



Maintenance and Service Guide

HP EliteDesk 800 G1 Tower

HP EliteDesk 800 G1 Small Form Factor

HP EliteDesk 800 G1 Ultra-Slim Desktop

© Copyright 2013 Hewlett-Packard Development Company, L.P. The information contained herein is subject to change without notice.

Microsoft, Windows, and Windows Vista are either trademarks or registered trademarks of Microsoft Corporation in the United States and/or other countries.

The only warranties for HP products and services are set forth in the express warranty statements accompanying such products and services. Nothing herein should be construed as constituting an additional warranty. HP shall not be liable for technical or editorial errors or omissions contained herein.

This document contains proprietary information that is protected by copyright. No part of this document may be photocopied, reproduced, or translated to another language without the prior written consent of Hewlett-Packard Company.

First Edition (July 2013)

Document Part Number: 723282-001

Product notice

This guide describes features that are common to most models. Some features may not be available on your computer.

About This Book

 **WARNING!** Text set off in this manner indicates that failure to follow directions could result in bodily harm or loss of life.

 **CAUTION:** Text set off in this manner indicates that failure to follow directions could result in damage to equipment or loss of information.

 **NOTE:** Text set off in this manner provides important supplemental information.

Table of contents

1 Product features	1
Standard configuration features	1
Tower (TWR)	1
Small Form Factor (SFF)	2
Ultra-slim Desktop (USDT)	2
Tower (TWR) front panel components	3
Small Form Factor (SFF) front panel components	4
Ultra-slim Desktop (USDT) front panel components	5
Tower (TWR) rear panel components	6
Small Form Factor (SFF) rear panel components	7
Ultra-slim Desktop (USDT) rear panel components	8
Serial number location	8
Tower (TWR)	9
Small Form Factor (SFF)	9
Ultra-slim Desktop (USDT)	10
2 Activating and Customizing the Software	11
Activating and customizing the software in Windows 7	11
Activating the Windows operating system	11
Downloading Windows 7 updates	12
Installing or upgrading device drivers	12
Customizing the monitor display	12
Activating and customizing the software in Windows 8	12
Activating the Windows Operating System	12
Downloading Windows 8 updates	13
Customizing the monitor display	13
3 Illustrated parts catalog	14
Tower (TWR) chassis spare parts	14
Computer major components	14
Cables	16

Misc parts	17
Drives	18
Misc boards	19
Sequential part number listing	19
Small Form Factor (SFF) chassis spare parts	22
Computer major components	22
Cables	23
Misc parts	24
Drives	25
Misc boards	25
Sequential part number listing	26
Ultra-Slim Desktop (USD) chassis spare parts	29
Computer major components	29
Cables	30
Misc parts	31
Drives	32
Misc boards	33
Sequential part number listing	33

4 Routine care, SATA drive guidelines, and disassembly preparation 35

Electrostatic discharge information	35
Generating static	36
Preventing electrostatic damage to equipment	36
Personal grounding methods and equipment	37
Grounding the work area	37
Recommended materials and equipment	37
Operating guidelines	38
Routine care	39
General cleaning safety precautions	39
Cleaning the Computer Case	39
Cleaning the keyboard	39
Cleaning the monitor	40
Cleaning the mouse	40
Service considerations	40
Power supply fan	40
Tools and software Requirements	41
Screws	41
Cables and connectors	41
Hard Drives	41
Lithium coin cell battery	42
SATA hard drives	42

SATA hard drive cables	43
SATA data cable	43
SMART ATA drives	43
Cable management	43
5 Removal and replacement procedures: Tower (TWR)	44
Preparation for disassembly	44
Access panel	45
Front bezel security	46
Front bezel	47
Bezel blanks	48
Memory	50
DIMMs	50
DDR3-SDRAM DIMMs	50
Populating DIMM sockets	50
Installing DIMMs	51
Expansion cards	53
System board connections	57
Drives	59
Drive positions	61
Removing a 5.25-inch drive	62
Installing a 5.25-inch drive	62
Removing a 3.5-inch device	64
Installing a 3.5-inch device	66
Removing a slim optical drive	67
Installing a slim optical drive	68
Removing a 3.5-inch or 2.5-inch hard drive	70
Installing a 3.5-inch or 2.5-inch hard drive	71
Front I/O assembly	76
Power switch/LED assembly	77
Fan sink	79
Processor	81
Speaker	82
Smart Cover Lock (solenoid lock)	83
Hood sensor	86
Fan	87
Power supply	89
System board and PCI expansion slot daughter card	92
6 Removal and replacement procedures: Small Form Factor (SFF)	94
Preparation for disassembly	94

Access panel	95
Front bezel	96
Front bezel security	97
Bezel blanks	99
Memory	100
DIMMs	100
DDR3-SDRAM DIMMs	100
Populating DIMM sockets	100
Installing DIMMs	101
Expansion card	103
System board connections	107
Drives	108
Drive positions	110
Removing a 3.5-inch device	111
Installing a 3.5-inch device	112
Removing a slim optical drive	114
Installing a slim optical drive	115
Removing and replacing a 3.5-inch hard drive	116
Removing a 2.5-inch hard drive	119
Installing a 2.5-inch hard drive	119
Power supply	121
Fan duct	124
Smart Cover Lock (solenoid lock)	125
Hood sensor	128
Cable routing	129
Front I/O assembly	130
Power switch assembly	132
Speaker	134
Fan sink	135
Processor	136
System board	138
Changing from desktop to tower configuration	140

7 Removal and replacement procedures: Ultra-slim Desktop (USDT) 141

Preparation for disassembly	141
Access panel	142
Front bezel	143
Front bezel security	144
Bezel blank	145
System board connections	146
Memory	147

SODIMMs	147
DDR3-SDRAM SODIMMs	147
Populating SODIMM sockets	148
Installing SODIMMs	149
Front fan	150
Optical drive	151
Removing the optical drive	151
Preparing the new optical drive	152
Installing the new optical drive	153
Hard drive	154
Speaker	156
Heat sink	157
Processor	159
Smart Cover Lock (solenoid lock)	160
Drive cage	164
Hood sensor	165
Card reader	166
WLAN module	168
Graphics board	169
Power switch	170
System board	171
Rear fan	173
Antennas	174
Changing from desktop to tower configuration	178
Port cover	179
Power supply, external	179

8 Computer Setup (F10) Utility 180

Computer Setup (F10) Utilities	180
Using Computer Setup (F10) Utilities	181
Computer Setup—File	182
Computer Setup—Storage	183
Computer Setup—Security	186
Computer Setup—Power	191
Computer Setup—Advanced	193
Recovering the Configuration Settings	195

9 Troubleshooting without diagnostics 196

Safety and comfort	196
Before you call for technical support	196
Helpful hints	197

Solving general problems	199
Solving power problems	203
Solving hard drive problems	205
Solving media card reader problems	208
Solving display problems	210
Solving audio problems	215
Solving printer problems	217
Solving keyboard and mouse problems	219
Solving Hardware Installation Problems	221
Solving Network Problems	223
Solving memory problems	227
Solving processor problems	229
Solving CD-ROM and DVD problems	230
Solving USB flash drive problems	232
Solving front panel component problems	233
Solving Internet access problems	233
Solving software problems	235
10 POST error messages	237
POST numeric codes and text messages	238
Interpreting POST diagnostic front panel LEDs and audible codes	246
11 Password security and resetting CMOS	250
Resetting the password jumper	251
Clearing and resetting the CMOS	252
12 HP PC Hardware Diagnostics	254
Why run HP PC Hardware Diagnostics – UEFI	254
How to access and run HP PC Hardware Diagnostics - UEFI	254
Downloading HP PC Hardware Diagnostics to a USB device	255
13 System backup and recovery	256
Backing up, restoring, and recovering in Windows 8	256
Creating recovery media and backups	257
Restoring and recovering using Windows 8 tools	258
Using Windows 8 Refresh	258
Using Windows 8 Reset	259
Recovery using the Windows 8 recovery USB flash drive	260
Recovery using Windows 8 operating system media (purchased separately) .	261
Backing up, restoring, and recovering in Windows 7	262

Creating recovery media	262
Creating recovery media using HP Recovery Manager (select models only) ...	263
Creating recovery discs with HP Recovery Disc Creator (select models only) ..	264
Creating recovery discs	264
Backing up your information	265
System Restore	265
System Recovery	266
System Recovery when Windows is responding	266
System Recovery when Windows is not responding	267
System Recovery using recovery media (select models only)	267
Using HP Recovery Disc operating system discs (select models only)	268
Appendix A Battery replacement	270
Appendix B Power cord set requirements	273
General requirements	273
Japanese power cord requirements	273
Country-specific requirements	274
Appendix C Specifications	275
TWR specifications	275
SFF specifications	276
USDT specifications	277
Index	278

1 Product features

Standard configuration features

Features may vary depending on the model. For a complete listing of the hardware and software installed in the computer, run the diagnostic utility (included on some computer models only).

 **NOTE:** All three computer models can be used in a tower orientation or a desktop orientation.

Tower (TWR)



Small Form Factor (SFF)



Ultra-slim Desktop (USDT)



Tower (TWR) front panel components

Drive configuration may vary by model. Some models have a bezel blank covering one or more drive bays.

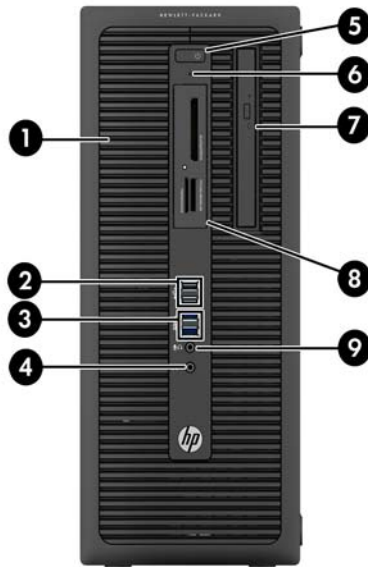

1	5.25-inch Half-Height Drive Bay (behind bezel)	6	Hard Drive Activity Light
2	USB 2.0 Ports (black)	7	Slim Optical Drive (optional)
3	USB 3.0 Ports (blue)	8	3.5-inch Media Card Reader (optional)
4	Headphone Connector	9	Microphone/Headphone Connector
5	Dual-State Power Button		

NOTE: When a device is plugged into the Microphone/Headphone Connector, a dialog box will pop up asking if you want to use the connector for a microphone Line-In device or a headphone. You can reconfigure the connector at any time by double-clicking the Audio Manager icon in the Windows taskbar.

NOTE: The Power On Light is normally white when the power is on. If it is flashing red, there is a problem with the computer and it is displaying a diagnostic code. Refer to [Interpreting POST diagnostic front panel LEDs and audible codes on page 246](#) to interpret the code.

Small Form Factor (SFF) front panel components

Drive configuration may vary by model. Some models have a bezel blank covering one or more drive bays.

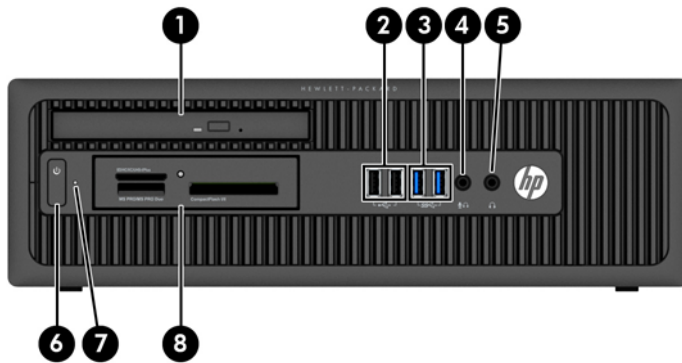

1	Slim Optical Drive (optional)	5	Headphone Connector
2	USB 2.0 Ports (black)	6	Dual-State Power Button
3	USB 3.0 Ports (blue)	7	Hard Drive Activity Light
4	Microphone/Headphone Connector	8	3.5-inch Media Card Reader (optional)

NOTE: When a device is plugged into the Microphone/Headphone Connector, a dialog box will pop up asking if you want to use the connector for a microphone Line-In device or a headphone. You can reconfigure the connector at any time by double-clicking the Audio Manager icon in the Windows taskbar.

NOTE: The Power On Light is normally white when the power is on. If it is flashing red, there is a problem with the computer and it is displaying a diagnostic code. Refer to [Interpreting POST diagnostic front panel LEDs and audible codes on page 246](#) to interpret the code.

Ultra-slim Desktop (USDT) front panel components

Drive configuration may vary by model. Some models have a bezel blank covering the optical drive bay.

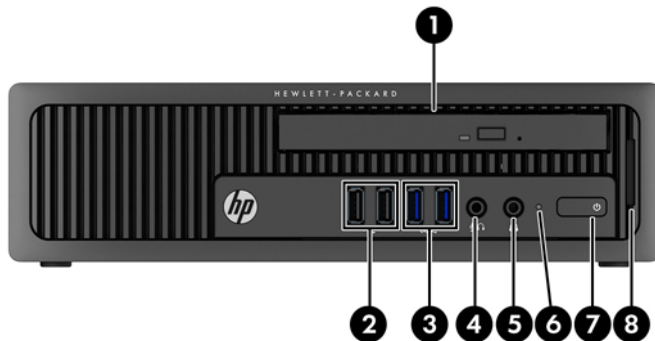









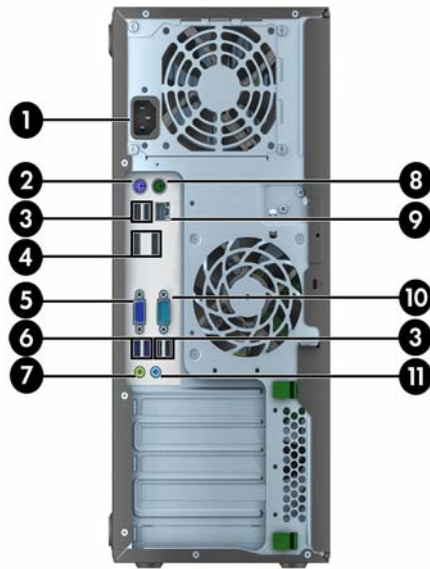



1	Slim Optical Drive (optional)	5	Headphone Connector
2	USB 2.0 Ports (black)	6	Hard Drive Activity Light
3	USB 3.0 Ports (blue)	7	Dual-State Power Button
4	Microphone/Headphone Connector	8	SD Media Card Reader (optional)

NOTE: When a device is plugged into the Microphone/Headphone Connector, a dialog box will pop up asking if you want to use the connector for a microphone Line-In device or a headphone. You can reconfigure the connector at any time by double-clicking the Audio Manager icon in the Windows taskbar.

NOTE: The Power On Light is normally white when the power is on. If it is flashing red, there is a problem with the computer and it is displaying a diagnostic code. Refer to [Interpreting POST diagnostic front panel LEDs and audible codes on page 246](#) to interpret the code.

Tower (TWR) rear panel components



1	 Power Cord Connector	7	 Line-Out Connector for powered audio devices (green)
2	 PS/2 Keyboard Connector (purple)	8	 PS/2 Mouse Connector (green)
3	 USB 2.0 Ports (black)	9	 RJ-45 Network Connector
4	 DisplayPort Monitor Connectors	10	 Serial Connector
5	 VGA Monitor Connector	11	 Line-In Audio Connector (blue)
6	 USB 3.0 Ports (blue)		

NOTE: An optional second serial port and an optional parallel port are available from HP.





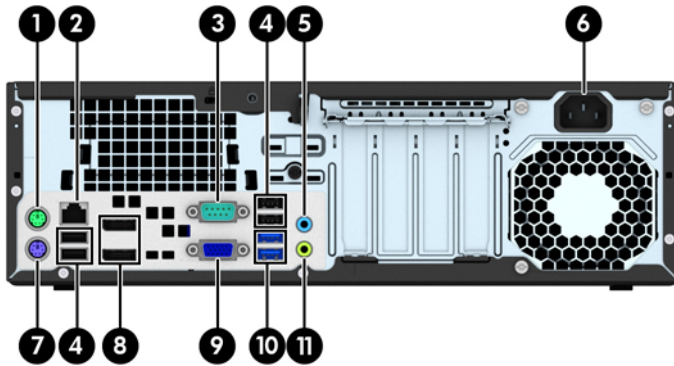

When a device is plugged into the blue Line-In Audio Connector, a dialog box will pop up asking if you want to use the connector for a line-in device or a microphone. You can reconfigure the connector at any time by double-clicking the Audio Manager icon in the Windows taskbar.

When a graphics card is installed in one of the system board slots, the video connectors on the graphics card and the integrated graphics on the system board may be used at the same time. However, for such a configuration, only the display connected to the discrete graphics card will display POST messages.

The system board graphics can be disabled by changing settings in Computer Setup.

Small Form Factor (SFF) rear panel components



1		PS/2 Mouse Connector (green)	7		PS/2 Keyboard Connector (purple)
2		RJ-45 Network Connector	8		DisplayPort Monitor Connectors
3		Serial Connector	9		VGA Monitor Connector
4		USB 2.0 Ports (black)	10		USB 3.0 Ports (blue)
5		Line-In Audio Connector (blue)	11		Line-Out Connector for powered audio devices (green)
6		Power Cord Connector			

NOTE: An optional second serial port and an optional parallel port are available from HP.







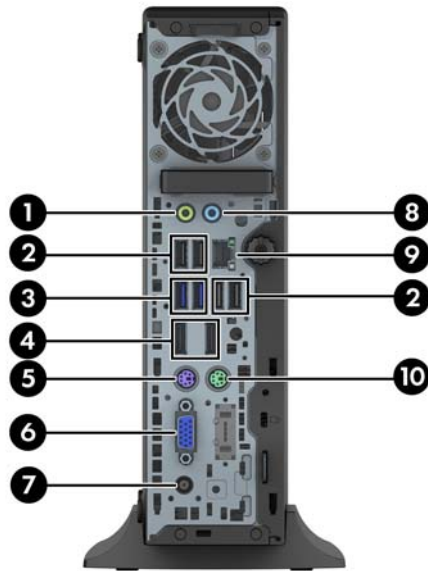

When a device is plugged into the blue Line-In Audio Connector, a dialog box will pop up asking if you want to use the connector for a line-in device or a microphone. You can reconfigure the connector at any time by double-clicking the Audio Manager icon in the Windows taskbar.

When a graphics card is installed in one of the system board slots, the video connectors on the graphics card and the integrated graphics on the system board may be used at the same time. However, for such a configuration, only the display connected to the discrete graphics card will display POST messages.

The system board graphics can be disabled by changing settings in Computer Setup.

Ultra-slim Desktop (USDT) rear panel components



1		Line-Out Connector for powered audio devices (green)	6		VGA Monitor Connector
2		USB 2.0 Ports (black)	7		Power Cord Connector
3		USB 3.0 Ports (blue)	8		Line-In Audio Connector (blue)
4		DisplayPort Monitor Connectors	9		RJ-45 Network Connector
5		PS/2 Keyboard Connector (purple)	10		PS/2 Mouse Connector (green)

NOTE: When a device is plugged into the blue Line-In Audio Connector, a dialog box will pop up asking if you want to use the connector for a line-in device or a microphone. You can reconfigure the connector at any time by double-clicking the Audio Manager icon in the Windows taskbar.

If an MXM graphics card is installed, all of the video connectors may be used at the same time. However, for such a configuration, only the display connected to the upper DisplayPort will display POST messages.

The system board graphics can be disabled by changing settings in Computer Setup.

Serial number location

Each computer has a unique serial number and a product ID number that are located on the exterior of the computer. Keep these numbers available for use when contacting customer service for assistance.

Tower (TWR)



Small Form Factor (SFF)

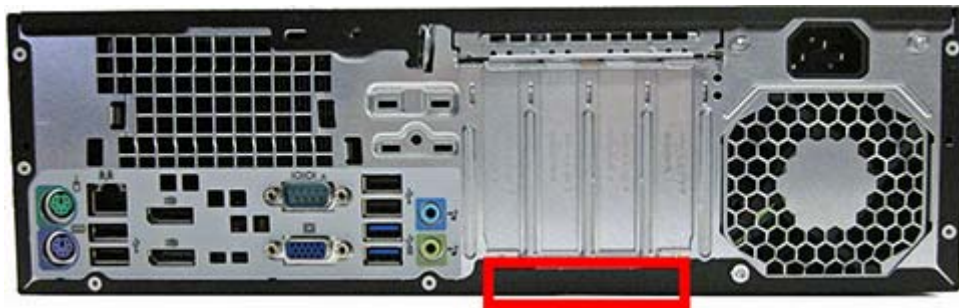

Ultra-slim Desktop (USDT)



2 Activating and Customizing the Software

 **NOTE:** This chapter provides information for both Windows 7 and Windows 8.

Activating and customizing the software in Windows 7

If your computer was not shipped with a Windows® operating system, some portions of this documentation do not apply. Additional information is available in online help after you activate the operating system.

 **CAUTION:** Do not add optional hardware or third-party devices to the computer until the operating system is successfully activated. Doing so may cause errors and prevent the operating system from installing properly.

 **NOTE:** Be sure there is a 10.2 cm (4 inch) clearance at the back of the unit and above the monitor to permit the required airflow.

Activating the Windows operating system

The first time you turn on the computer, the operating system is set up and activated automatically. This process takes about 5 to 10 minutes. Carefully read and follow the instructions on the screen to complete the activation.

We recommend that you register your computer with HP during operating system setup so you can receive important software updates, facilitate support questions, and sign up for special offers.

 **CAUTION:** After the activation process has begun, **DO NOT TURN OFF THE COMPUTER UNTIL THE PROCESS IS COMPLETE.** Turning off the computer during the activation process may damage the software that runs the computer or prevent its proper installation.

 **NOTE:** If the computer shipped with more than one operating system language on the hard drive, the activation process could take up to 60 minutes.

Downloading Windows 7 updates

Microsoft may release updates to the operating system. To help keep the computer running optimally, HP recommends checking for the latest updates during the initial installation and periodically throughout the life of the computer.

1. To set up your Internet connection, click **Start > Internet Explorer** and follow the instructions on the screen.
2. After an Internet connection has been established, click the **Start > All Programs > Windows Update**.
3. Run Windows Update monthly thereafter.

Installing or upgrading device drivers

When installing optional hardware devices after the operating system installation is complete, you must also install the drivers for each of the devices.

In Windows 7, if prompted for the i386 directory, replace the path specification with `C:\i386`, or use the **Browse** button in the dialog box to locate the i386 folder. This action points the operating system to the appropriate drivers.

Obtain the latest support software, including support software for the operating system, from <http://www.hp.com/support>. Select your country and language, select **Download drivers and software (and firmware)**, enter the model number of the computer, and press **Enter**.

Customizing the monitor display

If you wish, you can select or change the monitor refresh rates, screen resolution, color settings, font sizes, and power management settings.

For more information, refer to the online documentation provided with the graphics controller utility or the documentation that came with your monitor.

Right-click on the Windows desktop, then click **Personalize** to change display settings.

Activating and customizing the software in Windows 8

Additional information is available in online help after you activate the operating system.



NOTE: Be sure there is a 10.2 cm (4 inch) clearance at the back of the unit and above the monitor to permit the required airflow.

Activating the Windows Operating System

The first time you turn on the computer, the operating system is set up and activated automatically. This process takes about 5 to 10 minutes. Carefully read and follow the instructions on the screen to complete the activation.

We recommend that you register your computer with HP during operating system set up so you can receive important software updates, facilitate support questions, and sign up for special offers. You can also register your computer with HP using the **Register with HP** app on the Start screen.

 **CAUTION:** After the activation process has begun, DO NOT TURN OFF THE COMPUTER UNTIL THE PROCESS IS COMPLETE. Turning off the computer during the activation process may damage the software that runs the computer or prevent its proper installation.

Downloading Windows 8 updates

Microsoft may release updates to the operating system. To help keep the computer running optimally, HP recommends checking for the latest updates during the initial installation and periodically throughout the life of the computer.

Run Windows Update as soon as possible after you set up your computer.

1. Point to the upper-right or lower-right corner of the Start screen to display the charms.
2. Click **Settings > Change PC Settings > Windows Update**.
3. Run Windows Update monthly thereafter.

Customizing the monitor display

You can customize display settings for Windows 8 separately for the Start screen and the Desktop.

To customize the Start screen:

1. Point to the upper-right or lower-right corner of the Start screen to display the charms.
2. Click **Settings > Change PC Settings**.
3. Click **Personalize** to change the display settings.

To customize the Desktop:

1. Click the Desktop app on the Start screen.
2. Right-click on the desktop, and then click **Personalize** to change display settings.

3 Illustrated parts catalog

This chapter provides spare part information for all chassis.

Tower (TWR) chassis spare parts

Computer major components

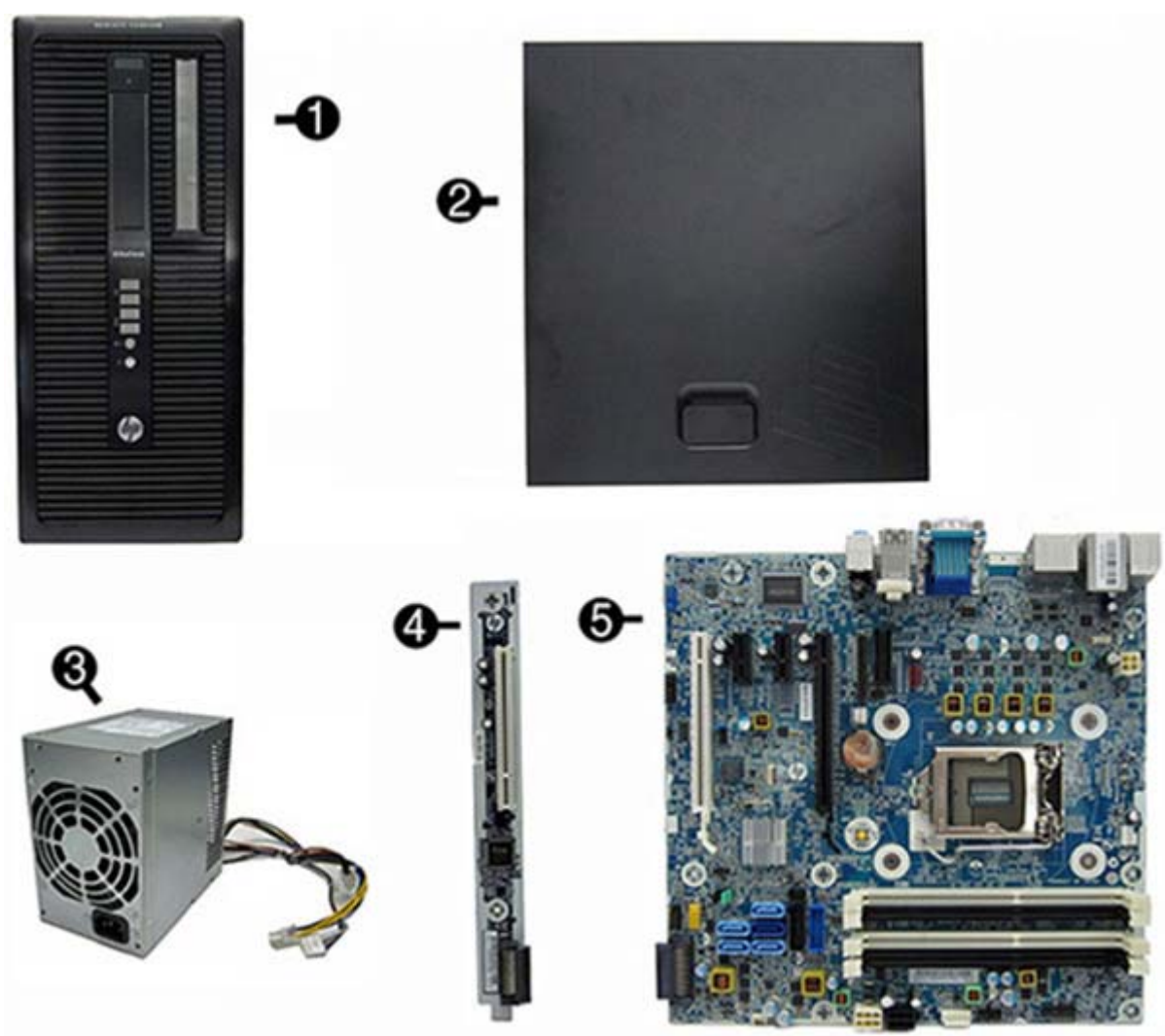

Item	Description	Spare part number
(1)	Front bezel	
	For use in all countries and regions except China	732751-001
	For use in China	732752-001
(2)	Access panel	732748-001
(3)	Power supply	
	320W, 92% efficient	702452-001
	320W, 90% efficient	702453-001
	320W, standard	702454-001
	320W, HV, standard	707906-001
(4)	HP PCI expansion slot daughter card	696971-001
(5)	System board (includes replacement thermal material)	
	For use in models without Windows 8	696969-001
	For use in models with Windows 8 Standard	696969-501
	For use in models with Windows 8 Professional	696969-601
	For use in models with NetClone	727720-001
	Memory modules (PC3-12800)	
	8-GB	689375-001
	4-GB	671613-001
	2-GB	671612-001
	Processors (include replacement thermal material)	
	Intel Core i7 4770 (3.4-GHz, 8-MB L3 cache)	727373-001
	Intel Core i5 4670 (3.4-GHz, 6-MB L3 cache)	727381-001
	Intel Core i5 4570 (3.2-GHz, 6-MB L3 cache)	727380-001

Cables



Item	Description	Spare part number
(1)	Front I/O assembly	732750-001
(2)	Power switch/LED assembly	732749-001
(3)	Drive power cable	732754-001
	Hard drive SATA cable, 14 inch, 1 straight end, 1 angled end	732753-001
	Hard drive SATA cable, 17.7 inch, 2 straight ends	639959-001
	SATA cable, 18 inch, 1 straight end, 1 angled end	646830-001
	DMS-59 to dual VGA cable	463023-001
	Adapter, DisplayPort to VGA	632484-001
	Adapter, DisplayPort to DVI	662723-001
	Adapter, DisplayPort to HDMI	617450-001
	DisplayPort cable	487562-001

Misc parts

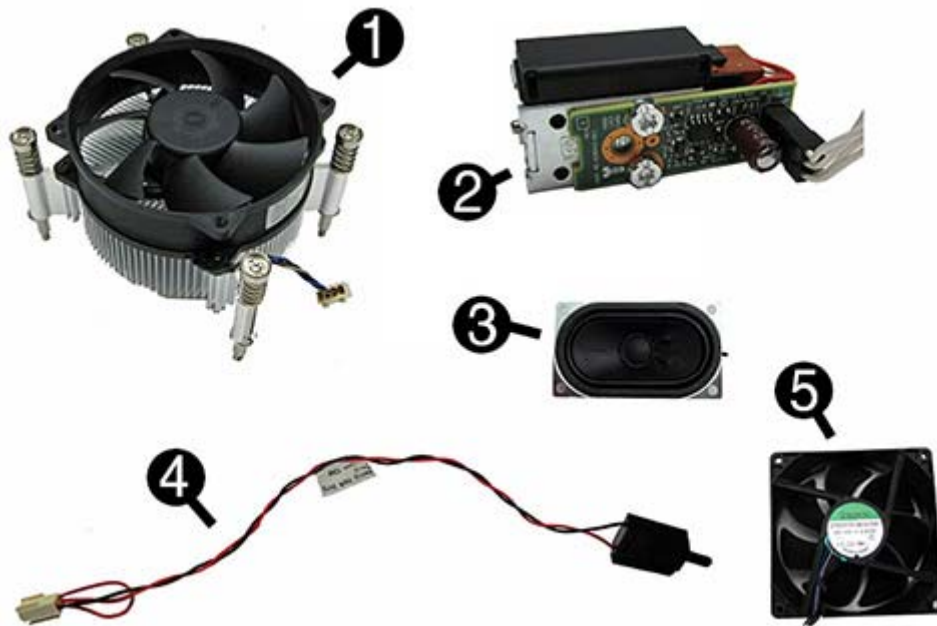

Item	Description	Spare part number
(1)	Fan sink (includes replacement thermal material)	727142-001
(2)	Solenoid lock	641498-001
(3)	Speaker	645330-001
(4)	Hood sensor	638816-001
(5)	Fan	727135-001
	Optical drive bezel blank	732770-001
	Printer port, PCI card	638817-001
	HP Ultralim Keyed Cable Lock	703372-001
	Hard drive conversion bracket	397117-001
	Serial port, PCI card	638815-001
	USB powered speakers	636917-001
	Mouse	
	PS2, optical	674315-001
	USB, HP Elite	674318-001
	Washable	724795-001
	Wireless, HP Elite	674317-001
	USB, optical	674316-001
	Foot kit	460890-001

Item	Description	Spare part number
Keyboard		
	PS/2	724718-xx1
	USB	724720-xx1
	USB, wireless	724722-xx1
	Smart card	701427-xx1
	Wireless keyboard, mouse, and dongle	730323-xx1

Drives

Description	Spare part number
Hard drive	
2 TB, 7200 rpm	616608-001
1 TB, hybrid SSD	724937-001
1 TB, 10000 rpm	719106-001
1 TB, 7200 rpm	613202-001
750 GB, 7200 rpm, hybrid SSD	719105-001
500 GB, 10000 rpm	683923-001
500 GB, 7200 rpm, self-encrypting (SED)	696442-001
500 GB, hybrid SSD	724938-001
256 GB Solid-state Drive (SSD), self-encrypting (SED)	680020-001
128 GB Solid-state Drive (SSD)	665961-001
32 GB mSATA drive	686616-001
Optical drive	
Blu-ray BD-RW SuperMulti XL Drive	719157-001
DVD±RW drive	657958-001
DVD-ROM drive	608394-001

Misc boards

Description	Spare part number
nVidia Quadro NVS310 PCIe x16 graphics card, 512 MB	707252-001
nVidia Quadro NVS315 PCIe x16 graphics card, 1 GB	720837-001
AMD Radeon HD8490 PCIe x16 graphics card, 1 GB	717219-001
AMD Radeon HD8470 PCIe x16 graphics card, 2 GB DDR3	729085-001
AMD Radeon HD 8350 1GB PCIe x16 DH GFX	717220-001
AMD Radeon HD8350 PCIe x16 graphics card, 1 GB DDR3	729084-001
GeForce GT630 PCIe x16 graphics card, 2 GB	702084-001
Intel PRO/1000 single port GbE NIC, includes bracket	728562-001
HP WLAN 802.11 a/b/g/n 2x2 PCIe module	695915-001

Sequential part number listing

Spare part number	Description
397117-001	Hard drive conversion bracket
460890-001	Foot kit
463023-001	DMS-59 to dual VGA cable
487562-001	DisplayPort cable
608394-001	DVD-ROM drive
613202-001	1 TB, 7200 rpm hard drive
616608-001	2 TB, 7200 rpm SATA hard drive
617450-001	Adapter, DisplayPort to HDMI
662723-001	Adapter, DisplayPort to DVI
632484-001	Adapter, DisplayPort to VGA
636917-001	USB powered speakers
638815-001	Serial port PCI card
638816-001	Hood sensor
638817-001	Printer port, PCI card
639959-001	Hard drive SATA cable, 17.7 inch, 2 straight ends
641498-001	Solenoid lock
643907-001	Fan sink (includes replacement thermal material)

Spare part number	Description
643908-001	Chassis fan
645330-001	Speaker
646831-001	Hard drive power cable
646832-001	SATA optical drive power cable
657958-001	DVD±RW drive
665961-001	128-GB Solid-state drive
671612-001	Memory module, 2-GB, PC3 12800
671613-001	Memory module, 4-GB, PC3-12800
674315-001	Mouse, PS2, optical
674316-001	Mouse, USB, optical
674317-001	Mouse, wireless
674318-001	Mouse, USB
680020-001	256 GB Solid-state drive, self-encrypting (SED)
683923-001	500 GB, 10000 rpm SATA hard drive
686616-001	32 GB mSATA drive
689375-001	Memory module, 8-GB, PC3-12800
695915-001	HP WLAN 802.11 a/b/g/n 2x2 PCIe NIC
696442-001	500 GB, 7200 rpm hard drive, self-encrypting (SED)
696969-001	System board for use in models without Windows 8 (includes replacement thermal material)
696969-501	System board for use in models with Windows 8 Standard (includes replacement thermal material)
696969-601	System board for use in models with Windows 8 Professional (includes replacement thermal material)
696971-001	HP PCI expansion slot daughter card
701427-xx1	Keyboard, smart card, for use in models with Windows 8
702084-001	GeForce GT630 PCIe x16 graphics card, 2 GB
702452-001	320W, 92% efficient
702453-001	320W, 90% efficient
702454-001	320W, standard
703372-001	HP Ultralim Keyed Cable Lock
707252-001	nVidia Quadro NVS310 PCIe x16 graphics card, 512 MB
707906-001	320W, HV, standard
717219-001	AMD Radeon HD8490 PCIe x16 graphics card, 1 GB
717220-001	AMD Radeon HD 8350 1GB PCIe x16 DH GFX

Spare part number	Description
719105-001	750 GB, 7200 rpm, 2.5-inch hard drive, hybrid SSD
719106-001	1 TB, 10000 rpm hard drive
719157-001	Blu-ray BD-RW SuperMulti XL Drive
720837-001	nVidia Quadro NVS315 PCIe x16 graphics card, 1 GB
724718-xx1	Keyboard, PS/2, for use in models with Windows 8
724720-xx1	Keyboard, USB, black, for use in models with Windows 8
724722-xx1	Keyboard, wireless, for use in models with Windows 8
724795-001	Mouse, washable
724937-001	1 TB hard drive, hybrid SSD
724938-001	500 GB hard drive, hybrid SSD
727135-001	Rear chassis fan
727373-001	Intel Core i7 4770 processor (3.4-GHz, 8-MB L3 cache)
727380-001	Intel Core i5 4570 processor (3.2-GHz, 6-MB L3 cache)
727381-001	Intel Core i5 4670 processor (3.4-GHz, 6-MB L3 cache)
727720-001	System board for use in NetClone models
728562-001	Intel PRO/1000 single port GbE NIC, includes bracket
729084-001	AMD Radeon HD8350 PCIe x16 graphics card, 1 GB DDR3
729085-001	AMD Radeon HD8470 PCIe x16 graphics card, 2 GB DDR3
730323-xx1	Wireless keyboard, mouse, and dongle
732748-001	Access panel
732749-001	Power switch/LED with holder
732750-001	Front I/O assembly
732751-001	Front bezel for use in all countries and regions except for China
732752-001	Front bezel for use in China
732753-001	Hard drive SATA cable, 14 inch, 1 straight end, 1 angled end
732754-001	Drive power cable
732770-001	Optical drive bezel blank

Small Form Factor (SFF) chassis spare parts

Computer major components

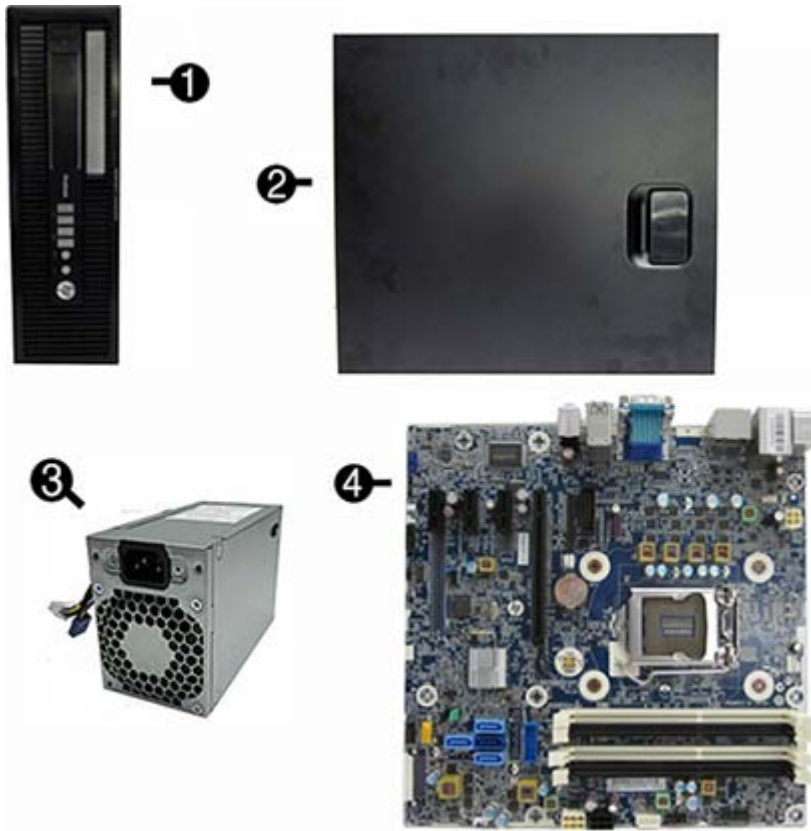

Item	Description	Spare part number
(1)	Front bezel	732757-001
(2)	Access panel	732760-001
(3)	Power supply	
	240W, 92% efficient	702455-001
	240W, 90% efficient	702456-001
	240W, standard	702457-001
(4)	System board (includes replacement thermal material)	
	For use in models without Windows 8	717522-001
	For use in models with Windows 8 Standard	717522-501
	For use in models with Windows 8 Professional	717522-601
	For use in models with NetClone	727722-001
	Memory modules (PC3-12800)	

Item	Description	Spare part number
	8-GB	689375-001
	4-GB	671613-001
	2-GB	671612-001
	Processors (include replacement thermal material)	
	Intel Core i7 4770 (3.4-GHz, 8-MB L3 cache)	727373-001
	Intel Core i5 4670 (3.4-GHz, 6-MB L3 cache)	727381-001
	Intel Core i5 4570 (3.2-GHz, 6-MB L3 cache)	727380-001

Cables

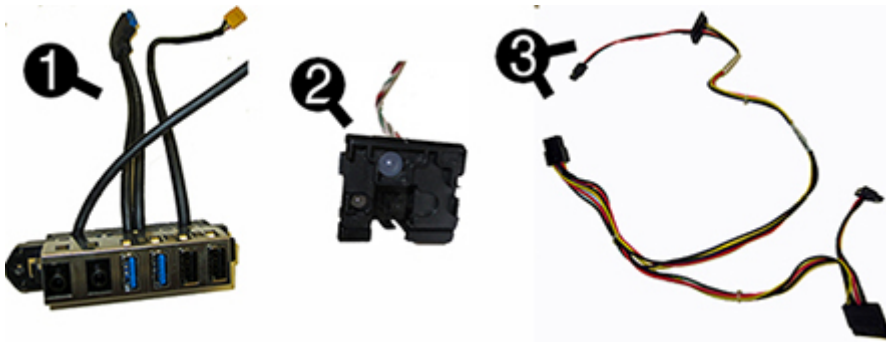

Item	Description	Spare part number
(1)	Front I/O assembly	732755-001
(2)	Power switch assembly	732756-001
(3)	SATA drive power cable	732759-001
	Hard drive SATA cable , 14 inch, 1 straight end, 1 angled end	732753-001
	Optical drive SATA cable , 19.5 inch, 2 straight ends	638813-001
	SATA cable , 25.2 inch, 1 straight end, 1 angled end	638814-001
	DMS-59 to dual VGA cable	463023-001
	Adapter, DisplayPort to VGA	632484-001
	Adapter, DisplayPort to DVI	662723-001
	Adapter, DisplayPort to HDMI	617450-001
	DisplayPort cable	487562-001

Misc parts

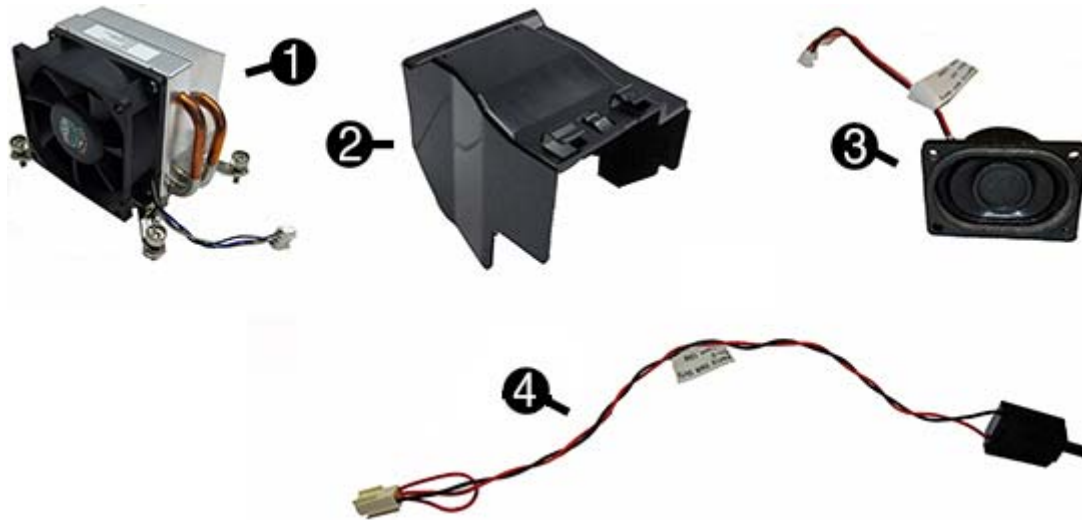

Item	Description	Spare part number
(1)	Fan sink (includes replacement thermal material)	727150-001
(2)	Fan duct	727145-001
(3)	Speaker	727149-001
(4)	Hood sensor	638816-001
	Optical drive bezel blank	732769-001
	Solenoid lock	732772-001
	Printer port, PCI card	638817-001
	HP Ultralim Keyed Cable Lock	703372-001
	Rubber foot	583654-001
	Chassis stand	688952-001
	Serial port, PCI card	638815-001
	Hard drive conversion bracket	397117-001
	USB powered speakers	636917-001
	Mouse	
	PS2, optical	674315-001
	USB, HP Elite	674318-001
	Washable	724795-001
	Wireless, HP Elite	674317-001
	USB, optical	674316-001
	Foot kit	583654-001

Item	Description	Spare part number
Keyboard		
	PS/2	724718-xx1
	USB	724720-xx1
	USB, wireless	724722-xx1
	Smart card	701427-xx1
	Wireless keyboard, mouse, and dongle	730323-xx1

Drives

Description	Spare part number
Hard drive	
2 TB, 7200 rpm	616608-001
1 TB hard drive, hybrid SSD	724937-001
1 TB, 10000 rpm	719106-001
1 TB, 7200 rpm	613202-001
750 GB, 7200 rpm, hybrid SSD	719105-001
500 GB, 10000 rpm	683923-001
500 GB, 7200 rpm, self-encrypting (SED)	696442-001
500 GB hard drive, hybrid SSD	724938-001
256-GB Solid-state Drive (SSD), self-encrypting (SED)	680020-001
128-GB Solid-state Drive (SSD)	665961-001
32 GB mSATA drive	686616-001
Optical drive	
Blu-ray BD-RW SuperMulti XL Drive	719157-001
DVD±RW drive	657958-001
DVD-ROM drive	608394-001

 **NOTE:** 2.5-inch solid-state drives require an adapter for installation.

Misc boards

Description	Spare part number
nVidia Quadro NVS310 PCIe x16 graphics card, 512 MB	707252-001

Description	Spare part number
nVidia Quadro NVS315 PCIe x16 graphics card, 1 GB	720837-001
AMD Radeon HD8490 PCIe x16 graphics card, 1 GB	717219-001
AMD Radeon HD8450 PCIe x16 graphics card, 1 GB	717220-001
GeForce GT630 PCIe x16 graphics card, 2 GB	702084-001
Intel PRO/1000 single port GbE NIC, includes bracket	728562-001
HP WLAN 802.11 a/b/g/n 2x2 PCIe module	695915-001

Sequential part number listing

Spare part number	Description
397117-001	Hard drive conversion bracket
463023-001	DMS-59 to dual VGA cable
487562-001	DisplayPort cable
583654-001	Rubber foot
608394-001	DVD-ROM drive
613202-001	1 TB, 7200 rpm hard drive
616608-001	2 TB, 7200 rpm SATA hard drive
617450-001	Adapter, DisplayPort to HDMI
632484-001	Adapter, DisplayPort to VGA
636917-001	USB powered speakers
638813-001	Optical drive SATA cable, 19.5 inch, 2 straight ends
638814-001	SATA cable, 25.2 inch, 1 straight end, 1 angled end
638815-001	Serial port PCI card
638816-001	Hood sensor
638817-001	Printer port, PCI card
657958-001	DVD±RW drive
662723-001	Adapter, DisplayPort to DVI
665961-001	128-GB Solid-state drive
671612-001	Memory module, 2-GB, PC3 12800
671613-001	Memory module, 4-GB, PC3-12800
674317-001	Mouse, wireless, HP Elite
674318-001	Mouse, USB, HP Elite

Spare part number	Description
674315-001	Mouse, PS2, optical
674316-001	Mouse, USB, optical
680020-001	256-GB Solid-state drive, self-encrypting (SED)
683923-001	500 GB, 10000 rpm SATA hard drive
686616-001	32 GB mSATA drive
688952-001	Chassis stand
689375-001	Memory module, 8-GB, PC3-12800
695915-001	HP WLAN 802.11 a/b/g/n 2x2 PCIe NIC
696442-001	500 GB, 7200 rpm hard drive, self-encrypting (SED)
701427-xx1	Keyboard, smart card, for use in models with Windows 8
702455-001	320W, 92% efficient
702456-001	320W, 90% efficient
702457-001	320W, standard
703372-001	HP Ultralim Keyed Cable Lock
707252-001	nVidia Quadro NVS310 PCIe x16 graphics card, 512 MB
717219-001	AMD Radeon HD8490 PCIe x16 graphics card, 1 GB
717220-001	AMD Radeon HD8450 PCIe x16 graphics card, 1 GB
717522-001	System board for use in models without Windows 8 (includes replacement thermal material)
717522-501	System board for use in models with Windows 8 Standard (includes replacement thermal material)
717522-601	System board for use in models with Windows 8 Professional (includes replacement thermal material)
719105-001	750 GB, 7200 rpm, 2.5-inch, hard drive, hybrid SSD
719106-001	1 TB, 10000 rpm hard drive
719157-001	Blu-ray BD-RW SuperMulti XL Drive
720837-001	nVidia Quadro NVS315 PCIe x16 graphics card, 1 GB
724718-xx1	Keyboard, PS/2, for use in models with Windows 8
724720-xx1	Keyboard, USB, black, for use in models with Windows 8
724722-xx1	Keyboard, wireless, for use in models with Windows 8
724795-001	Mouse, washable
724937-001	1 TB hard drive, hybrid SSD
724938-001	500 GB hard drive, hybrid SSD
727145-001	Fan duct
727149-001	Speaker

Spare part number	Description
727150-001	Fan sink
727373-001	Intel Core i7 4770 processor (3.4-GHz, 8-MB L3 cache)
727380-001	Intel Core i5 4570 processor (3.2-GHz, 6-MB L3 cache)
727381-001	Intel Core i5 4670 processor (3.4-GHz, 6-MB L3 cache)
727722-001	System board for use in NetClone models (includes replacement thermal material)
728562-001	Intel PRO/1000 single port GbE NIC, includes bracket
732753-001	Hard drive SATA cable, 14 inch, 1 straight end, 1 angled end
732759-001	SATA drive power cable
732755-001	Front I/O cable assembly
732756-001	Power switch assembly
732757-001	Front bezel
732760-001	Access panel
732769-001	Optical drive bezel blank
732772-001	Solenoid lock

Ultra-Slim Desktop (USDT) chassis spare parts

Computer major components

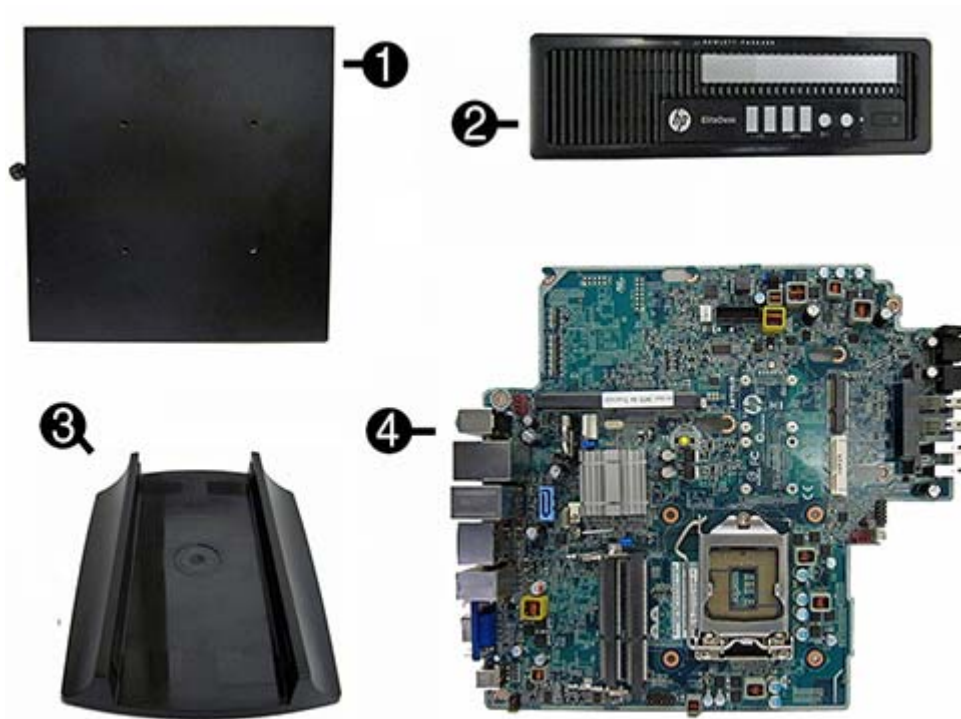

Item	Description	Spare part number
(1)	Access panel	732763-001
(2)	Front bezel	732764-001
(3)	Stand	612496-001
(4)	System board (includes replacement thermal material)	
	For use in models without Windows 8	696970-001
	For use in models with Windows 8 Standard	696970-501
	For use in models with Windows 8 Professional	696970-601
	For use in models with NetClone	727721-001
	AC adapter	
	180W, standard	613766-001
	135W, standard	648964-001
	Memory modules (PC3-12800)	
	8-GB	689374-001
	4-GB	689373-001

Item	Description	Spare part number
	2-GB	689372-001
Processors (include replacement thermal material)		
	Intel Core i7 4770s (3.1-GHz, 8-MB L3 cache)	732507-001
	Intel Core i5 4670s (3.1-GHz, 6-MB L3 cache)	732506-001
	Intel Core i5 4570s (2.9-GHz, 6-MB L3 cache)	732505-001

Cables



Item	Description	Spare part number
(1)	Optical drive cable/connector	605163-001
	Adapter, DisplayPort to VGA	632484-001
	Adapter, DisplayPort to DVI	662723-001
	Adapter, DisplayPort to HDMI	617450-001
	DisplayPort cable	487562-001

Misc parts



Item	Description	Spare part number
(1)	Heat sink for use with the processor (includes replacement thermal material)	587456-001
	Heat sink for use with the discrete graphics card (includes replacement thermal material; not illustrated)	689369-001
(2)	Power switch assembly	732767-001
(3)	Speaker	689384-001
(4)	Rear port cover	588981-001
(5)	Fan, rear	732766-001
(6)	Front I/O panel	732762-001
(7)	Chassis fan, front	732765-001
	Optical drive bezel blank	732771-001
	Solenoid lock	732772-001
	HP Ultrastim Keyed Cable Lock	703372-001
	Drive cage	732761-001
	USB powered speakers	636917-001
	Mouse	

Item	Description	Spare part number
	PS2, optical	674315-001
	USB, HP Elite	674318-001
	Washable	724795-001
	Wireless, HP Elite	674317-001
	USB, optical	674316-001
Keyboard		
	PS/2	724718-xx1
	USB, basic	724720-xx1
	USB, wireless	724722-xx1
	Smart card	701427-xx1
	Wireless keyboard, dongle, and mouse	730323-xx1

Drives

Description	Spare part number
Hard drive	
750 GB, 7200 rpm, hybrid SSD	719105-001
500 GB, 7200 rpm, self-encrypting (SED)	696442-001
500 GB, 7200 rpm	686217-001
320 GB, 7200 rpm	639135-001
500 GB hard drive, hybrid SSD	724938-001
256-GB Solid-state Drive (SSD), self-encrypting (SED)	680020-001
128-GB Solid-state Drive (SSD)	665961-001
32-GB Solid-state Drive (SSD)	686616-001
32-GB mSATA drive	719566-001
Optical drive	
DVD-ROM drive	608394-001
DVD±RW drive	657958-001
Blu-ray BD-RW SuperMulti XL Drive	719157-001

Misc boards

Description	Spare part number
AMD Radeon HD 7650A 2GB MXM Graphics	708866-001
HP WLAN 802.11 a/b/g/n 2x2 PCIe NIC	695915-001

Sequential part number listing

Spare part number	Description
487562-001	DisplayPort cable
587456-001	Heat sink for use with the processor (includes thermal material)
605163-001	Optical drive cable/connector
608394-001	DVD-ROM drive
612496-001	Stand
613766-001	180-W power adapter, standard
617450-001	Adapter, DisplayPort to HDMI
632484-001	Adapter, DisplayPort to VGA
636917-001	USB powered speakers
638816-001	Hood sensor
639135-001	320 GB, 7200 rpm hard drive
648964-001	AC adapter, 135W, standard
657958-001	DVD±RW drive
662723-001	Adapter, DisplayPort to DVI
665961-001	128-GB Solid-state drive
674315-001	Mouse, PS2, optical
674316-001	Mouse, USB, optical
674317-001	Mouse, wireless, HP Elite
674318-001	Mouse, USB, HP Elite
680020-001	256-GB Solid-state drive, self-encrypting (SED)
686217-001	500 GB, 7200 rpm hard drive
686616-001	32-GB Solid-state drive
689369-001	Heat sink for use on models with discrete graphics cards (includes thermal material)
689372-001	Memory module, 2-GB, PC3-12800

Spare part number	Description
689373-001	Memory module, 4-GB, PC3-12800
689374-001	Memory module, 8-GB, PC3-12800
689384-001	Speaker
695915-001	HP WLAN 802.11 a/b/g/n 2x2 PCIe NIC
696442-001	500 GB, 7200 rpm, self-encrypting (SED) hard drive
696970-001	System board (includes replacement thermal material)
701427-xx1	Keyboard, smart card, for use in models with Windows 8
703372-001	HP Ultralim Keyed Cable Lock
708866-001	AMD Radeon HD 7650A 2GB MXM Graphics
719105-001	750 GB, 7200 rpm hard drive, hybrid SSD
719157-001	Blu-ray BD-RW SuperMulti XL Drive
719566-001	32-GB mSATA drive
724718-xx1	Keyboard, PS/2, for use in models with Windows 8
724720-xx1	Keyboard, USB, black, for use in models with Windows 8
724722-xx1	Keyboard, wireless, for use in models with Windows 8
724795-001	Mouse, washable
724938-001	500 GB hard drive, hybrid SSD
727721-001	System board for use in NetClone models
732505-001	Intel Core i5 4570s processor (2.9-GHz, 6-MB L3 cache)
732506-001	Intel Core i5 4670s processor (3.1-GHz, 6-MB L3 cache)
732507-001	Intel Core i7 4770s processor (3.1-GHz, 8-MB L3 cache)
732761-001	Drive cage
732762-001	Front I/O assembly
732763-001	Access panel
732764-001	Front bezel
732765-001	Front fan
732766-001	Chassis fan, rear
732767-001	Power switch assembly
732771-001	Optical drive bezel blank
732772-001	Solenoid lock

4 Routine care, SATA drive guidelines, and disassembly preparation

This chapter provides general service information for the computer. Adherence to the procedures and precautions described in this chapter is essential for proper service.

⚠ CAUTION: When the computer is plugged into an AC power source, voltage is always applied to the system board. You must disconnect the power cord from the power source before opening the computer to prevent system board or component damage.

Electrostatic discharge information

A sudden discharge of static electricity from your finger or other conductor can destroy static-sensitive devices or microcircuitry. Often the spark is neither felt nor heard, but damage occurs. An electronic device exposed to electrostatic discharge (ESD) may not appear to be affected at all and can work perfectly throughout a normal cycle. The device may function normally for a while, but it has been degraded in the internal layers, reducing its life expectancy.

Networks built into many integrated circuits provide some protection, but in many cases, the discharge contains enough power to alter device parameters or melt silicon junctions.

Generating static

The following table shows that:

- Different activities generate different amounts of static electricity.
- Static electricity increases as humidity decreases.

Event	Relative Humidity		
	55%	40%	10%
Walking across carpet	7,500 V	15,000 V	35,000 V
Walking across vinyl floor	3,000 V	5,000 V	12,000 V
Motions of bench worker	400 V	800 V	6,000 V
Removing DIPs from plastic tube	400 V	700 V	2,000 V
Removing DIPs from vinyl tray	2,000 V	4,000 V	11,500 V
Removing DIPs from Styrofoam	3,500 V	5,000 V	14,500 V
Removing bubble pack from PCB	7,000 V	20,000 V	26,500 V
Packing PCBs in foam-lined box	5,000 V	11,000 V	21,000 V

These are then multi-packaged inside plastic tubes, trays, or Styrofoam.



NOTE: 700 volts can degrade a product.

Preventing electrostatic damage to equipment

Many electronic components are sensitive to ESD. Circuitry design and structure determine the degree of sensitivity. The following packaging and grounding precautions are necessary to prevent damage to electric components and accessories.

- To avoid hand contact, transport products in static-safe containers such as tubes, bags, or boxes.
- Protect all electrostatic parts and assemblies with conductive or approved containers or packaging.
- Keep electrostatic sensitive parts in their containers until they arrive at static-free stations.
- Place items on a grounded surface before removing them from their container.
- Always be properly grounded when touching a sensitive component or assembly.
- Avoid contact with pins, leads, or circuitry.
- Place reusable electrostatic-sensitive parts from assemblies in protective packaging or conductive foam.

Personal grounding methods and equipment

Use the following equipment to prevent static electricity damage to equipment:

- **Wrist straps** are flexible straps with a maximum of one-megohm \pm 10% resistance in the ground cords. To provide proper ground, a strap must be worn snug against bare skin. The ground cord must be connected and fit snugly into the banana plug connector on the grounding mat or workstation.
- **Heel straps/Toe straps/Boot straps** can be used at standing workstations and are compatible with most types of shoes or boots. On conductive floors or dissipative floor mats, use them on both feet with a maximum of one-megohm \pm 10% resistance between the operator and ground.

Static Shielding Protection Levels	
Method	Voltage
Antistatic plastic	1,500
Carbon-loaded plastic	7,500
Metallized laminate	15,000

Grounding the work area

To prevent static damage at the work area, use the following precautions:

- Cover the work surface with approved static-dissipative material. Provide a wrist strap connected to the work surface and properly grounded tools and equipment.
- Use static-dissipative mats, foot straps, or air ionizers to give added protection.
- Handle electrostatic sensitive components, parts, and assemblies by the case or PCB laminate. Handle them only at static-free work areas.
- Turn off power and input signals before inserting and removing connectors or test equipment.
- Use fixtures made of static-safe materials when fixtures must directly contact dissipative surfaces.
- Keep work area free of nonconductive materials such as ordinary plastic assembly aids and Styrofoam.
- Use field service tools, such as cutters, screwdrivers, and vacuums, that are conductive.

Recommended materials and equipment

Materials and equipment that are recommended for use in preventing static electricity include:

- Antistatic tape
- Antistatic smocks, aprons, or sleeve protectors
- Conductive bins and other assembly or soldering aids

- Conductive foam
- Conductive tabletop workstations with ground cord of one-megohm +/- 10% resistance
- Static-dissipative table or floor mats with hard tie to ground
- Field service kits
- Static awareness labels
- Wrist straps and footwear straps providing one-megohm +/- 10% resistance
- Material handling packages
- Conductive plastic bags
- Conductive plastic tubes
- Conductive tote boxes
- Opaque shielding bags
- Transparent metallized shielding bags
- Transparent shielding tubes

Operating guidelines

To prevent overheating and to help prolong the life of the computer:

- Keep the computer away from excessive moisture, direct sunlight, and extremes of heat and cold.
- Operate the computer on a sturdy, level surface. Leave a 10.2-cm (4-inch) clearance on all vented sides of the computer and above the monitor to permit the required airflow.
- Never restrict the airflow into the computer by blocking any vents or air intakes. Do not place the keyboard, with the keyboard feet down, directly against the front of the desktop unit as this also restricts airflow.
- Occasionally clean the air vents on all vented sides of the computer. Lint, dust, and other foreign matter can block the vents and limit the airflow. Be sure to unplug the computer before cleaning the air vents.
- Never operate the computer with the cover or side panel removed.
- Do not stack computers on top of each other or place computers so near each other that they are subject to each other's re-circulated or preheated air.
- If the computer is to be operated within a separate enclosure, intake and exhaust ventilation must be provided on the enclosure, and the same operating guidelines listed above will still apply.
- Keep liquids away from the computer and keyboard.

- Never cover the ventilation slots on the monitor with any type of material.
- Install or enable power management functions of the operating system or other software, including sleep states.

Routine care

General cleaning safety precautions

1. Never use solvents or flammable solutions to clean the computer.
2. Never immerse any parts in water or cleaning solutions; apply any liquids to a clean cloth and then use the cloth on the component.
3. Always unplug the computer when cleaning with liquids or damp cloths.
4. Always unplug the computer before cleaning the keyboard, mouse, or air vents.
5. Disconnect the keyboard before cleaning it.
6. Wear safety glasses equipped with side shields when cleaning the keyboard.

Cleaning the Computer Case

Follow all safety precautions in [General cleaning safety precautions on page 39](#) before cleaning the computer.

To clean the computer case, follow the procedures described below:

- To remove light stains or dirt, use plain water with a clean, lint-free cloth or swab.
- For stronger stains, use a mild dishwashing liquid diluted with water. Rinse well by wiping it with a cloth or swab dampened with clear water.
- For stubborn stains, use isopropyl (rubbing) alcohol. No rinsing is needed as the alcohol will evaporate quickly and not leave a residue.
- After cleaning, always wipe the unit with a clean, lint-free cloth.
- Occasionally clean the air vents on the computer. Lint and other foreign matter can block the vents and limit the airflow.

Cleaning the keyboard

Follow all safety precautions in [General cleaning safety precautions on page 39](#) before cleaning the keyboard.

To clean the tops of the keys or the keyboard body, follow the procedures described in [Cleaning the Computer Case on page 39](#).

When cleaning debris from under the keys, review all rules in [General cleaning safety precautions on page 39](#) before following these procedures:

⚠ CAUTION: Use safety glasses equipped with side shields before attempting to clean debris from under the keys.

- Visible debris underneath or between the keys may be removed by vacuuming or shaking.
- Canned, pressurized air may be used to clean debris from under the keys. Caution should be used as too much air pressure can dislodge lubricants applied under the wide keys.
- If you remove a key, use a specially designed key puller to prevent damage to the keys. This tool is available through many electronic supply outlets.

⚠ CAUTION: Never remove a wide leveled key (like the space bar) from the keyboard. If these keys are improperly removed or installed, the keyboard may not function properly.

- Cleaning under a key may be done with a swab moistened with isopropyl alcohol and squeezed out. Be careful not to wipe away lubricants necessary for proper key functions. Use tweezers to remove any fibers or dirt in confined areas. Allow the parts to air dry before reassembly.

Cleaning the monitor

- Wipe the monitor screen with a clean cloth moistened with water or with a towelette designed for cleaning monitors. Do not use sprays or aerosols directly on the screen; the liquid may seep into the housing and damage a component. Never use solvents or flammable liquids on the monitor.
- To clean the monitor body follow the procedures in [Cleaning the Computer Case on page 39](#).

Cleaning the mouse

Before cleaning the mouse, ensure that the power to the computer is turned off.

- Clean the mouse ball by first removing the retaining plate and the ball from the housing. Pull out any debris from the ball socket and wipe the ball with a clean, dry cloth before reassembly.
- To clean the mouse body, follow the procedures in [Cleaning the Computer Case on page 39](#).

Service considerations

Listed below are some of the considerations that you should keep in mind during the disassembly and assembly of the computer.

Power supply fan

The power supply fan is a variable-speed fan based on the temperature in the power supply.

⚠ CAUTION: The cooling fan is always on when the computer is in the “On” mode. The cooling fan is off when the computer is in “Standby,” “Suspend,” or “Off” modes.

You must disconnect the power cord from the power source before opening the computer to prevent system board or component damage.

Tools and software Requirements

To service the computer, you need the following:

- Torx T-15 screwdriver
- Torx T-15 screwdriver with small diameter shank (for certain front bezel removal)
- Flat-bladed screwdriver (may sometimes be used in place of the Torx screwdriver)
- Phillips #2 screwdriver
- Diagnostics software
- Tamper-resistant T-15 wrench

Screws

The screws used in the computer are not interchangeable. They may have standard or metric threads and may be of different lengths. If an incorrect screw is used during the reassembly process, it can damage the unit. HP strongly recommends that all screws removed during disassembly be kept with the part that was removed, then returned to their proper locations.

⚠ CAUTION: Metric screws have a black finish. U.S. screws have a silver finish and are used on hard drives only.

CAUTION: As each subassembly is removed from the computer, it should be placed away from the work area to prevent damage.

Cables and connectors

Most cables used throughout the unit are flat, flexible cables. These cables must be handled with care to avoid damage. Apply only the tension required to seat or unseat the cables during insertion or removal from the connector. Handle cables by the connector whenever possible. In all cases, avoid bending or twisting the cables, and ensure that the cables are routed in such a way that they cannot be caught or snagged by parts being removed or replaced.

⚠ CAUTION: When servicing this computer, ensure that cables are placed in their proper location during the reassembly process. Improper cable placement can damage the computer.

Hard Drives

Handle hard drives as delicate, precision components, avoiding all physical shock and vibration. This applies to failed drives as well as replacement spares.

- If a drive must be mailed, place the drive in a bubble-pack mailer or other suitable protective packaging and label the package "Fragile: Handle With Care."
- Do not remove hard drives from the shipping package for storage. Keep hard drives in their protective packaging until they are actually mounted in the CPU.
- Avoid dropping drives from any height onto any surface.

- If you are inserting or removing a hard drive, turn off the computer. Do not remove a hard drive while the computer is on or in standby mode.
- Before handling a drive, ensure that you are discharged of static electricity. While handling a drive, avoid touching the connector. For more information about preventing electrostatic damage, refer to [Electrostatic discharge information on page 35](#)
- Do not use excessive force when inserting a drive.
- Avoid exposing a hard drive to liquids, temperature extremes, or products that have magnetic fields such as monitors or speakers.

Lithium coin cell battery

The battery that comes with the computer provides power to the real-time clock and has a minimum lifetime of about three years.

See the appropriate removal and replacement chapter for the chassis you are working on in this guide for instructions on the replacement procedures.

 **WARNING!** This computer contains a lithium battery. There is a risk of fire and chemical burn if the battery is handled improperly. Do not disassemble, crush, puncture, short external contacts, dispose in water or fire, or expose it to temperatures higher than 140°F (60°C). Do not attempt to recharge the battery.

 **NOTE:** Batteries, battery packs, and accumulators should not be disposed of together with the general household waste. In order to forward them to recycling or proper disposal, please use the public collection system or return them to HP, their authorized partners, or their agents.

SATA hard drives

Serial ATA Hard Drive Characteristics	
Number of pins/conductors in data cable	7/7
Number of pins in power cable	15
Maximum data cable length	39.37 in (100 cm)
Data interface voltage differential	400-700 mV
Drive voltages	3.3 V, 5 V, 12 V
Jumpers for configuring drive	N/A
Data transfer rate	3.0 Gb/s

SATA hard drive cables

SATA data cable

Always use an HP approved SATA 3.0 Gb/s cable as it is fully backwards compatible with the SATA 1.5 Gb/s drives.

Current HP desktop products ship with SATA 3.0 Gb/s hard drives.

SATA data cables are susceptible to damage if overflexed. Never crease a SATA data cable and never bend it tighter than a 30 mm (1.18 in) radius.

The SATA data cable is a thin, 7-pin cable designed to transmit data for only a single drive.

SMART ATA drives

The Self Monitoring Analysis and Recording Technology (SMART) ATA drives for the HP Personal Computers have built-in drive failure prediction that warns the user or network administrator of an impending failure or crash of the hard drive. The SMART drive tracks fault prediction and failure indication parameters such as reallocated sector count, spin retry count, and calibration retry count. If the drive determines that a failure is imminent, it generates a fault alert.

Cable management

Always follow good cable management practices when working inside the computer.

- Keep cables away from major heat sources like the heat sink.
- Do not jam cables on top of expansion cards or memory modules. Printed circuit cards like these are not designed to take excessive pressure on them.
- Keep cables clear of sliding or moveable parts to prevent them from being cut or crimped when the parts are moved.
- When folding a flat ribbon cable, never fold to a sharp crease. Sharp creases may damage the wires.
- Some flat ribbon cables come prefolded. Never change the folds on these cables.
- Do not bend any cable sharply. A sharp bend can break the internal wires.
- Never bend a SATA data cable tighter than a 30 mm (1.18 in) radius.
- Never crease a SATA data cable.
- Do not rely on components like the drive cage, power supply, or computer cover to push cables down into the chassis. Always position the cables to lay properly by themselves.

5 Removal and replacement procedures: Tower (TWR)

Adherence to the procedures and precautions described in this chapter is essential for proper service. After completing all necessary removal and replacement procedures, run the Diagnostics utility to verify that all components operate properly.

 **NOTE:** Not all features listed in this guide are available on all computers.

Preparation for disassembly

See [Routine care, SATA drive guidelines, and disassembly preparation on page 35](#) for initial safety procedures.

1. Remove/disengage any security devices that prohibit opening the computer.
2. Remove all removable media, such as compact discs or USB flash drives, from the computer.
3. Turn off the computer properly through the operating system, then turn off any external devices.
4. Disconnect the power cord from the power outlet and disconnect any external devices.

 **CAUTION:** Turn off the computer before disconnecting any cables.

Regardless of the power-on state, voltage is always present on the system board as long as the system is plugged into an active AC outlet. In some systems the cooling fan is on even when the computer is in the “Standby,” or “Suspend” modes. The power cord should always be disconnected before servicing a unit.

5. As applicable, lay the computer down on its side to achieve a safe working position.

 **NOTE:** During disassembly, label each cable as you remove it, noting its position and routing. Keep all screws with the units removed.

 **CAUTION:** The screws used in the computer are of different thread sizes and lengths; using the wrong screw in an application may damage the unit.

Access panel

Description	Spare part number
Access panel	732748-001

To access internal components, you must remove the access panel:

1. Prepare the computer for disassembly ([Preparation for disassembly on page 44](#)).
2. Lift up on the access panel handle (1) then lift the access panel off the computer (2).

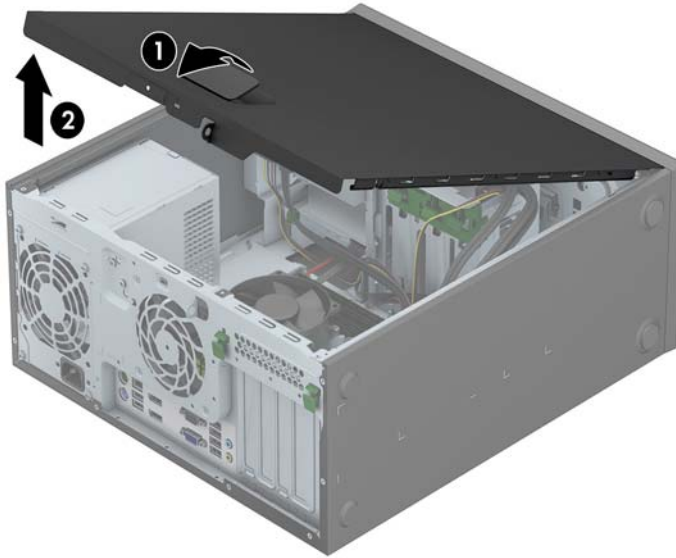

Front bezel security

The front bezel can be locked in place by installing a security screw provided by HP. To install the security screw:

1. Prepare the computer for disassembly ([Preparation for disassembly on page 44](#)).
2. Remove the access panel ([Access panel on page 45](#))
3. Remove the security screw from the side of the hard drive bay just behind the front panel.

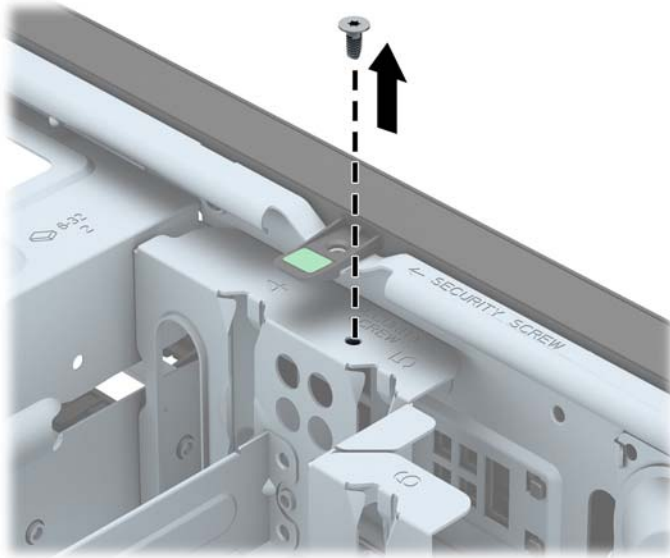

4. Install the security screw through the middle front bezel release tab to secure the front bezel in place.

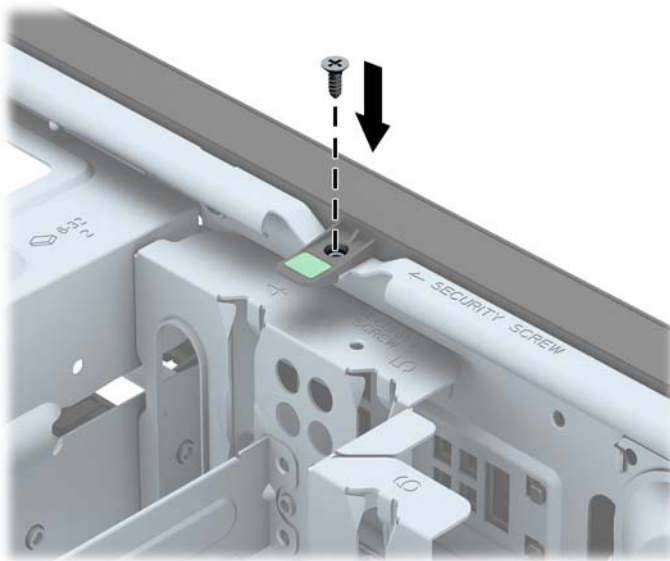

Front bezel

Description	Spare part number
Front bezel	732751-001
Front bezel for use in China	732752-001

1. Prepare the computer for disassembly ([Preparation for disassembly on page 44](#)).
2. Remove the access panel ([Access panel on page 45](#))
3. Lift up the three tabs on the side of the bezel (1), then rotate the bezel off the chassis (2).

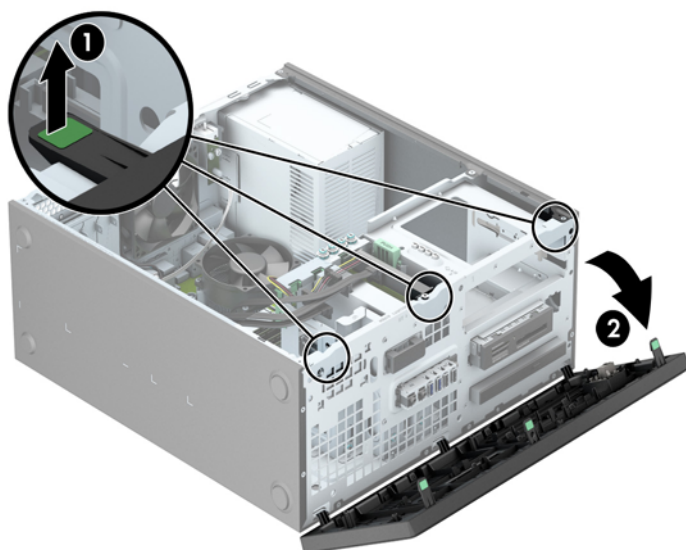



Bezel blanks

Description	Spare part number
Optical drive bezel blank	732770-001

On some models, there are bezel blanks covering the 3.5-inch and 5.25-inch drive bays that need to be removed before installing a drive. To remove a bezel blank:

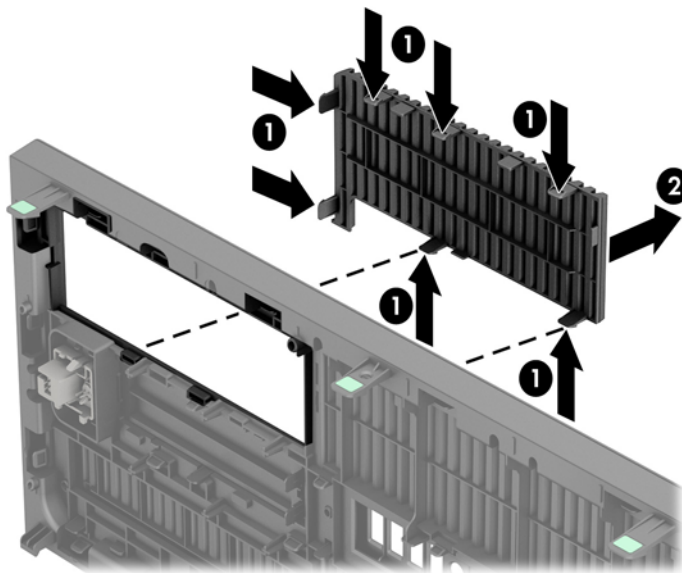
1. Remove the access panel ([Access panel on page 45](#))
2. Remove the front bezel ([Front bezel on page 47](#))
3. Remove the bezel blank for the appropriate drive:
 - To remove a 5.25-inch bezel blank, press inward on the retaining tabs that hold the bezel blank in place (1) then pull the bezel blank from the front bezel (2).



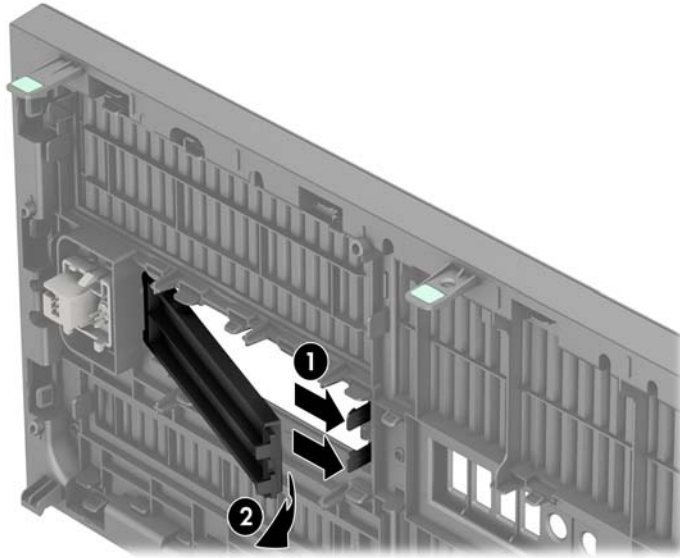

 **NOTE:** After removing the 5.25-inch drive bezel blank and installing a drive, you can install an optional bezel trim piece (available from HP) that surrounds the front of the drive.

- To remove a 3.5-inch bezel blank, press outward on the two retaining tabs that hold the bezel blank in place (1) and rotate the bezel blank back and to the right to remove it (2).

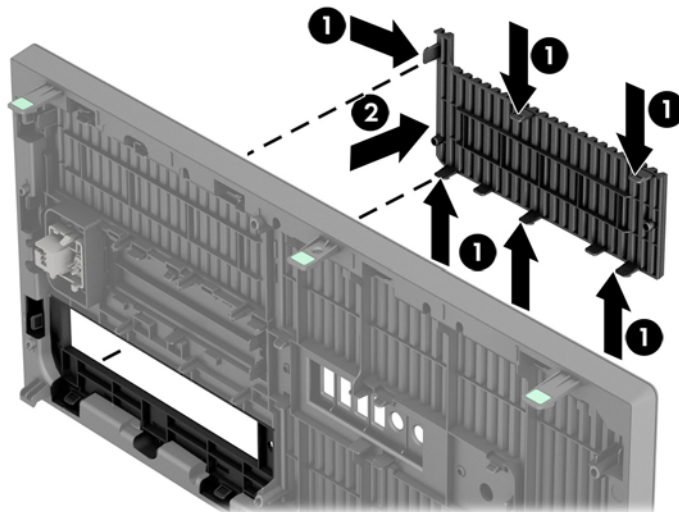

- To remove a slim optical drive bezel blank, press inward on the retaining tabs that hold the bezel blank in place (1) then pull the bezel blank from the front bezel (2).



 **NOTE:** After removing the slim optical drive bezel blank and installing a slim optical drive, you can install an optional bezel trim piece (available from HP) that surrounds the front of the slim optical drive.

Memory

Description	Spare part number
8-GB, PC3-12800	689375-001
4-GB, PC3-12800	671613-001
2-GB, PC3-12800	671612-001

The computer comes with double data rate 3 synchronous dynamic random access memory (DDR3-SDRAM) dual inline memory modules (DIMMs).

DIMMs

The memory sockets on the system board can be populated with up to four industry-standard DIMMs. These memory sockets are populated with at least one preinstalled DIMM. To achieve the maximum memory support, you can populate the system board with up to 32-GB of memory configured in a high-performing dual channel mode.

DDR3-SDRAM DIMMs

For proper system operation, the DDR3-SDRAM DIMMs must be:

- industry-standard 240-pin
- unbuffered non-ECC PC3-12800 DDR3-1600 MHz-compliant
- 1.35 volt or 1.5 volt DDR3/DDR3L-SDRAM DIMMs

The DDR3-SDRAM DIMMs must also:

- support CAS latency 11 DDR3 1600 MHz (11-11-11 timing)
- contain the mandatory JEDEC SPD information

In addition, the computer supports:

- 512-Mbit, 1-Gbit, and 2-Gbit non-ECC memory technologies
- single-sided and double-sided DIMMs
- DIMMs constructed with x8 and x16 DDR devices; DIMMs constructed with x4 SDRAM are not supported



NOTE: The system will not operate properly if you install unsupported DIMMs.

Populating DIMM sockets

There are four DIMM sockets on the system board, with two sockets per channel. The sockets are labeled DIMM1, DIMM2, DIMM3, and DIMM4. Sockets DIMM1 and DIMM2 operate in memory channel B. Sockets DIMM3 and DIMM4 operate in memory channel A.

The system will automatically operate in single channel mode, dual channel mode, or flex mode, depending on how the DIMMs are installed.

 **NOTE:** Single channel and unbalanced dual channel memory configurations will result in inferior graphics performance.

- The system will operate in single channel mode if the DIMM sockets are populated in one channel only.
- The system will operate in a higher-performing dual channel mode if the total memory capacity of the DIMMs in Channel A is equal to the total memory capacity of the DIMMs in Channel B. The technology and device width can vary between the channels. For example, if Channel A is populated with two 1-GB DIMMs and Channel B is populated with one 2-GB DIMM, the system will operate in dual channel mode.
- The system will operate in flex mode if the total memory capacity of the DIMMs in Channel A is not equal to the total memory capacity of the DIMMs in Channel B. In flex mode, the channel populated with the least amount of memory describes the total amount of memory assigned to dual channel and the remainder is assigned to single channel. For optimal speed, the channels should be balanced so that the largest amount of memory is spread between the two channels. If one channel will have more memory than the other, the larger amount should be assigned to Channel A. For example, if you are populating the sockets with one 2-GB DIMM, and three 1-GB DIMMs, Channel A should be populated with the 2-GB DIMM and one 1-GB DIMM, and Channel B should be populated with the other two 1-GB DIMMs. With this configuration, 4-GB will run as dual channel and 1-GB will run as single channel.
- In any mode, the maximum operational speed is determined by the slowest DIMM in the system.

Installing DIMMs

 **CAUTION:** You must disconnect the power cord and wait approximately 30 seconds for the power to drain before adding or removing memory modules. Regardless of the power-on state, voltage is always supplied to the memory modules as long as the computer is plugged into an active AC outlet. Adding or removing memory modules while voltage is present may cause irreparable damage to the memory modules or system board.

The memory module sockets have gold-plated metal contacts. When upgrading the memory, it is important to use memory modules with gold-plated metal contacts to prevent corrosion and/or oxidation resulting from having incompatible metals in contact with each other.

Static electricity can damage the electronic components of the computer or optional cards. Before beginning these procedures, ensure that you are discharged of static electricity by briefly touching a grounded metal object.

When handling a memory module, be careful not to touch any of the contacts. Doing so may damage the module.

1. Prepare the computer for disassembly ([Preparation for disassembly on page 44](#)).
2. Remove the access panel ([Access panel on page 45](#))

3. Open both latches of the memory module socket **(1)**, and insert the memory module into the socket **(2)**.

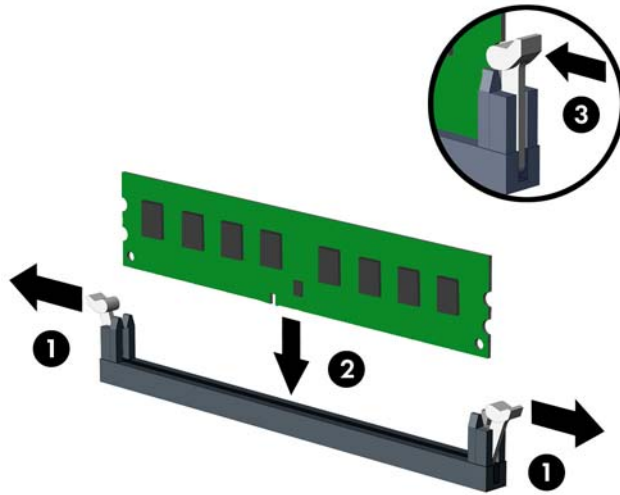

 **NOTE:** A memory module can be installed in only one way. Match the notch on the module with the tab on the memory socket.

Populate the black DIMM sockets before the white DIMM sockets.

For maximum performance, populate the sockets so that the memory capacity is spread as equally as possible between Channel A and Channel B. Refer to [Populating DIMM sockets on page 50](#) for more information.

4. Push the module down into the socket, ensuring that the module is fully inserted and properly seated. Make sure the latches are in the closed position **(3)**.
5. Repeat steps 3 and 4 to install any additional modules.

The computer should automatically recognize the additional memory the next time you turn on the computer.

Expansion cards

Description	Spare part number
nVidia Quadro NVS310 PCIe x16 graphics card, 512 MB	707252-001
nVidia Quadro NVS315 PCIe x16 graphics card, 1 GB	720837-001
AMD Radeon HD8490 PCIe x16 graphics card, 1 GB	717219-001
AMD Radeon HD8470 PCIe x16 graphics card, 2 GB DDR3	729085-001
AMD Radeon HD 8350 1GB PCIe x16 DH GFX	717220-001
GeForce GT630 PCIe x16 graphics card, 2 GB	702084-001
Intel PRO/1000 single port GbE NIC, includes bracket	728562-001
HP PCI expansion slot daughter card	696971-001

The computer has two PCI Express x1 expansion slots, one PCI Express x16 expansion slot, and one PCI Express x16 expansion slot that is downshifted to a x4 slot. Some models also have an optional standard PCI expansion slot.

 **NOTE:** You can install a PCI Express x1, x8, or x16 expansion card in the PCI Express x16 slots.

For dual graphics card configurations, the first (primary) card must be installed in the PCI Express x16 slot that is NOT downshifted to a x4.

You can add the optional standard PCI expansion slot to the system board by purchasing a PCI extender board from HP.

To remove, replace, or add an expansion card:

1. Prepare the computer for disassembly ([Preparation for disassembly on page 44](#)).
2. Remove the access panel ([Access panel on page 45](#))
3. Locate the correct vacant expansion socket on the system board and the corresponding expansion slot on the back of the computer chassis.

4. Press straight down on the two green thumb tabs on the exterior of the chassis (1) and rotate the expansion card retention latch open (2).

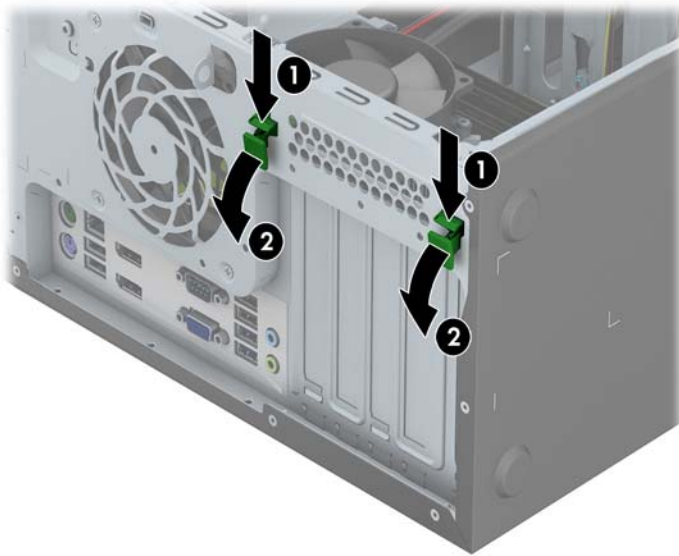

5. Before installing an expansion card, remove the expansion slot cover or the existing expansion card.

 **NOTE:** Before removing an installed expansion card, disconnect any cables that may be attached to the expansion card.

- a. If you are installing an expansion card in a vacant socket, remove the appropriate expansion slot cover on the back of the chassis. Lift the expansion slot cover from the expansion slot.

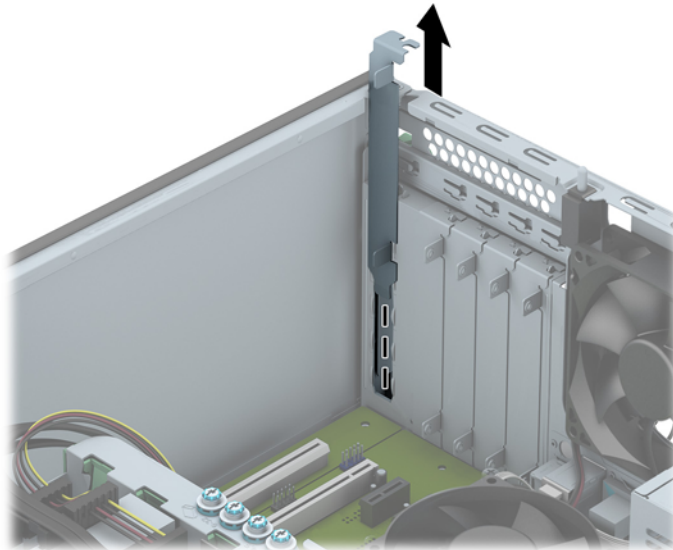

- b. If you are removing a standard PCI card or PCI Express x1 card, hold the card at each end and carefully rock it back and forth until the connectors pull free from the socket. Lift the card straight up to remove it. Be sure not to scrape the card against other components.

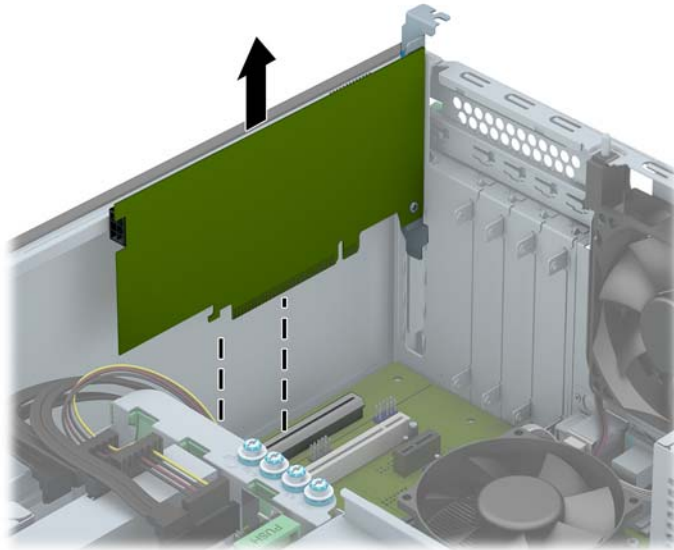

- c. If you are removing a PCI Express x16 card, pull the retention arm on the back of the expansion socket away from the card and carefully rock the card back and forth until the connectors pull free from the socket. Lift the card straight up to remove it. Be sure not to scrape the card against other components.

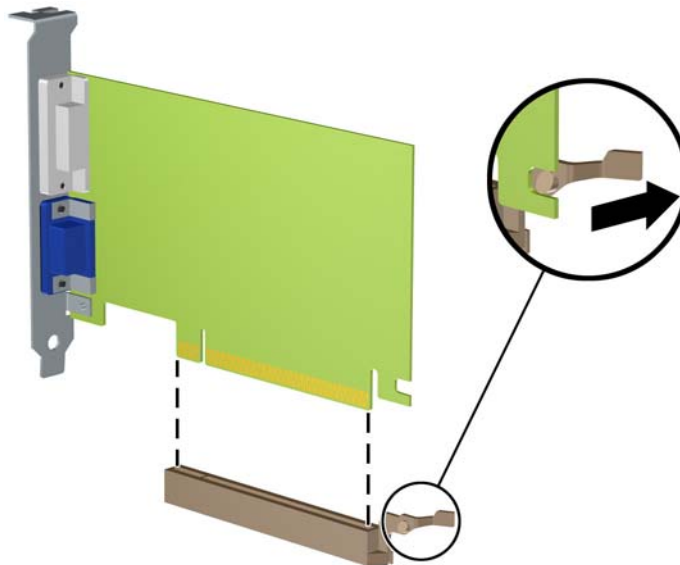

6. Store the removed card in anti-static packaging.
7. If you are not installing a new expansion card, install an expansion slot cover to close the open slot.

CAUTION: After removing an expansion card, you must replace it with a new card or expansion slot cover for proper cooling of internal components during operation.

8. To install a new expansion card, slide the bracket on the end of the card down into the slot on the back of the chassis and press the card down firmly into the socket on the system board.

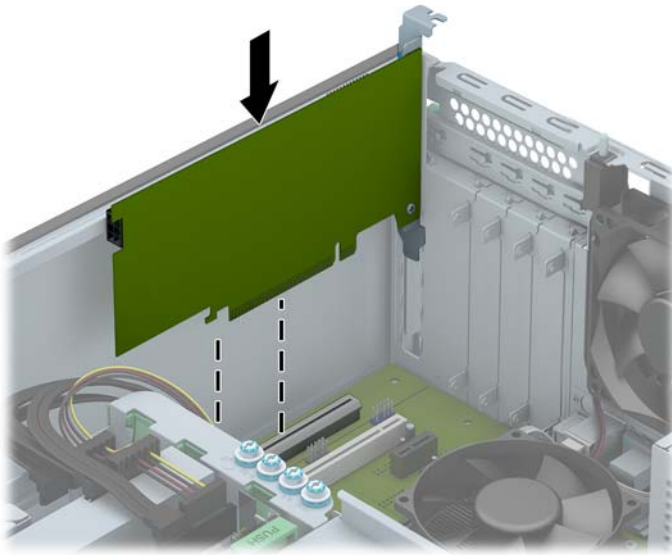

 **NOTE:** When installing an expansion card, press firmly on the card so that the whole connector seats properly in the expansion card slot.

9. Close the expansion card retention latch, making sure that it snaps firmly into place.



10. Connect external cables to the installed card, if needed. Connect internal cables to the system board, if needed.

System board connections

Refer to the following illustration and table to identify the system board connectors.

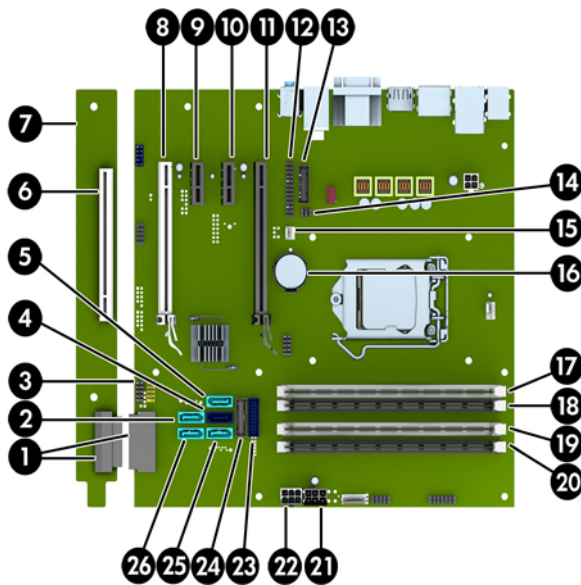

No.	System Board Connector	System Board Label	Color	Component
1	System Board PCI Extender Connectors	EXT	black	System Board PCI Extender (optional, shown installed)
2	SATA 3.0	SATA1	light blue	Any SATA Device other than the Primary Hard Drive
3	USB 2.0	MEDIA	black	USB 2.0 Device, such as a USB 2.0 Media Card Reader
4	SATA 3.0	SATA0	dark blue	Primary Hard Drive
5	SATA 3.0	SATA2	light blue	Any SATA Device other than the Primary Hard Drive
6	PCI (optional)	PCI1	white	Expansion Card
7	System Board PCI Extender (optional)	(not applicable)	(not applicable)	Expansion Card
8	PCI Express x16 downshifted to a x4	X4PCIEXP	white	Expansion Card
9	PCI Express x1	X1PCIEXP2	black	Expansion Card
10	PCI Express x1	X1PCIEXP1	black	Expansion Card
11	PCI Express x16	X16PCIEXP	black	Expansion Card
12	Parallel Port	PAR	black	Parallel Port
13	Serial Port	COMB	black	Serial Port
14	Hood Lock	HLCK	black	Hood Lock
15	Hood Sensor	HSENSE	white	Hood Sensor

No.	System Board Connector	System Board Label	Color	Component
16	Battery	BAT	black	Battery
17	DIMM4 (Channel A)	DIMM4	white	Memory Module
18	DIMM3 (Channel A)	DIMM3	black	Memory Module
19	DIMM2 (Channel B)	DIMM2	white	Memory Module
20	DIMM1 (Channel B)	DIMM1	black	Memory Module
21	Power	SATA PWRO	black	SATA Drives
22	Power	PWR	white	System Board
23	USB 3.0	FRONT USB3.0	blue	Front USB 3.0 Ports
24	USB 3.0	MEDIA3.0	black	USB 3.0 Device, such as a USB 3.0 Media Card Reader
25	SATA 3.0	SATA3	light blue	Any SATA Device other than the Primary Hard Drive
26	SATA 3.0	SATA5	light blue	Any SATA Device other than the Primary Hard Drive

Drives

Description	Spare part number
Optical drives	
DVD±RW drive	657958-001
DVD-ROM drive	608394-001
Blu-ray BD-RW SuperMulti XL Drive	719157-001
Hard drives	
2 TB, 7200 rpm hard drive	616608-001
1 TB hard drive, hybrid SSD	724937-001
1 TB, 10000 rpm hard drive	719106-001
1 TB, 7200 rpm hard drive	613202-001
750 GB, 7200 rpm, 2.5-inch hard drive, hybrid SSD	719105-001
500 GB, 10000 rpm hard drive	683923-001
500 GB, 7200 rpm, 2.5-inch hard drive, self-encrypting (SED)	696442-001
500 GB, 7200 rpm hard drive	696442-001
500 GB hard drive, hybrid SSD	724938-001
256 GB Solid State Drive (SSD), self-encrypting (SED)	680020-001
128 GB Solid State Drive (SSD)	665961-001
32 GB mSATA drive	686616-001

When installing drives, follow these guidelines:

- The primary Serial ATA (SATA) hard drive must be connected to the dark blue primary SATA connector on the system board labeled SATA0.
- Connect secondary hard drives and optical drives to any of the light blue SATA connectors on the system board (labeled SATA1, SATA2, SATA3, and SATA5).
- Connect a media card reader USB 3.0 cable to the USB connector on the system board labeled MEDIA3.0.
- The power cable for the drives has two branches coming off the system board connector. The first branch is a three-headed cable with the first connector routed to the 5.25-inch bay, the second connector routed to the 3.5-inch bay, and the third (two-wire) connector routed to the slim optical drive bay. The second branch is a three-headed cable with the first connector routed to the bottom 2.5-inch hard drive bay, the second connector routed to the middle 3.5-inch hard drive bay, and the third connector routed to the top 3.5-inch hard drive bay.
- You must install guide screws to ensure the drive will line up correctly in the drive cage and lock in place. HP has provided extra guide screws (four 6-32 silver and blue isolation mounting guide

screws and four silver 6-32 standard guide screws) installed on the side of the drive bays. The 6-32 isolation mounting screws are required for 3.5-inch hard drives installed in the 3.5-inch hard drive bays. The 6-32 standard guide screws are required for a USB 3.0 media card reader installed in the 3.5-inch optional drive bay. M3 metric guide screws for 5.25-inch optical drives and M3 isolation mounting guide screws for 2.5-inch hard drives are not provided. If you are replacing a drive, remove the guide screws from the old drive and install them in the new drive.

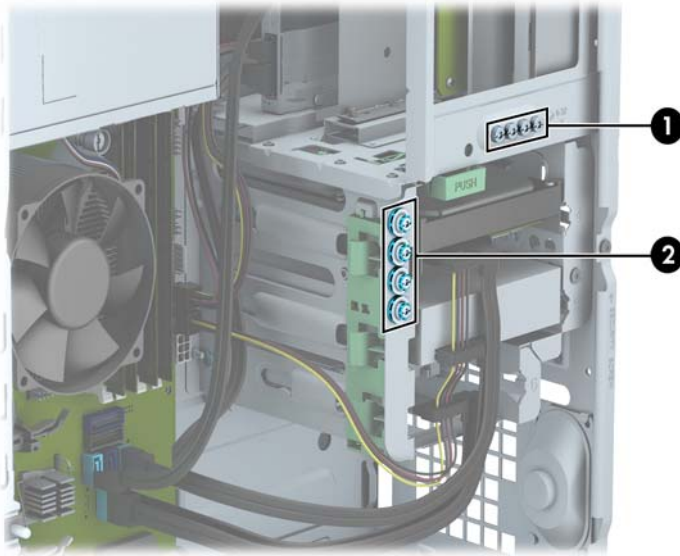

No.	Guide Screw	Device
1	Silver Standard 6-32 Guide Screws	USB 3.0 Media Card Reader
2	Silver and Blue 6-32 Isolation Mounting Screws	Secondary Hard Drive in 3.5-inch Hard Drive Bay

⚠ CAUTION: To prevent loss of work and damage to the computer or drive:

If you are inserting or removing a drive, shut down the operating system properly, turn off the computer, and unplug the power cord. Do not remove a drive while the computer is on or in standby mode.

Before handling a drive, ensure that you are discharged of static electricity. While handling a drive, avoid touching the connector.

Handle a drive carefully; do not drop it.

Do not use excessive force when inserting a drive.

Avoid exposing a hard drive to liquids, temperature extremes, or products that have magnetic fields such as monitors or speakers.

If a drive must be mailed, place the drive in a bubble-pack mailer or other protective packaging and label the package "Fragile: Handle With Care."

Drive positions

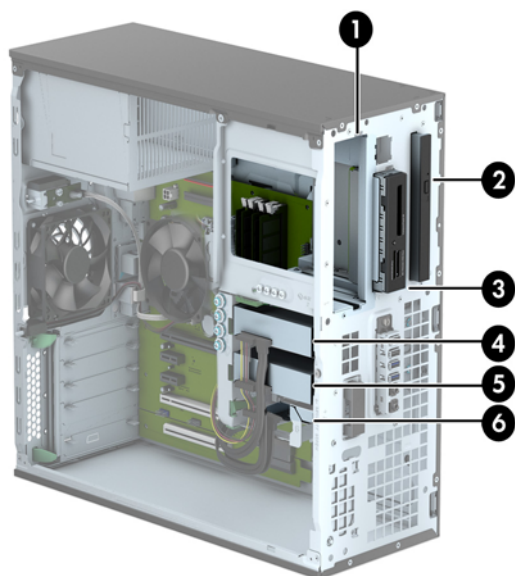



-
- | | |
|---|---|
| 1 | 5.25-inch half-height drive bay |
| 2 | Slim optical drive bay |
| 3 | 3.5-inch drive bay for optional drive (such as a media card reader) |
| 4 | Primary 3.5-inch internal hard drive bay |
| 5 | Secondary 3.5-inch internal hard drive bay |
| 6 | Secondary 2.5-inch internal hard drive bay |
-

NOTE: The drive configuration on your computer may be different than the drive configuration shown above.

To verify the type and size of the storage devices installed in the computer, run Computer Setup.

Removing a 5.25-inch drive

 **NOTE:** HP does not offer a 5.25-inch optical drive for this computer model. A 5.25-inch optical drive may have been installed by the user or third-party vendor.

 **CAUTION:** All removable media should be taken out of a drive before removing the drive from the computer.

1. Prepare the computer for disassembly ([Preparation for disassembly on page 44](#))
2. Remove the access panel ([Access panel on page 45](#))
3. Remove the front bezel ([Front bezel on page 47](#))
4. Disconnect the power cable and data cable from the back of the drive.

 **CAUTION:** When removing the cables, pull the tab or connector instead of the cable itself to avoid damaging the cable.

5. Press down on the green drivelock mechanism (1) and slide the drive from the drive bay (2).

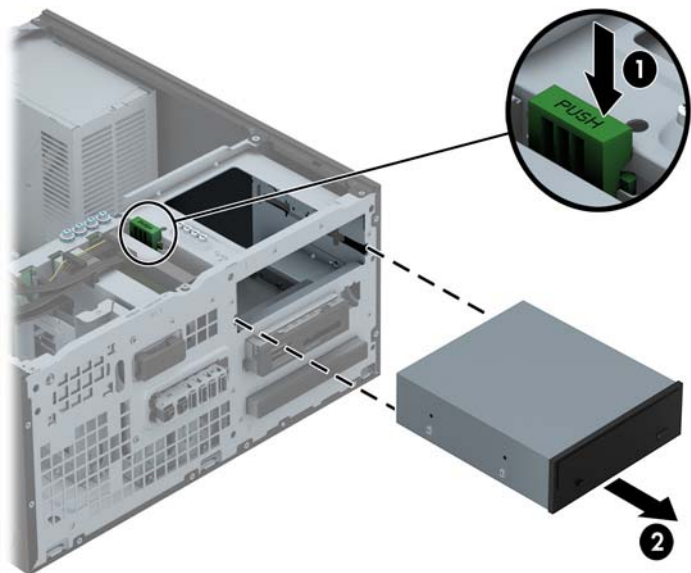



Installing a 5.25-inch drive

 **NOTE:** HP does not offer a 5.25-inch optical drive for this computer model. A 5.25-inch optical drive can be purchased through a third-party vendor.

1. Prepare the computer for disassembly ([Preparation for disassembly on page 44](#))
2. Remove the access panel ([Access panel on page 45](#))
3. Remove the front bezel ([Front bezel on page 47](#)). If you are installing a drive in a bay covered by a bezel blank, remove the bezel blank. See [Bezel blanks on page 48](#) for more information.

4. If you are installing an optical drive, install four M3 metric guide screws (not provided) in the lower holes on each side of the drive.

 **NOTE:** When replacing an optical drive, transfer the four M3 metric guide screws from the old drive to the new one.

 **CAUTION:** Use only 5-mm long screws as guide screws. Longer screws can damage the internal components of the drive.

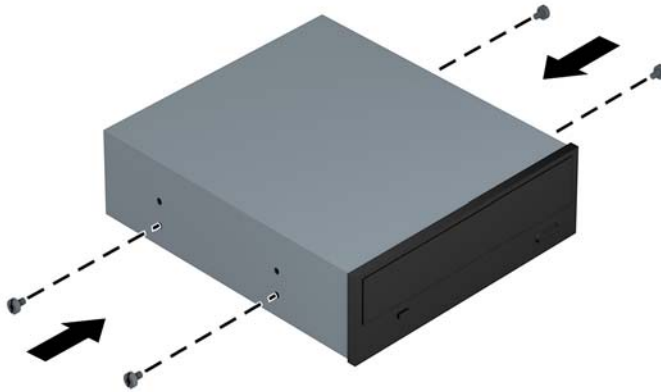

5. Slide the drive into the drive bay, making sure to align the guide screws with the guide slots, until the drive snaps into place.

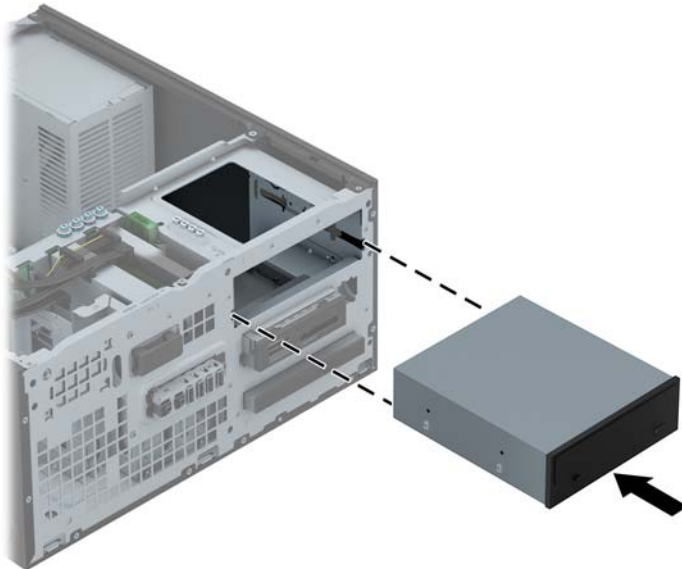

6. Connect the power cable and data cable to the rear of the optical drive.

7. Connect the opposite end of the data cable to one of the light blue SATA connectors on the system board.

 **NOTE:** Refer to [System board connections on page 57](#) for an illustration of the system board drive connectors.

8. Replace the front bezel.

 **NOTE:** An optional bezel trim piece that surrounds the front of the 5.25-inch drive is available from HP. Install the bezel trim piece in the front bezel before replacing the front bezel.

Removing a 3.5-inch device

 **CAUTION:** All removable media should be taken out of a drive before removing the drive from the computer.

1. Prepare the computer for disassembly ([Preparation for disassembly on page 44](#))
2. Remove the access panel ([Access panel on page 45](#))
3. Remove the front bezel ([Front bezel on page 47](#))
4. Disconnect the drive cables from the rear of the drive, or, if you are removing a media card reader, disconnect the USB cable from the system board as indicated in the following illustration.



5. Press the release lever at the rear of the drive away from the drive (1) and slide the drive from the drive bay (2).

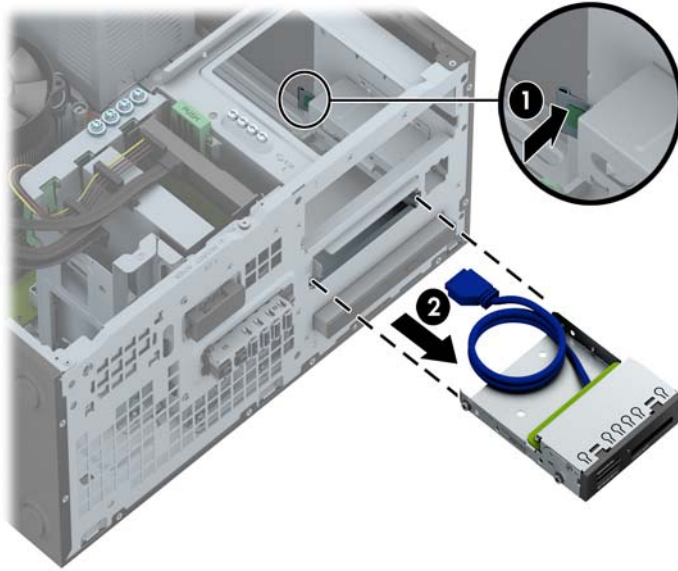

Installing a 3.5-inch device

1. Prepare the computer for disassembly ([Preparation for disassembly on page 44](#)).
2. Remove the access panel ([Access panel on page 45](#)).
3. Remove the front bezel ([Front bezel on page 47](#)). Remove the front bezel. If you are installing a drive in a bay covered by a bezel blank, remove the bezel blank. See [System board connections on page 57](#) for more information.
4. Install 6-32 guide screws in the holes on each side of the drive.

 **NOTE:** HP has supplied four extra 6-32 guide screws on top of the drive cage. Refer to [Drives on page 59](#) for an illustration of the extra guide screws location.

When replacing a drive, transfer the four 6-32 guide screws from the old drive to the new one.



5. Slide the drive into the drive bay, making sure to align the guide screws with the guide slots, until the drive snaps into place.



6. If installing a USB 3.0 media card reader, connect the USB cable from the media card reader to the USB 3.0 connector on the system board labeled MEDIA3.0.



 **NOTE:** Refer to [System board connections on page 57](#) for an illustration of the system board drive connectors.

Removing a slim optical drive

 **CAUTION:** All removable media should be taken out of a drive before removing the drive from the computer.

1. Prepare the computer for disassembly ([Preparation for disassembly on page 44](#))
2. Remove the access panel ([Access panel on page 45](#))
3. Remove the front bezel ([Front bezel on page 47](#))
4. Disconnect the power cable and data cable from the back of the drive.

 **CAUTION:** When removing the cables, pull the tab or connector instead of the cable itself to avoid damaging the cable.

5. Push the green release lever on the right rear side of the drive toward the center of the drive (1), then slide the drive forward and out of the bay (2).

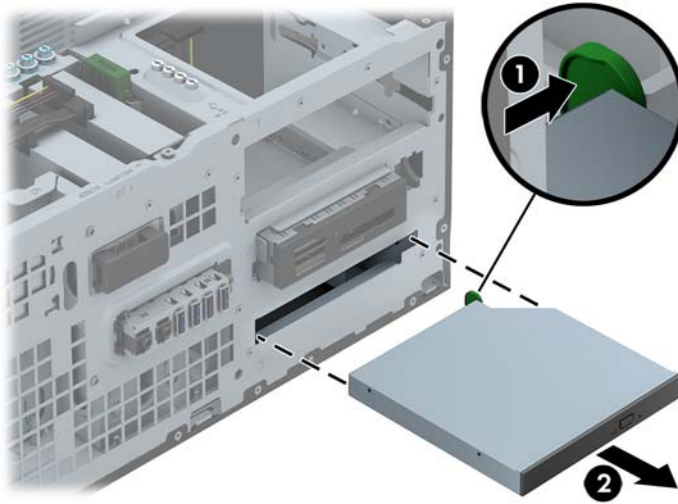

Installing a slim optical drive

1. Prepare the computer for disassembly ([Preparation for disassembly on page 44](#)).
2. Remove the access panel ([Access panel on page 45](#)).
3. Remove the front bezel ([Front bezel on page 47](#)). If you are installing a drive in a bay covered by a bezel blank, remove the bezel blank. See [System board connections on page 57](#) for more information.
4. Before the new optical drive can be used, the release latch must be attached.
 - a. Peel the backing off the adhesive on the release latch.
 - b. Without allowing the release latch to touch the optical drive, carefully align the holes on the release latch with the pins on the side of the optical drive. Make sure the release latch is oriented properly.
 - c. Insert the pin at the front of the optical drive into the hole at the end of the release latch, and press firmly.

- d. Insert the second pin, and press the entire release latch firmly to fasten the latch securely to the optical drive.

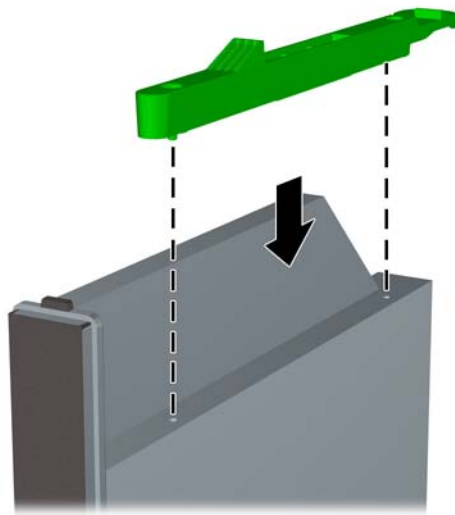

5. Slide the optical drive through the front bezel all the way into the bay so that it locks in place.

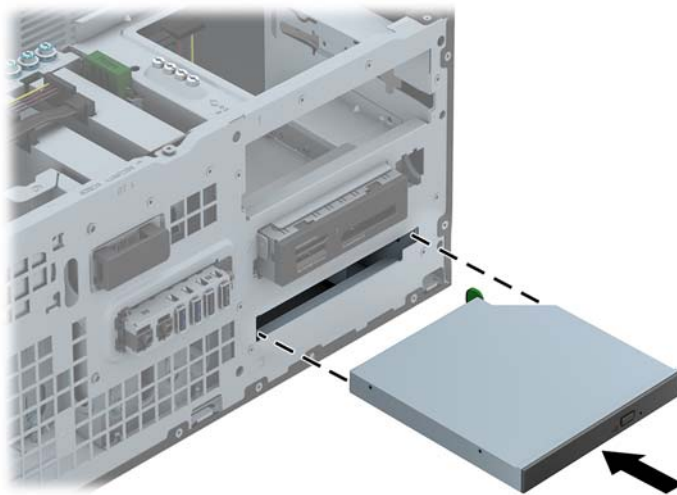

6. Connect the power cable and data cable to the rear of the optical drive.
7. Connect the opposite end of the data cable to one of the light blue SATA connectors on the system board.

 **NOTE:** Refer to [System board connections on page 57](#) for an illustration of the system board drive connectors.

8. Replace the front bezel.

 **NOTE:** An optional bezel trim piece that surrounds the front of the slim optical drive is available from HP. Install the bezel trim piece in the front bezel before replacing the front bezel.

Removing a 3.5-inch or 2.5-inch hard drive

 **NOTE:** Before you remove the old hard drive, be sure to back up the data from the old hard drive so that you can transfer the data to the new hard drive.

1. Prepare the computer for disassembly ([Preparation for disassembly on page 44](#))
2. Remove the access panel ([Access panel on page 45](#))
3. Disconnect the power cable (1) and data cable (2) from the back of the hard drive.

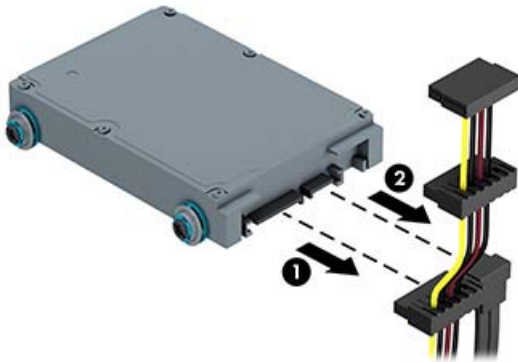
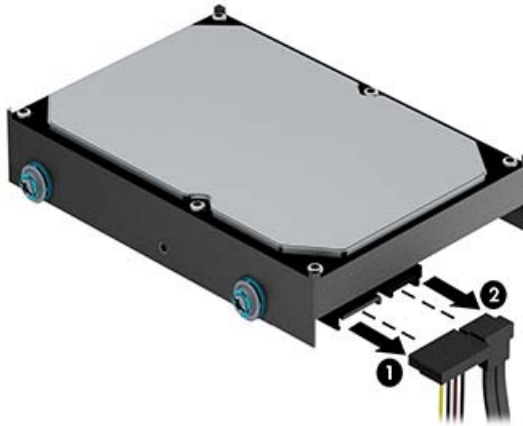

4. Release the drive by pulling the release tab away from the drive (1) and sliding the drive out of the bay (2).

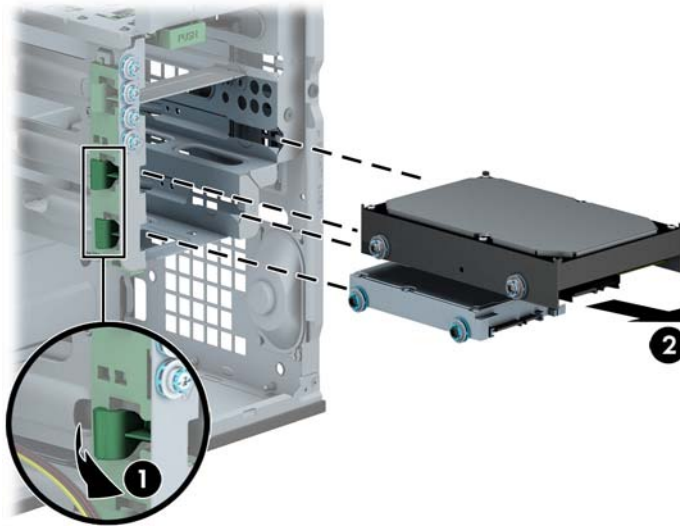

5. Remove the four guide screws (two on each side) from the old drive. You will need these screws to install a new drive.

Installing a 3.5-inch or 2.5-inch hard drive

1. Prepare the computer for disassembly ([Preparation for disassembly on page 44](#))
2. Remove the access panel ([Access panel on page 45](#))

3. Install guide screws on the sides of the drive. 3.5-inch hard drives use standard 6-32 silver and blue isolation mounting screws. 2.5-inch hard drives use metric M3 black and blue isolation mounting screws.

 **NOTE:** Four extra 6-32 isolation mounting guide screws for 3.5-inch hard drives are installed on the exterior of the hard drive bays. Extra guide screws for 2.5-inch hard drives are not provided on the chassis but can be purchased from HP. Refer to [Drives on page 59](#) for an illustration of the extra 6-32 isolation mounting guide screws location.

If you are replacing a drive, transfer the guides screws from the old drive to the new one.

- If you are installing a 3.5-inch hard drive, install four silver and blue 6-32 isolation mounting guide screws (two on each side of the drive).

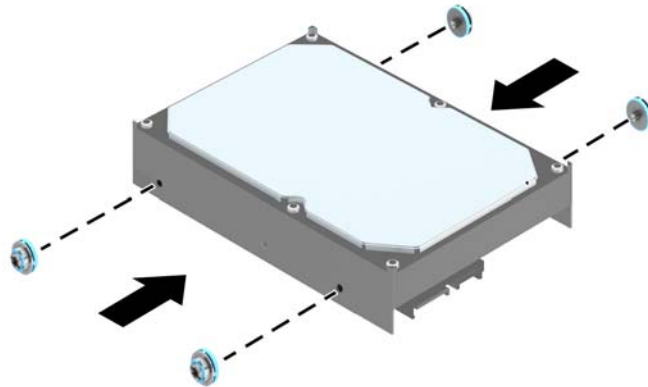

- If you are installing a 2.5-inch hard drive, install four black and blue M3 isolation mounting guide screws (two on each side of the drive).

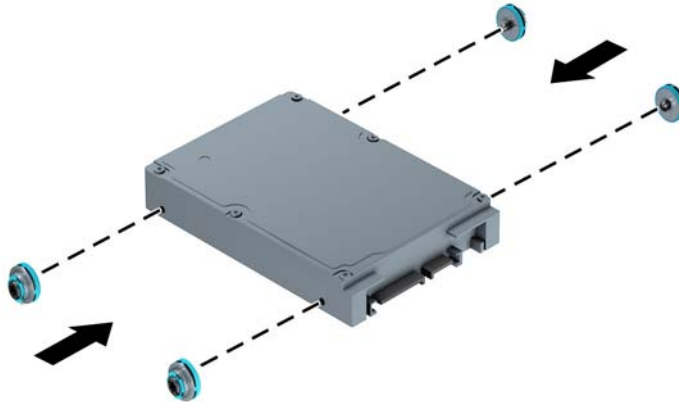

- You can also install a 2.5-inch hard drive into a 3.5-inch drive bay using an adapter bracket similar to the example shown below.
 - Slide the drive into the bay adapter bracket, ensuring the connector on the drive is fully inserted into the connector on the adapter bracket.

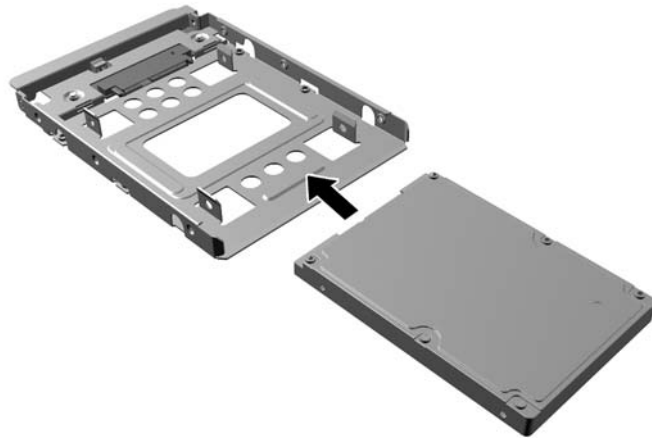

- Secure the drive to the bay adapter bracket by installing four black M3 adapter bracket screws through the sides of the bracket into the drive.

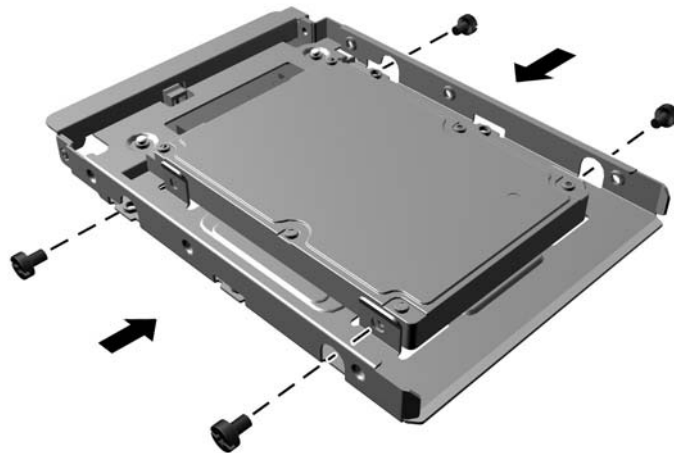

- Install four 6-32 silver and blue isolation mounting guide screws in the adapter bracket (two on each side of the bracket).

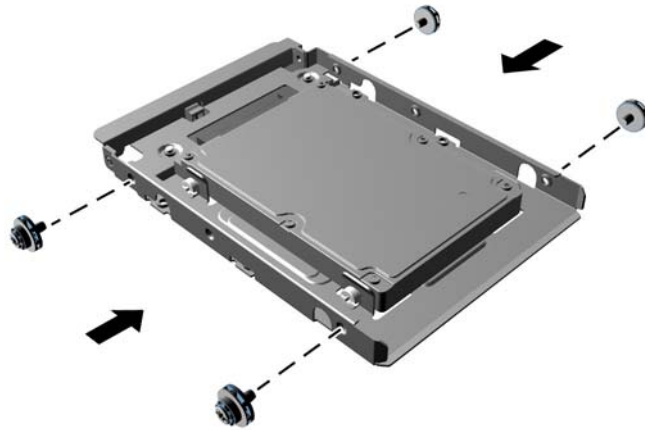

4. Slide the drive into the drive bay, making sure to align the guide screws with the guide slots, until the drive snaps into place.

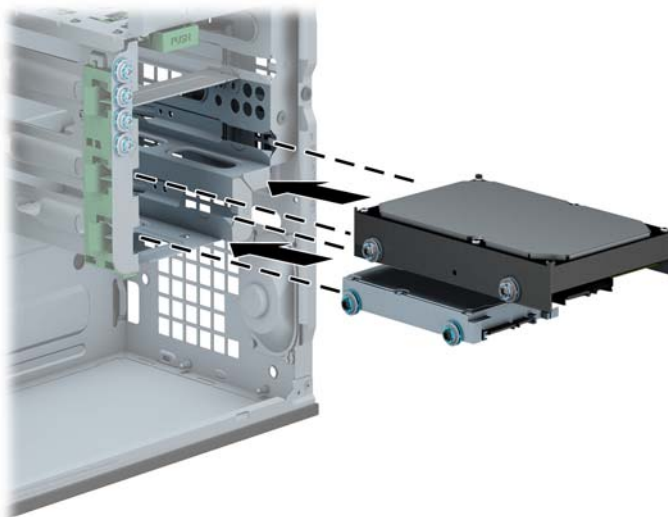

5. Connect the power cable (1) and data cable (2) to the back of the hard drive.

 **NOTE:** The power cable for the hard drives is a three-headed cable that is routed from the system board to the rear of the hard drive bays.

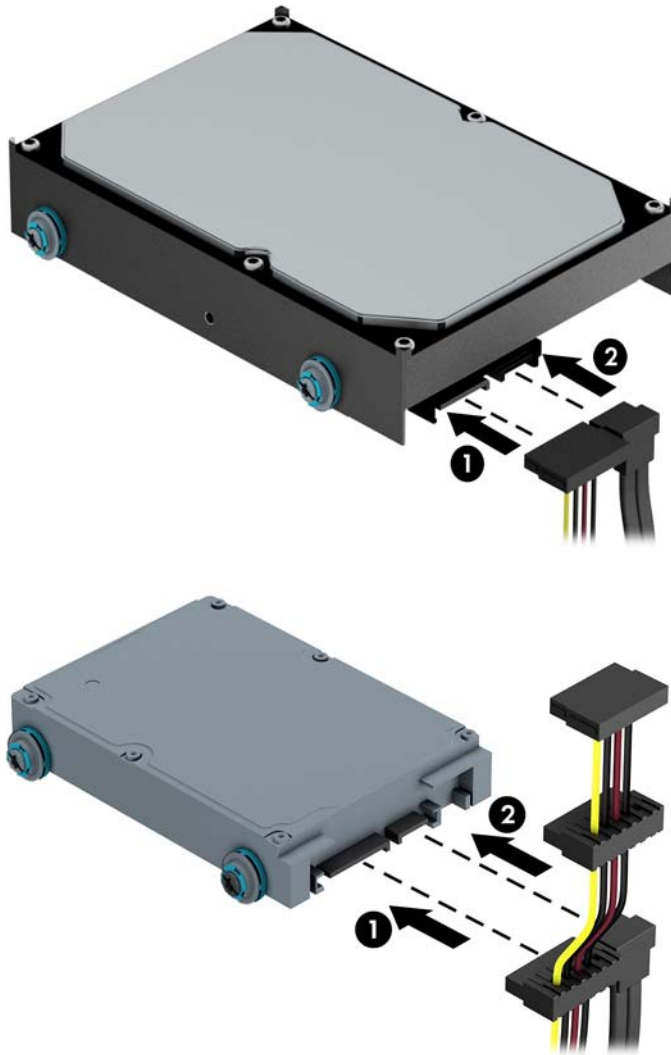

6. If installing a new drive, connect the opposite end of the data cable to the appropriate system board connector.

 **NOTE:** You must connect the primary hard drive data cable to the dark blue connector labeled SATA0 to avoid any hard drive performance problems. If you are adding a second hard drive, connect the data cable to one of the light blue SATA connectors.

Front I/O assembly

Description	Spare part number
Front I/O assembly	732750-001

1. Prepare the computer for disassembly ([Preparation for disassembly on page 44](#)).
2. Remove the access panel ([Access panel on page 45](#)).
3. Remove the front bezel ([Front bezel on page 47](#)).
4. Disconnect the three front I/O cables from the following system board connectors:
 - FRONT USB
 - MEDIA 3.0
 - FRONT AUD
5. Remove the Torx T15 screw that secures the assembly to the chassis **(1)**.
6. Rotate the right side of the assembly outward **(2)**.



7. Pull the assembly away from the computer while threading the wires through the hole in the front of the chassis.

To reinstall the assembly, reverse the removal procedure.

Power switch/LED assembly

Description	Spare part number
Power switch/LED assembly	732749-001

1. Prepare the computer for disassembly ([Preparation for disassembly on page 44](#)).
2. Remove the access panel ([Access panel on page 45](#)).
3. Remove the front bezel ([Front bezel on page 47](#)).
4. Disconnect the cable from the system board connector labeled PB/LED.



5. Press down on the top of the assembly to disengage the tab that secures the assembly to the chassis.

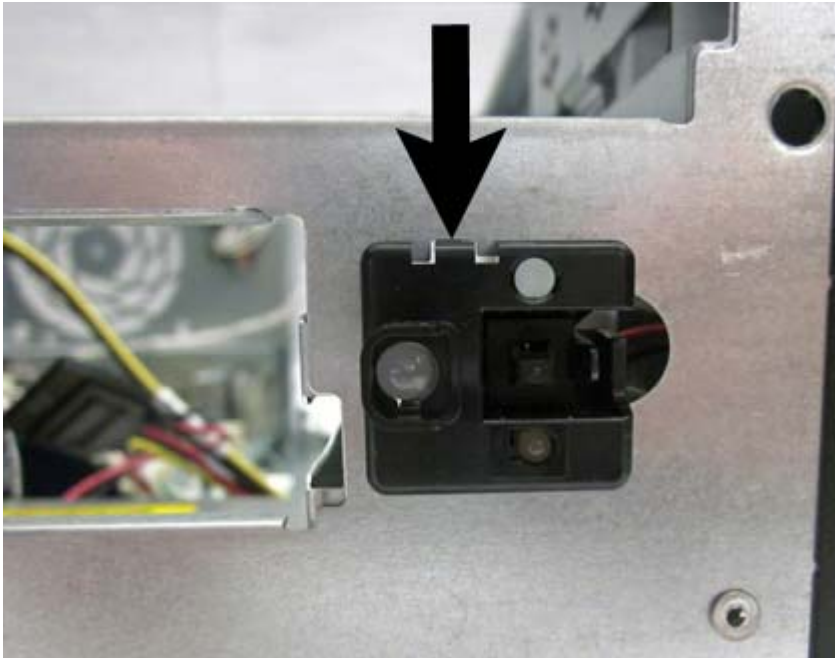

6. Rotate the assembly downward to remove it from the chassis.

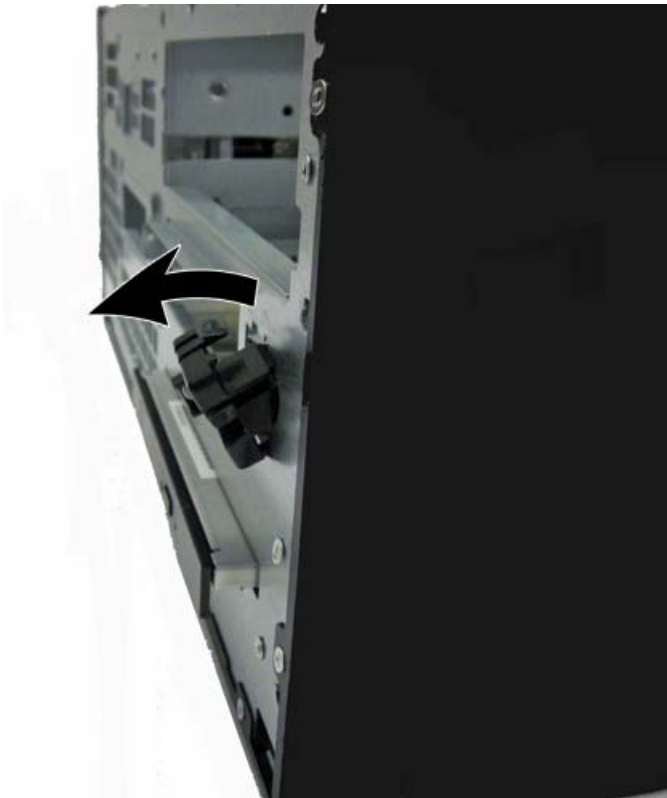

7. Pull the assembly away from the chassis while threading the cable through the hole in front of the chassis.

Fan sink

Description	Spare part number
Fan sink	727142-001

⚠ WARNING! To reduce risk of personal injury from hot surfaces, allow the internal system components to cool before touching.

1. Prepare the computer for disassembly ([Preparation for disassembly on page 44](#)).
2. Remove the access panel ([Access panel on page 45](#)).
3. Loosen the four silver captive Torx T15 screws that secure the heat sink to the system board.

⚠ CAUTION: Remove fan sink retaining screws in diagonally opposite pairs (as in an X) to even the downward forces on the processor. The pins on the socket are very fragile and any damage to them may require replacing the system board.



4. Disconnect the fan cable from the system board connector labeled CPUFAN **(1)**, and then lift the fan sink from atop the processor **(2)**.

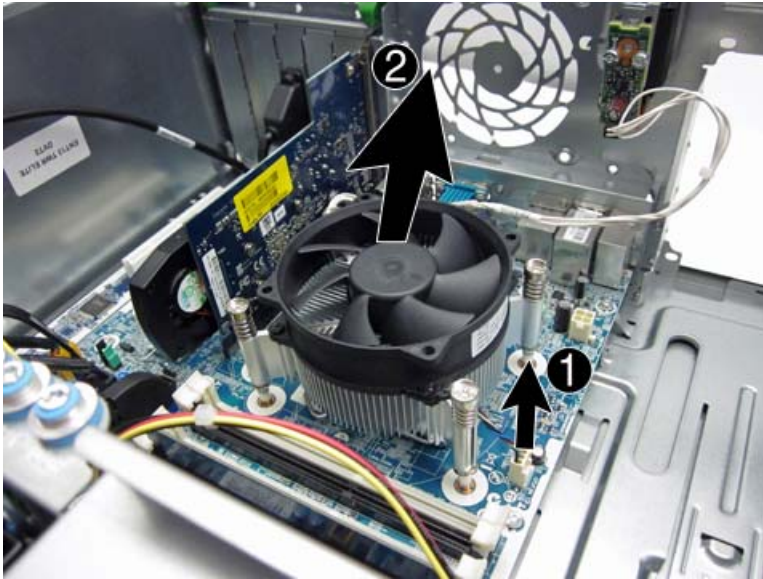

⚠ CAUTION: Fan sink retaining screws should be tightened in diagonally opposite pairs (as in an X) to evenly seat the heat sink on the processor. This is especially important as the pins on the socket are very fragile and any damage to them may require replacing the system board.

Processor

Description	Spare part number
Intel Core i7 processor	
4770, 3.4 GHz, 8-MB L3 cache, 86W	727373-001
Intel Core i5 processors	
4670, 3.4 GHz, 6-MB L3 cache, 86W	727381-001
4570, 3.2 GHz, 6-MB L3 cache, 86W	727380-001

1. Prepare the computer for disassembly ([Preparation for disassembly on page 44](#)).
2. Remove the access panel ([Access panel on page 45](#)).
3. Remove the fan sink ([Fan sink on page 79](#)).
4. Rotate the locking lever to its full open position **(1)**.
5. Raise and rotate the microprocessor retainer to its fully open position **(2)**.
6. Carefully lift the processor from the socket **(3)**.

⚠ CAUTION: Do NOT handle the pins in the processor socket. These pins are very fragile and handling them could cause irreparable damage. Once pins are damaged it may be necessary to replace the system board.

The heat sink must be installed within 24 hours of installing the processor to prevent damage to the processor's solder connections.

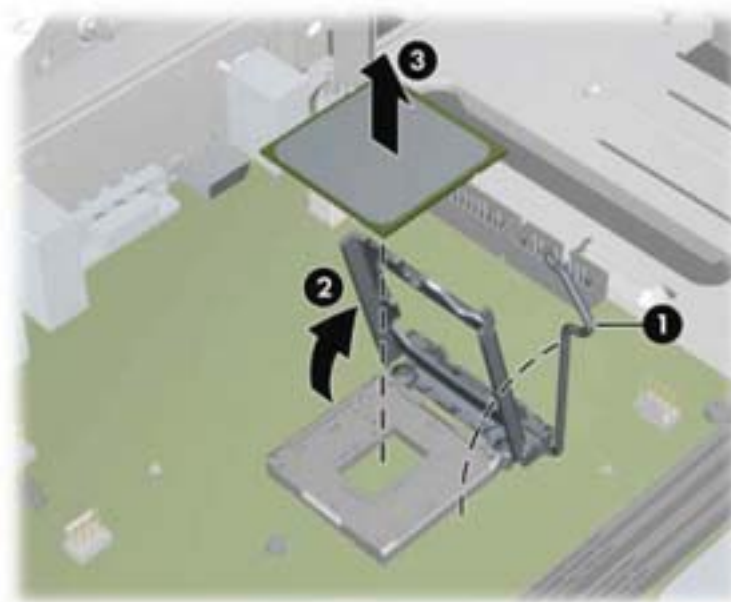



NOTE: After installing a new processor onto the system board, always update the system ROM to ensure that the latest version of the BIOS is being used on the computer. The latest system BIOS can be found on the Web at: <http://www8.hp.com/us/en/support-drivers.html>.

Speaker

Description	Spare part number
Speaker	645330-001

1. Prepare the computer for disassembly ([Preparation for disassembly on page 44](#)).
2. Remove the access panel ([Access panel on page 45](#)).
3. Disconnect the speaker wire from the system board connector labeled SPKR **(1)**.
4. From the inside of the chassis, remove the Torx T15 screw **(2)** that secures the speaker to the front of the chassis.
5. Rotate the top of the speaker downward **(3)**, and then remove it from the chassis.

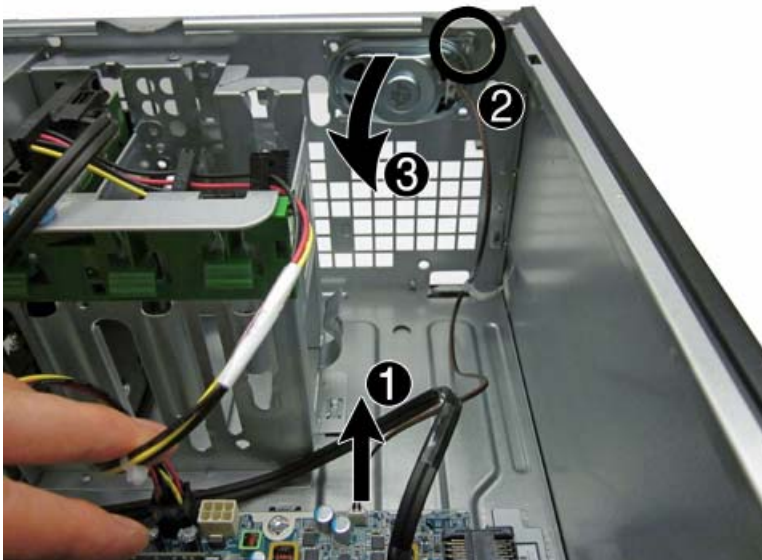

To replace the speaker, reverse the removal procedures.

Smart Cover Lock (solenoid lock)

Description	Spare part number
Solenoid lock	641498-001

 **NOTE:** The Smart Cover Lock is an optional feature included on some models only.

The Smart Cover Lock is a software-controllable cover lock, controlled by the setup password. This lock prevents unauthorized access to the internal components. The computer ships with the Smart Cover Lock in the unlocked position.

If you enable the Smart Cover Lock and cannot enter your password to disable the lock, you will need a Smart Cover FailSafe Key to open the computer cover. You will need the key to access the internal computer components in any of the following circumstances:

- Power outage
- Startup failure
- PC component (for example, processor or power supply) failure
- Forgotten password

 **NOTE:** The Smart Cover FailSafe Key is a specialized tool available from HP. Be prepared; order this key before you need it.

To obtain a FailSafe Key:

- Contact an authorized HP reseller or service provider. Order PN 166527-001 for the wrench-style key or PN 166527-002 for the screwdriver bit key.
 - Refer to the HP Web site (<http://www.hp.com>) for ordering information.
 - Call the appropriate number listed in the warranty.
1. Prepare the computer for disassembly ([Preparation for disassembly on page 44](#)).
 2. Remove the access panel ([Access panel on page 45](#)).

3. From the outside, rear side of the chassis, use the Smart Cover FailSafe Key to remove the tamper-proof screw(s) that secure the Smart Cover Lock to the chassis.

⚠ CAUTION: After you remove the screws, the lock may fall into the computer. Hold the lock while removing the screws to avoid damaging the lock or internal components.

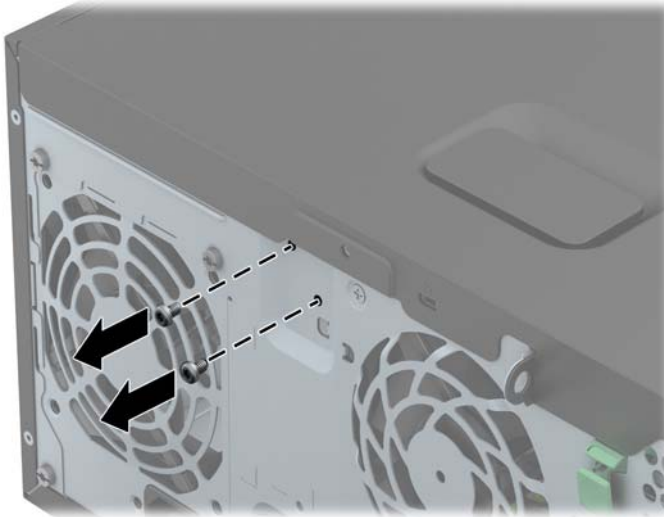

4. From the inside of the chassis, disconnect the cable **(1)** from the system board connector labeled HLOCK.
5. Remove the solenoid lock from the chassis **(2)**.

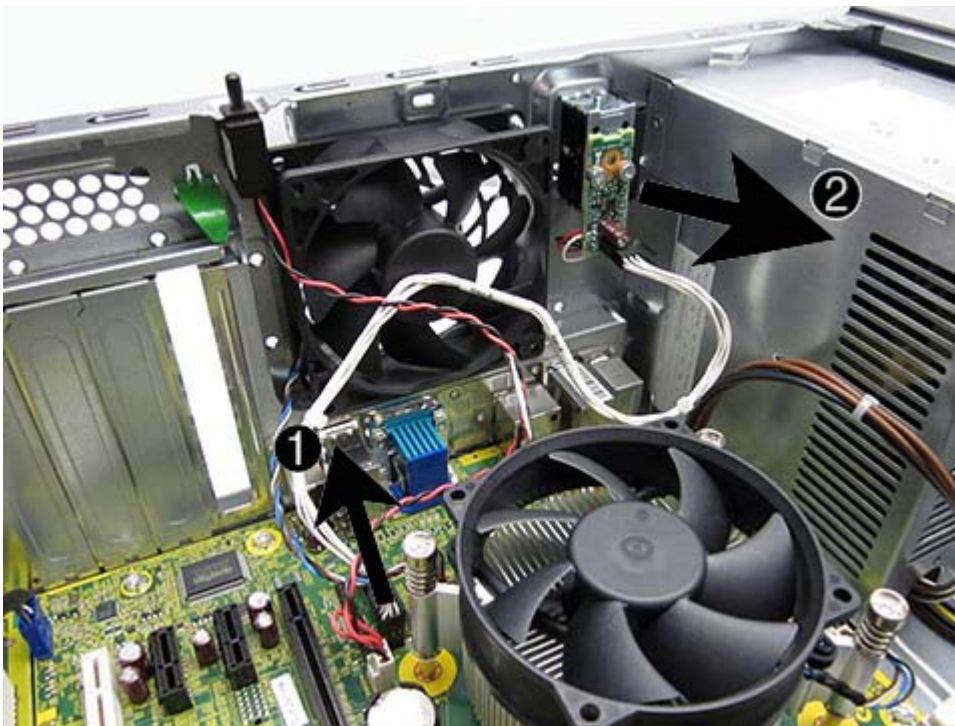

To install the solenoid lock, reverse the removal procedure.

Place the lock up against the tab at the top of the installation location on the rear of the chassis. From the outside of the chassis, line up the screw holes and install both security screws. Plug the connector into the system board connector.

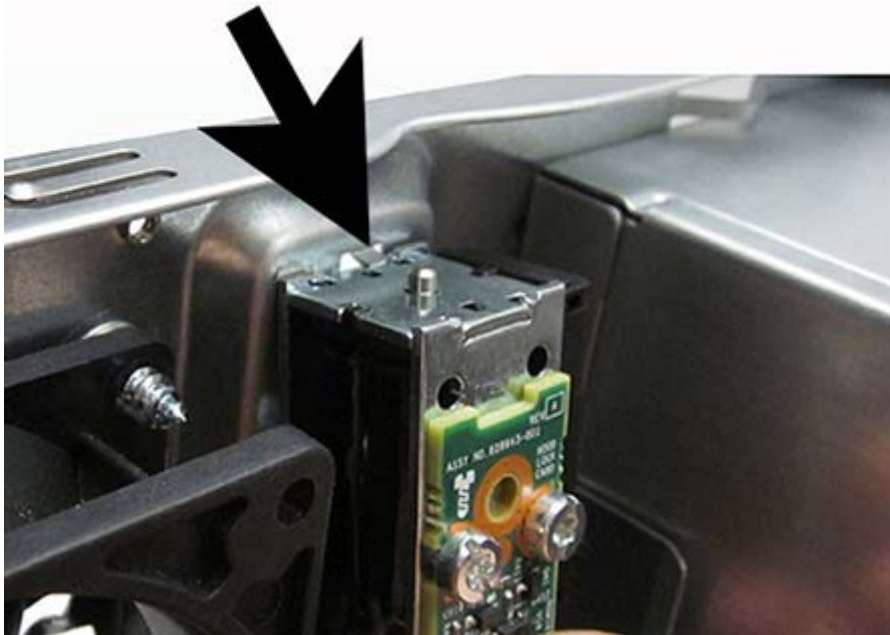

Insert the cable into the clip on the back of the system board USB port. Install the clip if necessary.



 **NOTE:** If both the hood lock and hood sensor are installed, make sure the hood sensor cable is under the hood lock cable in the clip.

Hood sensor

Description	Spare part number
Hood sensor	638816-001

1. Prepare the computer for disassembly ([Preparation for disassembly on page 44](#)).
2. Remove the access panel ([Access panel on page 45](#)).
3. Disconnect the cable from the system board connector labeled HSENSE **(1)**.
4. Using a tool, remove the sensor from the slot by pushing it into the computer to remove it **(2)**.

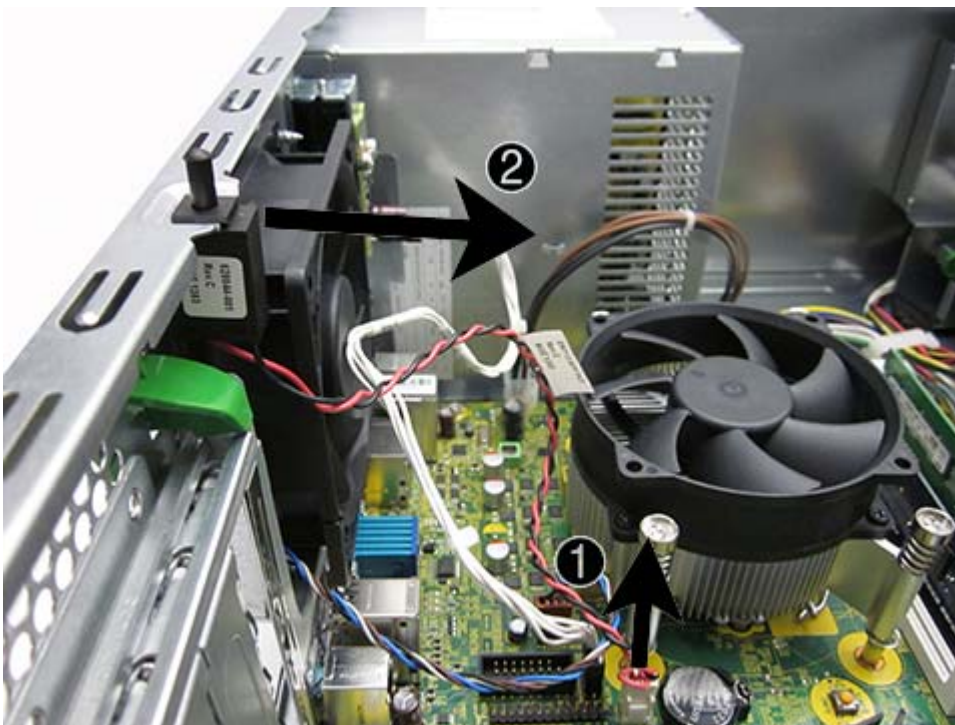

To install the hood sensor, reverse the removal procedure.

Fan

Description	Spare part number
Fan	727135-001

1. Prepare the computer for disassembly ([Preparation for disassembly on page 44](#)).
2. Remove the access panel ([Access panel on page 45](#)).
3. From the outside, rear side of the chassis, remove the three silver Phillips screws that secure the fan to the chassis.



4. From the inside of the chassis, disconnect the fan control cable **(1)** from the system board connector labeled CHFAN2.

5. Lift the fan out of the chassis (2).

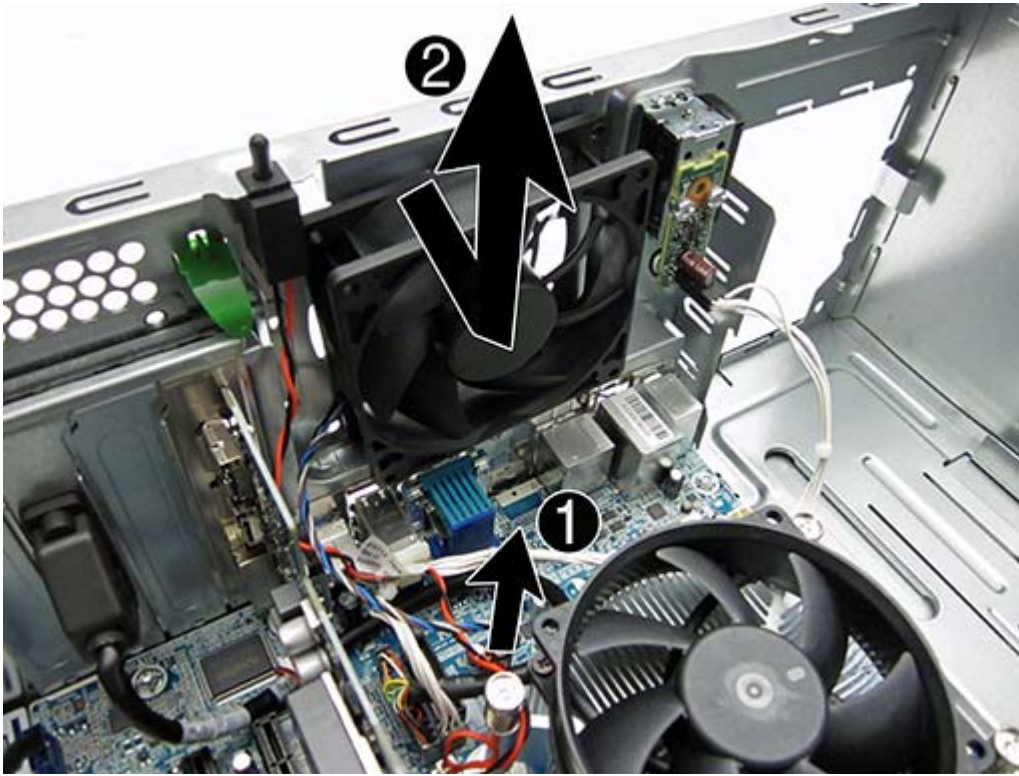

To install the fan, reverse the removal procedure. Be sure to orient the air flow out of the computer.

Power supply

Description	Spare part number
Power supply, 320W, 92% efficient	702452-001
Power supply, 320W, 90% efficient	702453-001
Power supply, 320W	702454-001
Power supply, HV, 320W	707906-001

1. Prepare the computer for disassembly ([Preparation for disassembly on page 44](#)).
2. Remove the access panel ([Access panel on page 45](#)).
3. Disconnect the power cables from the following system board connectors:
 - PWR
 - PWRCPU
 - PWRCMD



4. Remove the power cables from the clip on the base pan.

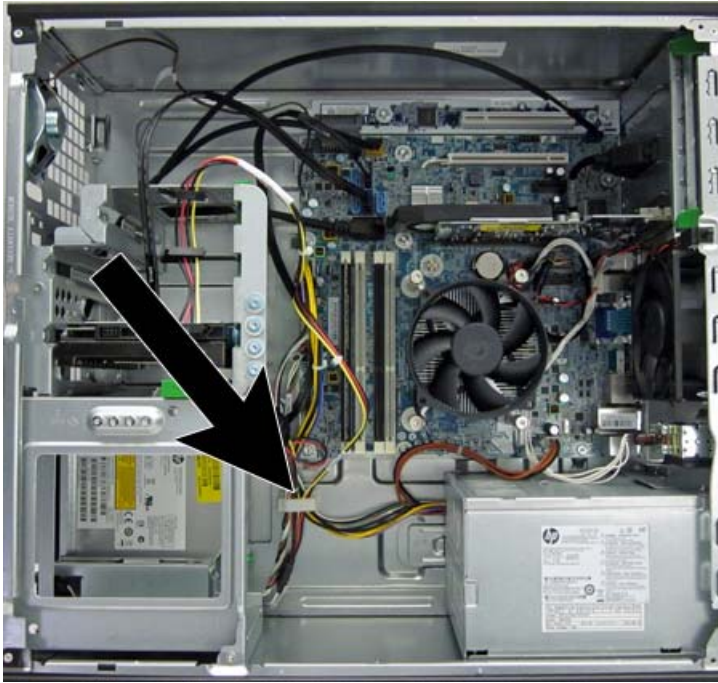

5. From the outside, rear of the chassis, remove the four silver Torx T15 screws that connect the power supply to the chassis.



6. Press the tab **(1)** on the base pan in front of the power supply that holds it in place.

7. Slide the power supply toward the front of the computer **(2)**, rotate slightly into the computer so the power supply clears the lip on the top of the chassis, and then lift the power supply out of the chassis **(3)**.

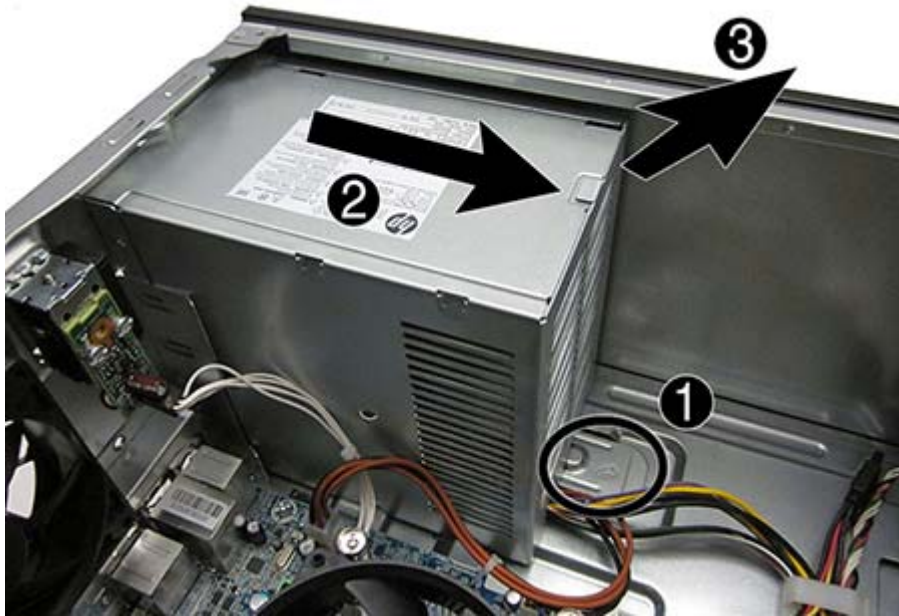

To install the power supply, reverse the removal procedure.

System board and PCI expansion slot daughter card



NOTE: All system board spare part kits include replacement thermal material.

Description	Spare part number
System board for use in models without Windows 8	696969-001
System board for use in models with Windows 8 Standard	696969-501
System board for use in models with Windows 8 Professional	696969-601
System board for use in models with NetClone	727720-001
HP PCI expansion slot daughter card	696971-001

1. Prepare the computer for disassembly ([Preparation for disassembly on page 44](#)).
2. Remove the access panel ([Access panel on page 45](#)).
3. When replacing the system board, make sure the following components are removed from the defective system board and installed on the replacement system board:
 - Memory modules ([Memory on page 50](#))
 - Expansion cards ([Expansion cards on page 53](#))
 - Fan sink ([Fan sink on page 79](#)).
 - Processor ([Processor on page 81](#))
4. Disconnect all cables connected to the system board, noting their location for reinstallation.
5. If a PCI expansion slot daughter card is installed, remove the two Torx T15 screws **(1)** that secure the PCI extension board to the chassis.

- Slide the board toward the side of the chassis to disengage it from the system board connector, and then lift the extension board from the chassis (2).

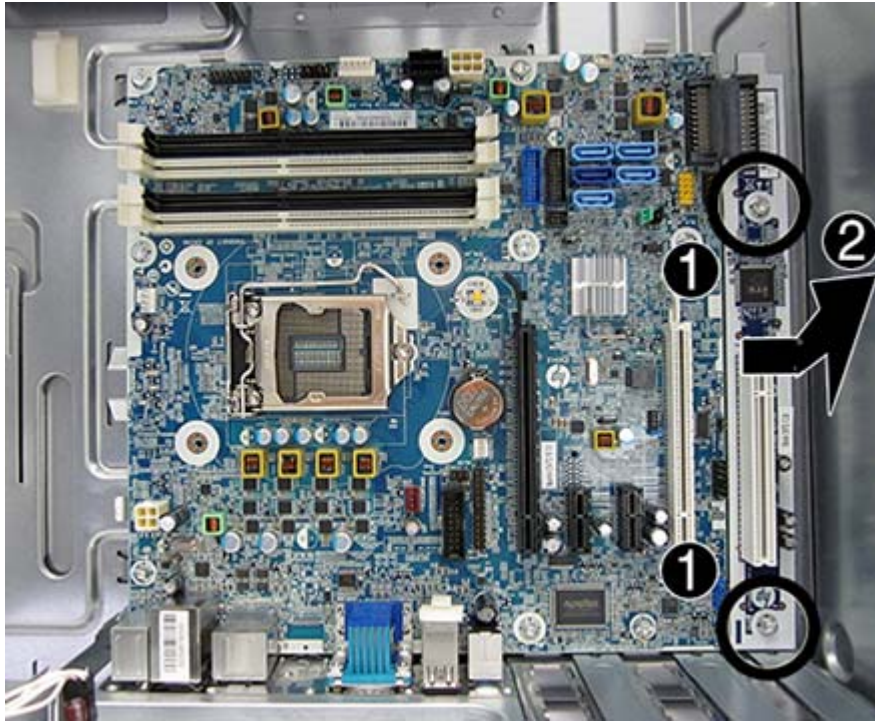

- Remove the eight Torx T15 screws (1) that secure the system board to the chassis.
- Slide the system board toward the front of the computer to disengage the I/O panel, and then lift the system board out of the computer (2).

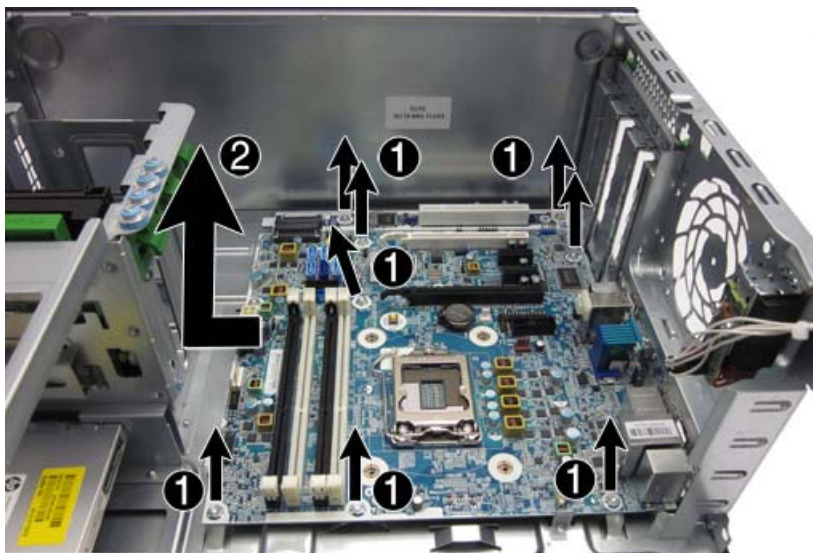

When reinstalling the system board, first insert the I/O panel back into the slots in the rear of the chassis, and then align the board with the chassis screw holes.

 **NOTE:** When replacing the system board, you must change the chassis serial number in the BIOS.

6 Removal and replacement procedures: Small Form Factor (SFF)

Adherence to the procedures and precautions described in this chapter is essential for proper service. After completing all necessary removal and replacement procedures, run the Diagnostics utility to verify that all components operate properly.

 **NOTE:** Not all features listed in this guide are available on all computers.

Preparation for disassembly

See [Routine care, SATA drive guidelines, and disassembly preparation on page 35](#) for initial safety procedures.

1. Remove/disengage any security devices that prohibit opening the computer.
2. Remove all removable media, such as compact discs or USB flash drives, from the computer.
3. Turn off the computer properly through the operating system, then turn off any external devices.
4. Disconnect the power cord from the power outlet and disconnect any external devices.

 **CAUTION:** Turn off the computer before disconnecting any cables.

Regardless of the power-on state, voltage is always present on the system board as long as the system is plugged into an active AC outlet. In some systems the cooling fan is on even when the computer is in the “Standby,” or “Suspend” modes. The power cord should always be disconnected before servicing a unit.

5. If the computer is on a stand, remove the computer from the stand and lay the computer down.

 **NOTE:** During disassembly, label each cable as you remove it, noting its position and routing. Keep all screws with the units removed.

Access panel

Description	Spare part number
Access panel	732760-001

1. Prepare the computer for disassembly ([Preparation for disassembly on page 94](#)).
2. Lift up on the access panel handle (1) then lift the access panel off the computer (2).

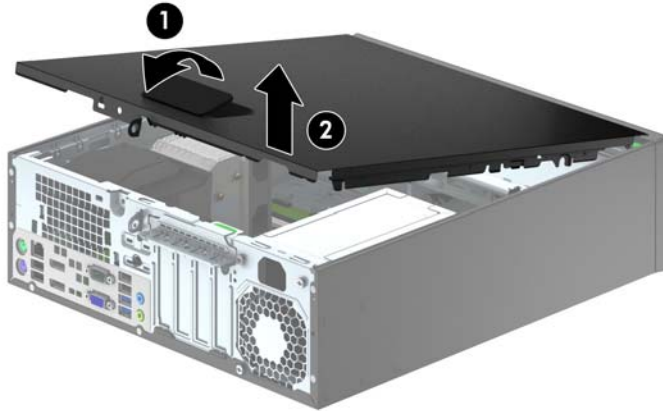

To install the access panel, reverse the removal procedure.

Front bezel

Description	Spare part number
Front bezel	732757-001
Optical drive bezel blank	732769-001

1. Prepare the computer for disassembly ([Preparation for disassembly on page 94](#)).
2. Remove the access panel ([Access panel on page 95](#)).
3. Lift up the three tabs on the side of the bezel (1), then rotate the bezel off the chassis (2).

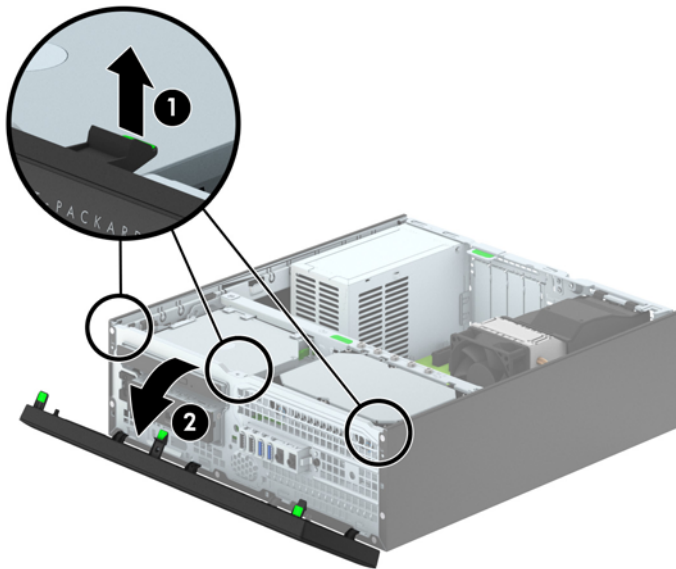

To install the front bezel, reverse the removal procedure.

Front bezel security

The front bezel can be locked in place by installing a security screw provided by HP. To install the security screw:

1. Prepare the computer for disassembly ([Preparation for disassembly on page 94](#)).
2. If the computer is on a stand, remove the computer from the stand.
3. Remove the access panel ([Access panel on page 95](#)).
4. Remove the front bezel ([Front bezel on page 96](#)).
5. Remove one of the five silver 6-32 standard screws located on top of the drive cage.

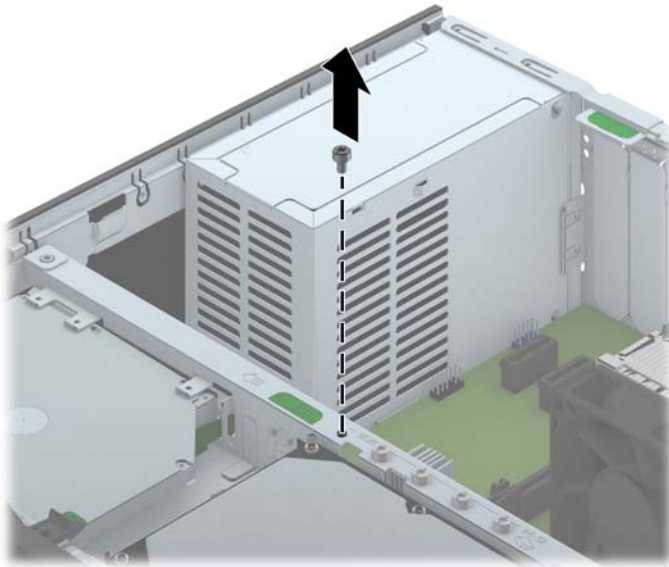

6. Install the security screw through the middle front bezel release tab to secure the front bezel in place.

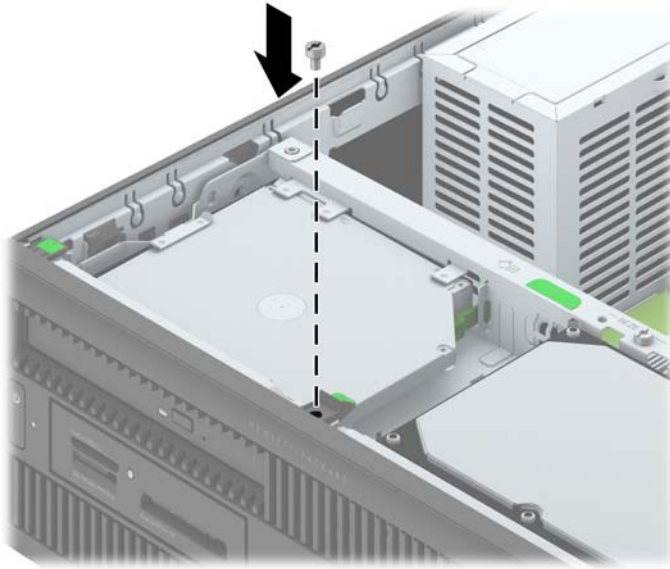

Bezel blanks

On some models, there are bezel blanks covering the 3.5-inch and 5.25-inch external drive bays that need to be removed before installing a drive. To remove a bezel blank:

1. Remove the access panel ([Access panel on page 95](#)).
2. Remove the front bezel ([Front bezel on page 96](#)).
3. To remove a 3.5-inch bezel blank, press inward on the five retaining tabs (1) and pull the blank off the front bezel (2).

To remove a slim optical drive bezel blank, press the two retaining tabs that hold the bezel blank in place towards the outer right edge of the bezel (3) and slide the bezel blank back and to the right to remove it (4).

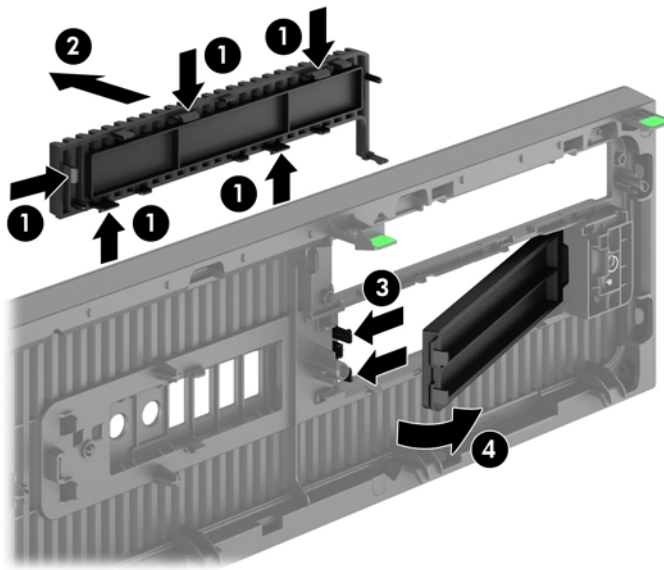

4. Replace the front bezel.

 **NOTE:** After removing the slim optical drive bezel blank and installing a slim optical drive, you can install an optional bezel trim piece (available from HP) that surrounds the front of the slim optical drive.

Memory

Description	Spare part number
8-GB, PC3-12800	689375-001
4-GB, PC3-12800	671613-001
2-GB, PC3-12800	671612-001

The computer comes with double data rate 3 synchronous dynamic random access memory (DDR3-SDRAM) dual inline memory modules (DIMMs).

DIMMs

The memory sockets on the system board can be populated with up to four industry-standard DIMMs. These memory sockets are populated with at least one preinstalled DIMM. To achieve the maximum memory support, you can populate the system board with up to 32-GB of memory configured in a high-performing dual channel mode.

DDR3-SDRAM DIMMs

For proper system operation, the DDR3-SDRAM DIMMs must be:

- industry-standard 240-pin
- unbuffered non-ECC PC3-12800 DDR3-1600 MHz-compliant
- 1.35 volt or 1.5 volt DDR3/DDR3L-SDRAM DIMMs

The DDR3-SDRAM DIMMs must also:

- support CAS latency 11 DDR3 1600 MHz (11-11-11 timing)
- contain the mandatory JEDEC SPD information

In addition, the computer supports:

- 512-Mbit, 1-Gbit, and 2-Gbit non-ECC memory technologies
- single-sided and double-sided DIMMs
- DIMMs constructed with x8 and x16 DDR devices; DIMMs constructed with x4 SDRAM are not supported



NOTE: The system will not operate properly if you install unsupported DIMMs.

Populating DIMM sockets

There are four DIMM sockets on the system board, with two sockets per channel. The sockets are labeled DIMM1, DIMM2, DIMM3, and DIMM4. Sockets DIMM1 and DIMM2 operate in memory channel B. Sockets DIMM3 and DIMM4 operate in memory channel A.

The system will automatically operate in single channel mode, dual channel mode, or flex mode, depending on how the DIMMs are installed.

 **NOTE:** Single channel and unbalanced dual channel memory configurations will result in inferior graphics performance.

- The system will operate in single channel mode if the DIMM sockets are populated in one channel only.
- The system will operate in a higher-performing dual channel mode if the total memory capacity of the DIMMs in Channel A is equal to the total memory capacity of the DIMMs in Channel B. The technology and device width can vary between the channels. For example, if Channel A is populated with two 1-GB DIMMs and Channel B is populated with one 2-GB DIMM, the system will operate in dual channel mode.
- The system will operate in flex mode if the total memory capacity of the DIMMs in Channel A is not equal to the total memory capacity of the DIMMs in Channel B. In flex mode, the channel populated with the least amount of memory describes the total amount of memory assigned to dual channel and the remainder is assigned to single channel. For optimal speed, the channels should be balanced so that the largest amount of memory is spread between the two channels. If one channel will have more memory than the other, the larger amount should be assigned to Channel A. For example, if you are populating the sockets with one 2-GB DIMM, and three 1-GB DIMMs, Channel A should be populated with the 2-GB DIMM and one 1-GB DIMM, and Channel B should be populated with the other two 1-GB DIMMs. With this configuration, 4-GB will run as dual channel and 1-GB will run as single channel.
- In any mode, the maximum operational speed is determined by the slowest DIMM in the system.

Installing DIMMs

 **CAUTION:** You must disconnect the power cord and wait approximately 30 seconds for the power to drain before adding or removing memory modules. Regardless of the power-on state, voltage is always supplied to the memory modules as long as the computer is plugged into an active AC outlet. Adding or removing memory modules while voltage is present may cause irreparable damage to the memory modules or system board.

The memory module sockets have gold-plated metal contacts. When upgrading the memory, it is important to use memory modules with gold-plated metal contacts to prevent corrosion and/or oxidation resulting from having incompatible metals in contact with each other.

Static electricity can damage the electronic components of the computer or optional cards. Before beginning these procedures, ensure that you are discharged of static electricity by briefly touching a grounded metal object.

When handling a memory module, be careful not to touch any of the contacts. Doing so may damage the module.

1. Prepare the computer for disassembly ([Preparation for disassembly on page 94](#)).
2. Remove the access panel ([Access panel on page 95](#)).
3. Rotate up the internal drive bay housing to access the memory module sockets on the system board.

4. Open both latches of the memory module socket **(1)**, and insert the memory module into the socket **(2)**.

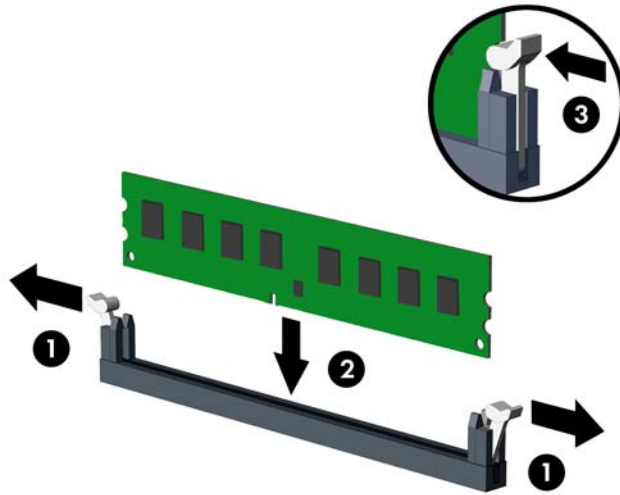

 **NOTE:** A memory module can be installed in only one way. Match the notch on the module with the tab on the memory socket.

Populate the black DIMM sockets before the white DIMM sockets.

For maximum performance, populate the sockets so that the memory capacity is spread as equally as possible between Channel A and Channel B. Refer to [Populating DIMM sockets on page 100](#) for more information.

5. Push the module down into the socket, ensuring that the module is fully inserted and properly seated. Make sure the latches are in the closed position **(3)**.
6. Repeat steps 4 and 5 to install any additional modules.

The computer should automatically recognize the additional memory the next time you turn on the computer.

Expansion card

Description	Spare part number
nVidia Quadro NVS310 PCIe x16 graphics card, 512 MB	707252-001
nVidia Quadro NVS315 PCIe x16 graphics card, 1 GB	720837-001
AMD Radeon HD8490 PCIe x16 graphics card, 1 GB	717219-001
AMD Radeon HD8450 PCIe x16 graphics card, 1 GB	717220-001
HP WLAN 802.11 a/b/g/n 2x2 PCIe module	695915-001
Intel PRO/1000 single port GbE NIC, includes bracket	728562-001

The computer has two PCI Express x1 expansion slots, one PCI Express x16 expansion slot, and one PCI Express x16 expansion slot that is downshifted to a x4 slot.

 **NOTE:** The PCI Express slots support only low profile cards.

You can install a PCI Express x1, x4, x8, or x16 expansion card in the PCI Express x16 slot.

For dual graphics card configurations, the first (primary) card must be installed in the PCI Express x16 slot that is NOT downshifted to a x4.

To remove, replace, or add an expansion card:

1. Prepare the computer for disassembly ([Preparation for disassembly on page 94](#)).
2. If the computer is on a stand, remove the computer from the stand.
3. Remove the access panel ([Access panel on page 95](#)).
4. Locate the correct vacant expansion socket on the system board and the corresponding expansion slot on the back of the computer chassis.

5. Release the slot cover retention latch that secures the slot covers by lifting the green tab on the latch and rotating the latch to the open position.

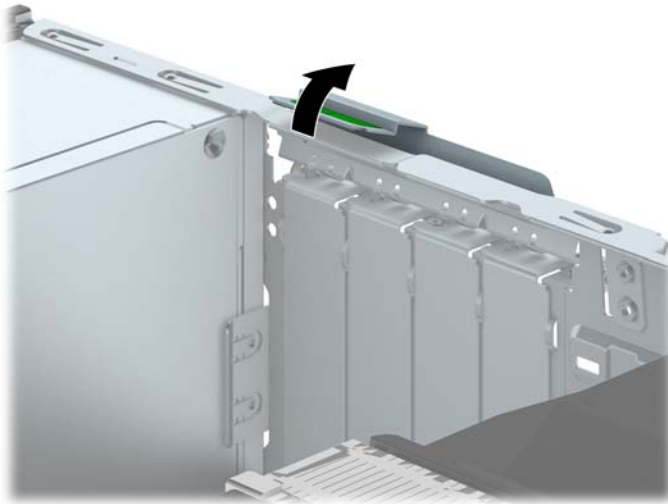

6. Before installing an expansion card, remove the expansion slot cover or the existing expansion card.

 **NOTE:** Before removing an installed expansion card, disconnect any cables that may be attached to the expansion card.

- a. If you are installing an expansion card in a vacant socket, remove the appropriate expansion slot cover on the back of the chassis. Pull the slot cover straight up then away from the inside of the chassis.

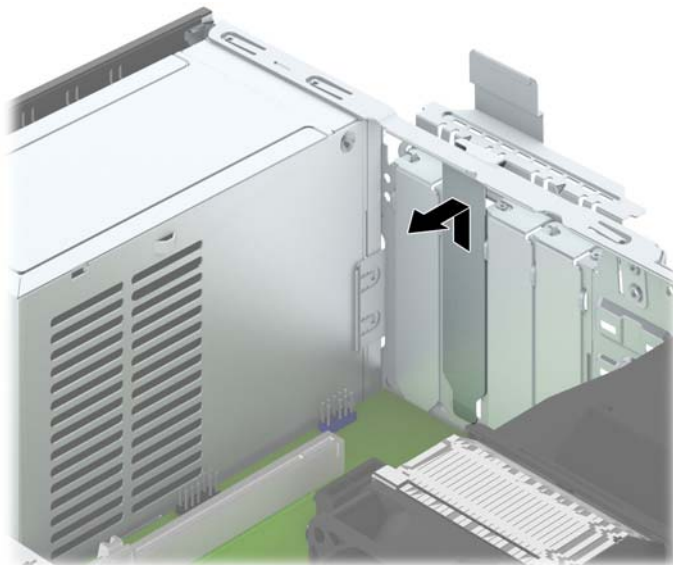

- b.** If you are removing a PCI Express x1 card, hold the card at each end, and carefully rock it back and forth until the connectors pull free from the socket. Pull the expansion card straight up from the socket (1) then away from the inside of the chassis to release it from the chassis frame (2). Be sure not to scrape the card against the other components.

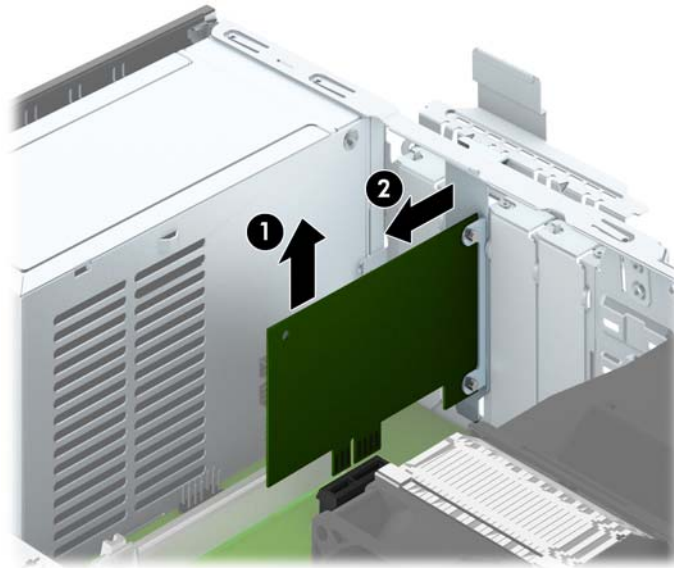

- c.** If you are removing a PCI Express x16 card, pull the retention arm on the back of the expansion socket away from the card and carefully rock the card back and forth until the connectors pull free from the socket. Pull the expansion card straight up from the socket then away from the inside of the chassis to release it from the chassis frame. Be sure not to scrape the card against the other components.

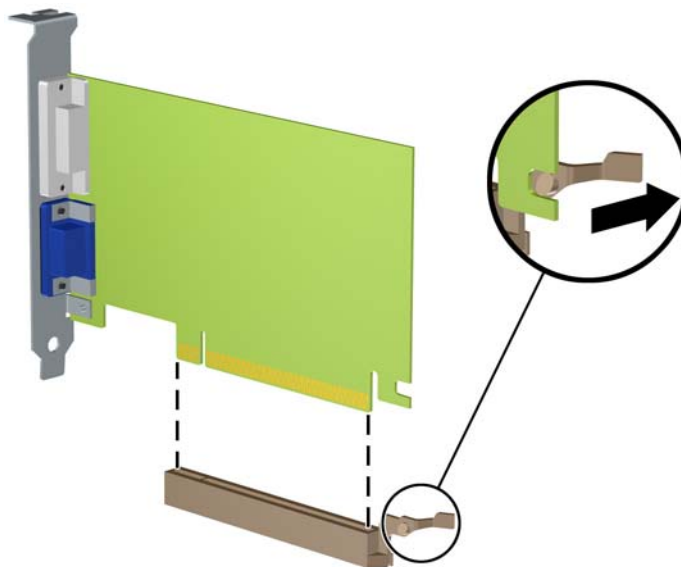

- 7.** Store the removed card in anti-static packaging.

8. If you are not installing a new expansion card, install an expansion slot cover to close the open slot.

⚠ CAUTION: After removing an expansion card, you must replace it with a new card or expansion slot cover for proper cooling of internal components during operation.

9. To install a new expansion card, hold the card just above the expansion socket on the system board then move the card toward the rear of the chassis (1) so that the bracket on the card is aligned with the open slot on the rear of the chassis. Press the card straight down into the expansion socket on the system board (2).

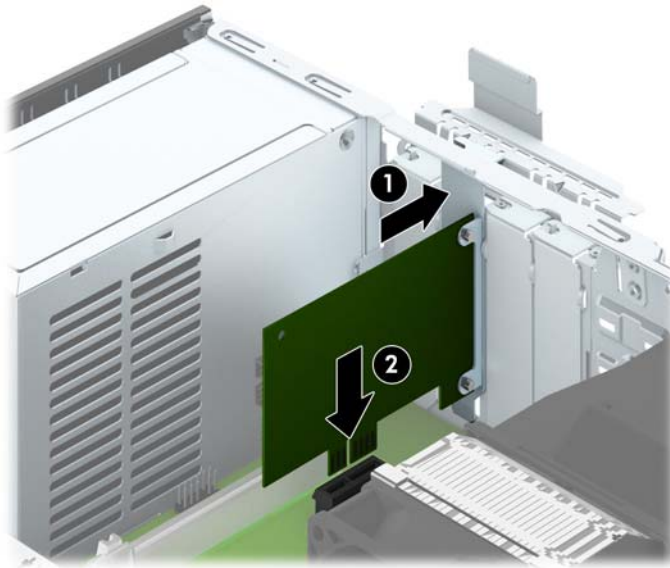

📝 NOTE: When installing an expansion card, press firmly on the card so that the whole connector seats properly in the expansion card slot.

10. Rotate the slot cover retention latch back in place to secure the expansion card.

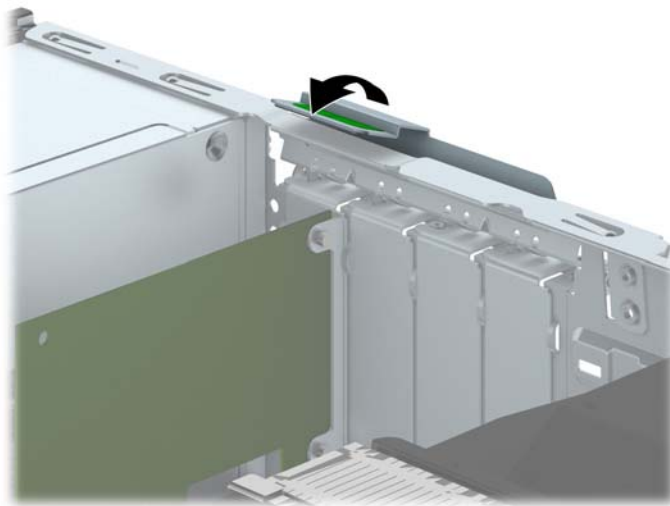

11. Connect external cables to the installed card, if needed. Connect internal cables to the system board, if needed.
12. Reconfigure the computer, if necessary.

System board connections

Refer to the following illustration and table to identify the system board connectors for your model.

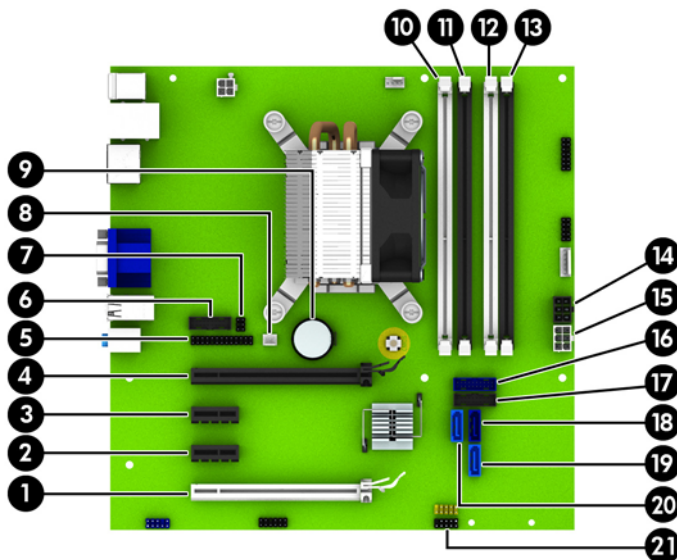

No.	System Board Connector	System Board Label	Color	Component
1	PCI Express x16 downshifted to a x4	X4PCIEXP	white	Expansion Card
2	PCI Express x1	X1PCIEXP2	black	Expansion Card
3	PCI Express x1	X1PCIEXP1	black	Expansion Card
4	PCI Express x16	X16PCIEXP	black	Expansion Card
5	Parallel Port	PAR	black	Parallel Port
6	Serial Port	COMB	black	Serial Port
7	Hood Lock	HLCK	black	Hood Lock
8	Hood Sensor	HSENSE	white	Hood Sensor
9	Battery	BAT	black	Battery
10	DIMM4 (Channel A)	DIMM4	white	Memory Module
11	DIMM3 (Channel A)	DIMM3	black	Memory Module
12	DIMM2 (Channel B)	DIMM2	white	Memory Module
13	DIMM1 (Channel B)	DIMM1	black	Memory Module
14	Power	SATAPWR0	black	SATA Drives

No.	System Board Connector	System Board Label	Color	Component
15	Power	PWR	white	System Board
16	USB 3.0	FRONT USB3.0	blue	Front USB 3.0 Ports
17	USB 3.0	MEDIA3.0	black	USB 3.0 Device, such as a USB 3.0 Media Card Reader
18	SATA 3.0	SATA0	dark blue	Primary Hard Drive
19	SATA 3.0	SATA1	light blue	Any SATA Device other than the Primary Hard Drive
20	SATA 3.0	SATA2	light blue	Any SATA Device other than the Primary Hard Drive
21	USB 2.0	MEDIA	black	USB 2.0 Device, such as a USB 2.0 Media Card Reader

Drives

Description	Spare part number
Optical drives	
DVD±RW drive	657958-001
DVD-ROM drive	608394-001
Blu-ray BD-RW SuperMulti XL Drive	719157-001
Hard drives	
2 TB, 7200 rpm hard drive	616608-001
1 TB hard drive, hybrid SSD	724937-001
1 TB, 10000 rpm hard drive	719106-001
1 TB, 7200 rpm hard drive	613202-001
750 GB, 7200 rpm, 2.5-inch hard drive, hybrid SSD	719105-001
500 GB, 10000 rpm hard drive	683923-001
500 GB, 7200 rpm hard drive, self-encrypting (SED)	696442-001
500 GB hard drive, hybrid SSD	724938-001
256 GB Solid State Drive (SSD), self-encrypting (SED)	680020-001
128 GB Solid State Drive (SSD)	665961-001
32 GB mSATA drive	686616-001

When installing drives, follow these guidelines:

- The primary Serial ATA (SATA) hard drive must be connected to the dark blue primary SATA connector on the system board labeled SATA0.
- Connect secondary hard drives and optical drives to one of the light blue SATA connectors on the system board (labeled SATA1 and SATA2).
- Connect a media card reader USB 3.0 cable to the USB connector on the system board labeled MEDIA3.0.
- The power cable for the drives has two branches coming off the system board connector. The first branch is a dual-headed cable with the first connector (four-wire) routed to the 3.5-inch optional drive bay and the second connector (two-wire) routed to the slim optical drive bay. The second branch is a dual-headed cable with the first connector routed to the 3.5-inch hard drive bay and the second connector routed to the 2.5-inch hard drive bay.
- You must install guide screws to ensure the drive will line up correctly in the drive cage and lock in place. HP has provided four extra 6-32 standard guide screws installed on the top of the drive bay. The 6-32 standard guide screws are required for a media card reader or a secondary hard drive installed in the 3.5-inch optional drive bay. M3 isolation mounting guide screws for 2.5-inch hard drives are not provided. If you are replacing a drive, remove the guide screws from the old drive and install them in the new drive.



There are a total of five extra silver 6-32 standard screws. One is used for bezel security (1) (see [Front bezel security on page 97](#) for more information). The other four are used as guide screws for a media card reader or a secondary hard drive in the 3.5-inch optional drive bay (2).

CAUTION: To prevent loss of work and damage to the computer or drive:

If you are inserting or removing a drive, shut down the operating system properly, turn off the computer, and unplug the power cord. Do not remove a drive while the computer is on or in standby mode.

Before handling a drive, ensure that you are discharged of static electricity. While handling a drive, avoid touching the connector.

Handle a drive carefully; do not drop it.

Do not use excessive force when inserting a drive.

Avoid exposing a hard drive to liquids, temperature extremes, or products that have magnetic fields such as monitors or speakers.

If a drive must be mailed, place the drive in a bubble-pack mailer or other protective packaging and label the package "Fragile: Handle With Care."

Drive positions

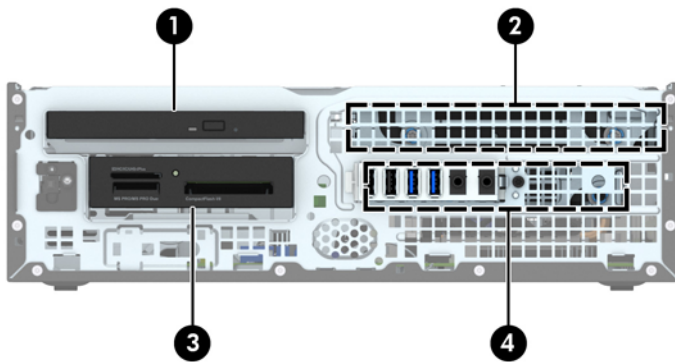

-
- | | |
|---|--|
| 1 | Slim optical drive bay |
| 2 | 3.5-inch internal hard drive bay |
| 3 | 3.5-inch drive bay for optional drives (media card reader shown) |
| 4 | 2.5-inch internal hard drive bay |
-

NOTE: The drive configuration on your computer may be different than the drive configuration shown above.

To verify the type and size of the storage devices installed in the computer, run Computer Setup.

Removing a 3.5-inch device

⚠ CAUTION: All removable media should be taken out of a drive before removing the drive from the computer.

1. Prepare the computer for disassembly ([Preparation for disassembly on page 94](#)).
2. Remove the access panel ([Access panel on page 95](#)).
3. Remove the front bezel ([Front bezel on page 96](#)).
4. Rotate the drive cage to its upright position.
5. Disconnect the drive cables from the rear of the drive, or, if you are removing a media card reader, disconnect the USB cable from the system board as indicated in the following illustration.



6. Press inward on the release lever at the rear of the drive (1) and slide the drive out of the rear of the drive bay (2).

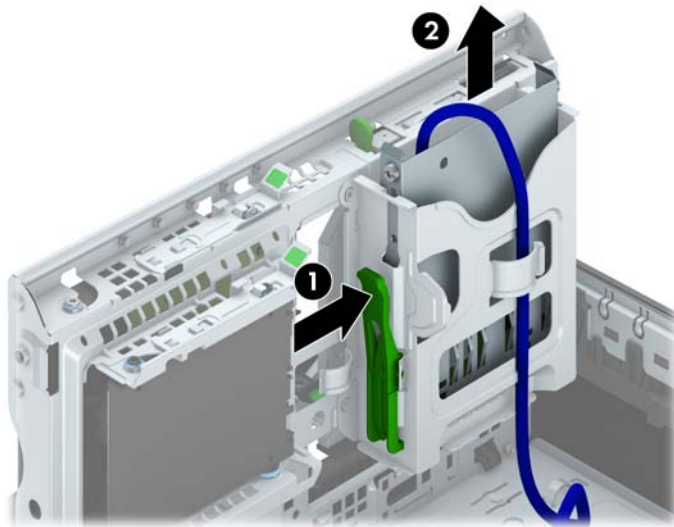

Installing a 3.5-inch device

1. Prepare the computer for disassembly ([Preparation for disassembly on page 94](#)).
2. Remove the access panel ([Access panel on page 95](#)).
3. Remove the front bezel ([Front bezel on page 96](#)). If you are installing a drive in a bay covered by a bezel blank, remove the bezel blank. See [Bezel blanks on page 99](#) for more information.
4. Install 6-32 guide screws in the holes on each side of the drive.

 **NOTE:** HP has supplied four extra 6-32 guide screws on top of the drive cage. Refer to [Drives on page 108](#) for an illustration of the extra guide screws location.

When replacing a drive, transfer the four 6-32 guide screws from the old drive to the new one.

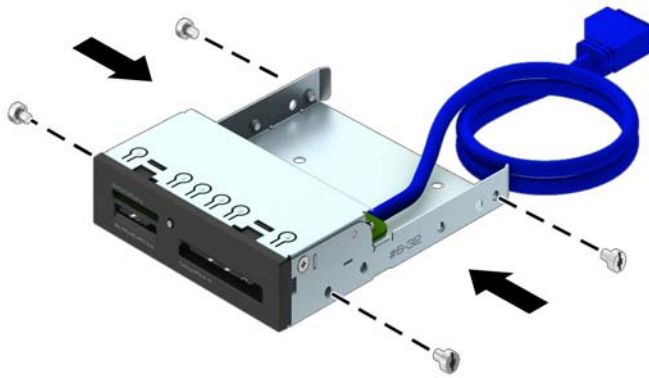

5. Rotate the drive cage to its upright position.
6. Slide the drive into the drive bay, making sure to align the guide screws with the guide slots, until the drive snaps into place.



7. If installing a USB 3.0 media card reader, connect the USB cable from the media card reader to the USB 3.0 connector on the system board labeled MEDIA3.0.



 **NOTE:** Refer to [System board connections on page 107](#) for an illustration of the system board drive connectors.

8. Rotate the drive cage back down to its normal position.

 **CAUTION:** Be careful not to pinch any cables or wires when rotating the drive cage down.

Removing a slim optical drive

CAUTION: All removable media should be taken out of a drive before removing the drive from the computer.

1. Prepare the computer for disassembly ([Preparation for disassembly on page 94](#)).
2. Remove the access panel ([Access panel on page 95](#)).
3. Disconnect the power cable (1) and data cable (2) from the rear of the optical drive, push the green release latch on the right rear side of the drive toward the center of the drive (3), then slide the drive forward and out of the bay through the front bezel (4).

CAUTION: When removing the cables, pull the tab or connector instead of the cable itself to avoid damaging the cable.

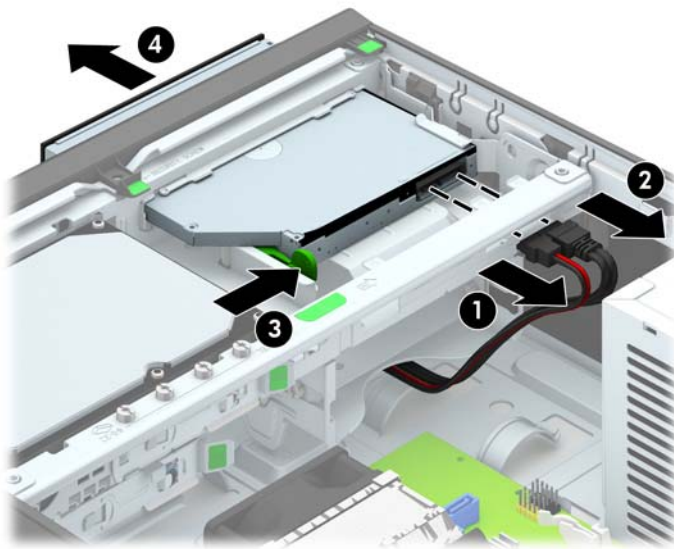

Installing a slim optical drive

1. Prepare the computer for disassembly ([Preparation for disassembly on page 94](#)).
2. If the computer is on a stand, remove the computer from the stand.
3. Remove the access panel ([Access panel on page 95](#)).
4. Remove the front bezel ([Front bezel on page 96](#)) if you are installing a drive in a bay covered by a bezel blank, then remove the bezel blank. See [Bezel blanks on page 99](#) for more information.
5. Before the new optical drive can be used, the release latch must be attached.
 - a. Peel the backing off the adhesive on the release latch.
 - b. Without allowing the release latch to touch the optical drive, carefully align the holes on the release latch with the pins on the side of the optical drive. Make sure the release latch is oriented properly.
 - c. Insert the pin at the front of the optical drive into the hole at the end of the release latch, and press firmly.
 - d. Insert the second pin, and press the entire release latch firmly to fasten the latch securely to the optical drive.

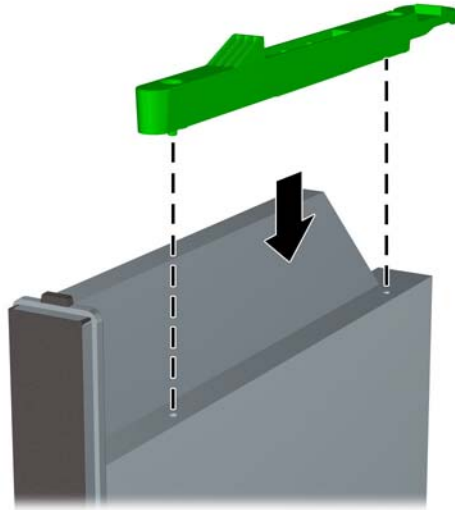

- Slide the optical drive through the front bezel all the way into the bay so that it locks in place (1), then connect the power cable (2) and data cable (3) to the rear of the drive.

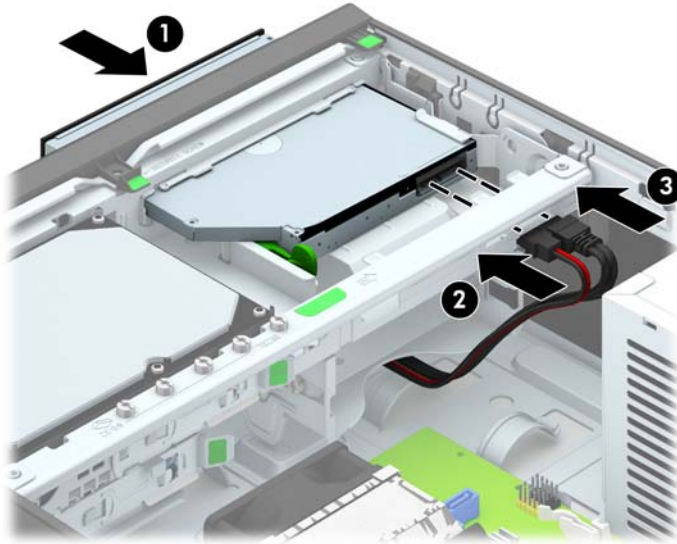

- Connect the opposite end of the data cable to one of the light blue SATA connectors on the system board.

 **NOTE:** Refer to [System board connections on page 107](#) for an illustration of the system board drive connectors.

- Replace the front bezel if it was removed.

 **NOTE:** An optional bezel trim piece that surrounds the front of the optical drive is available from HP. Install the bezel trim piece in the front bezel before installing the front bezel.

Removing and replacing a 3.5-inch hard drive

 **NOTE:** Before you remove the old hard drive, be sure to back up the data from the old hard drive so that you can transfer the data to the new hard drive.

- Prepare the computer for disassembly ([Preparation for disassembly on page 94](#)).
- If the computer is on a stand, remove the computer from the stand.
- Remove the access panel ([Access panel on page 95](#)).
- Disconnect the power cable and data cable from the back of the hard drive.

5. Pull the release lever next to the rear of the hard drive outward (1). While pulling the release lever out, slide the drive back until it stops, then lift the drive up and out of the bay (2).

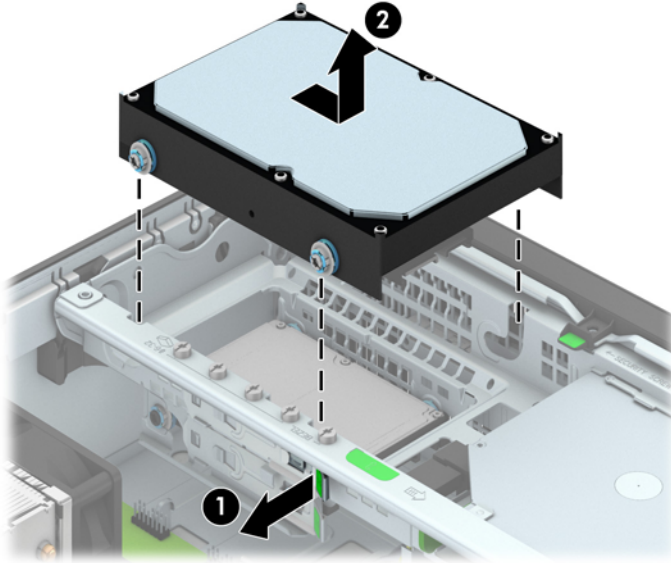

6. To install a hard drive, you must transfer the silver and blue isolation mounting guide screws from the old hard drive to the new hard drive.

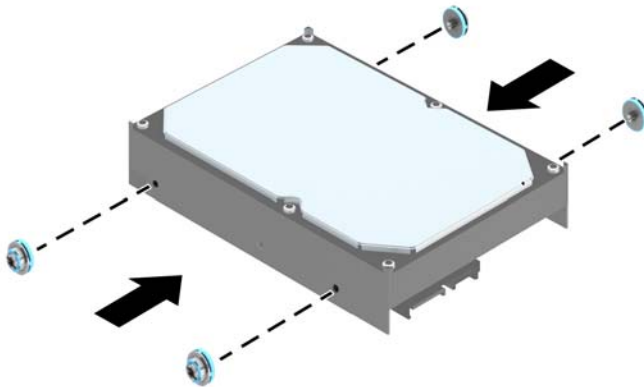

7. Align the guide screws with the slots on the chassis drive cage, press the hard drive down into the bay, then slide it forward until it stops and locks in place.

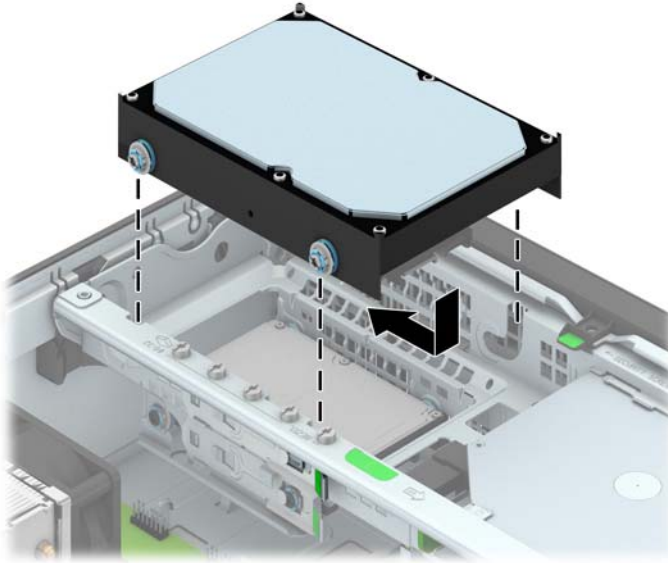

8. Connect the power cable and data cable to the back of the hard drive.

 **NOTE:** The data cable for the primary hard drive must be connected to the dark blue connector labeled SATA0 on the system board to avoid any hard drive performance problems.

9. Replace the access panel.
10. If the computer was on a stand, replace the stand.
11. Reconnect the power cord and turn on the computer.
12. Lock any security devices that were disengaged when the access panel was removed.

Removing a 2.5-inch hard drive

1. Prepare the computer for disassembly ([Preparation for disassembly on page 94](#)).
2. Remove the access panel ([Access panel on page 95](#)).
3. Rotate the drive cage to its upright position.
4. Disconnect the power cable and data cable from the back of the hard drive.
5. Pull outward on the release lever at the rear of the drive (1) then slide the drive back until it stops and pull it down and out of the drive bay (2).

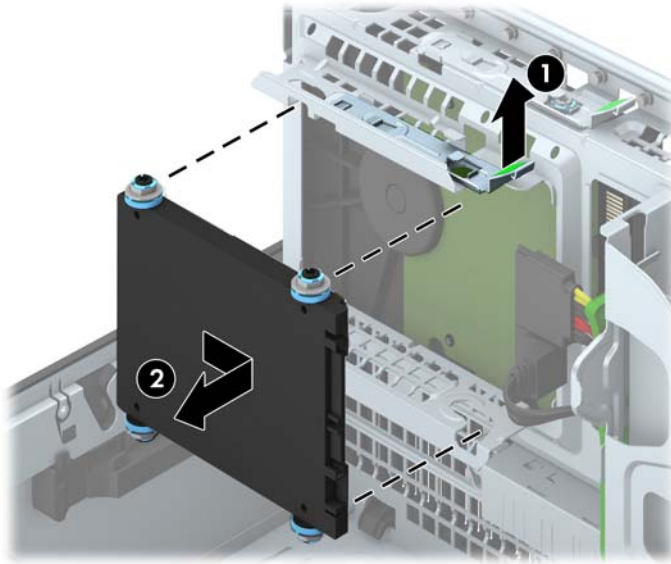

Installing a 2.5-inch hard drive

1. Prepare the computer for disassembly ([Preparation for disassembly on page 94](#)).
2. If the computer is on a stand, remove the computer from the stand.
3. Remove the access panel ([Access panel on page 95](#)).

4. Install four black and blue M3 isolation mounting guide screws (two on each side of the drive).

 **NOTE:** M3 metric isolation mounting guide screws can be purchased from HP.

When replacing a drive, transfer the four M3 isolation mounting guide screws from the old drive to the new one.

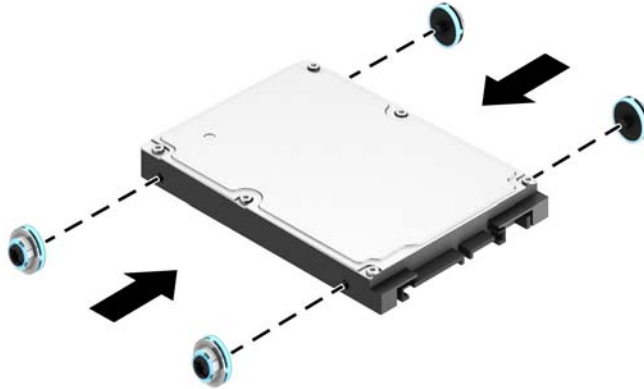

5. Rotate the drive cage to its upright position.
6. Align the guide screws on the drive with the J-slots on the sides of the drive bay. Press the drive up into the drive bay then slide it forward until it locks in place.

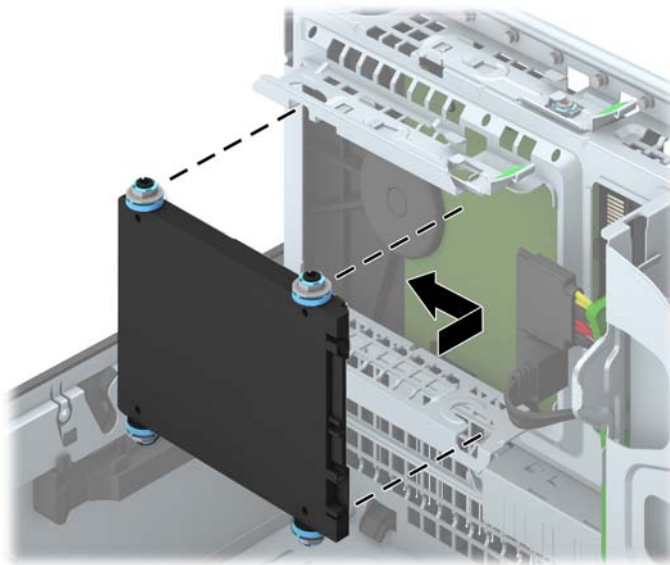

7. Connect the power cable and data cable to the back of the hard drive.

 **NOTE:** If the 2.5-inch hard drive is the primary drive, connect the data cable to the dark blue SATA connector labeled SATA0 on the system board. If it is a secondary drive, connect the data cable to one of the light blue SATA connectors on the system board.

8. Rotate the drive cage back down to its normal position.

 **CAUTION:** Be careful not to pinch any cables or wires when rotating the drive cage down.

Power supply

Description	Spare part number
Power supply, 92% efficient	702455-001
Power supply, 90% efficient	702456-001
Power supply, standard	702457-001

⚠ WARNING! To reduce potential safety issues, only the power supply provided with the computer, a replacement power supply provided by HP, or a power supply purchased as an accessory from HP should be used with the computer.

The power supply is located at the rear of the chassis. It is held in place by three Torx screws outside of the chassis and a release lever inside of the chassis.

⚠ WARNING! Voltage is always present on the system board when the computer is plugged into an active AC outlet. To avoid possible personal injury and damage to the equipment the power cord should be disconnected from the computer and/or the AC outlet before opening the computer.

1. Prepare the computer for disassembly ([Preparation for disassembly on page 94](#)).
2. Remove the access panel ([Access panel on page 95](#)).
3. Rotate the drive cage to the upright position.
4. Disconnect all power cables from the following system board connectors:
 - PWRCPU
 - PWRCMD
 - PWR

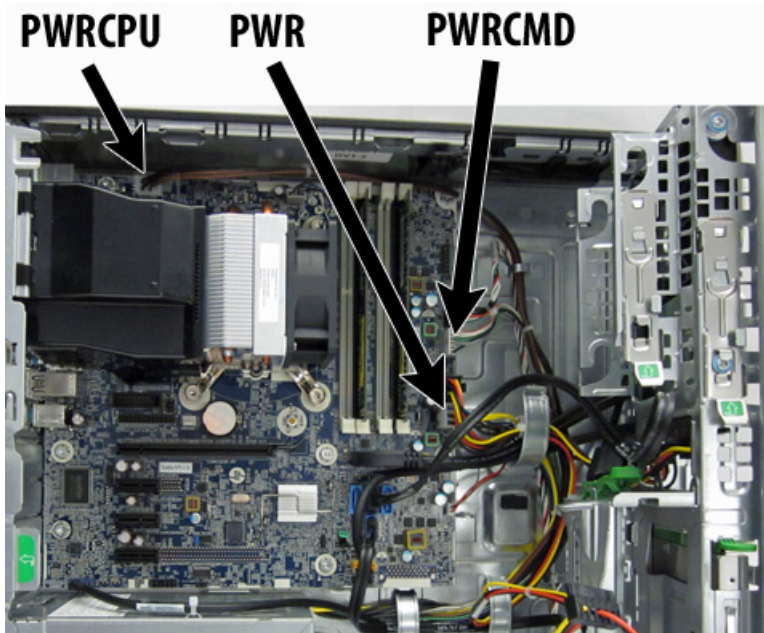

5. Release the power supply cables from the cable retaining clip under the drive cage.

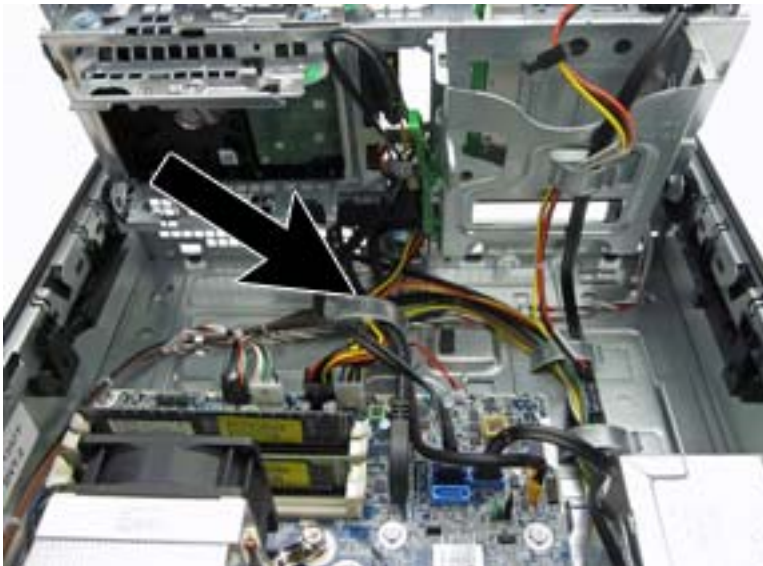

6. From the outside, rear of the computer, remove the three Torx screws that secure the power supply to the rear of the chassis.

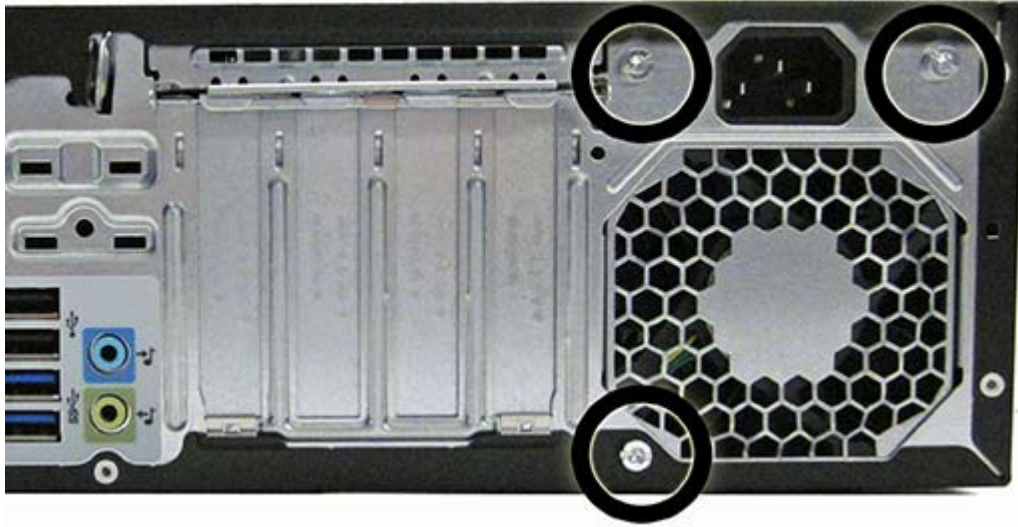

7. From the inside of the chassis, press the release button at the front of the power supply (1).
8. Slide the power supply forward (2), and then lift it out of the chassis (3).

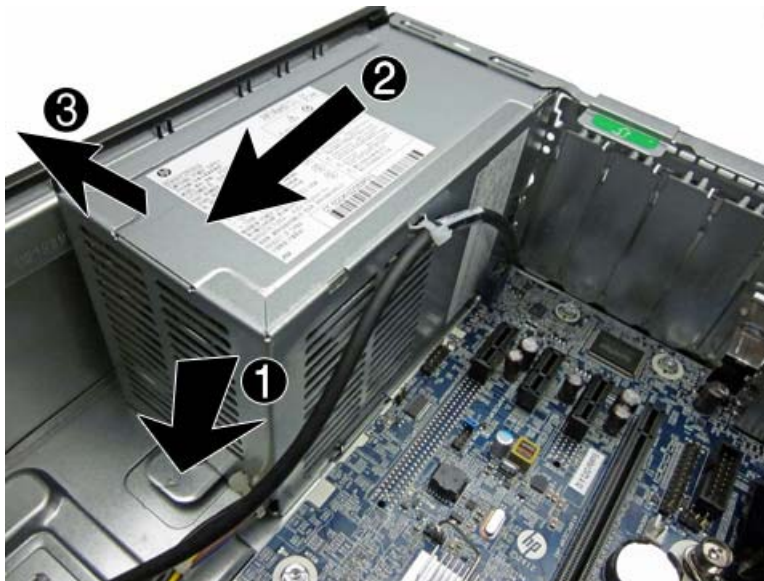

To install the power supply, reverse the removal procedure.

CAUTION: When installing the power supply cables, make sure they are properly positioned in the clip under the drive cage.

Fan duct

Description	Spare part number
Fan duct	727145-001

The fan duct sits between the front fan and the heat sink.

1. Prepare the computer for disassembly ([Preparation for disassembly on page 94](#)).
2. Remove the access panel ([Access panel on page 95](#)).
3. Rotate the fan duct upward.

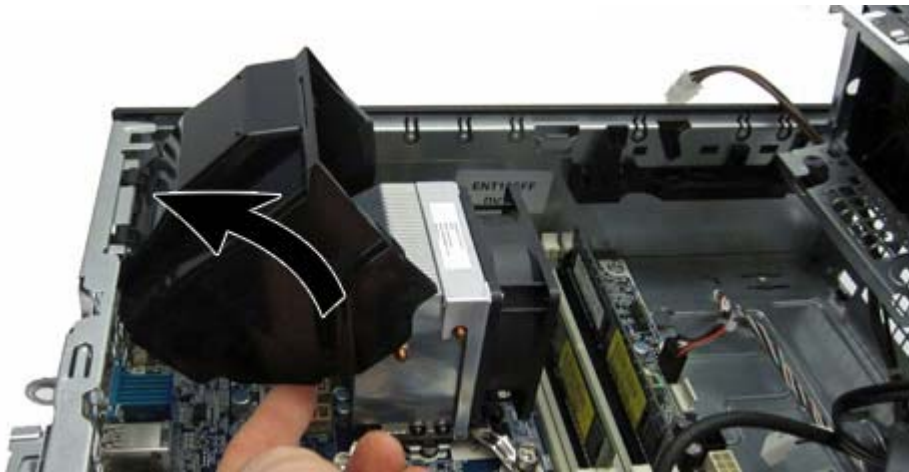

4. Pull the duct away from the chassis to disengage the clips on the duct from the chassis.



To install the fan duct, reverse the removal procedure.

Smart Cover Lock (solenoid lock)

Description	Spare part number
Solenoid lock	732772-001

 **NOTE:** The Smart Cover Lock is an optional feature included on some models only.

The Smart Cover Lock is a software-controllable cover lock, controlled by the setup password. This lock prevents unauthorized access to the internal components. The computer ships with the Smart Cover Lock in the unlocked position.

If you enable the Smart Cover Lock and cannot enter your password to disable the lock, you will need a Smart Cover FailSafe Key to open the computer cover. You will need the key to access the internal computer components in any of the following circumstances:

- Power outage
- Startup failure
- PC component (for example, processor or power supply) failure
- Forgotten password

 **NOTE:** The Smart Cover FailSafe Key is a specialized tool available from HP. Be prepared; order this key before you need it.

To obtain a FailSafe Key:

- Contact an authorized HP reseller or service provider. Order PN 166527-001 for the wrench-style key or PN 166527-002 for the screwdriver bit key.
- Refer to the HP Web site (<http://www.hp.com>) for ordering information.
- Call the appropriate number listed in the warranty.

The solenoid lock is mounted to the back of the computer. Remove it using one security screw on the outside of the computer.

1. Prepare the computer for disassembly ([Preparation for disassembly on page 94](#)).
2. Remove the access panel ([Access panel on page 95](#)).

3. From the outside, rear side of the chassis, remove the silver security screw that secures the solenoid lock to the chassis.

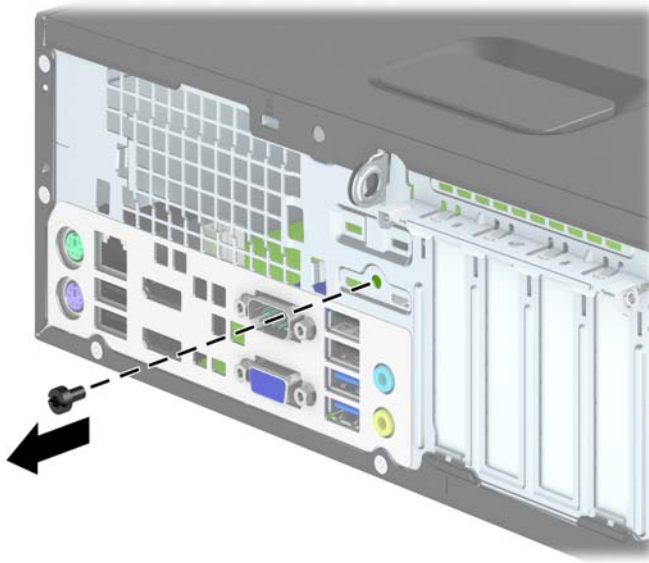

4. From the inside of the chassis, disconnect the cable (1) from the system board connector labeled HLOCK.
5. Remove the solenoid lock from the chassis (2).



To install the solenoid lock, reverse the removal procedure.

Refer to the following image for the location of the slots on the back of the chassis in which to install the solenoid lock. When installing, insert the top tabs into the top slots, and then rotate the lock downward. Then install the security screw on the outside of the computer. Plug the connector into the system board connector.

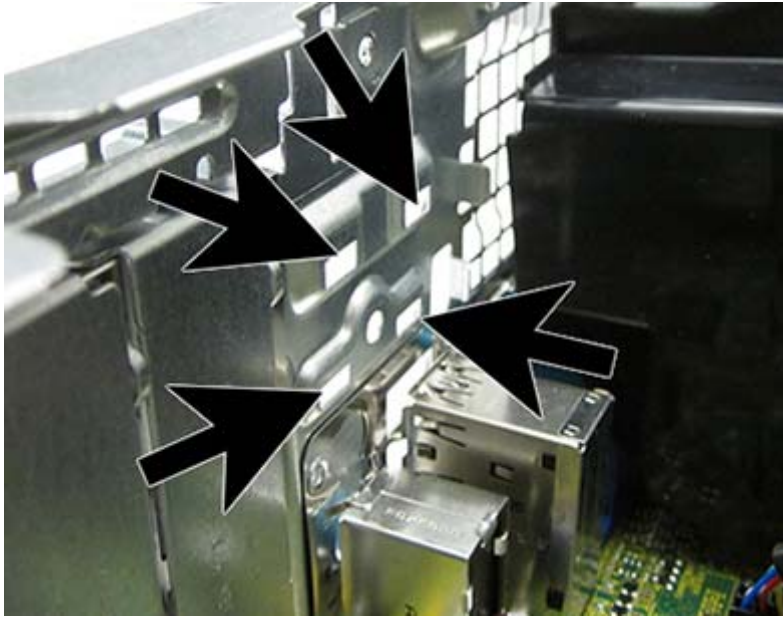

Hood sensor

Description	Spare part number
Hood sensor	638816-001

1. Prepare the computer for disassembly ([Preparation for disassembly on page 94](#)).
2. Remove the access panel ([Access panel on page 95](#)).
3. Disconnect the cable from the system board connector labeled HSENSE **(1)**.
4. Using a tool, remove the sensor from the slot by pushing it into the computer to remove it **(2)**.

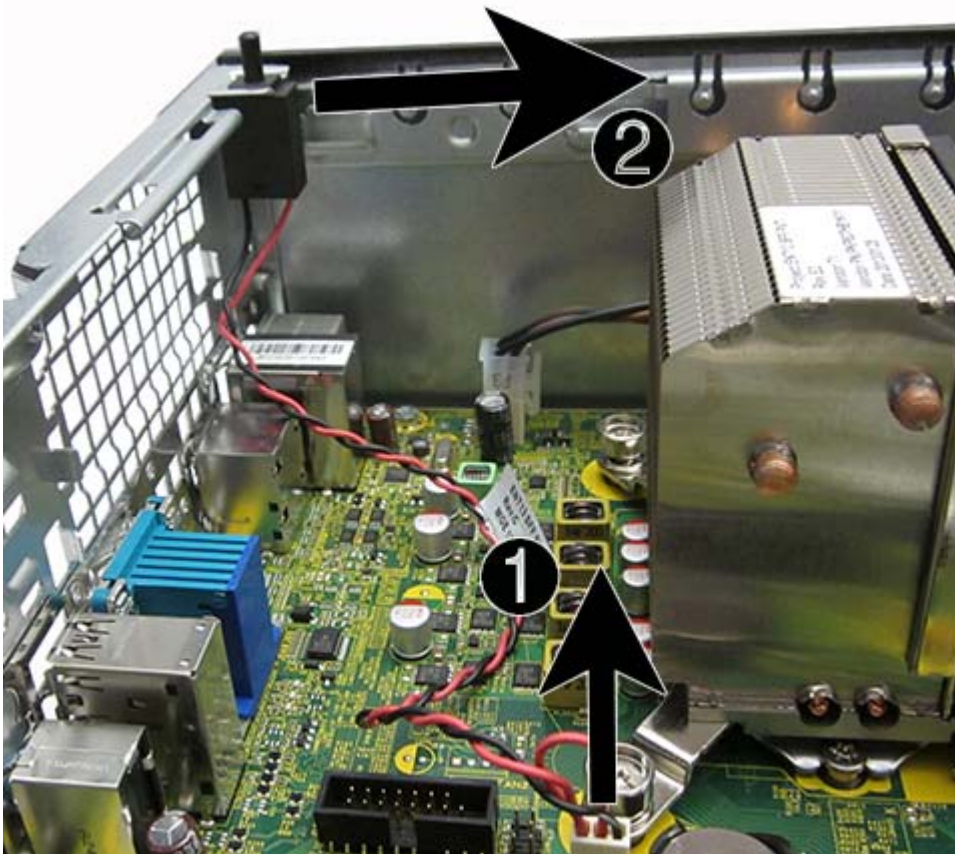

To install the hood sensor, reverse the removal procedure.

Cable routing

Use the following image to determine proper cable routing in the Small Form Factor computer.

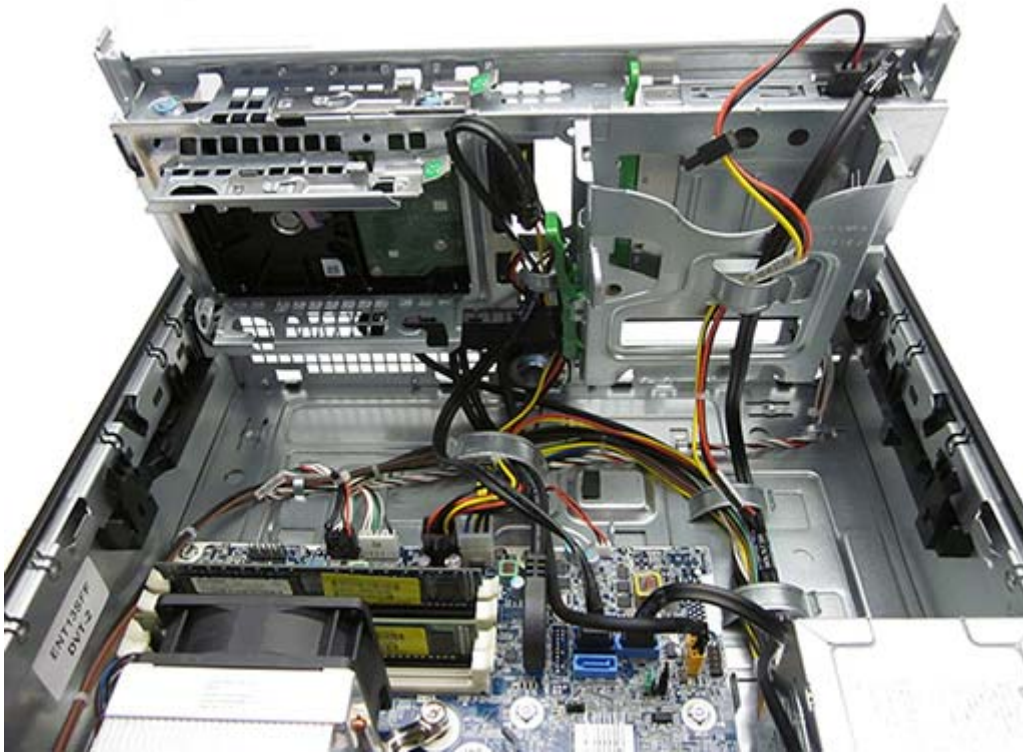

Front I/O assembly

Description	Spare part number
Front I/O assembly	732755-001

1. Prepare the computer for disassembly ([Preparation for disassembly on page 94](#)).
2. Remove the access panel ([Access panel on page 95](#)).
3. Remove the front bezel ([Front bezel on page 96](#)).
4. Rotate the drive cage to its upright position.
5. Disconnect the cables from the system board as follows:
 - Yellow connector labeled FRONT_USB
 - Black connector labeled MEDIA 3.0
 - Blue connector labeled FRONT_AUD

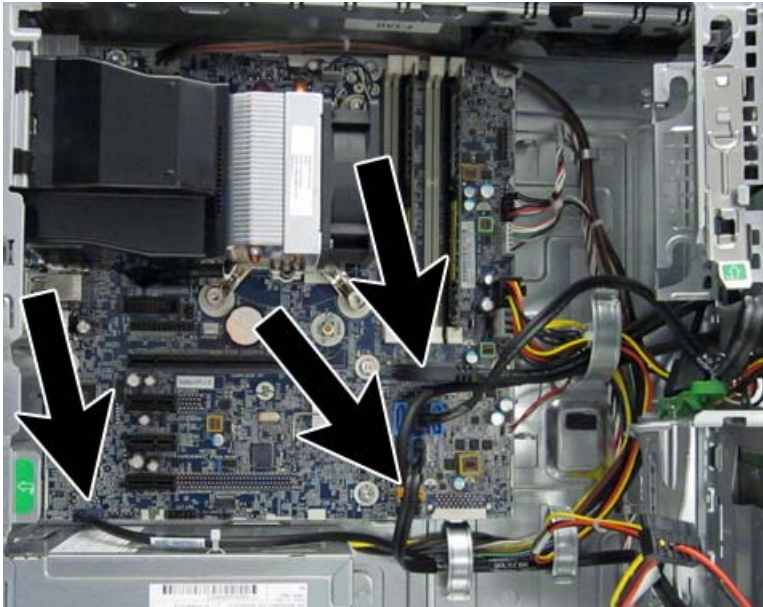

6. Remove the cables from the cable clip under the drive cage.

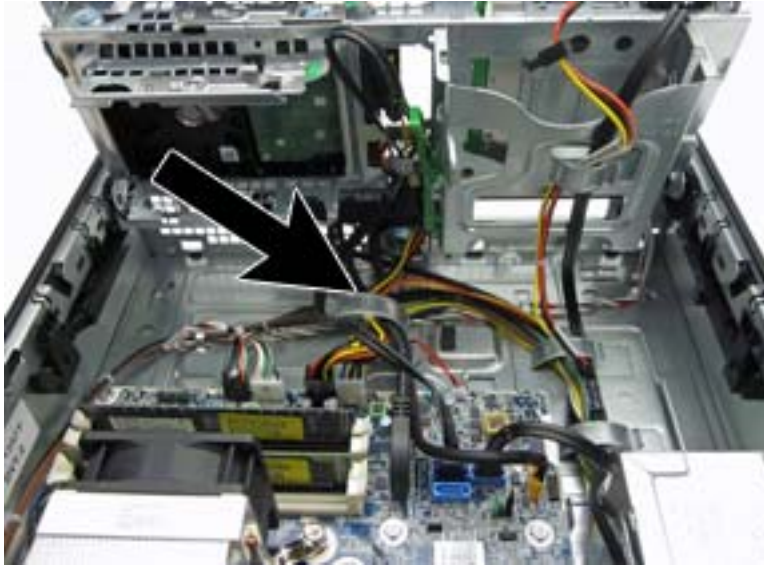

7. Remove the Torx T15 screw **(1)** that secures the assembly to the front of the chassis.
8. Press the tab on the right side of the assembly **(2)** to disengage it from the chassis.
9. Push the assembly into the chassis **(3)**, and remove it from the chassis.

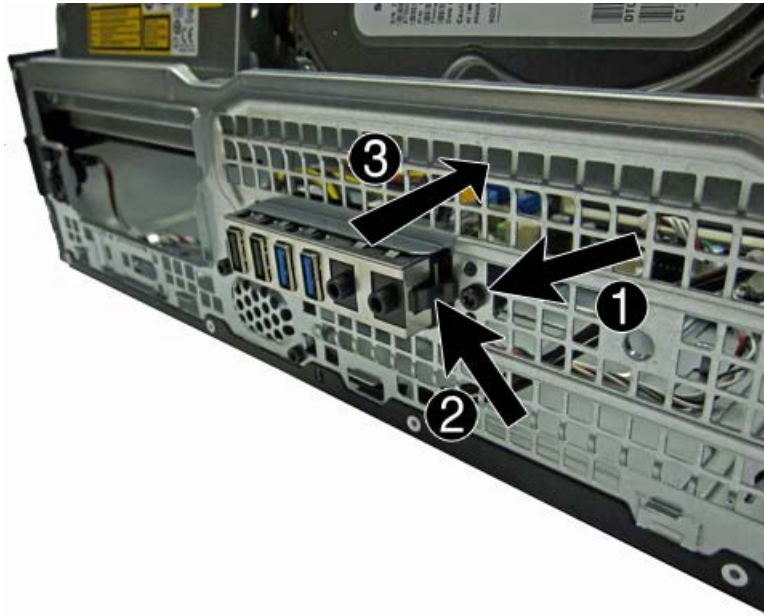

To install the front I/O assembly, reverse the removal procedure.

 **NOTE:** Be sure to correctly route the cables beneath the drive cage when reinstalling the assembly. Proper cable routing prevents damage to the cables and allows the drive cage to close properly. See [Cable routing on page 129](#) for proper cable placement.

Power switch assembly

Description	Spare part number
Power switch assembly	732756-001

1. Prepare the computer for disassembly ([Preparation for disassembly on page 94](#)).
2. Remove the access panel ([Access panel on page 95](#)).
3. Remove the front bezel ([Front bezel on page 96](#)).
4. Rotate the drive cage to its upright position.
5. Disconnect the cable from the system board connector labeled PB/LED.

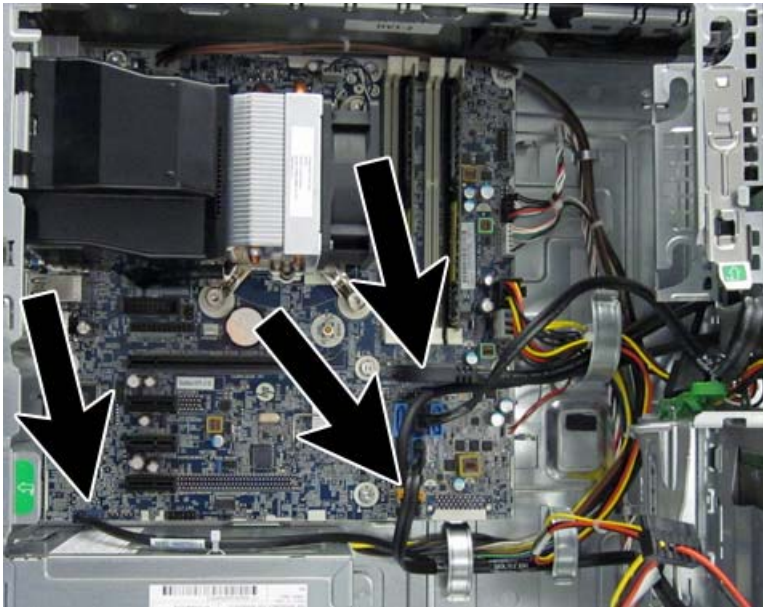

6. Remove the cable from the cable clip under the drive cage.

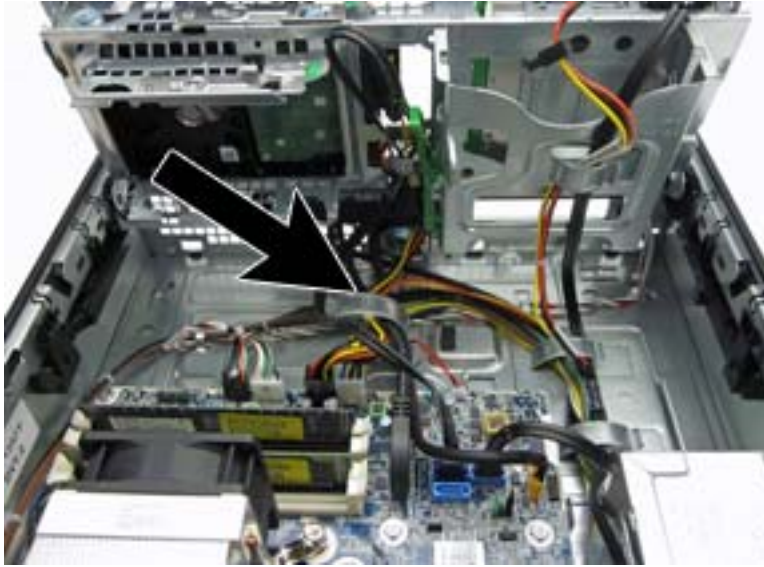

7. From the inside of the chassis, press down on the tab on the top of the power switch **(1)** to disengage the power switch from the chassis.
8. Pull the power switch out the front of the chassis **(2)**, while routing the cable through the hole in the chassis.

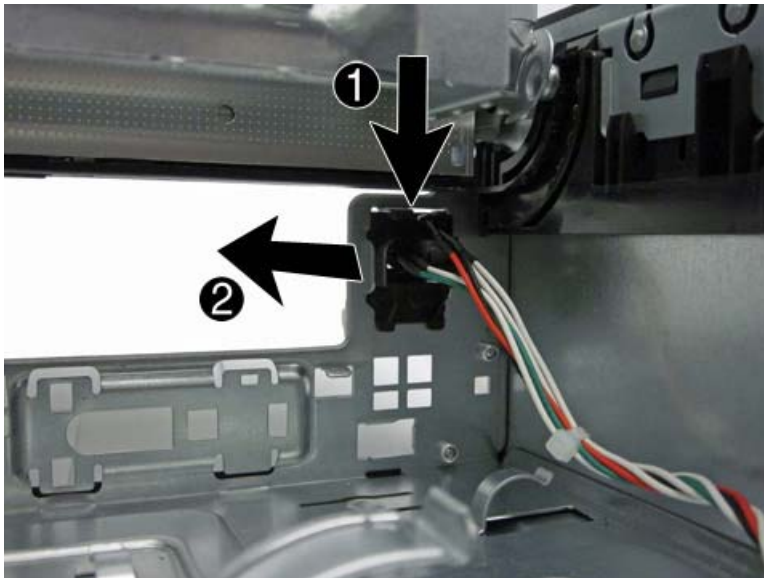

To install the power switch assembly, reverse the removal procedure.

 **NOTE:** Be sure to correctly route the cables beneath the drive cage when reinstalling the assembly. Proper cable routing prevents damage to the cables and allows the drive cage to close properly. See [Cable routing on page 129](#) for proper cable placement.

Speaker

Description	Spare part number
Speaker	727149-001

The speaker is attached to the front of the chassis under the rotating drive cage.

1. Prepare the computer for disassembly ([Preparation for disassembly on page 94](#)).
2. Remove the access panel ([Access panel on page 95](#)).
3. Remove the front bezel ([Front bezel on page 96](#)).
4. Rotate the drive cage to its upright position.
5. Disconnect the speaker wire from the white system board connector labeled SPKR.
6. Remove the two Torx screws that secure the speaker to the chassis.



7. Lift the speaker from the inside of the chassis to remove it.



To install the speaker, reverse the removal procedures.

Fan sink

Description	Spare part number
Fan sink	727150-001

The fan sink is secured atop the processor with four captive Torx screws. The fan sink includes a heat sink and a fan.

1. Prepare the computer for disassembly ([Preparation for disassembly on page 94](#)).
2. Remove the access panel ([Access panel on page 95](#)).
3. Remove the fan duct ([Fan duct on page 124](#)).
4. Loosen the four captive Torx T15 screws that secure the fan sink to the system board tray.

⚠ CAUTION: Remove fan sink retaining screws in diagonally opposite pairs (as in an X) to even the downward forces on the processor. This is especially important as the pins on the socket are very fragile and any damage to them may require replacing the system board.



5. Disconnect the fan cable from the system board connector labeled CPUFAN **(1)**, and then lift the heat sink from atop the processor **(2)**.

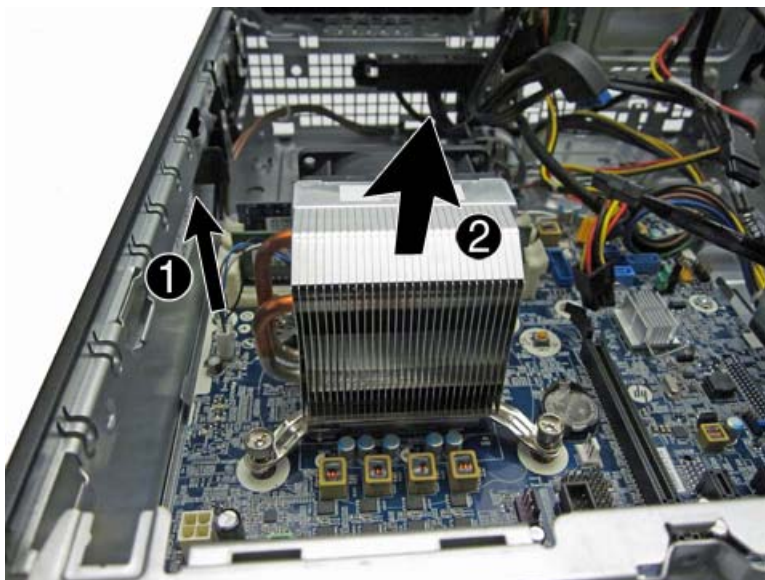

When reinstalling the fan sink, make sure that its bottom has been cleaned with an alcohol wipe and fresh thermal grease has been applied to the top of the processor.

CAUTION: Fan sink retaining screws should be tightened in diagonally opposite pairs (as in an X) to evenly seat the fan sink on the processor to avoid damage that could require replacing the system board.

Make sure to replace the fan duct. Failure to install the fan duct may cause the computer to overheat.

Processor

Description	Spare part number
Intel Core i7 processor	
4770, 3.4 GHz, 8-MB L3 cache, 86W	727373-001
Intel Core i5 processors	
4670, 3.4 GHz, 6-MB L3 cache, 86W	727381-001
4570, 3.2 GHz, 6-MB L3 cache, 86W	727380-001

1. Prepare the computer for disassembly ([Preparation for disassembly on page 94](#)).
2. Remove the access panel ([Access panel on page 95](#)).
3. Remove the fan duct ([Fan duct on page 124](#)).
4. Remove the fan sink ([Fan sink on page 135](#)).

5. Rotate the locking lever to its full open position **(1)**.
6. Raise and rotate the microprocessor retainer to its fully open position **(2)**.
7. Carefully lift the processor from the socket **(3)**.

⚠ CAUTION: Do NOT handle the pins in the processor socket. These pins are very fragile and handling them could cause irreparable damage. Once pins are damaged it may be necessary to replace the system board.

The heat sink must be installed within 24 hours of installing the processor to prevent damage to the processor's solder connections.

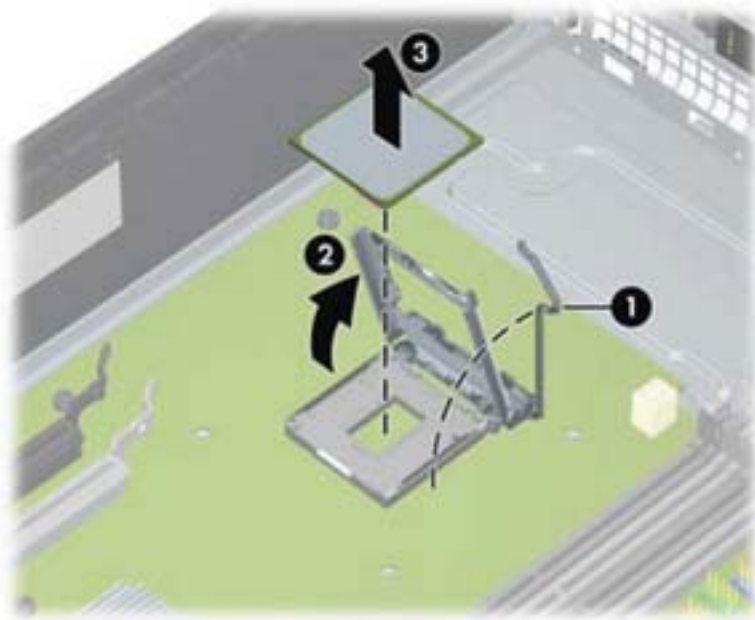

📝 NOTE: After installing a new processor onto the system board, always update the system ROM to ensure that the latest version of the BIOS is being used on the computer. The latest system BIOS can be found on the Web at: <http://www8.hp.com/us/en/support-drivers.html>.

System board

Description	Spare part number
System board for use in models without Windows 8 (includes thermal material)	717522-001
System board for use in models with Windows 8 Standard (includes thermal material)	717522-501
System board for use in models with Windows 8 Professional (includes thermal material)	717522-601
System board for use in models with NetClone (includes thermal material)	727722-001

1. Prepare the computer for disassembly ([Preparation for disassembly on page 94](#)).
2. Remove the access panel ([Access panel on page 95](#)).
3. When replacing the system board, make sure the following components are removed from the defective system board and installed on the replacement system board:
 - Memory modules ([Memory on page 100](#))
 - Expansion cards ([Expansion card on page 103](#))
 - Fan sink ([Fan sink on page 135](#))
 - Processor ([Processor on page 136](#))
4. Remove the fan duct from the chassis ([Fan duct on page 124](#)).
5. Rotate the drive cage to its upright position.
6. Disconnect all data and power cables from the system board.
7. Remove the eight Torx screws **(1)** that secure the system board to the chassis.

8. Slide the system board toward the front of the chassis to disengage the connectors (2), and then lift the system board up and out of the chassis (3).

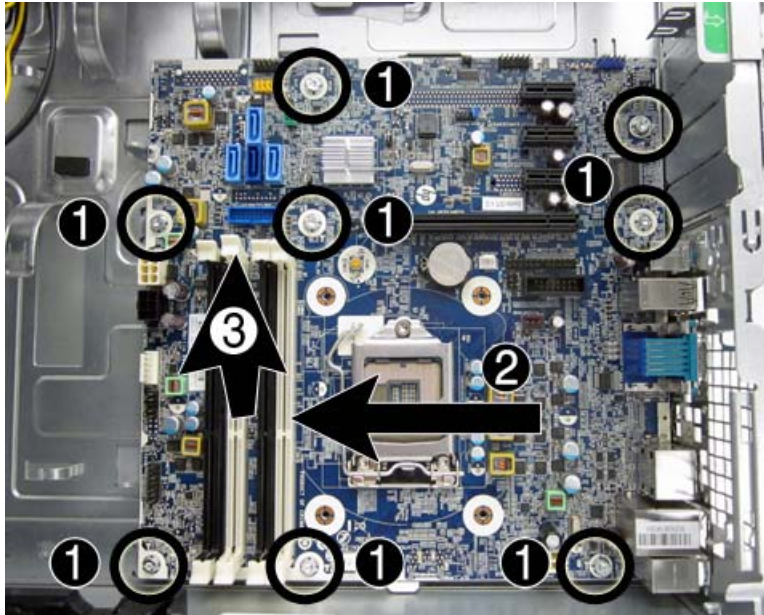

To install the system board, reverse the removal procedure.

 **NOTE:** When replacing the system board, you must also change the chassis serial number in the BIOS.

 **CAUTION:** When reconnecting the cables it is important that they be positioned correctly.

Changing from desktop to tower configuration

The Small Form Factor computer can be used in a tower orientation with an optional tower stand that can be purchased from HP.

1. Prepare the computer for disassembly ([Preparation for disassembly on page 94](#)).
2. Orient the computer so that its right side is facing down and place the computer in the optional stand.

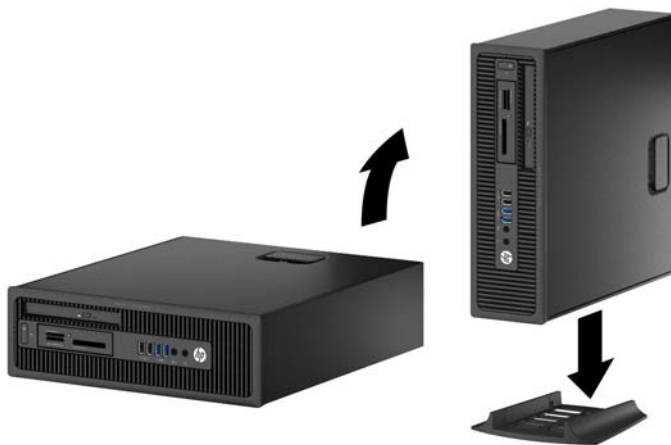

 **NOTE:** To stabilize the computer in a tower orientation, HP recommends the use of the optional tower stand.

3. Reconnect the power cord and any external devices, then turn on the computer.

 **NOTE:** Ensure at least 10.2 centimeters (4 inches) of space on all sides of the computer remains clear and free of obstructions.

7 Removal and replacement procedures: Ultra-slim Desktop (USDT)

Adherence to the procedures and precautions described in this chapter is essential for proper service. After completing all necessary removal and replacement procedures, run the Diagnostics utility to verify that all components operate properly.

 **NOTE:** Not all features listed in this guide are available on all computers.

Preparation for disassembly

See [Routine care, SATA drive guidelines, and disassembly preparation on page 35](#) for initial safety procedures.

1. Remove/disengage any security devices that prohibit opening the computer.
2. Remove all removable media, such as compact discs or USB flash drives, from the computer.
3. Turn off the computer properly through the operating system, then turn off any external devices.
4. Disconnect the power cord from the power outlet and disconnect any external devices.

 **CAUTION:** Turn off the computer before disconnecting any cables.

Regardless of the power-on state, voltage is always present on the system board as long as the system is plugged into an active AC outlet. In some systems the cooling fan is on even when the computer is in the "Standby," or "Suspend" modes. The power cord should always be disconnected before servicing a unit.

5. If the computer is on a stand, remove the computer from the stand and lay the computer down.

 **NOTE:** During disassembly, label each cable as you remove it, noting its position and routing. Keep all screws with the units removed.

Access panel

Description	Spare part number
Access panel	732763-001

To access internal components, you must remove the access panel:

1. Prepare the computer for disassembly ([Preparation for disassembly on page 141](#)).
2. Loosen the thumbscrew on the rear of the computer (1), slide the access panel toward the rear of the computer, then lift it off (2).



To install the access panel, reverse the removal procedure.

Front bezel

Description	Spare part number
Front bezel	732764-001

1. Prepare the computer for disassembly ([Preparation for disassembly on page 141](#)).
2. Remove the access panel ([Access panel on page 142](#)).
3. Lift up the three tabs on the side of the bezel (1), then rotate the bezel off the chassis (2).

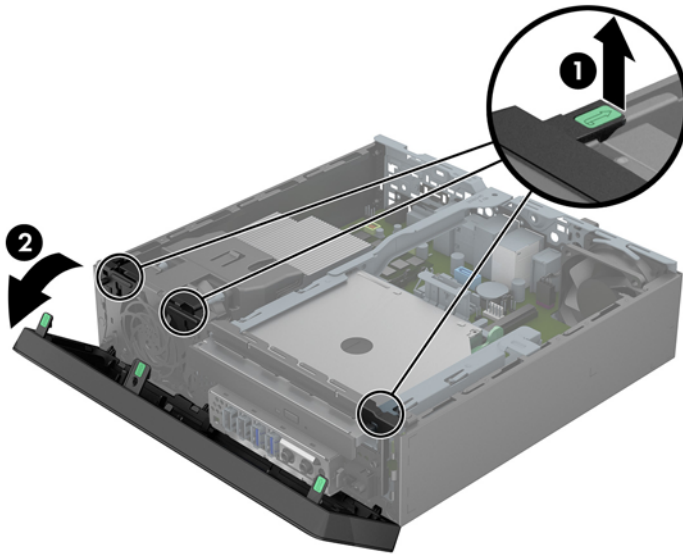

To install the front bezel, reverse the removal procedure.

Front bezel security

The front bezel can be locked in place by installing a security screw provided by HP. To install the security screw:

1. Prepare the computer for disassembly ([Preparation for disassembly on page 141](#)).
2. Remove the access panel ([Access panel on page 142](#)).
3. Remove the front bezel ([Front bezel on page 143](#)).
4. Remove the black screw on the front of the chassis behind the bezel. The screw is located next to the optical drive and is labeled "BEZEL."

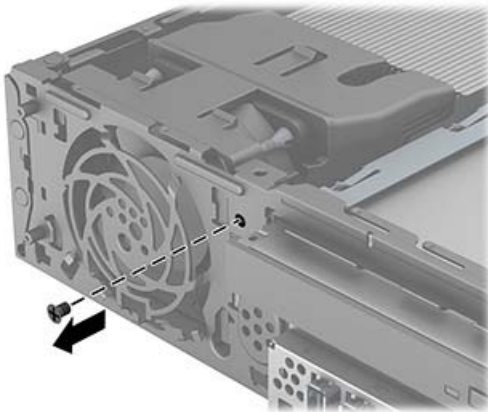

5. Replace the front bezel.
6. Install the security screw through the middle front bezel release tab and into the chassis to secure the front bezel in place.

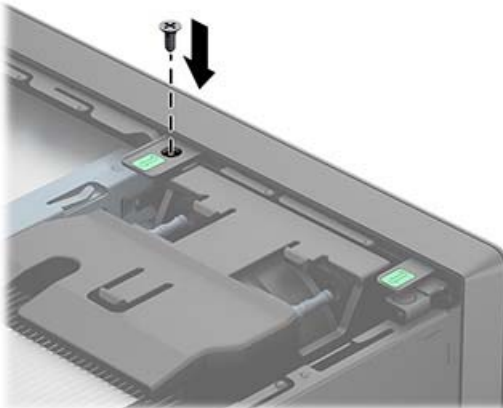



Bezel blank

Description	Spare part number
Optical drive bezel blank	732771-001

On some models, there is a bezel blank covering the slim optical drive bay that needs to be removed before installing a slim optical drive. To remove a bezel blank:

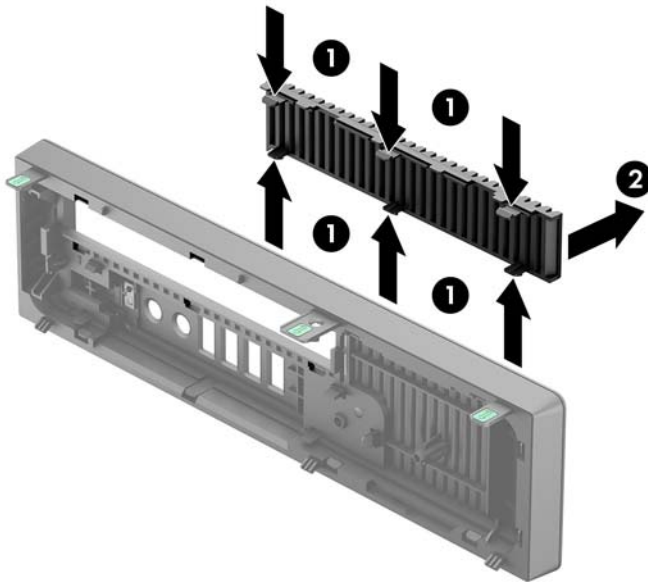
1. Remove the access panel ([Access panel on page 142](#)).
2. Remove the front bezel ([Front bezel on page 143](#)).
3. To remove the bezel blank, press inward on the six retaining tabs (1) and pull the blank off the front bezel (2).



 **NOTE:** After removing the slim optical drive bezel blank and installing a slim optical drive, you can install an optional bezel trim piece (available from HP) that surrounds the front of the slim optical drive.

System board connections

Refer to the following illustration and table to identify the system board connectors.

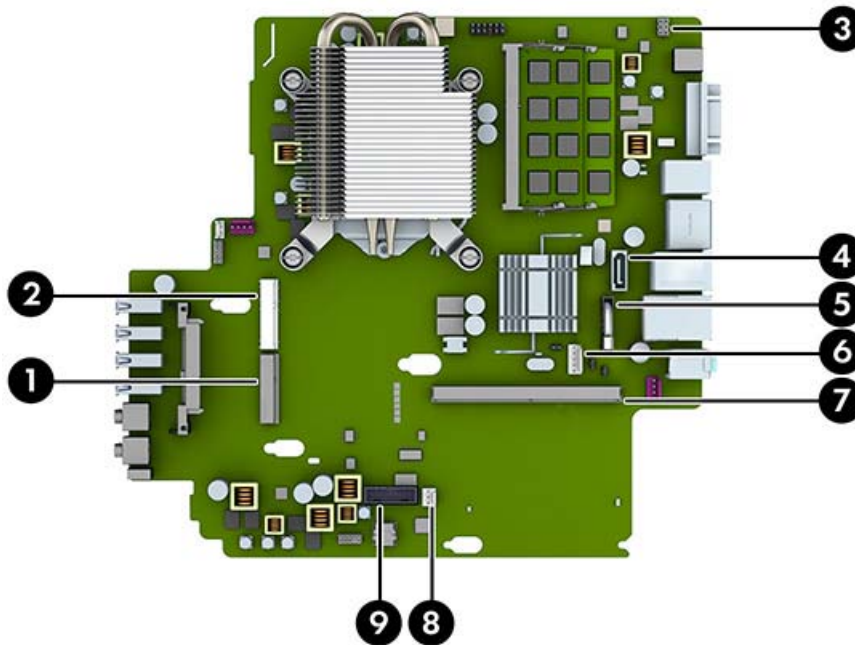

No.	System Board Connector	System Board Label	Color	Component
1	Mini PCI Express x1	X1PCIEXP1	black	Expansion Card (for example, WLAN card)
2	Mini-SATA	mSATA	white	Ultra-Small SSD
3	Hood Lock	HLOCK	black	Hood Lock
4	SATA 3.0	SATA1	light blue	Optical Drive
5	Battery	BAT	black	Battery
6	Power	SATA PWR1	white	Optical Drive
7	Mobile PCI Express Module	MXM	black	Graphics Card
8	Hood Sensor	HSENSE	white	Hood Sensor
9	USB 3.0	MEDIA 3.0	black	SD Media Card Reader

Memory

Description	Spare part number
8-GB, PC3-12800, SODIMM	689374-001
4-GB, PC3-12800, SODIMM	689373-001
2-GB, PC3-12800, SODIMM	689372-001

The computer comes with double data rate 3 synchronous dynamic random access memory (DDR3-SDRAM) small outline dual inline memory modules (SODIMMs).

SODIMMs

The memory sockets on the system board can be populated with up to two industry-standard SODIMMs. These memory sockets are populated with at least one preinstalled SODIMM. To achieve the maximum memory support, you can populate the system board with up to 16-GB of memory.

DDR3-SDRAM SODIMMs

For proper system operation, the SODIMMs must be:

- industry-standard 204-pin
- unbuffered non-ECC PC3-12800 DDR3-1600 MHz-compliant
- 1.35 volt or 1.5 volt DDR3-SDRAM SODIMMs

The DDR3-SDRAM SODIMMs must also:

- support CAS latency 11 DDR3 1600 MHz (11-11-11 timing)
- contain the mandatory Joint Electronic Device Engineering Council (JEDEC) specification

In addition, the computer supports:

- 512-Mbit, 1-Gbit, and 2-Gbit non-ECC memory technologies
- single-sided and double-sided SODIMMS
- SODIMMs constructed with x8 and x16 devices; SODIMMs constructed with x4 SDRAM are not supported



NOTE: The system will not operate properly if you install unsupported SODIMMs.

Populating SODIMM sockets

There are two SODIMM sockets on the system board, with one socket per channel. The sockets are labeled DIMM1 and DIMM3. The DIMM1 socket operates in memory channel B. The DIMM3 socket operates in memory channel A.

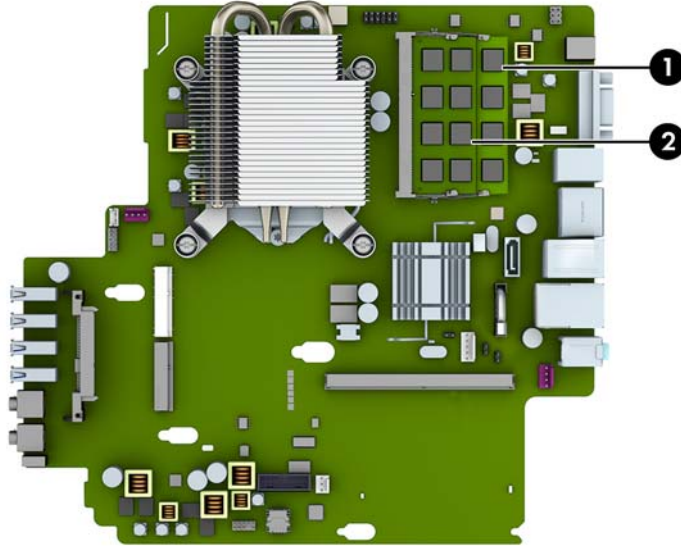

Item	Description	System Board Label	Socket Color
1	SODIMM1 socket, Channel B	DIMM1	Black
2	SODIMM3 socket, Channel A	DIMM3	Black

The system will automatically operate in single channel mode, dual channel mode, or flex mode, depending on how the SODIMMs are installed.

- The system will operate in single channel mode if the SODIMM sockets are populated in one channel only.
- The system will operate in a higher-performing dual channel mode if the memory capacity of the SODIMM in Channel A is equal to the memory capacity of the SODIMM in Channel B.
- The system will operate in flex mode if the memory capacity of the SODIMM in Channel A is not equal to the memory capacity of the SODIMM in Channel B. In flex mode, the channel populated with the least amount of memory describes the total amount of memory assigned to dual channel and the remainder is assigned to single channel. If one channel will have more memory than the other, the larger amount should be assigned to channel A.
- In any mode, the maximum operational speed is determined by the slowest SODIMM in the system.

Installing SODIMMs

⚠ CAUTION: You must disconnect the power cord and wait approximately 30 seconds for the power to drain before adding or removing memory modules. Regardless of the power-on state, voltage is always supplied to the memory modules as long as the computer is plugged into an active AC outlet. Adding or removing memory modules while voltage is present may cause irreparable damage to the memory modules or system board.

The memory module sockets have gold-plated metal contacts. When upgrading the memory, it is important to use memory modules with gold-plated metal contacts to prevent corrosion and/or oxidation resulting from having incompatible metals in contact with each other.

Static electricity can damage the electronic components of the computer or optional cards. Before beginning these procedures, ensure that you are discharged of static electricity by briefly touching a grounded metal object. For more information, refer to [Electrostatic discharge information on page 35](#).

When handling a memory module, be careful not to touch any of the contacts. Doing so may damage the module.

1. Prepare the computer for disassembly ([Preparation for disassembly on page 141](#)).
2. Remove the access panel ([Access panel on page 142](#)).
3. Locate the memory module sockets on the system board.

⚠ WARNING! To reduce risk of personal injury from hot surfaces, allow the internal system components to cool before touching.

4. To remove a SODIMM, press outward on the two latches on each side of the SODIMM **(1)** then pull the SODIMM out of the socket **(2)**.

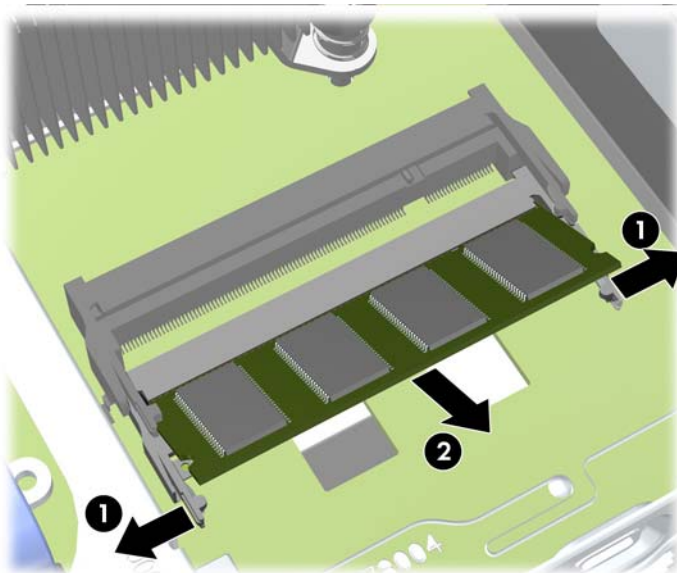

To install memory modules, reverse the removal procedure.

The computer automatically recognizes the additional memory when you turn on the computer.

Front fan

Description	Spare part number
Front fan	732765-001

The front fan sits against the front on the left side of the chassis.

1. Prepare the computer for disassembly ([Preparation for disassembly on page 141](#)).
2. Remove the access panel ([Access panel on page 142](#)).
3. Disconnect the fan control cable from the red system board connector labeled CHFAN **(1)**.
4. Lift the fan straight up and out of the chassis **(2)**.



To install the front fan, reverse the removal procedure.

Optical drive

The Ultra-Slim Desktop uses a slimline Serial ATA (SATA) optical drive.

Description	Spare part number
DVD-ROM drive	608394-001
DVD±RW drive	657958-001
Blu-ray BD-RW SuperMulti XL Drive	719157-001

Removing the optical drive

⚠ CAUTION: All removable media should be taken out of a drive before removing the drive from the computer.

1. Prepare the computer for disassembly ([Preparation for disassembly on page 141](#)).
2. Remove the access panel ([Access panel on page 142](#)).
3. Remove the front bezel ([Front bezel on page 143](#)).
4. Disconnect the cables on the rear of the optical drive (1), push the green release latch on the right rear side of the drive toward the center of the drive (2), then slide the drive forward and out of the bay through the front bezel (3).

⚠ CAUTION: When removing the cables, pull the tab or connector instead of the cable itself to avoid damaging the cable.

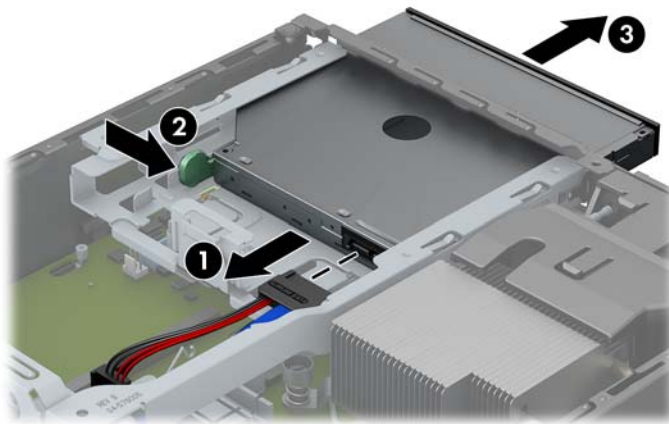

Preparing the new optical drive

Before the new optical drive can be used, the release latch must be attached.

1. Peel the backing off the adhesive on the release latch.
2. Without allowing the release latch to touch the optical drive, carefully align the holes on the release latch with the pins on the side of the optical drive. Make sure the release latch is oriented properly.
3. Insert the pin at the front of the optical drive into the hole at the end of the release latch, and press firmly.
4. Insert the second pin, and press the entire release latch firmly to fasten the latch securely to the optical drive.

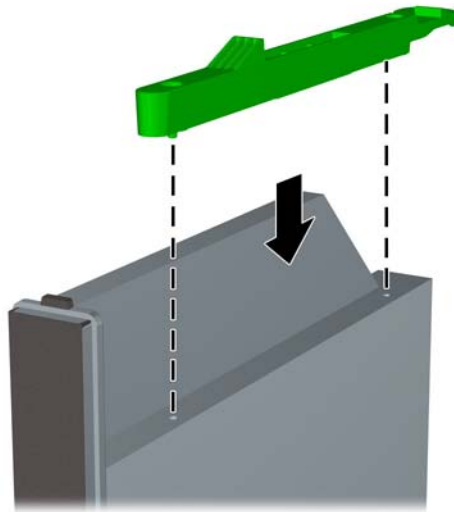

Installing the new optical drive

 **NOTE:** If you are installing an optical drive in a bay that did not previously have a drive in it, you must remove the access panel and the bezel blank covering the opening of the bay before proceeding. Follow the procedures in [Access panel on page 142](#) and [Bezel blank on page 145](#).

1. Follow the instructions for removing the optical drive. Refer to [Removing the optical drive on page 151](#).
2. Attach the release latch to the new optical drive. Refer to [Preparing the new optical drive on page 152](#).
3. Slide the optical drive through the front bezel all the way into the bay so that it locks in place (1), then connect the cable to the rear of the drive (2).

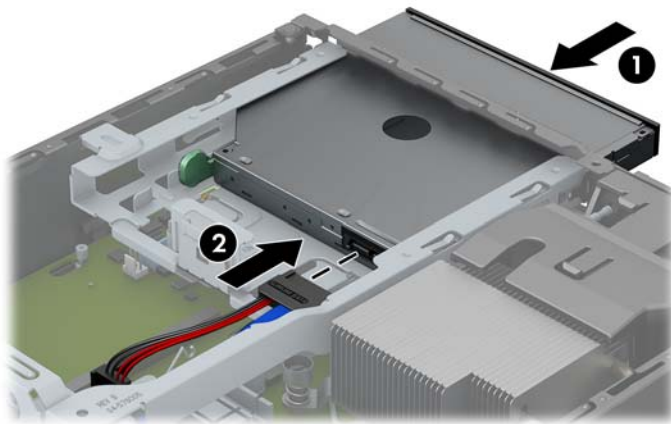

Hard drive

Description	Spare part number
750 GB, 7200 rpm, hybrid SSD	719105-001
500 GB, 7200 rpm, self-encrypting (SED)	696442-001
500 GB, 7200 rpm	686217-001
320 GB, 7200 rpm	639135-001
500 GB, hybrid SSD	724938-001
256 GB Solid State Drive (SSD), self-encrypting (SED)	680020-001
128 GB Solid State Drive (SSD)	665961-001
32 MB mSATA drive	719566-001

 **NOTE:** The Ultra-Slim Desktop supports only 2.5-inch Serial ATA (SATA) internal hard drives.

Before you remove the old hard drive, be sure to back up the data from the old hard drive so that you can transfer the data to the new hard drive.

The 2.5-inch hard drive is enclosed in a carrier under the optical drive.

1. Prepare the computer for disassembly ([Preparation for disassembly on page 141](#)).
2. Remove the access panel ([Access panel on page 142](#)).
3. Remove the optical drive ([Removing the optical drive on page 151](#)).
4. Press in the release latch on the left side of the hard drive carrier (1) then rotate the carrier handle up (2).

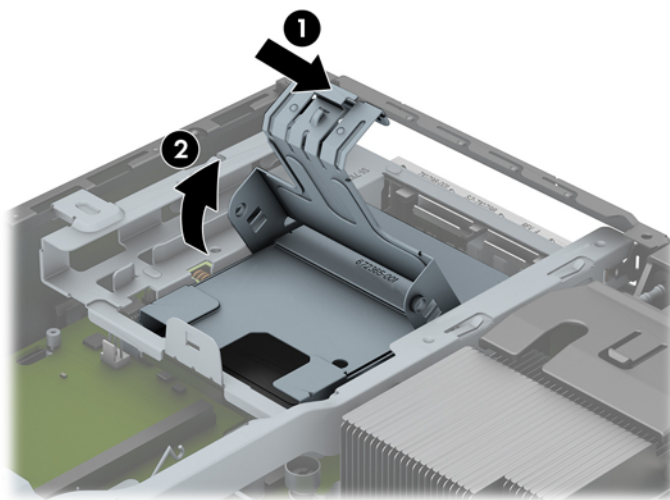

5. Lift the hard drive carrier straight up and out of the chassis.

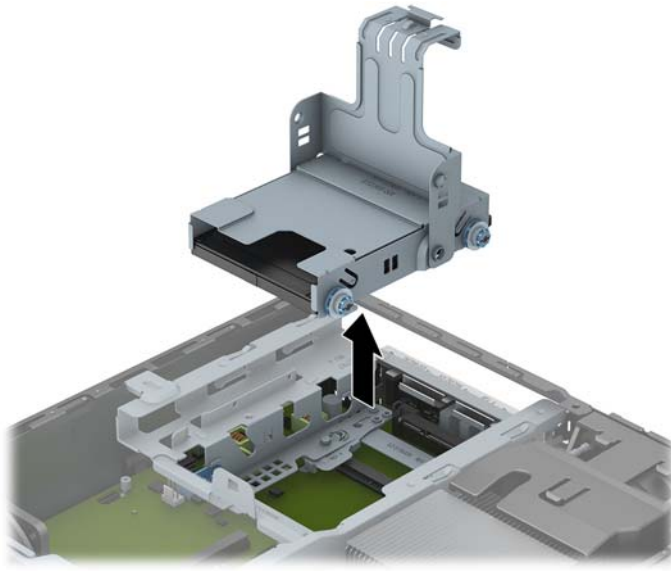

6. Remove the four guide screws from the sides of the hard drive carrier.

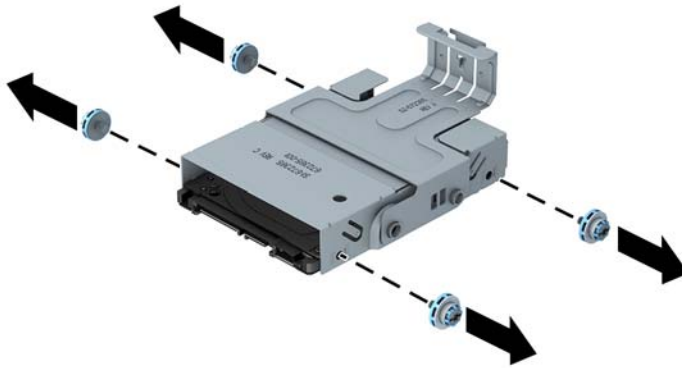

7. Lift the hard drive up to the top of the carrier (1) and slide the drive out of the carrier (2).



To replace the hard drive, reverse the removal procedures.

When replacing the hard drive, position the hard drive so that the top of the hard drive is up against the top of the carrier so that the circuit board on the bottom of the hard drive does not come in contact with the tabs on the bottom of the carrier, then slide the new hard drive into the carrier.

CAUTION: Do not allow the circuit board on the bottom of the hard drive to scrape along the tabs on the bottom of the carrier when sliding the hard drive into the carrier. Doing so can cause irreparable damage to the hard drive.

Speaker

Description	Spare part number
Speaker	689384-001

The speaker is secured to the front of the chassis between the fan and the I/O ports. Remove the screws from the outside and then remove the speaker from the inside.

1. Prepare the computer for disassembly ([Preparation for disassembly on page 141](#)).
2. Remove the access panel ([Access panel on page 142](#)).
3. Remove the front bezel ([Front bezel on page 143](#)).
4. Disconnect the speaker cable from the white system board connector labeled SPKR.
5. On the outside of the chassis, remove the two Torx T8 screws that secure the speaker to the chassis **(1)**, and then from the inside of the chassis, slide the speaker up to remove it **(2)**.



To install the speaker, reverse the removal procedure.

Heat sink

Description	Spare part number
Heat sink	587456-001

The heat sink is secured by four Torx screws. It does not have an attached fan.

1. Prepare the computer for disassembly ([Preparation for disassembly on page 141](#)).
2. Remove the access panel ([Access panel on page 142](#)).
3. Lift the front fan up and place it on top of the optical drive to access the front bezel release tabs. You do not need to disconnect the fan cable from the system board.
4. Loosen the four Torx T15 screws that secure the heat sink to the system board, and then lift the heat sink from the system board.



⚠ CAUTION: Heat sink retaining screws should be removed in diagonally opposite pairs (as in an X) to even the downward forces on the processor to avoid damage that could require replacing the system board.

5. Lay the heat sink on its top in a safe area to prevent the thermal grease from contaminating the work surface.

If reusing the existing heat sink go to step 1.

If using a new heat sink, go to step 3.

1. If reusing the existing heat sink, clean bottom of the heat sink and apply the thermal material provided in the spares kit to the top of the processor.
2. Position the heat sink atop the processor.
3. If using a new heat sink, remove the protective covering from the bottom of the heat sink and place it in position atop the processor.
4. Secure the heat sink to the system board and system board tray with the 4 captive screws.

 **CAUTION:** Heat sink retaining screws should be tightened in diagonally opposite pairs (as in an X) to evenly seat the heat sink on the processor. This is especially important as the pins on the socket are very fragile and any damage to them may require replacing the system board.

Processor

Description	Spare part number
Intel Core i7 4770s, 3.4 GHz, 8-MB L3 cache	732507-001
Intel Core i5 4670s, 3.1 GHz, 6-MB L3 cache	732506-001
Intel Core i5 4570s, 2.9 GHz, 6-MB L3 cache	732505-001

1. Prepare the computer for disassembly ([Preparation for disassembly on page 141](#)).
2. Remove the access panel ([Access panel on page 142](#)).
3. Remove the heat sink ([Heat sink on page 157](#)).
4. Rotate the processor locking lever to its full open position **(1)**.
5. Raise and rotate the microprocessor retainer to its fully open position **(2)**.
6. Carefully lift the processor from the socket **(3)**.

⚠ CAUTION: Do NOT handle the pins in the processor socket. These pins are very fragile and handling them could cause irreparable damage. Once pins are damaged it may be necessary to replace the system board.

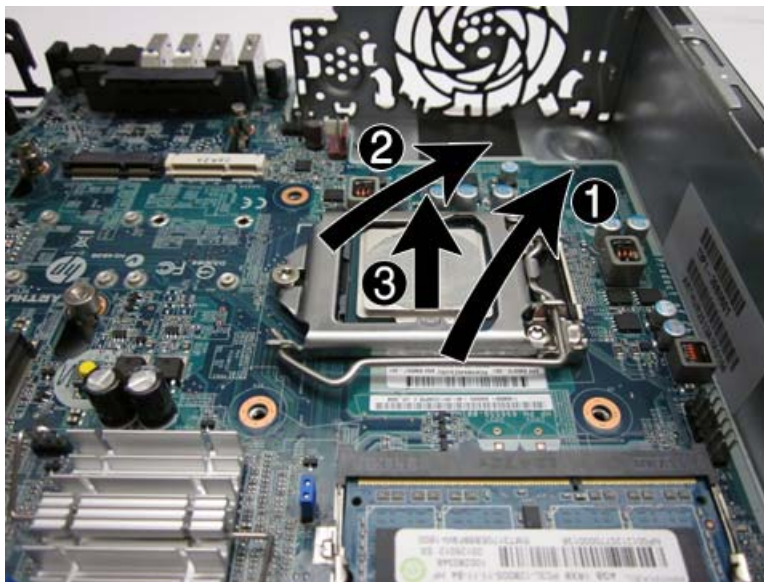

To install the processor, reverse the removal procedures.

📝 NOTE: After installing a new processor onto the system board, always update the system ROM to ensure that the latest version of the BIOS is being used on the computer. The latest system BIOS can be found on the Web at: <http://www8.hp.com/us/en/support-drivers.html>.

Smart Cover Lock (solenoid lock)

Description	Spare part number
Solenoid lock	732772-001

 **NOTE:** The Smart Cover Lock is an optional feature included on some models only.

The Smart Cover Lock is a software-controllable cover lock, controlled by the setup password. This lock prevents unauthorized access to the internal components. The computer ships with the Smart Cover Lock in the unlocked position.

If you enable the Smart Cover Lock and cannot enter your password to disable the lock, you will need a Smart Cover FailSafe Key to open the computer cover. You will need the key to access the internal computer components in any of the following circumstances:

- Power outage
- Startup failure
- PC component (for example, processor or power supply) failure
- Forgotten password

 **NOTE:** The Smart Cover FailSafe Key is a specialized tool available from HP. Be prepared; order this key before you need it.

To obtain a FailSafe Key:

- Contact an authorized HP reseller or service provider. Order PN 166527-001 for the wrench-style key or PN 166527-002 for the screwdriver bit key.
- Refer to the HP Web site (<http://www.hp.com>) for ordering information.
- Call the appropriate number listed in the warranty.

The solenoid lock is mounted to the back of the computer. Remove it using one security screw on the outside of the computer.

1. Prepare the computer for disassembly ([Preparation for disassembly on page 94](#)).
2. Remove the access panel ([Access panel on page 95](#)).

3. From the outside, rear side of the chassis, remove the silver security screw that secures the lock to the chassis.

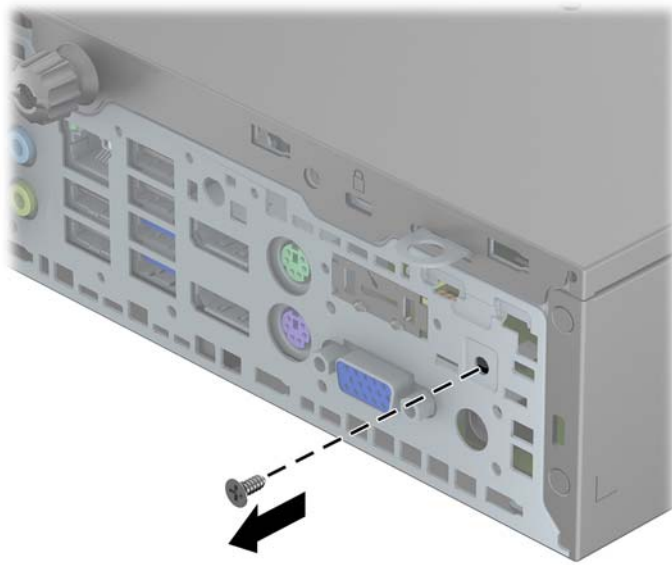

4. From the inside of the chassis, lift the lock up to gain access to the system board connector.



5. Disconnect the cable from the system board connector labeled HLOCK.

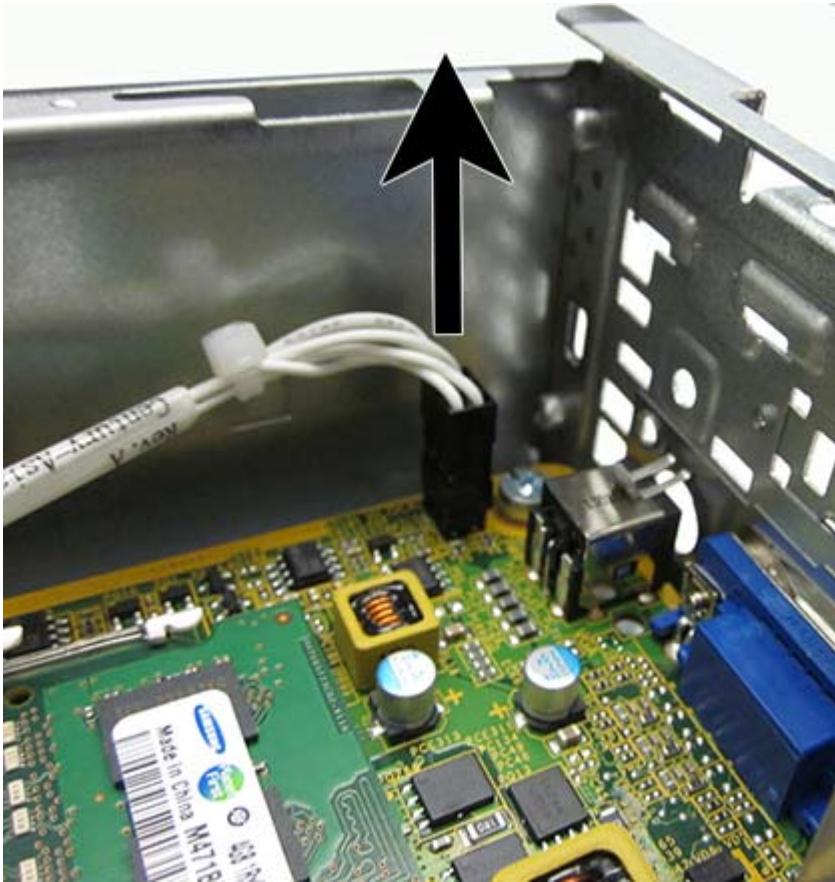

To install the Smart Cover Lock, reverse the removal procedure.

Refer to the following image for the location of the slots on the back of the chassis in which to install the lock. When installing, insert the top tabs into the top slots, and then rotate the lock downward. Then install the security screw on the outside of the computer. Plug the connector into the system board connector.

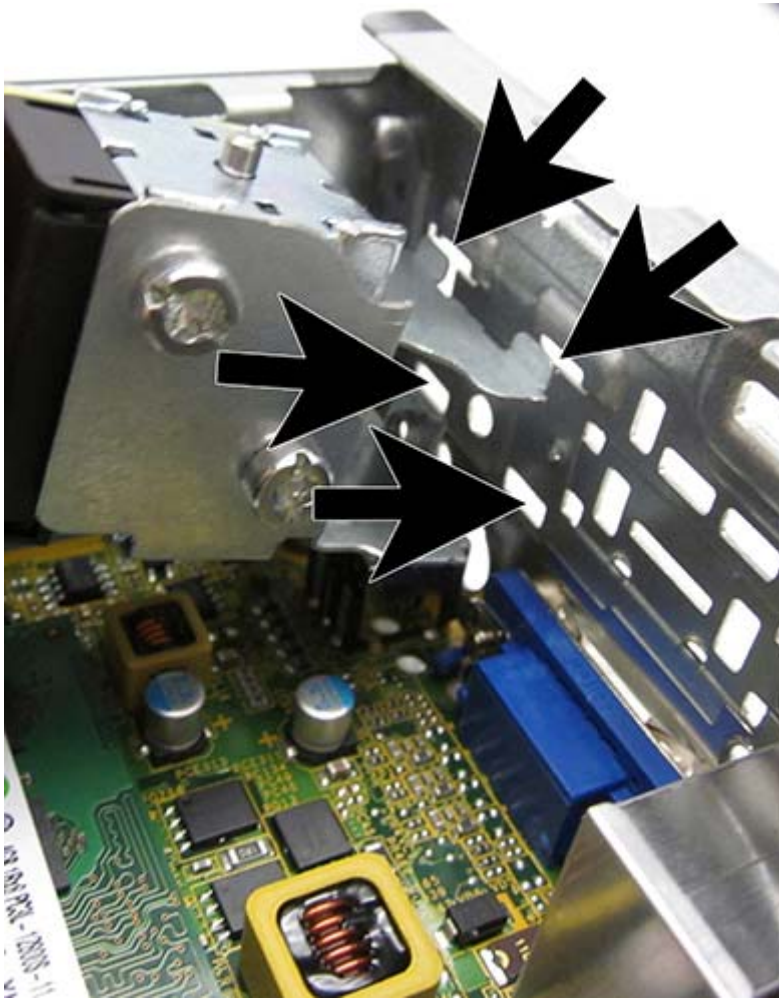

Drive cage

Description	Spare part number
Drive cage	732761-001

The drive cage sits behind the USB ports on the front of the chassis.

1. Prepare the computer for disassembly ([Preparation for disassembly on page 141](#)).
2. Remove the access panel ([Access panel on page 142](#)).
3. Remove the optical drive ([Removing the optical drive on page 151](#)).
4. Remove the hard drive ([Hard drive on page 154](#)).
5. Remove the two Torx screws that secure cage to the chassis **(1)**, lift the tab **(2)** on the cage, slide the cage toward the rear of the unit **(3)**, and then pull the cage up and out of the chassis.

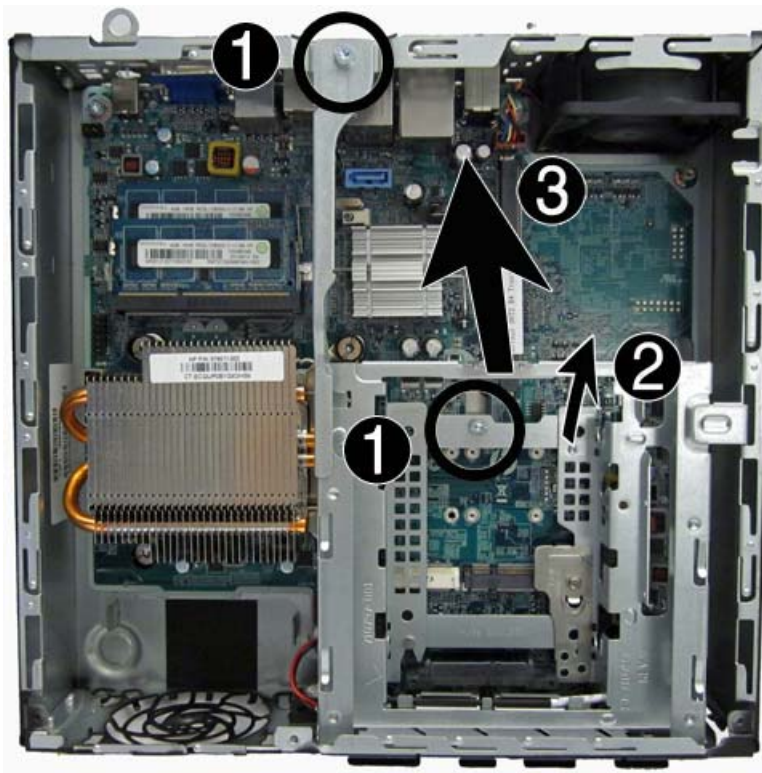

To install the drive cage, reverse the removal procedures.

Hood sensor

Description	Spare part number
Hood sensor	638816-001

1. Prepare the computer for disassembly ([Preparation for disassembly on page 141](#)).
2. Remove the access panel ([Access panel on page 142](#)).
3. Remove the optical drive ([Removing the optical drive on page 151](#)).
4. Remove the hard drive ([Hard drive on page 154](#)).
5. Remove the drive cage ([Drive cage on page 164](#)).
6. Remove the optical drive ([Removing the optical drive on page 151](#)).
7. Unplug the hood sensor cable from the white system board connector labeled HSENSE **(1)** and remove the cable from the white clip mounted on the inside chassis wall **(2)**.
8. Slide the hood sensor into the chassis to remove it from its slot **(3)**. Disengaging the hood sensor from the chassis may require use of a screwdriver or similar tool.

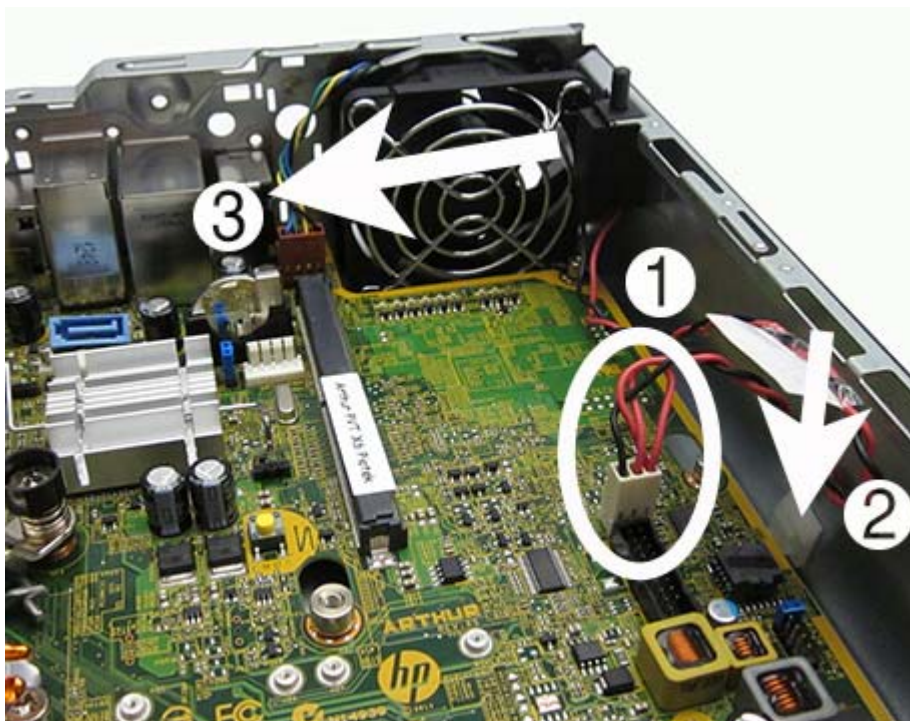

To install the hood sensor, reverse the removal procedures.

Card reader

Description	Spare part number
Card reader	xxxxxx-001

The card reader is secured to the front right corner of the chassis.

1. Prepare the computer for disassembly ([Preparation for disassembly on page 141](#)).
2. Remove the access panel ([Access panel on page 142](#)).
3. Remove the front bezel ([Front bezel on page 143](#)).
4. Remove the optical drive ([Removing the optical drive on page 151](#)).
5. Remove the hard drive ([Hard drive on page 154](#)).
6. Remove the drive cage ([Drive cage on page 164](#)).
7. Disconnect the cable from the system board connector labeled MEDIA.
8. On the outside of the chassis, remove the one Torx screw that secures the card reader to the chassis.



9. Pull the reader away from the front of the chassis while threading the cable through the slot in the front of the chassis.



To install the card reader, reverse the removal procedure.

WLAN module

Description	Spare part number
HP WLAN 802.11 a/b/g/n 2x2 PCIe NIC	695915-001

1. Prepare the computer for disassembly ([Preparation for disassembly on page 141](#)).
2. Remove the access panel ([Access panel on page 142](#)).
3. Remove the optical drive ([Removing the optical drive on page 151](#)).
4. Remove the hard drive ([Hard drive on page 154](#)).
5. Remove the drive cage ([Drive cage on page 164](#)).
6. Disconnect the two antenna cables from the connectors on the module (**1**).
7. Remove the two Phillips screws (**2**) that secure the module to the system board.
8. Lift the module to a 45 degree angle, and then remove the module from the connector by pulling it away at an angle (**3**).

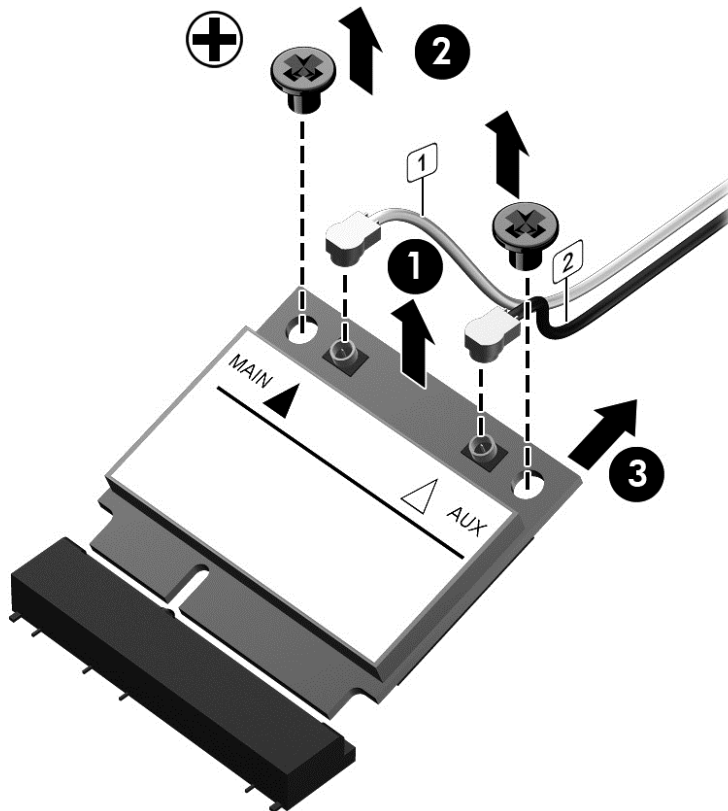

To install the WLAN module, reverse the removal procedure. Make sure the antenna cables are correctly routed.

Graphics board

Description	Spare part number
AMD Radeon HD 7650A 2GB MXM Graphics	708866-001

CAUTION: Be very careful when removing or replacing the system board to prevent damaging it.

1. Prepare the computer for disassembly ([Preparation for disassembly on page 141](#)).
2. Remove the access panel ([Access panel on page 142](#)).
3. Remove the optical drive ([Removing the optical drive on page 151](#)).
4. Remove the hard drive ([Hard drive on page 154](#)).
5. Remove the drive cage ([Drive cage on page 164](#)).
6. Remove the two Torx T8 screws **(1)** that secure the graphics board to the system board, rotate the board upward to a 45-degree angle **(2)**, and then pull it away from the system board connector and out of the computer **(3)**.

NOTE: Graphics card appearance may vary.

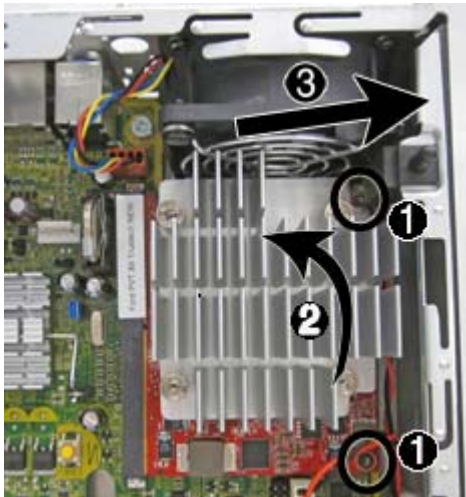

To install the graphics board, reverse the removal procedure.

If you need to remove the heat sink from the graphics board, loosen the four captive Torx screws that secure the heat sink from the graphics board, and then lift the heat sink from the graphics board.

Power switch

Description	Spare part number
Power switch	732767-001

1. Prepare the computer for disassembly ([Preparation for disassembly on page 141](#)).
2. Remove the access panel ([Access panel on page 142](#)).
3. Remove the front bezel ([Front bezel on page 143](#)).
4. Remove the optical drive ([Removing the optical drive on page 151](#)).
5. Remove the hard drive ([Hard drive on page 154](#)).
6. Remove the drive cage ([Drive cage on page 164](#)).
7. Disconnect the power switch cable from the system board connector labeled PB/LED.
8. Remove the power switch cable from atop the front I/O bracket.
9. From the front of the computer, press down (or squeeze) on the top on the power switch **(1)**, and then rotate it down **(2)** to disengage it from the chassis.

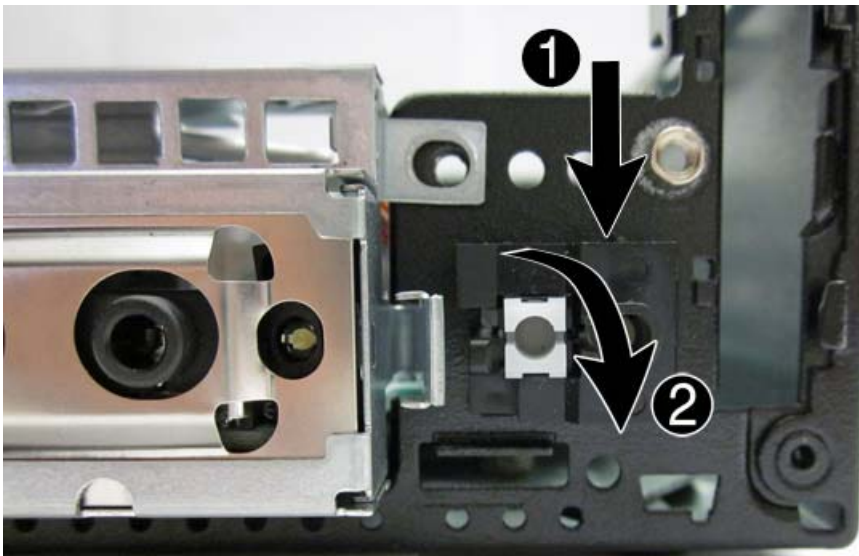

10. Pull the power switch and cable assembly out through the hole in the front of the chassis.

To install the power switch, reverse the removal procedure.

System board

Description	Spare part number
System board for use in models without Windows 8	696970-001
System board for use in models with Windows 8 Standard	696970-501
System board for use in models with Windows 8 Professional	696970-601
System board for use in NetClone models	727721-001
Front I/O panel	732762-001

⚠ CAUTION: Be very careful when removing or replacing the system board to prevent damaging it.

1. Prepare the computer for disassembly ([Preparation for disassembly on page 141](#)).
2. Remove the access panel ([Access panel on page 142](#)).
3. Remove the memory modules ([Memory on page 147](#)).
4. Remove the front fan ([Front fan on page 150](#)).
5. Remove the optical drive ([Removing the optical drive on page 151](#)).
6. Remove the hard drive ([Hard drive on page 154](#)).
7. Remove the drive cage ([Drive cage on page 164](#)).
8. Remove the heat sink ([Heat sink on page 157](#)).
9. Disconnect the rear fan cable from the system board.
10. Remove the power button cable from atop the front I/O panel.
11. Disconnect any remaining cables connected to the system board, noting their location for reinstallation.
12. Remove the front I/O panel:
 - a. Remove the Torx T15 screw from the right side of the panel that secures it to the front of the chassis.



- b. Press the tab on right side of the panel **(1)**, and then swing the right side of the cage away from the chassis to remove it **(2)**.

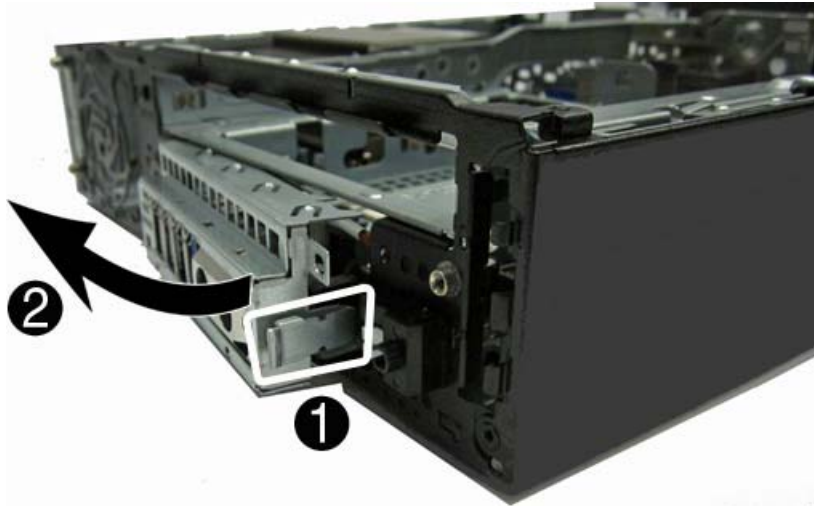

- 13.** Remove the three remaining Torx T15 screws that secure the system board to the chassis.



- 14.** Slide system board toward the front of the unit until the rear connectors are clear of their slots in the chassis **(1)**.

15. Lift the rear of the system board until it clears the chassis, and then remove the system board from the chassis **(2)**.

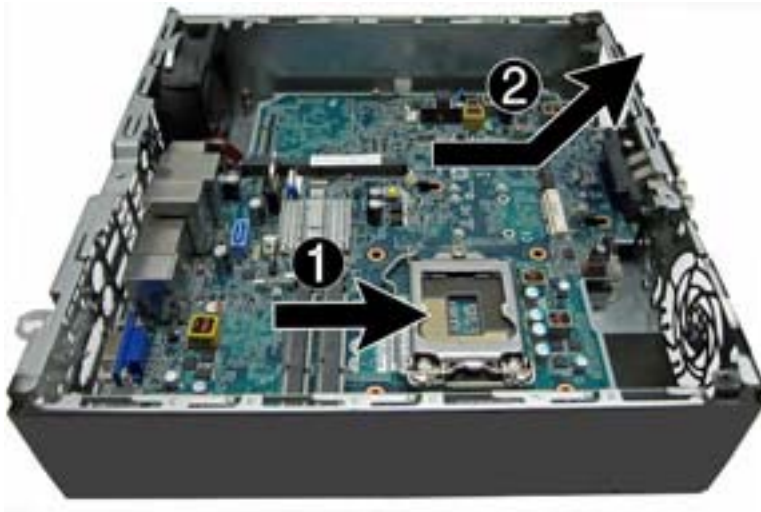

To install the system board, reverse the removal procedure.

 **NOTE:** When replacing the system board, you must also change the chassis serial number in the BIOS.

Rear fan

Description	Spare part number
Rear fan	732766-001

The rear fan is secured to the rear right corner of the chassis. You must remove the system board before you can remove the rear fan.

1. Prepare the computer for disassembly ([Preparation for disassembly on page 141](#)).
2. Remove the access panel ([Access panel on page 142](#)).
3. Remove the optical drive ([Removing the optical drive on page 151](#)).
4. Remove the front fan ([Front fan on page 150](#)).
5. Remove the hard drive ([Hard drive on page 154](#)).
6. Remove the drive cage ([Drive cage on page 164](#)).
7. Remove the heat sink ([Heat sink on page 157](#)).
8. Remove the system board ([System board on page 171](#)).

9. From the outside of the chassis, remove the four Phillips screws that secure the fan to the chassis.

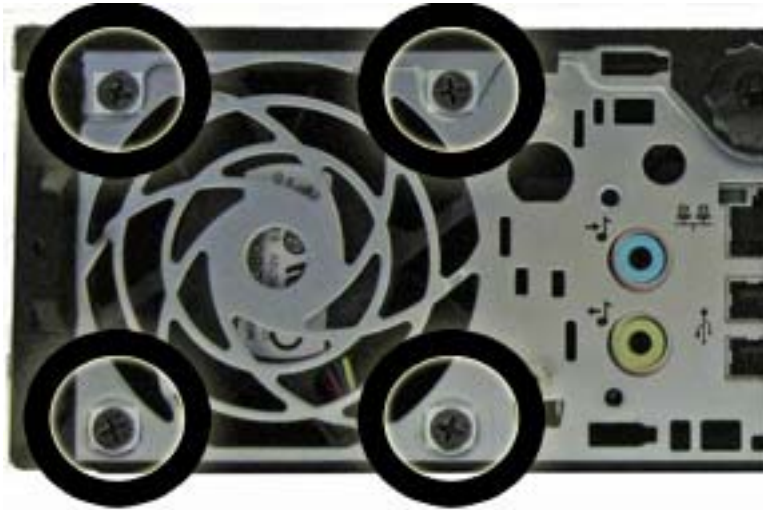

10. From the inside of the chassis, slide the fan out from underneath the chassis lip, and then remove the fan.



To install the rear fan, reverse the removal procedure.

Antennas

Two antennas are secured to chassis – one on the front, one on the back. You must remove all other components to remove the antennas.

1. Prepare the computer for disassembly ([Preparation for disassembly on page 141](#)).
2. Remove the access panel ([Access panel on page 142](#)).
3. Remove the optical drive ([Removing the optical drive on page 151](#)).
4. Remove the front fan ([Front fan on page 150](#)).
5. Remove the hard drive ([Hard drive on page 154](#)).

6. Remove the drive cage ([Drive cage on page 164](#)).
7. Remove the heat sink ([Heat sink on page 157](#)).
8. Remove the system board ([System board on page 171](#)).
9. Remove the rear fan ([Rear fan on page 173](#)).
10. To remove the front antenna, from the inside of the front of the chassis, remove the antenna from the clips built into the base pan.



11. From the outside of the front of the chassis, remove the two Torx T8 screws **(1)** that secure the antenna to the chassis.

- 12.** Pull the antenna out of the clips on the front of the chassis (**2**), and then pull the antenna out of the hole it routes through (**3**).

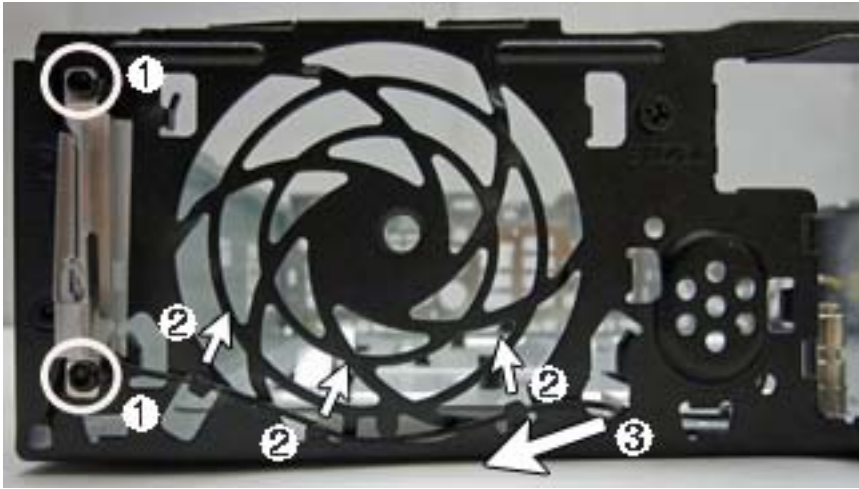

- 13.** To remove the rear antenna, from the inside of the front of the chassis, remove the antenna from the plastic clips attached to the side of the chassis.

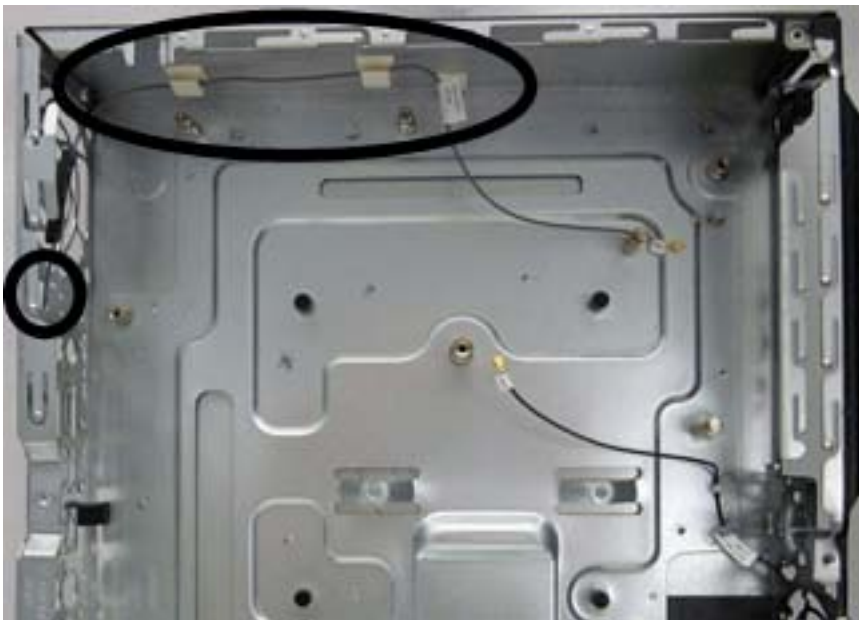

14. From the outside of the rear of the chassis, remove the two Torx T8 screws that secure the antenna to the chassis.



15. Pull the antenna through the hole it routes through.

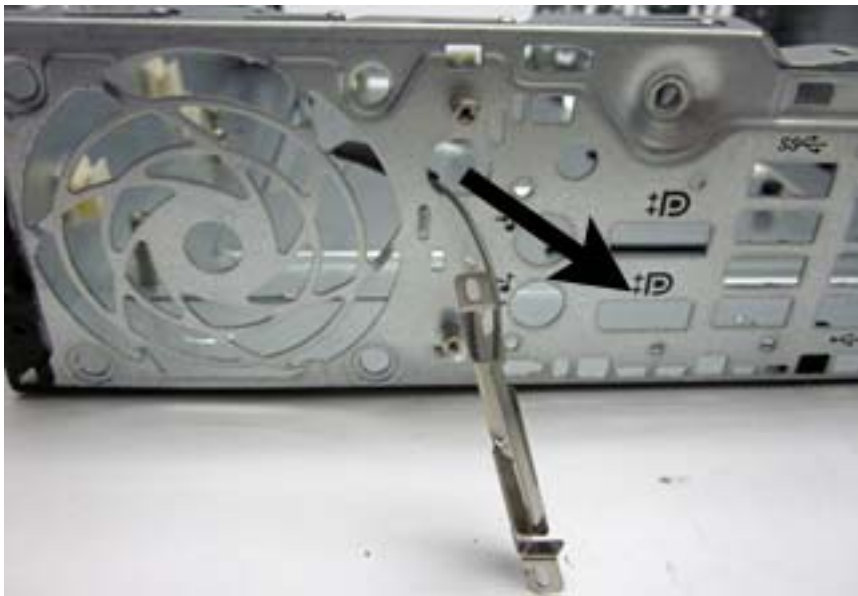

To install the rear fan, reverse the removal procedure.

Changing from desktop to tower configuration

The Ultra-slim Desktop can be used in a tower orientation with the tower stand included with the computer.

1. Remove/disengage any security devices that prohibit opening the computer.
2. Remove all removable media, such as compact discs or USB flash drives, from the computer.
3. Turn off the computer properly through the operating system, then turn off any external devices.
4. Disconnect the power cord from the power outlet and disconnect any external devices.

CAUTION: Regardless of the power-on state, voltage is always present on the system board as long as the system is plugged into an active AC outlet. You must disconnect the power cord to avoid damage to the internal components of the computer.

5. Orient the computer so that its left side is facing down and place the computer firmly down into the stand.



6. Reconnect the external equipment, plug the power cord into a power outlet, and turn the computer on.

NOTE: Ensure at least 10.2 centimeters (4 inches) of space on all sides of the computer remains clear and free of obstructions.

NOTE: An optional Quick Release mounting bracket is available from HP for mounting the computer to a wall, desk, or swing arm. When the mounting bracket is used, do not install the computer with the I/O ports oriented towards the ground.

Port cover

Description	Spare part number
Port cover	588981-001

An optional rear port cover is available for the computer.

To install the port cover:

1. Thread the cables through the bottom hole on the port cover (1) and connect the cables to the rear ports on the computer.
2. Insert the hooks on the port cover into the slots on the rear of the chassis, then slide the cover to the right to secure it in place (2).

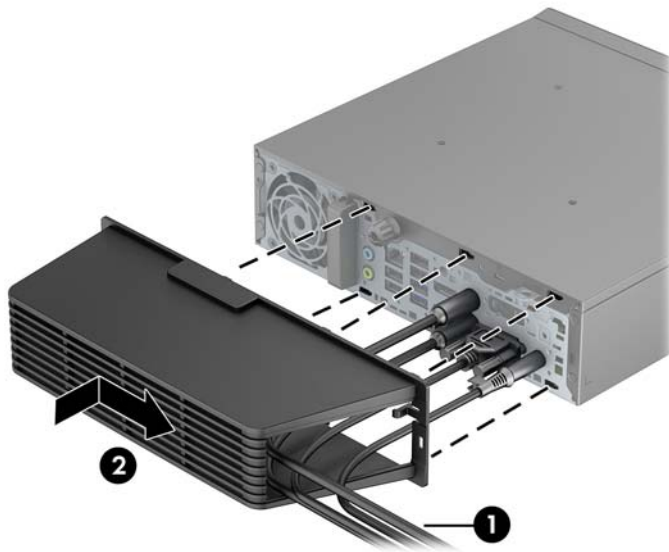

 **NOTE:** For security purposes, you can install an optional cable lock to the chassis that locks the port cover and secures the computer.

The port cover is secured in place by a retention lever just inside the port cover opening. To remove the port cover, pull the lever back towards the port cover opening (1), then slide the cover to the left and off the computer (2).

Power supply, external

The USDT chassis uses an external power supply.

 **WARNING!** To reduce potential safety issues, only the power supply provided with the computer, a replacement power supply provided by HP, or a power supply purchased as an accessory from HP should be used with the computer.

8 Computer Setup (F10) Utility

Computer Setup (F10) Utilities

Use Computer Setup (F10) Utility to do the following:

- Change factory default settings.
- Set the system date and time.
- Set, view, change, or verify the system configuration, including settings for processor, graphics, memory, audio, storage, communications, and input devices.
- Modify the boot order of bootable devices such as hard drives, optical drives, or USB flash media devices.
- Enable Quick Boot, which is faster than Full Boot but does not run all of the diagnostic tests run during a Full Boot. You can set the system to:
 - always Quick Boot (default);
 - periodically Full Boot (from every 1 to 30 days); or
 - always Full Boot.
- Select Post Messages Enabled or Disabled to change the display status of Power-On Self-Test (POST) messages. Post Messages Disabled suppresses most POST messages, such as memory count, product name, and other non-error text messages. If a POST error occurs, the error is displayed regardless of the mode selected. To manually switch to Post Messages Enabled during POST, press any key (except F1 through F12).
- Establish an Ownership Tag, the text of which is displayed each time the system is turned on or restarted.
- Enter the Asset Tag or property identification number assigned by the company to this computer.
- Enable the power-on password prompt during system restarts (warm boots) as well as during power-on.
- Establish a setup password that controls access to the Computer Setup (F10) Utility and the settings described in this section.
- Secure integrated I/O functionality, including the serial, USB, or parallel ports, audio, or embedded NIC, so that they cannot be used until they are unsecured.

- Enable or disable removable media boot ability.
- Solve system configuration errors detected but not automatically fixed during the Power-On Self-Test (POST).
- Replicate the system setup by saving system configuration information on a USB device and restoring it on one or more computers.
- Execute self-tests on a specified ATA hard drive (when supported by drive).
- Enable or disable DriveLock security (when supported by drive).

Using Computer Setup (F10) Utilities

Computer Setup can be accessed only by turning the computer on or restarting the system. To access the Computer Setup Utilities menu, complete the following steps:

1. Turn on or restart the computer.
2. Repeatedly press **F10** when the monitor light turns green to access the utility.

You can also press **Esc** to a menu that allows you to access different options available at startup, including the Computer Setup utility.

 **NOTE:** If you do not press **F10** at the appropriate time, you must restart the computer and again repeatedly press **F10** when the monitor light turns green to access the utility.

3. A choice of five headings appears in the Computer Setup Utilities menu: File, Storage, Security, Power, and Advanced.
4. Use the arrow (left and right) keys to select the appropriate heading. Use the arrow (up and down) keys to select the option you want, then press **Enter**. To return to the Computer Setup Utilities menu, press **Esc**.
5. To apply and save changes, select **File > Save Changes and Exit**.
 - If you have made changes that you do not want applied, select **Ignore Changes and Exit**.
 - To reset to factory settings or previously saved default settings (some models), select **Apply Defaults and Exit**. This option will restore the original factory system defaults.

 **NOTE:** Not all settings shown in the following sections are available for all models

 **CAUTION:** Do NOT turn the computer power OFF while the BIOS is saving the Computer Setup (F10) changes because the CMOS could become corrupted. It is safe to turn off the computer only after exiting the F10 Setup screen.

Computer Setup—File



NOTE: Support for specific Computer Setup options may vary depending on the hardware configuration.

Table 8-1 Computer Setup—File

Option	Description
System Information	Lists: <ul style="list-style-type: none">• Product name• SKU number• Processor type/speed/stepping• Cache size (L1/L2/L3) (dual core processors have this listed twice)• Installed memory size/speed, number of channels (single or dual) (if applicable)• Integrated MAC address for embedded, enabled NIC (if applicable)• System BIOS (includes family name and version)• Chassis serial number• Asset tracking number• ME firmware version• ME Management mode
About	Displays copyright notice.
Set Time and Date	Allows you to set system time and date.
Flash System ROM	Allows you to update the system ROM with a BIOS image file located on removable media.
Replicated Setup	Save to Removable Media Saves system configuration to a formatted USB flash media device. Restore from Removable Media Restores system configuration from a USB flash media device.
Default Setup	Save Current Settings as Default Saves the current system configuration settings as the default. Restore Factory Settings as Default Restores the factory system configuration settings as the default.
Apply Defaults and Exit	Applies the currently selected default settings and clears any established passwords.
Ignore Changes and Exit	Exits Computer Setup without applying or saving any changes.
Save Changes and Exit	Saves changes to system configuration or default settings and exits Computer Setup.

Computer Setup—Storage



NOTE: Support for specific Computer Setup options may vary depending on the hardware configuration.

Table 8-2 Computer Setup—Storage

Option	Description
Device Configuration	<p>Lists all installed BIOS-controlled storage devices.</p> <p>When a device is selected, detailed information and options are displayed. The following options may be presented:</p> <ul style="list-style-type: none">• Hard Disk: Size, model, firmware version, serial number, connector color. <p>Translation mode (ATA disks only)</p> <p>Lets you select the translation mode to be used for the device. This enables the BIOS to access disks partitioned and formatted on other systems and may be necessary for users of older versions of UNIX (e.g., SCO UNIX version 3.2). Options are Automatic, Bit-Shift, LBA Assisted, User, and Off.</p> <p>Available only when the drive translation mode is set to User, allows you to specify the parameters (logical cylinders, heads, and sectors per track) used by the BIOS to translate disk I/O requests (from the operating system or an application) into terms the hard drive can accept. Logical cylinders may not exceed 1024. The number of heads may not exceed 256. The number of sectors per track may not exceed 63.</p> <p>CAUTION: Ordinarily, the translation mode selected automatically by the BIOS should not be changed. If the selected translation mode is not compatible with the translation mode that was active when the disk was partitioned and formatted, the data on the disk will be inaccessible.</p> <ul style="list-style-type: none">• CD-ROM: Model, firmware version, serial number, connector color (not included for USB CD-ROM).• SSD Life Used <p>NOTE: Displays for solid-state drives.</p> <ul style="list-style-type: none">• SMART (ATA disks only)• Diskette: Model and firmware version. <p>NOTE: Displays for USB diskette drives.</p> <ul style="list-style-type: none">• Default Values (ATA disks only) <p>See Translation Mode above for details.</p> <p>SATA Defaults</p>

Table 8-2 Computer Setup—Storage (continued)

Storage Options

SATA Emulation

Allows you to choose how the SATA controller and devices are accessed by the operating system. There are three supported options: IDE, RAID, and AHCI (default).

CAUTION: SATA emulation changes may prevent access to existing hard drive data and degrade or corrupt established volumes.

IDE - This is the most backwards-compatible setting of the three options. Operating systems usually do not require additional driver support in IDE mode.

RAID - Allows DOS and boot access to RAID volumes. Use this mode with the RAID device driver loaded in the operating system to take advantage of RAID features.

AHCI (default option) - Allows operating systems with AHCI device drivers loaded to take advantage of more advanced features of the SATA controller.

NOTE: The RAID/AHCI device driver must be installed prior to attempting to boot from a RAID/AHCI volume. If you attempt to boot from a RAID/AHCI volume without the required device driver installed, the system will crash (blue screen). RAID volumes may become corrupted if they are booted to after disabling RAID.

Removable Media Boot

Enables/disables ability to boot the system from removable media. Default is enabled.

Table 8-2 Computer Setup—Storage (continued)

DPS Self-Test	<p>Allows you to execute self-tests on ATA hard drives capable of performing the Drive Protection System (DPS) self-tests.</p> <p>NOTE: This selection will only appear when at least one drive capable of performing the DPS self-tests is attached to the system.</p>
Boot Order	<p>Allows you to:</p> <ul style="list-style-type: none">• EFI Boot Sources: Specify the order in which EFI boot sources (such as a internal hard drive, USB hard drive, USB optical drive, or internal optical drive) are checked for a bootable operating system image. Each device on the list may be individually excluded from or included for consideration as a bootable operating system source. <p>EFI boot sources always have precedence over legacy boot sources.</p> <ul style="list-style-type: none">• Legacy Boot Sources: Specify the order in which legacy boot sources (such as a network interface card, internal hard drive, USB optical drive, or internal optical drive) are checked for a bootable operating system image. Each device on the list may be individually excluded from or included for consideration as a bootable operating system source. <p>Specify the order of attached hard drives. The first hard drive in the order will have priority in the boot sequence and will be recognized as drive C (if any devices are attached).</p> <p>NOTE: To drag a device to a preferred place, press Enter. To remove the device from consideration as a bootable device, press F5.</p> <p>You can use F5 to disable individual boot items, as well as disable EFI boot and/or legacy boot.</p> <p>NOTE: MS-DOS drive lettering assignments may not apply after a non-MS-DOS operating system has started.</p> <p>Shortcut to Temporarily Override Boot Order</p> <p>To boot one time from a device other than the default device specified in Boot Order, restart the computer and press Esc (to access the boot menu) and then F9 (Boot Order), or only F9 (skipping the boot menu) when the monitor light turns green. After POST is completed, a list of bootable devices is displayed. Use the arrow keys to select the preferred bootable device and press Enter. The computer then boots from the selected non-default device for this one time.</p>

Computer Setup—Security



NOTE: Support for specific Computer Setup options may vary depending on the hardware configuration.

Table 8-3 Computer Setup—Security

Option	Description
Setup Password	<p>Allows you to set and enable a setup (administrator) password.</p> <p>NOTE: If the setup password is set, it is required to change Computer Setup options, flash the ROM, and make changes to certain plug and play settings under Windows.</p>
Power-On Password	<p>Allows you to set and enable a power-on password. The power-on password prompt appears after a power cycle or reboot. If the user does not enter the correct power-on password, the unit will not boot.</p>
Password Options	<p>Allows you to enable/disable:</p> <p>(This selection appears only if a power-on password or setup password is set.)</p> <ul style="list-style-type: none">• Lock Legacy Resources (determines whether or not Windows Device Manager is allowed to change resource settings for serial and parallel ports).• Stringent security (enabling the stringent password disables the ability to reset the password by moving the jumper on the system board). Default is disabled. <p>CAUTION: If you enable the stringent security feature and you forget the setup password or the power-on password, the computer is inaccessible and can no longer be used.</p> <p>If you lose or forget the password, the system board must be replaced. This scenario is not covered under warranty.</p> <p>To prevent the computer from becoming permanently unusable, record your configured setup password or power-on password in a safe place away from your computer. Without these passwords, the computer cannot be unlocked.</p> <ul style="list-style-type: none">• Setup Browse Mode (appears if a setup password is set) (allows viewing, but not changing, the F10 Setup Options without entering setup password). Default is enabled.• Password prompt on F9 & F12 (requires setup password to use these boot functions). Default is enabled.• Network Server Mode. Default is disabled.
Smart Cover	<p>Allows you to:</p> <ul style="list-style-type: none">• Lock/unlock the Cover Lock.• Set the Cover Removal Sensor to Disable/Notify User/Setup Password. <p>NOTE: <i>Notify User</i> alerts the user that the sensor has detected that the cover has been removed. <i>Setup Password</i> requires that the setup password be entered to boot the computer if the sensor detects that the cover has been removed.</p>

Table 8-3 Computer Setup—Security (continued)

Device Security	Allows you to set Device Available/Device Hidden (default is Device Available) for: <ul style="list-style-type: none">• Embedded security device• System audio• USB controller (varies by model)• Network controller <p>NOTE: You must disable AMT before trying to hide the network controller.</p> <ul style="list-style-type: none">• Serial port• Parallel port• SATA ports (varies by model)
USB Security	Allows you to set Enabled/Disabled (default is Enabled) for: <ul style="list-style-type: none">• Front USB Ports• Rear USB Ports• Accessory USB Ports
Slot Security	Allows you to disable any PCI or PCI Express slot. Default is enabled.
Network Boot	Enables/disables the computer's ability to boot from an operating system installed on a network server. (Feature available on NIC models only; the network controller must be either a PCI expansion card or embedded on the system board.) Default is enabled.
System IDs	Allows you to set: <ul style="list-style-type: none">• Asset tag (18-byte identifier), a property identification number assigned by the company to the computer.• Ownership tag (80-byte identifier) displayed during POST.• Universal Unique Identifier (UUID) number. The UUID can only be updated if the current chassis serial number is invalid. (These ID numbers are normally set in the factory and are used to uniquely identify the system.)• Keyboard locale setting for System ID entry.

Table 8-3 Computer Setup—Security (continued)

Master Boot Record Security

Enables/disables Master Boot Record (MBR) security.

The MBR contains information needed to successfully boot from a disk and to access the data stored on the disk. Master Boot Record Security may prevent unintentional or malicious changes to the MBR, such as those caused by some viruses or by the incorrect use of certain disk utilities. It also allows you to recover the "last known good" MBR, should changes to the MBR be detected when the system is restarted.

When MBR Security is enabled, the BIOS prevents any changes being made to the MBR of the current bootable disk while in MS-DOS or Windows Safe Mode.

NOTE: Most operating systems control access to the MBR of the current bootable disk; the BIOS cannot prevent changes that may occur while the operating system is running.

Restores the backup Master Boot Record to the current bootable disk. Default is disabled.

Only appears if all of the following conditions are true:

- MBR security is enabled
- A backup copy of the MBR has been previously saved
- The current bootable disk is the same disk from which the backup copy was saved

CAUTION: Restoring a previously saved MBR after a disk utility or operating system has modified the MBR, may cause the data on the disk to become inaccessible. Only restore a previously saved MBR if you are confident that the current bootable disk's MBR has been corrupted or infected with a virus.

Table 8-3 Computer Setup—Security (continued)

System Security (these options are hardware dependent)	<p>Data Execution Prevention (enable/disable) - Helps prevent operating system security breaches. Default is enabled.</p> <p>SVM CPU Virtualization (enable/disable). Controls the virtualization features of the processor. Changing this setting requires turning the computer off and then back on. Default is disabled.</p> <p>Virtualization Technology (VTx) (enable/disable) - Controls the virtualization features of the processor. Changing this setting requires turning the computer off and then back on. Default is disabled.</p> <p>Virtualization Technology Directed I/O (VTd) (enable/disable) - Controls virtualization DMA remapping features of the chipset. Changing this setting requires turning the computer off and then back on. Default is disabled.</p> <p>Trusted Execution Technology (enable/disable) - Controls the underlying processor and chipset features needed to support a virtual appliance. Changing this setting requires turning the computer off and then back on. Default is disabled. To enable this feature you must enable the following features:</p> <ul style="list-style-type: none">• Embedded Security Device Support• Virtualization Technology• Virtualization Technology Directed I/O <p>Embedded Security Device (enable/disable) - Permits activation and deactivation of the Embedded Security Device.</p> <p>NOTE: To configure the Embedded Security Device, a Setup password must be set.</p> <ul style="list-style-type: none">• Reset to Factory Settings (Do not reset/Reset) - Resetting to factory defaults will erase all security keys and leave the device in a disabled state. Changing this setting requires that you restart the computer. Default is Do not reset. <p>CAUTION: The embedded security device is a critical component of many security schemes. Erasing the security keys will prevent access to data protected by the Embedded Security Device. Choosing Reset to Factory Settings may result in significant data loss.</p> <ul style="list-style-type: none">• Measure boot variables/devices to PCR1 - Typically, the computer measures the boot path and saves collected metrics to PCR5 (a register in the Embedded Security Device). Bitlocker tracks changes to any of these metrics, and forces the user to re-authenticate if it detects any changes. Enabling this feature lets you set Bitlocker to ignore detected changes to boot path metrics, thereby avoiding re-authentication issues associated with USB keys inserted in a port. Default is enabled.
--	---

Table 8-3 Computer Setup—Security (continued)

System Security (continued)	<p>OS management of Embedded Security Device (enable/disable) - This option allows the user to limit OS control of the Embedded Security Device. Default is enabled. This option is automatically disabled if Trusted Execution Technology is enabled.</p> <ul style="list-style-type: none">Reset of Embedded Security Device through OS (enable/disable) - This option allows the user to limit the operating system ability to request a Reset to Factory Settings of the Embedded Security Device. Default is disabled. <p>NOTE: To enable this option, a Setup password must be set.</p> <ul style="list-style-type: none">No PPI provisioning (Windows 8 only) - This option lets you set Windows 8 to bypass the PPI (Physical Presence Interface) requirement and directly enable and take ownership of the TPM on first boot. You cannot change this setting after TPM is owned/initialized, unless the TPM is reset. Default is disabled for non-Windows 8 systems, and enabled for Windows 8.Allow PPI policy to be changed by OS. Enabling this option allows the operating system to execute TPM operations without Physical Presence Interface. Default is disabled. <p>NOTE: To enable this option, a Setup password must be set.</p>
DriveLock Security	<p>Allows you to assign or modify a master or user password for hard drives. When this feature is enabled, the user is prompted to provide one of the DriveLock passwords during POST. If neither is successfully entered, the hard drive will remain inaccessible until one of the passwords is successfully provided during a subsequent cold-boot sequence.</p> <p>NOTE: This selection will only appear when at least one drive that supports the DriveLock feature is attached to the system.</p>
Secure Boot Configuration	<p>This is a feature of Windows 8.</p> <ul style="list-style-type: none">Legacy Support—Enable/Disable. Allows you to turn off all legacy support on the computer, including booting to DOS, running legacy graphics cards, booting to legacy devices, and so on. If set to disable, legacy boot options in Storage > Boot Order are not displayed. Default is enabled.Secure Boot—Enable/Disable. Allows you to make sure an operating system is legitimate before booting to it, making Windows resistant to malicious modification from preboot to full OS booting, preventing firmware attacks. UEFI and Windows Secure Boot only allow code signed by pre-approved digital certificates to run during the firmware and OS boot process. Default is disabled, except for Windows 8 systems which have this setting enabled. Secure Boot enabled also sets Legacy Support to disabled.Key Management—This option lets you manage the custom key settings.<ul style="list-style-type: none">Clear Secure Boot Keys—Don't Clear/Clear. Allows you to delete any previously loaded custom boot keys. Default is Don't Clear.Key Ownership—HP Keys/Custom Keys. Selecting Custom Mode allows you to modify the contents of the secure boot signature databases and the platform key (PK) that verifies kernels during system start up, allowing you to use alternative operating systems.

Table 8-3 Computer Setup—Security (continued)

Selecting HP Keys causes the computer boot using the preloaded HP-specific boot keys. Default is HP Keys.

- Fast Boot—Enable/Disable. Fast boot disables the ability to interrupt boot, such as pressing f keys to access items before the operating system loads. Default is disabled.

NOTE: If Windows 8 detects a serious error, it will interrupt the boot process automatically and display advanced boot options.

From Windows 8, you can press **Shift** and select **Restart** to access the screen that lets you boot to a device or troubleshoot your computer.

Computer Setup—Power



NOTE: Support for specific Computer Setup options may vary depending on the hardware configuration.

Table 8-4 Computer Setup—Power

Option	Description
OS Power Management	<ul style="list-style-type: none">• Idle Power Savings—Extended/Normal. Allows certain operating systems to decrease the processors power consumption when the processor is idle. Default is extended.• Runtime Power Management— Enable/Disable. Allows certain operating systems to reduce processor voltage and frequency when the current software load does not require the full capabilities of the processor. Default is enabled.• Unique Sleep State Blink Rates—Enable/Disable. This feature is designed to provide a visual indication of what sleep state the system is in. Each sleep state has a unique blink pattern. Default is disabled. <p>NOTE: For Windows 8 systems with Fast Boot support, a normal shutdown goes to the S4 state, not the S5 state.</p> <ul style="list-style-type: none">◦ S0 (On) = Solid white LED.◦ S3 (Stand By)= 3 blinks at 1Hz (50% duty cycle) followed by a pause of 2 seconds (white LED) — repeated cycles of 3 blinks and a pause.◦ S4 (Hibernation)= 4 blinks at 1Hz (50% duty cycle) followed by a pause of 2 seconds (white LED) — repeated cycles of 4 blinks and a pause.◦ S5 (Soft Off) = LED is off.

Table 8-4 Computer Setup—Power (continued)

Hardware Power Management	<p>SATA Power Management – Enables or disables SATA bus and/or device power management. Default is enabled.</p> <p>S5 Maximum Power Savings – Turns off power to all nonessential hardware when system is off to meet EUP Lot 6 requirement of less than 0.5 Watt power usage. Default is disabled.</p> <p>PCI Express x16 Slot 1 – Sets Active State Power Management (ASPM) of the bus. ASPM lets you set lower power modes that activate when the bus is not being used. Options are Disabled, L0s, L1, L0s and L1. Default is ASPM Disabled.</p> <p>PCI Express x1 Slot 1 – Sets Active State Power Management (ASPM) of the bus. ASPM lets you set lower power modes that activate when the bus is not being used. Options are Disabled, L0s, L1, L0s and L1. Default is ASPM Disabled.</p> <p>Network Controller – Sets ASPM of the bus. ASPM lets you set lower power modes that activate when the bus is not being used. Options are Disabled, L0s, L1, L0s and L1. Default is ASPM Disabled.</p> <p>USB 3.0 Controller – Sets ASPM of the bus. ASPM lets you set lower power modes that activate when the bus is not being used. Options are Disabled, L0s, L1, L0s and L1. Default is ASPM Disabled.</p>
Thermal	<p>Fan idle mode—This bar graph controls the minimum permitted fan speed.</p> <p>NOTE: This setting only changes the minimum fan speed. The fans are still automatically controlled.</p>

Computer Setup—Advanced

 **NOTE:** Support for specific Computer Setup options may vary depending on the hardware configuration.

Table 8-5 Computer Setup—Advanced (for advanced users)

Option	Heading
Power-On Options	<p>Allows you to set:</p> <ul style="list-style-type: none">• POST mode (QuickBoot, Clear Memory, FullBoot, or FullBoot Every x Days).<ul style="list-style-type: none">◦ QuickBoot (default) = Do not clear memory or perform a memory test.◦ FullBoot = Memory test (count) on cold boot. Clears memory on all boots.◦ Clear Memory = No memory count on cold boot. Clears memory on all boots.◦ FullBoot Every x Days = Memory count on 1st cold boot on or after the xth day. No more memory counts until 1st cold boot on or after x days. Clears memory on all boots.• POST messages (enable/disable). Enabling this feature will cause the system to display POST error messages, which are error messages displayed on the monitor during the Power On Self Test if the BIOS encounters some kind of problem while starting the PC. A POST error message will only display on screen if the computer is capable of booting this far. If the POST detects an error before this point, a beep code is generated instead. Default is disabled.• Press the ESC key for Startup Menu (Enable/Disable). This feature controls the display of the text “Press the ESC key for Startup Menu” during POST. This text does not display on Windows 8 systems with Fast Boot support. Other text also will not display (for example, Ownership Tag). Default is enabled.• Option ROM Prompt (enable/disable). Enabling this feature will cause the system to display a message before loading option ROMs. Default is enabled.• After Power Loss (off/on/previous state). Default is Power off. Setting this option to:<ul style="list-style-type: none">◦ Power off—causes the computer to remain powered off when power is restored.◦ Power on—causes the computer to power on automatically as soon as power is restored.◦ Previous state—causes the computer to power on automatically as soon as power is restored, if it was on when power was lost. <p>NOTE: If you turn off power to the computer using the switch on a power strip, you will not be able to use the suspend/sleep feature or the Remote Management features.</p> <ul style="list-style-type: none">• POST Delay (in seconds). Enabling this feature will add a user-specified delay to the POST process. This delay is sometimes needed for hard disks on some PCI cards that spin up very slowly, so slowly that they are not ready to boot by the time POST is finished. The POST delay also gives you more time to select F10 to enter Computer (F10) Setup. Default is None.• Remote Wakeup Boot Source (remote server/local hard drive). Default is Local hard drive.• Factory Recovery Boot Support (Enable/Disable). Provides the ability for the BIOS to redirect the boot to the recovery partition on the user hard drive, if present. Some versions of the recovery software honor the F11 key press even when this feature is disabled by the BIOS. Default is disabled.• Bypass F1 Prompt on Configuration Changes (Enable/Disable). Allows you to set the computer not to confirm when changes were made. Default is disabled.

Table 8-5 Computer Setup—Advanced (for advanced users) (continued)

BIOS Power-On	Allows you to set the computer to turn on automatically at a time you specify.
Onboard Devices	Allows you to set resources for or disable Legacy devices. Select the Legacy device's IRQ, DMA, and I/O Range. The settings may not take effect for all operating systems. To hide a device from the operating system, see Security > Device Security.
Bus Options	Allows you to enable or disable: <ul style="list-style-type: none">• PCI SERR# Generation. Default is enabled.• PCI VGA Palette Snooping, which sets the VGA palette snooping bit in PCI configuration space; only needed when more than one graphics controller is installed. Default is disabled.
Device Options	Allows you to set: <ul style="list-style-type: none">• Printer mode (Bi-Directional, EPP + ECP, Output Only). ECP = Enhanced Capabilities Port, EPP = Enhanced Parallel Port. Default is EPP+ECP.• Num Lock State at Power-On (off/on). Default is off.• Integrated Video (enable/disable). Use this option to disable the integrated video controller when another video controller is present in the system. Default is enabled.• Integrated Graphics (Auto/Disable/Force) Use this option to manage integrated (UMA) graphics memory allocation. The value you choose is allocated permanently to graphics and is unavailable to the operating system. For example, if you set this value to 512M on a system with 2 GB of RAM, the system always allocates 512 MB for graphics and the other 1.5 GB for use by the BIOS and operating system. Default is Auto which sets memory allocation to 512 MB. If you select Force, the UMA Frame Buffer Size option displays, which lets you set the UMA memory size allocation between 32 MB and 1 GB.• Internal Speaker (does not affect external speakers). Default is enabled.• NIC PXE Option ROM Download (PXE, iSCSI, disabled). The BIOS contains an embedded NIC option ROM to allow the unit to boot through the network to a PXE server. This is typically used to download a corporate image to a hard drive. The NIC option ROM takes up memory space below 1MB commonly referred to as DOS Compatibility Hole (DCH) space. This space is limited. This F10 option will allow users to disable the downloading of this embedded NIC option ROM thus giving more DCH space for additional PCI cards which may need option ROM space. The default will be to have the NIC option-ROM-enabled. Default is PXE.• SATA RAID Option ROM Download (enable/disable). The BIOS contains an embedded SATA RAID option ROM for RAID support. This can be temporarily disabled to save DCH space. Note that with the option ROM disabled, users will be unable to boot to hard drives in the system while running in RAID mode. Default is disabled.• Multi-Processor (enable/disable). Use this option to disable multi-processor support under the OS. Default is enabled.• Hyper threading (enable/disable). Use this option to disable processor hyper-threading.• Turbo Mode (enable/disable). Allows you to enable and disable the Intel Turbo Mode feature, which allows one core of the system to run at a higher than standard frequency and power if other cores are idle. Default is enabled.

Table 8-5 Computer Setup—Advanced (for advanced users) (continued)

VGA Configuration	Displayed only if there is an add-in video card in the system. Allows you to specify which VGA controller will be the “boot” or primary VGA controller.
--------------------------	---

AMT Configuration	Allows you to set: <ul style="list-style-type: none">• AMT (enable/disable). Allows you to enable or disable functions of the embedded Management Engine (ME) such as Active Management Technology (AMT). If set to disable, the Management Engine is set to a temporarily disabled state and will not provide functions beyond necessary system configuration. Default is enabled.• Unconfigure AMT/ME (enable/disable). Allows you to unconfigure any provisioned management settings for AMT. The AMT settings are restored to factory defaults. This feature should be used with caution as AMT will not be able to provide any set AMT management functions once unconfigured. Default is disabled.• Hide Unconfigure ME Confirmation Prompt (enable/disable). Allows you to set the system to not display the confirmation to unconfigure ME.• Watchdog Timer (enable/disable). Allows you to set amount of time for a operating system and BIOS watchdog alert to be sent if the timers are not deactivated. BIOS watchdog is deactivated by BIOS and would indicate that a halt occurred during execution if the alert is sent to the management console. An operating system alert is deactivated by the operating system image and would indicate that a hang occurred during its initialization. Default is enabled.
--------------------------	--

Recovering the Configuration Settings

This method of recovery requires that you first perform the **Save to Removable Media** command with the Computer Setup (F10) Utility before **Restore** is needed. (See [Computer Setup—File on page 182](#) in the Computer Setup—File table.)

 **NOTE:** It is recommended that you save any modified computer configuration settings to a USB flash media device and save the device for possible future use.

To restore the configuration, insert the USB flash media device with the saved configuration and perform the **Restore from Removable Media** command with the Computer Setup (F10) Utility. (See [Computer Setup—File on page 182](#) in the Computer Setup—File table.)

9 Troubleshooting without diagnostics

This chapter provides information on how to identify and correct minor problems, such as USB devices, hard drive, optical drive, graphics, audio, memory, and software problems. If you encounter problems with the computer, refer to the tables in this chapter for probable causes and recommended solutions.

 **NOTE:** For information on specific error messages that may appear on the screen during Power-On Self-Test (POST) at startup, refer to Appendix A, [POST error messages on page 237](#).

Safety and comfort

 **WARNING!** Misuse of the computer or failure to establish a safe and comfortable work environment may result in discomfort or serious injury. Refer to the *Safety & Comfort Guide* at <http://www.hp.com/ergo> for more information on choosing a workspace and creating a safe and comfortable work environment. For more information, refer to the *Safety & Regulatory Information* guide.

Before you call for technical support

If you are having problems with the computer, try the appropriate solutions below to try to isolate the exact problem before calling for technical support.

- Run the HP diagnostic tool.
- Run the hard drive self-test in Computer Setup. Refer to [Computer Setup \(F10\) Utility on page 180](#) for more information.
- Check the Power LED on the front of the computer to see if it is flashing red. The flashing lights are error codes that will help you diagnose the problem. Refer to Appendix A, [POST error messages on page 237](#) for more information.
- If the screen is blank, plug the monitor into a different video port on the computer if one is available. Or, replace the monitor with a monitor that you know is functioning properly.
- If you are working on a network, plug another computer with a different cable into the network connection. There may be a problem with the network plug or cable.
- If you recently added new hardware, remove the hardware and see if the computer functions properly.

- If you recently installed new software, uninstall the software and see if the computer functions properly.
- Boot the computer to the Safe Mode to see if it will boot without all of the drivers loaded. When booting the operating system, use “Last Known Configuration.”
- Refer to the comprehensive online technical support at <http://www.hp.com/support>.
- Refer to [Helpful hints on page 197](#) in this guide.

To assist you in resolving problems online, HP Instant Support Professional Edition provides you with self-solve diagnostics. If you need to contact HP support, use HP Instant Support Professional Edition's online chat feature. Access HP Instant Support Professional Edition at: <http://www.hp.com/go/ispe>.

Access the Business Support Center (BSC) at <http://www.hp.com/go/bizsupport> for the latest online support information, software and drivers, proactive notification, and worldwide community of peers and HP experts.

If it becomes necessary to call for technical assistance, be prepared to do the following to ensure that your service call is handled properly:

- Be in front of your computer when you call.
- Write down the computer serial number, product ID number, and monitor serial number before calling.
- Spend time troubleshooting the problem with the service technician.
- Remove any hardware that was recently added to your system.
- Remove any software that was recently installed.
- Restore the system from the Recovery Disc Set that you created or restore the system to its original factory condition in System Software Requirement Disks (SSRD).

 **CAUTION:** Restoring the system will erase all data on the hard drive. Be sure to back up all data files before running the restore process.

 **NOTE:** For sales information and warranty upgrades (Care Packs), call your local authorized service provider or dealer.

Helpful hints

If you encounter problems with the computer, monitor, or software, see the following list of general suggestions before taking further action:

- Check that the computer and monitor are plugged into a working electrical outlet.
- Check that the voltage select switch (some models) is set to the appropriate voltage for your region (115V or 230V).
- Check that the computer is turned on and the white power light is on.
- Check that the monitor is turned on and the green monitor light is on.

- Check the Power LED on the front of the computer to see if it is flashing red. The flashing lights are error codes that will help you diagnose the problem. Refer to Appendix A, [POST error messages on page 237](#) for more information.
- Turn up the brightness and contrast controls of the monitor if the monitor is dim.
- Press and hold any key. If the system beeps, then the keyboard should be operating correctly.
- Check all cable connections for loose connections or incorrect connections.
- Wake the computer by pressing any key on the keyboard or pressing the power button. If the system remains in suspend mode, shut down the computer by pressing and holding the power button for at least four seconds then press the power button again to restart the computer. If the system will not shut down, unplug the power cord, wait a few seconds, then plug it in again. The computer will restart if it is set to power on automatically as soon as power is restored in Computer Setup. If it does not restart, press the power button to start the computer.
- Reconfigure the computer after installing a non-plug and play expansion board or other option. See [Solving Hardware Installation Problems on page 221](#) for instructions.
- Be sure that all the needed device drivers have been installed. For example, if you are using a printer, you need a driver for that model printer.
- Remove all bootable media (CD/DVD or USB device) from the system before turning it on.
- If you have installed an operating system other than the factory-installed operating system, check to be sure that it is supported on the system.
- If the system has multiple video sources (embedded, PCI, or PCI-Express adapters) installed (embedded video on some models only) and a single monitor, the monitor must be plugged into the monitor connector on the source selected as the primary VGA adapter. During boot, the other monitor connectors are disabled and if the monitor is connected into these ports, the monitor will not function. You can select which source will be the default VGA source in Computer Setup.

 **CAUTION:** When the computer is plugged into an AC power source, there is always voltage applied to the system board. You must disconnect the power cord from the power source before opening the computer to prevent system board or component damage.

Solving general problems

You may be able to easily resolve the general problems described in this section. If a problem persists and you are unable to resolve it yourself or if you feel uncomfortable about performing the operation, contact an authorized dealer or reseller.

⚠ WARNING! When the computer is plugged into an AC power source, voltage is always applied to the system board. To reduce the risk of personal injury from electrical shock and/or hot surfaces, be sure to disconnect the power cord from the wall outlet and allow the internal system components to cool before touching.

Computer appears locked up and will not turn off when the power button is pressed.

Cause	Solution
Software control of the power switch is not functional.	<ol style="list-style-type: none">1. Press and hold the power button for at least four seconds until the computer turns off.2. Disconnect the power cord from the electrical outlet.

Computer will not respond to keyboard or mouse.

Cause	Solution
Computer is in Sleep state.	To resume from Sleep state, press the power button. CAUTION: When attempting to resume from Sleep state, do not hold down the power button for more than four seconds. Otherwise, the computer will shut down and you will lose any unsaved data.
System has locked up.	Restart computer.

Computer date and time display is incorrect.

Cause	Solution
RTC (real-time clock) battery may need to be replaced. NOTE: Connecting the computer to a live AC outlet prolongs the life of the RTC battery.	Reset the date and time under Control Panel (Computer Setup can also be used to update the RTC date and time). If the problem persists, replace the RTC battery. See the Removal and Replacement section for instructions on installing a new battery, or contact an authorized dealer or reseller for RTC battery replacement. To access Control Panel in Windows 7, select Start , and then select Control Panel . To access Control Panel in Windows 8, from the Start screen, type c , and then select Control Panel from the list of applications.

Cursor will not move using the [arrow](#) keys on the keypad.

Cause	Solution
The Num Lock key is turned on.	Press the Num Lock key. The Num Lock light must be off if you want to use the arrow keys on the keypad. You can also disable or enable the Num Lock key in Computer Setup at Advanced > Device Options .

There is no sound or sound volume is too low.

Cause	Solution
System volume may be set low or muted.	<ol style="list-style-type: none">1. Check the Computer Setup settings to make sure the internal system speaker is not muted (this setting does not affect the external speakers).2. Make sure the external speakers are properly connected and powered on and that the speakers' volume control is set correctly.3. Use the system volume control available in the operating system to make sure the speakers are not muted or to increase the volume.

Cannot remove computer cover or access panel.

Cause	Solution
Smart Cover Lock, featured on some computers, is locked.	Unlock the Smart Cover Lock using Computer Setup. In case of forgotten password, power loss, or computer malfunction, you must manually disable the Smart Cover lock . A key to unlock the Smart Cover Lock is not available from HP. Keys are typically available from a hardware store.

Poor performance.

Cause	Solution
Processor is too hot.	<ol style="list-style-type: none">1. Make sure airflow to the computer is not blocked. Leave a 10.2-cm (4-inch) clearance on all vented sides of the computer and above the monitor to permit the required airflow.2. Make sure fans are connected and working properly (some fans only operate when needed).3. Make sure the processor heat sink is installed properly.
Hard drive is full.	Transfer data from the hard drive to create more space on the hard drive.
Low on memory.	Add more memory.

Poor performance.

Cause	Solution
Hard drive fragmented.	Defragment hard drive.
Program previously accessed did not release reserved memory back to the system.	Restart the computer.
Virus resident on the hard drive.	Run virus protection program.
Too many applications running.	<p>Windows 7:</p> <ol style="list-style-type: none">1. Close unnecessary applications to free up memory.2. Add more memory.3. Some applications run in the background and can be closed by right-clicking on their corresponding icons in the task tray. To prevent these applications from launching at startup: <p>In Windows 7:</p> <ol style="list-style-type: none">a. Go to Start > All Programs > Accessories > Runb. Type <code>msconfig</code>, and then press Enter.c. On the Startup tab of the System Configuration Utility, clear applications that you do not want to launch automatically, and then click OK. <p>In Windows 8:</p> <ol style="list-style-type: none">a. On the Start screen, right-click, and then select the All apps icon.b. Under Windows System, click Run.c. Type <code>msconfig</code>, and then press Enter.d. On the Startup tab of the System Configuration Utility, clear applications that you do not want to launch automatically, and then click OK.
Some software applications, especially games, are stressful on the graphics subsystem.	<ol style="list-style-type: none">1. Lower the display resolution for the current application or consult the documentation that came with the application for suggestions on how to improve performance by adjusting parameters in the application.2. Add more memory.3. Upgrade the graphics solution.
Cause unknown.	Restart the computer.

Computer powered off automatically and the Power LED flashes Red two times, once every second, followed by a two second pause, and the computer beeps two times. (Beeps stop after fifth iteration but LEDs continue flashing).

Cause	Solution
Processor thermal protection activated: A fan may be blocked or not turning. OR The heat sink is not properly attached to the processor.	<ol style="list-style-type: none">1. Ensure that the computer air vents are not blocked and the processor cooling fan is running.2. Open the access panel, press the power button, and see if the processor fan (or other system fan) spins. If the fan does not spin, make sure the fan cable is plugged onto the system board header.3. If fan is plugged in and not spinning, replace it.

System does not power on and the LEDs on the front of the computer are not flashing.

Cause	Solution
System unable to power on.	<p>Press and hold the power button for less than 4 seconds. If the hard drive LED turns white, then:</p> <ol style="list-style-type: none">1. If equipped with a voltage selector, check that the voltage selector (located on the rear of the power supply) is set to the appropriate voltage. Proper voltage setting depends on your region.2. Remove the expansion cards one at a time until the 5V_aux light on the system board turns on.3. Replace the system board. <p>OR</p> <p>Press and hold the power button for less than 4 seconds. If the hard drive LED does not turn on white then:</p> <ol style="list-style-type: none">1. Check that the unit is plugged into a working AC outlet.2. Open the access panel and check that the power button cable is properly connected to the system board.3. Check that the power supply cables are properly connected to the system board.4. Check to see if the 5V_aux light on the system board is turned on. If it is turned on, then replace the power button assembly.5. If the 5V_aux light on the system board is off, then replace the power supply.6. Replace the system board.

Solving power problems

Common causes and solutions for power problems are listed in the following table.

Power supply shuts down intermittently.

Cause	Solution
If equipped with a voltage selector, voltage selector switch on rear of computer chassis (some models) not switched to correct line voltage (115V or 230V).	Select the proper AC voltage using the selector switch.
Power supply will not turn on because of internal power supply fault.	Replace the power supply.

Computer powered off automatically and the Power LED flashes Red two times, once every second, followed by a two second pause, and the computer beeps two times. (Beeps stop after fifth iteration but LEDs continue flashing.)

Cause	Solution
Processor thermal protection activated: A fan may be blocked or not turning. OR The heat sink is not properly attached to the processor.	<ol style="list-style-type: none">1. Ensure that the computer air vents are not blocked and the processor cooling fan is running.2. Open the access panel, press the power button, and see if the processor fan (or other system fan) spins. If the fan does not spin, make sure the fan cable is plugged onto the system board header.3. If fan a plugged in and not spinning, replace it.

Power LED flashes Red four times, once every second, followed by a two second pause, and the computer beeps four times. (Beeps stop after fifth iteration but LEDs continue flashing.)

Cause	Solution
Power failure (power supply is overloaded).	<ol style="list-style-type: none">1. If equipped with a voltage selector, check that the voltage selector, located on the rear of the power supply (some models), is set to the appropriate voltage. Proper voltage setting depends on your region.2. Open the access panel and ensure the power supply cable is seated into the connector on the system board.3. Check if a device is causing the problem by removing ALL attached devices (such as hard drives or optical drives and expansion cards). Power on the system. If the system enters POST, then power off and replace one device at a time and repeat this procedure until failure occurs. Replace the device that is causing the failure. Continue adding devices one at a time to ensure all devices are functioning properly.4. Replace the power supply.5. Replace the system board.
The incorrect external power supply adapter is being used on the All-in One or USDT.	The power supply adapter must be at the correct power rating and use the Smart ID technology before the system will power up. Replace the power supply adapter with the HP-supplied power supply adapter.

Solving hard drive problems

Hard drive error occurs.

Cause	Solution
Hard disk has bad sectors or has failed.	<ol style="list-style-type: none">1. In Windows 7, click Start, click Computer, and right-click on a drive. Select Properties, and then select the Tools tab. Under Error-checking click Check Now. In Windows 8, on the Start screen type e, and then select File Explorer from the list of applications. In the left column, expand Computer, right-click on a drive, select Properties, and then select the Tools tab. Under Error checking click Check.2. Use a utility to locate and block usage of bad sectors. If necessary, reformat the hard disk.

Disk transaction problem.

Cause	Solution
Either the directory structure is bad or there is a problem with a file.	<p>In Windows 7, click Start, expand Computer, and right-click on a drive. Select Properties, and then select the Tools tab. Under Error-checking click Check Now.</p> <p>In Windows 8, on the Start screen type e, and then click File Explorer from the list of applications. In the left column, expand Computer, right-click on a drive, select Properties, and then select the Tools tab. Under Error checking click Check.</p>

Drive not found (identified).

Cause	Solution
Cable could be loose.	Check cable connections.
The system may not have automatically recognized a newly installed device.	<p>See reconfiguration directions in the Solving Hardware Installation Problems on page 221 section. If the system still does not recognize the new device, check to see if the device is listed within Computer Setup. If it is listed, the probable cause is a driver problem. If it is not listed, the probable cause is a hardware problem.</p> <p>If this is a newly installed drive, run the Computer Setup utility and try adding a POST delay under Advanced > Power-On Options.</p>

Drive not found (identified).

Cause	Solution
The device is attached to a SATA port that has been hidden in Computer Setup.	Run the Computer Setup utility and ensure Device Available is selected for the device's SATA port in Security > Device Security .
Drive responds slowly immediately after power-up.	Run Computer Setup and increase the POST Delay in Advanced > Power-On Options .

Nonsystem disk/NTLDR missing message.

Cause	Solution
The system is trying to start from the hard drive but the hard drive may have been damaged.	<ol style="list-style-type: none">1. Perform Drive Protection System (DPS) testing in system ROM.
System files missing or not properly installed.	<ol style="list-style-type: none">1. Insert bootable media and restart the computer.2. Boot to the windows installation media and select the recovery option. If only a restore kit is available, then select the File Backup Program option, and then restore the system.3. Install system files for the appropriate operating system.
Hard drive boot has been disabled in Computer Setup.	Run the Computer Setup utility and enable the hard drive entry in the Storage > Boot Order list.
Bootable hard drive is not attached as first in a multi-hard drive configuration.	If attempting to boot from a hard drive, ensure it is attached to the system board dark blue SATA connector.
Bootable hard drive is not listed first in the Boot Order.	Run the Computer Setup utility and select Storage > Boot Order and ensure the bootable hard drive is listed immediately under the Hard Drive entry.

Computer will not boot from hard drive.

Cause	Solution
The device is attached to a SATA port that has been hidden in Computer Setup.	<ol style="list-style-type: none">1. Check SATA cable connections.2. Run the Computer Setup utility and ensure Device Available is selected for the device's SATA port in Security > Device Security.
Boot order is not correct.	Run the Computer Setup utility and change boot sequence in Storage > Boot Order .

Computer will not boot from hard drive.

Cause	Solution
Hard Drive's "Emulation Type" is set to "None." (some models)	Run the Computer Setup utility and change the "Emulation Type" to "Hard Disk" in the device's details under Storage > Device Configuration .
Hard drive is damaged.	Observe if the front panel Power LED is blinking RED and if any beeps are heard. See Appendix A, POST error messages on page 237 to determine possible causes for the blinking red and beep codes. See the Worldwide Limited Warranty for terms and conditions.

Computer seems to be locked up.

Cause	Solution
Program in use has stopped responding to commands.	<ol style="list-style-type: none">1. Use the task manager to close programs that do not respond.2. Attempt the normal Windows "Shut Down" procedure. If this fails, press the power button for four or more seconds to turn off the power. To restart the computer, press the power button again.

Solving media card reader problems

Media card will not work in a digital camera after formatting it in Windows.

Cause	Solution
By default, Windows will format any media card with a capacity greater than 32MB with the FAT32 format. Some digital cameras use the FAT (FAT16 & FAT12) format and can not operate with a FAT32 formatted card.	Either format the media card in the digital camera or select FAT file system to format the media card in a computer with Windows.

A write-protected or locked error occurs when attempting to write to the media card.

Cause	Solution
Media card is locked. Locking the media card is a safety feature that prevents writing to and deleting from an SD/Memory Stick/PRO card.	If using an SD card, make sure that the lock tab located on the right of the SD card is not in the locked position. If using a Memory Stick/PRO card, make sure that the lock tab located on the bottom of the Memory Stick/PRO card is not in the locked position.

Can not write to the media card.

Cause	Solution
The media card is a read-only memory (ROM) card.	Check the manufacturer's documentation included with your card to see if it writable. Refer to the previous section for a list of compatible cards.
Media card is locked. Locking the media card is a safety feature that prevents writing to and deleting from an SD/Memory Stick/PRO card.	If using an SD card, make sure that the lock tab located on the right of the SD card is not in the locked position. If using a Memory Stick/PRO card, make sure that the lock tab located on the bottom of the Memory Stick/PRO card is not in the locked position.

Unable to access data on the media card after inserting it into a slot.

Cause	Solution
The media card is not inserted properly, is inserted in the wrong slot, or is not supported.	Ensure that the card is inserted properly with the gold contact on the correct side. The green LED will light if inserted properly.

Do not know how to remove a media card correctly.

Cause	Solution
The computer's software is used to safely eject the card.	<p>In Windows 7, click Start, select Computer, right-click on the corresponding drive icon, and then select Eject. Pull the card out of the slot.</p> <p>In Windows 8, on the Start screen, type e, and then click File Explorer from the list of applications. Expand Computer, right-click on the corresponding drive icon, and then select Eject. Pull the card out of the slot.</p> <p>NOTE: Never remove the card when the green LED is flashing</p>

After installing the media card reader and booting to Windows, the reader and the inserted cards are not recognized by the computer.

Cause	Solution
The operating system needs time to recognize the device if the reader was just installed into the computer and you are turning the PC on for the first time.	Wait a few seconds so that the operating system can recognize the reader and the available ports, and then recognize the media inserted in the reader.

After inserting a media card in the reader, the computer attempts to boot from the media card.

Cause	Solution
The inserted media card has boot capability.	<ol style="list-style-type: none">1. If you do not want to boot from the media card, remove it during boot or do not select the option to boot from the inserted media card during the boot process.2. During POST (Power On Self-Test), press F9 to modify the boot menu.3. Change the boot sequence in F10 Computer Setup.

Solving display problems

If you encounter display problems, see the documentation that came with the monitor and to the common causes and solutions listed in the following table.

Blank screen (no video).

Cause	Solution
Monitor is not turned on and the monitor light is not on.	Turn on the monitor and check that the monitor light is on.
Bad monitor.	Try a different monitor.
The cable connections are not correct.	Check the cable connection from the monitor to the computer and to the electrical outlet.
You may have a screen blanking utility installed or energy saver features are enabled.	Press any key or click the mouse button and type your password (if set).
System ROM is corrupted; system is running in Boot Block Emergency Recovery Mode (indicated by eight beeps).	Reflash the system ROM with the latest BIOS image.
You are using a fixed-sync monitor and it will not sync at the resolution chosen.	Be sure that the monitor can accept the same horizontal scan rate as the resolution chosen.
Computer is in Sleep state.	Press the power button to resume from Sleep state. CAUTION: When attempting to resume from Sleep state, do not hold down the power button for more than four seconds. Otherwise, the computer will shut down and you will lose any unsaved data.
Monitor cable is plugged into the wrong connector.	Systems may have a monitor connection on both the motherboard or an add-in card. Try moving the monitor connection to a different connector on the back of the computer
Monitor settings in the computer are not compatible with the monitor.	<ol style="list-style-type: none">In Control Panel, select Category from the View by list, then under Appearance and Personalization, select Adjust screen resolution. To access Control Panel in Windows 7, click Start, and then select Control Panel. To access Control Panel in Windows 8, from the Start screen, type c, and then select Control Panel from the list of applications.Expand the Resolution box, and then use the sliding control to reset the resolution.
Monitor is configured to use an input that is not active.	Use the monitor's on-screen menu controls to select the input that is being driven by the system. Refer to the monitor's user documentation for more information on the on-screen controls and settings.

Blank screen and the power LED flashes Red five times, once every second, followed by a two second pause, and the computer beeps five times. (Beeps stop after fifth iteration but LEDs continue flashing.)

Cause	Solution
Pre-video memory error.	<ol style="list-style-type: none">1. Reseat DIMMs. Power on the system.2. Replace DIMMs one at a time to isolate the faulty module.3. Replace third-party memory with HP memory.4. Replace the system board.

Blank screen and the power LED flashes Red six times, once every second, followed by a two second pause, and the computer beeps six times. (Beeps stop after fifth iteration but LEDs continue flashing.)

Cause	Solution
Pre-video graphics error.	<p>For systems with a graphics card:</p> <ol style="list-style-type: none">1. Reseat the graphics card (if applicable). Power on the system.2. Replace the graphics card (if applicable).3. Replace the system board. <p>For systems with integrated graphics, replace the system board.</p>

Blank screen and the power LED flashes Red seven times, once every second, followed by a two second pause, and the computer beeps seven times. (Beeps stop after fifth iteration but LEDs continue flashing.)

Cause	Solution
System board failure (ROM detected failure prior to video).	Replace the system board.

Monitor does not function properly when used with energy saver features.

Cause	Solution
Monitor without energy saver capabilities is being used with energy saver features enabled.	Disable monitor energy saver feature.

Dim characters.

Cause	Solution
The brightness and contrast controls are not set properly.	Adjust the monitor brightness and contrast controls.
Cables are not properly connected.	Check that the graphics cable is securely connected to the graphics card (if applicable) or video connector and the monitor.

Blurry video or requested resolution cannot be set.

Cause	Solution
If the graphics controller was upgraded, the correct graphics drivers may not be loaded.	Install the video drivers included in the upgrade kit.
Monitor is not capable of displaying requested resolution.	Change requested resolution.
Graphics card is bad.	Replace the graphics card.

The picture is broken up, rolls, jitters, or flashes.

Cause	Solution
The monitor connections may be incomplete or the monitor may be incorrectly adjusted.	<ol style="list-style-type: none">1. Be sure the monitor cable is securely connected to the computer.2. In a two-monitor system or if another monitor is in close proximity, be sure the monitors are not interfering with each other's electromagnetic field by moving them apart.3. Fluorescent lights or fans may be too close to the monitor.
Monitor needs to be degaussed.	Degauss the monitor. Refer to the documentation that came with the monitor for instructions.

Image is not centered.

Cause	Solution
Position may need adjustment.	Press the monitor's Menu button to access the OSD menu. Select ImageControl/ Horizontal Position or Vertical Position to adjust the horizontal or vertical position of the image.

“No Connection, Check Signal Cable” displays on screen.

Cause	Solution
Monitor video cable is disconnected.	Connect the video cable between the monitor and computer. CAUTION: Ensure that the computer power is off while connecting the video cable.

“Out of Range” displays on screen.

Cause	Solution
Video resolution and refresh rate are set higher than what the monitor supports.	<p>Restart the computer and enter Safe Mode. Change the settings to a supported setting then restart the computer so that the new settings take effect.</p> <p>To enter Safe Mode in Windows 7:</p> <ol style="list-style-type: none">1. Restart the computer.2. Press and hold the F8 key as your computer restarts, before the Windows logo appears. If the Windows logo appears, you must restart the computer and try again.3. On the Advanced Boot Options screen, use the arrow keys to highlight the safe mode option you want, and then press Enter.4. Log on to your computer with a user account that has administrator rights. <p>When your computer is in safe mode, Safe Mode displays in the corners of your monitor. To exit safe mode, restart your computer and let Windows start normally.</p> <p>To enter Safe Mode in Windows 8:</p> <ol style="list-style-type: none">1. Press the Windows logo + I to open the Settings charm.2. Select Change PC Settings, select General, and then under Advanced startup, click Restart now.3. Select Troubleshoot, select Advanced options, select Startup Settings, and then click Restart.4. Use the function keys or number keys to select the safe mode option you want. <p>When your computer is in safe mode, Safe Mode displays in the corners of your monitor. To exit safe mode, restart your computer and let Windows start normally.</p>

High pitched noise coming from inside a flat panel monitor.

Cause	Solution
Brightness and/or contrast settings are too high.	Lower brightness and/or contrast settings.

Fuzzy focus; streaking, ghosting, or shadowing effects; horizontal scrolling lines; faint vertical bars; or unable to center the picture on the screen (flat panel monitors using an analog VGA input connection only).

Cause	Solution
Flat panel monitor's internal digital conversion circuits may be unable to correctly interpret the output synchronization of the graphics card.	<ol style="list-style-type: none">1. Select the monitor's Auto-Adjustment option in the monitor's on-screen display menu.2. Manually synchronize the Clock and Clock Phase on-screen display functions. To download a SoftPaq that will assist you with the synchronization, go to the following Web site, select the appropriate monitor, and download either SP32347 or SP32202: http://www.hp.com/support
Graphics card is not seated properly or is bad (some models).	<ol style="list-style-type: none">1. Reseat the graphics card.2. Replace the graphics card.

Certain typed symbols do not appear correct.

Cause	Solution
The font you are using does not support that particular symbol.	<p>Use the Character Map to locate and select the appropriate symbol. You can copy the symbol from the Character Map into a document.</p> <p>In Windows 7, click Start, select All Programs, select Accessories, select System Tools, and then select Character Map.</p> <p>In Windows 8, on the Start screen, type <code>ch</code>, and then select Character Map from the list of applications.</p>

Solving audio problems

If the computer has audio features and you encounter audio problems, see the common causes and solutions listed in the following table.

Sound cuts in and out.

Cause	Solution
Processor resources are being used by other open applications.	Shut down all open processor-intensive applications.

Sound does not come out of the speaker or headphones.

Cause	Solution
Software volume control is turned down or muted.	Double-click the Speaker icon on the taskbar, then make sure that Mute is not selected and use the volume slider to adjust the volume. NOTE: In Windows 8, the taskbar is available at the bottom of the Desktop screen.
Audio is hidden in Computer Setup.	Enable the audio in Computer Setup: Security > Device Security > System Audio .
The external speakers are not turned on.	Turn on the external speakers.
The audio device may be connected to the wrong jack.	Ensure that the device is connected to the correct jack on the computer. The rear audio jack output is the green receptacle. The speakers should be plugged into the line-out jack and the headphones should be plugged into the headphone jack.
External speakers plugged into the wrong audio jack on a recently installed sound card.	See the sound card documentation for proper speaker connection. The rear audio jack output is the green receptacle.
Headphones or devices connected to the line-out connector mute the internal speaker.	Turn on and use headphones or external speakers, if connected, or disconnect headphones or external speakers.
Computer is in Sleep state.	Press the power button to resume from Sleep state. CAUTION: When attempting to resume from Sleep state, do not hold down the power button for more than four seconds. Otherwise, the computer will shut down and you will lose any unsaved data.
Internal speaker is disabled in Computer Setup.	Enable the internal speaker in Computer Setup. Select Advanced > Device Options > Internal Speaker .

Sound does not come out of the speaker or headphones.

Cause	Solution
The application is set to use a different audio device than speakers.	Some graphics cards support audio over the DisplayPort connection (if applicable), so multiple audio devices may be listed in Device Manager. Make sure the correct device is being used. To access Device Manager in Windows 7, click Start , select Control Panel , and then select Device Manager . To access Device Manager in Windows 8, from the Start screen, type c , select Control Panel from the list of applications, and then select Device Manager .
Some applications can select which audio output device is used.	Make sure the application has selected the correct audio device.
The operating system controls may be set to use a different audio device as the default output device than what is expected.	Set the operating system to use the correct audio device.

Sound from headphones is not clear or muffled.

Cause	Solution
Headphones are plugged into the rear audio output connector. The rear audio output connector is for powered audio devices and is not designed for headphone use.	Plug the headphones into the headphone connector on the front of the computer.

Computer appears to be locked up while recording audio.

Cause	Solution
The hard disk may be full.	Before recording, make sure there is enough free space on the hard disk. You can also try recording the audio file in a compressed format.

Line-in jack is not functioning properly.

Cause	Solution
Jack has been reconfigured in the audio driver or application software.	In the audio driver or application software, reconfigure the jack or set the jack to its default value.

There is no sound or sound volume is too low.

Cause	Solution
The application is set to use a different audio device than speakers.	<p>Some graphics cards support audio over the DisplayPort connection (if applicable), so multiple audio devices may be listed in Device Manager. Make sure the correct device is being used.</p> <p>To access Device Manager in Windows 7, click Start, select Control Panel, and then select Device Manager.</p> <p>To access Device Manager in Windows 8, from the Start screen, type c, select Control Panel from the list of applications, and then select Device Manager.</p>
Some applications can select which audio output device is used.	Make sure the application has selected the correct audio device.
The operating system controls may be set to use a different audio device as the default output device than what is expected.	Set the operating system to use the correct audio device.

Solving printer problems

If you encounter printer problems, see the documentation that came with the printer and to the common causes and solutions listed in the following table.

Printer will not print.

Cause	Solution
Printer is not turned on and online.	Turn the printer on and make sure it is online.
The correct printer drivers for the application are not installed.	<ol style="list-style-type: none">1. Install the correct printer driver for the application.2. Try printing using the MS-DOS command: <pre>DIR C:\ > [printer port]</pre>where [printer port] is the address of the printer being used. If the printer works, reload the printer driver. To run MS-DOS commands, press the Windows key + r, type cmd in the Open box, and then click OK.
If you are on a network, you may not have made the connection to the printer.	Make the proper network connections to the printer.
Printer may have failed.	Run printer self-test.

Printer will not turn on.

Cause	Solution
The cables may not be connected properly.	Reconnect all cables and check the power cord and electrical outlet.

Printer prints garbled information.

Cause	Solution
The correct printer driver for the application is not installed.	Install the correct printer driver for the application.
The cables may not be connected properly.	Reconnect all cables.
Printer memory may be overloaded.	Reset the printer by turning it off for one minute, then turn it back on.

Printer will not print.

Cause	Solution
The printer may be out of paper.	Check the paper tray and refill it if it is empty.

Solving keyboard and mouse problems

If you encounter keyboard or mouse problems, see the documentation that came with the equipment and to the common causes and solutions listed in the following table.

A wireless keyboard/mouse is not working correctly. Symptoms include lagging mouse movement, jumpy mouse/keyboard, or no function of mouse/keyboard and external drive.

Cause	Solution
If your computer is equipped with USB 3.0 ports, connected USB 3.0 devices can interfere with the wireless keyboard USB receiver.	Connect the wireless keyboard USB receiver to a USB 2.0 port that is separated from ports with USB 3.0 devices. If you still experience interference, you may have to place the connectors farther apart using an external USB hub.

Keyboard commands and typing are not recognized by the computer.

Cause	Solution
Keyboard connector is not properly connected.	Shut down the computer, reconnect the keyboard to the back of the computer, and then restart the computer.
Program in use has stopped responding to commands.	Shut down your computer using the mouse and then restart the computer.
Keyboard needs repairs.	See the Worldwide Limited Warranty for terms and conditions.
Computer is in Sleep state.	Press the power button to resume from Sleep state. CAUTION: When attempting to resume from Sleep state, do not hold down the power button for more than four seconds. Otherwise, the computer will shut down and you will lose any unsaved data.

Cursor will not move using the [arrow](#) keys on the keypad.

Cause	Solution
The Num Lock key is on.	Press the Num Lock key. The Num Lock light should be off if you want to use the arrow keys on the keypad. You can disable or enable the Num Lock key in Computer Setup at Advanced > Device Options .

Mouse does not respond to movement or is too slow.

Cause	Solution
Mouse connector is not properly plugged into the back of the computer.	<p>Shut down the computer using the keyboard.</p> <p>Windows 7:</p> <ol style="list-style-type: none">1. Press the Ctrl and Esc keys at the same time (or press the Windows logo key) to display the Start menu.2. Use the arrow keys to select Shut Down and then press Enter.3. After the shutdown is complete, plug the mouse connector into the back of the computer (or the keyboard) and restart. <p>Windows 8:</p> <ol style="list-style-type: none">1. Press the Windows logo + I to open the Settings charm.2. Use the arrow keys to select Power, and then press Enter.3. Use the arrow keys to select Shut Down, and then press Enter.4. After the shutdown is complete, plug the mouse connector into the back of the computer (or the keyboard) and restart.
Program in use has stopped responding to commands.	Shut down the computer using the keyboard then restart the computer.
Mouse may need cleaning.	Remove the roller ball cover on the mouse and clean the internal components.
Mouse may need repair.	See the Worldwide Limited Warranty for terms and conditions.
Computer is in Sleep state.	<p>Press the power button to resume from Sleep state.</p> <p>CAUTION: When attempting to resume from Sleep state, do not hold down the power button for more than four seconds. Otherwise, the computer will shut down and you will lose any unsaved data.</p>

Mouse will only move vertically, horizontally, or movement is jerky.

Cause	Solution
Mouse roller ball or the rotating encoder shafts that make contact with the ball are dirty.	Remove roller ball cover from the bottom of the mouse and clean the internal components with a mouse cleaning kit available from most computer stores.

Solving Hardware Installation Problems

You may need to reconfigure the computer when you add or remove hardware, such as an additional drive or expansion card. If you install a plug and play device, Windows automatically recognizes the device and configures the computer. If you install a non-plug and play device, you must reconfigure the computer after completing installation of the new hardware. In Windows, use the **Add Hardware Wizard** and follow the instructions that appear on the screen.

To open the Add Hardware Wizard, open a Command Prompt and open hdwwiz.exe.

⚠ WARNING! When the computer is plugged into an AC power source, voltage is always applied to the system board. To reduce the risk of personal injury from electrical shock and/or hot surfaces, be sure to disconnect the power cord from the wall outlet and allow the internal system components to cool before touching.

Table 9-1 Solving Hardware Installation Problems

A new device is not recognized as part of the system.

Cause	Solution
Device is not seated or connected properly.	Ensure that the device is properly and securely connected and that pins in the connector are not bent down.
Cable(s) of new external device are loose or power cables are unplugged.	Ensure that all cables are properly and securely connected and that pins in the cable or connector are not bent down.
Power switch of new external device is not turned on.	Turn off the computer, turn on the external device, then turn on the computer to integrate the device with the computer system.
When the system advised you of changes to the configuration, you did not accept them.	Reboot the computer and follow the instructions for accepting the changes.
A plug and play board may not automatically configure when added if the default configuration conflicts with other devices.	Use Windows Device Manager to deselect the automatic settings for the board and choose a basic configuration that does not cause a resource conflict. You can also use Computer Setup to reconfigure or disable devices to resolve the resource conflict. To access Device Manager in Windows 7, click Start , select Control Panel , and then select Device Manager . To access Device Manager in Windows 8, from the Start screen, type c , select Control Panel from the list of applications, and then select Device Manager .
USB ports on the computer are disabled in Computer Setup.	Run the Computer Setup utility and ensure that Device available is selected for appropriate USB ports under Security > USB Security .

Computer will not start.

Cause	Solution
Wrong memory modules were used in the upgrade or memory modules were installed in the wrong location.	<ol style="list-style-type: none">1. Review the documentation that came with the system to determine if you are using the correct memory modules and to verify the proper installation. NOTE: DIMM1 or XMM1 must always be installed. On all computers except the USDT, DIMM1 must be installed before DIMM2, and DIMM3 must be installed before DIMM4.2. Observe the beeps and LED lights on the front of the computer. Beeps and flashing LEDs are codes for specific problems.3. If you still cannot resolve the issue, contact Customer Support.

Power LED flashes Red five times, once every second, followed by a two second pause, and the computer beeps five times. (Beeps stop after fifth iteration but LEDs continue flashing.)

Cause	Solution
Memory is installed incorrectly or is bad.	<p>CAUTION: To avoid damage to the DIMMs or the system board, you must unplug the computer power cord before attempting to reseat, install, or remove a DIMM module.</p> <ol style="list-style-type: none">1. Reseat DIMMs. Power on the system.2. Replace DIMMs one at a time to isolate the faulty module. NOTE: DIMM1 or XMM1 must always be installed. On all computers except the USDT, DIMM1 must be installed before DIMM2, and DIMM3 must be installed before DIMM43. Replace third-party memory with HP memory.4. Replace the system board.

Power LED flashes Red six times, once every second, followed by a two second pause, and the computer beeps six times. (Beeps stop after fifth iteration but LEDs continue flashing.)

Cause	Solution
Graphics card (some models) is not seated properly or is bad, or system board is bad.	For systems with a graphics card: <ol style="list-style-type: none">1. Reseat the graphics card. Power on the system.2. Replace the graphics card.3. Replace the system board. For systems with integrated graphics, replace the system board.

Power LED flashes Red ten times, once every second, followed by a two second pause, and the computer beeps ten times. (Beeps stop after fifth iteration but LEDs continue flashing.)

Cause	Solution
Bad option card.	<ol style="list-style-type: none">1. Check each option card by removing the cards one at time (if multiple cards), then power on the system to see if fault goes away.2. Once bad card is identified, remove and replace bad option card.3. Replace the system board.

Solving Network Problems

Some common causes and solutions for network problems are listed in the following table. These guidelines do not discuss the process of debugging the network cabling.

Table 9-2 Solving Network Problems

Wake-on-LAN feature is not functioning.

Cause	Solution
S5 Maximum Power Saving feature is enabled.	Disable the S5 Maximum Power Saving option in Computer Setup. Select Power > Hardware Power Management > S5 Maximum Power Savings .

Table 9-2 Solving Network Problems (continued)

Wake-on-LAN feature is not functioning.

Cause	Solution
S5 Wake on LAN is disabled (some models).	Enable the S5 Wake on LAN option in Computer Setup. Select Advanced > Device Options > S5 Wake on LAN .
Wake-on-LAN is not enabled.	To enable Wake-on-LAN in Windows 7: <ol style="list-style-type: none">1. Select Start > Control Panel > Network and Sharing Center.2. Under Tasks, select Manage network connections.3. Click Local Area Connection.4. Click the Properties button.5. Click the Configure button.6. Click the Power Management tab, then select Allow this device to wake the computer. To enable Wake-on-LAN in Windows 8: <ol style="list-style-type: none">1. From the Start screen, type c, and then select Control Panel from the list of applications.2. Select Network and Sharing Center, and then click the Ethernet link next to the connection.3. Click the Properties button.4. Click the Configure button.5. Click the Power Management tab, then enable the appropriate Wake-on LAN option.

Network driver does not detect network controller.

Cause	Solution
Network controller is disabled.	<ol style="list-style-type: none">1. Run Computer Setup and enable network controller.2. Enable the network controller in the operating system using Device Manager. To access Device Manager in Windows 7, click Start, select Control Panel, and then select Device Manager. To access Device Manager in Windows 8, from the Start screen, type c, select Control Panel from the list of applications, and then select Device Manager.
Incorrect network driver.	Check the network controller documentation for the correct driver or obtain the latest driver from the manufacturer's Web site.

Network status link light never flashes.

NOTE: The network status light is supposed to flash when there is network activity.

Cause	Solution
No active network is detected.	Check cabling and network equipment for proper connection.
Network controller is not set up properly.	Check for the device status within Windows, such as Device Manager for driver load and the Network Connections applet within Windows for link status. To access Device Manager in Windows 7, click Start , select Control Panel , and then select Device Manager . To access Device Manager in Windows 8, from the Start screen, type c , select Control Panel from the list of applications, and then select Device Manager .
Network controller is disabled.	<ol style="list-style-type: none">1. Run Computer Setup and enable network controller.2. Enable the network controller in the operating system using Device Manager. To access Device Manager in Windows 7, click Start, select Control Panel, and then select Device Manager. To access Device Manager in Windows 8, from the Start screen, type c, select Control Panel from the list of applications, and then select Device Manager.
Network driver is not properly loaded.	Reinstall network drivers.
System cannot autosense the network.	Disable auto-sensing capabilities and force the system into the correct operating mode.

Diagnostics reports a failure.

Cause	Solution
The cable is not securely connected.	Ensure that the cable is securely attached to the network connector and that the other end of the cable is securely attached to the correct device.
The cable is attached to the incorrect connector.	Ensure that the cable is attached to the correct connector.
There is a problem with the cable or a device at the other end of the cable.	Ensure that the cable and device at the other end are operating correctly.
Network controller interrupt is shared with an expansion board.	Under the Computer Setup Advanced menu, change the resource settings for the board.
The network controller is defective.	Contact an authorized service provider.

Diagnostics passes, but the computer does not communicate with the network.

Cause	Solution
Network drivers are not loaded, or driver parameters do not match current configuration.	Make sure the network drivers are loaded and that the driver parameters match the configuration of the network controller. Make sure the correct network client and protocol is installed.
The network controller is not configured for this computer.	Select the Network and Sharing Center icon in the Control Panel and configure the network controller. To access Control Panel in Windows 7, click Start , and then select Control Panel . To access Control Panel in Windows 8, from the Start screen, type c , and then select Control Panel .

Network controller stopped working when an expansion board was added to the computer.

Cause	Solution
Network controller interrupt is shared with an expansion board.	Under the Computer Setup Advanced menu, change the resource settings for the board.
The network controller requires drivers.	Verify that the drivers were not accidentally deleted when the drivers for a new expansion board were installed.
The expansion board installed is a network card (NIC) and conflicts with the embedded NIC.	Under the Computer Setup Advanced menu, change the resource settings for the board.

Network controller stops working without apparent cause.

Cause	Solution
The files containing the network drivers are corrupted.	Reinstall the network drivers using the Recovery Disc Set in Windows 7 or Windows recovery tools in Windows 8. If necessary, download the softpaq from the web (from a different computer).
The cable is not securely connected.	Ensure that the cable is securely attached to the network connector and that the other end of the cable is securely attached to the correct device.
The network controller is defective.	Contact an authorized service provider.

New network card will not boot.

Cause	Solution
New network card may be defective or may not meet industry-standard specifications.	Install a working, industry-standard NIC, or change the boot sequence to boot from another source.

Cannot connect to network server when attempting Remote System Installation.

Cause	Solution
The network controller is not configured properly.	Verify Network Connectivity, that a DHCP Server is present, and that the Remote System Installation Server contains the NIC drivers for your NIC.

System setup utility reports unprogrammed EEPROM.

Cause	Solution
Unprogrammed EEPROM.	Contact an authorized service provider.

Solving memory problems

If you encounter memory problems, some common causes and solutions are listed in the following table.

⚠ CAUTION: Power may still be supplied to the DIMMs when the computer is turned off (depending on the Management Engine (ME) settings). To avoid damage to the DIMMs or the system board, you must unplug the computer power cord before attempting to reseat, install, or remove a memory module.

For those systems that support ECC memory, HP does not support mixing ECC and non-ECC memory. Otherwise, the computer will not boot the operating system.



NOTE: The memory count will be affected by configurations with the Management Engine (ME) enabled. The ME uses 8MB of system memory in single channel mode or 16MB of memory in dual-channel mode to download, decompress, and execute the ME firmware for Out-of-Band (OOB), third-party data storage, and other management functions.

System will not boot or does not function properly after installing additional memory modules.

Cause

Solution

A memory module is not installed in the DIMM1 or XMM1 socket.

Ensure that a memory module is installed in the DIMM1 or XMM1 socket on the system board. This socket must be populated with a memory module.

Memory module is not the correct type or speed grade for the system or the new memory module is not seated properly.

Replace module with the correct industry-standard device for the computer. On some models, ECC and non-ECC memory modules cannot be mixed.

Out of memory error.

Cause

Solution

You have run out of memory to run the application.

Check the application documentation to determine the memory requirements.

Memory count during POST is wrong.

Cause

Solution

The memory modules may not be installed correctly.

Check that the memory modules have been installed correctly and that proper modules are used.

Integrated graphics may use system memory.

No action required.

Insufficient memory error during operation.

Cause

Solution

Too many Terminate and Stay Resident programs (TSRs) are installed.

Delete any TSRs that you do not need.

You have run out of memory for the application.

Check the memory requirements for the application or add more memory to the computer.

Power LED flashes Red five times, once every second, followed by a two second pause, and the computer beeps five times. (Beeps stop after fifth iteration but LEDs continue flashing.)

Cause	Solution
Memory is installed incorrectly or is bad.	<ol style="list-style-type: none">1. Reseat DIMMs. Power on the system.2. Replace DIMMs one at a time to isolate the faulty module.3. Replace third-party memory with HP memory.4. Replace the system board.

Solving processor problems

If you encounter processor problems, common causes and solutions are listed in the following table.

Poor performance is experienced.

Cause	Solution
Processor is hot.	<ol style="list-style-type: none">1. Make sure the airflow to the computer is not blocked.2. Make sure the fans are connected and working properly (some fans only operate when needed).3. Make sure the processor heat sink is installed properly.

Power LED flashes Red three times, once every second, followed by a two second pause.

Cause	Solution
Processor is not seated properly or not installed.	<ol style="list-style-type: none">1. Check to see that the processor is present.2. Reseat the processor.

Power LED flashes Red eleven times, once every second, followed by a two second pause.

Cause	Solution
The current processor does not support a feature previously enabled on this system.	<ol style="list-style-type: none">1. Install a TXT (Trusted Execution Technology) capable processor.2. Disable TXT in the Computer Setup (F10) utility.3. Reinstall the original processor.

Solving CD-ROM and DVD problems

If you encounter CD-ROM or DVD problems, see the common causes and solutions listed in the following table or to the documentation that came with the optional device.

System will not boot from CD-ROM or DVD drive.

Cause	Solution
The device is attached to a SATA port that has been hidden in the Computer Setup utility.	Run the Computer Setup utility and ensure Device Available is selected for the device's SATA port in Security > Device Security .
Removable Media Boot is disabled in the Computer Setup utility.	Run the Computer Setup utility and enable booting to removable media in Storage > Storage Options . Ensure CD-ROM is enabled in Storage > Boot Order .
Network Boot is enabled in Computer Setup.	Run the Computer Setup utility and disable Network Boot in Security > Network Boot .
Non-bootable CD in drive.	Try a bootable CD in the drive.
Boot order not correct.	Run the Computer Setup utility and change boot sequence in Storage > Boot Order .

Drive not found (identified).

Cause	Solution
Cable could be loose.	Check cable connections.
The system may not have automatically recognized a newly installed device.	See reconfiguration directions in the Solving Hardware Installation Problems on page 221 section. If the system still does not recognize the new device, check to see if the device is listed within Computer Setup. If it is listed, the probable cause is a driver problem. If it is not listed, the probable cause is a hardware problem. If this is a newly installed drive, run the Computer Setup utility and try adding a POST delay under Advanced > Power-On Options .
The device is attached to a SATA port that has been hidden in Computer Setup.	Run the Computer Setup utility and ensure Device Available is selected for the device's SATA port in Security > Device Security .
Drive responds slowly immediately after power-up.	Run Computer Setup and increase the POST Delay in Advanced > Power-On Options .

CD-ROM or DVD devices are not detected or driver is not loaded.

Cause	Solution
Drive is not connected properly or not properly configured.	See the documentation that came with the optional device.

Movie will not play in the DVD drive.

Cause	Solution
Movie may be regionalized for a different country.	See the documentation that came with the DVD drive.
Decoder software is not installed.	Install decoder software.
Damaged media.	Replace media.
Movie rating locked out by parental lock.	Use DVD software to remove parental lock.
Media installed upside down.	Reinstall media.

Cannot eject compact disc (tray-load unit).

Cause	Solution
Disc not properly seated in the drive.	Turn off the computer and insert a thin metal rod into the emergency eject hole and push firmly. Slowly pull the tray out from the drive until the tray is fully extended, then remove the disc.

CD-ROM, CD-RW, DVD-ROM, or DVD-R/RW drive cannot read a disc or takes too long to start.

Cause	Solution
Media is corrupt.	Try different media to confirm whether media is valid.
Media has been inserted upside down.	Re-insert the media with the label facing up.
The DVD-ROM drive takes longer to start because it has to determine the type of media played, such as audio or video.	Wait at least 30 seconds to let the DVD-ROM drive determine the type of media being played. If the disc still does not start, read the other solutions listed for this topic.
CD or DVD disc is dirty.	Clean CD or DVD with a CD cleaning kit, available from most computer stores.
Windows does not detect the CD-ROM or DVD-ROM drive.	<ol style="list-style-type: none">1. Use Device Manager to remove or uninstall the device. To access Device Manager in Windows 7, click Start, select Control Panel, and then select Device Manager. To access Device Manager in Windows 8, from the Start screen, type c, select Control Panel from the list of applications, and then select Device Manager.2. Restart the computer and let Windows detect the CD or DVD driver.

Recording or copying CDs is difficult or impossible.

Cause	Solution
Wrong or poor quality media type.	<ol style="list-style-type: none">1. Try using a slower speed when recording.2. Verify that you are using the correct media for the drive.3. Try a different brand of media. Quality varies widely between manufacturers.

Solving USB flash drive problems

If you encounter USB flash drive problems, common causes and solutions are listed in the following table.

USB flash drive is not seen as a drive letter in Windows.

Cause	Solution
The drive letter after the last physical drive is not available.	Change the default drive letter for the flash drive in Windows.

USB flash drive not found (identified).

Cause	Solution
The device is attached to a USB port that has been hidden in Computer Setup.	Run the Computer Setup utility and enable USB ports in Security > USB Security .
The device was not properly seated before power-up.	Ensure the device is fully inserted into the USB port before applying power to the system

System will not boot from USB flash drive.

Cause	Solution
Boot order is not correct.	Run the Computer Setup utility and change boot sequence in Storage > Boot Order .
Removable Media Boot is disabled in the Computer Setup utility.	Run the Computer Setup utility and enable booting to removable media in Storage > Storage Options . Ensure USB is enabled in Storage > Boot Order .

The computer boots to DOS after making a bootable flash drive.

Cause	Solution
Flash drive is bootable.	Install the flash drive only after the operating system boots.
Flash drive is defective.	Try a different flash drive.

Solving front panel component problems

If you encounter problems with devices connected to the front panel, refer to the common causes and solutions listed in the following table.

A USB device, headphone, or microphone is not recognized by the computer.

Cause	Solution
Device is not properly connected.	<ol style="list-style-type: none">1. Turn off the computer.2. Reconnect the device to the front of the computer and restart the computer.
The device does not have power.	If the USB device requires AC power, be sure one end is connected to the device and one end is connected to a live outlet.
The correct device driver is not installed.	<ol style="list-style-type: none">1. Install the correct driver for the device.2. You might need to reboot the computer.
The cable from the device to the computer does not work.	<ol style="list-style-type: none">1. If possible, replace the cable.2. Restart the computer.
The device is not working.	<ol style="list-style-type: none">1. Replace the device.2. Restart the computer.
USB ports on the computer are disabled in Computer Setup.	Run the Computer Setup utility and ensure that the USB ports are set to Enabled in Security > USB Security .

Solving Internet access problems

If you encounter Internet access problems, consult your Internet Service Provider (ISP) or refer to the common causes and solutions listed in the following table.

Unable to connect to the Internet.

Cause	Solution
Internet Service Provider (ISP) account is not set up properly.	Verify Internet settings or contact your ISP for assistance.
Web browser is not set up properly.	Verify that the Web browser is installed and set up to work with your ISP.
Cable/DSL modem is not plugged in.	Plug in cable/DSL modem. You should see a "power" LED light on the front of the cable/DSL modem.
Cable/DSL service is not available or has been interrupted due to bad weather.	Try connecting to the Internet at a later time or contact your ISP. (If the cable/DSL service is connected, the "cable" LED light on the front of the cable/DSL modem will be on.)

Unable to connect to the Internet.

Cause	Solution
The CAT5 UTP cable is disconnected.	Connect the CAT5 UTP cable between the cable modem and the computers' RJ-45 connector. (If the connection is good, the "PC" LED light on the front of the cable/DSL modem will be on.)
IP address is not configured properly.	Contact your ISP for the correct IP address.
Cookies are corrupted. (A "cookie" is a small piece of information that a Web server can store temporarily with the Web browser. This is useful for having the browser remember some specific information that the Web server can later retrieve.)	Windows 7: <ol style="list-style-type: none">1. Select Start > Control Panel.2. Click Internet Options.3. In the Browsing history section on the General tab, click the Delete button.4. Select the Cookies check box and click the Delete button. Windows 8: <ol style="list-style-type: none">1. From the Start screen, type c, and then select Control Panel from the list of applications..2. Click Internet Options.3. In the Browsing history section on the General tab, click the Delete button.4. Select the Cookies check box and click the Delete button.

Cannot automatically launch Internet programs.

Cause	Solution
You must log on to your ISP before some programs will start.	Log on to your ISP and launch the desired program.

Solving software problems

Most software problems occur as a result of the following:

- The application was not installed or configured correctly.
- There is insufficient memory available to run the application.
- There is a conflict between applications.
- Be sure that all the needed device drivers have been installed.
- If you have installed an operating system other than the factory-installed operating system, check to be sure it is supported on the system.

If you encounter software problems, see the applicable solutions listed in the following table.

Computer will not continue and the HP logo does not display.

Cause	Solution
ROM issue - POST error has occurred.	Observe the beeps and LED lights on the front of the computer. See Appendix A, POST error messages on page 237 to determine possible causes. See the Worldwide Limited Warranty for terms and conditions.

Computer will not continue after HP logo screen displays.

Cause	Solution
System files may be damaged.	<p>In Windows 7, use recovery media to scan hard drive for errors, or use Windows Startup Repair to fix problems that might prevent Windows from starting correctly. Windows Startup Repair is one of the recovery tools in the System Recovery Options menu. You can also create a system repair disc that contains the System Recovery Options menu. If the problem is severe enough that Startup Repair doesn't start on its own and you can't access the System Recovery Options menu on your computer's hard disk, you can get to the menu and start Startup Repair by using the Windows installation disc or a system repair disc that you created earlier.</p> <p>In Windows 8, use Automatic Repair to fix problems that might prevent Windows from starting correctly.</p> <p>To access Automatic Repair:</p> <ol style="list-style-type: none">1. Press the Windows logo + I to open the Settings charm.2. Select Change PC Settings, select General, and then under Advanced startup, click Restart now.3. Select Troubleshoot, select Advanced options, and then select Automatic Repair. <p>Windows starts Automatic Repair.</p> <ol style="list-style-type: none">4. Select the account to use to begin Automatic Repair, and type the password for the account. <p>Windows diagnoses the computer and attempts the repair it.</p>

"Illegal Operation has Occurred" error message is displayed.

Cause	Solution
Software being used is not Microsoft-certified for your version of Windows.	Verify that the software is certified by Microsoft for your version of Windows (see program packaging for this information).
Configuration files are corrupt.	If possible, save all data, close all programs, and restart the computer.

10 POST error messages

This appendix lists the error codes, error messages, and the various indicator light and audible sequences that you may encounter during Power-On Self-Test (POST) or computer restart, the probable source of the problem, and steps you can take to resolve the error condition.

POST Message Disabled suppresses most system messages during POST, such as memory count and non-error text messages. If a POST error occurs, the screen will display the error message. To manually switch to the POST Messages Enabled mode during POST, press any key (except **F10**, **F11**, or **F12**). The default mode is POST Message Disabled.

The speed at which the computer loads the operating system and the extent to which it is tested are determined by the POST mode selection.

Quick Boot is a fast startup process that does not run all of the system level tests, such as the memory test. Full Boot runs all of the ROM-based system tests and takes longer to complete.

Full Boot may also be enabled to run every 1 to 30 days on a regularly scheduled basis. To establish the schedule, reconfigure the computer to the Full Boot Every x Days mode, using Computer Setup.



NOTE: For more information on Computer Setup, see [Computer Setup \(F10\) Utility on page 180](#).

POST numeric codes and text messages

This section covers those POST errors that have numeric codes associated with them. The section also includes some text messages that may be encountered during POST.



NOTE: The computer will beep once after a POST text message is displayed on the screen.

Control panel message	Description	Recommended action
101-Option ROM Checksum Error	System ROM or expansion board option ROM checksum.	<ol style="list-style-type: none">1. Verify the correct ROM.2. Flash the ROM if needed.3. If an expansion board was recently added, remove it to see if the problem remains.4. Clear CMOS. (See Appendix B, Password security and resetting CMOS on page 250.)5. If the message disappears, there may be a problem with the expansion card.6. Replace the system board.
103-System Board Failure	DMA or timers.	<ol style="list-style-type: none">1. Clear CMOS. (See Appendix B, Password security and resetting CMOS on page 250.)2. Remove expansion boards.3. Replace the system board.
110-Out of Memory Space for Option ROMs	Recently added PCI expansion card contains an option ROM too large to download during POST.	<ol style="list-style-type: none">1. If a PCI expansion card was recently added, remove it to see if the problem remains.2. In Computer Setup, set Advanced > Device Options > NIC PXE Option ROM Download to DISABLE to prevent PXE option ROM for the internal NIC from being downloaded during POST to free more memory for an expansion card's option ROM. Internal PXE option ROM is used for booting from the NIC to a PXE server.
162-System Options Not Set	Configuration incorrect. RTC (real-time clock) battery may need to be replaced.	Run Computer Setup and check the configuration in Advanced > Onboard Devices . Reset the date and time under Control Panel . If the problem persists, replace the RTC battery. See the Removal and Replacement section for instructions on installing a new battery, or contact an authorized dealer or reseller for RTC battery replacement.

Control panel message	Description	Recommended action
163-Time & Date Not Set	Invalid time or date in configuration memory. RTC (real-time clock) battery may need to be replaced.	Reset the date and time under Control Panel (Computer Setup can also be used). If the problem persists, replace the RTC battery. See the Removal and Replacement section for instructions on installing a new battery, or contact an authorized dealer or reseller for RTC battery replacement.
163-Time & Date Not Set	CMOS jumper may not be properly installed.	Check for proper placement of the CMOS jumper if applicable.
164-MemorySize Error	Memory amount has changed since the last boot (memory added or removed).	Press the F1 key to save the memory changes.
164-MemorySize Error	Memory configuration incorrect.	<ol style="list-style-type: none"> 1. Run Computer Setup or Windows utilities. 2. Make sure the memory module(s) are installed properly. 3. If third-party memory has been added, test using HP-only memory. 4. Verify proper memory module type.
201-Memory Error	RAM failure.	<ol style="list-style-type: none"> 1. Ensure memory modules are correctly installed. 2. Verify proper memory module type. 3. Remove and replace the identified faulty memory module(s). 4. If the error persists after replacing memory modules, replace the system board.
213-Incompatible Memory Module in Memory Socket(s) X, X, ...	A memory module in memory socket identified in the error message is missing critical SPD information, or is incompatible with the chipset.	<ol style="list-style-type: none"> 1. Verify proper memory module type. 2. Try another memory socket. 3. Replace DIMM with a module conforming to the SPD standard.
214-DIMM Configuration Warning	Populated DIMM Configuration is not optimized.	Rearrange the DIMMs so that each channel has the same amount of memory.
219-ECC Memory Module Detected ECC Modules not supported on this Platform	Recently added memory module(s) support ECC memory error correction.	<ol style="list-style-type: none"> 1. If additional memory was recently added, remove it to see if the problem remains. 2. Check product documentation for memory support information.

Control panel message	Description	Recommended action
301-Keyboard Error	Keyboard failure.	<ol style="list-style-type: none"> 1. Reconnect keyboard with computer turned off. 2. Check connector for bent or missing pins. 3. Ensure that none of the keys are depressed. 4. Replace keyboard.
303-Keyboard Controller Error	I/O board keyboard controller.	<ol style="list-style-type: none"> 1. Reconnect keyboard with computer turned off. 2. Replace the system board.
304-Keyboard or System Unit Error	Keyboard failure.	<ol style="list-style-type: none"> 1. Reconnect the keyboard with computer turned off. 2. Ensure that none of the keys are depressed. 3. Replace the keyboard. 4. Replace the system board.
501-Display Adapter Failure	Graphics display controller.	<ol style="list-style-type: none"> 1. Reseat the graphics card (if applicable). 2. Clear CMOS. (See Appendix B, Password security and resetting CMOS on page 250.) 3. Verify monitor is attached and turned on. 4. Replace the graphics card (if possible).
510-Flash Screen Image Corrupted	Flash Screen image has errors.	Reflash the system ROM with the latest BIOS image.
511-CPU, CPUA, or CPUB Fan not Detected	CPU fan is not connected or may have malfunctioned.	<ol style="list-style-type: none"> 1. Reseat CPU fan. 2. Reseat fan cable. 3. Replace CPU fan.
512-Chassis, Rear Chassis, or Front Chassis Fan not Detected	Chassis, rear chassis, or front chassis fan is not connected or may have malfunctioned.	<ol style="list-style-type: none"> 1. Reseat chassis, rear chassis, or front chassis fan. 2. Reseat fan cable. 3. Replace chassis, rear chassis, or front chassis fan.
513-Front Chassis fan not detected	Front chassis fan is not connected or may have malfunctioned.	<ol style="list-style-type: none"> 1. Reseat front chassis fan. 2. Reseat fan cable. 3. Replace front chassis fan.

Control panel message	Description	Recommended action
514-CPU or Chassis Fan not Detected	CPU or chassis fan is not connected or may have malfunctioned.	<ol style="list-style-type: none"> 1. Reseat CPU or chassis fan. 2. Reseat fan cable. 3. Replace CPU or chassis fan.
515-Power Supply fan not detected	Power supply fan is not connected or may have malfunctioned.	<ol style="list-style-type: none"> 1. Reseat power supply fan. 2. Reseat fan cable. 3. Replace power supply fan.
601-Diskette Controller Error	Diskette controller circuitry or floppy drive circuitry incorrect.	<ol style="list-style-type: none"> 1. Check and/or replace cables. 2. Clear CMOS. (See Appendix B, Password security and resetting CMOS on page 250.) 3. Replace diskette drive. 4. Replace the system board.
605-Diskette Drive Type Error	Mismatch in drive type.	<ol style="list-style-type: none"> 1. Disconnect any other diskette controller devices (tape drives). 2. Clear CMOS. (See Appendix B, Password security and resetting CMOS on page 250.)
660-Display cache is detected unreliable	Integrated graphics controller display cache is not working properly and will be disabled.	Replace system board if minimal graphics degrading is an issue.
912-Computer Cover Has Been Removed Since Last System Startup	Computer cover was removed since last system startup.	No action required.
917-Front Audio Not Connected	Front audio harness has been detached or unseated from motherboard.	Reconnect or replace front audio harness.
918-Front USB Not Connected	Front USB harness has been detached or unseated from motherboard.	Reconnect or replace front USB harness.
921-Device in PCI Express slot failed to initialize	There is an incompatibility/problem with this device and the system or PCI Express Link could not be retrained to an x1.	Try rebooting the system. If the error reoccurs, the device may not work with this system
1151-Serial Port A Address Conflict Detected	Both external and internal serial ports are assigned to COM1.	<ol style="list-style-type: none"> 1. Remove any serial port expansion cards. 2. Clear CMOS. (See Appendix B, Password security and resetting CMOS on page 250.) 3. Reconfigure card resources and/or run Computer Setup or Windows utilities.

Control panel message	Description	Recommended action
1152-Serial Port B Address Conflict Detected	Both external and internal serial ports are assigned to COM2.	<ol style="list-style-type: none"> 1. Remove any serial port expansion cards. 2. Clear CMOS. (See Appendix B, Password security and resetting CMOS on page 250.) 3. Reconfigure card resources and/or run Computer Setup or Windows utilities.
1155-Serial Port Address Conflict Detected	Both external and internal serial ports are assigned to same IRQ.	<ol style="list-style-type: none"> 1. Remove any serial port expansion cards. 2. Clear CMOS. (See Appendix B, Password security and resetting CMOS on page 250.) 3. Reconfigure card resources and/or run Computer Setup or Windows utilities.
1720-SMART Hard Drive Detects Imminent Failure	Hard drive is about to fail. (Some hard drives have a hard drive firmware patch that will fix an erroneous error message.)	<ol style="list-style-type: none"> 1. Determine if hard drive is giving correct error message. Enter Computer Setup and run the Drive Protection System test under Storage > DPS Self-test. 2. Apply hard drive firmware patch if applicable. (Available at http://www.hp.com/support.) 3. Back up contents and replace hard drive.
1796-SATA Cabling Error	One or more SATA devices are improperly attached. For optimal performance, the SATA 0 and SATA 1 connectors must be used before SATA 2 and SATA 3.	Ensure SATA connectors are used in ascending order. For one device, use SATA 0. For two devices, use SATA 0 and SATA 1. For three devices, use SATA 0, SATA 1, and SATA 2.
1797-SATA Drivelock is not supported in RAID mode.	Drivelock is enabled on one or more SATA hard drives, and they cannot be accessed while the system is configured for RAID mode.	Either remove the Drivelocked SATA device or disable the Drivelock feature. To disable the Drivelock feature, enter Computer Setup, change Storage > Storage Options > SATA Emulation to IDE , and select File > Save Changes and Exit . Reenter Computer Setup and select Security > Drivelock Security . For each listed Drivelock-capable SATA device, ensure Drivelock is Disabled . Lastly, change Storage > Storage Options > SATA Emulation back to RAID and select File > Save Changes and Exit .
1801-Microcode Patch Error	Processor is not supported by ROM BIOS.	<ol style="list-style-type: none"> 1. Upgrade BIOS to proper version. 2. Change the processor.

Control panel message	Description	Recommended action
2200-PMM Allocation Error during MEBx Download	Memory error during POST execution of the Management Engine (ME) BIOS Extensions option ROM.	<ol style="list-style-type: none"> 1. Reboot the computer. 2. Unplug the power cord, re-seat the memory modules, and reboot the computer. 3. If the memory configuration was recently changed, unplug the computer, restore the original memory configuration, and reboot the computer. 4. If the error persists, replace the system board.
2201-MEBx Module did not checksum correctly	Memory error during POST execution of the Management Engine (ME) BIOS Extensions option ROM.	<ol style="list-style-type: none"> 1. Reboot the computer. 2. Unplug the power cord, re-seat the memory modules, and reboot the computer. 3. If the memory configuration was recently changed, unplug the power cord, restore the original memory configuration, and reboot the computer. 4. If the error persists, replace the system board.
2202-PMM Deallocation Error during MEBx cleanup	Memory error during POST execution of the Management Engine (ME) BIOS Extensions option ROM.	<ol style="list-style-type: none"> 1. Reboot the computer. 2. Unplug the power cord, re-seat the memory modules, and reboot the computer. 3. If the memory configuration was recently changed, unplug the power cord, restore the original memory configuration, and reboot the computer. 4. If the error persists, replace the system board.
2203-Setup error during MEBx execution	MEBx selection or exit resulted in a setup failure.	<ol style="list-style-type: none"> 1. Reboot the computer. 2. Unplug the power cord, re-seat the memory modules, and reboot the computer. 3. If the memory configuration was recently changed, unplug the power cord, restore the original memory configuration, and reboot the computer. 4. If the error persists, replace the system board.

Control panel message	Description	Recommended action
2204-Inventory error during MEBx execution	BIOS information passed to the MEBx resulted in a failure.	<ol style="list-style-type: none"> 1. Reboot the computer. 2. If the error persists, update to the latest BIOS version. 3. If the error still persists, replace the system board.
2205-Interface error during MEBx execution	MEBx operation experienced a hardware error during communication with ME.	<ol style="list-style-type: none"> 1. Reboot the computer. 2. If the error persists, update to the latest BIOS version. 3. If the error still persists, replace the system board.
2211-Memory not configured correctly for proper MEBx execution.	DIMM1 or XMM1 is not installed.	Make sure there is a memory module in the black DIMM1 socket and that it is properly seated.
2212-USB Key Provisioning failure writing to device	USB device used for USB key provisioning will not allow BIOS to update provision file properly.	<ol style="list-style-type: none"> 1. Try a different USB key device for provisioning. 2. If the error persists, update to the latest BIOS version and ME firmware version. 3. If the error still persists, replace the system board.
2217-ME Firmware Version request failure	ME firmware is not properly responding to BIOS query for version information.	<ol style="list-style-type: none"> 1. Reboot the computer. 2. If the error persists, update to the latest BIOS version and ME firmware version. 3. If the error still persists, replace the system board.
2218-ME Firmware Version should be updated	ME firmware must be updated to match current functionality contained in the system BIOS.	<ol style="list-style-type: none"> 1. Update to the latest ME firmware version. 2. If the error persists and system BIOS has been recently updated, restore previous system BIOS version. 3. If the error still persists, replace the system board.
2219-USB Key Provisioning file has invalid header identifier	Provisioning file contained on the USB key has been corrupted or is not a valid version for the current ME firmware.	<ol style="list-style-type: none"> 1. Recreate the provisioning file using third party management console software. 2. If the error persists and system BIOS has been recently updated, restore previous system BIOS version. Otherwise, update the ME firmware version. 3. If the error still persists, replace the system board.

Control panel message	Description	Recommended action
2220-USB Key Provisioning file has mismatch version	Provisioning file contained on the USB key is not a valid version for the current ME firmware.	<ol style="list-style-type: none"> 1. Reboot the computer. 2. If the error persists and system BIOS has been recently updated, restore previous system BIOS version. Otherwise, update the ME firmware version. 3. If the error still persists, replace the system board.
2230-General error during MEBx execution	Error occurred during MEBx execution which fails into the "General" grouping. Status information displayed along with the error provides further clarity into the failure. MEBx handles transference of information between the system BIOS and ME firmware.	<ol style="list-style-type: none"> 1. Reboot the computer. 2. If the error persists, update to the latest BIOS version and ME firmware version. 3. If the error still persists, replace the system board.
2231-ME error during MEBx execution	Error occurred during MEBx execution which fails into "ME" grouping.	<ol style="list-style-type: none"> 1. Reboot the computer. 2. If the error persists, update to the latest BIOS version and ME firmware version. 3. If the error still persists, replace the system board.
2232-AMT error during MEBx execution	Error occurred during MEBx execution which fails into "AMT" grouping.	<ol style="list-style-type: none"> 1. Reboot the computer. 2. If the error persists, update to the latest BIOS version and ME firmware version. 3. If the error still persists, replace the system board.
2233-HECI error during MEBx execution	Error occurred during MEBx execution which fails into "MEI or HECI" grouping.	<ol style="list-style-type: none"> 1. Reboot the computer. 2. If the error persists, update to the latest BIOS version and ME firmware version. 3. If the error still persists, replace the system board.
2239-ME image lock failure	Special system configurations with reduced ME firmware image require BIOS control of ME firmware upgrading. A failure has occurred after the ME firmware update process in which the BIOS could not relock the ME firmware region.	<ol style="list-style-type: none"> 1. Reboot the computer. 2. If the error persists, update to the latest BIOS version and ME firmware version. 3. If the error still persists, replace the system board.
2240-ME image unlock failure	Special system configurations with reduced ME firmware image require BIOS control of ME firmware upgrading. A failure has occurred prior to the ME firmware update process in which the BIOS could not unlock the ME firmware region.	<ol style="list-style-type: none"> 1. Reboot the computer. 2. If the error persists, update to the latest BIOS version and ME firmware version. 3. If the error still persists, replace the system board.
Invalid Electronic Serial Number	Electronic serial number is missing.	Enter the correct serial number in Computer Setup.

Control panel message	Description	Recommended action
Network Server Mode Active and No Keyboard Attached	Keyboard failure while Network Server Mode enabled.	<ol style="list-style-type: none"> 1. Reconnect keyboard with computer turned off. 2. Check connector for bent or missing pins. 3. Ensure that none of the keys are depressed. 4. Replace keyboard.
Parity Check 2	Parity RAM failure.	Run Computer Setup and Diagnostic utilities.

Interpreting POST diagnostic front panel LEDs and audible codes

This section covers the front panel LED codes as well as the audible codes that may occur before or during POST that do not necessarily have an error code or text message associated with them.

 **WARNING!** When the computer is plugged into an AC power source, voltage is always applied to the system board. To reduce the risk of personal injury from electrical shock and/or hot surfaces, be sure to disconnect the power cord from the wall outlet and allow the internal system components to cool before touching.

 **NOTE:** If you see flashing LEDs on a PS/2 keyboard, look for flashing LEDs on the front panel of the computer and refer to the following table to determine the front panel LED codes.

Recommended actions in the following table are listed in the order in which they should be performed.

Not all diagnostic lights and audible codes are available on all models.

Activity	Beeps	Possible cause	Recommended action
White Power LED On.	None	Computer on.	None
White Power LED flashes every two seconds.	None	Computer in Suspend to RAM mode (some models only) or normal Suspend mode.	None required. Press any key or move the mouse to wake the computer.

Activity	Beeps	Possible cause	Recommended action
Red Power LED flashes two times, once every second, followed by a two second pause. Beeps stop after fifth iteration but LEDs continue until problem is solved.	2	Processor thermal protection activated: A fan may be blocked or not turning. OR The heat sink/fan assembly is not properly attached to the processor.	<ol style="list-style-type: none"> 1. Ensure that the computer air vents are not blocked and the processor cooling fan is running. 2. Open hood, press power button, and see if the processor fan spins. If the processor fan is not spinning, make sure the fan's cable is plugged onto the system board header. 3. If fan is plugged in, but is not spinning, then replace heat sink/fan assembly. 4. Contact an authorized reseller or service provider.
Red Power LED flashes three times, once every second, followed by a two second pause. Beeps stop after fifth iteration but LEDs continue until problem is solved.	3	Processor not installed (not an indicator of bad processor).	<ol style="list-style-type: none"> 1. Check to see that the processor is present. 2. Reseat the processor.
Red Power LED flashes four times, once every second, followed by a two second pause. Beeps stop after fifth iteration but LEDs continue until problem is solved.	4	Power failure (power supply is overloaded). OR The incorrect external power supply adapter is being used on the USDT.	<ol style="list-style-type: none"> 1. Open the hood and ensure the 4 or 6-wire power supply cable is seated into the connector on the system board. 2. Check if a device is causing the problem by removing ALL attached devices (such as hard, diskette, or optical drives, and expansion cards). Power on the system. If the system enters the POST, then power off and replace one device at a time and repeat this procedure until failure occurs. Replace the device that is causing the failure. Continue adding devices one at a time to ensure all devices are functioning properly. 3. Replace the power supply. 4. Replace the system board. <p>OR</p> <p>The USDT power supply adapter must be at 135W and use the Smart ID technology before the system will power up. Replace the power supply adapter with the HP-supplied USDT power supply adapter.</p>

Activity	Beeps	Possible cause	Recommended action
Red Power LED flashes five times, once every second, followed by a two second pause. Beeps stop after fifth iteration but LEDs continue until problem is solved.	5	Pre-video memory error.	<p>CAUTION: To avoid damage to the DIMMs or the system board, you must unplug the computer power cord before attempting to reseat, install, or remove a DIMM module.</p> <ol style="list-style-type: none"> 1. Reseat DIMMs. 2. Replace DIMMs one at a time to isolate the faulty module. 3. Replace third-party memory with HP memory. 4. Replace the system board.
Red Power LED flashes six times, once every second, followed by a two second pause. Beeps stop after fifth iteration but LEDs continue until problem is solved.	6	Pre-video graphics error.	<p>For systems with a graphics card:</p> <ol style="list-style-type: none"> 1. Reseat the graphics card. 2. Replace the graphics card. 3. Replace the system board. <p>For systems with integrated graphics, replace the system board.</p>
Red Power LED flashes seven times, once every second, followed by a two second pause. Beeps stop after fifth iteration but LEDs continue until problem is solved.	7	System board failure (ROM detected failure prior to video).	Replace the system board.
Red Power LED flashes eight times, once every second, followed by a two second pause. Beeps stop after fifth iteration but LEDs continue until problem is solved.	8	Invalid ROM based on bad checksum.	<ol style="list-style-type: none"> 1. Reflash the system ROM with the latest BIOS image. 2. Replace the system board.
Red Power LED flashes nine times, once every second, followed by a two second pause. Beeps stop after fifth iteration but LEDs continue until problem is solved.	9	System powers on but is unable to boot.	<ol style="list-style-type: none"> 1. Check that the voltage selector, located on the rear of the power supply (some models), is set to the appropriate voltage. Proper voltage setting depends on your region. 2. Unplug the AC power cord from the computer, wait 30 seconds, then plug the power cord back in to the computer. 3. Replace the system board. 4. Replace the processor.

Activity	Beeps	Possible cause	Recommended action
Red Power LED flashes ten times, once every second, followed by a two second pause. Beeps stop after fifth iteration but LEDs continue until problem is solved.	10	Bad option card.	<ol style="list-style-type: none"> 1. Check each option card by removing the card (one at a time if multiple cards), then power on the system to see if fault goes away. 2. Once a bad card is identified, remove and replace the bad option card. 3. Replace the system board.
Red Power LED flashes eleven times, once every second, followed by a two second pause. Beeps stop after fifth iteration but LEDs continue until problem is solved.	11	The current processor does not support a feature previously enabled on this system.	<ol style="list-style-type: none"> 1. Install a TXT capable processor. 2. Disable TXT in the Computer Setup (F10) utility. 3. Reinstall the original processor.
System does not power on and LEDs are not flashing.	None	System unable to power on.	<p>Press and hold the power button for less than 4 seconds. If the hard drive LED turns white, the power button is working correctly. Try the following:</p> <ol style="list-style-type: none"> 1. Check that the voltage selector (some models), located on the rear of the power supply, is set to the appropriate voltage. Proper voltage setting depends on your region. 2. Replace the system board. <p>OR</p> <p>Press and hold the power button for less than 4 seconds. If the hard drive LED does not turn on white then:</p> <ol style="list-style-type: none"> 1. Check that the unit is plugged into a working AC outlet. 2. Open hood and check that the power button harness is properly connected to the system board. 3. Check that both power supply cables are properly connected to the system board. 4. Check to see if the 5V_aux light on the system board is turned on. If it is turned on, then replace the power button harness. If the problem persists, replace the system board. 5. If the 5V_aux light on the system board is not turned on, remove the expansion cards one at a time until the 5V_aux light on the system board turns on. If the problem persists, replace the power supply.

11 Password security and resetting CMOS

This computer supports security password features, which can be established through the Computer Setup Utilities menu.

This computer supports two security password features that are established through the Computer Setup Utilities menu: setup password and power-on password. When you establish only a setup password, any user can access all the information on the computer except Computer Setup. When you establish only a power-on password, the power-on password is required to access Computer Setup and any other information on the computer. When you establish both passwords, only the setup password will give you access to Computer Setup.

When both passwords are set, the setup password can also be used in place of the power-on password as an override to log in to the computer. This is a useful feature for a network administrator.

If you forget the password for the computer, you can clear that password so you can gain access to the information on the computer by resetting the password jumper.

 **CAUTION:** Pushing the CMOS button will reset CMOS values to factory defaults. It is important to back up the computer CMOS settings before resetting them in case they are needed later. Back up is easily done through Computer Setup. See [Computer Setup \(F10\) Utility on page 180](#) for information on backing up the CMOS settings.

Resetting the password jumper

⚠ CAUTION: If you enable the stringent security feature in Computer Setup and you forget the setup password or the power-on password, the computer is inaccessible and can no longer be used.

Enabling the stringent password disables the ability to reset the password by moving the jumper on the system board.

If you lose or forget the password, the system board must be replaced. This scenario is not covered under warranty.

To prevent the computer from becoming permanently unusable, record your configured setup password or power-on password in a safe place away from your computer. Without these passwords, the computer cannot be unlocked.

To disable the power-on or setup password features, or to clear the power-on or setup passwords, complete the following steps:

1. Shut down the operating system properly, then turn off the computer and any external devices, and disconnect the power cord from the power outlet.
2. With the power cord disconnected, press the power button again to drain the system of any residual power.

⚠ WARNING! To reduce the risk of personal injury from electrical shock and/or hot surfaces, be sure to disconnect the power cord from the wall outlet, and allow the internal system components to cool before touching.

⚠ CAUTION: When the computer is plugged in, the power supply always has voltage applied to the system board even when the unit is turned off. Failure to disconnect the power cord can result in damage to the system.

Static electricity can damage the electronic components of the computer or optional equipment. Before beginning these procedures, ensure that you are discharged of static electricity by briefly touching a grounded metal object. See the *Safety & Regulatory Information* guide for more information.

3. Remove the computer cover or access panel.
4. Locate the header and jumper.

📄 NOTE: The password jumper is green so that it can be easily identified. For assistance locating the password jumper and other system board components, see the Illustrated Parts & Service Map (IPSM). The IPSM can be downloaded from <http://www.hp.com/support>.

5. Remove the jumper from pins 1 and 2. Place the jumper on either pin 1 or 2, but not both, so that it does not get lost.
6. Replace the computer cover or access panel.
7. Reconnect the external equipment.

8. Plug in the computer and turn on power. Allow the operating system to start. This clears the current passwords and disables the password features.
9. To establish new passwords, repeat steps 1 through 4, replace the password jumper on pins 1 and 2, then repeat steps 6 through 8. Establish the new passwords in Computer Setup.

Clearing and resetting the CMOS

The computer's configuration memory (CMOS) stores information about the computer's configuration.

The CMOS button resets CMOS but does not clear the power-on and setup passwords.

Clearing CMOS will clear the Active Management Technology (AMT) settings in the Management Engine BIOS Extension (MEBx), including the password. The password will default to "admin" and will need to be reset. The AMT settings will also need to be reset. To access the MEBx, press **Ctrl+P** during POST.

1. Turn off the computer and any external devices, and disconnect the power cord from the power outlet.
2. Disconnect the keyboard, monitor, and any other external equipment connected to the computer.

⚠ WARNING! To reduce the risk of personal injury from electrical shock and/or hot surfaces, be sure to disconnect the power cord from the wall outlet, and allow the internal system components to cool before touching.

⚠ CAUTION: When the computer is plugged in, the power supply always has voltage applied to the system board even when the unit is turned off. Failure to disconnect the power cord can result in damage to the system.

Static electricity can damage the electronic components of the computer or optional equipment. Before beginning these procedures, ensure that you are discharged of static electricity by briefly touching a grounded metal object. See the *Safety & Regulatory Information* guide for more information.

3. Remove the computer cover or access panel.

⚠ CAUTION: Pushing the CMOS button will reset CMOS values to factory defaults. It is important to back up the computer CMOS settings before resetting them in case they are needed later. Back up is easily done through Computer Setup. See [Computer Setup \(F10\) Utility on page 180](#) for information on backing up the CMOS settings.

4. Locate, press, and hold the CMOS button in for five seconds.

 **NOTE:** Make sure you have disconnected the AC power cord from the wall outlet. The CMOS button will not clear CMOS if the power cord is connected.



 **NOTE:** For assistance locating the CMOS button and other system board components, see the Illustrated Parts & Service Map (IPSM).

5. Replace the computer cover or access panel.
6. Reconnect the external devices.
7. Plug in the computer and turn on power.

 **NOTE:** You will receive POST error messages after clearing CMOS and rebooting advising you that configuration changes have occurred. Use Computer Setup to reset any special system setups along with the date and time.

For instructions on Computer Setup, see [Computer Setup \(F10\) Utility on page 180](#).

12 HP PC Hardware Diagnostics

To help troubleshoot and diagnose failures, use the UEFI-based hardware diagnostic solution that HP includes on all products. This tool can even be used if the computer will not boot to the operating system.

Why run HP PC Hardware Diagnostics – UEFI

The HP PC Hardware Diagnostic tools simplify the process of diagnosing hardware issues and expedite the support process when issues are found. The tools save time by pinpointing the component that needs to be replaced.

- **Isolate true hardware failures:** The diagnostics run outside of the operating system so they effectively isolate hardware failures from issues that may be caused by the operating system or other software components.
- **Failure ID:** When a failure is detected that requires hardware replacement, a 24-digit Failure ID is generated. This ID can then be provided to the call agent, who will either schedule support or provide replacement parts.

How to access and run HP PC Hardware Diagnostics - UEFI

To access the UEFI diagnostics:

1. Restart or turn on the computer and press **Esc** repeatedly until the BIOS boot menu appears.
2. Press **F2** or select **Diagnostics (F2)**.

How to access and run UEFI diagnostics

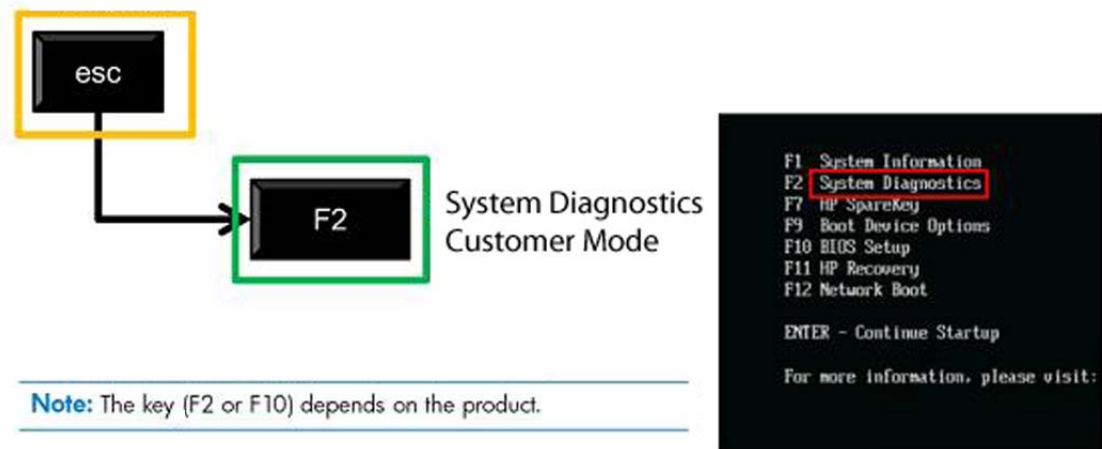

Note: The key (F2 or F10) depends on the product.

After pressing **F2**, the BIOS sequentially searches three places for the system diagnostics:

- a. **First** – a connected USB drive (to download the diagnostics tools to a USB drive, see the instructions in [Downloading HP PC Hardware Diagnostics to a USB device on page 255](#)).
- b. **Second** – the hard disk drive.
- c. **Third** – in the BIOS, a core set of diagnostics (for memory and hard disk drive) that are accessible only if the USB or hard disk drive versions are not detected.

Downloading HP PC Hardware Diagnostics to a USB device

1. Go to <http://www.hp.com>.
2. Click the **Support & Drivers** link.
3. Select the **Drivers & Software** tab.
4. Enter the product name in the text box and click **Search**.
5. Select your specific computer model.
6. Select your operating system.
7. In the Diagnostic section, click the **HP UEFI Support Environment** link. This link provides additional information.

- or -

Click the **Download** button and select **Run**. The download includes instructions (in English) on how to install the tools on the USB device.

 **NOTE:** HP diagnostic solutions are developed to test components typically included on HP products. They may not diagnose all third-party accessories that can be added to the system.

13 System backup and recovery

Backing up, restoring, and recovering in Windows 8

Your computer includes tools provided by HP and Windows to help you safeguard your information and retrieve it if you ever need to. These tools will help you return your computer to a proper working state or even back to the original factory state, all with simple steps.

This section provides information about the following processes:

- Creating recovery media and backups
- Restoring and recovering your system



NOTE: This section describes an overview of backing up, restoring, and recovering options. For more details about the tools provided, see Help and Support. From the Start screen, type **h**, and then select **Help and Support**.

Creating recovery media and backups

Recovery after a system failure is only as good as your most recent backup.

1. After you successfully set up the computer, create recovery media. This step creates a backup of the recovery partition on the computer. The backup can be used to reinstall the original operating system in cases where the hard drive is corrupted or has been replaced.

You will use a USB flash drive to create a bootable recovery drive that can be used to troubleshoot a Windows 8 computer that is unable to start. The USB flash drive can be used to reinstall the original operating system and the programs that were installed at the factory.

 **NOTE:** Any information on the USB flash drive will be erased before the recovery media is created.

To create the recovery media, from the Start screen, type `recovery drive`, and then click on **Settings**, then click on **Create a recovery drive**. Follow the on-screen instructions to continue.

2. As you add hardware and software programs, create system restore points. A system restore point is a snapshot of certain hard drive contents saved by Windows System Restore at a specific time. A system restore point contains information that Windows uses, such as registry settings. Windows creates a system restore point for you automatically during a Windows update and during other system maintenance (such as a software update, security scanning, or system diagnostics). You can also manually create a system restore point at any time. For more information and steps for creating specific system restore points, see Windows Help and Support. From the Start screen, type `h`, and then select **Help and Support**.
3. As you add photos, video, music, and other personal files, create a backup of your personal information. Windows File History can be set to regularly and automatically back up files from libraries, desktop, contacts, and favorites. If files are accidentally deleted from the hard drive and they can no longer be restored from the Recycle Bin, or if files become corrupted, you can restore the files that you backed up using File History. Restoring files is also useful if you ever choose to reset the computer by reinstalling Windows.

 **NOTE:** File History is not enabled by default, so you must turn it on.

For more information and steps for enabling Windows File History, see Windows Help and Support. From the Start screen, type `h`, and then select **Help and Support**.

Restoring and recovering using Windows 8 tools

Windows recovery tools provide access to several options for recovering your system. Choose the method that best matches your situation and level of expertise:

- If you need to restore your personal files and data, you can use Windows File History to restore your information from the backups you created. For more information and steps for using File History, see Windows Help and Support. From the Start screen, type **h**, and then select **Help and Support**.
- If you want to restore the system to a previous state without losing any personal information, Windows System Restore is an option. System Restore allows you to restore without the requirements of Windows Refresh or a reinstallation. Windows creates system restore points automatically during a Windows update and other system maintenance events. Even if you did not manually create a restore point, you can choose to restore to an automatically created restore point. For more information and steps for using Windows System Restore, see Windows Help and Support. From the Start screen, type **h**, and then select **Help and Support**.
- If you want a quick and easy way to recover the system without losing your personal information, settings, or apps that came preinstalled on your computer or were purchased from the Windows Store, Windows Refresh is an option. This method does not require backing up data to another drive. See [Using Windows 8 Refresh on page 258](#).
- If you want to reset your computer to its original state, Windows Reset provides an easy way to remove all personal data, apps, and settings, and reinstall Windows. The Reset recovery tool reinstalls the operating system and HP programs and drivers that were installed at the factory. Software not installed at the factory must be reinstalled. Any personal files must be restored from backups you made. See [Using Windows 8 Reset on page 259](#).
- If the computer is unable to start, you can use the Windows recovery USB flash drive you created to recover the system. See [Recovery using the Windows 8 recovery USB flash drive on page 260](#).
- If the computer is unable to start and you did not create a recovery USB flash drive or the one you created does not work, see [Recovery using Windows 8 operating system media \(purchased separately\) on page 261](#).

Using Windows 8 Refresh

 **NOTE:** You may be prompted for your permission or password when using Refresh. See Windows Help and Support for more information. From the Start screen, type **h**, and then select **Help and Support**.

 **IMPORTANT:** Refresh removes any traditional applications that were not originally installed on the system at the factory.

 **NOTE:** During Refresh, a list of removed traditional applications will be saved so that you have a quick way to see what you might need to reinstall. See Help and Support for instructions on reinstalling traditional applications. From the Start screen, type **h**, and then select **Help and Support**.

If Windows is responding, use these steps to start Refresh:

1. On the Start screen, point to the far-right upper or lower corner of the screen to display the charms.
2. Click **Settings**.
3. Click **Change PC settings** in the bottom-right corner of the screen, and then select **General** from the PC settings screen.
4. Under **Refresh your PC without affecting your files**, select **Get started**, and follow the on-screen instructions.

If Windows is not responding, use these steps to start Refresh:

1. If possible, back up all personal files.
2. If possible, check for the presence of the HP Recovery partition: From the Start screen, type *c*, and then select **Computer**

 **NOTE:** If the HP Recovery partition is not listed, or you cannot check for its presence, you must recover using the recovery media you created; see [Recovery using the Windows 8 recovery USB flash drive on page 260](#). Or you must use the Windows 8 operating system media and the *Driver Recovery* media (purchased separately); see [Recovery using Windows 8 operating system media \(purchased separately\) on page 261](#)

3. If the HP Recovery partition is listed, restart the computer, and then press *esc* while the company logo is displayed. The computer Startup Menu displays.
4. Press *f11* to select the System Recovery option.
5. Choose your keyboard layout.
6. Select **Troubleshoot**.
7. Select **Refresh**.
8. Follow the on-screen instructions to continue.

Using Windows 8 Reset

 **NOTE:** You may be prompted for your permission or password when using Reset. See Windows Help and Support for more information. From the Start screen, type *h*, and then select **Help and Support**.

 **IMPORTANT:** Reset does not provide backups of your information. Before using Reset, back up any personal information you wish to retain.

If Windows is responding, use these steps to start Reset:

1. On the Start screen, point to the far-right upper or lower corner of the screen to display the charms.
2. Click **Settings**.

3. Click **Change PC settings** in the bottom-right corner of the screen, and then select **General** from the PC settings screen.
4. Under **Remove everything and reinstall Windows**, select **Get started**, and follow the on-screen instructions.

If Windows is not responding, use these steps to start Reset:

1. If possible, back up all personal files.
2. If possible, check for the presence of the HP Recovery partition: From the Start screen, type *c*, and then select **Computer**.

 **NOTE:** If the HP Recovery partition is not listed, or you cannot check for its presence, you must recover using the recovery media you created; see [Recovery using the Windows 8 recovery USB flash drive on page 260](#). Or you must use the Windows 8 operating system media and the *Driver Recovery* media (purchased separately); see [Recovery using Windows 8 operating system media \(purchased separately\) on page 261](#).

3. If the HP Recovery partition is listed, restart the computer, and then press *esc* while the company logo is displayed. The computer Startup Menu displays.
4. Press *f11* to select the System Recovery option.
5. Choose your keyboard layout.
6. Select **Troubleshoot**.
7. Select **Reset**.
8. Follow the on-screen instructions to continue.

Recovery using the Windows 8 recovery USB flash drive

To recover your system using the recovery USB flash drive you previously created:

 **NOTE:** If you did not create a recovery USB flash drive or the one you created does not work, see [Recovery using Windows 8 operating system media \(purchased separately\) on page 261](#).

1. If possible, back up all personal files.
2. Insert the recovery USB flash drive you created into a USB port on your computer.
3. Restart the computer and as soon as you see the HP logo screen, press *f9* to display a list of boot devices. Use the arrow keys to select your USB flash drive from the UEFI Boot Sources list. Press *Enter* to boot from that device.
4. Choose your keyboard layout.
5. Select **Troubleshoot**.
6. Select **Refresh your PC**.
7. Follow the on-screen instructions.

Recovery using Windows 8 operating system media (purchased separately)

This recovery process requires Windows 8 operating system media, which can be ordered from the support website. For U.S. support, go to <http://www.hp.com/support>. For worldwide support, go to http://welcome.hp.com/country/us/en/wwcontact_us.html. You can also order the media by calling support. For contact information, see the *Worldwide Telephone Numbers* booklet included with the computer.

 **CAUTION:** Using Windows 8 operating system media completely erases hard drive contents and reformats the hard drive. All files that you have created and any software that you have installed on the computer are permanently removed. When reformatting is complete, the recovery process helps you restore the operating system, as well as drivers, software, and utilities.

To initiate recovery using Windows 8 operating system media:

 **NOTE:** This process takes several minutes.

1. If possible, back up all personal files.
2. Restart the computer, and then follow the instructions provided with the Windows 8 operating system media to install the operating system.
3. When prompted, press any keyboard key.
4. Follow the on-screen instructions.

After the repair is completed and the Windows 8 desktop appears:

1. Remove the Windows 8 operating system media, and then insert the *Driver Recovery* media.
2. Install the Hardware Enabling Drivers first, and then install Recommended Applications.

Backing up, restoring, and recovering in Windows 7

Your computer includes tools provided by HP and Windows to help you safeguard your information and retrieve it if you ever need to. These tools will help you return your computer to a proper working state or even back to the original factory state, all with simple steps.

This section provides information about the following processes:

- Creating recovery media and backups
- Restoring and recovering your system

 **NOTE:** This section describes an overview of backing up, restoring, and recovering options. For more details about the Windows Backup and Restore tools provided, see Help and Support. To access Help and Support, select **Start > Help and Support**.

Recovery after a system failure is only as good as your most recent backup.

1. After you successfully set up the computer, create recovery media. This media can be used to reinstall the original operating system in cases where the hard drive is corrupted or has been replaced. See [Creating recovery media on page 262](#).
2. As you add hardware and software programs, create system restore points. A system restore point is a snapshot of certain hard drive contents saved by Windows System Restore at a specific time. A system restore point contains information that Windows uses, such as registry settings. Windows creates a system restore point for you automatically during a Windows update and during other system maintenance (such as a software update, security scanning, or system diagnostics). You can also manually create a system restore point at any time. For more information and steps for creating specific system restore points, see Help and Support. To access Help and Support, select **Start > Help and Support**.
3. As you add photos, video, music, and other personal files, create a backup of your personal information. If files are accidentally deleted from the hard drive and they can no longer be restored from the Recycle Bin, or if files become corrupted, you can restore the files that you backed up. In case of system failure, you can use the backup files to restore the contents of your computer. See [Backing up your information on page 265](#).

 **NOTE:** HP recommends that you print the recovery procedures and save them for later use, in case of system instability.

Creating recovery media

After you successfully set up the computer, create recovery media. The media can be used to reinstall the original operating system in cases where the hard drive is corrupted or has been replaced.

There are two types of recovery media. To determine which steps to follow for your computer:

1. Click the **Start** button.
2. Click **All Programs**.
 - If **Security and Protection** is listed, continue with the steps in [Creating recovery media using HP Recovery Manager \(select models only\) on page 263](#).
 - If **Productivity and Tools** is listed, continue with the steps in [Creating recovery discs with HP Recovery Disc Creator \(select models only\) on page 264](#).

Creating recovery media using HP Recovery Manager (select models only)

- To create recovery discs, your computer must have a DVD writer. Use DVD+R or DVD-R discs (purchased separately). The discs you use will depend on the type of optical drive you are using.

 **NOTE:** DVD+R DL, DVD-R DL, or DVD±RW disc are not supported.

- You have the option of creating a recovery USB flash drive instead, using a high-quality USB drive.
- If you are creating recovery discs, be sure to use high-quality discs. It is normal for the system to reject defective discs. You will be prompted to insert a new blank disc to try again.
- The number of discs in the recovery-disc set depends on your computer model (typically 3 to 6 DVDs). The Recovery Media Creation program tells you the specific number of blank discs needed to make the set. If you are using a USB flash drive, the program will tell you the size of the drive required to store all the data (minimum of 8 GB).

 **NOTE:** The process of creating recovery media is lengthy. You can quit the process at any time. The next time you initiate the process, it resumes where it left off.

 **NOTE:** Do not use media cards for creating recovery media. The system may not be able to boot up from a media card and you may not be able to run system recovery.

To create recovery discs:

1. Close all open programs.
2. Click the **Start** button, click **All Programs**, click **Security and Protection**, click **Recovery Manager**, and then click **HP Recovery Media Creation**. If prompted, click **Yes** to allow the program to continue.
3. Click **Create recovery media using blank DVD(s)**, and then click **Next**.
4. Follow the on-screen instructions. Label each disc after you make it (for example, Recovery 1, Recovery 2), and then store the discs in a secure place.

To create a recovery USB flash drive:



NOTE: You must use a USB flash drive with a capacity of at least 8 GB.

1. Close all open programs.
2. Insert the USB flash drive into a USB port on the computer.
3. Click the **Start** button, click **All Programs**, click **Security and Protection**, click **Recovery Manager**, and then click **Recovery Media Creation**.
4. Click **Create recovery media with a USB flash drive**, and then click **Next**.
5. Select the USB flash drive from the list of media. The program will let you know how much storage is required to create the recovery drive. If the USB flash drive does not have enough storage capacity, it will appear grayed out, and you must replace it with a larger USB flash drive. Click **Next**.



NOTE: Recovery Media Creation formats the USB flash drive, deleting any files on it.

6. Follow the on-screen instructions. When the process is complete, label the USB flash drive and store it in a secure place.

Creating recovery discs with HP Recovery Disc Creator (select models only)

HP Recovery Disc Creator is a software program that offers an alternative way to create recovery discs on select models. After you successfully set up the computer, you can create recovery discs using HP Recovery Disc Creator. The recovery discs allows you to reinstall your original operating system as well as select drivers and applications if the hard drive becomes corrupted. HP Recovery Disc Creator creates two kinds of recovery discs:

- Windows 7 operating system DVD—Installs the operating system without additional drivers or applications.
- *Driver Recovery* DVD—Installs specific drivers and applications only, in the same way that the HP Software Setup utility installs drivers and applications.

To create recovery discs, your computer must have a DVD writer. Use any of the following types of discs (purchased separately): DVD+R, DVD+R DL, DVD-R, DVD-R DL, or DVD±RW. The discs you use will depend on the type of optical drive you are using.

Creating recovery discs



NOTE: The Windows 7 operating system DVD can be created only once. Thereafter, the option to create that media will not be available after you create a Windows DVD.

To create the Windows DVD:

1. Select **Start > All Programs > Productivity and Tools > HP Recovery Disc Creator**.
2. Select **Windows disk**.
3. From the drop-down menu, select the drive for burning the recovery media.
4. Click the **Create** button to start the burning process. Label the disc after you create it, and store it in a secure place.

After the Windows 7 operating system DVD has been created, create the *Driver Recovery* DVD:

1. Select **Start > All Programs > Productivity and Tools > HP Recovery Disc Creator**.
2. Select **Driver disk**.
3. From the drop-down menu, select the drive for burning the recovery media.
4. Click the **Create** button to start the burning process. Label the disc after you create it, and store it in a secure place.

Backing up your information

You should create your initial backup immediately after initial system setup. As you add new software and data files, you should continue to back up your system on a regular basis to maintain a reasonably current backup. Your initial and subsequent backups allow you to restore your data and settings if a failure occurs.

You can back up your information to an optional external hard drive, a network drive, or discs.

Note the following when backing up:

- Store personal files in the Documents library, and back it up regularly.
- Back up templates that are stored in their associated directories.
- Save customized settings that appear in a window, toolbar, or menu bar by taking a screen shot of your settings. The screen shot can be a time-saver if you have to reset your preferences.
- When backing up to discs, number each disc after removing it from the drive.

 **NOTE:** For detailed instructions on various backup and restore options, perform a search for these topics in Help and Support. To access Help and Support, select **Start > Help and Support**.

 **NOTE:** Windows includes the User Account Control feature to improve the security of your computer. You may be prompted for your permission or password. Refer to Help and Support. To access Help and Support, select **Start > Help and Support**.

To create a backup using Windows Backup and Restore:

 **NOTE:** The backup process may take over an hour, depending on file size and the speed of the computer.

1. Select **Start > All Programs > Maintenance > Backup and Restore**.
2. Follow the on-screen instructions to set up your backup.

System Restore

If you have a problem that might be due to software that you installed on your computer, or if you want to restore the system to a previous state without losing any personal information, use System Restore to return the computer to a previous restore point.

 **NOTE:** Always use this System Restore procedure before you use the System Recovery feature.

To start System Restore:

1. Close all open programs.
2. Click the **Start** button, right-click **Computer**, and then click **Properties**.
3. Click **System protection, System Restore**, click **Next**, and then follow the on-screen instructions.

System Recovery

 **WARNING!** This procedure will delete all user information. To prevent loss of information, be sure to back up all user information so you can restore it after recovery.

System Recovery completely erases and reformats the hard disk drive, deleting all data files that you have created, and then reinstalls the operating system, programs, and drivers. However, you must reinstall any software that was not installed on the computer at the factory. This includes software that came on media included in the computer accessory box, and any software programs you installed after purchase. Any personal files must be restored from backups you made.

If you were not able to create system recovery DVDs or USB flash drive, you can order a recovery disc set from support. For U.S. support, go to <http://www.hp.com/support>. For worldwide support, go to http://welcome.hp.com/country/us/en/wwcontact_us.html. You can also order the recovery disc set by calling support. For contact information, see the *Worldwide Telephone Numbers* booklet included with the computer.

 **NOTE:** Always use the System Restore procedure before you use the System Recovery program. See [System Restore on page 265](#).

You must choose one of the following methods to perform a System Recovery:

- Recovery image — Run System Recovery from a recovery image stored on your hard disk drive. The recovery image is a file that contains a copy of the original factory-shipped software. To perform a System Recovery from a recovery image, see [System Recovery when Windows is responding on page 266](#) or [System Recovery when Windows is not responding on page 267](#).
- Recovery media — Run System Recovery from recovery media that you have created from files stored on your hard disk drive or purchased separately. See [System Recovery using recovery media \(select models only\) on page 267](#).

System Recovery when Windows is responding

 **CAUTION:** System Recovery deletes all data and programs you created or installed. Before you begin, back up any important data to a CD or DVD or to a USB flash drive.

 **NOTE:** In some cases, you must use recovery media for this procedure. If you have not already created this media, follow the instructions in [Creating recovery media on page 262](#).

If the computer is working and Windows 7 is responding, use these steps to perform a System Recovery:

1. Turn off the computer.
2. Disconnect all peripheral devices from the computer except the monitor, keyboard, and mouse.

3. Turn on the computer.
4. When Windows has loaded, click the **Start** button, click **All Programs**.
is listed, follow the steps in [System Recovery when Windows is not responding on page 267](#).
 - If **Security and Protection** is listed, continue with step 5.
 - If **Productivity and Tools** is listed, follow the steps in [System Recovery when Windows is not responding on page 267](#).
5. Click **Security and Protection**, click **Recovery Manager**, and then click **Recovery Manager**. If prompted, click **Yes** to allow the program to continue.
6. Under **I need help immediately**, click **System Recovery**.
7. Select **Yes**, and then click **Next**. Your computer restarts.
8. When the computer restarts, you will see the Recovery Manager welcome screen again. Under **I need help immediately**, click **System Recovery**. If you are prompted to back up your files, and you have not done so, select **Back up your files first (recommended)**, and then click **Next**. Otherwise, select **Recover without backing up your files**, and then click **Next**.
9. System Recovery begins. After System Recovery is complete, click **Finish** to restart the computer.
10. When Windows has loaded, shut down the computer, reconnect all peripheral devices, and then turn the computer back on.

System Recovery when Windows is not responding

 **CAUTION:** System Recovery deletes all data and programs you created or installed.

If Windows is not responding, but the computer is working, follow these steps to perform a System Recovery.

1. Turn off the computer. If necessary, press and hold the power button until the computer turns off.
2. Disconnect all peripheral devices from the computer, except the monitor, keyboard, and mouse.
3. Press the power button to turn on the computer.
4. As soon as you see the HP logo screen, repeatedly press the **F11** key on your keyboard until the *Windows is Loading Files...* message appears on the screen.
5. At the HP Recovery Manager screen, follow the on-screen instructions to continue.
6. When Windows has loaded, shut down the computer, reconnect all peripheral devices, and then turn the computer back on.

System Recovery using recovery media (select models only)

Use the steps provided in this section if you created recovery media using [Creating recovery media using HP Recovery Manager \(select models only\) on page 263](#). If you used HP Recovery Disc Creator to create a Windows 7 operating system DVD and a *Driver Recovery* DVD, use the steps in [Using HP Recovery Disc operating system discs \(select models only\) on page 268](#).

⚠ CAUTION: System Recovery deletes all data and programs you have created or installed. Back up any important data to a CD or DVD or to a USB flash drive.

To perform a System Recovery using recovery media:

1. If using a set of DVDs, insert the first recovery disc into the DVD drive tray, and close the tray. If you are using a recovery USB flash drive, insert it into a USB port.
2. Click the **Start** button, and then click **Shut Down**.

or

If the computer is not responding, press and hold the power button for approximately 5 seconds or until the computer turns off.

3. Disconnect all peripheral devices from the computer except the monitor, keyboard, and mouse.
4. Press the power button to turn on the computer, and press **Esc** as the computer is powering on to display the startup menu.
5. Use the arrow keys to select the boot menu, and press **Enter**. Use the arrow keys to select the location where the recovery media is inserted (USB or DVD). Press **Enter** to boot from that device.
6. If Recovery Manager asks if you want to run System Recovery from Media or Hard Drive, select **Media**. On the Welcome screen, under **I need help immediately**, click **Factory Reset**.
7. If you are prompted to back up your files, and you have not done so, select **Back up your files first (recommended)**, and then click **Next**. Otherwise, select **Recover without backing up your files**, and then click **Next**.
8. If you are prompted to insert the next recovery disc, do so.
9. When Recovery Manager is finished, remove the recovery disc or the recovery USB flash drive from the system.
10. Click **Finish** to restart the computer.

Using HP Recovery Disc operating system discs (select models only)

Use the steps provided in this section if you used HP Recovery Disc Creator to create a Windows 7 operating system DVD and a *Driver Recovery* DVD. If you created recovery media using [Creating recovery media using HP Recovery Manager \(select models only\) on page 263](#), use the steps in [System Recovery using recovery media \(select models only\) on page 267](#).

If you cannot use the recovery discs you previously created using the HP Recovery Disc Creator (select models only), you must purchase a Windows 7 operating system DVD to reboot the computer and repair the operating system.

To order a Windows 7 operating system DVD and *Driver Recovery* DVD, go to the HP website. For U.S. support, go to <http://www.hp.com/support>. For worldwide support, go to http://welcome.hp.com/country/us/en/wwcontact_us.html. You can also order the DVDs by calling support. For contact information, see the *Worldwide Telephone Numbers* booklet included with the computer.

 **CAUTION:** Using a Windows 7 operating system DVD completely erases hard drive contents and reformats the hard drive. All files that you have created and any software that you have installed on the computer are permanently removed. When reformatting is complete, the recovery process helps you restore the operating system, as well as drivers, software, and utilities.

To initiate recovery using a Windows 7 operating system DVD:

 **NOTE:** This process takes several minutes.

1. If possible, back up all personal files.
2. Restart the computer, and then insert the Windows 7 operating system DVD into the optical drive before the Windows operating system loads.

 **NOTE:** If the computer does not boot to the DVD, restart the computer and press **Esc** as the computer is powering on to see the startup menu. Use the arrow keys to select the boot menu and press **Enter**. Use the arrow keys to select the location where the recovery DVD is inserted. Press **Enter** to boot from that device.

3. When prompted, press any keyboard key.
4. Follow the on-screen instructions.
5. Click **Next**.
6. Select **Install now**.
7. Follow the on-screen instructions.

After the repair is completed:

1. Eject the Windows 7 operating system DVD and then insert the *Driver Recovery* DVD.
2. Follow the on-screen instructions to install the Hardware Enabling Drivers first, and then install Recommended Applications.

A Battery replacement

The battery that comes with the computer provides power to the real-time clock. When replacing the battery, use a battery equivalent to the battery originally installed in the computer. The computer comes with a 3-volt lithium coin cell battery.

 **WARNING!** The computer contains an internal lithium manganese dioxide battery. There is a risk of fire and burns if the battery is not handled properly. To reduce the risk of personal injury:

Do not attempt to recharge the battery.

Do not expose to temperatures higher than 60°C (140°F).

Do not disassemble, crush, puncture, short external contacts, or dispose of in fire or water.

Replace the battery only with the HP spare designated for this product.

 **CAUTION:** Before replacing the battery, it is important to back up the computer CMOS settings. When the battery is removed or replaced, the CMOS settings will be cleared.

Static electricity can damage the electronic components of the computer or optional equipment. Before beginning these procedures, ensure that you are discharged of static electricity by briefly touching a grounded metal object.

 **NOTE:** The lifetime of the lithium battery can be extended by plugging the computer into a live AC wall socket. The lithium battery is only used when the computer is NOT connected to AC power.

HP encourages customers to recycle used electronic hardware, HP original print cartridges, and rechargeable batteries. For more information about recycling programs, go to <http://www.hp.com/recycle>.

-
1. Remove/disengage any security devices that prohibit opening the computer.
 2. Remove all removable media, such as compact discs or USB flash drives, from the computer.
 3. Turn off the computer properly through the operating system, then turn off any external devices.
 4. Disconnect the power cord from the power outlet and disconnect any external devices.

 **CAUTION:** Regardless of the power-on state, voltage is always present on the system board as long as the system is plugged into an active AC outlet. You must disconnect the power cord to avoid damage to the internal components of the computer.

-
5. Remove the access panel.

6. Locate the battery and battery holder on the system board.

 **NOTE:** On some computer models, it may be necessary to remove an internal component to gain access to the battery.

7. Depending on the type of battery holder on the system board, complete the following instructions to replace the battery.

Type 1

- a. Lift the battery out of its holder.

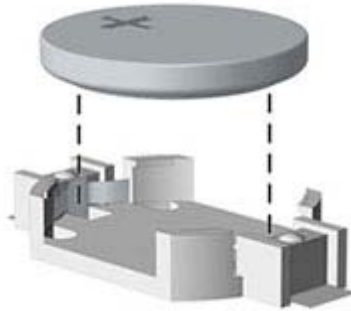

- b. Slide the replacement battery into position, positive side up. The battery holder automatically secures the battery in the proper position.

Type 2

- a. To release the battery from its holder, squeeze the metal clamp that extends above one edge of the battery. When the battery pops up, lift it out (1).
- b. To insert the new battery, slide one edge of the replacement battery under the holder's lip with the positive side up. Push the other edge down until the clamp snaps over the other edge of the battery (2).

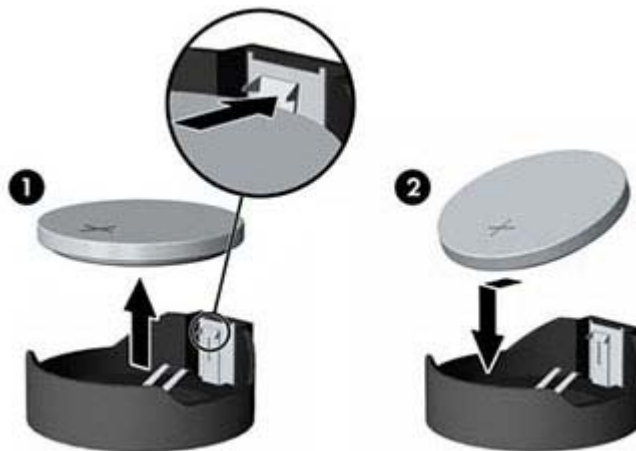

Type 3

- a. Pull back on the clip (1) that is holding the battery in place, and remove the battery (2).

- b.** Insert the new battery and position the clip back into place.

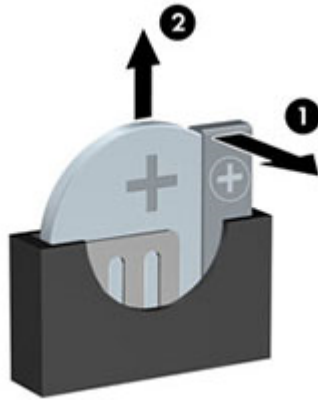

 **NOTE:** After the battery has been replaced, use the following steps to complete this procedure.

- 8.** Replace the access panel.
- 9.** Plug in the computer and turn on power to the computer.
- 10.** Reset the date and time, your passwords, and any special system setups using Computer Setup.
- 11.** Lock any security devices that were disengaged when the access panel was removed.

B Power cord set requirements

The power supplies on some computers have external power switches. The voltage select switch feature on the computer permits it to operate from any line voltage between 100-120 or 220-240 volts AC. Power supplies on those computers that do not have external power switches are equipped with internal switches that sense the incoming voltage and automatically switch to the proper voltage.

The power cord set received with the computer meets the requirements for use in the country where you purchased the equipment.

Power cord sets for use in other countries must meet the requirements of the country where you use the computer.

General requirements

The requirements listed below are applicable to all countries:

1. The power cord must be approved by an acceptable accredited agency responsible for evaluation in the country where the power cord set will be installed.
2. The power cord set must have a minimum current capacity of 10A (7A Japan only) and a nominal voltage rating of 125 or 250 volts AC, as required by each country's power system.
3. The diameter of the wire must be a minimum of 0.75 mm² or 18AWG, and the length of the cord must be between 1.8 m (6 feet) and 3.6 m (12 feet).

The power cord should be routed so that it is not likely to be walked on or pinched by items placed upon it or against it. Particular attention should be paid to the plug, electrical outlet, and the point where the cord exits from the product.

 **WARNING!** Do not operate this product with a damaged power cord set. If the power cord set is damaged in any manner, replace it immediately.

Japanese power cord requirements

For use in Japan, use only the power cord received with this product.

 **CAUTION:** Do not use the power cord received with this product on any other products.

Country-specific requirements

Additional requirements specific to a country are shown in parentheses and explained below.

Country	Accrediting Agency	Country	Accrediting Agency
Australia (1)	EANSW	Italy (1)	IMQ
Austria (1)	OVE	Japan (3)	METI
Belgium (1)	CEBC	Norway (1)	NEMKO
Canada (2)	CSA	Sweden (1)	SEMKO
Denmark (1)	DEMKO	Switzerland (1)	SEV
Finland (1)	SETI	United Kingdom (1)	BSI
France (1)	UTE	United States (2)	UL
Germany (1)	VDE		

1. The flexible cord must be Type HO5VV-F, 3-conductor, 0.75mm² conductor size. Power cord set fittings (appliance coupler and wall plug) must bear the certification mark of the agency responsible for evaluation in the country where it will be used.
2. The flexible cord must be Type SVT or equivalent, No. 18 AWG, 3-conductor. The wall plug must be a two-pole grounding type with a NEMA 5-15P (15A, 125V) or NEMA 6-15P (15A, 250V) configuration.
3. Appliance coupler, flexible cord, and wall plug must bear a "T" mark and registration number in accordance with the Japanese Dentori Law. Flexible cord must be Type VCT or VCTF, 3-conductor, 0.75 mm² conductor size. Wall plug must be a two-pole grounding type with a Japanese Industrial Standard C8303 (7A, 125V) configuration.

C Specifications

TWR specifications

Chassis		
Height	15.7 in	39.9 cm
Width	6.7 in	17.0 cm
Depth	17.4 in	44.2 cm
Approximate Weight	20.5 lb	9.3 kg
Temperature Range		
Operating	50° to 95°F	10° to 35°C
Nonoperating	-22° to 140°F	-30° to 60°C
NOTE: Operating temperature is derated 1.0° C per 300 m (1000 ft) to 3000 m (10,000 ft) above sea level; no direct sustained sunlight. Maximum rate of change is 10° C/Hr. The upper limit may be limited by the type and number of options installed.		
Relative Humidity (noncondensing)		
Operating	10-90%	10-90%
Nonoperating (38.7°C max wet bulb)	5-95%	5-95%
Maximum Altitude (unpressurized)		
Operating	10,000 ft	3048 m
Nonoperating	30,000 ft	9144 m
Power Supply		
Operating Voltage Range	90-264 VAC	
Rated Voltage Range ¹	100-240 VAC	
Rated Line Frequency	50-60 Hz	
Operating Line Frequency	47-63 Hz	
Standard Efficiency	320W	

Rated Input Current	5.5A
---------------------	------

¹ This system utilizes an active power factor corrected power supply. This allows the system to pass the CE mark requirements for use in the countries of the European Union. The active power factor corrected power supply also has the added benefit of not requiring an input voltage range select switch.

SFF specifications

Chassis (in the desktop position)		
Height	3.95 in	10.0 cm
Width	13.3 in	33.8 cm
Depth	14.9 in	37.9 cm
Approximate Weight	16.7 lb	7.6 kg
Weight Supported (maximum distributed load in desktop position)	77 lb	35 kg
Temperature Range		
Operating	50° to 95°F	10° to 35°C
Nonoperating	-22° to 140°F	-30° to 60°C
NOTE: Operating temperature is derated 1.0° C per 300 m (1000 ft) to 3000 m (10,000 ft) above sea level; no direct sustained sunlight. Maximum rate of change is 10° C/Hr. The upper limit may be limited by the type and number of options installed.		
Relative Humidity (noncondensing)		
Operating	10-90%	10-90%
Nonoperating (38.7°C max wet bulb)	5-95%	5-95%
Maximum Altitude (unpressurized)		
Operating	10,000 ft	3048 m
Nonoperating	30,000 ft	9144 m
Power Supply		
Operating Voltage Range	90-264 VAC	
Rated Voltage Range ¹	100-240 VAC	
Rated Line Frequency	50-60 Hz	
Operating Line Frequency	47-63 Hz	
Standard Efficiency	240W active PFC	
Rated Input Current	4A	

¹ This system utilizes an active power factor corrected power supply. This allows the system to pass the CE mark requirements for use in the countries of the European Union. The active power factor corrected power supply also has the added benefit of not requiring an input voltage range select switch.

USDT specifications

Chassis		
Height	2.60 in	6.6 cm
Width	9.90 in	25.1 cm
Depth	10.00 in	25.4 cm
(depth will increase if the computer is equipped with a port security bracket)		
Approximate Weight		
	6.8 lb	3.1 kg
Weight Supported (maximum distributed load in desktop position)		
	77 lb	35 kg
Temperature Range (values subject to change with increasing altitude above sea level)		
Operating	50° to 95° F	10° to 35° C
Nonoperating	-22° to 140° F	-30° to 60° C
NOTE: Operating temperature is derated 1.0° C per 300 m (1,000 ft) to 3,000 m (10,000 ft) above sea level, no direct sustained sunlight. Maximum rate of change is 10° C (50° F)/Hr. The upper limit may be limited by the type and number of options installed.		
Relative Humidity (noncondensing)		
Operating (28° C (82.4° F) max wet bulb)	10-90%	10-90%
Nonoperating (38.7° C (101.66° F) max wet bulb)	5-95%	5-95%
Maximum Altitude (unpressurized)		
Operating	10,000 ft	3,048 m
Nonoperating	30,000 ft	9,144 m
Power Supply		
Operating Voltage Range	90-264 VAC	
Rated Voltage Range ¹	100-240 VAC	
Rated Line Frequency	50-60 Hz	
Operating Line Frequency	47-63 Hz	
Rated Input Current	N/A	

¹ This system utilizes an active power factor corrected external power supply. This allows the system to pass the CE mark requirements for use in the countries of the European Union. The active power factor corrected power supply also has the added benefit of not requiring an input voltage range select switch.

Index

- A**
- AC adapter, USDT
 - spare part number 29, 33
 - access panel
 - locked 200
 - SFF removal and replacement 95
 - SFF spare part number 95
 - SFF, spare part number 22, 28
 - TWR removal 45
 - TWR spare part number 45
 - TWR, spare part number 15, 21
 - USDT removal and replacement 142
 - USDT spare part number 142
 - USDT, spare part number 29, 34
 - adapter, DisplayPort to DVI, spare part number 16, 19, 23, 26, 30
 - adapter, DisplayPort to HDMI, spare part number 16, 19, 23, 26, 30
 - adapter, DisplayPort to VGA, spare part number 16, 19, 23, 26, 30
 - audible codes 246
 - audio problems 215
- B**
- backup and recovery, Windows 7 262
 - Backup and Restore, Windows 7 265
- C**
- backups
 - creating Windows 7 262, 265
 - personal files for Windows 8 computer models 257
 - battery
 - disposal 42
 - battery replacement 270
 - beep codes 246
 - bezel blank
 - spare part number 48
 - USDT, spare part number 34
 - bezel blank (USDT), spare part number 31
 - booting options
 - Full Boot 237
 - Quick Boot 237
- C**
- cable lock, spare part number 17, 20, 24, 27, 31, 34
 - cable management 43
 - cable pinouts, SATA data 43
 - card reader
 - USDT removal and replacement 166
 - USDT spare part number 166
 - cautions
 - AC power 35
 - cables 41
 - cooling fan 40
 - electrostatic discharge 35
 - keyboard cleaning 40
 - keyboard keys 40
 - CD-ROM or DVD problems 230
 - chasis types, illustrated 35
 - chassis fan
 - TWR, spare part number 20
 - USDT, spare part number 34
 - chassis stand
 - spare part number 24
 - cleaning
 - computer 39
 - mouse 40
 - safety precautions 39
 - CMOS
 - backing up 250
 - clearing and resetting 252
 - computer
 - specifications 276, 277
 - computer cleaning 39
 - country power cord set requirements 274
 - Customer Support 196
- D**
- deleted files
 - restoring for Windows 8 computer models 258
 - DIMMs. See memory
 - disassembly preparation
 - SFF 94
 - TWR 44
 - USDT 141
 - DisplayPort cable, spare part number 16, 19, 23, 26, 30
 - DMS-59 to dual VGA cable, spare part number 16, 19, 23, 26
 - drive cage kit
 - USDT spare part number 31, 164
 - drive power cable
 - SFF, spare part number 23, 28
 - TWR, spare part number 16, 21

- drive rail
 - USDT removal and replacement 164
- Driver Recovery DVD,
 - creating 264
 - using for restore 268
- Driver Recovery media, Windows 8 261
- drives
 - SFF locations 110
 - TWR cable connections 59
 - TWR installation 59
 - TWR locations 61
- E**
- electrostatic discharge (ESD) 35
 - preventing damage 36
- error
 - codes 237, 246
 - messages 238
- expansion card
 - SFF installation 103
 - SFF removal 103
 - TWR installation 53
 - TWR removal 53
- F**
- f11 recovery, Windows 8 258
- fan
 - TWR spare part number 21, 87
 - TWR, spare part number 17, 20
 - USDT, spare part number 31, 34
- fan duct
 - SFF removal and replacement 124
 - SFF spare part number 124
 - SFF, spare part number 24, 27
- fan sink
 - SFF removal and replacement 135
 - SFF spare part number 135
 - SFF, spare part number 24, 28
 - TWR removal and replacement 79
- TWR spare part number 79
- TWR, spare part number 17, 19
- fan, power supply 40
- flash drive problems 232
- flashing LEDs 246
- front bezel
 - removing blanks 99, 145
 - SFF removal and replacement 96
 - SFF security 97
 - SFF spare part number 96
 - SFF, spare part number 22, 28
 - TWR blank removal 48
 - TWR removal 47
 - TWR security 46
 - TWR spare part number 47
 - TWR, spare part number 15, 21
 - USDT removal and replacement 143
 - USDT security 144
 - USDT spare part number 143
 - USDT, spare part number 29, 34
- front fan
 - USDT removal and replacement 150
 - USDT spare part number 150
- front I/O assembly
 - SFF removal and replacement 130
 - SFF spare part number 130
 - SFF, spare part number 23, 28
 - TWR spare part number 76
 - TWR, spare part number 16, 21
 - USDT, spare part number 31
- front panel components
 - SFF 4
 - TWR 3
 - USDT 5
- front panel problems 233
- front USB panel
 - TWR removal and replacement 76
- G**
- general problems 199
- graphics board
 - USDT removal and replacement 169
- graphics card, spare part number 19, 25
- grounding methods 37
- H**
- hard drive
 - proper handling 41
 - SATA characteristics 42
 - spare part numbers 18, 25, 32
 - USDT installation 154
 - USDT removal 154
- hard drive (2.5-inch)
 - SFF installation 119
 - SFF removal 119
 - TWR installation 71
 - TWR removal 70
- hard drive (3.5-inch)
 - SFF installation 116
 - SFF removal 116
 - TWR installation 71
 - TWR removal 70
- hard drive problems 205
- hard drive recovery
 - Windows 7 266
 - Windows 8 258
- hardware installation problems 221
- heat sink
 - USDT removal and replacement 157
 - USDT spare part number 157
 - USDT, spare part number 31
- Help and Support
 - Windows 7 262
- helpful hints 197
- hood sensor
 - SFF spare part number 128
 - spare part number 17, 19, 24, 26, 33
 - TWR spare part number 86
 - USDT removal and replacement 165
 - USDT spare part number 165

HP Recovery Disc Creator, using
264

I

installing

- battery 270
- SFF 2.5-inch hard drive 119
- SFF 3.5-inch hard drive 116
- SFF expansion card 103
- SFF media card reader 112
- SFF memory 100
- SFF slim optical drive 115
- TWR 2.5-inch hard drive 71
- TWR 3.5-inch hard drive 71
- TWR 5.25-inch optical drive
62
- TWR drive cables 59
- TWR expansion card 53
- TWR media card reader 66
- TWR memory 50
- TWR slim optical drive 68
- USDT hard drive 154
- USDT memory 147
- USDT optical drive 153

Internet access problems 233

K

keyboard

- cleaning 39
- spare part numbers 18, 25,
32

keyboard problems 219

L

LEDs

- blinking PS/2 keyboard 246

locks

- SFF front bezel 97
- TWR front bezel 46
- USDT front bezel 144

M

media card reader

- problems 208
- SFF installation 112
- SFF removal 111
- TWR installation 66
- TWR removal 64

memory

- problems 227
- SFF installation 100

SFF socket population 100

SFF specifications 100

TWR installation 50

TWR socket population 50

TWR specifications 50

USDT installation 147

USDT socket population 148

USDT specifications 147

memory modules

- spare part number 15, 20,
22, 26, 27, 50, 100
- USDT, spare part number 29,
34, 147

monitor problems 210

mouse

- cleaning 40
- problems 219

mouse, spare part number 17,
24, 31, 32

N

network problems 223

NIC, spare part number 21, 28

numeric error codes 238

O

operating guidelines 38

operating system media, Windows
8 261

optical drive

- problems 230
- spare part numbers 18, 20,
25, 26, 27, 32, 33
- USDT installation 153
- USDT release latch attachment
152
- USDT removal 151
- USDT, spare part number 151

optical drive (5.25-inch)

- TWR installation 62
- TWR removal 62

optical drive (slim)

- SFF installation 115
- SFF removal 114
- TWR installation 68
- TWR removal 67

optical drive cable/connector,
USDT

- spare part number 30
- overheating, prevention 38

P

password

- clearing 250
- power-on 250
- setup 250

PCI expansion slot daughter card

- TWR removal and
replacement 92

port cover

- USDT spare part number 179

POST error messages 237

power cord set requirements
country specific 274

power problems 203

power supply

- fan 40
- operating voltage range 275,
276, 277

SFF removal and replacement
121

SFF, spare part number 22,
27

TWR removal and
replacement 89

TWR spare part number 89

TWR, spare part number 15,
20

power switch assembly

SFF removal and replacement
132

SFF spare part number 132

SFF, spare part number 23,
28

TWR removal and
replacement 77

TWR spare part number 77

TWR, spare part number 16,
21

USDT removal and
replacement 170

power-on password 250

printer port (expansion), PCI card
spare part number 24

printer port (expansion), spare part
number 17, 19, 26

printer problems 217

problems

- audio 215
- CD-ROM or DVD 230
- flash drive 232

- front panel 233
 - general 199
 - hard drive 205
 - hardware installation 221
 - Internet access 233
 - keyboard 219
 - Media Card Reader 208
 - memory 227
 - monitor 210
 - mouse 219
 - network 223
 - power 203
 - printer 217
 - processor 229
 - software 235
 - processor
 - SFF removal and replacement 136
 - spare part number 15, 21, 23, 28, 30
 - TWR removal and replacement 81
 - USDT removal and replacement 159
 - processor problems 229
 - product ID locations 8
- R**
- rear fan
 - TWR removal and replacement 87
 - TWR, spare part number 21
 - USDT removal and replacement 173, 174
 - USDT spare part number 173
 - rear panel components
 - SFF 7
 - TWR 6
 - USDT 8
 - rear port cover, USDT
 - spare part number 31
 - recovery discs, steps for creating Windows 7 263
 - recovery discs, using for restore 268
 - recovery media, creating 264
 - recovery media, creating Windows 7 262
 - recovery partition, Windows 8 258
 - recovery USB flash drive, steps for creating Windows 7 263
 - recovery using Windows 8
 - operating system media 261
 - removal and replacement
 - power switch assembly 132
 - SFF fan duct 124
 - SFF fan sink 135
 - SFF front bezel 95, 96
 - SFF front I/O assembly 130
 - SFF hood sensor 128
 - SFF power supply 121
 - SFF processor 136
 - SFF Smart Cover Lock 125
 - SFF solenoid lock 125
 - SFF speaker 134
 - SFF system board 138
 - TWR fan 87
 - TWR fan sink 79
 - TWR front USB panel 76
 - TWR hood sensor 86
 - TWR PCI expansion slot daughter card 92
 - TWR power supply 89
 - TWR power switch assembly 77
 - TWR processor 81
 - TWR solenoid lock 83
 - TWR speaker 82
 - TWR system board 92
 - USDT access panel 142
 - USDT card reader 166
 - USDT front bezel 143
 - USDT front fan 150
 - USDT graphics board 169
 - USDT heat sink 157
 - USDT hood sensor 165
 - USDT optical drive rail 164
 - USDT power switch 170
 - USDT processor 159
 - USDT rear fan 173, 174
 - USDT Smart Cover Lock 160
 - USDT solenoid lock 160
 - USDT speaker 156
 - USDT system board 171
 - USDT WLAN tuner module 168
 - removing
 - battery 270
 - bezel blanks 99, 145
 - SFF 2.5-inch hard drive 119
 - SFF 3.5-inch hard drive 116
 - SFF expansion card 103
 - SFF media card reader 111
 - SFF slim optical drive 114
 - TWR 2.5-inch hard drive 70
 - TWR 3.5-inch hard drive 70
 - TWR 5.25-inch optical drive 62
 - TWR access panel 45
 - TWR bezel blanks 48
 - TWR expansion card 53
 - TWR front bezel 47
 - TWR media card reader 64
 - TWR slim optical drive 67
 - USDT hard drive 154
 - USDT optical drive 151
 - resetting
 - CMOS 250
 - password jumper 250
 - restore
 - Windows File History 258
 - restoring the hard drive, Windows 8 258
 - rubber foot
 - spare part number 24
- S**
- safety and comfort 196
 - safety precautions
 - cleaning 39
 - SATA
 - connectors on system board 42
 - data cable pinouts 43
 - hard drive characteristics 42
 - SATA cable
 - SFF, spare part number 23
 - SATA hard drive cable
 - TWR, spare part number 20
 - SATA optical drive cable
 - TWR, spare part number 20
 - screws, correct size 41
 - security
 - SFF front bezel 97
 - TWR front bezel 46
 - USDT front bezel 144
 - serial number locations 8
 - serial port (expansion), spare part number 19, 26

- serial port, spare part number 17, 24
- service considerations 40
- setup password 250
- SFF
 - access panel, spare part number 22, 28
 - disassembly preparation 94
 - drive power cable, spare part number 23, 28
 - fan duct removal and replacement 124
 - fan duct, spare part number 24, 27
 - fan sink removal and replacement 135
 - fan sink, spare part number 24, 28
 - font I/O assembly, spare part number 28
 - front bezel removal and replacement 95, 96
 - front bezel, spare part number 22, 28
 - front I/O assembly removal and replacement 130
 - front I/O assembly, spare part number 23
 - power supply removal and replacement 121
 - power supply, spare part number 22, 27
 - power switch assembly removal and replacement 132
 - power switch assembly, spare part number 23, 28
 - preparation for disassembly 94
 - processor removal and replacement 136
 - SATA cable, spare part number 23
 - Smart Cover Lock removal and replacement 125
 - solenoid lock removal and replacement 125, 128
 - solenoid lock, spare part number 24
 - speaker removal and replacement 134
 - speaker, spare part number 24, 27
 - system board removal and replacement 138
 - system board, spare part number 22, 27, 28
- Smart Cover Lock
 - SFF removal and replacement 125
 - SFF spare part number 125
 - USD T spare part number 160
- software
 - problems 235
 - servicing computer 41
- solenoid lock
 - SFF removal and replacement 125, 128
 - SFF spare part number 125
 - SFF, spare part number 24
 - spare part number 28
 - TWR removal and replacement 83, 86
 - TWR spare part number 83
 - TWR, spare part number 17, 19
 - USD T removal and replacement 160
 - USD T spare part number 160
- solid-state drive, spare part number 18, 25, 32
- spare part number
 - tamper-resistant wrench 41
 - Torx T-15 screwdriver 41
- speaker
 - SFF removal and replacement 134
 - SFF spare part number 134
 - SFF, spare part number 24, 27
 - TWR removal and replacement 82
 - TWR spare part number 82
 - TWR, spare part number 17, 20
 - USD T removal and replacement 156
 - USD T spare part number 156
 - USD T, spare part number 31, 34
- specifications
 - computer 275, 276, 277
 - SFF memory 100
 - TWR memory 50
 - USD T memory 147
- stand (USD T), spare part number 29, 33
- static electricity 36
- system board
 - SATA connectors 42
 - SFF removal and replacement 138
 - SFF spare part number 138
 - SFF, spare part number 22, 27, 28
 - TWR removal and replacement 92
 - TWR spare part number 92
 - TWR, spare part number 15, 20
 - USD T removal and replacement 171
 - USD T, spare part number 29, 34
- system board connections
 - SFF 107
 - TWR 57
 - USD T 146
- System Recovery using Windows 7 recovery media 267
- System Recovery, Windows 7 266
- system restore point
 - creating for Windows 8 computer models 257
 - restoring for Windows 8 computer models 258
- system restore points, creating Windows 7 262
- System Restore, Windows 7 265

T

- tamper-proof screws
 - tool 41
- temperature control 38
- tools, servicing 41
- Torx T15 screwdriver 41

- tower conversion
 - SFF 140
 - USDT 178
- TWR
 - access panel, spare part number 15, 21
 - disassembly preparation 44
 - drive power cable, spare part number 16, 21
 - fan removal and replacement 87
 - fan sink removal and replacement 79
 - fan sink, spare part number 17, 19
 - fan, spare part number 17, 20
 - front bezel, spare part number 15, 21
 - front I/O assembly, spare part number 16, 21
 - front USB panel removal and replacement 76
 - PCI expansion slot daughter card 92
 - power supply removal and replacement 89
 - power supply, spare part number 15, 20
 - power switch assembly removal and replacement 77
 - power switch assembly, spare part number 16, 21
 - preparation for disassembly 44
 - processor removal and replacement 81
 - SATA hard drive cable, spare part number 20
 - SATA optical drive cable, spare part number 20
 - solenoid lock removal and replacement 83, 86
 - speaker removal and replacement 82
 - speaker, spare part number 17, 20
 - system board removal and replacement 92
 - system board, spare part number 15, 20

U

- USB powered speakers, spare part number 17, 19, 24, 26, 31, 33
- USDT
 - AC adapter, spare part number 29, 33
 - access panel removal and replacement 142
 - access panel, spare part number 29, 34
 - card reader removal and replacement 166
 - chassis fan, spare part number 34
 - disassembly preparation 141
 - drive cage, spare part number 31
 - drive rail removal and replacement 164
 - fan (front), spare part number 31
 - fan (rear), spare part number 31
 - front bezel removal and replacement 143
 - front bezel, spare part number 29, 34
 - front fan removal and replacement 150
 - front I/O panel, spare part number 31
 - graphics board removal and replacement 169
 - heat sink removal and replacement 157
 - heat sink, spare part number 31
 - hood sensor removal and replacement 165
 - optical drive cable/connector, spare part number 30
 - power switch removal and replacement 170
 - preparation for disassembly 141
 - processor removal and replacement 159
 - rear fan removal and replacement 173, 174

- rear port cover, spare part number 31
- Smart Cover Lock removal and replacement 160
- solenoid lock removal and replacement 160
- speaker removal and replacement 156
- speaker, spare part number 31, 34
- system board removal and replacement 171
- system board, spare part number 29, 34
- WLAN module removal and replacement 168

V

- ventilation, proper 38

W

- Wake-on-LAN feature 223
- Windows
 - backup 257
 - File History 257, 258
 - restoring files 258
 - system restore point 257, 258
- Windows 7
 - backing up information 265
 - backup and recovery 262
 - Backup and Restore 265
 - creating backups 262
 - creating recovery media 262
 - creating system restore points 262
 - hard drive recovery 266
 - Help and Support 262
 - steps for creating recovery discs 263
 - steps for creating recovery media 263
 - steps for creating recovery USB flash drive 263
 - System Recovery 266
 - System Recovery using recovery media 267
 - System Restore 265
- Windows 7 operating system discs using for restore 268

- Windows 7 operating system DVD
 - creating 264
 - using for restore 268
- Windows 7 operating system media
 - creating 264
- Windows 8
 - backup and restore 256
 - Driver Recovery media 261
 - f11 recovery 258
 - hard drive recovery 258
 - operating system DVD 261
 - recovery partition 258
 - restoring the hard drive 258
- WLAN module
 - USDT removal and replacement 168
 - USDT spare part number 168