



HP EliteBook 8540p Notebook PC
HP EliteBook 8540w Mobile Workstation

Maintenance and Service Guide

© Copyright 2010 Hewlett-Packard
Development Company, L.P.

Bluetooth is a trademark owned by its proprietor and used by Hewlett-Packard Company under license. Intel and Core are trademarks or registered trademarks of Intel Corporation in the United States and other countries. Microsoft, Windows, and Windows Vista are either trademarks or registered trademarks of Microsoft Corporation in the United States and/or other countries. SD Logo is a trademark of its proprietor.

The information contained herein is subject to change without notice. The only warranties for HP products and services are set forth in the express warranty statements accompanying such products and services. Nothing herein should be construed as constituting an additional warranty. HP shall not be liable for technical or editorial errors or omissions contained herein.

Second Edition: April 2010

First Edition: January 2010

Document Part Number: 590180-002

Safety warning notice

⚠ **WARNING!** To reduce the possibility of heat-related injuries or of overheating the computer, do not place the computer directly on your lap or obstruct the computer air vents. Use the computer only on a hard, flat surface. Do not allow another hard surface, such as an adjoining optional printer, or a soft surface, such as pillows or rugs or clothing, to block airflow. Also, do not allow the AC adapter to contact the skin or a soft surface, such as pillows or rugs or clothing, during operation. The computer and the AC adapter comply with the user-accessible surface temperature limits defined by the International Standard for Safety of Information Technology Equipment (IEC 60950).

Table of contents

1 Product description	1
2 External component identification	9
Display	9
Top components	10
Pointing devices	10
Lights	11
Buttons, switches, and fingerprint reader	13
Keys	15
Front components	16
Left-side components	17
Rear components	18
Right-side components	18
Bottom components	19
Wireless antennas (select models only)	20
3 Illustrated parts catalog	21
Service tag	21
Computer major components	22
Display components	28
Plastics Kit	29
Cable Kit	30
Mass storage devices	31
Miscellaneous parts	32
Sequential part number listing	33
4 Removal and replacement procedures	40
Preliminary replacement requirements	40
Tools required	40
Service considerations	40
Plastic parts	40
Cables and connectors	41
Drive handling	41

Grounding guidelines	42
Electrostatic discharge damage	42
Packaging and transporting guidelines	43
Workstation guidelines	43
Equipment guidelines	44
Component replacement procedures	45
Service tag	45
Computer feet	46
Battery	47
SIM	48
Optical drive	49
Upgrade bay	50
Ambient light sensor	52
Hard drive	54
Bluetooth module	57
RTC battery	58
Expansion memory modules	60
WWAN module	62
Keyboard	65
Primary memory module	68
WLAN module	69
Switch cover	71
Fan	73
Heat sink	75
Processor	77
Graphics card	79
Display assembly	81
Top cover	87
Modem module	91
ExpressCard/audio assembly	92
Speaker assembly	94
System board	96
RJ-11 connector cable	98
USB/VGA board	100
Power connector cable	102
5 Computer Setup	104
Starting Computer Setup	104
Using Computer Setup	104
Navigating and selecting in Computer Setup	104
Restoring factory settings in Computer Setup	105
Computer Setup menus	106
File menu	106

Security menu	107
System Configuration menu	108
6 Specifications	112
Computer specifications	112
39.6-cm (15.6-in) HD display specifications	113
39.6-cm (15.6-in) HD+ display specifications	114
39.6-cm (15.6-in) FHD display specifications	115
Hard drive specifications	116
DVD±RW and CD-RW SuperMulti DL Combo Drive specifications	117
Blu-ray Disc ROM with SuperMulti DVD±R/RW DL Drive	118
Blu-ray Disc ROM Combo Drive	119
DVD-ROM Drive specifications	120
Specification information in Device Manager	121
7 Backup and recovery	122
Windows 7	122
Backing up your information	122
Performing a recovery	123
Using the Windows recovery tools	124
Using f11	124
Using a Windows 7 operating system DVD (purchased separately)	125
Windows Vista	126
Backing up your information	126
Performing a recovery	127
Using the Windows recovery tools	127
Using f11	128
Using a Windows Vista operating system DVD (purchased separately)	128
Windows XP	130
Backing up your information	130
Performing a recovery	131
Recovering your information	131
Recovering the operating system and programs	131
8 Connector pin assignments	132
Audio-out (headphone)	132
Audio-in (microphone)	132
External monitor	133
RJ-11 (modem)	134
RJ-45 (network)	134
Universal Serial Bus	135

9 Power cord set requirements	136
Requirements for all countries and regions	136
Requirements for specific countries and regions	137
10 Recycling	138
Battery	138
Display	138
Index	144

1 Product description

Category	Description	HP EliteBook 8540p Notebook PC	HP EliteBook 8540w Mobile Workstation
Product Name	HP EliteBook 8540p Notebook PC	√	
	HP EliteBook 8540w Mobile Workstation		√
Processors	Intel® Core™i7 processors, Quad Core		
	820QM, 1.73-GHz (Turbo up to 3.06) processor 8-MB L3 cache, 8 threads	√	√
	720QM, 1.66-GHz (Turbo up to 2.80) processor 6-MB L3 cache, 8 threads	√	√
	Intel Core i7 processor, Dual Core		
	620M, 2.66-GHz (Turbo up to 3.33) processor 4-MB L3 cache, 4 threads	√	√
	Intel Core i5 processors, Dual Core		
	540M, 2.53-GHz (Turbo up to 3.06) processor 3-MB L3 cache, 4 threads	√	√
	520M, 2.40-GHz (Turbo up to 2.93) processor 3-MB L3 cache, 4 threads	√	√
Chipset	Intel P55 Mobile Express	√	√
Graphics	NVIDIA N10P-NS 1GB DDR3 - NVIDIA NVS 5100	√	
	NVIDIA N10P-GLM 1GB DDR3 - NVIDIA Quadro FX 880M		√
	NVIDIA N10P-GLM4 1GB GDDR5 - NVIDIA Quadro FX 1800M		√
	ATI FirePro M5800		√
Panel	All display assemblies include 3 wireless local area network (WLAN) antennas and 2 wireless wide area network (WWAN) antennas	√	√
	39.6-cm (15.6-in) HD	√	√
	39.6-cm (15.6-in) HD with webcam	√	√
	39.6-cm (15.6-in) HD+	√	√
	39.6-cm (15.6-in) HD+ with webcam	√	√

Category	Description	HP EliteBook 8540p Notebook PC	HP EliteBook 8540w Mobile Workstation
	39.6-cm (15.6-in) FHD	√	√
	39.6-cm (15.6-in) FHD with webcam	√	√
	39.6-cm (15.6-in) FHD DreamColor		√
	39.6-cm (15.6-in) FHD DreamColor with webcam		√
	Support privacy filter	√	√
Memory	Four customer-accessible/upgradeable memory module slots supporting up to 16 GB of RAM in models that use quad-core processors	√	√
	Two customer-accessible/upgradeable memory module slots supporting up to 8 GB of RAM in models that use dual-core processors	√	√
	Supports dual-channel memory	√	√
	PC3-10600, 1333-MHz, DDR3	√	√
	Supports the following configurations:	√	√
	<ul style="list-style-type: none"> • 16684 (4096 × 4) • 12288 (4096 × 2) + (2048 × 2) • 8192 (2048 × 4) • 8192 (4096 × 2) • 4096 (2048 × 2) • 4096 (4096 × 1) • 2048 (2048 × 1) 		
Hard drives	Supports 9.5-mm, 6.35-cm (2.50-in) SATA hard drives	√	√
	Customer-accessible	√	√
	Supports the following drives:	√	√
	<ul style="list-style-type: none"> • 500-GB, 7200 • 320-GB, 7200-rpm • 250-GB, 7200 		
	Supports the following solid-state drives:	√	√
	<ul style="list-style-type: none"> • 256-GB • 160-GB 		
	HP Mobile Data Protection System 3D	√	√
	RAID 0/1 Support	√	√
Upgrade bay	Fixed (removal of 1 screw required)	√	√

Category	Description	HP EliteBook 8540p Notebook PC	HP EliteBook 8540w Mobile Workstation
	Customer-accessible	√	√
	Serial ATA	√	√
	12.7-mm tray load	√	√
	Supports "No Drive" option		
	Supports the following 12.7-mm SATA optical drives:	√	√
	<ul style="list-style-type: none"> • DVD±RW and CD-RW Super Multi DL Combo Drive with LightScribe • Blu-ray Disc ROM with SuperMulti DVD+/-R/RW DL Drive • Blu-ray R/RE DVD+/-RW SuperMulti DL Drive • DVD-ROM Drive 		
	Supports the following 9.5-mm SATA hard drive:		
	<ul style="list-style-type: none"> • 500-GB, 7200-rpm 		
Diskette drive	Supports external USB diskette drive only	√	√
Microphone	Integrated dual-array microphone	√	√
Audio	HD audio	√	√
	Stereo speakers	√	√
Webcam	Integrated 2-megapixel webcam with macro lens	√	√
Modem	56K V.92 MDC data/fax modem	√	√
	Modem cable not included	√	√
	Supports "No Modem" option	√	√
Ethernet	Intel 82577LM GbE LAN 10/100/1000 network interface card (NIC) with iAMT	√	√
	S3/S4/S5 wake on LAN	√	√
	NIC power down technology	√	√
	Ethernet cable not included	√	√
Wireless	Integrated WLAN options by way of wireless module:		
	Three WLAN antennas built into display assembly	√	√
	Supports "no WLAN" option	√	√

Category	Description	HP EliteBook 8540p Notebook PC	HP EliteBook 8540w Mobile Workstation
	Supports the following WLAN formats:	√	√
	<ul style="list-style-type: none"> Intel Wi-Fi Link 6300, 802.11a/g/n, 3 × 3 Intel Wi-Fi Link 6200, 802.11a/b/g/n, 2 × 2 Intel Wi-Fi Link 6100, 802.11a/b/g (Ukraine and Russia only) Broadcom 4322, 802.11a/b/g/n, 2 × 2 		
	Integrated WWAN options by way of wireless module:		
	Two WWAN antennas built into display assembly	√	√
	GPS support	√	√
	Subscriber identity module (SIM) security (customer-accessible in battery bay)	√	√
	Supports "no WWAN" option	√	√
	Supports the following WWAN modules:	√	√
	<ul style="list-style-type: none"> Qualcomm Ericsson 		
	Integrated personal area network (PAN) options by way of Bluetooth® module:		
	Supports "no PAN" option	√	√
	Broadcom Bluetooth	√	√
External media card	One ExpressCard/54 slot	√	√
	Integrated Media Card Reader with SD, MMC, MS, MSpro, xD, Memory Stick Duo support	√	√
Ports	Audio-in (stereo microphone)	√	√
	Audio-out (stereo headphone)	√	√
	DisplayPort	√	√
	RJ-11 (modem)	√	√
	RJ-45 (Ethernet, includes link and activity lights)	√	√
	USB 3.0 (2)	√	√
	USB 2.0 (3)	√	√
	eSATA	√	√
	VGA (Dsub 15-pin) supporting 1600 × 1200 external resolution at 75-GHz (hot plug with auto-detect)	√	√
	1394a	√	√
	3-pin AC power	√	√

Category	Description	HP EliteBook 8540p Notebook PC	HP EliteBook 8540w Mobile Workstation
	Docking connector	√	√
Docking	HP Docking Station	√	√
	HP Advanced Docking Station	√	√
Keyboard/pointing devices	Full-size keyboard with durable key cap coating	√	√
	Dual point (pointing stick and TouchPad) with 3 pointing stick buttons and 3 TouchPad buttons and scroll zone	√	√
	Spill-resistant design, DuraKey coating	√	√
	Touch-sensitive volume up/down and mute buttons	√	√
	Five touch-sensitive launch buttons (QuickLook/Software Setup, QuickWeb/Browser Launch, WLAN on/off, Touchpad on/off, Calculator launch)	√	√
Power requirements	AC adapter with localized cable plug support (3-wire plug with ground pin, supports 3-pin DC connector):	√	√
	<ul style="list-style-type: none"> • 150-W • 120-W • 90-W 		
	8-cell, 2.55-Ah (73-Wh) Li-ion battery	√	√
	Supports 8-cell Extended Life Battery	√	√
	Supports 12-cell Ultra Capacity Battery	√	√
	HP Fast Charge Technology	√	√
Security	Integrated fingerprint reader	√	√
	Integrated smart card reader	√	√
	Security cable slot	√	√
	Trusted platform module (TPM) V.1.2	√	√
	Preboot authentication (password, smart card)	√	√
Operating system	Preinstalled:		
	Windows 7 Professional 64	√	√
	Windows 7 Professional 32	√	√
	Windows 7 Professional with XPP images	√	√
	Windows 7 Home Premium 64	√	√
	Windows 7 Home Premium 32	√	√
	Windows Vista Business 32	√	√

Category	Description	HP EliteBook 8540p Notebook PC	HP EliteBook 8540w Mobile Workstation
	Windows Vista Home Basic	√	√
	FreeDOS	√	√
	Preinstalled with Microsoft® Office:		
	Windows 7 Professional 32 with Microsoft® Office 2007 Personal with Powerpoint	√	√
	Windows 7 Professional 32 with Microsoft Office 2007 Personal	√	√
	Windows 7 Professional 32 with Microsoft Office 2007 Professional	√	√
	Windows 7 Professional 32 with Microsoft Office 2007 Ready	√	√
	Windows 7 Home Basic with Microsoft Office Ready	√	√
	Windows 7 Home Premium 32 with Microsoft Office Ready	√	√
	Windows 7 Home Premium 32 with Microsoft Office Personal with Powerpoint	√	√
	Windows 7 Home Premium 32 with Microsoft Office Personal	√	√
	Windows 7 Home Premium 32 with Microsoft Office Professional	√	√
	Windows 7 Home Premium 64 with Microsoft Office Ready	√	√
	Windows 7 Home Premium 64 with Microsoft Office Personal with Powerpoint	√	√
	Windows 7 Home Premium 64 with Microsoft Office Personal	√	√
	Windows 7 Home Premium 64 with Microsoft Office Professional	√	√
	Windows 7 Professional 64 with Microsoft Office Ready	√	√
	Windows 7 Professional 64 with Microsoft Office Personal with Powerpoint	√	√
	Windows 7 Professional 64 with Microsoft Office Personal	√	√
	Windows 7 Professional with XPP images with Microsoft Office Ready	√	√
	Windows 7 Professional with XPP images with Microsoft Office Personal with Powerpoint	√	√
	Windows 7 Professional with XPP images with Microsoft Office Personal	√	√

Category	Description	HP EliteBook 8540p Notebook PC	HP EliteBook 8540w Mobile Workstation
	Windows 7 Professional with XPP images with Microsoft Office Professional	√	√
	Windows Vista Business 32 with Microsoft Office 2007 Ready	√	
	Windows Vista Business 32 with Microsoft Office 2007 Personal with Powerpoint	√	
	Windows Vista Business 32 with Microsoft Office 2007 Personal	√	√
	Windows Vista Business 32 with Microsoft 2007 Professional	√	√
	Windows Vista Home Basic with Microsoft Office 2007 Ready	√	√
	Windows Vista Home Basic with Microsoft Office 2007 Personal with Powerpoint	√	√
	Windows Vista Home Basic with Microsoft Office 2007 Personal	√	√
	Windows Vista Home Basic with Microsoft Office 2007 Professional	√	√
	Restore Media:		
	Windows 7 Professional 64	√	√
	Windows 7 Professional 32	√	√
	Windows 7 Home Basic 32	√	√
	Windows 7 Home Premium 64	√	√
	Windows 7 Home Premium 32	√	√
	Windows Vista Business 32	√	√
	Windows Vista Home Basic	√	√
	Windows XP Professional	√	√
	DRDVD XP Pro	√	√
	DRDVD Windows 7	√	√
	DRDVD Windows 7 with WinDVD	√	√
	DRDVD Windows Vista	√	√
	Office Ready restore DVD	√	√
	Web-only support:		
	Windows XP Professional 64		√
	Windows Vista 32/64 Enterprise	√	√
	Certified:		
	Novell™: SuSE Linux™ Enterprise Desktop	√	√

Category	Description	HP EliteBook 8540p Notebook PC	HP EliteBook 8540w Mobile Workstation
Serviceability	End-user replaceable parts:		
	AC adapter	√	√
	Battery (system)	√	√
	Hard drive	√	√
	Keyboard	√	√
	Memory module	√	√
	Optical drive	√	√
	Mini-PCI components (WLAN, WWAN, SIM)	√	√

2 External component identification

Display



Component	Description
(1) Internal display switch	Turns off the display if the display is closed while the power is on.
(2) Internal microphones (2)	Record sound.
(3) Webcam light	On: The webcam is in use.
(4) Webcam	Records audio and video and captures still photographs.
(5) Keyboard light	Illuminates the keyboard in low-light conditions when pressed.
(6) Ambient light sensor	Automatically adjusts the display brightness based on the lighting conditions in your environment.

Top components

Pointing devices

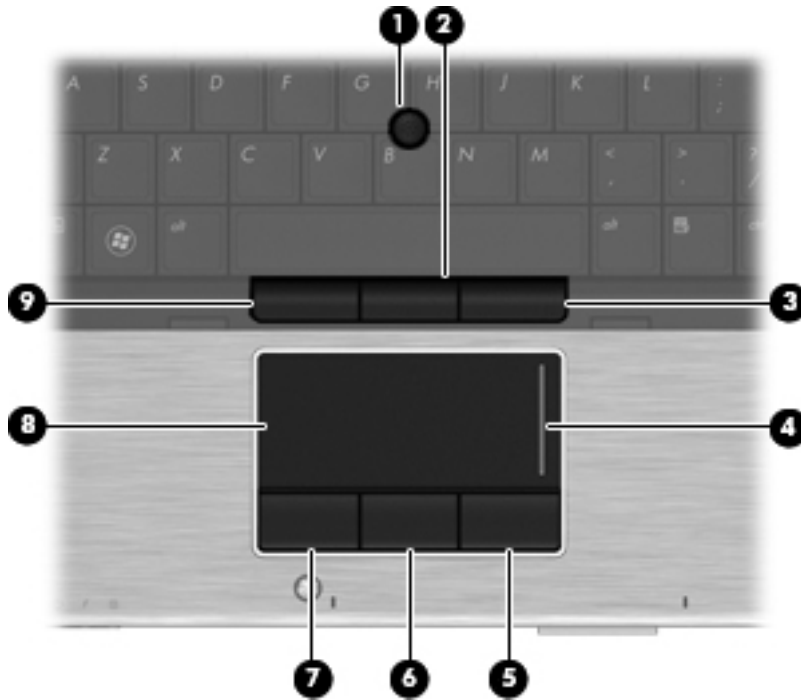

Component	Description
(1) Pointing stick*	Moves the pointer and selects or activates items on the screen.
(2) Center pointing stick button*	Functions like the center button on an external mouse.
(3) Right pointing stick button*	Functions like the right button on an external mouse.
(4) TouchPad scroll zone	Scrolls up or down.
(5) Right TouchPad button*	Functions like the right button on an external mouse.
(6) Center TouchPad button*	Functions like the center button on an external mouse.
(7) Left TouchPad button*	Functions like the left button on an external mouse.
(8) TouchPad*	Moves the pointer and selects or activates items on the screen.
(9) Left pointing stick button*	Functions like the left button on an external mouse.

*This table describes factory settings. To view or change pointing device preferences, select **Start > Control Panel > Hardware and Sound > Mouse**.

Lights

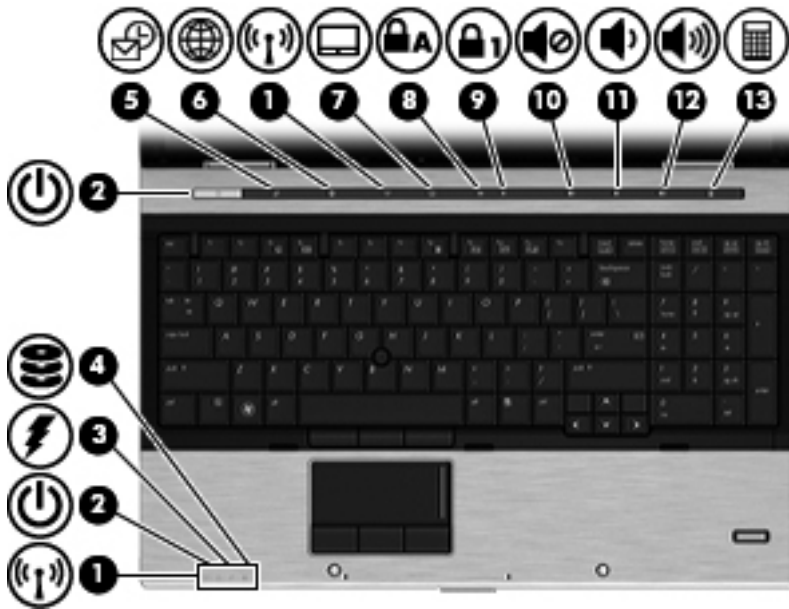

NOTE: Lights indicated by callouts 5 – 7 and 10 – 13 are always lit when the computer is powered on. The light does not imply the function is active.

NOTE: If you press the lights indicated by callouts 5, 6, 11, 12, and 13, the light blinks for a few seconds and turns back on.

Component	Description
(1) Wireless lights (2) [†]	<ul style="list-style-type: none"> Blue: An integrated wireless device, such as a wireless local area network (WLAN) device and/or a Bluetooth® device, is on. Amber: All wireless devices are off.
(2) Power lights (2) [*]	Wireless lights (2) [†] <ul style="list-style-type: none"> On: The computer is on. Blinking: The computer is in the Sleep state. Off: The computer is off or in Hibernation.
(3) Battery light	<ul style="list-style-type: none"> Amber: A battery is charging. Turquoise: A battery is close to full charge capacity. Blinking amber: A battery that is the only available power source has reached a low battery level. When the battery reaches a critical battery level, the battery light begins blinking rapidly. Off: If the computer is plugged into an external power source, the light turns off when all batteries in the computer are fully charged. If the computer is not plugged into an external power source, the light stays off until the battery reaches a low battery level.

Component	Description
(4) Drive light	<ul style="list-style-type: none"> Blinking turquoise: The hard drive or optical drive is being accessed. Amber: HP 3D DriveGuard has temporarily parked the hard drive.
(5) QuickLook light	<ul style="list-style-type: none"> On: The computer is on. Off: The computer is off or in the Sleep or Hibernation state.
(6) HP QuickWeb light	<ul style="list-style-type: none"> On: The computer is on.
(7) TouchPad light	<ul style="list-style-type: none"> Blue: TouchPad is on. Amber: TouchPad is off.
(8) Caps lock light	On: Caps lock is on.
(9) Num lock light	On: Num lock is on.
(10) Volume mute light	<ul style="list-style-type: none"> Blue: Computer sound is on. Amber: Computer sound is off.
(11) Volume down light	Blinking: The volume scroll zone is being used to decrease speaker volume.
(12) Volume up light	Blinking: The volume scroll zone is being used to increase speaker volume.
(13) Calculator light	<ul style="list-style-type: none"> On: The Windows calculator application is on. Blinking: The Windows calculator is in use.

*The two power lights display the same information. The light on the power button is visible only when the computer is open. The power light on the front of the computer is visible whether the computer is open or closed.

†The two wireless lights display the same information. The light on the wireless button is visible only when the computer is open. The wireless light on the front of the computer is visible whether the computer is open or closed.

Buttons, switches, and fingerprint reader

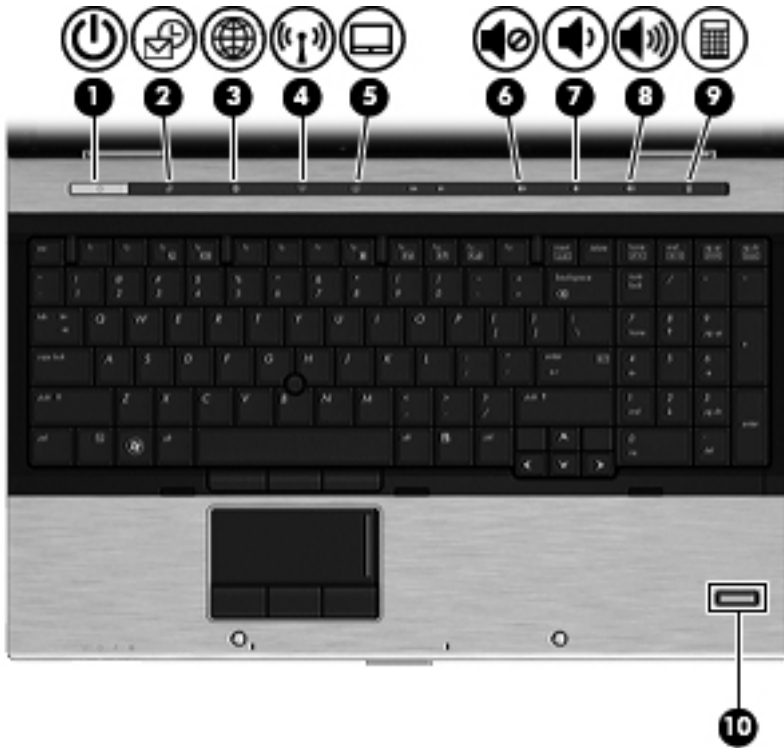

Component	Description
(1) Power button	<ul style="list-style-type: none"> • When the computer is off, press the button to turn on the computer. • When the computer is on, press the button to shut down the computer. • When the computer is in the Sleep state, press the button briefly to exit Sleep. • When the computer is in Hibernation, press the button briefly to exit Hibernation. <p>If the computer has stopped responding and Windows shutdown procedures are ineffective, press and hold the power button for at least 5 seconds to turn off the computer.</p> <p>To learn more about your power settings, select Start > Control Panel > Performance and Maintenance > Power Options.</p>
(2) QuickLook button	<ul style="list-style-type: none"> • When the computer is off, press the button to open HP QuickLook. • When the computer is on, press the button to open Software Setup. <p>NOTE: If Software Setup is not available, the default Web browser opens.</p>

Component	Description
(3) QuickWeb button	<ul style="list-style-type: none">• When the computer is off, press the button to open HP QuickWeb.• When the computer is on, press the button to open the default Web browser.
(4) Wireless button	Turns the wireless feature on or off, but does not establish a wireless connection.
(5) TouchPad button	Enables/disables the TouchPad.
(6) Volume mute button	Mutes and restores speaker sound.
(7) Volume down button	Decreases computer volume.
(8) Volume up button	Increases computer volume.
(9) Calculator button	Turns on the Windows calculator function.
(10) Fingerprint reader	Allows a fingerprint logon to Windows, instead of a password logon.

Keys

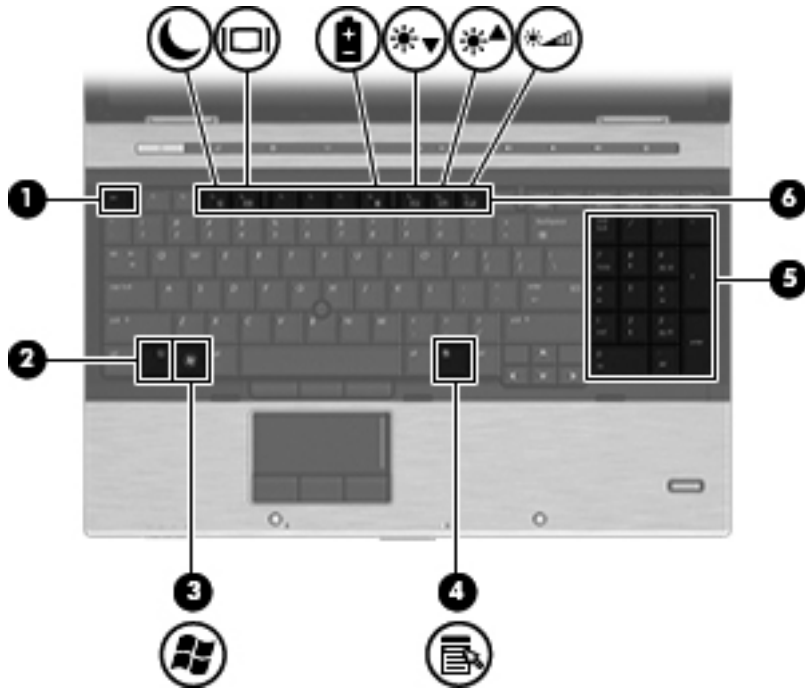

Component	Description
(1) <code>esc</code> key	Displays system information when pressed in combination with the <code>fn</code> key.
(2) <code>fn</code> key	Executes frequently used system functions when pressed in combination with a function key or the <code>esc</code> key.
(3) Windows logo key	Displays the Windows Start menu.
(4) Windows applications key	Displays a shortcut menu for items beneath the pointer.
(5) Integrated numeric keypad keys	Can be used like the keys on an external numeric keypad.
(6) Function keys	Execute frequently used system functions when pressed in combination with the <code>fn</code> key.

Front components



Component	Description
(1) Wireless light	<ul style="list-style-type: none"> An integrated wireless device, such as a WLAN device, the HP Mobile Broadband Module (select models only), and/or a Bluetooth device, is on. Amber: All wireless devices are off.
(2) Power light	<ul style="list-style-type: none"> On: The computer is on. Blinking: The computer is in the Sleep state. Off: The computer is off or in Hibernation.
(3) Battery light	<ul style="list-style-type: none"> Amber: A battery is charging. Turquoise: A battery is close to full charge capacity. Blinking amber: A battery that is the only available power source has reached a low battery level. When the battery reaches a critical battery level, the battery light begins blinking rapidly. Off: If the computer is plugged into an external power source, the light turns off when all batteries in the computer are fully charged. If the computer is not plugged into an external power source, the light stays off until the battery reaches a low battery level.
(4) Drive light	<ul style="list-style-type: none"> Blinking turquoise: The hard drive or optical drive is being accessed. Amber: HP 3D DriveGuard has temporarily parked the hard drive.
(5) Speakers (2)	Produce sound.
(6) Media Card Reader	Supports the following optional digital card formats: <ul style="list-style-type: none"> Memory Stick Memory Stick Duo (adapter required) Memory Stick Pro (adapter required) MultiMediaCard Secure Digital (SD) Memory Card xD-Picture Card xD-Picture Card Type H xD-Picture Card Type M

Component	Description
(7) Display release button	Opens the computer.
(8) Business card slot	Holds a business card in position so that the webcam can capture an image.

Left-side components

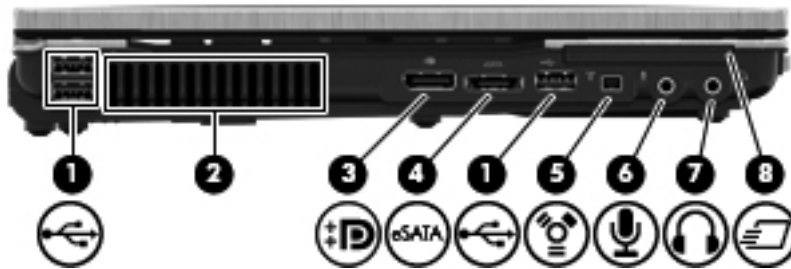

Component	Description
(1) USB ports (3)	Connect optional USB devices.
(2) Vent	Enables airflow to cool internal components. NOTE: The computer fan starts up automatically to cool internal components and prevent overheating. It is normal for the internal fan to cycle on and off during routine operation.
(3) DisplayPort	Connects an optional digital display device, such as a high-performance monitor or projector.
(4) eSATA port	Connects high-performance eSATA components, such as an eSATA external hard drive.
(5) 1394 port	Connects an optional IEEE 1394 or 1394a device, such as a camcorder.
(6) Audio-in (microphone) jack	Connects an optional computer headset microphone, stereo array microphone, or monaural microphone.
(7) Audio-out (headphone) jack	Produces sound when connected to optional powered stereo speakers, headphones, ear buds, a headset, or television audio. NOTE: When a device is connected to the headphone jack, the computer speakers are disabled.
(8) ExpressCard slot	Supports optional ExpressCards.

Rear components



The vent enables airflow to cool internal components.

 **NOTE:** The computer fan starts up automatically to cool internal components and prevent overheating. It is normal for the internal fan to cycle on and off during routine operation.

Component	Description
(1) External monitor port	Connects an external VGA monitor or projector.
(2) Power connector	Connects an AC adapter.

Right-side components



Component	Description
(1) Smart card reader	Supports optional smart cards and Java™ Cards.
(2) Upgrade bay	Supports an optical drive or hard drive.
(3) 3.0 SuperSpeed USB ports (2)	Connect optional USB devices and transfer data at a higher speed than a 2.0 USB device.
(4) RJ-45 (network) jack	Connects a network cable.
(5) RJ-11 (modem) jack	Connects a modem cable.
(6) Security cable slot	Attaches an optional security cable to the computer.

NOTE: The security cable is designed to act as a deterrent, but it may not prevent the computer from being mishandled or stolen.

Bottom components

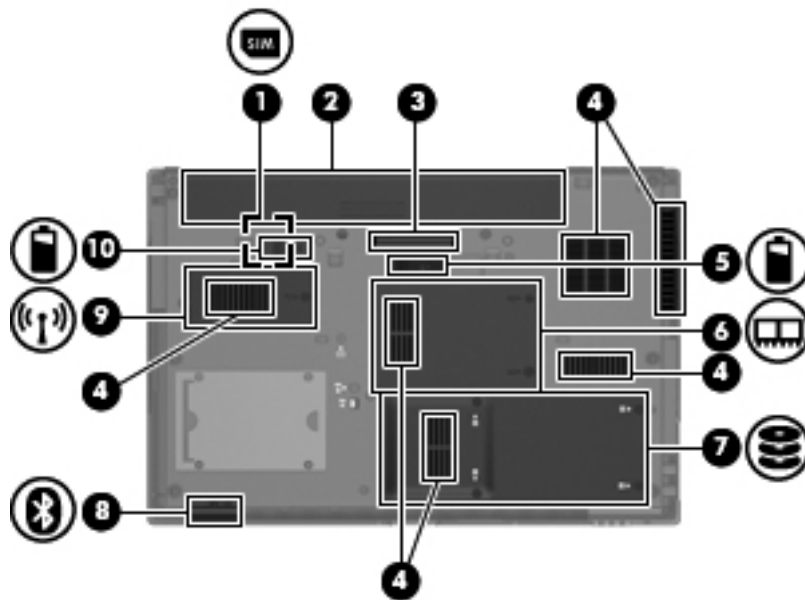

Component	Description
(1) SIM slot	Contains a wireless subscriber identity module (SIM) (select models only). The SIM slot is located inside the battery bay.
(2) Battery bay	Holds the battery.
(3) Docking connector	Connects an optional docking device.
(4) Vents (6)	Enable airflow to cool internal components. NOTE: The computer fan starts up automatically to cool internal components and prevent overheating. It is normal for the internal fan to cycle on and off during routine operation.
(5) Accessory battery connector	Connects an optional accessory battery.
(6) Memory module compartment	Contains two expansion memory module slots.
(7) Hard drive bay	Holds the hard drive.
(8) Bluetooth compartment	Contains a Bluetooth device.
(9) Wireless module compartment	Contains an HP Mobile Broadband Module. NOTE: To prevent an unresponsive system, replace the wireless module only with a wireless module authorized for use in the computer by the governmental agency that regulates wireless devices in your country or region. If you replace the module and then receive a warning message, remove the module to restore computer functionality, and then contact technical support through Help and Support.
(10) Battery release latch	Releases the battery from the battery bay.

Wireless antennas (select models only)

The antennas send and receive signals from one or more wireless devices. These antennas are not visible from the outside of the computer.

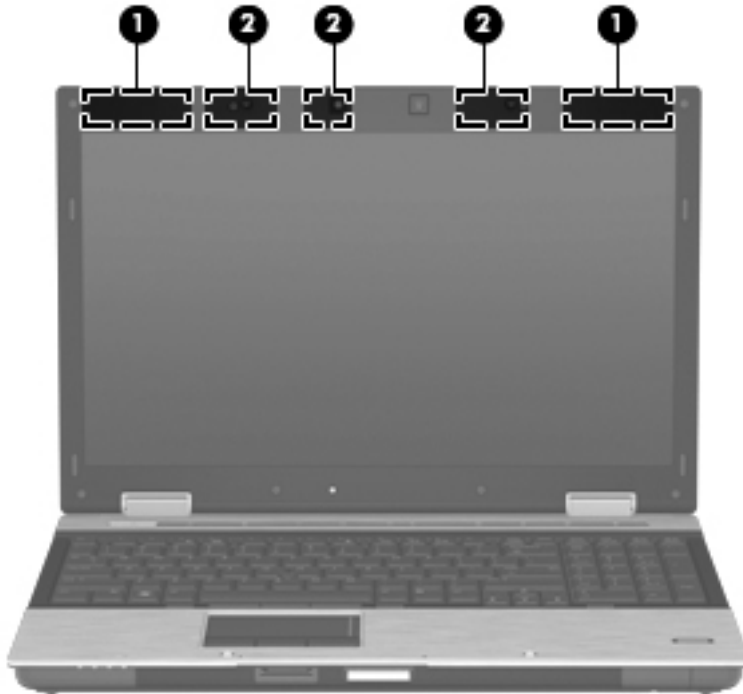

Component	Description
(1) WWAN antennas (2)*	Send and receive wireless signals to communicate with wireless wide area networks (WWANs).
(2) WLAN antennas (3)*	Send and receive wireless signals to communicate with wireless local area networks (WLANs).

*The antennas are not visible from the outside of the computer. For optimal transmission, keep the areas immediately around the antennas free from obstructions.

To see wireless regulatory notices, refer to the section of the *Regulatory, Safety and Environmental Notices* that applies to your country or region. These notices are located in Help and Support.

3 Illustrated parts catalog

Service tag

When ordering parts or requesting information, provide the computer serial number and model description provided on the service tag.



- Product name **(1)**. This is the product name affixed to the front of the computer.
- Serial number (s/n) **(2)**. This is an alphanumeric identifier that is unique to each product.
- Part number/Product number (p/n) **(3)**. This number provides specific information about the product's hardware components. The part number helps a service technician to determine what components and parts are needed.
- Model description **(4)**. This is the alphanumeric identifier used to locate documents, drivers, and support for the computer.
- Warranty period **(5)**. This number describes the duration (in years) of the warranty period for the computer.

Computer major components

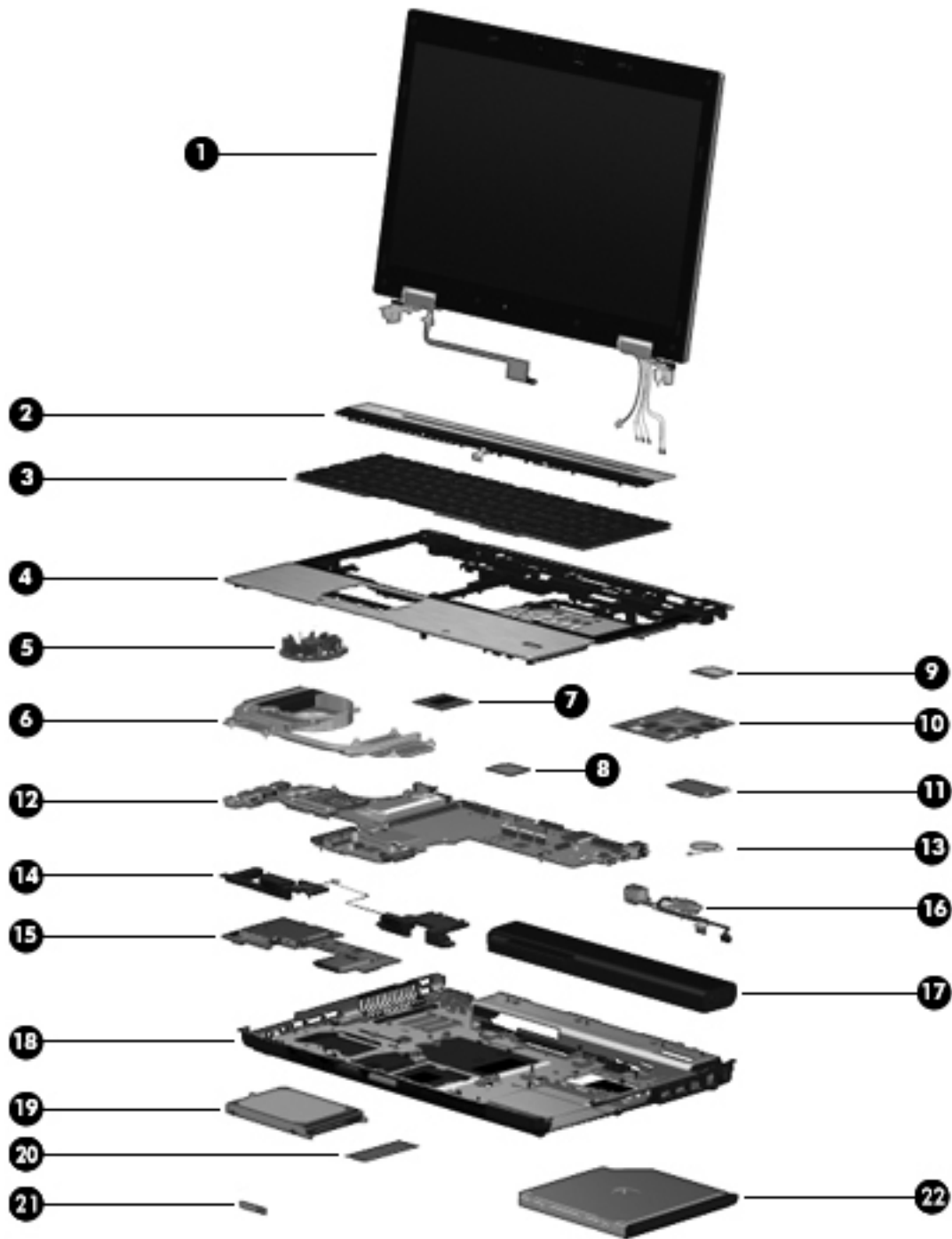

Item	Description	Spare part number
(1)	Display assembly (includes 3 WLAN antenna transceivers and cables and 2 WWAN antenna transceivers and cables)	
	For use in model 8540p:	
	<ul style="list-style-type: none"> 39.6-cm (15.6-in) LED, HD, AntiGlare for use in computers without a webcam 	595736-001

Item	Description	Spare part number
	• 39.6-cm (15.6-in) LED, HD, AntiGlare for use in computers with a webcam	595737-001
	• 39.6-cm (15.6-in) LED, FHD for use in computers without a webcam	595738-001
	• 39.6-cm (15.6-in) LED, FHD for use in computers with a webcam	600755-001
	• 39.6-cm (15.6-in) LED, HD+ WVA for use in computers without a webcam	595739-001
	• 39.6-cm (15.6-in) LED, HD+ for use in computers with a webcam	595740-001
	For use in model 8540w:	
	• 39.6-cm (15.6-in) LED, HD, AntiGlare for use in computers without a webcam	600756-001
	• 39.6-cm (15.6-in) LED, HD, AntiGlare for use in computers with a webcam	600757-001
	• 39.6-cm (15.6-in) LED, HD+ WVA for use in computers without a webcam	600760-001
	• 39.6-cm (15.6-in) LED, HD+ WVA for use in computers with a webcam	600761-001
	• 39.6-cm (15.6-in) LED, FHD for use in computers without a webcam	600758-001
	• 39.6-cm (15.6-in) LED, FHD for use in computers with a webcam	600759-001
	• 39.6-cm (15.6-in) LED, FHD, Dreamcolor for use in computers without a webcam	606979-001
	• 39.6-cm (15.6-in) LED, FHD, DreamColor for use in computers with a webcam	606980-001
(2)	Switch cover	
	For use in model 8540p	595770-001
	For use in model 8540w	595771-001
(3)	Keyboard with pointing stick (includes pointing stick and pointing stick cable)	
	For use in Belgium	595790-A41
	For use in Brazil	595790-201
	For use in Bulgaria	595790-261
	For use in the Czech Republic and Slovakia	595790-A81
	For use in Denmark	595790-081
	For use in France	595790-051
	For use in French Canada	595790-121
	For use in Germany	595790-041
	For use in Greece	595790-DJ1
	For use in Hungary	595790-211
	For use in Iceland	595790-DD1
	For use in Israel	595790-BB1
	For use in Italy	595790-061
	For use in Japan	595790-291
	For use in Latin America	595790-161
	For use in the Netherlands	595790-B31

Item	Description	Spare part number
	For use in Norway	595790-091
	For use in Portugal	595790-131
	For use in Russia	595790-251
	For use in Saudi Arabia	595790-171
	For use in Slovenia	595790-BA1
	For use in South Korea	595790-AD1
	For use in Spain	595790-071
	For use in Sweden	595790-B71
	For use in Switzerland	595790-BG1
	For use in Taiwan	595790-AB1
	For use in Thailand	595790-281
	For use in Turkey	595790-141
	For use in the United Kingdom	595790-031
	For use in the United States	595790-001
(4)	Top cover (includes TouchPad button and bracket)	
	For use with HP EliteBook 8540p computer models that include a fingerprint reader	595775-001
	For use with HP EliteBook 8540p computer models that do not include a fingerprint reader	595776-001
	For use with HP EliteBook 8540w computer models that include a fingerprint reader	595777-001
	For use with HP EliteBook 8540w computer models that do not include a fingerprint reader	595778-001
	Fingerprint reader board (not illustrated; includes fingerprint reader board cable)	595780-001
(5)	Fan	595769-001
(6)	Heat sink (includes replacement thermal material)	
	For use in computers with NVIDIA Quadro FX 1800 graphics (includes fan)	595766-001
	For use in computers with NVIDIA Quadro FX 880 or NVIDIA NVS 5100 graphics (does not include fan)	595767-001
	For use in computers with ATI FirePro M5800 graphics (includes fan)	595768-001
(7)	Processor	
	Intel Core i7 processors, Quad Core	
	820QM, 1.73-GHz (Turbo up to 3.06) processor 8-MB L3 cache, 8 threads	583053-001
	720QM, 1.66-GHz (Turbo up to 2.80) processor 6-MB L3 cache, 8 threads	586170-001
	Intel Core i7 processor, Dual Core	
	620M, 2.66-GHz (Turbo up to 3.33) processor 4-MB L3 cache, 4 threads	587259-001
	Intel Core i5 processors, Dual Core	
	540M, 2.53-GHz (Turbo up to 3.06) processor 3-MB L3 cache, 4 threads	594188-001

Item	Description	Spare part number
	520M, 2.40-GHz (Turbo up to 2.93) processor 3-MB L3 cache, 4 threads	594187-001
(8)	Modem module	
	NOTE: The modem module spare part kit does not include a modem module cable. The modem module cable is included in the Cable Kit, spare part number 595787-001. See Cable Kit on page 30 for more Cable Kit spare part number information.	
	For use in all countries and regions except Australia and New Zealand	510099-001
	For use in Australia and New Zealand	510099-011
(9)	WLAN module	
	Intel Wi-Fi Link 6300, 802.11a/b/g/n for use in Andorra, Antigua and Barbuda, Argentina, Aruba, Australia, Austria, Azerbaijan, Bahamas, Bahrain, Barbados, Belgium, Bermuda, Bolivia, Bosnia and Herzegovina, Brazil, Brunei, Bulgaria, Canada, Cayman Islands, Chile, the People's Republic of China, Colombia, Costa Rica, Croatia, Cyprus, Czech Republic, Denmark, Dominican Republic, Ecuador, Egypt, El Salvador, Estonia, Finland, France, French Guiana, Georgia, Germany, Ghana, Greece, Guadeloupe, Guam, Guatemala, Haiti, Honduras, Hong Kong, Hungary, Iceland, India, Indonesia, Ireland, Israel, Italy, Ivory Coast, Jamaica, Japan, Jordan, Kenya, South Korea, Kuwait, Kyrgyzstan, Latvia, Lebanon, Martinique, US Virgin Islands, Puerto Rico, Nether Antilles, Liechtenstein, Lithuania, Luxembourg, Malawi, Malaysia, Malta, Mauritius, Mexico, Monaco, Montenegro, Morocco, the Netherlands, New Zealand, Nicaragua, Nigeria, Norway, Oman, Pakistan, Panama, Paraguay, Peru, Philippines, Poland, Portugal, Qatar, Romania, San Marino, Saudi Arabia, Senegal, Singapore, Slovakia, Slovenia, South Africa, Spain, Sri Lanka, Sweden, Switzerland, Taiwan, Tanzania, Thailand, Trinidad and Tobago, Turkey, the United Arab Emirates, the United Kingdom, the United States, Uruguay, Venezuela, and Vietnam	572511-001
	Intel Wi-Fi Link 6200, 802.11a/b/g/n for use in Andorra, Antigua and Barbuda, Argentina, Aruba, Australia, Austria, Azerbaijan, Bahamas, Bahrain, Barbados, Belgium, Bermuda, Bolivia, Bosnia and Herzegovina, Brazil, Brunei, Bulgaria, Canada, Cayman Islands, Chile, the People's Republic of China, Colombia, Costa Rica, Croatia, Cyprus, Czech Republic, Denmark, Dominican Republic, Ecuador, Egypt, El Salvador, Estonia, Finland, France, French Guiana, Georgia, Germany, Ghana, Greece, Guadeloupe, Guam, Guatemala, Haiti, Honduras, Hong Kong, Hungary, Iceland, India, Indonesia, Ireland, Israel, Italy, Ivory Coast, Jamaica, Japan, Jordan, Kenya, Kuwait, Kyrgyzstan, Latvia, Lebanon, Martinique, Liechtenstein, Lithuania, Luxembourg, Malawi, Malaysia, Malta, Mauritius, Mexico, Monaco, Montenegro, Morocco, the Nether Antilles, the Netherlands, New Zealand, Nicaragua, Nigeria, Norway, Oman, Pakistan, Panama, Paraguay, Peru, Philippines, Poland, Portugal, Puerto Rico, Qatar, Romania, San Marino, Saudi Arabia, Senegal, Singapore, Slovakia, Slovenia, South Africa, South Korea, Spain, Sri Lanka, Sweden, Switzerland, Taiwan, Tanzania, Thailand, Trinidad and Tobago, Tunisia, Turkey, the United Arab Emirates, the United Kingdom, the United States, Uruguay, the U.S. Virgin Islands, Venezuela, and Vietnam	572509-001
	Intel Wi-Fi Link 6100, 802.11a/b/g for use in Russia and Ukraine	572510-001
	Broadcom 4322 AGN 802.11a/b/g/n WLAN module for use in Antigua and Barbuda, Barbados, Belize, Canada, the Cayman Islands, Guam, Puerto Rico, Trinidad and Tobago, the U.S. Virgin Islands, and the United States	518434-001

Item	Description	Spare part number
	Broadcom 4322 AGN 802.11a/b/g/n WLAN module for use in Afghanistan, Albania, Algeria, Andorra, Angola, Antigua and Barbuda, Argentina, Armenia, Aruba, Australia, Austria, Azerbaijan, the Bahamas, Bahrain, Bangladesh, Barbados, Belarus, Belgium, Belize, Benin, Bermuda, Bhutan, Bolivia, Bosnia and Herzegovina, Botswana, Brazil, the British Virgin Islands, Brunei, Bulgaria, Burkina Faso, Burundi, Cameroon, Cape Verde, the Central African Republic, Chad, Chile, the People's Republic of China, Colombia, Comoros, the Congo, Costa Rica, Croatia, Cyprus, the Czech Republic, Denmark, Djibouti, Dominica, the Dominican Republic, East Timor, Ecuador, Egypt, El Salvador, Equatorial Guinea, Eritrea, Estonia, Ethiopia, Fiji, Finland, France, French Guiana, Gabon, Gambia, Georgia, Germany, Ghana, Gibraltar, Greece, Grenada, Guadeloupe, Guatemala, Guinea, Guinea-Bissau, Guyana, Haiti, Honduras, Hong Kong, Hungary, Iceland, India, Ireland, Israel, Italy, the Ivory Coast, Jamaica, Jordan, Kazakhstan, Kenya, Kiribati, Kyrgyzstan, Laos, Latvia, Lebanon, Lesotho, Liberia, Liechtenstein, Lithuania, Luxembourg, Macedonia, Madagascar, Malawi, Malaysia, the Maldives, Mali, Malta, the Marshall Islands, Martinique, Mauritania, Mauritius, Mexico, Micronesia, Monaco, Mongolia, Montenegro, Morocco, Mozambique, Namibia, Nauru, Nepal, the Nether Antilles, the Netherlands, New Zealand, Nicaragua, Niger, Nigeria, Norway, Oman, Pakistan, Palau, Panama, Papua New Guinea, Paraguay, Peru, the Philippines, Poland, Portugal, the Republic of Moldova, Romania, Russia, Rwanda, Samoa, San Marino, Sao Tome and Principe, Saudi Arabia, Senegal, Serbia, the Seychelles, Sierra Leone, Singapore, Slovakia, Slovenia, the Solomon Islands, Somalia, South Africa, South Korea, Spain, Sri Lanka, St. Kitts and Nevis, St. Lucia, St. Vincent and the Grenadines, Suriname, Swaziland, Sweden, Switzerland, Taiwan, Tajikistan, Tanzania, Togo, Tonga, Trinidad and Tobago, Tunisia, Turkey, Turkmenistan, Tuvalu, Uganda, Ukraine, the United Arab Emirates, the United Kingdom, Uruguay, Uzbekistan, Vanuatu, Venezuela, Vietnam, Yemen, Zaire, Zambia, and Zimbabwe	518434-002
(10)	Graphics card (includes replacement thermal material)	
	NVIDIA NVS 5100 graphics card	595820-001
	NVIDIA Quadro FX 880 graphics card	595821-001
	NVIDIA Quadro FX 1800 graphics card	595822-001
	ATI FirePro M5800 graphics card	595823-001
(11)	HP un2420 Broadband Module (WWAN)	531993-001
(12)	System board (includes replacement thermal material and VGA support bracket)	
	For use with the following dual-core processors: 520M, 540M, 620M	595764-001
	For use with the following quad-core processors: 720QM, 820QM	595765-001
(13)	RTC battery	581075-001
(14)	Speaker assembly	595788-001
(15)	ExpressCard/audio assembly	595783-001
(16)	USB/VGA board (includes cable)	595782-001
(17)	8-cell Li-ion battery	
	73-Wh battery	493976-001
	68-Wh battery	592078-001
(18)	Base enclosure (includes rubber feet)	
	For use with HP EliteBook 8540w computer models without an RJ-11 cap	595772-001
	For use with HP EliteBook 8540p computer models with an RJ-11 cap	595773-001
	For use with HP EliteBook 8540p computer models without an RJ-11 cap	595774-001

Item	Description	Spare part number
(19)	Hard drive (includes hard drive bracket and screws)	
	500-GB, 7200-rpm	595755-001
	500-GB, 7200-rpm (for use in the upgrade bay)	595762-001
	320-GB, 7200-rpm	595754-001
	250-GB, 7200-rpm	595753-001
	256-GB solid-state drive	595756-001
	160-GB solid-state drive	595757-001
(20)	Memory modules (PC3-10600, 1333-MHz, DDR3)	
	4-GB	599092-001
	2-GB	598856-001
(21)	Bluetooth module (does not include Bluetooth module cable)	537921-001
	NOTE: The Bluetooth module spare part kit does not include a Bluetooth module cable. The Bluetooth module cable is included in the Cable Kit, spare part number 595787-001. See Cable Kit on page 30 for more Cable Kit spare part number information.	
(22)	Optical drive (includes bracket, bezel, and screws)	
	DVD±RW and CD-RW SuperMulti DL Combo Drive with LightScribe	595759-001
	Blu-ray Disc ROM with SuperMulti DVD+/-R/RW DL Drive	595760-001
	DVD-ROM Drive	595758-001
	Blu-ray ROM DVD±RW SuperMulti DL Drive	595761-001
	Cable Kit (not illustrated; see Cable Kit on page 30 for more Cable Kit spare part number information)	595787-001

Display components

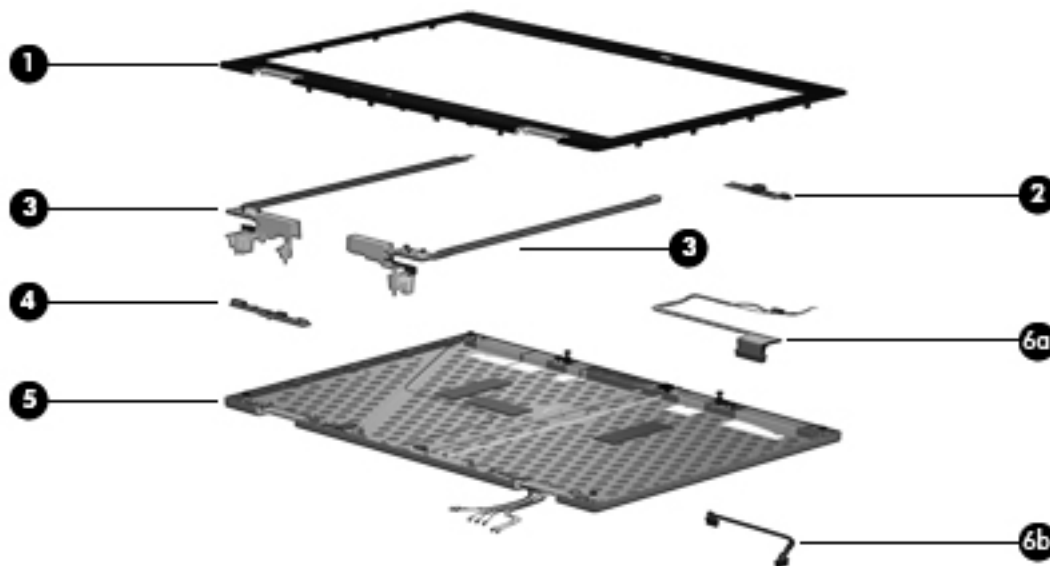

Item	Description	Spare part number
(1)	Display bezel	
	For use with computer models with a webcam	595747-001
	For use with computer models without a webcam	595748-001
	For use with computer models with DreamColor displays	595749-001
(2)	Webcam module	583219-001
(3)	Display hinges (includes left and right hinges)	
	For use with computer models that do not use DreamColor displays	595742-001
	For use with computer models that use DreamColor displays	595743-001
(4)	Ambient light sensor	595781-001
(5)	Display enclosure (includes antennas, microphone, and microphone mylar)	
	For use in HP Elite 8540p models	595744-001
	For use in HP Elite 8540w models that do not use DreamColor displays	595745-001
	For use in HP Elite 8540w models that use DreamColor displays	595746-001
	Display cable kit , includes:	595741-001
(6a)	LCD cable, main	
(6b)	LCD cable, color mapping board to panel	

Plastics Kit

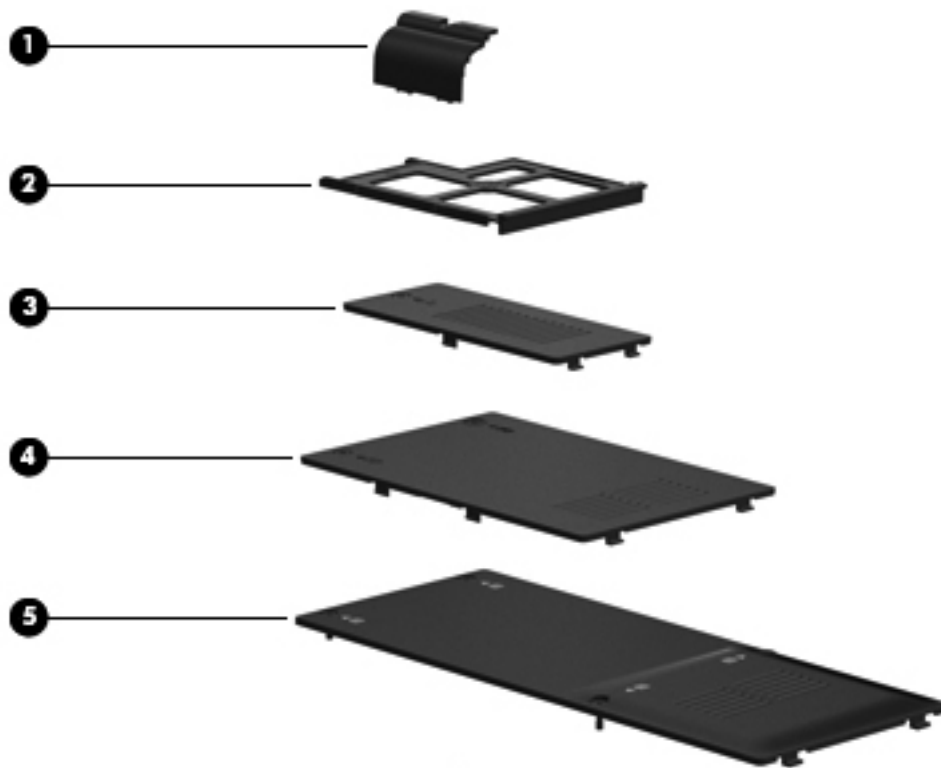

Item	Description	Spare part number
Plastics Kit:		595784-001
(1)	Bluetooth module cover	
(2)	ExpressCard slot protective insert	
(3)	WWAN cover	
(4)	Memory module compartment cover (includes 2 captive screws, secured by C-clips)	
(5)	Hard drive cover (includes 4 captive screws, secured by C-clips)	
	LCD hinge covers (left and right; not illustrated)	
	Optical drive panel (not illustrated)	

Cable Kit

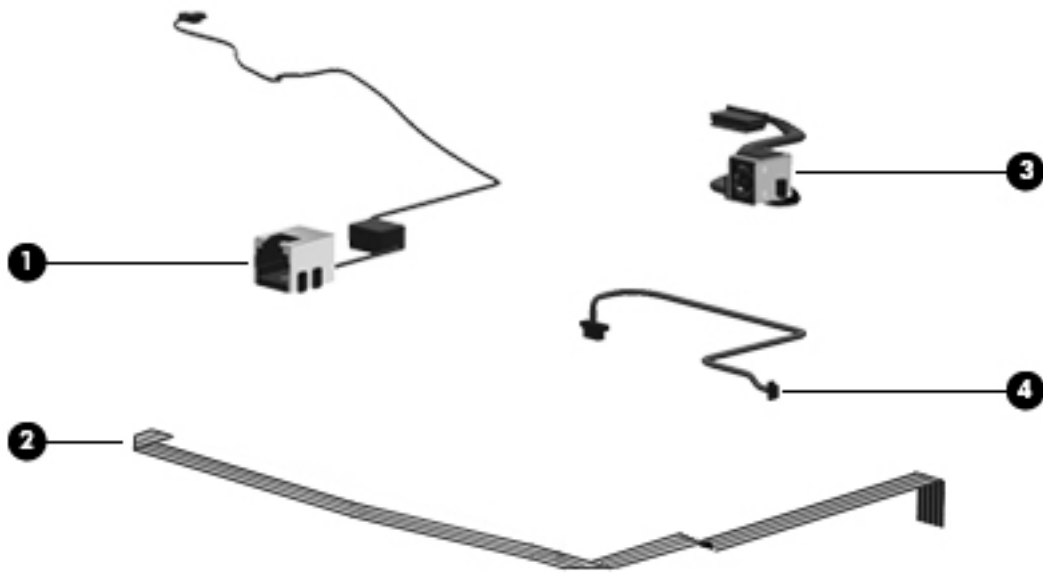

Item	Description	Spare part number
	Cable Kit:	595787-001
(1)	RJ-11 connector cable	
(2)	TouchPad cable	
(3)	Power connector cable	
(4)	Bluetooth module cable	

Mass storage devices

Item	Description	Spare part number
(1)	Optical drive	
	DVD±RW and CD-RW SuperMulti DL Combo Drive with LightScribe	595759-001
	Blu-ray Disc ROM with SuperMulti DVD±R/RW DL Drive	595760-001
	DVD-ROM Drive	595758-001
	Blu-ray ROM DVD±RW SuperMulti DL Drive	595761-001
(3)	Hard drive (includes bracket and screws)	
	500-GB, 7200-rpm	595755-001
	500-GB, 7200-rpm (for use in the upgrade bay)	595762-001
	320-GB, 7200-rpm	595754-001
	250-GB, 7200-rpm	595753-001
	256-GB solid-state drive (SSD)	595756-001
	160-GB solid-state drive (SSD)	595757-001

Miscellaneous parts

Description	Spare part number
AC adapters	
90-W AC adapter	463955-001
90-W AC adapter for use in India	535593-001
120-W AC adapter	463953-001
150-W AC adapter	463954-001
Battery latch kit (includes latch, knob, and spring)	595750-001
Power cords:	
For use in Argentina	490371-D01
For use in Australia	490371-011
For use in Brazil	490371-201
For use in Denmark	490371-081
For use in Europe, the Middle East, and Africa	490371-021
For use in India	490371-D01
For use in Israel	490371-BB1
For use in Italy	490371-061
For use in Japan	490371-291
For use in the People's Republic of China	490371-AA1
For use in South Africa	490371-AR1
For use in South Korea	490371-AD1
For use in Switzerland	490371-111
Power cord for use in Taiwan	490371-AB1
For use in the United Kingdom	490371-031
For use in the United States	490371-001

Description	Spare part number
Rubber Kit (includes rubber feet and rubber screw covers)	595785-001
Screw Kit	595786-001
<ul style="list-style-type: none"> • Phillips PM2.0×5.0 captive screw • Black Phillips PM2.5×12.0 captive screw • Silver Phillips PM2.5×12.0 captive screw • Phillips PM2.0×7.0 captive screw • Phillips PM2.0×4.0 screw • Phillips PM3.0×3.0 screw • Phillips PM2.5×5.0 screw • Phillips PM2.5×3.0 screw • Phillips PM2.0×3.0 screw • Black Phillips PM2.5×6.0 screw • Black Phillips PM2.0×5.0 screw • HM2.5×6.0 hex screw lock • Torx T8M2.5×7.0 screw • Torx T8M2.5×8.0 screw • Torx T8M2.0×8.0 screw • Torx T8M2.5×6.0 screw 	

Sequential part number listing

Spare part number	Description
463953-001	120-W AC adapter
463954-001	150-W AC adapter
463955-001	90-W AC adapter
490371-001	Power cord for use in North America
490371-011	Power cord for use in Australia
490371-021	Power cord for use in Europe, the Middle East, and Africa
490371-031	Power cord for use in the United Kingdom
490371-061	Power cord for use in Italy
490371-081	Power cord for use in Denmark
490371-111	Power cord for use in Switzerland
490371-201	Power cord for use in Brazil

Spare part number	Description
490371-291	Power cord for use in Japan
490371-AA1	Power cord for use in the People's Republic of China
490371-AB1	Power cord for use in Taiwan
490371-AD1	Power cord for use in South Korea
490371-AR1	Power cord for use in South Africa
490371-BB1	Power cord for use in Israel
490371-D01	Power cord for use in Argentina
490371-D61	Power cord for use in India
493976-001	8-cell, 2.55-Ah (73-Wh) Li-ion battery
510099-001	Modem module for use in all countries and regions except Australia and New Zealand NOTE: The modem module spare part kit does not include a modem module cable. The modem module cable is included in the Cable Kit, spare part number 595787-001. See Cable Kit on page 30 for more Cable Kit spare part number information.
510099-011	Modem module for use in Australia and New Zealand
518434-001	Broadcom 4322 AGN 802.11a/b/g/n WLAN module for use in Antigua and Barbuda, Barbados, Belize, Canada, the Cayman Islands, Guam, Puerto Rico, Trinidad and Tobago, the U.S. Virgin Islands, and the United States
518434-002	Broadcom 4322 AGN 802.11a/b/g/n WLAN module for use in Afghanistan, Albania, Algeria, Andorra, Angola, Antigua and Barbuda, Argentina, Armenia, Aruba, Australia, Austria, Azerbaijan, the Bahamas, Bahrain, Bangladesh, Barbados, Belarus, Belgium, Belize, Benin, Bermuda, Bhutan, Bolivia, Bosnia and Herzegovina, Botswana, Brazil, the British Virgin Islands, Brunei, Bulgaria, Burkina Faso, Burundi, Cameroon, Cape Verde, the Central African Republic, Chad, Chile, the People's Republic of China, Colombia, Comoros, the Congo, Costa Rica, Croatia, Cyprus, the Czech Republic, Denmark, Djibouti, Dominica, the Dominican Republic, East Timor, Ecuador, Egypt, El Salvador, Equatorial Guinea, Eritrea, Estonia, Ethiopia, Fiji, Finland, France, French Guiana, Gabon, Gambia, Georgia, Germany, Ghana, Gibraltar, Greece, Grenada, Guadeloupe, Guatemala, Guinea, Guinea-Bissau, Guyana, Haiti, Honduras, Hong Kong, Hungary, Iceland, India, Ireland, Israel, Italy, the Ivory Coast, Jamaica, Jordan, Kazakhstan, Kenya, Kiribati, Kyrgyzstan, Laos, Latvia, Lebanon, Lesotho, Liberia, Liechtenstein, Lithuania, Luxembourg, Macedonia, Madagascar, Malawi, Malaysia, the Maldives, Mali, Malta, the Marshall Islands, Martinique, Mauritania, Mauritius, Mexico, Micronesia, Monaco, Mongolia, Montenegro, Morocco, Mozambique, Namibia, Nauru, Nepal, the Nether Antilles, the Netherlands, New Zealand, Nicaragua, Niger, Nigeria, Norway, Oman, Pakistan, Palau, Panama, Papua New Guinea, Paraguay, Peru, the Philippines, Poland, Portugal, the Republic of Moldova, Romania, Russia, Rwanda, Samoa, San Marino, Sao Tome and Principe, Saudi Arabia, Senegal, Serbia, the Seychelles, Sierra Leone, Singapore, Slovakia, Slovenia, the Solomon Islands, Somalia, South Africa, South Korea, Spain, Sri Lanka, St. Kitts and Nevis, St. Lucia, St. Vincent and the Grenadines, Suriname, Swaziland, Sweden, Switzerland, Taiwan, Tajikistan, Tanzania, Togo, Tonga, Trinidad and Tobago, Tunisia, Turkey, Turkmenistan, Tuvalu, Uganda, Ukraine, the United Arab Emirates, the United Kingdom, Uruguay, Uzbekistan, Vanuatu, Venezuela, Vietnam, Yemen, Zaire, Zambia, and Zimbabwe
531993-001	HP un2420 Broadband Module (WWAN)
535593-001	90-W AC adapter for use in India
537921-001	Bluetooth module

Spare part number	Description
572509-001	Intel Wi-Fi Link 6200, 802.11a/b/g/n WLAN module for use in Andorra, Antigua and Barbuda, Argentina, Aruba, Australia, Austria, Azerbaijan, Bahamas, Bahrain, Barbados, Belgium, Bermuda, Bolivia, Bosnia and Herzegovina, Brazil, Brunei, Bulgaria, Canada, Cayman Islands, Chile, the People's Republic of China, Colombia, Costa Rica, Croatia, Cyprus, Czech Republic, Denmark, Dominican Republic, Ecuador, Egypt, El Salvador, Estonia, Finland, France, French Guiana, Georgia, Germany, Ghana, Greece, Guadeloupe, Guam, Guatemala, Haiti, Honduras, Hong Kong, Hungary, Iceland, India, Indonesia, Ireland, Israel, Italy, Ivory Coast, Jamaica, Japan, Jordan, Kenya, Kuwait, Kyrgyzstan, Latvia, Lebanon, Martinique, Liechtenstein, Lithuania, Luxembourg, Malawi, Malaysia, Malta, Mauritius, Mexico, Monaco, Montenegro, Morocco, the Nether Antilles, the Netherlands, New Zealand, Nicaragua, Nigeria, Norway, Oman, Pakistan, Panama, Paraguay, Peru, Philippines, Poland, Portugal, Puerto Rico, Qatar, Romania, San Marino, Saudi Arabia, Senegal, Singapore, Slovakia, Slovenia, South Africa, South Korea, Spain, Sri Lanka, Sweden, Switzerland, Taiwan, Tanzania, Thailand, Trinidad and Tobago, Tunisia, Turkey, the United Arab Emirates, the United Kingdom, the United States, Uruguay, the U.S. Virgin Islands, Venezuela, and Vietnam
572510-001	Intel Wi-Fi Link 6100, 802.11a/b/g WLAN module for use in Russia and Ukraine
572511-001	Intel Wi-Fi Link 6300, 802.11a/b/g/n WLAN module for use in Andorra, Antigua and Barbuda, Argentina, Aruba, Australia, Austria, Azerbaijan, Bahamas, Bahrain, Barbados, Belgium, Bermuda, Bolivia, Bosnia and Herzegovina, Brazil, Brunei, Bulgaria, Canada, Cayman Islands, Chile, the People's Republic of China, Colombia, Costa Rica, Croatia, Cyprus, Czech Republic, Denmark, Dominican Republic, Ecuador, Egypt, El Salvador, Estonia, Finland, France, French Guiana, Georgia, Germany, Ghana, Greece, Guadeloupe, Guam, Guatemala, Haiti, Honduras, Hong Kong, Hungary, Iceland, India, Indonesia, Ireland, Israel, Italy, Ivory Coast, Jamaica, Japan, Jordan, Kenya, South Korea, Kuwait, Kyrgyzstan, Latvia, Lebanon, Martinique, US Virgin Islands, Puerto Rico, Nether Antilles, Liechtenstein, Lithuania, Luxembourg, Malawi, Malaysia, Malta, Mauritius, Mexico, Monaco, Montenegro, Morocco, the Netherlands, New Zealand, Nicaragua, Nigeria, Norway, Oman, Pakistan, Panama, Paraguay, Peru, Philippines, Poland, Portugal, Qatar, Romania, San Marino, Saudi Arabia, Senegal, Singapore, Slovakia, Slovenia, South Africa, Spain, Sri Lanka, Sweden, Switzerland, Taiwan, Tanzania, Thailand, Trinidad and Tobago, Turkey, the United Arab Emirates, the United Kingdom, the United States, Uruguay, Venezuela, and Vietnam
581075-001	RTC battery
583053-001	Intel Core i7 820QM Quad Core processor, 1.73-GHz (Turbo up to 3.06), 8-MB L3 cache, 8 threads
583219-001	Webcam module
586170-001	Intel Core i7 720QM Quad Core processor, 1.66-GHz (Turbo up to 2.80), 6-MB L3 cache, 8 threads
587259-001	Intel Core i7 620M Dual Core processor, 2.66-GHz (Turbo up to 3.33), 4-MB L3 cache, 4 threads
592078-001	8-cell, 68-Wh Li-ion battery
594187-001	Intel Core i5 520M Dual Core processor, 2.40-GHz (Turbo up to 2.93), 3-MB L3 cache, 4 threads
594188-001	Intel Core i5 540M Dual Core processor, 2.53-GHz (Turbo up to 3.06), 3-MB L3 cache, 4 threads
595736-001	39.6-cm (15.6-in) LED display assembly, HD, AntiGlare for use in computers without a webcam (includes 3 WLAN antenna transceivers and cables and 2 WWAN antenna transceivers and cables)
595737-001	39.6-cm (15.6-in) LED display assembly, HD, AntiGlare for use in computers with a webcam (includes 3 WLAN antenna transceivers and 2 WWAN antenna transceivers and cables)
595738-001	39.6-cm (15.6-in) LED display assembly, FHD for use in computers without a webcam (includes 3 WLAN antenna transceivers and cables and 2 WWAN antenna transceivers and cables)
595739-001	39.6-cm (15.6-in) LED display assembly, HD+ WVA for use in computers without a webcam (includes 3 WLAN antenna transceivers and cables and 2 WWAN antenna transceivers and cables)
595740-001	39.6-cm (15.6-in) LED display assembly, HD+ for use in computers with a webcam (includes 3 WLAN antenna transceivers and cables and 2 WWAN antenna transceivers and cables)
595741-001	Display cable kit, includes LCD cable, LCD cable (system board to color mapping board), LCD cable (color mapping board to panel)

Spare part number	Description
595742-001	Display hinges for use in models that do not use DreamColor displays (includes left and right hinge)
595743-001	Display hinges for use with models with DreamColor displays (includes left and right hinge)
595744-001	Display enclosure for use in HP Elite 8540p models (includes antennas, microphone, and microphone mylar)
595745-001	Display enclosure for use in HP Elite 8540w models that do not use DreamColor displays (includes antennas, microphone, and microphone mylar)
595746-001	Display enclosure for use in HP Elite 8540w models that use DreamColor displays (includes antennas, microphone, and microphone mylar)
595747-001	Display bezel for use with computer models with a webcam
595748-001	Display bezel for use with computer models without a webcam
595749-001	Display bezel for use with computer models with DreamColor
595750-001	Battery latch kit (includes latch, knob, and spring)
595753-001	250-GB, 7200-rpm hard drive (includes hard drive bracket and screws)
595754-001	320-GB, 7200-rpm hard drive (includes hard drive bracket and screws)
595755-001	500-GB, 7200-rpm hard drive (includes hard drive bracket and screws)
595756-001	256-GB solid-state drive (SSD) (includes hard drive bracket and screws)
595757-001	160-GB solid-state drive (SSD) (includes hard drive bracket and screws)
595758-001	DVD-ROM drive
595759-001	DVD±RW and CD-RW SuperMulti DL combo drive with LightScribe
595760-001	Blu-ray Disc ROM with SuperMulti DVD±R/RW DL drive
595761-001	Blu-ray ROM DVD±RW SuperMulti DL Drive
595762-001	500-GB, 7200-rpm hard drive for use in the upgrade bay (includes hard drive bracket and screws)
595764-001	System board for use with the following dual-core processors: 520M, 540M, 620M (includes replacement thermal material and VGA support bracket)
595765-001	System board for use with the following quad-core processors: 720QM, 820QM (includes replacement thermal material and VGA support bracket)
595766-001	Heat sink with fan (for use in computers with NVIDIA Quadro FX 1800 graphics)
595767-001	Heat sink for use in computers with NVIDIA Quadro FX 880 or NVIDIA NVS 5100 graphics (does not include fan)
595768-001	Heat sink for use in computers with ATI FirePro M5800 graphics (includes fan)
595769-001	Fan
595770-001	Switch cover for use in model 8540p (includes LED board and cable)
595771-001	Switch cover for use in model 8540w (includes LED board and cable)
595772-001	Base enclosure for use with HP EliteBook 8540w computer models without an RJ-11 cap
595773-001	Base enclosure for use with HP EliteBook 8540p computer models with an RJ-11 cap
595774-001	Base enclosure for use with HP EliteBook 8540p computer models without an RJ-11 cap

Spare part number	Description
595775-001	Top cover for use with HP EliteBook 8540p computer models that include a fingerprint reader (includes TouchPad button and bracket)
595776-001	Top cover for use with HP EliteBook 8540p computer models that do not include a fingerprint reader (includes TouchPad button and bracket)
595777-001	Top cover for use with HP EliteBook 8540w computer models that include a fingerprint reader (includes Touchpad button and bracket)
595778-001	Top cover for use with HP EliteBook 8540w computer models that do not include a fingerprint reader (includes Touchpad button and bracket)
595780-001	Fingerprint reader board (includes fingerprint reader board cable)
595781-001	Ambient light sensor board (includes cable)
595782-001	USB/VGA board (includes cable)
595783-001	ExpressCard/audio assembly
595784-001	Plastics Kit (see Plastics Kit on page 29 for more Plastics Kit spare part information)
595785-001	Rubber Kit (includes rubber feet and rubber screw covers)
595786-001	Screw Kit
595787-001	Cable Kit (see Cable Kit on page 30 for more Cable Kit spare part information)
595788-001	Speaker assembly
595790-001	Keyboard with pointing stick for use in the United States (includes keyboard and pointing stick cables)
595790-121	Keyboard with pointing stick for use in French Canada (includes keyboard and pointing stick cables)
595790-201	Keyboard with pointing stick for use in Brazil (includes keyboard and pointing stick cables)
595790-161	Keyboard with pointing stick for use in Latin America (includes keyboard and pointing stick cables)
595790-BA1	Keyboard with pointing stick for use in Slovenia (includes keyboard and pointing stick cables)
595790-171	Keyboard with pointing stick for use in Saudi Arabia (includes keyboard and pointing stick cables)
595790-A41	Keyboard with pointing stick for use in Belgium (includes keyboard and pointing stick cables)
595790-261	Keyboard with pointing stick for use in Bulgaria (includes keyboard and pointing stick cables)
595790-A81	Keyboard with pointing stick for use in the Czech Republic and Slovakia (includes keyboard and pointing stick cables)
595790-081	Keyboard with pointing stick for use in Denmark (includes keyboard and pointing stick cables)
595790-B31	Keyboard with pointing stick for use in the Netherlands and Europe (includes keyboard and pointing stick cables)
595790-051	Keyboard with pointing stick for use in France (includes keyboard and pointing stick cables)
595790-041	Keyboard with pointing stick for use in Germany (includes keyboard and pointing stick cables)
595790-DJ1	Keyboard with pointing stick for use in Greece (includes keyboard and pointing stick cables)
595790-DD1	Keyboard with pointing stick for use in Iceland (includes keyboard and pointing stick cables)
595790-211	Keyboard with pointing stick for use in Hungary (includes keyboard and pointing stick cables)
595790-BB1	Keyboard with pointing stick for use in Israel (includes keyboard and pointing stick cables)

Spare part number	Description
595790-061	Keyboard with pointing stick for use in Italy (includes keyboard and pointing stick cables)
595790-091	Keyboard with pointing stick for use in Norway (includes keyboard and pointing stick cables)
595790-131	Keyboard with pointing stick for use in Portugal (includes keyboard and pointing stick cables)
595790-251	Keyboard with pointing stick for use in Russia (includes keyboard and pointing stick cables)
595790-071	Keyboard with pointing stick for use in Spain (includes keyboard and pointing stick cables)
595790-B71	Keyboard with pointing stick for use in Sweden (includes keyboard and pointing stick cables)
595790-BG1	Keyboard with pointing stick for use in Switzerland (includes keyboard and pointing stick cables)
595790-141	Keyboard with pointing stick for use in Turkey (includes keyboard and pointing stick cables)
595790-031	Keyboard with pointing stick for use in the United Kingdom (includes keyboard and pointing stick cables)
595790-291	Keyboard with pointing stick for use in Japan (includes keyboard and pointing stick cables)
595790-AD1	Keyboard with pointing stick for use in South Korea (includes keyboard and pointing stick cables)
595790-AB1	Keyboard with pointing stick for use in Taiwan (includes keyboard and pointing stick cables)
595790-281	Keyboard with pointing stick for use in Thailand (includes keyboard and pointing stick cables)
595820-001	NVIDIA NVS 5100 graphics card (includes replacement thermal material)
595821-001	NVIDIA Quadro FX 880 graphics card (includes replacement thermal material)
595822-001	NVIDIA Quadro FX 1800 graphics card (includes replacement thermal material)
595823-001	ATI FirePro M5800 graphics card
595824-001	ExpressCard cage assembly with LED
598856-001	2-GB memory module (PC3-10600, 1333-MHz, DDR3)
599092-001	4-GB memory module (PC3-10600, 1333-MHz, DDR3)
600755-001	39.6-cm (15.6-in) LED display assembly, FHD for use in model 8540p computers with a webcam (includes 3 WLAN antenna transceivers and cables and 2 WWAN antenna transceivers and cables)
600756-001	39.6-cm (15.6-in) LED display assembly, HD, AntiGlare for use in model 8540w computers without a webcam (includes 3 WLAN antenna transceivers and cables and 2 WWAN antenna transceivers and cables)
600757-001	39.6-cm (15.6-in) LED display assembly, HD, AntiGlare for use in model 8540w computers with a webcam (includes 3 WLAN antenna transceivers and cables and 2 WWAN antenna transceivers and cables)
600758-001	39.6-cm (15.6-in) LED display assembly, FHD for use in model 8540w computers without a webcam (includes 3 WLAN antenna transceivers and cables and 2 WWAN antenna transceivers and cables)
600759-001	39.6-cm (15.6-in) LED display assembly, FHD for use in model 8540w computers with a webcam (includes 3 WLAN antenna transceivers and cables and 2 WWAN antenna transceivers and cables)
600760-001	39.6-cm (15.6-in) LED display assembly, HD+ WVA for use in computers without a webcam (includes 3 WLAN antenna transceivers and cables and 2 WWAN antenna transceivers and cables)
600761-001	39.6-cm (15.6-in) LED display assembly, HD+ WVA for use in computers with a webcam (includes 3 WLAN antenna transceivers and cables and 2 WWAN antenna transceivers and cables)

Spare part number	Description
606979-001	39.6-cm (15.6-in) LED display assembly, FHD, DreamColor for use in model 8540w computers without a webcam (includes 3 WLAN antenna transceivers and cables and 2 WWAN antenna transceivers and cables)
606980-001	39.6-cm (15.6-in) LED display assembly, FHD, DreamColor for use in model 8540w computers with a webcam (includes 3 WLAN antenna transceivers and cables and 2 WWAN antenna transceivers and cables)

4 Removal and replacement procedures

Preliminary replacement requirements

Tools required

You will need the following tools to complete the removal and replacement procedures:

- Flat-bladed screwdriver
- Phillips P0 and P1 screwdrivers
- Torx T8 screwdriver

Service considerations

The following sections include some of the considerations that you must keep in mind during disassembly and assembly procedures.

 **NOTE:** As you remove each subassembly from the computer, place the subassembly (and all accompanying screws) away from the work area to prevent damage.

Plastic parts

 **CAUTION:** Using excessive force during disassembly and reassembly can damage plastic parts. Use care when handling the plastic parts. Apply pressure only at the points designated in the maintenance instructions.

Cables and connectors

-
- △ **CAUTION:** When servicing the computer, be sure that cables are placed in their proper locations during the reassembly process. Improper cable placement can damage the computer.
-

Cables must be handled with extreme care to avoid damage. Apply only the tension required to unseat or seat the cables during removal and insertion. Handle cables by the connector whenever possible. In all cases, avoid bending, twisting, or tearing cables. Be sure that cables are routed in such a way that they cannot be caught or snagged by parts being removed or replaced. Handle flex cables with extreme care; these cables tear easily.

Drive handling

-
- △ **CAUTION:** Drives are fragile components that must be handled with care. To prevent damage to the computer, damage to a drive, or loss of information, observe these precautions:
-

Before removing or inserting a hard drive, shut down the computer. If you are unsure whether the computer is off or in Hibernation, turn the computer on, and then shut it down through the operating system.

Before handling a drive, be sure that you are discharged of static electricity. While handling a drive, avoid touching the connector.

Before removing a diskette drive or optical drive, be sure that a diskette or disc is not in the drive and be sure that the optical drive tray is closed.

Handle drives on surfaces covered with at least 2.5 cm (one inch) of shock-proof foam.

Avoid dropping drives from any height onto any surface.

After removing a hard drive, an optical drive, or a diskette drive, place it in a static-proof bag.

Avoid exposing a hard drive to products that have magnetic fields, such as monitors or speakers.

Avoid exposing a drive to temperature extremes or liquids.

If a drive must be mailed, place the drive in a bubble pack mailer or other suitable form of protective packaging and label the package "FRAGILE."

Grounding guidelines

Electrostatic discharge damage

Electronic components are sensitive to electrostatic discharge (ESD). Circuitry design and structure determine the degree of sensitivity. Networks built into many integrated circuits provide some protection, but in many cases, ESD contains enough power to alter device parameters or melt silicon junctions.

A discharge of static electricity from a finger or other conductor can destroy static-sensitive devices or microcircuitry. Even if the spark is neither felt nor heard, damage may have occurred.

An electronic device exposed to ESD may not be affected at all and can work perfectly throughout a normal cycle. Or the device may function normally for a while, and then degrade in the internal layers, reducing its life expectancy.

△ **CAUTION:** To prevent damage to the computer when you are removing or installing internal components, observe these precautions:

Keep components in their electrostatic-safe containers until you are ready to install them.

Use nonmagnetic tools.

Before touching an electronic component, discharge static electricity by using the guidelines described in this section.

Avoid touching pins, leads, and circuitry. Handle electronic components as little as possible.

If you remove a component, place it in an electrostatic-safe container.

The following table shows how humidity affects the electrostatic voltage levels generated by different activities.

△ **CAUTION:** A product can be degraded by as little as 700 V.

Typical electrostatic voltage levels			
Event	Relative humidity		
	10%	40%	55%
Walking across carpet	35,000 V	15,000 V	7,500 V
Walking across vinyl floor	12,000 V	5,000 V	3,000 V
Motions of bench worker	6,000 V	800 V	400 V
Removing DIPS from plastic tube	2,000 V	700 V	400 V
Removing DIPS from vinyl tray	11,500 V	4,000 V	2,000 V
Removing DIPS from Styrofoam	14,500 V	5,000 V	3,500 V
Removing bubble pack from PCB	26,500 V	20,000 V	7,000 V
Packing PCBs in foam-lined box	21,000 V	11,000 V	5,000 V

Packaging and transporting guidelines

Follow these grounding guidelines when packaging and transporting equipment:

- To avoid hand contact, transport products in static-safe tubes, bags, or boxes.
- Protect ESD-sensitive parts and assemblies with conductive or approved containers or packaging.
- Keep ESD-sensitive parts in their containers until the parts arrive at static-free workstations.
- Place items on a grounded surface before removing items from their containers.
- Always be properly grounded when touching a component or assembly.
- Store reusable ESD-sensitive parts from assemblies in protective packaging or nonconductive foam.
- Use transporters and conveyors made of antistatic belts and roller bushings. Be sure that mechanized equipment used for moving materials is wired to ground and that proper materials are selected to avoid static charging. When grounding is not possible, use an ionizer to dissipate electric charges.

Workstation guidelines

Follow these grounding workstation guidelines:

- Cover the workstation with approved static-shielding material.
- Use a wrist strap connected to a properly grounded work surface and use properly grounded tools and equipment.
- Use conductive field service tools, such as cutters, screwdrivers, and vacuums.
- When fixtures must directly contact dissipative surfaces, use fixtures made only of static-safe materials.
- Keep the work area free of nonconductive materials, such as ordinary plastic assembly aids and Styrofoam.
- Handle ESD-sensitive components, parts, and assemblies by the case or PCM laminate. Handle these items only at static-free workstations.
- Avoid contact with pins, leads, or circuitry.
- Turn off power and input signals before inserting or removing connectors or test equipment.

Equipment guidelines

Grounding equipment must include either a wrist strap or a foot strap at a grounded workstation.

- When seated, wear a wrist strap connected to a grounded system. Wrist straps are flexible straps with a minimum of one megohm $\pm 10\%$ resistance in the ground cords. To provide proper ground, wear a strap snugly against the skin at all times. On grounded mats with banana-plug connectors, use alligator clips to connect a wrist strap.
- When standing, use foot straps and a grounded floor mat. Foot straps (heel, toe, or boot straps) can be used at standing workstations and are compatible with most types of shoes or boots. On conductive floors or dissipative floor mats, use foot straps on both feet with a minimum of one megohm resistance between the operator and ground. To be effective, the conductive strips must be worn in contact with the skin.

The following grounding equipment is recommended to prevent electrostatic damage:

- Antistatic tape
- Antistatic smocks, aprons, and sleeve protectors
- Conductive bins and other assembly or soldering aids
- Nonconductive foam
- Conductive tabletop workstations with ground cords of one megohm resistance
- Static-dissipative tables or floor mats with hard ties to the ground
- Field service kits
- Static awareness labels
- Material-handling packages
- Nonconductive plastic bags, tubes, or boxes
- Metal tote boxes
- Electrostatic voltage levels and protective materials

The following table lists the shielding protection provided by antistatic bags and floor mats.

Material	Use	Voltage protection level
Antistatic plastic	Bags	1,500 V
Carbon-loaded plastic	Floor mats	7,500 V
Metallized laminate	Floor mats	5,000 V

Component replacement procedures

This chapter provides removal and replacement procedures.

There are as many as 95 screws and screw locks, in 15 different sizes, that must be removed, replaced, or loosened when servicing the computer. Make special note of each screw and screw lock size and location during removal and replacement.

Service tag

When ordering parts or requesting information, provide the computer serial number and model description provided on the service tag.



- Product name **(1)**. This is the product name affixed to the front of the computer.
- Serial number (s/n) **(2)**. This is an alphanumeric identifier that is unique to each product.
- Part number/Product number (p/n) **(3)**. This number provides specific information about the product's hardware components. The part number helps a service technician to determine what components and parts are needed.
- Warranty period **(4)**. This number describes the duration (in years) of the warranty period for the computer.
- Model description **(5)**. This is the alphanumeric identifier used to locate documents, drivers, and support for the computer.

Computer feet

The computer feet are adhesive-backed rubber pads. The feet are included in the Rubber Kit, spare part number 595785-001. There are 6 rubber feet that attach to the base enclosure in the locations illustrated below.

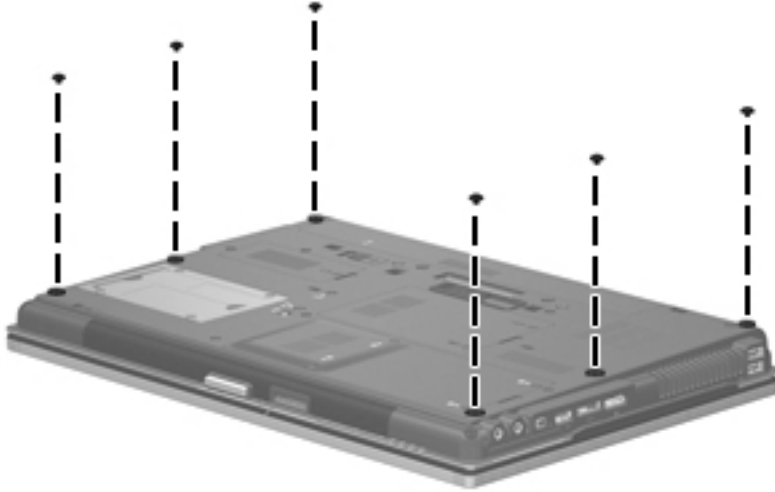

Battery

Description	Spare part number
8-cell, 73-Wh Li-ion battery	493976-001
8-cell, 68-Wh Li-ion battery	592078-001

Before disassembling the computer, follow these steps:

1. Shut down the computer. If you are unsure whether the computer is off or in Hibernation, turn the computer on, and then shut it down through the operating system.
2. Disconnect all external devices connected to the computer.
3. Disconnect the power from the computer by first unplugging the power cord from the AC outlet, and then unplugging the AC adapter from the computer.

Remove the battery:

1. Turn the computer upside-down on a flat surface, with the battery bay toward you.
2. Slide the battery release latch **(1)** to release the battery.
3. Remove the battery **(2)** from the computer.

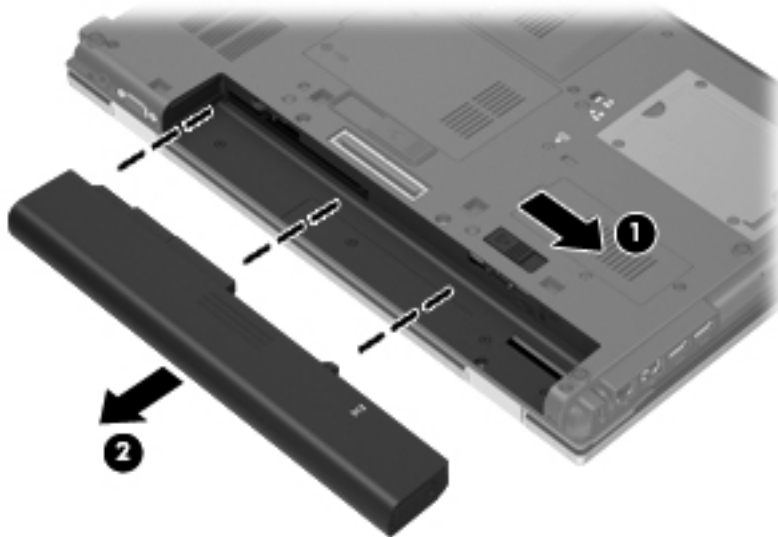

Install the battery by inserting it into the battery bay until you hear a click.

SIM

 **NOTE:** This section applies only to computer models with WWAN capability.

NOTE: If there is a SIM inserted in the SIM slot, it must be removed before disassembling the computer. Be sure that the SIM is reinserted in the SIM slot after reassembling the computer.

Before removing the SIM, follow these steps:

1. Shut down the computer. If you are unsure whether the computer is off or in Hibernation, turn the computer on, and then shut it down through the operating system.
2. Disconnect all external devices connected to the computer.
3. Disconnect the power from the computer by first unplugging the power cord from the AC outlet, and then unplugging the AC adapter from the computer.
4. Remove the battery (see [Battery on page 47](#)).

Remove the SIM:

1. Press in on the SIM **(1)**. (The module is partially ejected from the SIM slot.)
2. Remove the SIM **(2)** from the SIM slot.

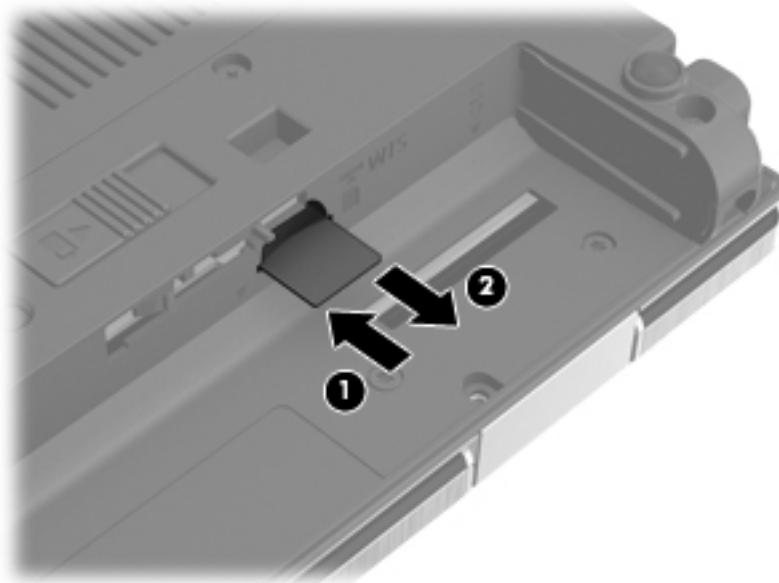

Reverse this procedure to install the SIM.

Optical drive

 **NOTE:** All optical drive spare part kits include an optical drive bezel.

Description	Spare part number
DVD±RW and CD-RW SuperMulti DL Combo Drive with LightScribe	595759-001
Blu-ray Disc ROM with SuperMulti DVD±R/RW DL Drive	595760-001
DVD-ROM Drive	595758-001
Blu-ray ROM DVD±RW SuperMulti DL Drive	595761-001

Before removing the optical drive, follow these steps:

1. Shut down the computer. If you are unsure whether the computer is off or in Hibernation, turn the computer on, and then shut it down through the operating system.
2. Disconnect all external devices connected to the computer.
3. Disconnect the power from the computer by first unplugging the power cord from the AC outlet, and then unplugging the AC adapter from the computer.
4. Remove the battery (see [Battery on page 47](#)).

Remove the optical drive:

1. Position the computer with the right side toward you.
2. Remove the Phillips PM2.5×12.0 captive screw (1) that secures the optical drive to the computer.
3. Push the optical drive tab (2) to release the optical drive from the computer.
4. Remove the optical drive (3) from the computer.

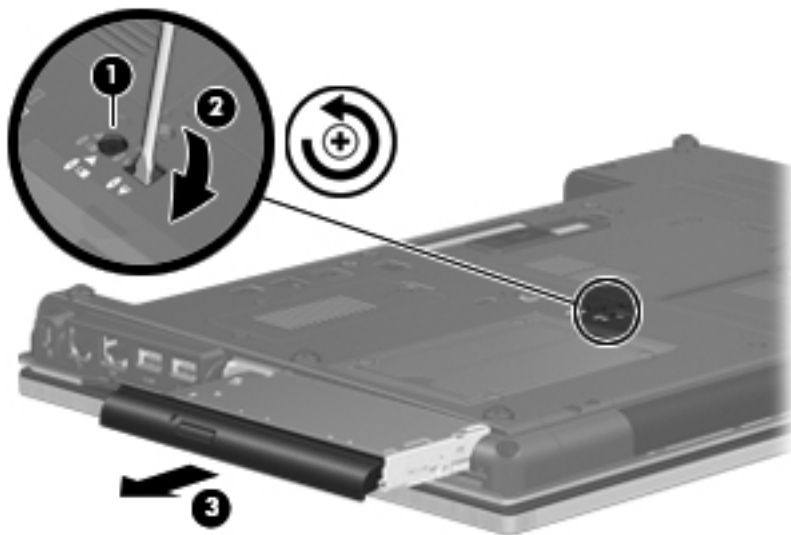

5. If it is necessary to replace the optical drive bracket, position the optical drive with the rear toward you.

6. Remove the two Phillips PM2.0×3.0 screws **(1)** that secure the optical drive bracket to the optical drive.
7. Remove the optical drive bracket **(2)**.



Reverse this procedure to install an optical drive.

Upgrade bay

Description	Spare part number
500-GB, 7200-rpm hard drive	595762-001

Before removing a drive from the upgrade bay, follow these steps:

1. Shut down the computer. If you are unsure whether the computer is off or in Hibernation, turn the computer on, and then shut it down through the operating system.
2. Disconnect all external devices connected to the computer.
3. Disconnect the power from the computer by first unplugging the power cord from the AC outlet, and then unplugging the AC adapter from the computer.
4. Remove the battery (see [Battery on page 47](#)).

Remove the drive from the upgrade bay:

1. Position the computer upside down, with the front toward you.
2. Remove the four screw covers **(1)** and four Phillips PM2.0×4.0 screws **(2)** that secure the hard drive assembly into the upgrade bay.
3. Loosen the captive Phillips PM2.5×12.0 screw that secures the drive in the bay **(3)**.
4. Push the optical drive tab **(4)** to release the drive from the computer.

5. Remove the optical drive (5) from the computer.

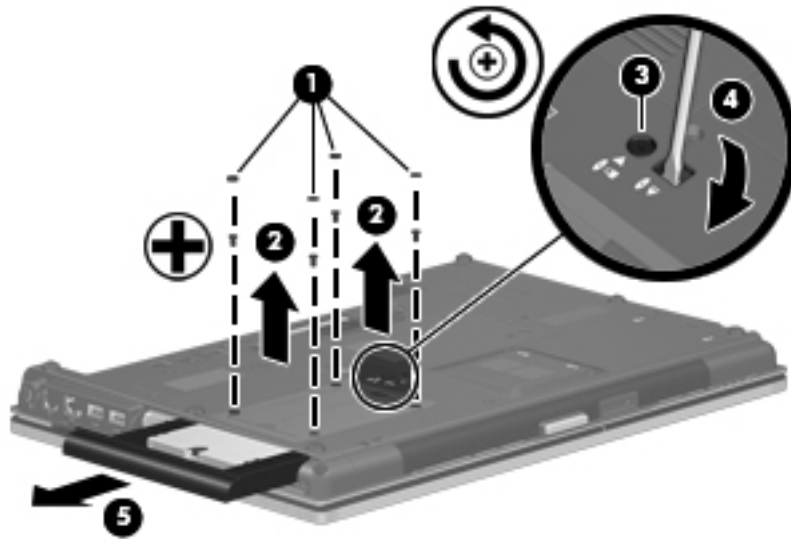

6. Remove the assembly from the base enclosure.

Reverse this procedure to install the hard drive into the upgrade bay.

Ambient light sensor

 **NOTE:** If it has been determined that the ambient light sensor is the component that must be replaced to complete the computer repair, the display assembly does not have to be removed. Follow the procedures in this section to replace the ambient light sensor. For information on replacing the display assembly and the display hinges, see [Display assembly on page 81](#).

Description	Spare part number
Ambient light sensor board (includes cable)	595781-001

Before removing the ambient light sensor, follow these steps:

1. Shut down the computer. If you are unsure whether the computer is off or in Hibernation, turn the computer on, and then shut it down through the operating system.
2. Disconnect all external devices connected to the computer.
3. Disconnect the power from the computer by first unplugging the power cord from the AC outlet, and then unplugging the AC adapter from the computer.
4. Remove the battery (see [Battery on page 47](#)).

Remove the ambient light sensor:

1. Turn the computer right-side up, with the front toward you.
2. Open the computer as far as possible.
3. Remove the two rubber screw covers (1) on the bottom edge of the display bezel.
4. Remove the two Phillips PM2.5×5.0 screws (2) that secure the display bezel bottom edge to the display assembly.

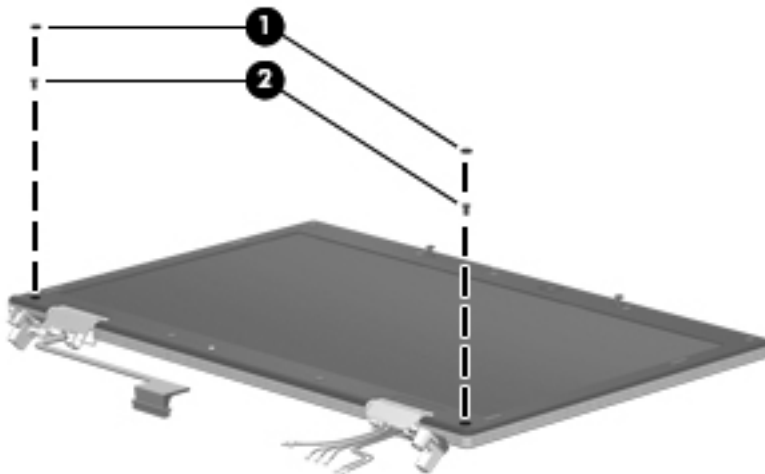

5. Flex the inside edges of the left and right sides (1) and the display bezel bottom edge (2) until the bezel disengages from the display assembly.

6. Release the display bezel bottom edge (3) from the display assembly.

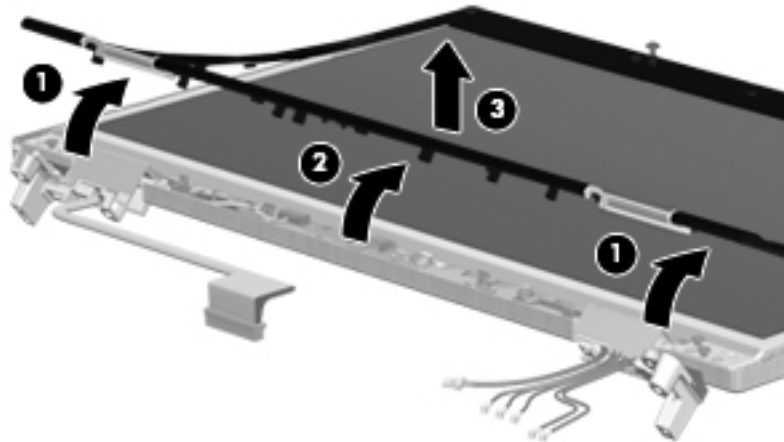

7. Remove the Phillips PM2.0x4.0 screw (1) that secures the ambient light sensor to the display enclosure.
8. Release the sensor (2) from the display enclosure as far as the display panel cable and backlight cable allow.
9. Disconnect the backlight cable (3), the display panel cable (4), and the keyboard light cable (5) from the ambient light sensor.

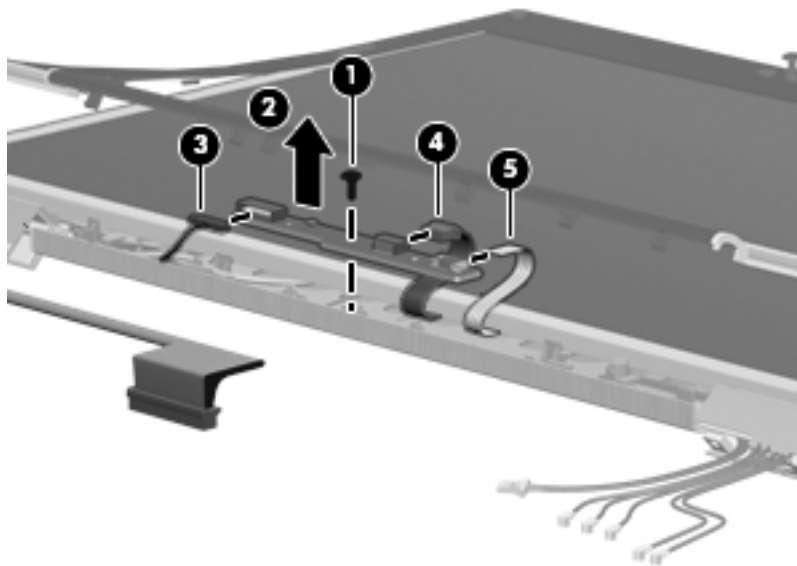

10. Remove the ambient light sensor.

Reverse this procedure to install the ambient light sensor.

Hard drive

 **NOTE:** All hard drive spare part kits include a hard drive bracket and screws.

Description	Spare part number
500-GB, 7200-rpm hard drive	595755-001
320-GB, 7200-rpm hard drive	595754-001
250-GB, 7200-rpm hard drive	595753-001
256-GB solid-state drive (SSD)	595756-001
160-GB solid-state drive (SSD)	595757-001

Before disassembling the computer, follow these steps:

1. Shut down the computer. If you are unsure whether the computer is off or in Hibernation, turn the computer on, and then shut it down through the operating system.
2. Disconnect all external devices connected to the computer.
3. Disconnect the power from the computer by first unplugging the power cord from the AC outlet, and then unplugging the AC adapter from the computer.
4. Remove the battery (see [Battery on page 47](#)).

Remove the hard drive:

1. Position the computer upside-down, with the front toward you.
2. Loosen the four Phillips PM2.0×7.0 captive screws **(1)** that secure the hard drive cover to the computer.

3. Lift the right side of the hard drive cover, swing it to the left (2), and remove the cover. The hard drive cover is included in the Plastics Kit, spare part number 595784-001

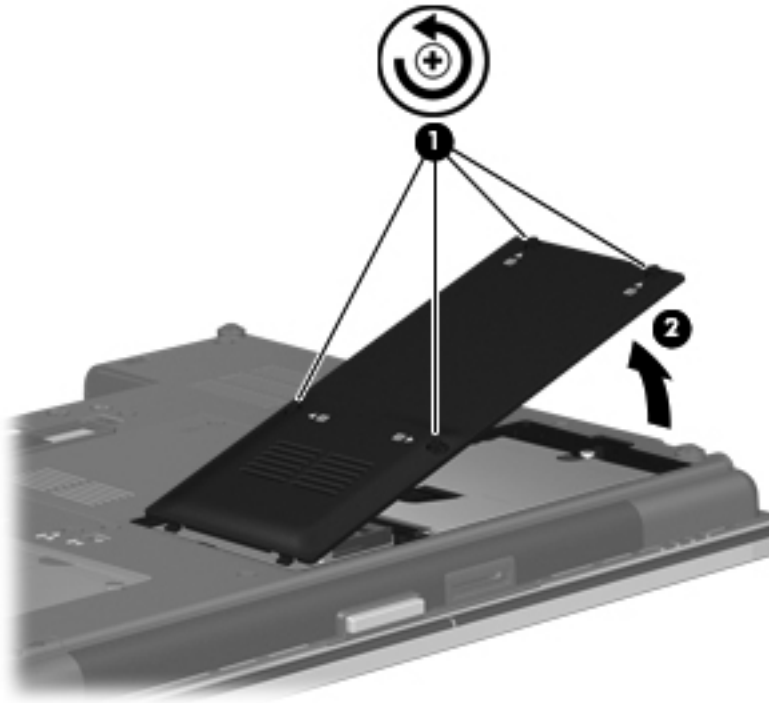

4. Loosen the Phillips PM2.5×12.0 captive screw (1) that secures the hard drive to the computer.
5. Grasp the Mylar tab on the hard drive and slide the hard drive to the right (2) to disconnect it from the system board.

6. Remove the hard drive (3) from the hard drive bay.

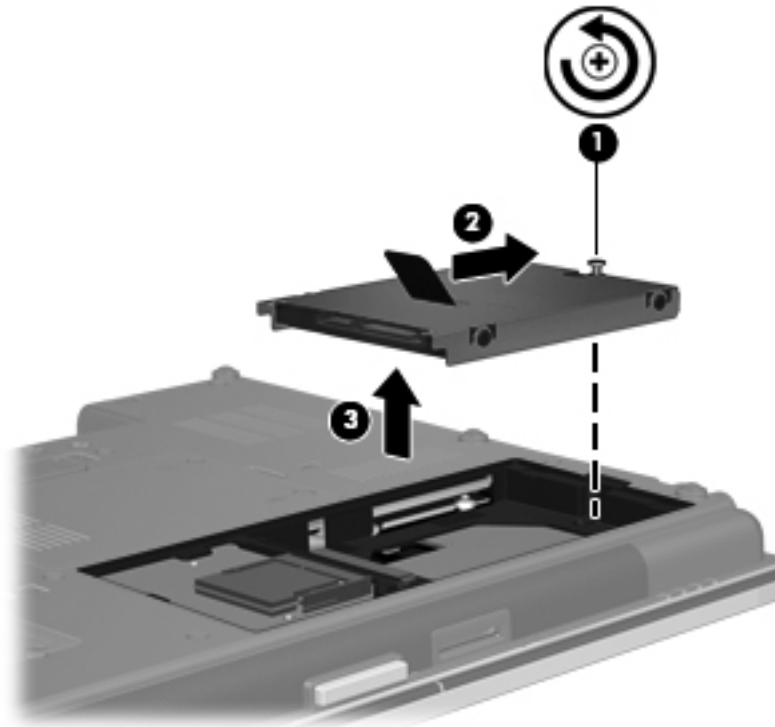

7. If it is necessary to replace the hard drive bracket, remove the four Phillips PM3.0×5.0 hard drive bracket screws (1) from each side of the hard drive.
8. Lift the bracket (2) straight up to remove it from the hard drive.

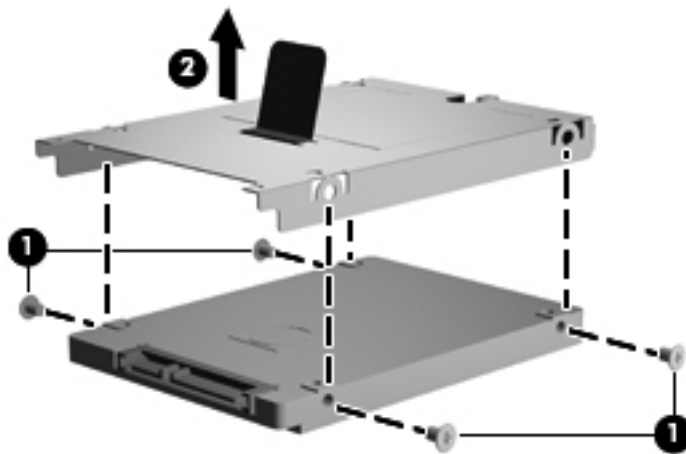

Reverse this procedure to reassemble and install the hard drive.

Bluetooth module

 **NOTE:** The Bluetooth module spare part kit does not include a Bluetooth module cable. The Bluetooth module cable is included in the Cable Kit, spare part number 595787-001. See [Cable Kit on page 30](#) for more Cable Kit spare part number information.

Description	Spare part number
Bluetooth module	537921-001

Before removing the Bluetooth module, follow these steps:

1. Shut down the computer. If you are unsure whether the computer is off or in Hibernation, turn the computer on, and then shut it down through the operating system.
2. Disconnect all external devices connected to the computer.
3. Disconnect the power from the computer by first unplugging the power cord from the AC outlet, and then unplugging the AC adapter from the computer.
4. Remove the battery (see [Battery on page 47](#)).

Remove the Bluetooth module:

1. Position the computer upside-down, with the front toward you.
2. Remove the Bluetooth cover by loosening the Phillips PM2.5×6.0 captive screw (1), and then lifting the cover straight up (2) and off the computer.
3. Remove the Bluetooth module by lifting it straight up and out of the compartment (3) as far as the cable allows.
4. Disconnect the Bluetooth module cable (4) from the Bluetooth module.

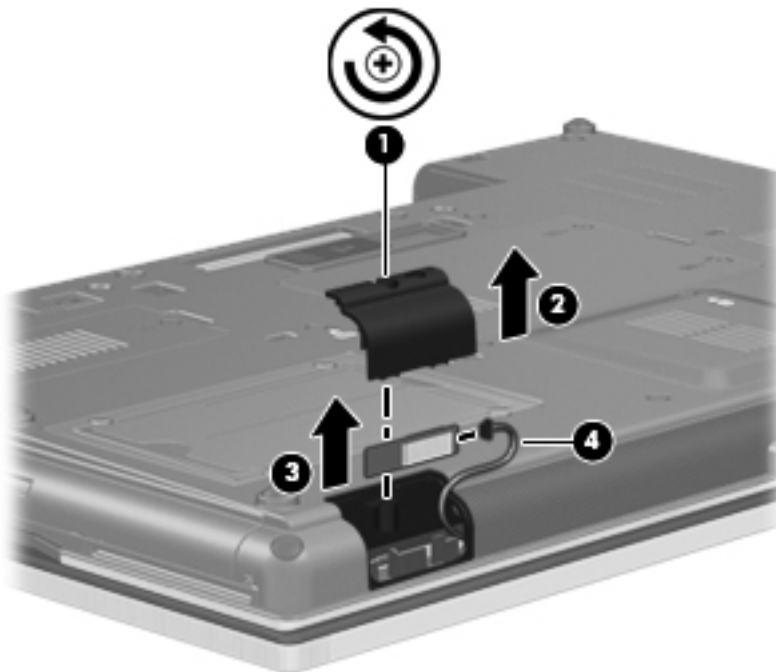

Reverse this procedure to install the Bluetooth module.

RTC battery

Description	Spare part number
RTC battery	581075-001

Before removing the RTC battery, follow these steps:

1. Shut down the computer. If you are unsure whether the computer is off or in Hibernation, turn the computer on, and then shut it down through the operating system.
2. Disconnect all external devices connected to the computer.
3. Disconnect the power from the computer by first unplugging the power cord from the AC outlet, and then unplugging the AC adapter from the computer.
4. Remove the battery (see [Battery on page 47](#)).

Remove the RTC battery:

1. Position the computer upside-down, with the front toward you.
2. Loosen the two Phillips PM2.0×5.0 captive screws (1) that secure the memory module compartment cover to the computer.
3. Lift the right side of the cover (2), swing it up and to the left, and remove the cover. The memory module compartment cover is included in the Plastics Kit, spare part number 595784-001.

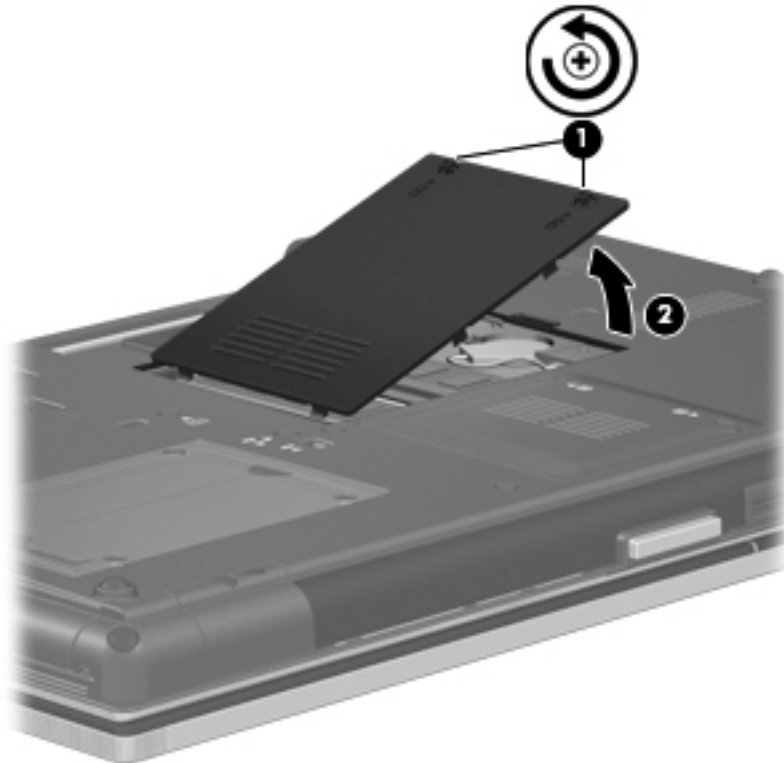

4. Disconnect the RTC battery cable (1) from the system board.
5. Gently pull the battery away from the double-sided tape that secures it to the system board and remove it from the computer (2).

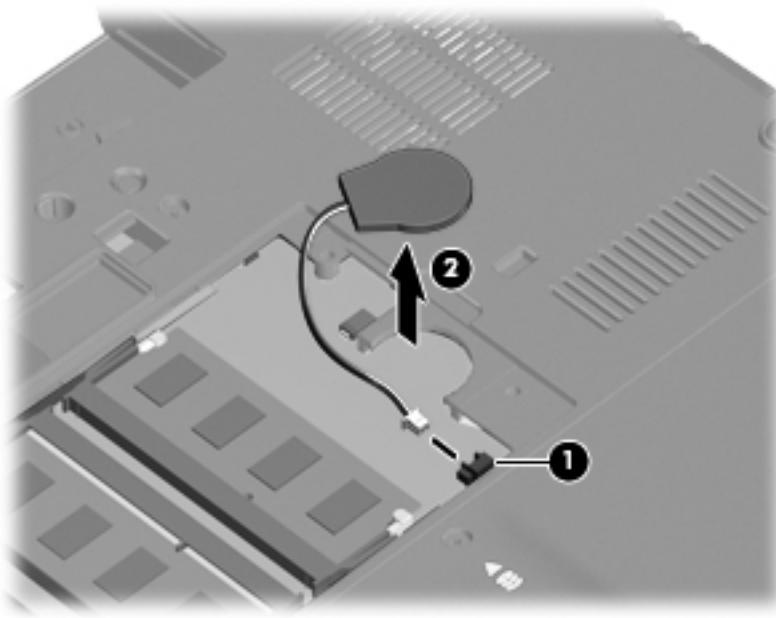

Reverse this procedure to install the RTC battery.

Expansion memory modules

 **NOTE:** Expansion memory is installed in a compartment on the bottom of the computer.

Computers that use the system board with spare part number 595764-001 have two memory slots.

Computers that use the system board with spare part number 595765-001 have four memory slots. On these computers, in both the expansion memory slots (on the bottom of the computer) and the primary memory slots (under the keyboard), slot 2 cannot be populated if slot 1 is not populated.

Description	Spare part number
2-GB (PC3-10600, 1333-MHz, DDR3)	598856-001
4-GB (PC3-10600, 1333-MHz, DDR3)	599092-001

Before removing the memory module, follow these steps:

1. Shut down the computer. If you are unsure whether the computer is off or in Hibernation, turn the computer on, and then shut it down through the operating system.
2. Disconnect all external devices connected to the computer.
3. Disconnect the power from the computer by first unplugging the power cord from the AC outlet, and then unplugging the AC adapter from the computer.
4. Remove the battery (see [Battery on page 47](#)).

Remove the expansion memory module:

1. Position the computer upside-down, with the front toward you.
2. Loosen the two Phillips PM2.0×5.0 captive screws **(1)** that secure the memory module compartment cover to the computer.

3. Lift the right side of the cover (2), swing it up and to the left, and remove the cover. The memory module compartment cover is included in the Plastics Kit, spare part number 595784-001.

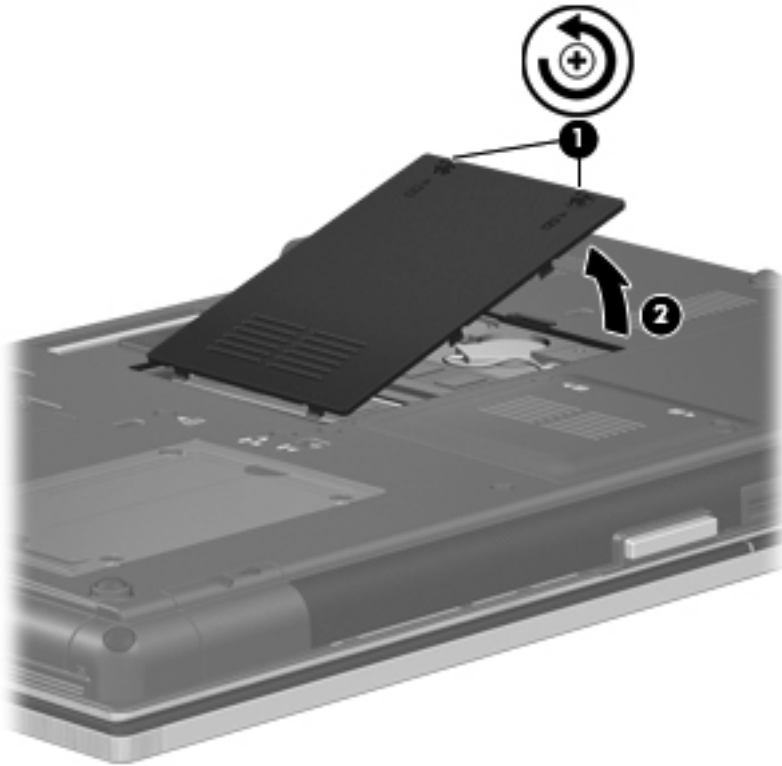

4. Spread the retaining tabs (1) on each side of the expansion memory module slot to release the memory module. (The edge of the module opposite the slot rises away from the computer.)
5. Remove the expansion memory module (2) by pulling the module away from the slot at an angle.

 **NOTE:** Memory modules are designed with a notch (3) to prevent incorrect insertion into the memory module slot.

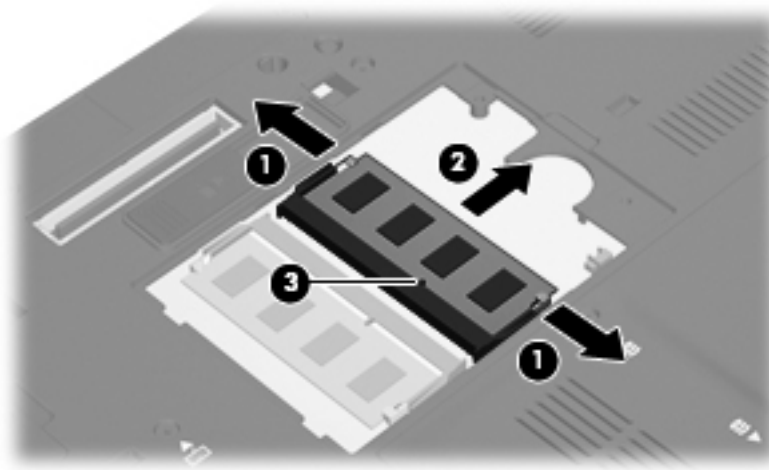

Reverse this procedure to install an expansion memory module.

WWAN module

△ **CAUTION:** The WWAN module and the WLAN module are not interchangeable.

📄 **NOTE:** Ericsson modules are only available in EMEA on certain computers.

Description	Spare part number
HP un2420 Broadband Module (WWAN)	531993-001

Before removing the WWAN module, follow these steps:

1. Shut down the computer. If you are unsure whether the computer is off or in Hibernation, turn the computer on, and then shut it down through the operating system.
2. Disconnect all external devices connected to the computer.
3. Disconnect the power from the computer by first unplugging the power cord from the AC outlet, and then unplugging the AC adapter from the computer.
4. Remove the battery (see [Battery on page 47](#)).
5. Remove the SIM (see [SIM on page 48](#)).

Remove the WWAN module:

1. Loosen the captive Phillips PM2.0×5.0 captive screw **(1)** that secures the WWAN cover to the computer.
2. Lift the right side of the cover **(2)**, swing it up and to the left, and remove the cover. The WWAN cover is included in the Plastics Kit, spare part number 595784-001.

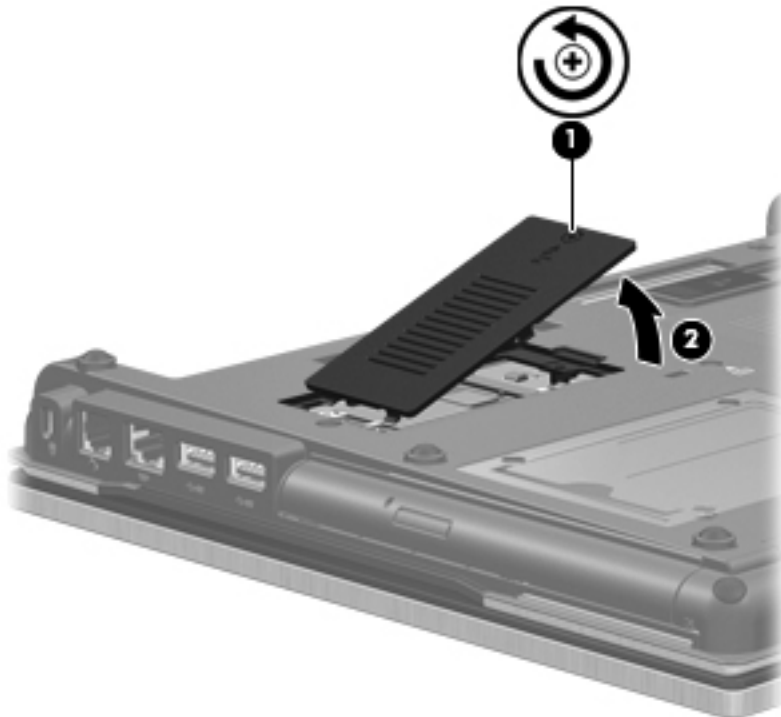

3. Disconnect the WWAN antenna cables **(1)** from the terminals on the WWAN module.

 **NOTE:** The red WWAN antenna cable is connected to the WWAN module “Main” terminal. The blue WWAN antenna cable is connected to the WWAN module “Aux” terminal.

There are two different WWAN modules available, and each module has the antenna connectors reversed.

4. Remove the two Phillips PM2.5×3.0 screws **(2)** that secure the WWAN module to the computer. (The edge of the module opposite the slot rises away from the computer.)

5. Remove the WWAN module (3) by pulling the module away from the slot at an angle.

 **NOTE:** WWAN modules are designed with a notch (4) to prevent incorrect insertion.

Figure 4-1 Ericsson module antenna locations

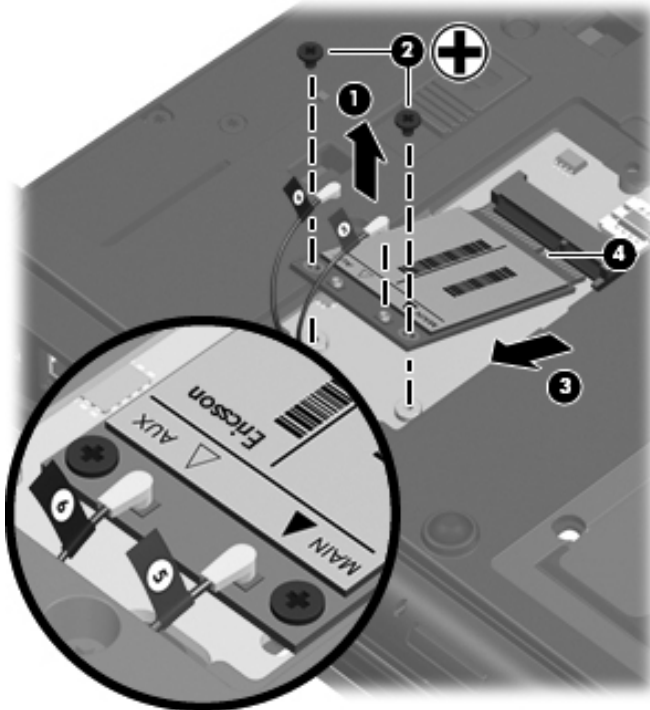
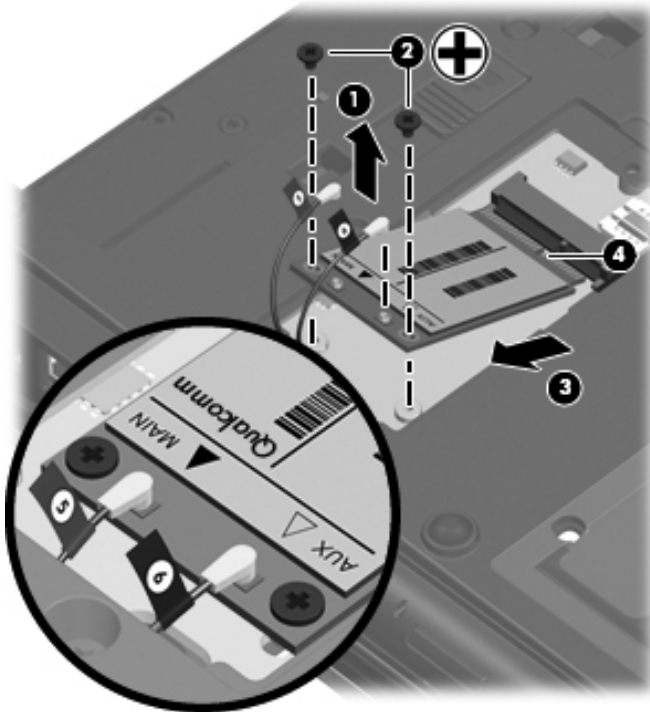

Figure 4-2 Qualcomm module antenna locations



Reverse this procedure to install the WWAN module.

Keyboard

For use in:	Spare part number	For use in:	Spare part number
Keyboards with pointing stick (includes pointing stick cable):			
Belgium	595790-A41	Latin America	595790-161
Brazil	595790-201	The Netherlands and Europe	595790-B31
Bulgaria	595790-261	Norway	595790-091
Czech Republic and Slovakia	595790-A81	Portugal	595790-131
Denmark	595790-081	Russia	595790-251
France	595790-051	Saudi Arabia	595790-171
French Canada	595790-121	Slovenia	595790-BA1
Germany	595790-041	Spain	595790-071
Greece	595790-DJ1	Sweden and Finland	595790-B71
Hungary	595790-211	Switzerland	595790-BG1
Iceland	595790-DD1	Taiwan	595790-AB1
Israel	595790-BB1	Thailand	595790-281
Italy	595790-061	Turkey	595790-141
Japan	595790-291	The United Kingdom	595790-031
South Korea	595790-AD1	The United States	595790-001

Before removing the keyboard, follow these steps:

1. Shut down the computer. If you are unsure whether the computer is off or in Hibernation, turn the computer on, and then shut it down through the operating system.
2. Disconnect all external devices connected to the computer.
3. Disconnect the power from the computer by first unplugging the power cord from the AC outlet, and then unplugging the AC adapter from the computer.
4. Remove the battery (see [Battery on page 47](#)).

Remove the keyboard:

1. Turn the computer upside-down, with the rear toward you.

2. Loosen the three Phillips PM2.5×12.0 captive screws that secure the keyboard to the computer.

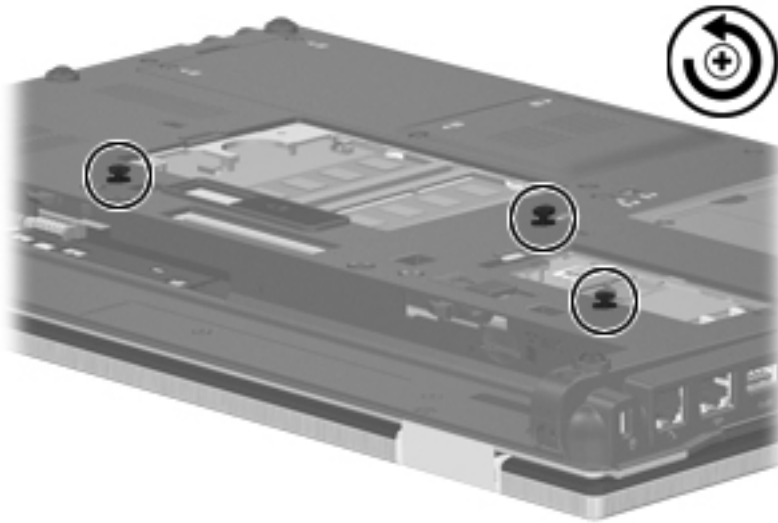

3. Turn the computer right-side up, with the front toward you.
4. Open the computer as far as possible.
5. Slide the four keyboard retention tabs (1) toward you. The tabs are located between the **esc** and **f1** keys, between the **f4** and **f5** keys, between the **f8** and **f9** keys, and between the **f12** and **scroll** keys.
6. Lift the rear edge of the keyboard, and then rotate the keyboard forward until it rests upside-down on top of the TouchPad (2).



7. Release the zero insertion force (ZIF) connector to which the keyboard cable is attached (1), and then disconnect the keyboard cable from the system board.

8. Release the ZIF connector to which the pointing stick cable (2) is attached, and then disconnect the pointing stick cable from the system board.

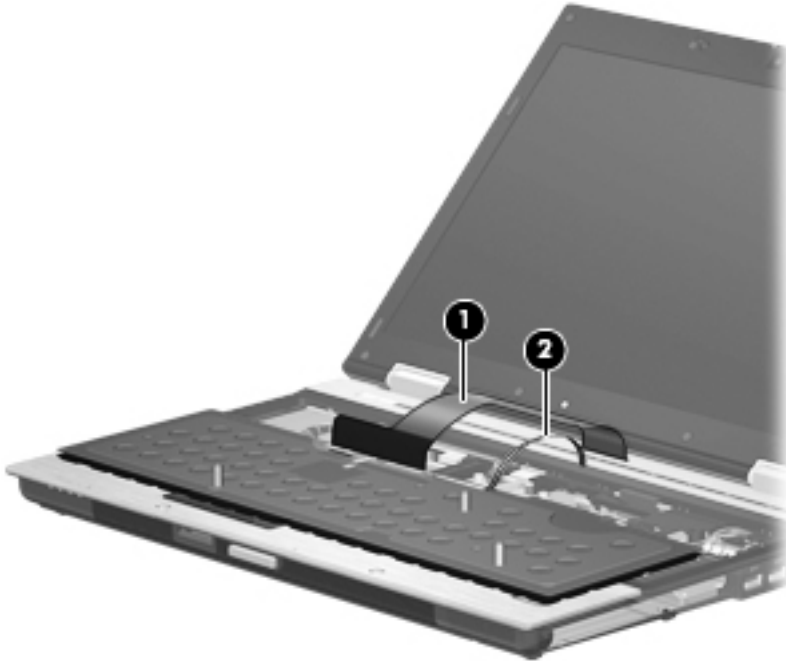

9. Remove the keyboard.

Reverse this procedure to install the keyboard.

Primary memory module

 **NOTE:** Primary memory is installed under the keyboard.

Computers that use the system board with spare part number 595764-001 have two memory slots.

Computers that use the system board with spare part number 595765-001 have four memory slots. On these computers, in both the expansion memory slots (on the bottom of the computer) and the primary memory slots (under the keyboard), slot 2 cannot be populated if slot 1 is not populated.

Description	Spare part number
2-GB (PC3-10600, 1333-MHz, DDR3)	598856-001
4-GB (PC3-10600, 1333-MHz, DDR3)	599092-001

Before removing the primary memory module, follow these steps:

1. Shut down the computer. If you are unsure whether the computer is off or in Hibernation, turn the computer on, and then shut it down through the operating system.
2. Disconnect all external devices connected to the computer.
3. Disconnect the power from the computer by first unplugging the power cord from the AC outlet, and then unplugging the AC adapter from the computer.
4. Remove the battery (see [Battery on page 47](#)).
5. Remove the following components:
 - a. Hard drive (see [Hard drive on page 54](#))
 - b. Keyboard (see [Keyboard on page 65](#))

Remove the primary memory module:

1. Spread the retaining tabs **(1)** on each side of the primary memory module slot to release the memory module. (The edge of the module opposite the slot rises away from the computer.)

- Remove the primary memory module (2) by pulling the module away from the slot at an angle.

 **NOTE:** Memory modules are designed with a notch (3) to prevent incorrect insertion into the memory module slot.

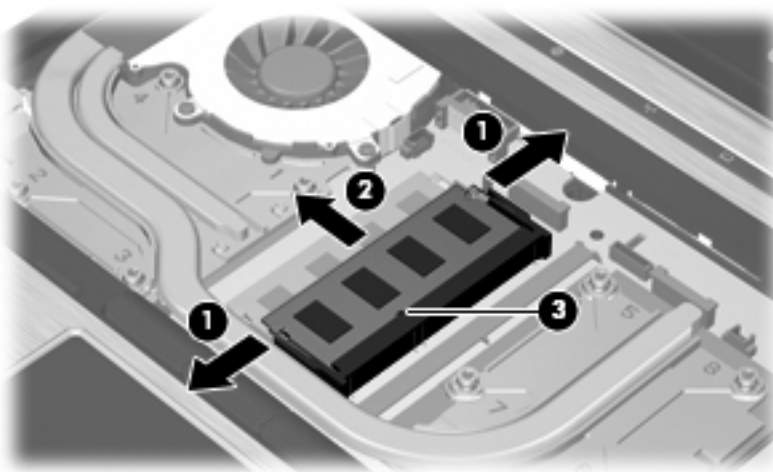

Reverse this procedure to install a primary memory module.

WLAN module

 **CAUTION:** The WLAN module and the WWAN module are not interchangeable.

Description	Spare part number
Intel Wi-Fi Link 6300, 802.11a/b/g/n WLAN module for use in Andorra, Antigua and Barbuda, Argentina, Aruba, Australia, Austria, Azerbaijan, Bahamas, Bahrain, Barbados, Belgium, Bermuda, Bolivia, Bosnia and Herzegovina, Brazil, Brunei, Bulgaria, Canada, Cayman Islands, Chile, the People's Republic of China, Colombia, Costa Rica, Croatia, Cyprus, Czech Republic, Denmark, Dominican Republic, Ecuador, Egypt, El Salvador, Estonia, Finland, France, French Guiana, Georgia, Germany, Ghana, Greece, Guadeloupe, Guam, Guatemala, Haiti, Honduras, Hong Kong, Hungary, Iceland, India, Indonesia, Ireland, Israel, Italy, Ivory Coast, Jamaica, Japan, Jordan, Kenya, South Korea, Kuwait, Kyrgyzstan, Latvia, Lebanon, Martinique, US Virgin Islands, Puerto Rico, Nether Antilles, Liechtenstein, Lithuania, Luxembourg, Malawi, Malaysia, Malta, Mauritius, Mexico, Monaco, Montenegro, Morocco, the Netherlands, New Zealand, Nicaragua, Nigeria, Norway, Oman, Pakistan, Panama, Paraguay, Peru, Philippines, Poland, Portugal, Qatar, Romania, San Marino, Saudi Arabia, Senegal, Singapore, Slovakia, Slovenia, South Africa, Spain, Sri Lanka, Sweden, Switzerland, Taiwan, Tanzania, Thailand, Trinidad and Tobago, Turkey, the United Arab Emirates, the United Kingdom, the United States, Uruguay, Venezuela, and Vietnam	572511-001
Intel Wi-Fi Link 6200, 802.11a/b/g/n WLAN module for use in Andorra, Antigua and Barbuda, Argentina, Aruba, Australia, Austria, Azerbaijan, Bahamas, Bahrain, Barbados, Belgium, Bermuda, Bolivia, Bosnia and Herzegovina, Brazil, Brunei, Bulgaria, Canada, Cayman Islands, Chile, the People's Republic of China, Colombia, Costa Rica, Croatia, Cyprus, Czech Republic, Denmark, Dominican Republic, Ecuador, Egypt, El Salvador, Estonia, Finland, France, French Guiana, Georgia, Germany, Ghana, Greece, Guadeloupe, Guam, Guatemala, Haiti, Honduras, Hong Kong, Hungary, Iceland, India, Indonesia, Ireland, Israel, Italy, Ivory Coast, Jamaica, Japan, Jordan, Kenya, Kuwait, Kyrgyzstan, Latvia, Lebanon, Martinique, Liechtenstein, Lithuania, Luxembourg, Malawi, Malaysia, Malta, Mauritius, Mexico, Monaco, Montenegro, Morocco, the Nether Antilles, the Netherlands, New Zealand, Nicaragua, Nigeria, Norway, Oman, Pakistan, Panama, Paraguay, Peru, Philippines, Poland, Portugal, Puerto Rico, Qatar, Romania, San Marino, Saudi Arabia, Senegal, Singapore, Slovakia, Slovenia, South Africa, South Korea, Spain, Sri Lanka, Sweden, Switzerland, Taiwan, Tanzania, Thailand, Trinidad and Tobago, Tunisia, Turkey, the United Arab Emirates, the United Kingdom, the United States, Uruguay, the U.S. Virgin Islands, Venezuela, and Vietnam	572509-001

Description	Spare part number
Intel Wi-Fi Link 6100, 802.11a/b/g WLAN module for use in Russia and Ukraine	572510-001
Broadcom 4322 AGN 802.11a/b/g/n WLAN module for use in Antigua and Barbuda, Barbados, Belize, Canada, the Cayman Islands, Guam, Puerto Rico, Trinidad and Tobago, the U.S. Virgin Islands, and the United States	518434-001
Broadcom 4322 AGN 802.11a/b/g/n WLAN module for use in Afghanistan, Albania, Algeria, Andorra, Angola, Antigua and Barbuda, Argentina, Armenia, Aruba, Australia, Austria, Azerbaijan, the Bahamas, Bahrain, Bangladesh, Barbados, Belarus, Belgium, Belize, Benin, Bermuda, Bhutan, Bolivia, Bosnia and Herzegovina, Botswana, Brazil, the British Virgin Islands, Brunei, Bulgaria, Burkina Faso, Burundi, Cameroon, Cape Verde, the Central African Republic, Chad, Chile, the People's Republic of China, Colombia, Comoros, the Congo, Costa Rica, Croatia, Cyprus, the Czech Republic, Denmark, Djibouti, Dominica, the Dominican Republic, East Timor, Ecuador, Egypt, El Salvador, Equatorial Guinea, Eritrea, Estonia, Ethiopia, Fiji, Finland, France, French Guiana, Gabon, Gambia, Georgia, Germany, Ghana, Gibraltar, Greece, Grenada, Guadeloupe, Guatemala, Guinea, Guinea-Bissau, Guyana, Haiti, Honduras, Hong Kong, Hungary, Iceland, India, Ireland, Israel, Italy, the Ivory Coast, Jamaica, Jordan, Kazakhstan, Kenya, Kiribati, Kyrgyzstan, Laos, Latvia, Lebanon, Lesotho, Liberia, Liechtenstein, Lithuania, Luxembourg, Macedonia, Madagascar, Malawi, Malaysia, the Maldives, Mali, Malta, the Marshall Islands, Martinique, Mauritania, Mauritius, Mexico, Micronesia, Monaco, Mongolia, Montenegro, Morocco, Mozambique, Namibia, Nauru, Nepal, the Nether Antilles, the Netherlands, New Zealand, Nicaragua, Niger, Nigeria, Norway, Oman, Pakistan, Palau, Panama, Papua New Guinea, Paraguay, Peru, the Philippines, Poland, Portugal, the Republic of Moldova, Romania, Russia, Rwanda, Samoa, San Marino, Sao Tome and Principe, Saudi Arabia, Senegal, Serbia, the Seychelles, Sierra Leone, Singapore, Slovakia, Slovenia, the Solomon Islands, Somalia, South Africa, South Korea, Spain, Sri Lanka, St. Kitts and Nevis, St. Lucia, St. Vincent and the Grenadines, Suriname, Swaziland, Sweden, Switzerland, Taiwan, Tajikistan, Tanzania, Togo, Tonga, Trinidad and Tobago, Tunisia, Turkey, Turkmenistan, Tuvalu, Uganda, Ukraine, the United Arab Emirates, the United Kingdom, Uruguay, Uzbekistan, Vanuatu, Venezuela, Vietnam, Yemen, Zaire, Zambia, and Zimbabwe	518434-002

Before removing the WLAN module, follow these steps:

1. Shut down the computer. If you are unsure whether the computer is off or in Hibernation, turn the computer on, and then shut it down through the operating system.
2. Disconnect all external devices connected to the computer.
3. Disconnect the power from the computer by first unplugging the power cord from the AC outlet, and then unplugging the AC adapter from the computer.
4. Remove the battery (see [Battery on page 47](#)).
5. Remove the keyboard (see [Keyboard on page 65](#)).

Remove the WLAN module:

1. Turn the computer right-side up, with the front toward you.
2. Disconnect the WLAN antenna cables **(1)** from the terminals on the WLAN module.



NOTE: The black WLAN antenna cable is connected to the WLAN module “Main” terminal. The white WLAN antenna cable is connected to the WLAN module “Aux” terminal. If the computer is equipped with an 802.11a/b/g/n WLAN module, the yellow WLAN antenna cable is connected to the middle terminal on the WLAN module.

3. Remove the two Phillips PM2.0×3.0 barrel screws **(2)** that secure the WLAN module to the computer. (The edge of the module opposite the slot rises away from the computer.)

4. Remove the WLAN module (3) by pulling the module away from the slot at an angle.

 **NOTE:** WLAN modules are designed with a notch (4) to prevent incorrect insertion.

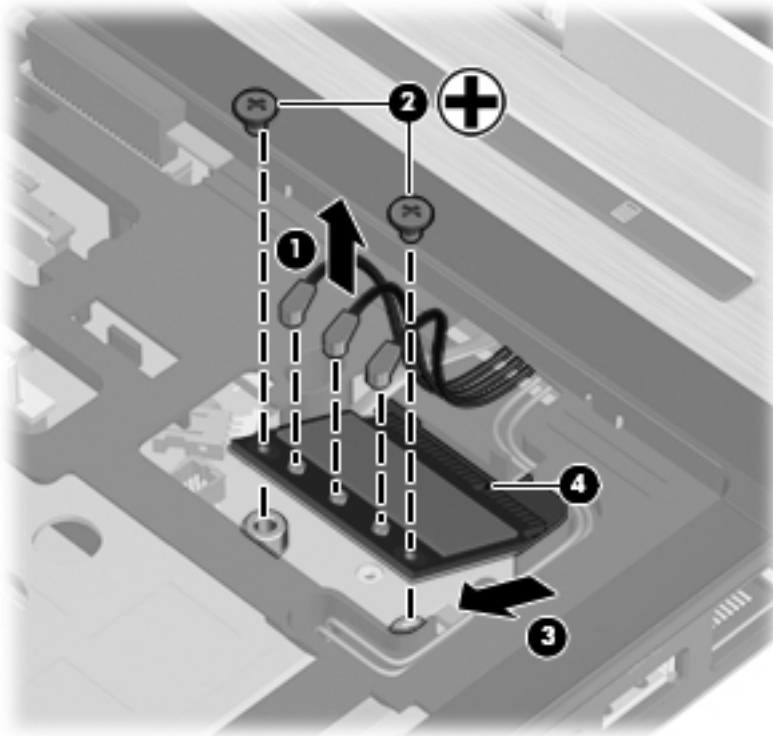

Reverse this procedure to install the WLAN module.

Switch cover

Description	Spare part number
Switch cover for use in model 8540p (includes LED board and cable)	595770-001
Switch cover for use in model 8540w (includes LED board and cable)	595771-001

Before removing the switch cover, follow these steps:

1. Shut down the computer. If you are unsure whether the computer is off or in Hibernation, turn the computer on, and then shut it down through the operating system.
2. Disconnect all external devices connected to the computer.
3. Disconnect the power from the computer by first unplugging the power cord from the AC outlet, and then unplugging the AC adapter from the computer.
4. Remove the battery (see [Battery on page 47](#)).
5. Remove the keyboard (see [Keyboard on page 65](#)).

Remove the switch cover:

1. Turn the computer upside-down, with the rear toward you.

2. Remove the three Phillips PM2.0×3.0 screws that secure the switch cover to the computer.

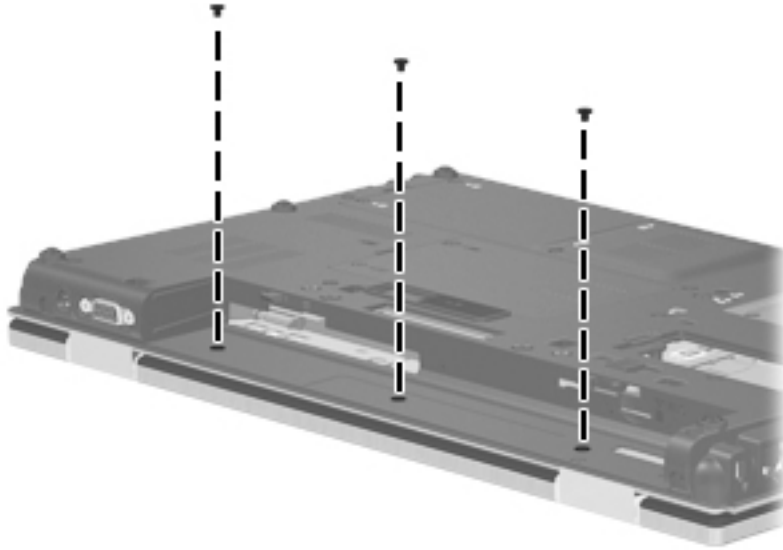

3. Turn the computer right-side up, with the front toward you.
4. Open the computer as far as possible.
5. Disconnect the LED board cable (1) from the ZIF connector on the system board.
6. Release the switch cover by lifting the left and right inside edges of the switch cover (2) until it disengages from the computer, and then rotating it forward.
7. Remove the switch cover from the computer (3).

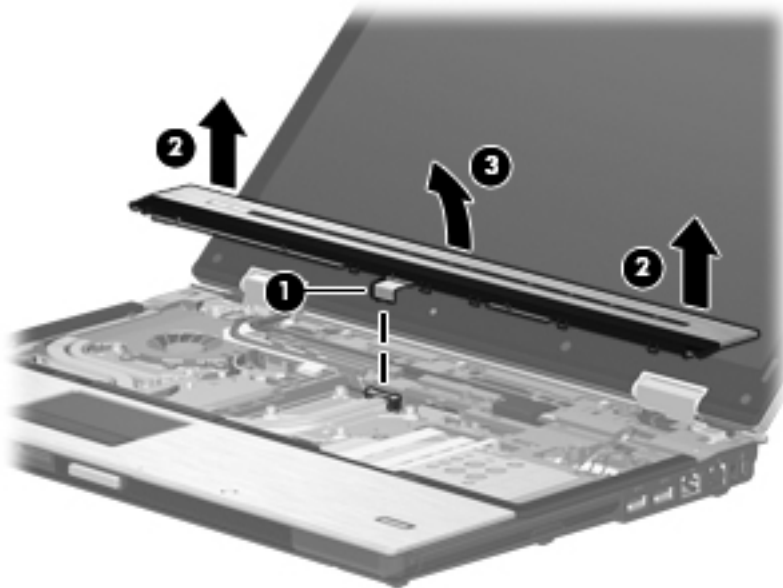

Reverse this procedure to install the switch cover.

Fan

Description	Spare part number
Fan	595769-001

Before removing the fan, follow these steps:

1. Shut down the computer. If you are unsure whether the computer is off or in Hibernation, turn the computer on, and then shut it down through the operating system.
2. Disconnect all external devices connected to the computer.
3. Disconnect the power from the computer by first unplugging the power cord from the AC outlet, and then unplugging the AC adapter from the computer.
4. Remove the battery (see [Battery on page 47](#)).
5. Remove the following components:
 - a. Keyboard (see [Keyboard on page 65](#))
 - b. Switch cover (see [Switch cover on page 71](#))

Remove the fan:

1. Position the computer right-side up, with the front toward you.
2. Disconnect the fan cable **(1)** from the system board.
3. Loosen the three captive Phillips PM 2.5x5.0 screws **(2)** that secure the fan to the base enclosure.



NOTE: The screw closest to the display may be hidden under display cables.

4. Lift the display cables aside **(3)** to allow room to remove the fan.
5. Remove the Mylar **(4)** that secures the fan to the heat sink.

6. Lift the fan from the base enclosure (5).

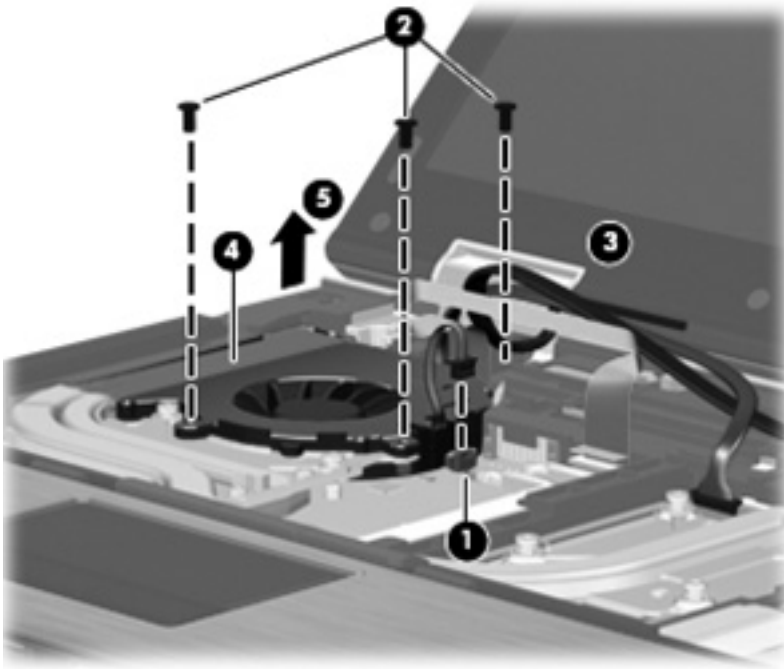

Reverse this procedure to install the fan.

 **NOTE:** To properly ventilate the computer, allow at least a 7.6-cm (3-in) clearance on the left side of the computer.

The computer uses an electric fan for ventilation. The fan is controlled by a temperature sensor and is designed to turn on automatically when high temperature conditions exist. These conditions are affected by high external temperatures, system power consumption, power management/battery conservation configurations, battery fast charging, and software requirements. Exhaust air is displaced through the ventilation grill located on the left side of the computer.

Heat sink

All heat sink spare part kits include replacement thermal material.

Description	Spare part number
Heat sink for use in computers with NVIDIA Quadro FX 1800 graphics (includes fan)	595766-001
Heat sink for use in computers with NVIDIA Quadro FX 880 or NVIDIA NVS 5100 graphics (does not include fan)	595767-001
Heat sink for use in computers with ATI FirePro M5800 graphics (includes fan)	595768-001

Before removing the heat sink, follow these steps:

1. Shut down the computer. If you are unsure whether the computer is off or in Hibernation, turn the computer on, and then shut it down through the operating system.
2. Disconnect all external devices connected to the computer.
3. Disconnect the power from the computer by first unplugging the power cord from the AC outlet, and then unplugging the AC adapter from the computer.
4. Remove the battery (see [Battery on page 47](#)).
5. Remove the following components:
 - a. Keyboard (see [Keyboard on page 65](#))
 - b. Switch cover (see [Switch cover on page 71](#))
 - c. Fan (see [Fan on page 73](#))

Remove the heat sink:

1. Position the computer right-side up, with the front toward you.

2. In the order indicated, loosen the eight Torx T8M2.0x8.0 captive screws (1) - (8) that secure the heat sink to the base enclosure.

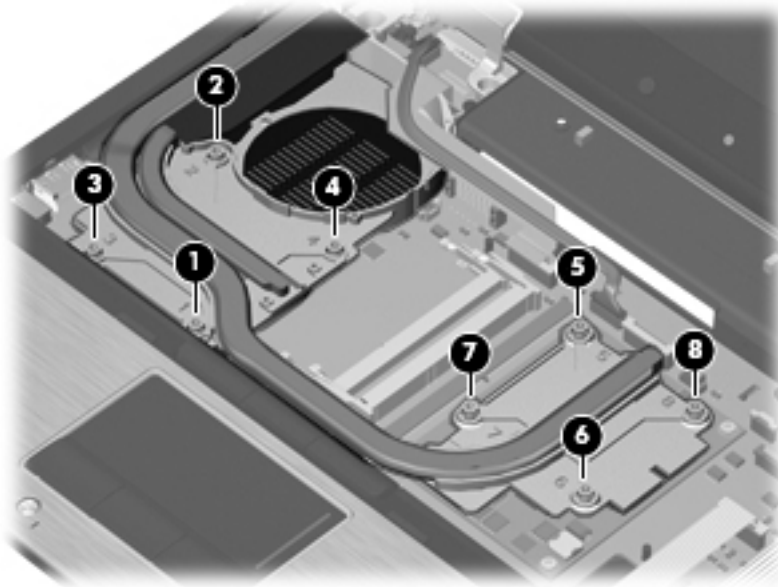

3. Lift the right side of the heat sink (1) to disengage it from the graphics card.
4. Remove the heat sink (2) from the computer.

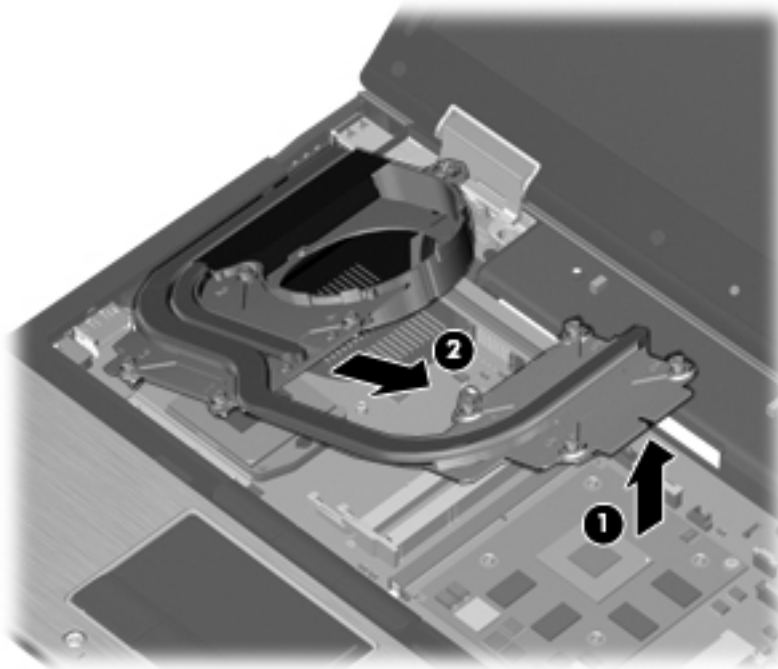

 **NOTE:** The thermal material must be thoroughly cleaned from the surfaces of the heat sink (1) - (3) each time the heat sink is removed. Thermal material is included with all heat sink and processor spare part kits.

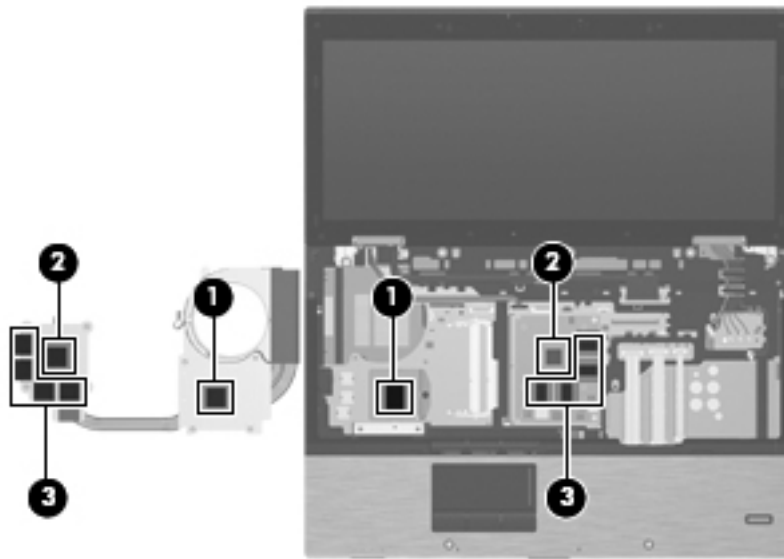

Reverse this procedure to install the heat sink.

Processor

 **NOTE:** All processor spare part kits include replacement thermal material.

Description	Spare part number
Intel Core i7 processors, Quad Core	
820QM, 1.73-GHz (Turbo up to 3.06) processor 8-MB L3 cache, 8 threads	583053-001
720QM, 1.66-GHz (Turbo up to 2.80) processor 6-MB L3 cache, 8 threads	586170-001
Intel Core i7 processor, Dual Core	
620M, 2.66-GHz (Turbo up to 3.33) processor 4-MB L3 cache, 4 threads	587259-001
Intel Core i5 processors, Dual Core	
540M, 2.53-GHz (Turbo up to 3.06) processor 3-MB L3 cache, 4 threads	594188-001
520M, 2.40-GHz (Turbo up to 2.93) processor 3-MB L3 cache, 4 threads	594187-001

Before removing the processor, follow these steps:

1. Shut down the computer. If you are unsure whether the computer is off or in Hibernation, turn the computer on, and then shut it down through the operating system.
2. Disconnect all external devices connected to the computer.
3. Disconnect the power from the computer by first unplugging the power cord from the AC outlet, and then unplugging the AC adapter from the computer.

4. Remove the battery (see [Battery on page 47](#)).
5. Remove the following components:
 - a. Keyboard (see [Keyboard on page 65](#))
 - b. Switch cover (see [Switch cover on page 71](#))
 - c. Fan (see [Fan on page 73](#))
 - d. Heat sink (see [Heat sink on page 75](#))

Remove the processor:

1. Position the computer right-side up, with the front toward you.
2. Use a flat-bladed screwdriver to turn the processor locking screw **(1)** one-half turn counterclockwise until you hear a click.
3. Lift the processor **(2)** straight up and remove it.

 **NOTE:** The gold triangle **(3)** on the processor must be aligned with the triangle **(4)** embossed on the processor slot when you install the processor.

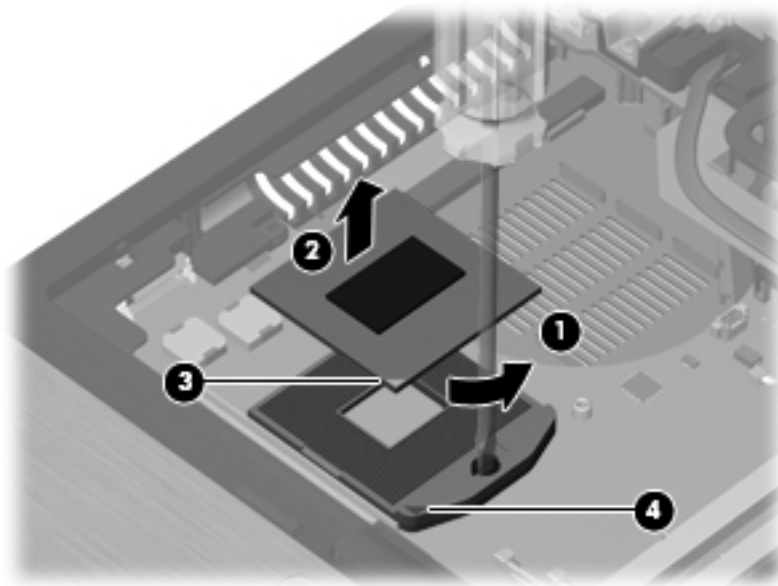

Reverse this procedure to install the processor.

Graphics card

 **NOTE:** All graphics card spare part kits include replacement thermal material.

Description	Spare part number
NVIDIA NVS 5100 graphics card	595820-001
NVIDIA Quadro FX 880 graphics card	595821-001
NVIDIA Quadro FX 1800 graphics card	595822-001
ATI FirePro M5800 graphics card	595823-001

Before removing the graphics card, follow these steps:

1. Shut down the computer. If you are unsure whether the computer is off or in Hibernation, turn the computer on, and then shut it down through the operating system.
2. Disconnect all external devices connected to the computer.
3. Disconnect the power from the computer by first unplugging the power cord from the AC outlet, and then unplugging the AC adapter from the computer.
4. Remove the battery (see [Battery on page 47](#)).
5. Remove the following components:
 - a. Keyboard (see [Keyboard on page 65](#))
 - b. Switch cover (see [Switch cover on page 71](#))
 - c. Fan (see [Fan on page 73](#))
 - d. Heat sink (see [Heat sink on page 75](#))

Remove the graphics card:

1. Position the computer right-side up, with the front toward you.
2. Remove the two Phillips PM2.5×3.0 screws **(1)** that secure the graphics card to the computer. (The edge of the board opposite the graphics card slot rises away from the computer.)

3. Remove the graphics card (2) by sliding it away from the graphics card slot at an angle.

 **NOTE:** The graphics card is designed with a notch (3) to prevent incorrect insertion.

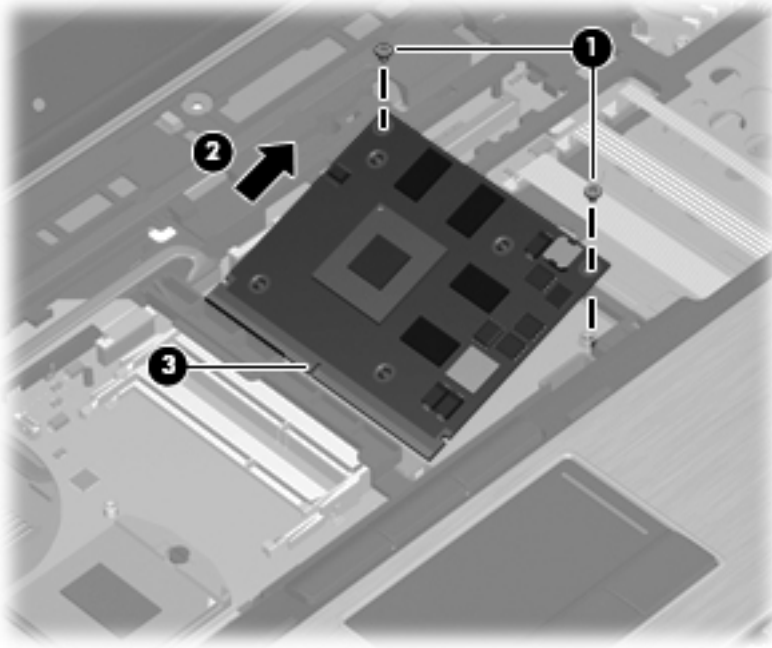

Reverse this procedure to install the graphics card.

Display assembly

All display assemblies include 3 WLAN antenna transceivers and cables, and 2 WWAN antenna transceivers and cables.

Description	Spare part number
For use in model 8540p:	
39.6-cm (15.6-in) LED, HD, AntiGlare for use in computers without a webcam	595736-001
39.6-cm (15.6-in) LED, HD, AntiGlare for use in computers with a webcam	595737-001
39.6-cm (15.6-in) LED, FHD for use in computers without a webcam	595738-001
39.6-cm (15.6-in) LED, FHD for use in computers with a webcam	600755-001
39.6-cm (15.6-in) LED, HD+ WVA for use in computers without a webcam	595739-001
39.6-cm (15.6-in) LED, HD+ for use in computers with a webcam	595740-001
For use in model 8540w:	
39.6-cm (15.6-in) LED, HD, AntiGlare for use in computers without a webcam	600756-001
39.6-cm (15.6-in) LED, HD, AntiGlare for use in computers with a webcam	600757-001
39.6-cm (15.6-in) LED, HD+ WVA for use in computers without a webcam	600760-001
39.6-cm (15.6-in) LED, HD+ WVA for use in computers with a webcam	600761-001
39.6-cm (15.6-in) LED, FHD for use in computers without a webcam	600758-001
39.6-cm (15.6-in) LED, FHD for use in computers with a webcam	600759-001
39.6-cm (15.6-in) LED, FHD, DreamColor for use in computers without a webcam	606979-001
39.6-cm (15.6-in) LED, FHD, DreamColor for use in computers with a webcam	606980-001

Before removing the display assembly, follow these steps:

1. Shut down the computer. If you are unsure whether the computer is off or in Hibernation, turn the computer on, and then shut it down through the operating system.
2. Disconnect all external devices connected to the computer.
3. Disconnect the power from the computer by first unplugging the power cord from the AC outlet, and then unplugging the AC adapter from the computer.
4. Remove the battery (see [Battery on page 47](#)).
5. Disconnect the wireless antenna cables from the WLAN module (see [WLAN module on page 69](#)) and the WWAN module (see [WWAN module on page 62](#)).
6. Remove the following components:
 - a. Keyboard (see [Keyboard on page 65](#))
 - b. Switch cover (see [Switch cover on page 71](#))

Remove the display assembly:

1. Position the computer right-side up, with the front toward you.
2. Disconnect the display panel cable (1) from the system board.
3. Remove the display panel cable from the clips built into the top cover (2)
4. Disconnect the microphone cable from the pass-thru cable (3).
5. Remove the WWAN antenna cables from the channel to the bottom of the base enclosure.(4).
6. Remove the WWAN antenna, WLAN antenna, and the microphone cables (5) from the clips built into the top cover.

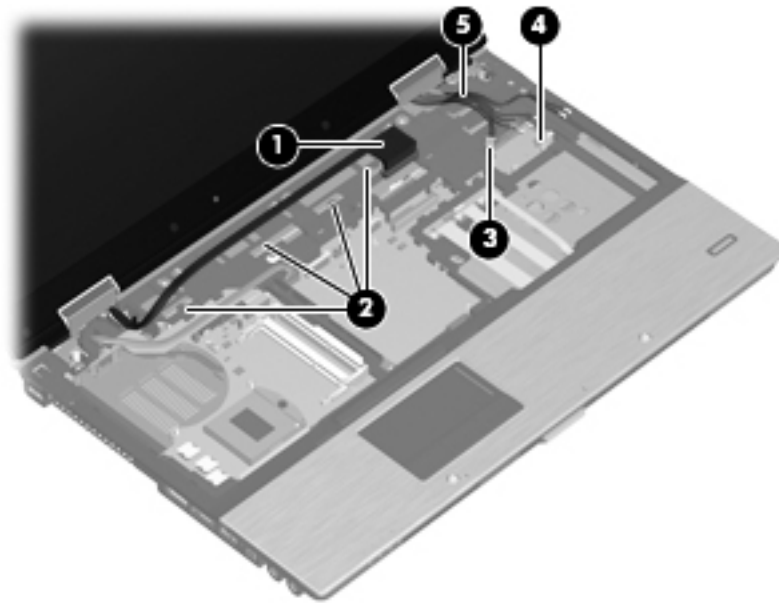

7. Position the computer upside-down, with the rear toward you.

8. Remove the following:
 - (1) Two rubber screw covers
 - (2) Four Torx T8M2.5×7.0 screws, two on the bottom, two on back
 - (3) Two Phillips PM2.5×3.0 screws in the battery bay

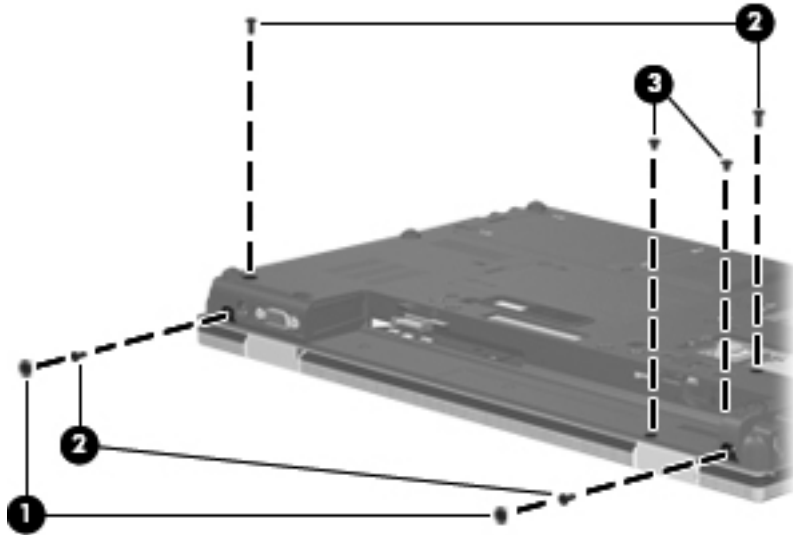

9. Remove the three Torx T8M2.5×7.0 screws (1) that secure the display assembly to the computer.
10. Lift the display assembly (2) straight up and remove it.

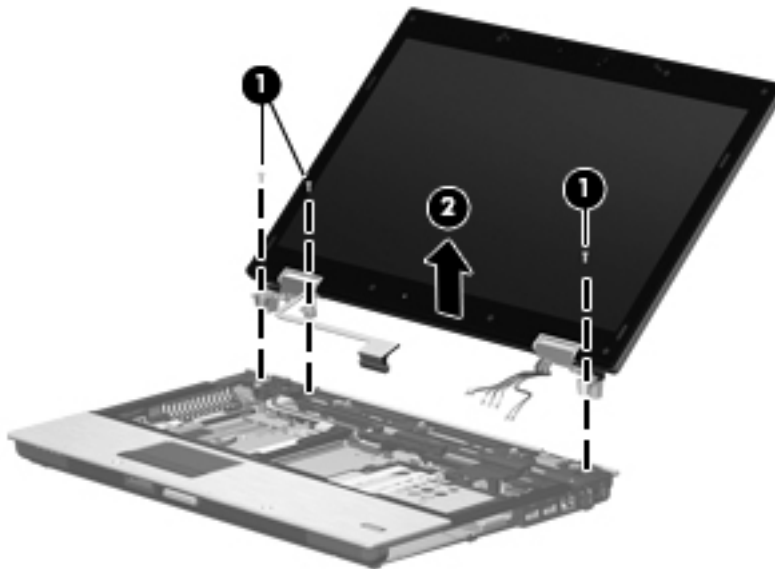

△ **CAUTION:** When installing the display assembly, be sure that the 4 wireless antenna cables routed out of the display right hinge are routed and arranged properly.

Failure to follow these routing instructions can result in degradation of the computer's WLAN and WWAN performance.

11. If it is necessary to replace the display bezel or display hinges, remove the following:

- (1) Four rubber screw covers on the display bezel top edge
- (2) Two rubber screw covers on the display bezel bottom edge
- (3) Four Phillips PM2.5×5.0 screws on the display bezel top edge
- (4) Two Phillips PM2.5×5.0 screws on the display bezel bottom edge

 **NOTE:** See [Ambient light sensor on page 52](#) for display inverter replacement instructions.

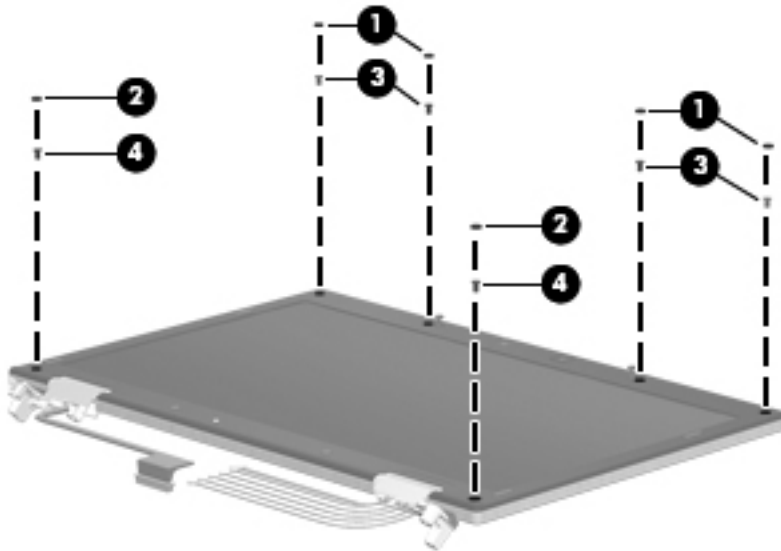

12. Flex the top (1) of the bezel, the inside edges of the left and right sides (2), and then the bottom (3) of the bezel until it disengages from the display enclosure.

13. Remove the display bezel (4). The display bezel is available using spare part numbers 595747-001 (for use with computer models with a webcam), 595748-001 (for use with computer models equipped without a webcam), and 595749-001 (for use with computer models equipped with DreamColor displays).

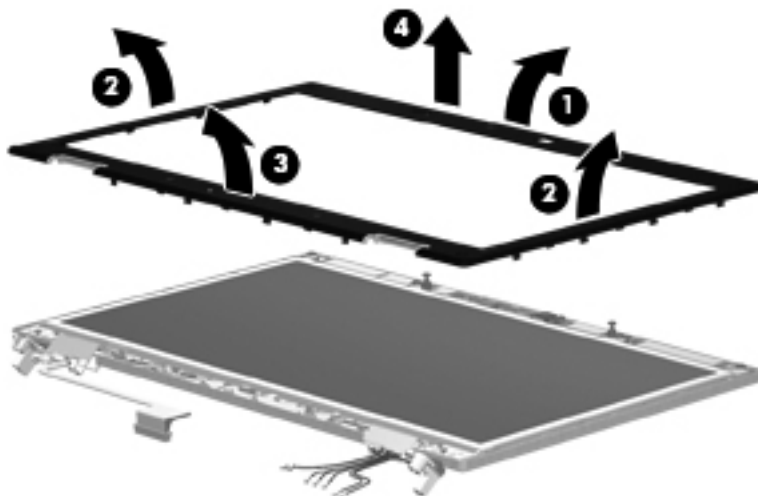

14. If it is necessary to replace the webcam module from the display enclosure, gently pull the webcam module away from the double-sided tape on the display enclosure (1), disconnect the webcam cable from the module (2), and then remove the webcam. The webcam module is available using spare part number 583219-001.

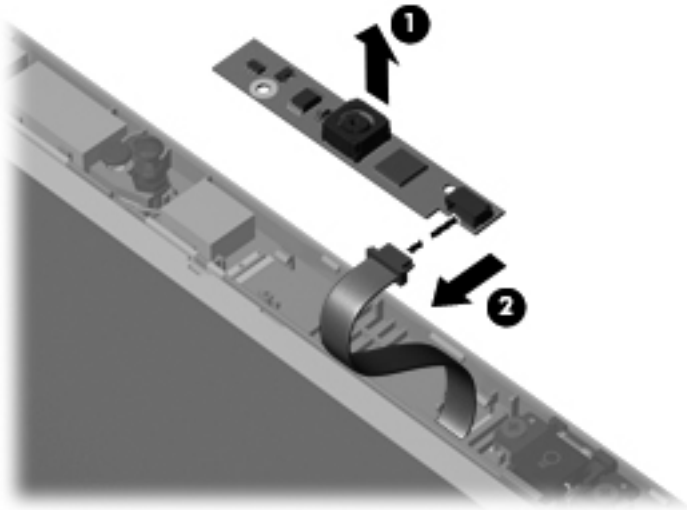

15. If it is necessary to replace the display panel, remove the four Phillips PM2.5×5.0 screws (1) that secure the display panel to the display enclosure.
16. Remove the display panel cable from the left hinge (2).
17. Remove the antenna and microphone cables from the right hinge (3).
18. Remove the display panel (4).

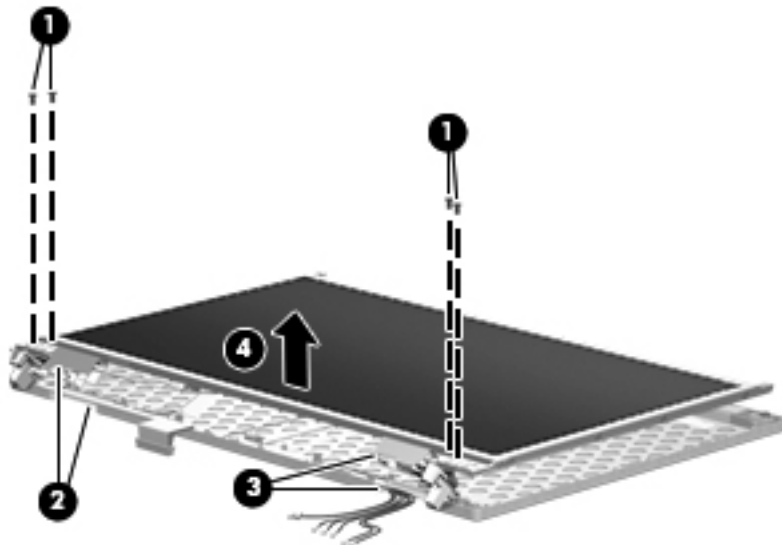

19. If it is necessary to remove the display panel cable, remove the tape that secures the connector to the display panel (1), slide up and back the vertical bracket (2) that secures the cable to the display, and then lift the cable away from the display panel (3). The display panel cable is in the Display Panel Cable Kit, spare part number 595741-001.

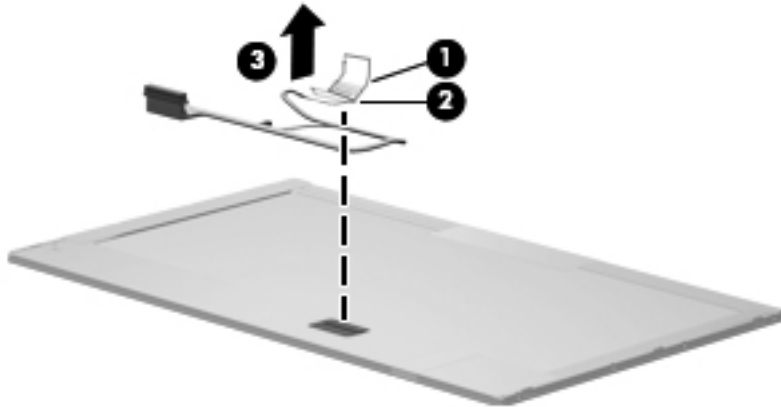

20. If it is necessary to replace the display hinges, remove the four Phillips PM2.5×3.0 screws (1) that secure each display hinge to the display panel.
21. Remove the display hinges (2). The left and right display hinges are available using spare part number 595742-001 for models that do not use DreamColor displays, and 595743-001 for models that use DreamColor displays.

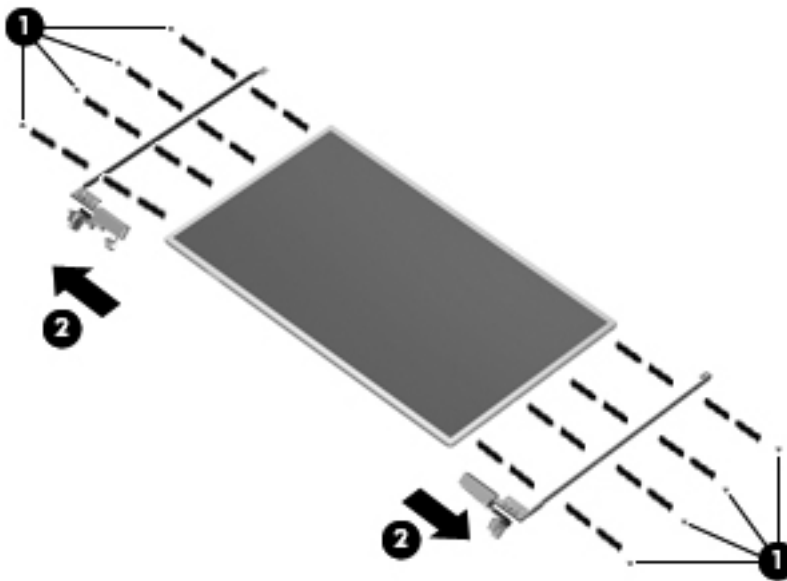

Reverse this procedure to reassemble and install the display assembly.

Top cover

All top covers include TouchPad button and bracket.

Description	Spare part number
For use with HP EliteBook 8540p computer models that include a fingerprint reader	595775-001
For use with HP EliteBook 8540p computer models that do not include a fingerprint reader	595776-001
For use with HP EliteBook 8540w computer models that include a fingerprint reader	595777-001
For use with HP EliteBook 8540w computer models that do not include a fingerprint reader	595778-001

Before removing the top cover, follow these steps:

1. Shut down the computer. If you are unsure whether the computer is off or in Hibernation, turn the computer on, and then shut it down through the operating system.
2. Disconnect all external devices connected to the computer.
3. Disconnect the power from the computer by first unplugging the power cord from the AC outlet, and then unplugging the AC adapter from the computer.
4. Remove the battery (see [Battery on page 47](#)).
5. Remove the following components:
 - a. Hard drive (see [Hard drive on page 54](#))
 - b. Optical drive (see [Optical drive on page 49](#))
 - c. Keyboard (see [Keyboard on page 65](#))
 - d. Switch cover (see [Switch cover on page 71](#))
 - e. Display assembly (see [Display assembly on page 81](#))

Remove the top cover:

1. Turn the computer upside-down, with the front toward you.
2. Remove the two rubber screw covers **(1)**. The rubber screw covers are included in the Rubber Kit, spare part number 595785-001.
3. Remove the six Torx T8M2.5×7.0 screws **(2)** that secure the top cover to the base enclosure.
4. Remove the two Phillips PM2.5x3.0 screws **(3)** from the optical drive bay.

5. Remove the two Phillips PM2.0x3.0 screws (4) from the hard drive bay.

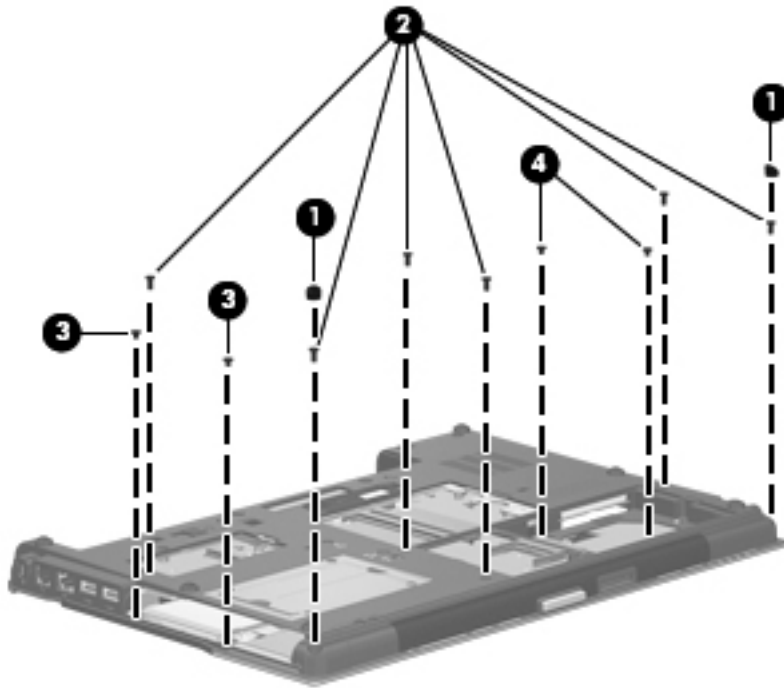

6. Turn the computer right-side up, with the rear toward you.
7. Remove the two Torx T8M2.5x6.0 screws (1) from the top of the top cover.
8. Close the computer and turn the rear toward you.
9. Remove the two HM2.5x6.0 screw locks (2) that secure the top cover to the computer.

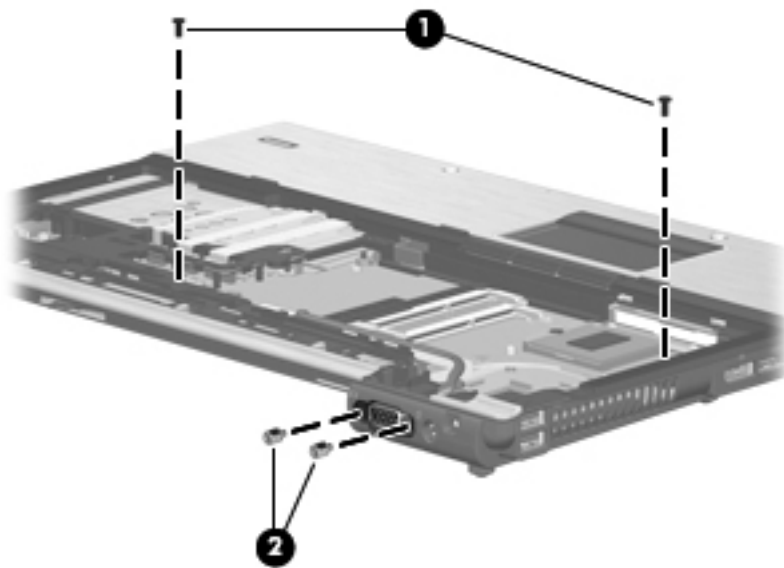

10. Disconnect the following cables from the system board:

- (1) Black VGA cable
- (2) Gray VGA cable
- (3) Fingerprint reader cable
- (4) TouchPad cable
- (5) Card reader cable

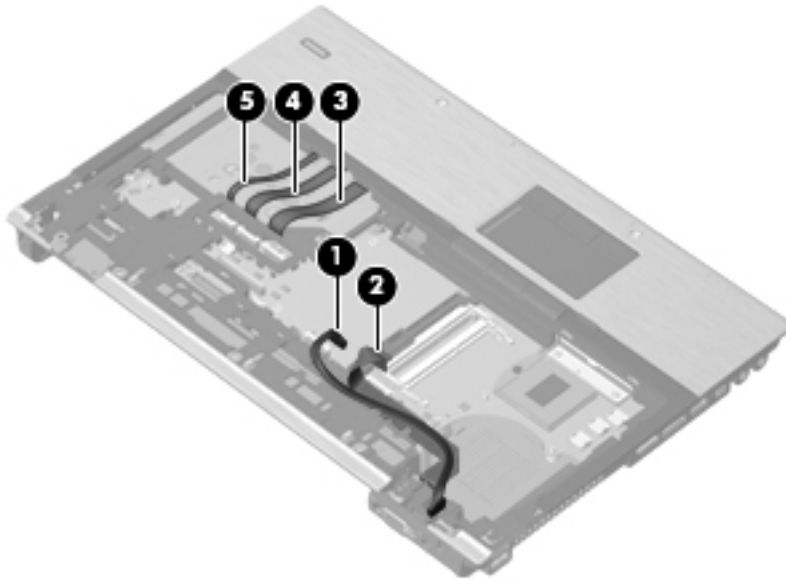

11. Lift the rear edge of the top cover (1), and then swing it up and forward slightly.

12. Lift the top cover up (2) to allow access to the audio pass-thru cable located on the bottom of the top cover.

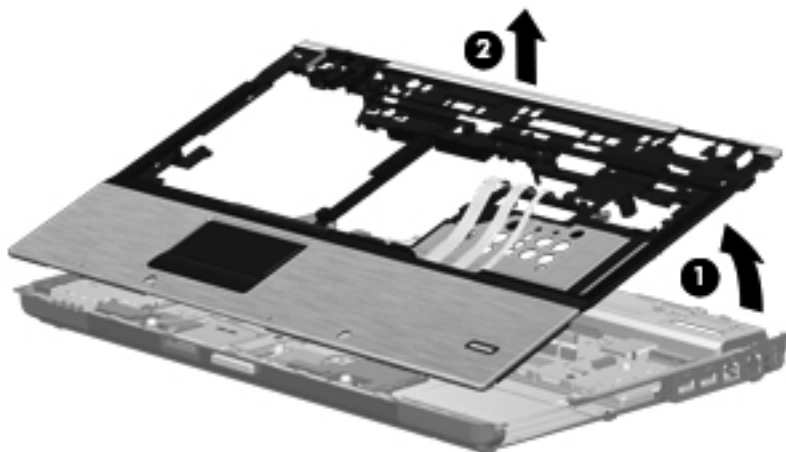

13. Disconnect the audio pass-thru cable from the system board.

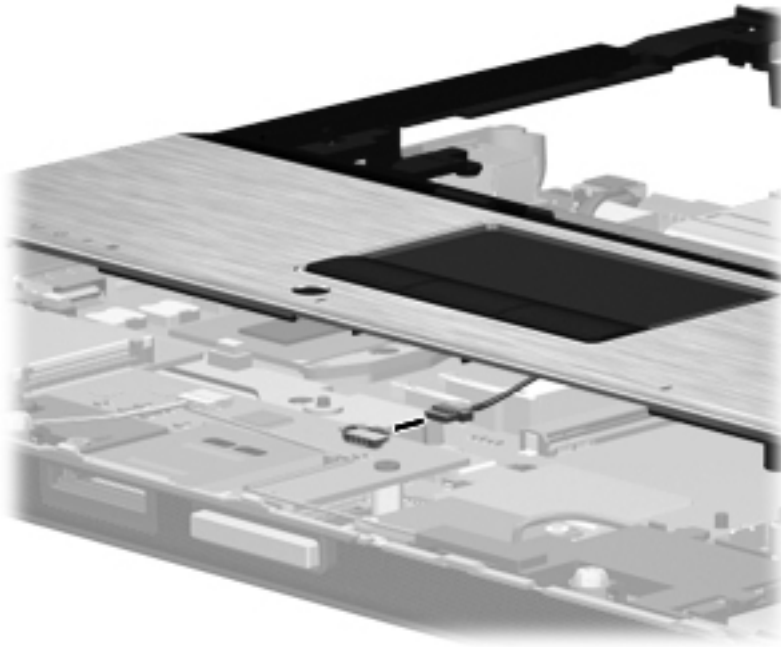

Reverse this procedure to install the top cover.

Modem module

 **NOTE:** The modem module spare part kit does not include a modem module cable. The modem module cable is included in the Cable Kit, spare part number 595787-001. See [Cable Kit on page 30](#) for more Cable Kit spare part number information.

Description	Spare part number
Modem module for use in all countries and regions except Australia and New Zealand	510099-001
Modem module for use in Australia and New Zealand	510099-011

Before removing the modem module, follow these steps:

1. Shut down the computer. If you are unsure whether the computer is off or in Hibernation, turn the computer on, and then shut it down through the operating system.
2. Disconnect all external devices connected to the computer.
3. Disconnect the power from the computer by first unplugging the power cord from the AC outlet, and then unplugging the AC adapter from the computer.
4. Remove the battery (see [Battery on page 47](#)).
5. Remove the following components:
 - a. Hard drive (see [Hard drive on page 54](#))
 - b. Keyboard (see [Keyboard on page 65](#))
 - c. Optical drive (see [Optical drive on page 49](#))
 - d. Switch cover (see [Switch cover on page 71](#))
 - e. Display assembly (see [Display assembly on page 81](#))
 - f. Top cover (see [Top cover on page 87](#))

Remove the modem module:

1. Turn the computer right-side up, with the front toward you.
2. Remove the Phillips PM2.0×3.0 barrel screws **(1)** that secure the modem module to the system board.
3. Disconnect the modem module **(2)** from the system board by lifting it straight up.

4. Disconnect the modem module cable (3) from the modem module.

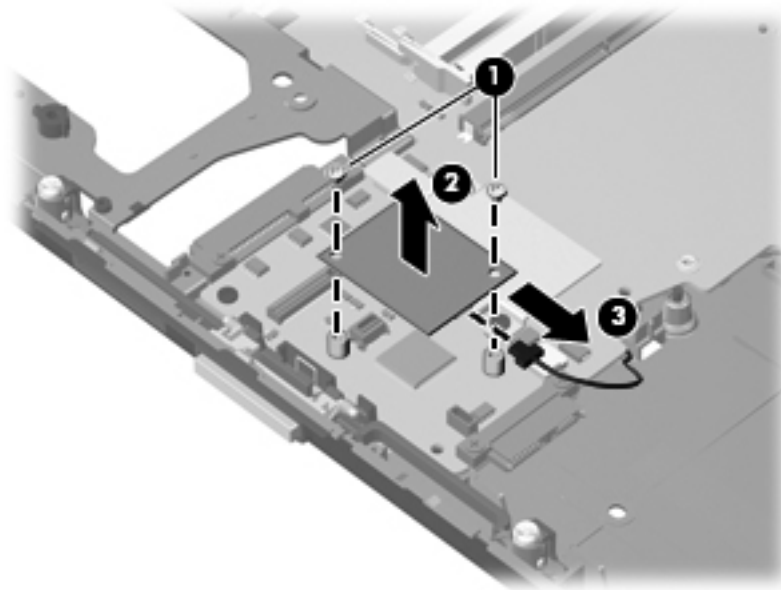

Reverse this procedure to install the modem module.

ExpressCard/audio assembly

Description	Spare part number
ExpressCard/audio assembly	595783-001

Before removing the ExpressCard/audio assembly, follow these steps:

1. Shut down the computer. If you are unsure whether the computer is off or in Hibernation, turn the computer on, and then shut it down through the operating system.
2. Disconnect all external devices connected to the computer.
3. Disconnect the power from the computer by first unplugging the power cord from the AC outlet, and then unplugging the AC adapter from the computer.
4. Remove the battery (see [Battery on page 47](#)).
5. Remove the following components:
 - a. Hard drive (see [Hard drive on page 54](#))
 - b. Optical drive (see [Optical drive on page 49](#))
 - c. Keyboard (see [Keyboard on page 65](#))
 - d. Switch cover (see [Switch cover on page 71](#))
 - e. Display assembly (see [Display assembly on page 81](#))
 - f. Top cover (see [Top cover on page 87](#))

- g. Fan (see [Fan on page 73](#))
- h. Heat sink (see [Heat sink on page 75](#))
- i. Modem module (see [Modem module on page 91](#))

Remove the ExpressCard/audio assembly:

1. Position the computer right-side up, with the front toward you.
2. Disconnect the speaker cable from the assembly (1).
3. Remove the two Torx T8M2.5×8.0 screws (2) that secure the assembly to the base enclosure.
4. Lift the right side of the assembly (3) until the audio connectors disengage from the openings in the base enclosure.

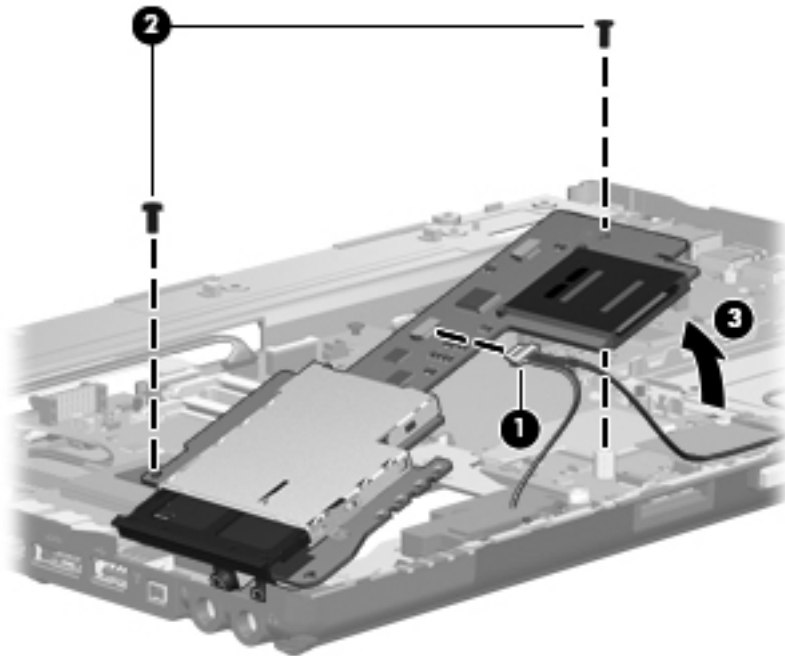

5. Remove the assembly from the base enclosure.

Reverse this procedure to install the ExpressCard/audio assembly.

Speaker assembly

Description	Spare part number
Speaker assembly	595788-001

Before removing the speaker assembly, follow these steps:

1. Shut down the computer. If you are unsure whether the computer is off or in Hibernation, turn the computer on, and then shut it down through the operating system.
2. Disconnect all external devices connected to the computer.
3. Disconnect the power from the computer by first unplugging the power cord from the AC outlet, and then unplugging the AC adapter from the computer.
4. Remove the battery (see [Battery on page 47](#)).
5. Remove the following components:
 - a. Hard drive (see [Hard drive on page 54](#))
 - b. Optical drive (see [Optical drive on page 49](#))
 - c. Keyboard (see [Keyboard on page 65](#))
 - d. Switch cover (see [Switch cover on page 71](#))
 - e. Display assembly (see [Display assembly on page 81](#))
 - f. Top cover (see [Top cover on page 87](#))

Remove the speaker assembly:

1. Position the computer right-side up, with the front toward you.

2. Unplug the Bluetooth cable (1) from the system board, and then remove the cable from the routing channel atop the right speaker (2).

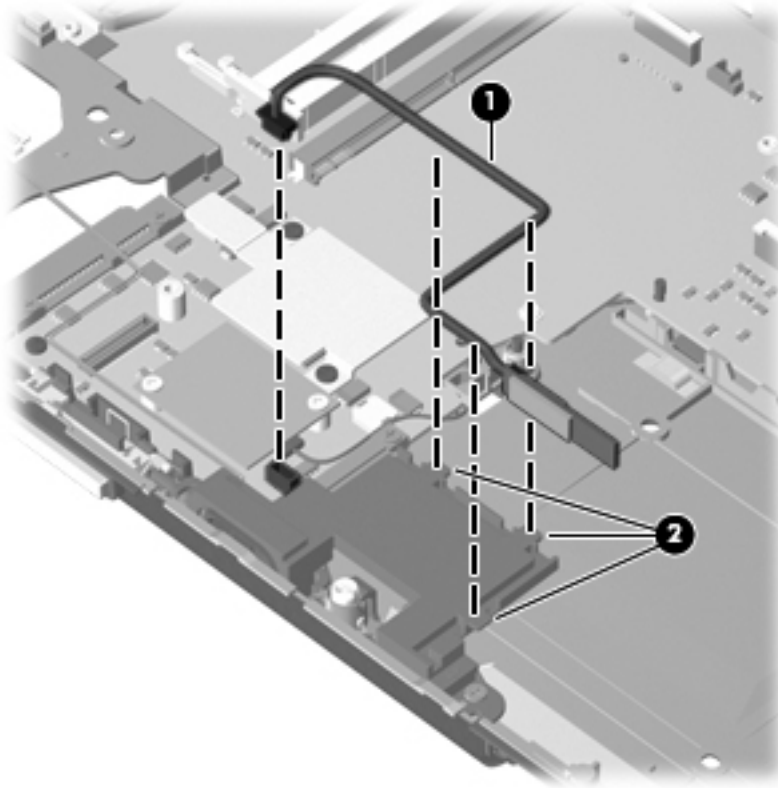

3. Remove the four Phillips PM2.5×5.0 screws (1) that secure the speaker assembly to the base enclosure.
4. Remove the speaker assembly (2) from the base enclosure.

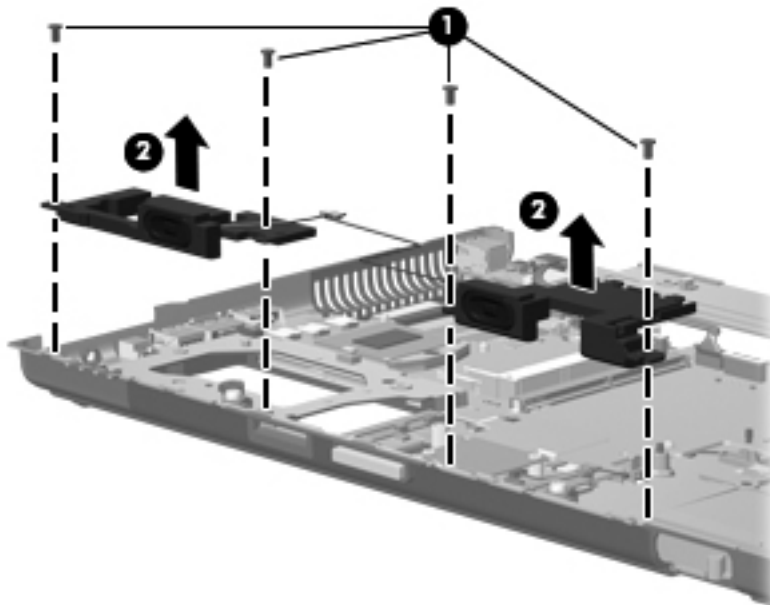

Reverse this procedure to install the speaker assembly.

System board

 **NOTE:** All system board spare part kits include replacement thermal material and VGA support bracket.

NOTE: Models that support quad-core processors have four memory slots. Models that support dual-core processors have two memory slots.

Description	Spare part number
For use with the following dual-core processors: 520M, 540M, 620M	595764-001
For use with the following quad-core processors: 720QM, 820QM	595765-001

Before removing the system board, follow these steps:

1. Shut down the computer. If you are unsure whether the computer is off or in Hibernation, turn the computer on, and then shut it down through the operating system.
2. Disconnect all external devices connected to the computer.
3. Disconnect the power from the computer by first unplugging the power cord from the AC outlet, and then unplugging the AC adapter from the computer.
4. Remove the battery (see [Battery on page 47](#)).
5. Remove the following components:
 - a. Hard drive (see [Hard drive on page 54](#))
 - b. Optical drive (see [Optical drive on page 49](#))
 - c. Keyboard (see [Keyboard on page 65](#))
 - d. Switch cover (see [Switch cover on page 71](#))
 - e. Display assembly (see [Display assembly on page 81](#))
 - f. Fan (see [Fan on page 73](#))
 - g. Heat sink (see [Heat sink on page 75](#))
 - h. Top cover (see [Top cover on page 87](#))
 - i. ExpressCard/audio assembly (see [ExpressCard/audio assembly on page 92](#))
 - j. Modem module (see [Modem module on page 91](#))

When replacing the system board, be sure that the following components are removed from the defective system board and installed on the replacement system board:

- SIM (see [SIM on page 48](#))
- Memory module (see [Expansion memory modules on page 60](#))
- WLAN module (see [WLAN module on page 69](#))

- WWAN module (see [WWAN module on page 62](#))
- Processor (see [Processor on page 77](#))
- Graphics card (see [Graphics card on page 79](#))

Remove the system board:

1. Position the computer right-side up, with the front toward you.
2. Remove the four Torx T8M2.5×7.0 screws (1) that secure the system board to the base enclosure.
3. Lift the system board up a couple of inches (2) to gain access to the VGA board connector located under the system board.

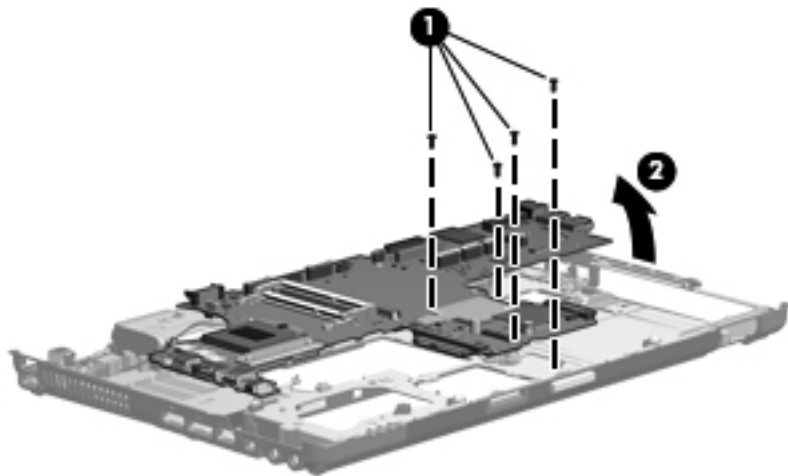

4. Disconnect the VGA board cable from the bottom of the system board.

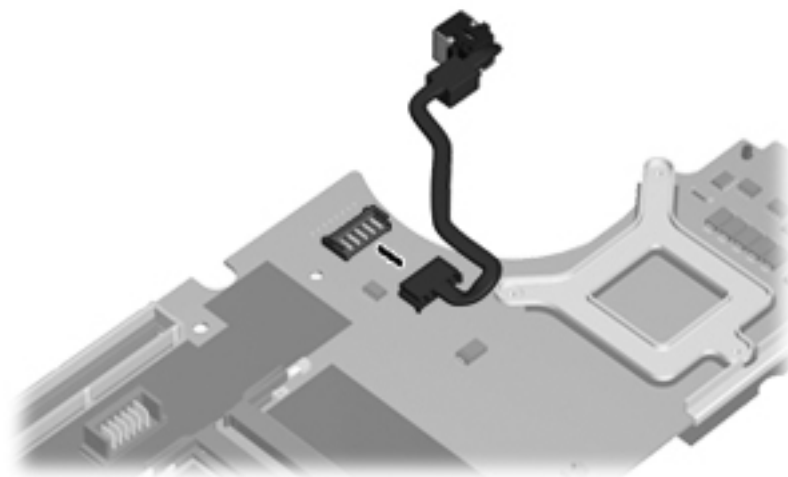

5. Remove the system board from the chassis.

Reverse the preceding procedure to install the system board.

RJ-11 connector cable

 **NOTE:** The RJ-11 connector cable is included in the Cable Kit, spare part number 595787-001.

Before removing the RJ-11 connector cable, follow these steps:

1. Shut down the computer. If you are unsure whether the computer is off or in Hibernation, turn the computer on, and then shut it down through the operating system.
2. Disconnect all external devices connected to the computer.
3. Disconnect the power from the computer by first unplugging the power cord from the AC outlet, and then unplugging the AC adapter from the computer.
4. Remove the battery (see [Battery on page 47](#)).
5. Remove the following components:
 - a. Hard drive (see [Hard drive on page 54](#))
 - b. Optical drive (see [Optical drive on page 49](#))
 - c. Keyboard (see [Keyboard on page 65](#))
 - d. Switch cover (see [Switch cover on page 71](#))
 - e. Display assembly (see [Display assembly on page 81](#))
 - f. Top cover (see [Top cover on page 87](#))
 - g. Fan (see [Fan on page 73](#))
 - h. Heat sink (see [Heat sink on page 75](#))
 - i. Modem module (see [Modem module on page 91](#))
 - j. System board (see [System board on page 96](#))

Remove the RJ-11 connector cable:

1. Position the computer right-side up, with the front toward you.
2. Remove the RJ-11 connector (**1**) from the clip built into the base enclosure.

3. Remove the RJ-11 connector cable from the clips and routing channel (2) built into the base enclosure.

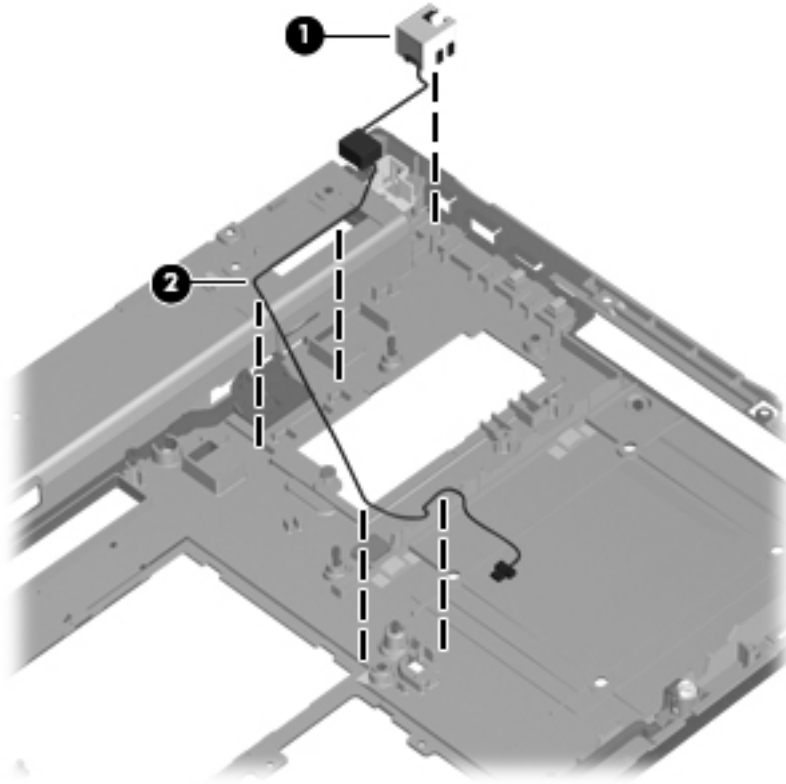

4. Remove the RJ-11 connector cable from the base enclosure.
Reverse this procedure to install the RJ-11 connector cable.

USB/VGA board

Description	Spare part number
USB/VGA board (includes cable)	595782-001

Before removing the USB/VGA board, follow these steps:

1. Shut down the computer. If you are unsure whether the computer is off or in Hibernation, turn the computer on, and then shut it down through the operating system.
2. Disconnect all external devices connected to the computer.
3. Disconnect the power from the computer by first unplugging the power cord from the AC outlet, and then unplugging the AC adapter from the computer.
4. Remove the battery (see [Battery on page 47](#)).
5. Remove the following components:
 - a. Hard drive (see [Hard drive on page 54](#))
 - b. Optical drive (see [Optical drive on page 49](#))
 - c. Keyboard (see [Keyboard on page 65](#))
 - d. Switch cover (see [Switch cover on page 71](#))
 - e. Display assembly (see [Display assembly on page 81](#))
 - f. Top cover (see [Top cover on page 87](#))
 - g. Fan (see [Fan on page 73](#))
 - h. Heat sink (see [Heat sink on page 75](#))
 - i. Modem module (see [Modem module on page 91](#))
 - j. System board (see [System board on page 96](#))

Remove the USB/VGA board:

1. Position the computer right-side up, with the front toward you.
2. Remove the Torx T8M2.5×6.0 screw **(1)** that secures the USB board to the base enclosure.

3. Lift the USB/VGA board out of the chassis (2)

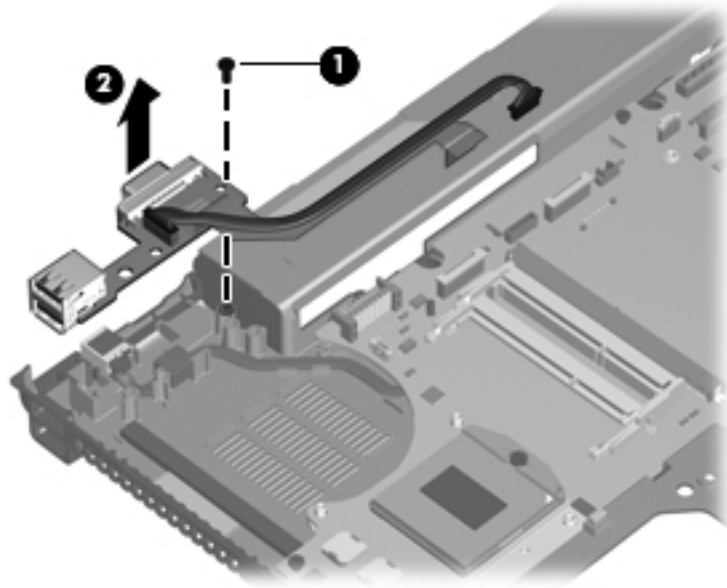

Reverse this procedure to install the USB/VGA board.

Power connector cable

 **NOTE:** The power connector cable is included in the Cable Kit, spare part number 595787-001.

Before removing the power connector cable, follow these steps:

1. Shut down the computer. If you are unsure whether the computer is off or in Hibernation, turn the computer on, and then shut it down through the operating system.
2. Disconnect all external devices connected to the computer.
3. Disconnect the power from the computer by first unplugging the power cord from the AC outlet, and then unplugging the AC adapter from the computer.
4. Remove the battery (see [Battery on page 47](#)).
5. Remove the following components:
 - a. Hard drive (see [Hard drive on page 54](#))
 - b. Optical drive (see [Optical drive on page 49](#))
 - c. Keyboard (see [Keyboard on page 65](#))
 - d. Switch cover (see [Switch cover on page 71](#))
 - e. Display assembly (see [Display assembly on page 81](#))
 - f. Top cover (see [Top cover on page 87](#))
 - g. Fan (see [Fan on page 73](#))
 - h. Heat sink (see [Heat sink on page 75](#))
 - i. Modem module (see [Modem module on page 91](#))
 - j. System board (see [System board on page 96](#))

Remove the power connector cable:

1. Position the computer right-side up, with the front toward you.
2. Lift the power connector **(1)** up from the clips **(2)** in the rear of the base enclosure.

3. Remove the power connector cable from the enclosure.

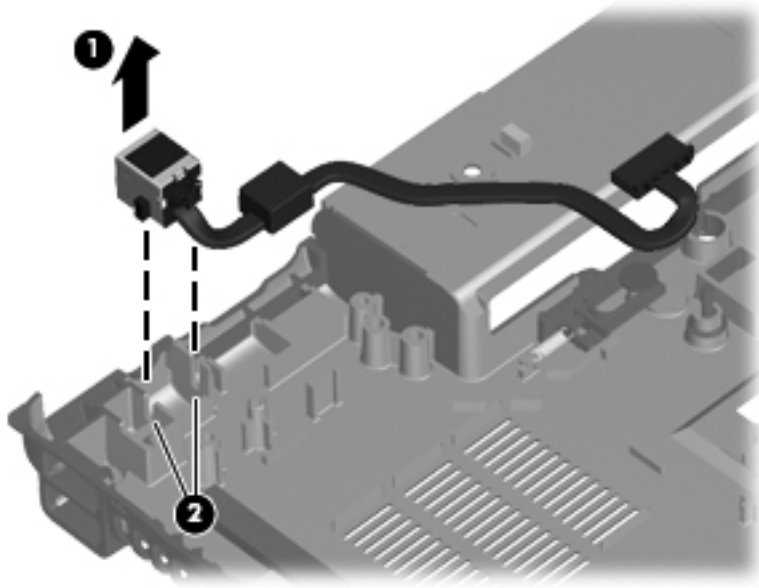

Reverse this procedure to install the power connector cable.

5 Computer Setup

Starting Computer Setup

Computer Setup is a preinstalled, ROM-based utility that can be used even when the operating system is not working or will not load.

 **NOTE:** Some of the Computer Setup menu items listed in this guide may not be supported by your computer.

NOTE: An external keyboard or mouse connected to a USB port can be used with Computer Setup only if USB legacy support is enabled.

To start Computer Setup, follow these steps:

1. Turn on or restart the computer, and then press **esc** while the “Press the ESC key for Startup Menu” message is displayed at the bottom of the screen.
2. Press **f10** to enter BIOS Setup.

Using Computer Setup

Navigating and selecting in Computer Setup

The information and settings in Computer Setup are accessed from the File, Security, Diagnostics, and System Configuration menus.

To navigate and select in Computer Setup, follow these steps:

1. Turn on or restart the computer, and then press **esc** while the “Press the ESC key for Startup Menu” message is displayed at the bottom of the screen.
 - To select a menu or a menu item, use the tab key and the keyboard arrow keys, and then press **enter**, or use a pointing device to click the item.
 - To scroll up and down, click the up arrow or the down arrow in the upper-right corner of the screen, or use the up arrow key or the down arrow key.
 - To close open dialog boxes and return to the main Computer Setup screen, press **esc**, and then follow the on-screen instructions.

 **NOTE:** You can use either a pointing device (TouchPad, pointing stick, or USB mouse) or the keyboard to navigate and make selections in Computer Setup.

2. Press **f10** to enter BIOS Setup.
3. Select the **File**, **Security**, **Diagnostics**, or **System Configuration** menu.

To exit Computer Setup menus, choose one of the following methods:

- To exit Computer Setup menus without saving your changes, click the **Exit** icon in the lower-left corner of the screen, and then follow the on-screen instructions.

– or –

Use the tab key and the arrow keys to select **File > Ignore changes and exit**, and then press [enter](#).

– or –

- To save your changes and exit Computer Setup menus, click the **Save** icon in the lower-left corner of the screen, and then follow the on-screen instructions.

– or –

Use the tab key and the arrow keys to select **File > Save changes and exit**, and then press [enter](#).

Your changes go into effect when the computer restarts.

Restoring factory settings in Computer Setup

 **NOTE:** Restoring defaults will not change the hard drive mode.

To return all settings in Computer Setup to the values that were set at the factory, follow these steps:

1. Turn on or restart the computer, and then press [esc](#) while the “Press the ESC key for Startup Menu” message is displayed at the bottom of the screen.
2. Press [f10](#) to enter BIOS Setup.
3. Use a pointing device or the arrow keys to select **File > Restore defaults**.
4. Follow the on-screen instructions.
5. To save your changes and exit, click the **Save** icon in the lower-left corner of the screen, and then follow the on-screen instructions.

– or –

Use the arrow keys to select **File > Save changes and exit**, and then press [enter](#).

Your changes go into effect when the computer restarts.

 **NOTE:** Your password settings and security settings are not changed when you restore the factory settings.

Computer Setup menus

The menu tables in this section provide an overview of Computer Setup options.

 **NOTE:** Some of the Computer Setup menu items listed in this chapter may not be supported by your computer.

File menu

Select	To do this
System Information	<ul style="list-style-type: none">• View identification information for the computer and the batteries in the system.• View specification information for the processor, cache and memory size, system ROM, video revision, and keyboard controller version.
Set System Date and Time	Set or change the date and time on the computer.
System Diagnostics	Displays the following information: <ul style="list-style-type: none">• System Information<ul style="list-style-type: none">◦ Identification information for the computer and the batteries in the system.◦ Specification information for the processor, cache and memory size, system ROM, video revision, and keyboard controller version.• Start-up Test—Verifies the system components needed for starting the computer.• Run-In Test—Runs a comprehensive check on system memory.• Hard Disk Test—Runs a comprehensive self-test on any hard drive in the system.• Memory Test—Runs a comprehensive test on any memory installed in the computer.• Battery Test—Runs a comprehensive test on any batteries installed in the computer.• Error Log—Displays a log file if any errors have occurred.
Restore defaults	Replace the configuration settings in Computer Setup with the original factory settings. (Hard drive mode, password settings, and security settings are not changed when you restore the factory settings.)
Reset BIOS security to factory default	Restore the BIOS security settings to the factory default.
Ignore changes and exit	Cancel any changes entered during the current session. Then, exit and restart the computer.
Save changes and exit	Save any changes entered during the current session. Then, exit and restart the computer. Your changes go into effect when the computer restarts.

Security menu

 **NOTE:** Some of the menu items listed in this section may not be supported by your computer.

Select	To do this
Administrator Tools	
Setup BIOS Administrator Password	Set up a BIOS administrator password.
User Management (requires a BIOS administrator password)	
Create New BIOS User Account	<ul style="list-style-type: none">• Select from a list of BIOS users.• Select from a list of ProtectTools users.
Password Policy (requires a BIOS administrator password)	Revise password policy criteria.
HP SpareKey	Enable/disable HP SpareKey (enabled by default).
Always Prompt for HP SpareKey Enrollment	Enable/disable HP SpareKey enrollment (enabled by default).
Fingerprint Reset on Reboot (if present)	Reset/clear the fingerprint reader ownership (select models only; disabled by default).
User Tools	
Change Password	Enter, change, or delete a BIOS administrator password.
HP SpareKey Enrollment	Enroll or reset HP SpareKey, which is a set of security questions and answers used if you forget your password.
Anti Theft	
AT-p	Enable/disable Anti-Theft Protection.
DriveLock Passwords	<ul style="list-style-type: none">• Enable/disable DriveLock on any computer hard drive (enabled by default).• Change a DriveLock user password or master password. <p>NOTE: DriveLock settings are accessible only when you enter Computer Setup by turning on (not restarting) the computer.</p>
Automatic DriveLock	Enable/disable Automatic DriveLock support.
TPM Embedded Security	Enable/disable support for Trusted Platform Module (TPM) Embedded Security, which protects the computer from unauthorized access to owner functions available in Embedded Security for ProtectTools. For more information, refer to the ProtectTools software Help. NOTE: You must have a setup password to change this setting.
Disk Sanitizer	Run Disk Sanitizer to destroy all existing data on the primary hard drive or the drive in the upgrade bay. CAUTION: If you run Disk Sanitizer, the data on the selected drive is destroyed permanently.
System IDs	Enter a user-defined computer asset tracking number and ownership tag.

System Configuration menu

 **NOTE:** Some of the listed System Configuration options may not be supported by your computer.

Select	To do this
Language	Change the Computer Setup language.
Boot Options	<ul style="list-style-type: none">• Set a Startup Menu delay (in seconds).• Set the Multiboot Express Boot Popup delay (in seconds).• Enable/disable Custom Logo (disabled by default).• Enable/disable Display Diagnostic URL (enabled by default).• Enable/disable CD-ROM boot (disabled by default).• Enable/disable SD Card boot (enabled by default).• Enable/disable floppy boot (enabled by default).• Enable/disable PXE Internal NIC boot (enabled by default).• Enable/Disable Unified Extensible Firmware Interface (UEFI) Boot Mode (disabled by default).• Set the Legacy Boot Order.
Device Configurations	<ul style="list-style-type: none">• Enable/disable USB legacy support (enabled by default). When enabled, USB legacy support allows the following:<ul style="list-style-type: none">◦ Use of a USB keyboard in Computer Setup even when a Windows operating system is not running.◦ Startup from bootable USB devices, including a hard drive, diskette drive, or optical drive connected by a USB port to the computer.• Select a parallel port mode: ECP (Enhanced Capabilities Port), standard, bidirectional, or EPP (Enhanced Parallel Port).• Enable/disable fan always on while connected to an AC outlet (enabled by default).• Enable/disable Data Execution Prevention (select models only). When enabled, the processor can disable some virus code execution, which helps to improve computer security (disabled by default).• SATA (Serial Advanced Technology Attachment) device mode. The following options are available:<ul style="list-style-type: none">◦ AHCI (Advanced Host Controller Interface)◦ IDE (Integrated Drive Electronics)◦ RAID (Redundant Array of Independent Disks) (select models only)

Select	To do this
	<p>NOTE: Availability of these options varies by computer model.</p> <ul style="list-style-type: none">• Enable/disable secondary battery fast charge (enabled by default).• Enable/disable HP QuickLook (enabled by default).• Enable/disable Preboot Authentication on HP QuickLook Boot (enabled by default).• Enable/disable HP QuickWeb (enabled by default).• Enable/disable HP QuickWeb: Write Protect (disabled by default).• Enable/disable Virtualization Technology (select models only; disabled by default).• Enable/disable TXT (Intel Trusted Execution Technology) (select models only; disabled by default).• Multi Core CPU (enabled by default).• Intel HT Technology (enabled by default).• Enable/disable Wake on USB (enabled by default).• Enable/disable Num lock state at boot (disabled by default).

Select	To do this
Built-In Device Options	<ul style="list-style-type: none">• Enable/disable the wireless button state (enabled by default).• Enable/disable embedded WLAN device radio (select models only; enabled by default).• Enable/disable the embedded Bluetooth device radio (enabled by default).• Enable/disable the Network Interface Controller (NIC) (enabled by default).• Enable/disable LAN/WLAN switching (disabled by default).• Set the wake on LAN state. Options include the following:<ul style="list-style-type: none">◦ Disabled◦ Boot to Network◦ Follow Boot Order• Enable/disable the Ambient Light Sensor.• Enable/disable the Notebook Upgrade Bay device (enabled by default).• Enable/disable the fingerprint device (enabled by default).• Enable/disable the integrated camera (enabled by default).• Enable/disable the Power Monitor Circuit (enabled by default).• Enable/disable the audio device (enabled by default).• Enable/disable a modem device (enabled by default).• Enable/disable the microphone (enabled by default).• Enable/disable the internal speakers (enabled by default).

Select	To do this
Port Options	<p>NOTE: All port options are enabled by default.</p> <ul style="list-style-type: none"> • Enable/disable the serial port. • Enable/disable the parallel port. • Enable/disable the flash media reader. • Enable/disable the USB port. <p>CAUTION: Disabling the USB port also disables MultiBay devices and ExpressCard devices on the advanced port replicator.</p> <ul style="list-style-type: none"> • Enable/disable the 1394 port. • Enable/disable the ExpressCard slot. • Enable/disable the Smart Card slot. • Enable/disable the eSATA port.
AMT Options	<ul style="list-style-type: none"> • Enable/disable Firmware Verbosity. • Enable/disable AMT Setup Prompt (Ctrl+P). • Enable/disable USB Key Provisioning Support. • Enable/disable Unconfigure AMT on next boot. • Select Terminal Emulation Mode. <ul style="list-style-type: none"> ◦ ANSI ◦ VT100 • Enable/disable Firmware Progress Event Support. • Enable/disable Initiate Intel CIRA.
Set Security Level	Change, view, or hide security levels for all BIOS menu items.
Restore Security Defaults	Restore the default security settings.

6 Specifications

Computer specifications

	Metric	U.S.
Dimensions		
Length	25.2 cm	9.9 in
Width	37.4 cm	14.7 in
Height (front to rear)	3.2 to 3.7 cm	1.28 to 1.45 in
Weight (equipped with 39.6-cm (15.6-in) HD+ display, NV Graphics, DVD drive, 1-GB DIMM, 160-GB hard drive, WLAN module, 8-cell battery)	2.89 kg	6.37 lbs
Input power		
Operating voltage	19.0 V dc @ 4.74 A – 90 W	
Operating current	4.74 A	
Temperature		
Operating (not writing to optical disc)	0°C to 35°C	32°F to 95°F
Operating (writing to optical disc)	5°C to 35°C	41°F to 95°F
Nonoperating	-20°C to 60°C	-4°F to 140°F
Relative humidity		
Operating	10% to 90%	
Nonoperating	5% to 95%	
Maximum altitude (unpressurized)		
Operating (14.7 to 10.1 psia)	-15 m to 3,048 m	50 ft to 10,000 ft
Nonoperating (14.7 to 4.4 psia)	-15 m to 12,192 m	-50 ft to 40,000 ft
Shock		
Operating	125 g, 2 ms, half-sine	
Nonoperating	200 g, 2 ms, half-sine	
Random vibration		
Operating	0.75 g zero-to-peak, 10 Hz to 500 Hz, 0.25 oct/min sweep rate	

	Metric	U.S.
Nonoperating	1.50 g zero-to-peak, 10 Hz to 500 Hz, 0.5 oct/min sweep rate	

NOTE: Applicable product safety standards specify thermal limits for plastic surfaces. The computer operates well within this range of temperatures.

39.6-cm (15.6-in) HD display specifications

	Metric	U.S.
Dimensions		
Height	21.0 cm	8.25 in
Width	35.9 cm	14.15 in
Diagonal	39.6 cm	15.6 in
Surface treatment	Anti-glare	
Contrast ratio	300:1 (typical)	
Refresh rate	60 Hz	
Brightness	200 nits (typical)	
Pixel resolution		
Pitch	0.252 mm	
Format	1366 × 768	
Configuration	RGB stripe	
Backlight	LED	
PPI	101 ppi	
Viewing angle	+/-30 horizontal (minimum), +/-10° vertical (minimum) 30/30/20/10 (Left/Right/Down/Up) (minimum) or 45/45/35/25 (Left/Right/Down/Up) (typical)	

39.6-cm (15.6-in) HD+ display specifications

	Metric	U.S.
Dimensions		
Height	20.9 cm	8.25 in
Width	35.9 cm	14.15 in
Diagonal	39.6 cm	15.6 in
Surface treatment	Anti-glare	
Contrast ratio	300:1 (typical)	
Refresh rate	60 Hz	
Brightness	200 nits (typical)	
Pixel resolution		
Pitch	0.2151 mm	
Format	1600 × 900	
Configuration	RGB stripe	
Backlight	LED	
PPI	118 ppi	
Viewing angle	30/30/20/10 (Left/Right/Down/Up) (minimum) or 45/45/35/25 (Left/Right/Down/Up) (typical)	

39.6-cm (15.6-in) FHD display specifications

	Metric	U.S.
Dimensions		
Height	20.9 cm	8.25 in
Width	35.9 cm	14.15 in
Diagonal	39.6 cm	15.6 in
Surface treatment	Anti-glare	
Contrast ratio	300:1 (typical)	
Refresh rate	60 Hz	
Brightness	220 nits (typical)	
Pixel resolution		
Pitch	0.179 × 0.179 mm	
Format	1920 × 1080	
Configuration	RGB stripe	
Backlight	LED	
PPI	142 ppi	
Viewing angle	60/60/50/50 (Left/Right/Down/Up) (minimum) or 70/70/60/60 (Left/Right/Down/Up) (typical)	

Hard drive specifications

	500-GB*	320-GB*	250-GB*
Dimensions			
Height	9.5 mm	9.5 mm	9.5 mm
Width	70 mm	70 mm	70 mm
Weight	101 g	101 g	101 g
Interface type	SATA	SATA	SATA
Transfer rate	100 MB/sec	100 MB/sec	100 MB/sec
Security	ATA security	ATA security	ATA security
Seek times (typical read, including setting)			
Single track	3 ms	3 ms	3 ms
Average	13 ms	13 ms	13 ms
Maximum	24 ms	24 ms	24 ms
Logical blocks	1,048,576,000	625,141,400	488,397,168
Disc rotational speed	7200 rpm	7200 rpm	7200 rpm
Operating temperature	5°C to 55°C (41°F to 131°F)		
*1 GB = 1 billion bytes when referring to hard drive storage capacity. Actual accessible capacity is less. Actual drive specifications may differ slightly.			
NOTE: Certain restrictions and exclusions apply. Contact technical support for details.			

DVD±RW and CD-RW SuperMulti DL Combo Drive specifications

Applicable disc	Read:	Write:
	CD-DA, CD+(E)G, CD-MIDI, CD-TEXT, CD-ROM, CD-ROM XA, MIXED MODE CD, CD-I, CD-I Bridge (Photo-CD, Video CD), Multisession CD (Photo-CD, CD-EXTRA, Portfolio, CD-R, CD-RW), CD-R, CD-RW, DVD-ROM (DVD-5, DVD-9, DVD-10, DVD-18), DVD-R, DVD-RW, DVD+R, DVD+RW, DVD-RAM	CD-R and CD-RW DVD+R, DVD+RW, DVD-R, DVD-RW, DVD-RAM
Center hole diameter	1.5 cm (0.59 in)	
Disc diameter		
Standard disc	12 cm (4.72 in)	
Mini disc	8 cm (3.15 in)	
Disc thickness	1.2 mm (0.047 in)	
Track pitch	0.74 µm	
Access time	CD	DVD
Random	< 175 ms	< 230 ms
Full stroke	< 285 ms	< 335 ms
Audio output level	Line-out, 0.7 Vrms	
Cache buffer	2 MB	
Data transfer rate		
24X CD-ROM	3,600 KB/sec	
8X DVD-ROM	10,800 KB/sec	
24X CD-R	3,600 KB/sec	
16X CD-RW	2,400 KB/sec	
8X DVD+R	10,800 KB/sec	
4X DVD+RW	5,400 KB/sec	
8X DVD-R	10,800 KB/sec	
4X DVD-RW	5,400 KB/sec	
2.4X DVD+R(9)	2,700 KB/sec	
5X DVD-RAM	6,750 KB/sec	
Transfer mode	Multiword DMA Mode	
Startup time	< 15 seconds	
Stop time	< 6 seconds	

Blu-ray Disc ROM with SuperMulti DVD±R/RW DL Drive

Applicable disc	Read:	Write:		
	CD-DA, CD+(E)G, CD-MIDI, CDTEXT, CD-ROM, CD-ROM XA, MIXED MODE CD, CD-I, CD-I Bridge (Photo-CD, Video CD), Multisession CD (Photo-CD, CD-EXTRA, Portfolio, CD-R, CD-RW), CD-R, CD-RW, DVDROM (DVD-5, DVD-9, DVD-10, DVD-18), DVD-R, DVD-RW, DVD+R, DVD+RW, DVD-RAM, HD-ROM (Single Layer), HD-ROM (Dual Layer), HD DVD-R, HD DVD-R for Dual Layer, HD DVD-RW	CD-R and CD-RW DVD+R, DVD+R(9), DVD+RW, DVD-R, DVD-R(9),DVD-RW, DVD-RAM		
Access time	CD	DVD	HD	
Random	170 ms	170 ms	230 ms	
Cache buffer	8 MB			
Data transfer rate				
24X CD-ROM	3,600 KB/sec			
8X DVD	10,800 KB/sec			
24X CD-R	3,600 KB/sec			
16X CD-RW	2,400 KB/sec			
8X DVD+R	10,800 KB/sec			
4X DVD+RW	5,400 KB/sec			
8X DVD-R	10,800 KB/sec			
4X DVD-RW	5,400 KB/sec			
2.4X DVD+R(9)	2,700 KB/sec			
5X DVD-RAM	6,750 KB/sec			
1X BD-ROM	4,500 KB/sec			
1X BD-R read	4,500 KB/sec			
1X BD-RE read	4,500 KB/sec			
Transfer mode	Multiword DMA Mode			

Blu-ray Disc ROM Combo Drive

Applicable disc	Read:	Write:	
	CD-DA, CD+(E)G, CD-MIDI, CD-TEXT, CD-ROM, CD-ROM XA, MIXED MODE CD, CD-I, CD-I Bridge (Photo-CD, Video CD), Multisession CD (Photo-CD, CD-EXTRA, Portfolio, CD-R, CD-RW), CD-R, CD-RW, DVD-ROM (DVD-5, DVD-9, DVD-10, DVD-18), DVD-R, DVD-RW, DVD+R, DVD+RW, DVD-RAM, BD-ROM, BD-R, BD-RE	CD-R, CD-RW, DVD+R, DVD+R(9), DVD+RW, DVD-R, DVD-R(9), DVD-RW, DVD-RAM	
Access time	CD	DVD	BD-ROM
Random	<190 ms	<190 ms	<230 ms
Maximum Media Capacity (read)	50 GB		
Maximum Media Capacity (write)	8.5 GB		
Data transfer rate			
24X CD-ROM	3,600 KB/sec		
8X DVD	10,800 KB/sec		
16X CD-R	2,400 KB/sec		
10X CD-RW	1,500 KB/sec		
8X DVD+R	10,800 KB/sec		
8X DVD+RW	10,800 KB/sec		
8X DVD-R	10,800 KB/sec		
6X DVD-RW	8,100 KB/sec		
4X DVD+R Dual Layer	5,400 KB/sec		
4X DVD-R Dual Layer	5,400 KB/sec		
5X DVD-RAM	6,750 KB/sec		
2X BD-ROM	9,000 KB/sec		

DVD-ROM Drive specifications

Applicable disc	DVD-ROM (DVD-5, DVD-9, DVD-10, DVD-18, CD-ROM (Mode 1 and 2), CD Digital Audio, CD-XA ready (Mode 2, Form 1 and Form 2), CD-I (Mode 2, Form 1 and Form 2), CD-R, CD-RW, Photo CD (single and multisession), CD-Bridge	
Center hole diameter	1.5 cm (0.59 in)	
Disc diameter		
Standard disc	12 cm (4.72 in)	
Mini disc	8 cm (3.15 in)	
Disc thickness	1.2 mm (0.047 in)	
Track pitch	0.74 μ m	
Access time	CD	DVD
Random	< 100 ms	< 125 ms
Full stroke	< 175 ms	< 225 ms
Audio output level	Line-out, 0.7 Vrms	
Cache buffer	512 KB	
Data transfer rate		
CD-R (24X)	3600 KB/s (150 KB/s at 1X CD rate)	
CD-RW (10X)	1500 KB/s (150 KB/s at 1X CD rate)	
CD-ROM (24X)	3600 KB/s (150 KB/s at 1X CD rate)	
DVD (8X)	10,800 KB/s (1,352 KB/s at 1X DVD rate)	
Multiword DMA mode 2	16.6 MB/s	
Startup time	< 10 seconds	
Stop time	< 3 seconds	

Specification information in Device Manager

Device Manager allows you to view and control the hardware attached to the computer, as well as provides hardware specification information.

You can also add hardware or modify device configurations using Device Manager.

 **NOTE:** Windows 7 and Windows Vista include the User Account Control feature to improve the security of your computer. You may be prompted for your permission or password for tasks such as installing software, running utilities, or changing Windows settings. Refer to Windows Help and Support for more information.

After you open Device Manager, drill-down to a device and double-click it to access its properties.

To access Device Manager in Windows 7:

1. Select **Start > Computer > System properties**.
2. In the left pane, click **Device Manager**.

To access Device Manager in Windows Vista:

1. Select **Start > Computer > System properties**.
2. In the left pane, click **Device Manager**.

To access Device Manager in Windows XP:

1. Select **Start > My Computer**.
2. In the left pane of the System Tasks window, select **View system information**.
3. Select **Hardware** tab > **Device Manager**.

7 Backup and recovery

Windows 7

To protect your information, use Windows Backup and Restore to back up individual files and folders, back up your entire hard drive (select models only), create system repair discs (select models only), or create system restore points. In case of system failure, you can use the backup files to restore the contents of your computer.

Windows Backup and Restore provides the following options:

- Creating a system repair disc (select models only)
- Backing up individual files and folders
- Creating a system image (select models only)
- Scheduling automatic backups (select models only)
- Creating system restore points
- Recovering individual files
- Restoring the computer to a previous state
- Recovering information using recovery tools

 **NOTE:** For detailed instructions, perform a search for these topics in Help and Support.

NOTE: In case of system instability, HP recommends that you print the recovery procedures and save them for later use.

Backing up your information

Recovery after a system failure is as complete as your most current backup. You should create system repair discs (select models only) and your initial backup immediately after software setup. As you add new software and data files, you should continue to back up your system on a regular basis to maintain a reasonably current backup. The system repair discs (select models only) are used to start up (boot) the computer and repair the operating system in case of system instability or failure. Your initial and subsequent backups allow you to restore your data and settings if a failure occurs.

You can back up your information to an optional external hard drive, a network drive, or discs.

Note the following when backing up:

- Store personal files in the Documents library, and back it up regularly.
- Back up templates that are stored in their associated programs.

- Save customized settings that appear in a window, toolbar, or menu bar by taking a screen shot of your settings. The screen shot can be a time-saver if you have to reset your preferences.

To create a screen shot:

1. Display the screen you want to save.
2. Copy the screen image:

To copy only the active window, press **alt+fn+prt sc**.

To copy the entire screen, press **fn+prt sc**.

3. Open a word-processing document, and then select **Edit > Paste**.

The screen image is added to the document.

4. Save the document.

- When backing up to discs, use any of the following types of discs (purchased separately): CD-R, CD-RW, DVD+R, DVD+R DL, DVD-R, DVD-R DL, or DVD±RW. The discs you use will depend on the type of optical drive installed in your computer.

 **NOTE:** DVDs and DVDs with double-layer (DL) support store more information than CDs, so using them for backup reduces the number of recovery discs required.

- When backing up to discs, number each disc before inserting it into the optical drive of the computer.

To create a backup using Backup and Restore, follow these steps:

 **NOTE:** Be sure that the computer is connected to AC power before you start the backup process.

NOTE: The backup process may take over an hour, depending on file size and the speed of the computer.

1. Select **Start > All Programs > Maintenance > Backup and Restore**.
2. Follow the on-screen instructions to set up your backup, create a system image (select models only), or create a system repair disc (select models only).

 **NOTE:** Windows includes the User Account Control feature to improve the security of your computer. You may be prompted for your permission or password for tasks such as installing software, running utilities, or changing Windows settings. Refer to Windows Help and Support for more information.

Performing a recovery

In case of system failure or instability, the computer provides the following tools to recover your files:

- Windows recovery tools: You can use Windows Backup and Restore to recover information you have previously backed up. You can also use Windows Startup Repair to fix problems that might prevent Windows from starting correctly.
- **f11** recovery tools: You can use the **f11** recovery tools to recover your original hard drive image. The image includes the Windows operating system and software programs installed at the factory.

 **NOTE:** If you are unable to boot (start up) your computer and you cannot use the system repair discs you previously created (select models only), you must purchase a Windows 7 operating system DVD to reboot the computer and repair the operating system. For additional information, refer to the “Using a Windows 7 operating system DVD (purchased separately)” section in this guide.

Using the Windows recovery tools

To recover information you previously backed up, follow these steps:

1. Select **Start > All Programs > Maintenance > Backup and Restore**.
2. Follow the on-screen instructions to recover your system settings, your computer (select models only), or your files.

 **NOTE:** Windows includes the User Account Control feature to improve the security of your computer. You may be prompted for your permission or password for tasks such as installing software, running utilities, or changing Windows settings. Refer to Windows Help and Support for more information.

To recover your information using Startup Repair, follow these steps:

△ **CAUTION:** Using Startup Repair completely erases hard drive contents and reformats the hard drive. All files you have created and any software installed on the computer are permanently removed. When reformatting is complete, the recovery process restores the operating system, as well as the drivers, software, and utilities from the backup used for recovery.

1. If possible, back up all personal files.
2. If possible, check for the presence of the Windows partition and the HP Recovery partition.

To check for the Windows partition, select **Start > Computer**.

To check for the HP Recovery partition, select **Start**, right-click **Computer**, click **Manage**, and then click **Disk Management**.

 **NOTE:** If the Windows partition and the HP Recovery partition are not listed, you must recover your operating system and programs using the Windows 7 operating system DVD and the *Driver Recovery* disc (both purchased separately). For additional information, refer to the “Using a Windows 7 operating system DVD (purchased separately)” section in this guide.

3. If the Windows partition and the HP Recovery partition are listed, restart the computer, and then press **f8** before the Windows operating system loads.
4. Select **Startup Repair**.
5. Follow the on-screen instructions.

 **NOTE:** For additional information on recovering information using the Windows tools, perform a search for these topics in Help and Support.

Using f11

△ **CAUTION:** Using **f11** completely erases hard drive contents and reformats the hard drive. All files you have created and any software installed on the computer are permanently removed. The **f11** recovery tool reinstalls the operating system and HP programs and drivers that were installed at the factory. Software not installed at the factory must be reinstalled.

To recover the original hard drive image using **f11**, follow these steps:

1. If possible, back up all personal files.
2. If possible, check for the presence of the HP Recovery partition: select **Start**, right-click **Computer**, click **Manage**, and then click **Disk Management**.

 **NOTE:** If the HP Recovery partition is not listed, you must recover your operating system and programs using the Windows 7 operating system DVD and the *Driver Recovery* disc (both purchased separately). For additional information, refer to the “Using a Windows 7 operating system DVD (purchased separately)” section in this guide.

3. If the HP Recovery partition is listed, restart the computer, and then press **esc** while the “Press the ESC key for Startup Menu” message is displayed at the bottom of the screen.
4. Press **f11** while the “Press <F11> for recovery” message is displayed on the screen.
5. Follow the on-screen instructions.

Using a Windows 7 operating system DVD (purchased separately)

If you are unable to boot (start up) your computer and you cannot use the system repair discs you previously created (select models only), you must purchase a Windows 7 operating system DVD to reboot the computer and repair the operating system. Make sure that your most recent backup (stored on discs or on an external drive) is easily accessible. To order a Windows 7 operating system DVD, go to <http://www.hp.com/support>, select your country or region, and then follow the on-screen instructions. You can also order the DVD by calling technical support. For contact information, refer to the *Worldwide Telephone Numbers* booklet included with the computer.

△ **CAUTION:** Using a Windows 7 operating system DVD completely erases hard drive contents and reformats the hard drive. All files you have created and any software installed on the computer are permanently removed. When reformatting is complete, the recovery process helps you restore the operating system, as well as drivers, software, and utilities.

To initiate recovery using a Windows 7 operating system DVD, follow these steps:

 **NOTE:** This process takes several minutes.

1. If possible, back up all personal files.
2. Restart the computer, and then insert the Windows 7 operating system DVD into the optical drive before the Windows operating system loads.
3. When prompted, press any keyboard key.
4. Follow the on-screen instructions.
5. Click **Next**.
6. Select **Repair your computer**.
7. Follow the on-screen instructions.

Windows Vista

To protect your information, use the Backup and Restore Center to back up individual files and folders, back up your entire hard drive (select models only), or create system restore points. In case of system failure, you can use the backup files to restore the contents of your computer.

The Backup and Restore Center provides the following options:

- Backing up individual files and folders
- Backing up the entire hard drive (select models only)
- Scheduling automatic backups (select models only)
- Creating system restore points
- Recovering individual files
- Restoring the computer to a previous state
- Recovering information using recovery tools

 **NOTE:** For detailed instructions, perform a search for these topics in Help and Support.

NOTE: In case of system instability, HP recommends that you print the recovery procedures and save them for later use.

Backing up your information

Recovery after a system failure is as complete as your most current backup. You should create your initial backup immediately after software setup. As you add new software and data files, you should continue to back up your system on a regular basis to maintain a reasonably current backup.

You can back up your information to an optional external hard drive, a network drive, or discs.

Note the following when backing up:

- Store personal files in the Documents folder, and back it up regularly.
- Back up templates that are stored in their associated programs.
- Save customized settings that appear in a window, toolbar, or menu bar by taking a screen shot of your settings. The screen shot can be a time-saver if you have to reset your preferences.

To create a screen shot:

1. Display the screen you want to save.
2. Copy the screen image:
 - To copy only the active window, press **alt+fn+prt sc**.
 - To copy the entire screen, press **fn+prt sc**.
3. Open a word-processing document, and then select **Edit > Paste**.
 - The screen image is added to the document.
4. Save the document.

- When backing up to discs, use any of the following types of discs (purchased separately): CD-R, CD-RW, DVD+R, DVD+R DL, DVD-R, DVD-R DL, or DVD±RW. The discs you use will depend on the type of optical drive installed in your computer.

 **NOTE:** DVDs and DVDs with double-layer (DL) support store more information than CDs, so using them for backup reduces the number of recovery discs required.

- When backing up to discs, number each disc before inserting it into the optical drive of the computer.

To create a backup using Backup and Restore Center, follow these steps:

 **NOTE:** Be sure that the computer is connected to AC power before you start the backup process.

NOTE: The backup process may take over an hour, depending on file size and the speed of the computer.

1. Select **Start > All Programs > Maintenance > Backup and Restore Center**.
2. Follow the on-screen instructions to back up your entire computer (select models only) or your files.

 **NOTE:** Windows includes the User Account Control feature to improve the security of your computer. You may be prompted for your permission or password for tasks such as installing software, running utilities, or changing Windows settings. Refer to Windows Help and Support for more information.

Performing a recovery

In case of system failure or instability, the computer provides the following tools to recover your files:

- Windows recovery tools: You can use the Backup and Restore Center to recover information you have previously backed up. You can also use Windows Startup Repair to fix problems that might prevent Windows from starting correctly.
- **f11** recovery tools: You can use the **f11** recovery tools to recover your original hard drive image. The image includes the Windows operating system and software programs installed at the factory.

 **NOTE:** If you are unable to boot (start up) your computer, you must purchase a Windows Vista® operating system DVD to reboot the computer and repair the operating system. For additional information, refer to the “Using a Windows Vista operating system DVD (purchased separately)” section in this guide.

Using the Windows recovery tools

To recover information you previously backed up, follow these steps:

1. Select **Start > All Programs > Maintenance > Backup and Restore Center**.
2. Follow the on-screen instructions to recover your entire computer (select models only) or your files.

 **NOTE:** Windows includes the User Account Control feature to improve the security of your computer. You may be prompted for your permission or password for tasks such as installing software, running utilities, or changing Windows settings. Refer to Windows Help and Support for more information.

To recover your information using Startup Repair, follow these steps:

△ **CAUTION:** Using Startup Repair completely erases hard drive contents and reformats the hard drive. All files you have created and any software installed on the computer are permanently removed. When reformatting is complete, the recovery process restores the operating system, as well as the drivers, software, and utilities from the backup used for recovery.

1. If possible, back up all personal files.
2. If possible, check for the presence of the Windows partition and the HP Recovery partition. To find the partitions, select **Start > Computer**.

 **NOTE:** If the Windows partition and the HP Recovery partition have been deleted, you must recover your operating system and programs using the Windows Vista operating system DVD and the *Driver Recovery* disc (both purchased separately). For additional information, refer to the “Using a Windows Vista operating system DVD (purchased separately)” section in this guide.

3. Restart the computer, and then press **f8** before the Windows operating system loads.
4. Select **Repair your computer**.
5. Follow the on-screen instructions.

 **NOTE:** For additional information on recovering information using the Windows tools, perform a search for these topics in Help and Support.

Using f11

△ **CAUTION:** Using **f11** completely erases hard drive contents and reformats the hard drive. All files you have created and any software installed on the computer are permanently removed. The **f11** recovery tool reinstalls the operating system and HP programs and drivers that were installed at the factory. Software not installed at the factory must be reinstalled.

To recover the original hard drive image using **f11**, follow these steps:

1. If possible, back up all personal files.
2. If possible, check for the presence of the HP Recovery partition. To find the partition, select **Start > Computer**.

 **NOTE:** If the HP Recovery partition has been deleted, you must recover your operating system and programs using the Windows Vista operating system DVD and the *Driver Recovery* disc (both purchased separately). For additional information, refer to the “Using a Windows Vista operating system DVD (purchased separately)” section in this guide.

3. Turn on or restart the computer, and then press **esc** while the “Press the ESC key for Startup Menu” message is displayed at the bottom of the screen.
4. Press **f11** while the “Press <F11> for recovery” message is displayed on the screen.
5. Follow the on-screen instructions.

Using a Windows Vista operating system DVD (purchased separately)

If you are unable to boot (start up) your computer, you must purchase a Windows Vista operating system DVD to reboot the computer and repair the operating system. Make sure that your most recent backup (stored on discs or on an external drive) is easily accessible. To order a Windows Vista operating system DVD, go to <http://www.hp.com/support>, select your country or region, and then

follow the on-screen instructions. You can also order the DVD by calling technical support. For contact information, refer to the *Worldwide Telephone Numbers* booklet included with the computer.

△ **CAUTION:** Using a Windows Vista operating system DVD completely erases hard drive contents and reformats the hard drive. All files you have created and any software installed on the computer are permanently removed. When reformatting is complete, the recovery process helps you restore the operating system, as well as drivers, software, and utilities.

To initiate recovery using a Windows Vista operating system DVD, follow these steps:

 **NOTE:** This process takes several minutes.

1. If possible, back up all personal files.
2. Restart the computer, and then insert the Windows Vista operating system DVD into the optical drive before the Windows operating system loads.
3. When prompted, press any keyboard key.
4. Follow the on-screen instructions.
5. Click **Next**.
6. Select **Repair your computer**.
7. Follow the on-screen instructions.

Windows XP

To protect your information, use the Windows Backup utility (select models only) to back up files and folders or create recovery points. In case of system failure, you can use the backup files to restore your computer.

Windows provides the following options:

- Backing up individual files and folders
- Backing up all files and folders
- Scheduling automatic backups
- Creating recovery points
- Recovering information

 **NOTE:** For detailed instructions, perform a search for these topics in Help and Support.

NOTE: In case of system instability, HP recommends that you print the recovery procedures and save them for later use.

Backing up your information

Recovery after a system failure is as complete as your most current backup. You should create your initial backup immediately after software setup. As you add new software and data files, you should continue to back up your system on a regular basis to maintain a reasonably current backup.

You can back up individual files or folders to an optional external hard drive or to a network drive.

Note the following when backing up:

- Store personal files in the My Documents folder, and back it up periodically.
- Back up templates stored in their associated programs.
- Save customized settings that appear in a window, toolbar, or menu bar by taking a screen shot of your settings. The screen shot can be a time saver if you have to reset your preferences.

To copy the screen and paste it into a word-processing document:

- a. Display the screen you want to save.
- b. Copy the screen image:
 - To copy only the active window, press **alt+fn+prt sc**.
 - To copy the entire screen, press **fn+prt sc**.
- c. Open a word-processing document, click **Edit > Paste**.
 - The screen image is added to the document.
- d. Save the document.

To create a backup using the Windows Backup utility (select models only), follow these steps:

 **NOTE:** Be sure that the computer is connected to AC power before you start the backup process.

NOTE: The backup process may take over an hour, depending on file size and the speed of the computer.

1. Select **Start > All Programs > Accessories > System Tools > Backup**.
2. Follow the on-screen instructions.

Performing a recovery

In case of system failure or instability, the computer provides the following tools to recover your files:

- Windows recovery tools (select models only): You can use the Windows Backup utility to recover information you have previously backed up.
- *Operating System* and *Driver Recovery* discs (included with your computer): You can use the discs to recover your operating system and programs installed at the factory.

Recovering your information

To recover information you previously backed up, follow these steps:

1. If possible, back up all personal files.
2. Select **Start > All Programs > Accessories > System Tools > Backup**.
The Backup or Restore Wizard opens.
3. Click **Restore files and settings**, and then click **Next**.
4. Follow the on-screen instructions.

 **NOTE:** For additional information on initiating a recovery in Windows, perform a search for this topic in Help and Support.

Recovering the operating system and programs

△ **CAUTION:** The recovery process reformats and completely erases the hard drive. All files you have created and any software installed on the computer are permanently removed. The recovery process reinstalls the original operating system, software, and drivers. Software, drivers, and updates not installed by HP must be manually reinstalled.

To recover your operating system and programs, follow these steps:

1. If possible, back up all personal files.
2. Insert the *Operating System* disc into the optical drive.
3. Shut down the computer.
4. Turn on the computer.
5. Follow the on-screen instructions to install the operating system.
6. After the operating system is installed, remove the *Operating System* disc and insert the *Driver Recovery* disc.
7. Follow the on-screen instructions to install the drivers and programs.

8 Connector pin assignments

Audio-out (headphone)

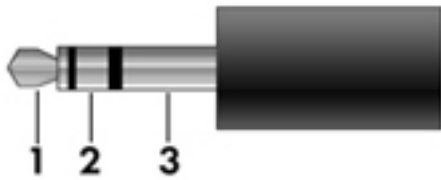

Pin	Signal
1	Audio out, left channel
2	Audio out, right channel
3	Ground

Audio-in (microphone)

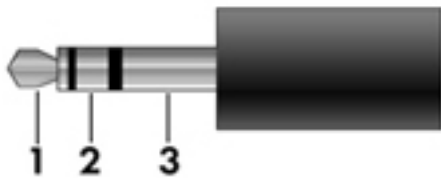

Pin	Signal
1	Audio signal in
2	Audio signal in
3	Ground

External monitor

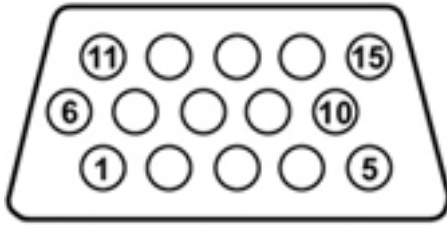

Pin	Signal
1	Red analog
2	Green analog
3	Blue analog
4	Not connected
5	Ground
6	Ground analog
7	Ground analog
8	Ground analog
9	+5 VDC
10	Ground
11	Monitor detect
12	DDC 2B data
13	Horizontal sync
14	Vertical sync
15	DDC 2B clock

RJ-11 (modem)

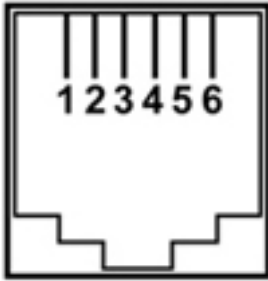

Pin	Signal
1	Unused
2	Tip
3	Ring
4	Unused
5	Unused
6	Unused

RJ-45 (network)

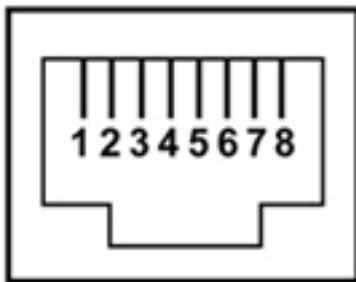

Pin	Signal
1	Transmit +
2	Transmit -
3	Receive +
4	Unused
5	Unused
6	Receive -
7	Unused
8	Unused

Universal Serial Bus

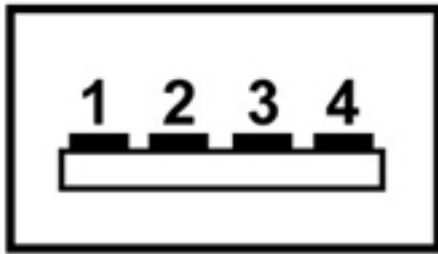

Pin	Signal
1	+5 VDC
2	Data -
3	Data +
4	Ground

9 Power cord set requirements

The wide range input feature of the computer permits it to operate from any line voltage from 100 to 120 volts AC, or from 220 to 240 volts AC.

The 3-conductor power cord set included with the computer meets the requirements for use in the country or region where the equipment is purchased.

Power cord sets for use in other countries and regions must meet the requirements of the country or region where the computer is used.

Requirements for all countries and regions

The requirements listed below are applicable to all countries and regions:

- The length of the power cord set must be at least 1.5 m (5.0 ft) and no more than 2.0 m (6.5 ft).
- All power cord sets must be approved by an acceptable accredited agency responsible for evaluation in the country or region where the power cord set will be used.
- The power cord sets must have a minimum current capacity of 10 amps and a nominal voltage rating of 125 or 250 V AC, as required by the power system of each country or region.
- The appliance coupler must meet the mechanical configuration of an EN 60 320/IEC 320 Standard Sheet C13 connector for mating with the appliance inlet on the back of the computer.

Requirements for specific countries and regions

Country/region	Accredited agency	Applicable note number
Australia	EANSW	1
Austria	OVE	1
Belgium	CEBC	1
Canada	CSA	2
Denmark	DEMKO	1
Finland	FIMKO	1
France	UTE	1
Germany	VDE	1
Italy	IMQ	1
Japan	METI	3
The Netherlands	KEMA	1
Norway	NEMKO	1
The People's Republic of China	CCC	5
South Korea	EK	4
Sweden	SEMKO	1
Switzerland	SEV	1
Taiwan	BSMI	4
The United Kingdom	BSI	1
The United States	UL	2

1. The flexible cord must be Type HO5VV-F, 3-conductor, 1.0-mm² conductor size. Power cord set fittings (appliance coupler and wall plug) must bear the certification mark of the agency responsible for evaluation in the country or region where it will be used.
2. The flexible cord must be Type SPT-3 or equivalent, No. 18 AWG, 3-conductor. The wall plug must be a two-pole grounding type with a NEMA 5-15P (15 A, 125 V) or NEMA 6-15P (15 A, 250 V) configuration.
3. The appliance coupler, flexible cord, and wall plug must bear a "T" mark and registration number in accordance with the Japanese Dentori Law. The flexible cord must be Type VCT or VCTF, 3-conductor, 1.00-mm² conductor size. The wall plug must be a two-pole grounding type with a Japanese Industrial Standard C8303 (7 A, 125 V) configuration.
4. The flexible cord must be Type RVV, 3-conductor, 0.75-mm² conductor size. Power cord set fittings (appliance coupler and wall plug) must bear the certification mark of the agency responsible for evaluation in the country or region where it will be used.
5. The flexible cord must be Type VCTF, 3-conductor, 0.75-mm² conductor size. Power cord set fittings (appliance coupler and wall plug) must bear the certification mark of the agency responsible for evaluation in the country or region where it will be used.

10 Recycling

Battery

When a battery has reached the end of its useful life, do not dispose of the battery in general household waste. Follow the local laws and regulations in your area for computer battery disposal.

Display

-
- ⚠ **WARNING!** The backlight contains mercury. Exercise caution when removing and handling the backlight to avoid damaging this component and causing exposure to the mercury.
 - ⚠ **CAUTION:** The procedures in this chapter can result in damage to display components. The only components intended for recycling purposes are the LCD panel and the backlight. When you remove these components, handle them carefully.
 - 📄 **NOTE: Materials Disposal.** This HP product contains mercury in the backlight in the display assembly that might require special handling at end-of-life. Disposal of mercury may be regulated because of environmental considerations. For disposal or recycling information, contact your local authorities, or see the Electronic Industries Alliance (EIA) Web site at <http://www.eiae.org>.
-

This section provides disassembly instructions for the display assembly. The display assembly must be disassembled to gain access to the backlight **(1)** and the liquid crystal display (LCD) panel **(2)**.



-
- 📄 **NOTE:** The procedures provided in this chapter are general disassembly instructions. Specific details, such as screw sizes, quantities, and locations, and component shapes and sizes, can vary from one computer model to another.
-

Perform the following steps to disassemble the display assembly:

1. Remove all screw covers (1) and screws (2) that secure the display bezel to the display assembly.

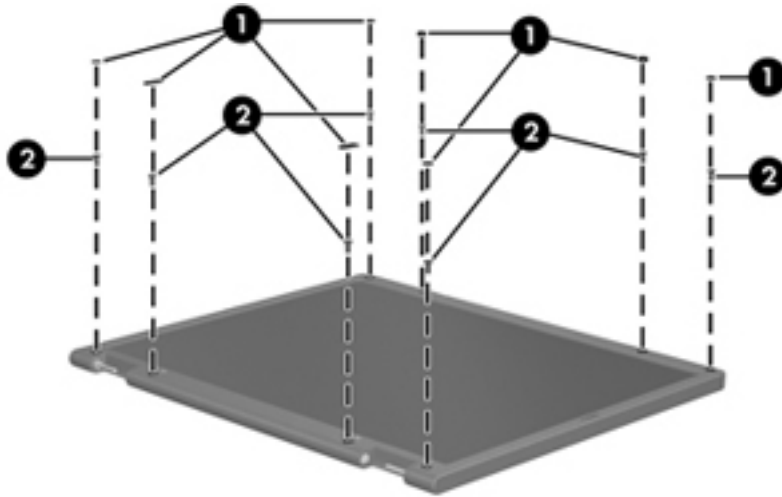

2. Lift up and out on the left and right inside edges (1) and the top and bottom inside edges (2) of the display bezel until the bezel disengages from the display assembly.
3. Remove the display bezel (3).

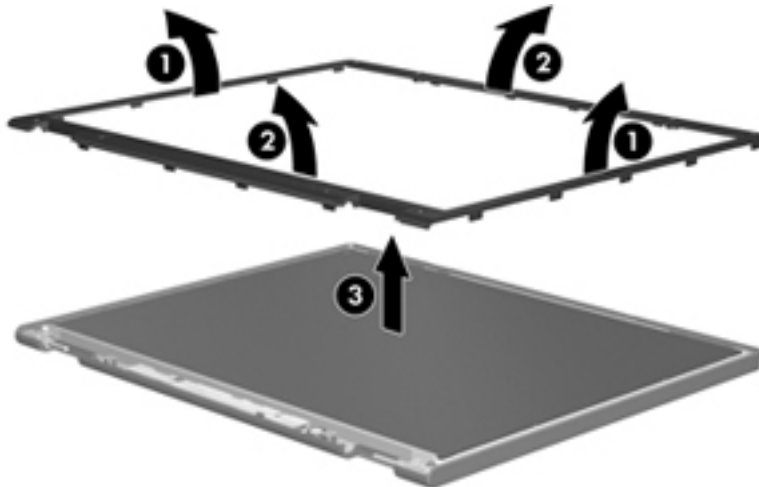

4. Disconnect all display panel cables (1) from the display inverter and remove the inverter (2).

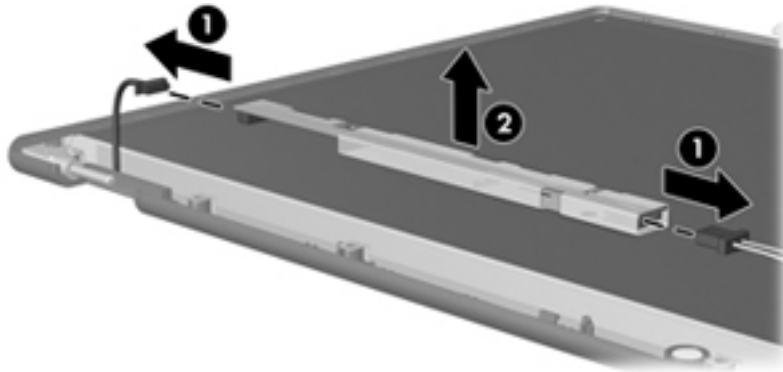

5. Remove all screws (1) that secure the display panel assembly to the display enclosure.
6. Remove the display panel assembly (2) from the display enclosure.

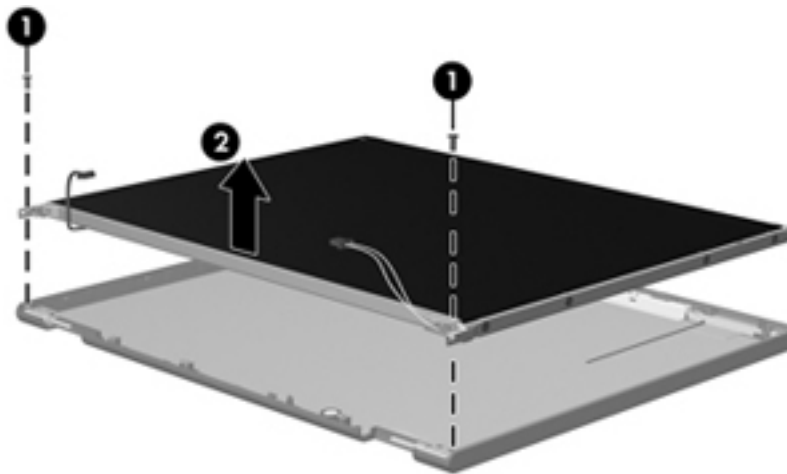

7. Turn the display panel assembly upside-down.
8. Remove all screws that secure the display panel frame to the display panel.

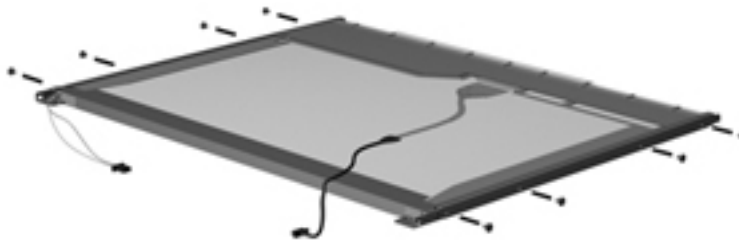

9. Use a sharp-edged tool to cut the tape (1) that secures the sides of the display panel to the display panel frame.

10. Remove the display panel frame (2) from the display panel.

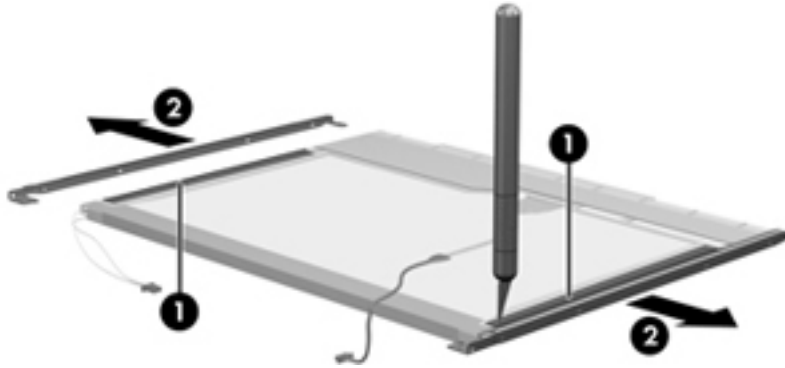

11. Remove the screws (1) that secure the backlight cover to the display panel.
12. Lift the top edge of the backlight cover (2) and swing it outward.

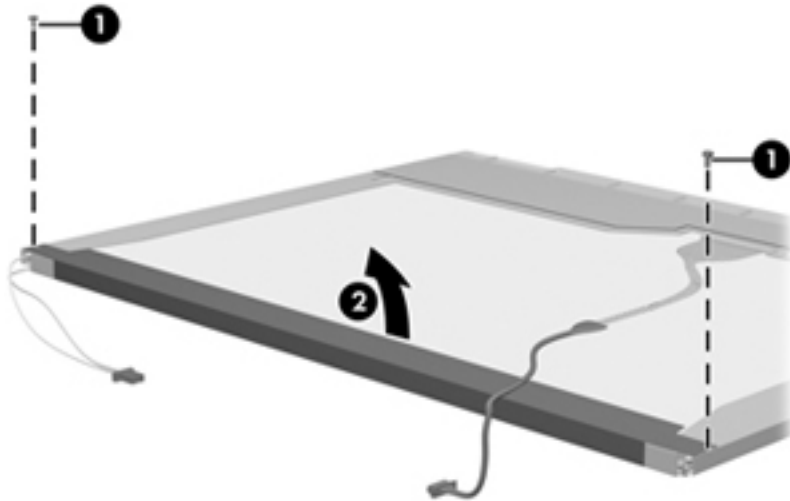

13. Remove the backlight cover.
14. Turn the display panel right-side up.

15. Remove the backlight cables (1) from the clip (2) in the display panel.

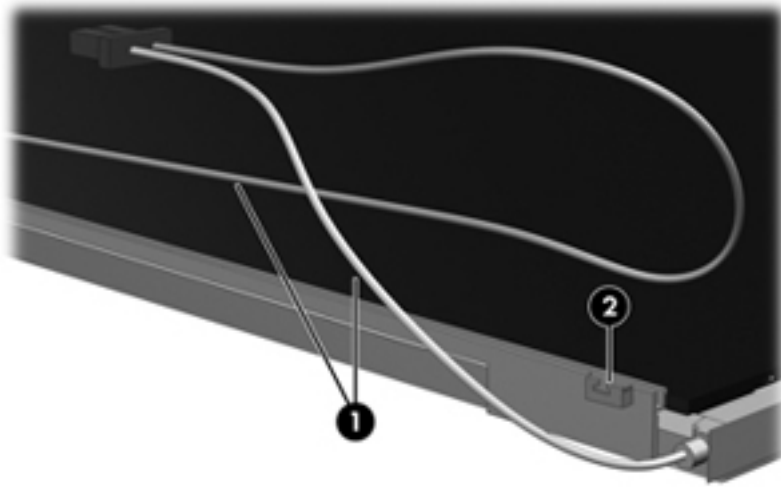

16. Turn the display panel upside-down.

⚠ WARNING! The backlight contains mercury. Exercise caution when removing and handling the backlight to avoid damaging this component and causing exposure to the mercury.

17. Remove the backlight frame from the display panel.

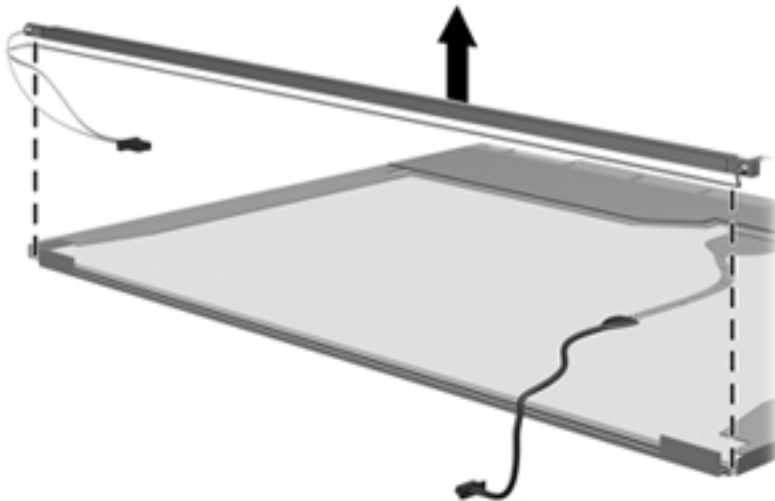

18. Remove the backlight from the backlight frame.

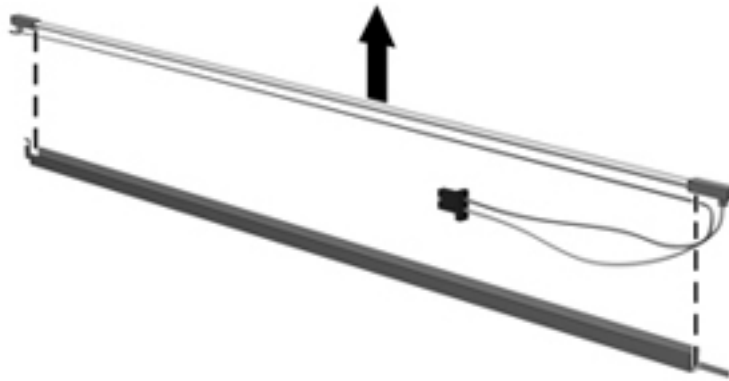

19. Disconnect the display panel cable (1) from the LCD panel.
20. Remove the screws (2) that secure the LCD panel to the display rear panel.
21. Release the LCD panel (3) from the display rear panel.
22. Release the tape (4) that secures the LCD panel to the display rear panel.

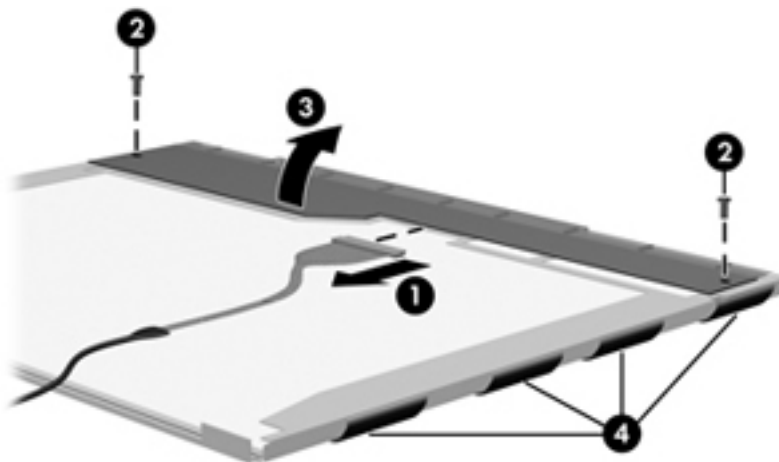

23. Remove the LCD panel.

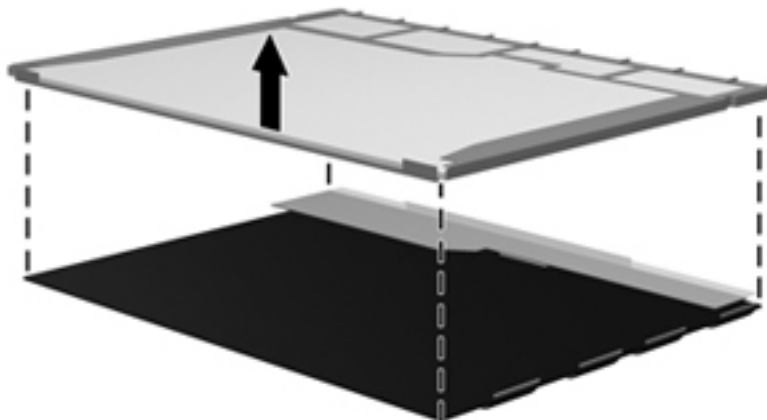

24. Recycle the LCD panel and backlight.

Index

Symbols/Numerics

1394 port, identifying 17

A

AC adapter, spare part
numbers 32, 33

ambient light sensor
identifying 9
removal 52
spare part number 37, 52

AMT options

AMT Setup Prompt (Ctrl-
P) 111

Firmware Progress Event
Support 111

Firmware Verbosity 111

Initiate Intel CIRA 111

Terminal Emulation Mode 111

Unconfigure AMT on next
boot 111

USB Key Provisioning
Support 111

antennas

disconnecting 63, 70

WLAN 20

WWAN 20

Anti Theft 107

applications key, Windows 15

audio, product description 3

audio-in (microphone) jack
identifying 17

pin assignments 132

audio-out (headphone) jack
identifying 17

pin assignments 132

B

backing up files 122

Backup and Restore 122, 123

Backup and Restore

Center 126, 127

base enclosure, spare part
number 26, 36

battery

removal 47

spare part number 26, 47

battery bay 19

battery latch kit, spare part
number 36

battery light 16

battery release latch 19

bays, hard drive 19

BIOS administrator

password 107

Blu-ray Disc ROM Drive,

specifications 119

Blu-ray Disc ROM with SuperMulti

DVD±R/RW DL Drive

removal 49

spare part

number 27, 31, 36, 49

specifications 118

Blu-ray ROM DVD±RW SuperMulti

DL Drive, spare part

number 27, 31, 36, 49

Bluetooth cable, illustrated 30

Bluetooth module

removal 57

spare part number 34

spare part numbers 27, 57

Bluetooth module cover,

illustrated 29

boot options 108

boot order 108

built-in device

Ambient Light Sensor 110

audio device 110

Bluetooth device radio 110

fingerprint reader 110

integrated camera 110

internal speakers 110

LAN/WLAN switching 110

microphone 110

modem 110

Network Interface Controller
(LAN) 110

Notebook Upgrade Bay 110

Power Monitor Circuit 110

Wake on LAN 110

wireless button 110

WLAN device radio 110

built-in device options 110

business card slot, identifying 17

buttons

display release 17

mute 14

pointing stick 10

power 13

QuickLook 13

QuickWeb 14

TouchPad 10, 14

volume 14

Wireless 14

C

Cable Kit

contents 30

spare part number 27, 30, 37

cables, service considerations 41

caps lock light, identifying 12

chipset, product description 1

components

bottom 19

display 9

front 16

left-side 17

rear 18

- right-side 18
- top 10
- computer feet
 - locations 46
 - spare part number 46
- Computer Setup
 - File menu 106
 - navigating and selecting 104
 - restoring factory settings 105
 - Security menu 107
 - System Configuration menu 108
- computer specifications 112
- connector, power 18
- connectors, service
 - considerations 41
- creating a backup 122

D

- device configurations 108
- discs
 - Driver Recovery 131
 - Operating System 131
- disk sanitizer 107
- diskette drive
 - precautions 41
 - product description 3
- display assembly
 - removal 52
 - spare part numbers 22, 35, 52
- display bezel
 - release 52
 - removal 84
 - spare part numbers 28, 36, 84
- display component recycling 138
- display components, spare part numbers 28
- display hinge
 - removal 86
 - spare part number 28, 36, 86
- display panel
 - product description 1
 - removal 85
- display release button, identifying 17
- display
 - specifications 113, 114, 115
- DisplayPort, identifying 17
- docking support, product description 5

- drive light 16
- DriveLock password 107
- DriveLock, automatic 107
- Driver Recovery disc 131
- drives
 - boot order 108
 - preventing damage 41
- DVD-ROM Drive
 - precautions 41
 - removal 49
 - spare part
 - number 27, 31, 36, 49
 - specifications 120
- DVD±RW and CD-RW SuperMulti DL Combo Drive with LightScribe
 - precautions 41
 - removal 49
 - spare part
 - number 27, 31, 36, 49

E

- electrostatic discharge 42
- eSata port, identifying 17
- esc key, identifying 15
- Ethernet, product description 3
- Execution Disable 108
- expansion memory module
 - removal 60
 - spare part numbers 60
- ExpressCard slot insert, illustrated 29
- ExpressCard slot, identifying 17
- ExpressCard/audio assembly
 - removal 92
 - spare part number 26, 37, 92
- external media cards, product description 4
- external monitor port
 - identifying 18
 - pin assignments 133

F

- f11 recovery 124, 128
- fan
 - removal 73
 - spare part number 24, 36, 73
- feet
 - illustrated 29
 - locations 46
 - spare part number 46

- File menu 106
- fingerprint reader board, spare part number 24, 37
- fingerprint reader, identifying 14
- fn key, identifying 15
- function keys, identifying 15

G

- graphics card
 - removal 79
 - spare part numbers 26, 38, 79
- graphics, product description 1
- grounding equipment and methods 44

H

- hard drive
 - precautions 41
 - product description 2
 - removal 54
 - spare part number 36
 - spare part
 - numbers 27, 31, 36, 54
 - specifications 116
- hard drive bay 19
- hard drive bracket, removal 56
- hard drive cover
 - illustrated 29
 - removal 55
- hard drive recovery 124, 128
- headphone (audio-out) jack
 - identifying 17
 - pin assignments 132
- heat sink
 - removal 75
 - spare part number 24, 36, 75
- hinge
 - removal 86
 - spare part number 28, 36, 86
- HP QuickLook 109
- HP SpareKey enrollment 107

I

- IEEE 1394 port, identifying 17
- Intel HT Technology 109
- internal display switch, identifying 9
- internal microphone, identifying 9

- J**
- jacks
 - audio-in (microphone) 17
 - audio-out (headphone) 17
 - RJ-11 (modem) 18
 - RJ-45 (network) 18
- K**
- keyboard
 - product description 5
 - removal 65
 - spare part numbers 23, 37, 65
- keyboard light, identifying 9
- keypad keys, identifying 15
- keys
 - esc 15
 - fn 15
 - function 15
 - keypad 15
 - Windows applications 15
 - Windows logo 15
- L**
- language, changing in Computer Setup 108
- latch, battery release 19
- legacy support, USB 104, 108
- lights
 - battery 16
 - caps lock 12
 - drive 16
 - keyboard 9
 - local area network (LAN) 16
 - mute 12
 - num lock 12
 - power 11, 16
 - QuickLook 12
 - QuickWeb 12
 - TouchPad 12
 - volume down 12
 - volume mute 12
 - volume up 12
 - webcam 9
 - wireless 11, 16
- M**
- mass storage devices, spare part numbers 31
- Media Card Reader, identifying 16
- memory module
 - product description 2
 - removal 60, 68
 - spare part number 68
 - spare part numbers 27, 60
- memory module compartment cover
 - illustrated 29
 - removal 58, 60
- microphone (audio-in) jack
 - identifying 17
 - pin assignments 132
 - product description 3
- model name 1
- modem jack, pin assignments 134
- modem module
 - product description 3
 - removal 91
 - spare part number 25, 34, 91
- monitor port
 - external 18
 - pin assignments 133
- Multi Core CPU 109
- mute button, identifying 14
- mute light, identifying 12
- N**
- network jack, pin assignments 134
- num lock light, identifying 12
- O**
- Operating System disc 131
- operating system, product description 5
- optical drive
 - precautions 41
 - product description 2
 - removal 49
 - spare part numbers 27, 31, 49
 - specifications 117, 118, 119, 120
- P**
- packing guidelines 43
- parallel port mode 108
- passwords 107
- pin assignments
 - audio-in jack 132
 - audio-out jack 132
 - external monitor port 133
 - headphone jack 132
 - microphone jack 132
 - modem jack 134
 - monitor port 133
 - network jack 134
 - RJ-11 134
 - RJ-45 jack 134
 - Universal Serial Bus (USB) port 135
- plastic parts 40
- Plastics Kit
 - contents 29
 - spare part number 29, 37
- pointing device, product description 5
- pointing stick buttons, identifying 10
- pointing stick, identifying 10
- port options
 - 1394 port 111
 - eSATA port 111
 - ExpressCard slot 111
 - flash media reader 111
 - parallel port 111
 - serial port 111
 - Smart Card slot 111
 - USB port 111
- ports
 - 1394 17
 - DisplayPort 17
 - eSATA 17
 - external monitor 18
 - product description 4
 - USB 17, 18
- power button, identifying 13
- power connector cable
 - removal 102
 - spare part numbers 102
- power connector cable, illustrated 30
- power connector, identifying 18
- power cord
 - set requirements 136
 - spare part numbers 32, 33
- power lights, identifying 11, 16
- power requirements, product description 5

- primary memory module
 - removal 68
 - spare part number 68
- processor
 - product description 1
 - removal 77
 - spare part numbers 24, 77
- product description
 - audio 3
 - chipset 1
 - diskette drive 3
 - display panel 1
 - docking support 5
 - Ethernet 3
 - external media cards 4
 - graphics 1
 - hard drives 2
 - keyboard 5
 - memory module 2
 - microphone 3
 - modem module 3
 - operating system 5
 - optical drives 2
 - pointing devices 5
 - ports 4
 - power requirements 5
 - processors 1
 - product name 1
 - security 5
 - serviceability 8
 - webcam 3
 - wireless 3
- product name 1
- Q**
 - QuickLook button, identifying 13
 - QuickLook light, identifying 12
 - QuickWeb button, identifying 14
 - QuickWeb light, identifying 12
- R**
 - recovery partition 124, 128
 - release latch, battery 19
 - removal/replacement
 - preliminaries 40
 - procedures 45
 - restore security defaults 111
 - restore the factory settings 106
 - restoring
 - hard drive 124, 128
 - RJ-11 (modem) jack
 - identifying 18
 - pin assignments 134
 - RJ-11 connector cable
 - illustrated 30
 - removal 98
 - RJ-45 (network) jack
 - identifying 18
 - pin assignments 134
 - RTC battery
 - removal 58
 - spare part number 26, 35, 58
 - Rubber Kit, spare part number 37
- S**
 - SATA (Serial Advanced Technology Attachment) devices
 - AHCI (Advanced Host Controller Interface) 108
 - IDE (Integrated Drive Electronics) 108
 - Screw Kit, spare part number 33, 37
 - scroll zone, TouchPad 10
 - Secondary Battery Fast Charge 109
 - security cable slot, identifying 18
 - Security menu
 - always prompt for HP SpareKey enrollment 107
 - Automatic DriveLock 107
 - change password 107
 - Disk Sanitizer 107
 - DriveLock 107
 - fingerprint reader reset 107
 - HP Sparekey 107
 - HP Sparekey enrollment 107
 - password policy 107
 - set up BIOS administrator password 107
 - System IDs 107
 - security, product description 5
 - service considerations 40
 - service tag 21, 45
 - serviceability, product description 8
 - set security level 111
 - setup utility
 - File menu 106
 - navigating and selecting 104
 - restoring factory settings 105
 - Security menu 107
 - System Configuration menu 108
 - SIM, removal 48
 - slots
 - business card 17
 - ExpressCard 17
 - security cable 18
 - smart card reader 18
 - smart card reader, identifying 18
 - solid-state drive, spare part numbers 27, 31, 36, 54
 - speaker assembly
 - identifying 16
 - removal 94
 - spare part number 26, 37, 94
 - specifications
 - Blu-ray Disc ROM Drive 119
 - Blu-ray Disc ROM with SuperMulti DVD±R/RW DL Drive 118
 - computer 112
 - display 113, 114, 115
 - DVD-ROM Drive 120
 - DVD±RW and CD-RW SuperMulti DL Combo Drive 117
 - hard drive 116
 - optical drive 117, 118, 119, 120
 - static-shielding materials 44
 - switch cover
 - removal 71
 - spare part number 23, 36, 71
 - system board
 - removal 96
 - spare part number 26
 - spare part numbers 36, 96
 - System Configuration menu 108
 - system date and time 106
 - system diagnostics 106
 - system fan 108
 - system IDs 107
 - system information 106
- T**
 - thermal material, replacement 76
 - tools required 40

- top cover
 - removal 87
 - spare part number 24, 87
 - spare part numbers 37
- TouchPad buttons,
 - identifying 10, 14
- TouchPad cable, illustrated 30
- TouchPad light, identifying 12
- TouchPad scroll zone,
 - identifying 10
- TouchPad, identifying 10
- TPM Embedded Security 107
- transporting guidelines 43
- TXT (Intel Trusted Execution Technology) 109

U

- Unified Extensible Firmware Interface (UEFI) mode 108
- Universal Serial Bus (USB) port,
 - pin assignments 135
- upgrade bay
 - identifying 18
 - removal 50
 - spare part number 50
- USB legacy support 104, 108
- USB ports, identifying 17, 18
- USB/VGA board
 - removal 100
 - spare part number 26, 100
 - spare part numbers 37
- User management 107

V

- vents, identifying 17, 19
- Virtualization Technology 109
- volume down button,
 - identifying 14
- volume down light, identifying 12
- volume mute button,
 - identifying 14
- volume mute light, identifying 12
- volume up button, identifying 14
- volume up light, identifying 12

W

- webcam
 - identifying 9
 - product description 3
 - spare part number 35
- webcam light, identifying 9

- Windows 7 operating system
 - DVD 125
- Windows applications key,
 - identifying 15
- Windows Backup utility 130, 131
- Windows logo key, identifying 15
- Windows recovery 131
- Windows Vista operating system
 - DVD 128
- wireless antennas
 - disconnecting 63, 70
 - location 20
- wireless button, identifying 14
- wireless light, identifying 11, 16
- wireless, product description 3
- WLAN antennas, identifying 20
- WLAN module
 - removal 69
 - spare part number 35, 69
 - spare part numbers 25
- workstation guidelines 43
- WWAN antennas, identifying 20
- WWAN cover
 - illustrated 29
 - removal 62
- WWAN module
 - removal 62
 - spare part number 26, 34, 62

