



E4331 V1
November 2008

VH236/VH232/VH202 Series LCD Monitor

User Guide

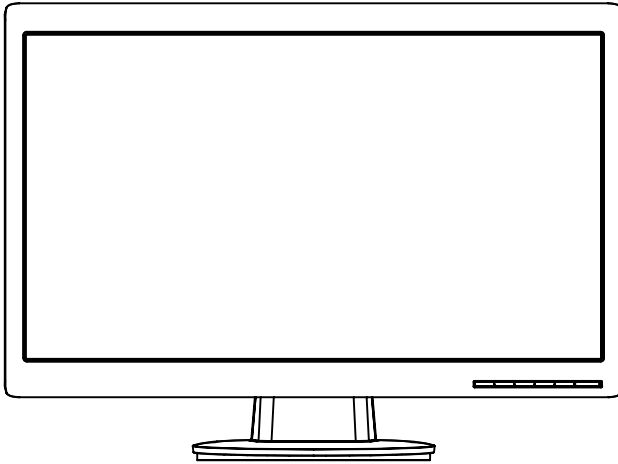

Table of contents

| | |
|--|------------|
| Notices | iii |
| Safety information | iv |
| Care & Cleaning | v |
| | |
| Chapter 1: Product introduction | |
| 1.1 Welcome! | 1-1 |
| 1.2 Package contents | 1-1 |
| 1.3 Assembling the monitor base | 1-2 |
| 1.5 Monitor introduction | 1-5 |
| 1.5.1 Front of the LCD monitor | 1-5 |
| 1.5.2 Rear of the LCD monitor | 1-9 |
| | |
| Chapter 2: Setup | |
| 2.1 Detaching the arm/stand (for VESA wall mount) | 2-1 |
| 2.2 Adjusting the monitor | 2-2 |
| | |
| Chapter 3: General Instruction | |
| 3.1 OSD (On-Screen Display) menu | 3-1 |
| 3.1.1 How to reconfigure | 3-1 |
| 3.1.2 OSD Function Introduction..... | 3-1 |
| 3.2 Specifications summary | 3-4 |
| 3.3 Troubleshooting (FAQ) | 3-7 |
| 3.4 Supported operating modes | 3-8 |
| 3.5 HDMI Supported Primary Timings | 3-9 |

Copyright © 2008 ASUSTeK COMPUTER INC. All Rights Reserved.

No part of this manual, including the products and software described in it, may be reproduced, transmitted, transcribed, stored in a retrieval system, or translated into any language in any form or by any means, except documentation kept by the purchaser for backup purposes, without the express written permission of ASUSTeK COMPUTER INC. ("ASUS").

Product warranty or service will not be extended if: (1) the product is repaired, modified or altered, unless such repair, modification of alteration is authorized in writing by ASUS; or (2) the serial number of the product is defaced or missing.

ASUS PROVIDES THIS MANUAL "AS IS" WITHOUT WARRANTY OF ANY KIND, EITHER EXPRESS OR IMPLIED, INCLUDING BUT NOT LIMITED TO THE IMPLIED WARRANTIES OR CONDITIONS OF MERCHANTABILITY OR FITNESS FOR A PARTICULAR PURPOSE. IN NO EVENT SHALL ASUS, ITS DIRECTORS, OFFICERS, EMPLOYEES OR AGENTS BE LIABLE FOR ANY INDIRECT, SPECIAL, INCIDENTAL, OR CONSEQUENTIAL DAMAGES (INCLUDING DAMAGES FOR LOSS OF PROFITS, LOSS OF BUSINESS, LOSS OF USE OR DATA, INTERRUPTION OF BUSINESS AND THE LIKE), EVEN IF ASUS HAS BEEN ADVISED OF THE POSSIBILITY OF SUCH DAMAGES ARISING FROM ANY DEFECT OR ERROR IN THIS MANUAL OR PRODUCT.

SPECIFICATIONS AND INFORMATION CONTAINED IN THIS MANUAL ARE FURNISHED FOR INFORMATIONAL USE ONLY, AND ARE SUBJECT TO CHANGE AT ANY TIME WITHOUT NOTICE, AND SHOULD NOT BE CONSTRUED AS A COMMITMENT BY ASUS. ASUS ASSUMES NO RESPONSIBILITY OR LIABILITY FOR ANY ERRORS OR INACCURACIES THAT MAY APPEAR IN THIS MANUAL, INCLUDING THE PRODUCTS AND SOFTWARE DESCRIBED IN IT.

Products and corporate names appearing in this manual may or may not be registered trademarks or copyrights of their respective companies, and are used only for identification or explanation and to the owners' benefit, without intent to infringe.

Notices

Federal Communications Commission Statement

This device complies with Part 15 of the FCC Rules. Operation is subject to the following two conditions:

- This device may not cause harmful interference, and
- This device must accept any interference received including interference that may cause undesired operation.

This equipment has been tested and found to comply with the limits for a Class B digital device, pursuant to Part 15 of the FCC Rules. These limits are designed to provide reasonable protection against harmful interference in a residential installation. This equipment generates, uses and can radiate radio frequency energy and, if not installed and used in accordance with manufacturer's instructions, may cause harmful interference to radio communications. However, there is no guarantee that interference will not occur in a particular installation. If this equipment does cause harmful interference to radio or television reception, which can be determined by turning the equipment off and on, the user is encouraged to try to correct the interference by one or more of the following measures:

- Reorient or relocate the receiving antenna.
- Increase the separation between the equipment and receiver.
- Connect the equipment to an outlet on a circuit different from that to which the receiver is connected.
- Consult the dealer or an experienced radio/TV technician for help.

As an Energy Star® Partner, our company has determined that this product meets the Energy Star® guidelines for energy efficiency.

Canadian Department of Communications Statement

This digital apparatus does not exceed the Class B limits for radio noise emissions from digital apparatus set out in the Radio Interference Regulations of the Canadian Department of Communications.

This class B digital apparatus complies with Canadian ICES-003.

Safety information

- Before setting up the monitor, carefully read all the documentation that came with the package.
- To prevent fire or shock hazard, never expose the monitor to rain or moisture.
- Never try to open the monitor cabinet. The dangerous high voltages inside the monitor may result in serious physical injury.
- If the power supply is broken, do not try to fix it by yourself. Contact a qualified service technician or your retailer.
- Before using the product, make sure all cables are correctly connected and the power cables are not damaged. If you detect any damage, contact your dealer immediately.
- Slots and openings on the back or top of the cabinet are provided for ventilation. Do not block these slots. Never place this product near or over a radiator or heat source unless proper ventilation is provided.
- The monitor should be operated only from the type of power source indicated on the label. If you are not sure of the type of power supply to your home, consult your dealer or local power company.
- Use the appropriate power plug which complies with your local power standard.
- Do not overload power strips and extension cords. Overloading can result in fire or electric shock.
- Avoid dust, humidity, and temperature extremes. Do not place the monitor in any area where it may become wet. Place the monitor on a stable surface.
- Unplug the unit during a lightning storm or if it will not be used for a long period of time. This will protect the monitor from damage due to power surges.
- Never push objects or spill liquid of any kind into the slots on the monitor cabinet.
- To ensure satisfactory operation, use the monitor only with UL listed computers which have appropriate configured receptacles marked between 100-240V AC.
- If you encounter technical problems with the monitor, contact a qualified service technician or your retailer.

Care & Cleaning

- Before you lift or reposition your monitor, it is better to disconnect the cables and power cord. Follow the correct lifting techniques when positioning the monitor. When lifting or carrying the monitor, grasp the edges of the monitor. Do not lift the display by the stand or the cord.
- Cleaning. Turn your monitor off and unplug the power cord. Clean the monitor surface with a lint-free, non-abrasive cloth. Stubborn stains may be removed with a cloth dampened with mild cleaner.
- Avoid using a cleaner containing alcohol or acetone. Use a cleaner intended for use with the LCD. Never spray cleaner directly on the screen, as it may drip inside the monitor and cause an electric shock.

The following symptoms are normal with the monitor:

- The screen may flicker during the initial use due to the nature of the fluorescent light. Turn off the Power Switch and turn it on again to make sure that the flicker disappears.
- You may find slightly uneven brightness on the screen depending on the desktop pattern you use.
- When the same image is displayed for hours, an afterimage of the previous screen may remain after switching the image. The screen will recover slowly or you can turn off the Power Switch for hours.
- When the screen becomes black or flashes, or cannot work anymore, contact your dealer or service center to fix it. Do not repair the screen by yourself!

Conventions used in this guide



WARNING: Information to prevent injury to yourself when trying to complete a task.



CAUTION: Information to prevent damage to the components when trying to complete a task.



IMPORTANT: Information that you **MUST** follow to complete a task.



NOTE: Tips and additional information to aid in completing a task.

Where to find more information

Refer to the following sources for additional information and for product and software updates.

1. ASUS websites

The ASUS websites worldwide provide updated information on ASUS hardware and software products. Refer to <http://www.asus.com>

2. Optional documentation

Your product package may include optional documentation, such as warranty card, that may have been added by your dealer. These documents are not part of the standard package.

1.1 Welcome!

Thank you for purchasing the ASUS® VH236/VH232/VH202 Series LCD monitor!

The latest widescreen LCD monitor from ASUS provides a crisper, broader, and brighter display, plus a host of features that enhance your viewing experience.

With these features, you can enjoy the convenience and delightful visual experience that the VH236/VH232/VH202 Series brings you!

1.2 Package contents

Check your VH236/VH232/VH202 Series LCD package for the following items:

- ✓ LCD monitor
- ✓ Monitor base
- ✓ Support CD
- ✓ Quick Start Guide
- ✓ Power cord
- ✓ VGA cable
- ✓ DVI cable (Only for some models)
- ✓ Audio cable (Only for some models)



If any of the above items is damaged or missing, contact your retailer immediately.

1.3 Assembling the monitor base

1.3.1 VH236/VH232

To assemble the monitor base:

1. Connect the base with the monitor. A click indicates that the base has been connected successfully.
2. Adjust the monitor to the angle that is most comfortable for you.



We recommend that you cover the table surface with soft cloth to prevent damage to the monitor.

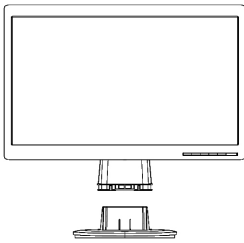

1

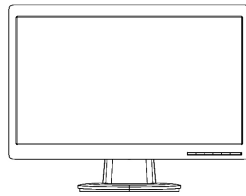

2

1.3.2 VH202

To assemble the monitor :

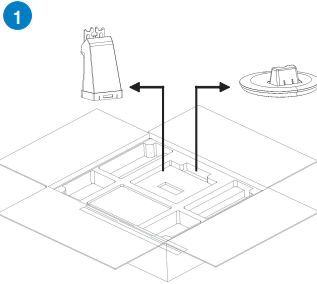

Open carton, take out base and stand.

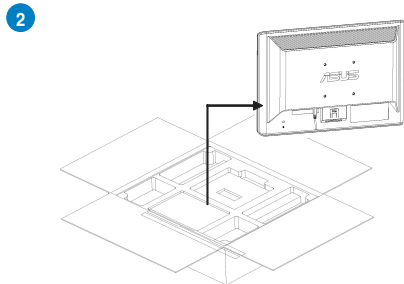

Remove cushion, take out monitor set

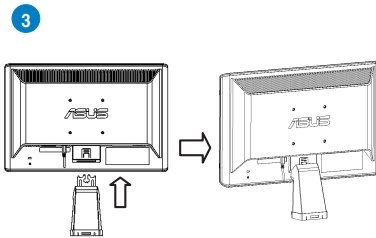

Assembly monitor with stand

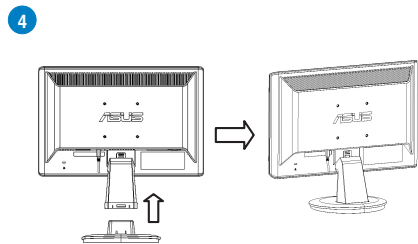

Assembly monitor with base

1.4 Connect cables

Connect cables which you need

1.4.1 VH236H/VH232H

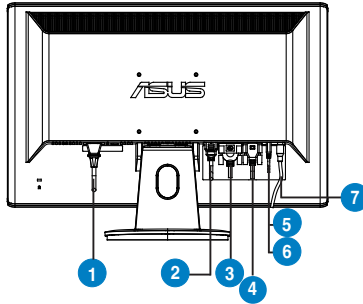

| | |
|---|---------------------|
| 1 | AC-IN port |
| 2 | HDMI-IN port |
| 3 | DVI port |
| 4 | VGA port |
| 5 | Line - in Port |
| 6 | Earphone - out Port |
| 7 | SPDIF Out |

1.4.2 VH236S/VH232T/VH232S/VH232D/VH202T/VH202N/VH202S/VH202D

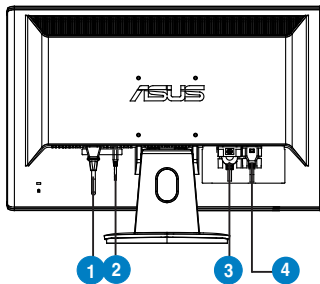

| | |
|---|---------------------------------------|
| 1 | AC-IN port |
| 2 | Line - in Port (Only for some models) |
| 3 | DVI port (Only for some models) |
| 4 | VGA port |

1.5 Monitor introduction

1.5.1 Front of the LCD monitor

1.5.1.1 VH236H/VH232H/VH232T/VH202T

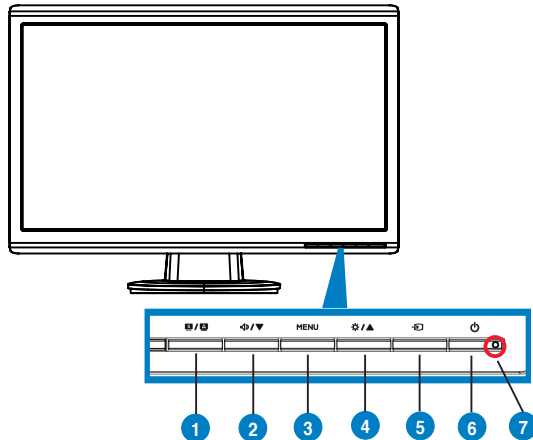

1. **S / A** button:
 - Automatically adjust the image to its optimized position, clock, and phase by long pressing this button for 2-4 seconds (for VGA mode only).
 - Use this hotkey to switch from five video preset modes (Game Mode, Night View Mode, Scenery Mode, Standard Mode, Theater Mode) with SPLENDID™ Video Enhancement Technology.
 - Exit the OSD menu or go back to the previous menu as the OSD menu is active.
2. **Speaker / ▼** Button:
 - Press this button to decrease the value of the function selected or move to the next function.
 - This is also a hotkey for Volume adjustment.
3. **MENU** Button:
 - Press this button to enter/select the icon (function) highlighted while the OSD menu is activated.
4. **Gear / ▲** Button:
 - Press this button to increase the value of the function selected or move to the previous function.
 - This is also a hotkey for Brightness adjustment.
5. **Input Select** Button
Use this hotkey to switch from VGA, DVI, HDMI input signal.
(for some models)





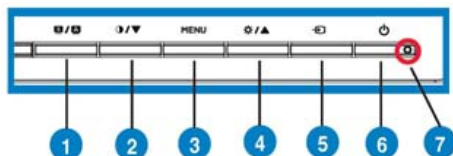

Press **Input Select** (Input Select Button) to display HDMI signals after you connect cable with monitor. (for VH236H and VH232H)

6.  Power button
 - Press this button to turn the monitor on/off.
7. Power indicator

1.5.1.2 VH202N



1. **S** button:
 - Use this hotkey to switch from five video preset modes (Game Mode, Night View Mode, Scenery Mode, Standard Mode, Theater Mode) with SPLENDID™ Video Enhancement Technology.
 - Exit the OSD menu or go back to the previous menu as the OSD menu is active.
- A** button:
 - Automatically adjust the image to its optimized position, clock, and phase by long pressing this button (for VGA mode only).
2.  Button:
 - Press this button to decrease the value of the function selected or move to the next function.
 - This is also a hotkey for Contrast Ratio adjustment.
3. MENU Button:
 - Press this button to enter/select the icon (function) highlighted while the OSD menu is activated.
4.  Button:
 - Press this button to increase the value of the function selected or move to the previous function.
 - This is also a hotkey for Brightness adjustment.
5.  Input Select Button
 - Use this hotkey to switch from VGA,DVI input signal.
6.  Power button
 - Press this button to turn the monitor on/off.
7. Power indicator

1.5.1.3 VH236S/VH232S/VH202S

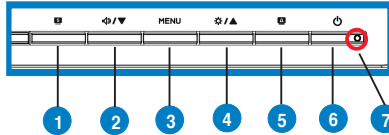

1. **S** button:
 - Use this hotkey to switch from five video preset modes (Game Mode, Night View Mode, Scenery Mode, Standard Mode, Theater Mode) with SPLENDID™ Video Enhancement Technology.
 - Exit the OSD menu or go back to the previous menu as the OSD menu is active.
2. **◀/▼** Button:
 - Press this button to decrease the value of the function selected or move to the next function.
 - This is also a hotkey for Volume adjustment.
3. **MENU** Button:
 - Press this button to enter/select the icon (function) highlighted while the OSD menu is activated.
4. **⚙/▲** Button:
 - Press this button to increase the value of the function selected or move to the previous function.
 - This is also a hotkey for Brightness adjustment.
5. **A** button:
 - Automatically adjust the image to its optimized position, clock, and phase by long pressing this button (for VGA mode only).
6. **⏻** Power button
 - Press this button to turn the monitor on/off.
7. Power indicator

1.5.1.4 VH232D/VH202D □ □

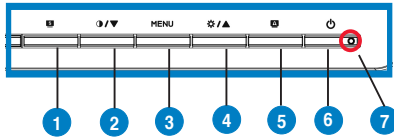

1. **S** button:
 - Use this hotkey to switch from five video preset modes (Game Mode, Night View Mode, Scenery Mode, Standard Mode, Theater Mode) with SPLENDID™ Video Enhancement Technology.
 - Exit the OSD menu or go back to the previous menu as the OSD menu is active.
2. **▼** Button:
 - Press this button to decrease the value of the function selected or move to the next function.
 - This is also a hotkey for Contrast Ratio adjustment.
3. MENU Button:
 - Press this button to enter/select the icon (function) highlighted while the OSD menu is activated.
4. **⚙** / **▲** Button:
 - Press this button to increase the value of the function selected or move to the previous function.
 - This is also a hotkey for Brightness adjustment.
5. **▲** button:
 - Automatically adjust the image to its optimized position, clock, and phase by long pressing this button (for VGA mode only).
6. **⏻** Power button
 - Press this button to turn the monitor on/off.
7. Power indicator

| Status | Description |
|--------|--------------|
| Blue | ON |
| Amber | Standby mode |
| OFF | OFF |

1.5.2 Rear of the LCD monitor

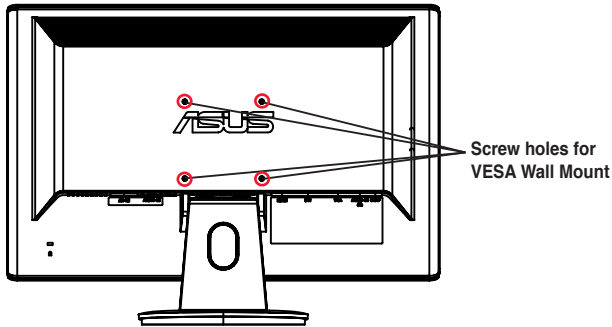

1.5.2.1 VH236H/VH232H□□

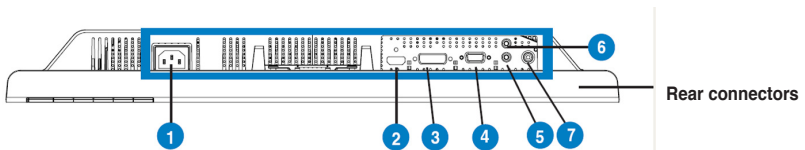

| | |
|---|---------------------|
| 1 | AC-IN port |
| 2 | HDMI-IN port |
| 3 | DVI port |
| 4 | VGA port |
| 5 | Line - in Port |
| 6 | Earphone - out Port |
| 7 | SPDIF Out |

1.5.2.2 VH236S/VH232T/VH232S/VH232D/VH202T/VH202S/VH202D

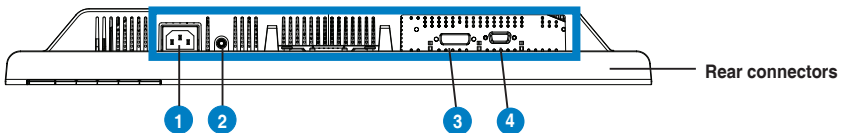

| | |
|---|---------------------------------------|
| 1 | AC-IN port |
| 2 | Line - in Port (Only for some models) |
| 3 | DVI port (Only for some models) |
| 4 | VGA port |

2.1 Detaching the arm/stand (for VESA wall mount)

The detachable stand of the VH236/VH232/VH202 Series LCD monitor is specially designed for VESA wall mount.

2.1.1 VH236/VH232

To detach the arm/stand:

1. Remove the arm cover.
2. Have the front of the monitor face down on a table.
3. Use a screwdriver to remove the three screws on the stand of the monitor as the below drawing shows.
4. Detach the arm from the monitor.



- We recommend that you cover the table surface with soft cloth to prevent damage to the monitor.
- Hold the stand of the monitor when you remove the screws.

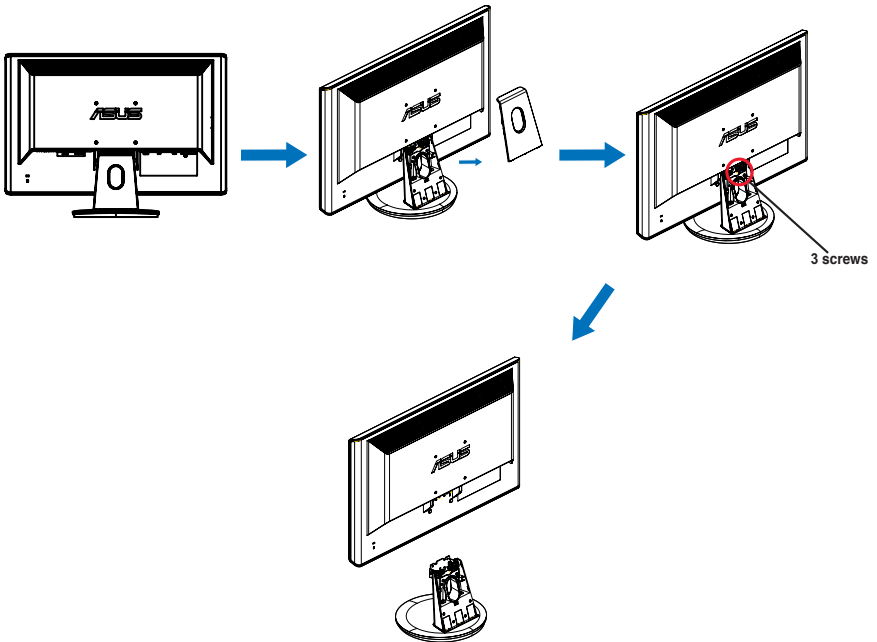

The VESA wall mount kit (100 mm x 100 mm) is purchased separately.

For use only with UL Listed Wall Mount Bracket with minimum weight/load 5.8Kg
(Screw size: 4mm x 12 mm)

2.1.2 VH202

To detach the arm/stand:

1. Have the front of the monitor face down on a table.
2. Press the release button.
3. Detach the arm from the monitor.



- We recommend that you cover the table surface with soft cloth to prevent damage to the monitor.

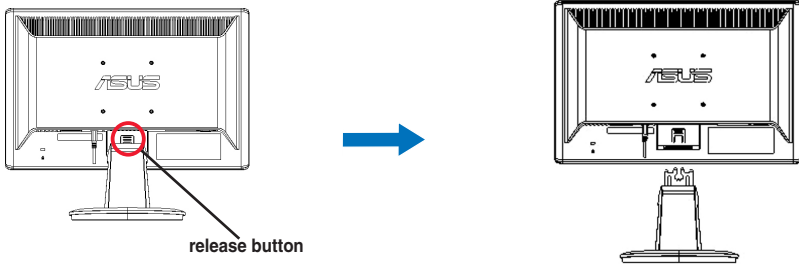

The VESA wall mount kit (100 mm x 100 mm) is purchased separately.

For use only with UL Listed Wall Mount Bracket with minimum weight/load 4.4 Kg
(Screw size: 4mm x 12 mm)

2.2 Adjusting the monitor

- For optimal viewing, we recommend that you look at the full face of the monitor, then adjust the monitor to the angle that is most comfortable for you.
- Hold the stand to prevent the monitor from falling when you change its angle.
- You can adjust the monitor's angle from -5° to 20° .

$-5^{\circ}\sim 20^{\circ}$

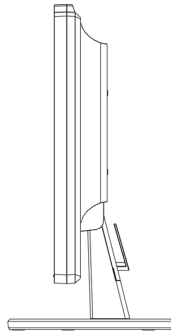

3.1 OSD (On-Screen Display) menu

3.1.1 How to reconfigure

1. Press the MENU button to activate the OSD menu.



2. Press ▼ and ▲ to navigate through the functions. Highlight and activate the desired function by pressing the MENU button. If the function selected has a sub-menu, press ▼ and ▲ again to navigate through the sub-menu functions. Highlight and activate the desired sub-menu function by pressing the MENU button.
3. Press ▼ and ▲ to change the settings of the selected function.
4. To exit the OSD menu, press the **S** button. Repeat step 2 and step 3 to adjust any other function.

3.1.2 OSD Function Introduction

1. Splendid

This function contains five sub-functions you can select for your preference. Each mode has the Reset selection, allowing you to maintain your setting or return to the preset mode.

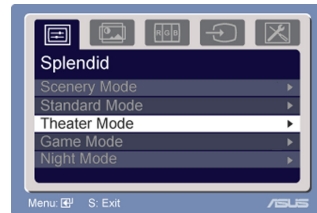

- **Scenery Mode:** best choice for scenery photo display with SPLENDID™ Video Enhancement.
- **Standard Mode:** best choice for document editing with SPLENDID™ Video Enhancement.
- **Theater Mode:** best choice for movie with SPLENDID™ Video Enhancement.
- **Game Mode:** best choice for game playing with SPLENDID™ Video Enhancement.
- **Night View Mode:** best choice for dark-scene game or movie with SPLENDID™ Video Enhancement.



- In the Standard Mode, the **Saturation** and ASCR functions are not user-configurable.
- In the other modes, the **sRGB** function is not user-configurable.

2. Image

You can adjust brightness, contrast, sharpness, saturation, position (VGA only), and focus (VGA only) from this main function.

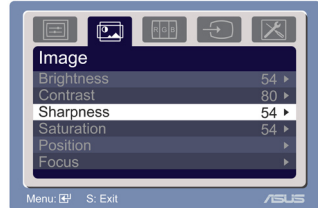

- Brightness: the adjusting range is from 0 to 100. + > is a hotkey to activate this function.
- Contrast: the adjusting range is from 0 to 100.
- Sharpness: the adjusting range is from 0 to 100.
- Saturation: the adjusting range is from 0 to 100.
- Position: adjusts the horizontal position (H-Position) and the vertical position (V-Position) of the image. The adjusting range is from 0 to 100.
- Focus: reduces Horizontal-line noise and Vertical-line noise of the image by adjusting (Phase) and (Clock) separately. The adjusting range is from 0 to 100.



- Phase adjusts the phase of the pixel clock signal. With a wrong phase adjustment, the screen shows horizontal disturbances.
- Clock (pixel frequency) controls the number of pixels scanned by one horizontal sweep. If the frequency is not correct, the screen shows vertical stripes and the image is not proportional.

3. Color

Select the image color you like from this function.

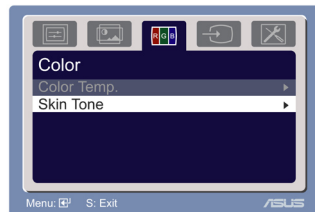

- Color Temp.: contains five color modes including Cool, Normal, Warm, sRGB, and User mode.
- Skin Tone: contains three color modes including Reddish, Natural, and Yellowish.



In the User mode, colors of R (Red), G (Green), and B (Blue) are user-configurable; the adjusting range is from 0-100.

4. Input Select

In this function, you can select VGA,DVI,HDMI input source.
(Only for some models)

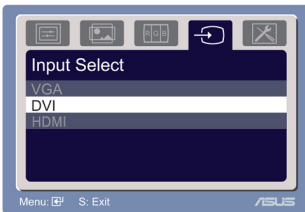

5. System Setup

Allow you to adjust the system.

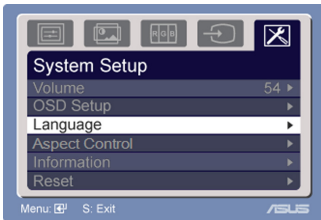

- Volume: the adjusting range is from 0 to 100. is a hotkey to activate this function.
- OSD Setup: adjusts the horizontal position (H-Position) and the vertical position (V-Position) of the OSD. The adjusting range is from 0 to 100. In the OSD Timeout selection, you can adjust the OSD timeout from 10 to 120.
- Language: there are ten languages for your selection, including English, German, Italian, French, Dutch, Spanish, Russian, Traditional Chinese, Simplified Chinese, Japanese, and Korean.
- Aspect Controls: adjusts the aspect ratio to “Full” or “4:3”.(for some models)
- Information: shows the monitor information.
- Reset: “Yes” allows you to revert to the preset mode.

3.2 Specifications summary

| Model | VH232H | VH232T | VH232S | VH232D |
|--------------------------|---------------------------|---------------------------|---------------------------|---------------------------|
| Panel Size | 23"W | 23"W | 23"W | 23"W |
| True Resolution | 1920x1080 | 1920x1080 | 1920x1080 | 1920x1080 |
| Brightness (Max.) | ≥ 300cd/m ² | ≥ 300cd/m ² | ≥ 300cd/m ² | ≥ 300cd/m ² |
| Intrinsic Contrast Ratio | ≥ 1000:1 | ≥ 1000:1 | ≥ 1000:1 | ≥ 1000:1 |
| Viewing Angle (CR=10) | ≥ 160°(V), ≥ 160°(H) | ≥ 160°(V), ≥ 160°(H) | ≥ 160°(V), ≥ 160°(H) | ≥ 160°(V), ≥ 160°(H) |
| Color Saturation (NTSC) | 72% | 72% | 72% | 72% |
| Display Colors | 16.7 M | 16.7 M | 16.7 M | 16.7 M |
| Response Time | 5ms (Tr+Tf) | 5ms (Tr+Tf) | 5ms (Tr+Tf) | 5ms (Tr+Tf) |
| Satellite Speaker | 2W x 2 stereo | 2W x 2 stereo | 2W x 2 stereo | - |
| HDMI input | HDMI | - | - | - |
| DVI input | DVI | DVI | - | - |
| D-Sub input | Yes | Yes | Yes | Yes |
| Audio Line-in | Yes | Yes | Yes | - |
| Earphone Output | Yes | - | - | - |
| SPIDIF output | Yes | - | - | - |
| Power ON | 50W | 50W | 50W | 50W |
| Tilt | +20° ~ -5° | +20° ~ -5° | +20° ~ -5° | +20° ~ -5° |
| VESA Wall Mounting | Yes (100mmx100mm) | Yes (100mmx100mm) | Yes (100mmx100mm) | Yes (100mmx100mm) |
| Phys. Dimension | 548.8x349.9x220 | 548.8x349.9x220 | 548.8x349.9x220 | 548.8x349.9x220 |
| Box Dimension (WxHxD) | 623x478x171 | 623x478x171 | 623x478x171 | 623x478x171 |
| Net Weight (Esti.) | 5.5 | 5.3 | 5.1 | 4.9 |
| Gross Weight (Esti.) | 7.3 | 7.0 | 6.7 | 6.5 |
| Voltage Rating | AC:100~240V (Built-in) | AC:100~240V (Built-in) | AC:100~240V (Built-in) | AC:100~240V (Built-in) |

3.2.1 Specifications summary



| | |
|---------------------------------|--|
| Model | VH236H |
| Panel Size | 23"W |
| True Resolution | 1920x1080 |
| Brightness (Max.) | $\cong 300\text{cd}/\text{m}^2$ |
| Intrinsic Contrast Ratio | $\cong 1000:1$ |
| Viewing Angle (CR=10) | $\cong 160^\circ(\text{V})$, $\cong 160^\circ(\text{H})$ |
| Color Saturation (NTSC) | 72% |
| Display Colors | 16.7 M |
| Response Time | 2ms |
| Satellite Speaker | 2W x 2 stereo |
| HDMI input | HDMI |
| DVI input | Yes |
| D-Sub input | Yes |
| Audio Line-in | Yes |
| Earphone Output | Yes |
| SPIDIF output | Yes |
| Power ON | 50W |
| Tilt | +20° ~ -5° |
| VESA Wall Mounting | Yes (100mmx100mm) |
| Phys. Dimension | 548.80x349.9x220 |
| Box Dimension (WxHxD) | 623x478x171 |
| Net Weight (Esti.) | 5.5 |
| Gross Weight (Esti.) | 7.3 |
| Voltage Rating | AC:100~240V (Built-in) |

3.2.2 Specifications summary

| Model | VH202T | VH202N | VH202S | VH202D |
|--------------------------|---|---|---|---|
| Panel Size | 20"W | 20"W | 20"W | 20"W |
| True Resolution | 1600x900 | 1600x900 | 1600x900 | 1600x900 |
| Brightness (Max.) | $\geq 250\text{cd}/\text{m}^2$ | $\geq 250\text{cd}/\text{m}^2$ | $\geq 250\text{cd}/\text{m}^2$ | $\geq 250\text{cd}/\text{m}^2$ |
| Intrinsic Contrast Ratio | $\cong 1000:1$ | $\cong 1000:1$ | $\cong 1000:1$ | $\cong 1000:1$ |
| Viewing Angle (CR=10) | $\geq 160^\circ(\text{V})$, $\geq 160^\circ(\text{H})$ | $\geq 160^\circ(\text{V})$, $\geq 160^\circ(\text{H})$ | $\geq 160^\circ(\text{V})$, $\geq 160^\circ(\text{H})$ | $\geq 160^\circ(\text{V})$, $\geq 160^\circ(\text{H})$ |
| Color Saturation (NTSC) | 72% | 72% | 72% | 72% |
| Display Colors | 16.7 M | 16.7 M | 16.7 M | 16.7 M |
| Response Time | 5ms (Tr+Tf) | 5ms (Tr+Tf) | 5ms (Tr+Tf) | 5ms (Tr+Tf) |
| Satellite Speaker | 1 W x 2 stereo | 1 W x 2 stereo | 1 W x 2 stereo | - |
| HDMI input | - | - | - | - |
| DVI input | DVI | DVI | - | - |
| D-Sub input | Yes | Yes | Yes | Yes |
| Audio Line-in | Yes | - | Yes | - |
| Earphone Output | Yes | - | - | - |
| SPIDIF output | Yes | - | - | - |
| Power ON | 45W | 45W | 45W | 45W |
| Tilt | +20° ~ -5° | +20° ~ -5° | +20° ~ -5° | +20° ~ -5° |
| VESA Wall Mounting | Yes (100mmx100mm) | Yes (100mmx100mm) | Yes (100mmx100mm) | Yes (100mmx100mm) |
| Phys. Dimensio | 481.3x387.5x205 | 481.3x387.5x205 | 481.3x387.5x205 | 481.3x387.5x205 |
| Box Dimension (WxHxD) | 552x391x140 | 552x391x140 | 552x391x140 | 552x391x140 |
| Net Weight (Esti.) | 4.4 | 4.4 | 4.2 | 4.0 |
| Gross Weight (Esti.) | 5.8 | 5.8 | 5.5 | 5.3 |
| Voltage Rating | AC:100~240V (Built-in) | AC:100~240V (Built-in) | AC:100~240V (Built-in) | AC:100~240V (Built-in) |

*Specifications are subject to change without notice.

3.3 Troubleshooting (FAQ)

| Problem | Possible Solution |
|--|--|
| Power LED is not ON | <ul style="list-style-type: none">• Press the  button to check if the monitor is in the ON mode.• Check if the power cord is properly connected to the monitor and the power outlet. |
| The power LED lights amber and there is no screen image | <ul style="list-style-type: none">• Check if the monitor and the computer are in the ON mode.• Make sure the signal cable is properly connected the monitor and the computer.• Inspect the signal cable and make sure none of the pins are bent.• Connect the computer with another available monitor to check if the computer is properly working. |
| Screen image is too light or dark | <ul style="list-style-type: none">• Adjust the Contrast and Brightness settings via OSD. |
| Screen image is not centered or sized properly | <ul style="list-style-type: none">• Press the  button for two seconds to automatically adjust the image.• Adjust the H-Position or V-Position settings via OSD. |
| Screen image bounces or a wave pattern is present in the image | <ul style="list-style-type: none">• Make sure the signal cable is properly connected to the monitor and the computer.• Move electrical devices that may cause electrical interference. |
| Screen image has color defects (white does not look white) | <ul style="list-style-type: none">• Inspect the signal cable and make sure that none of the pins are bent.• Perform Reset via OSD.• Adjust the R/G/B color settings or select the Color Temperature via OSD. |
| Screen image is blurry or fuzzy | <ul style="list-style-type: none">• Press the  button for two seconds to automatically adjust the image (for VGA mode only).• Adjust the Phase and Clock settings via OSD. |
| No sound or sound is low | <ul style="list-style-type: none">• Ensure that the audio cable is properly connected to the monitor and the computer• Adjust the volume settings of both your monitor and computer.• Ensure that the computer sound card driver is properly installed and activated. |

3.4 VH236/VH232/VH202 PC Supported Timing List

VESA Modes, Factory Preset Timings

| Mode | Resolution | H(KHz) | V(Hz) | Pixel(MHz) |
|--------|------------|--------|-------|------------|
| VGA | 640x480 | 31.469 | 60 | 25.175 |
| | 640x480 | 37.861 | 72 | 31.5 |
| | 640x480 | 37.5 | 75 | 31.5 |
| SVGA | 800x600 | 35.156 | 56 | 36 |
| | 800x600 | 37.879 | 60 | 40 |
| | 800x600 | 48.077 | 72 | 50 |
| | 800x600 | 46.875 | 75 | 49.5 |
| XGA | 1024x768 | 48.363 | 60 | 65 |
| | 1024x768 | 56.476 | 70 | 75 |
| | 1024x768 | 60.023 | 75 | 78.75 |
| SXGA | 1152x864 | 67.5 | 75 | 108 |
| | 1280x1024 | 63.981 | 60 | 108 |
| | 1280x1024 | 79.976 | 75 | 135 |
| WXGA+ | 1440x900 | 55.935 | 59 | 106.5 |
| WSXGA+ | 1600x900 | 67.5 | 75 | 97.75 |
| | 1680 x1050 | 65.29 | 60 | 146.25 |
| 1080P | 1920x1080 | 67.5 | 60 | 148.5 |

IBM Modes

| Mode | Resolution | H(KHz) | V(Hz) | Pixel(MHz) |
|------|------------|--------|-------|------------|
| DOS | 640x350 | 31.469 | 70 | 25.175 |
| | 720x400 | 31.469 | 70 | 28.322 |

MAC Modes

| Mode | Resolution | H(KHz) | V(Hz) | Pixel(MHz) |
|------|------------|--------|-------|------------|
| VGA | 640x480 | 35 | 67 | 30.24 |
| SVGA | 832x624 | 49.725 | 75 | 57.2832 |

VESA Modes ,User Available Timings

| Mode | Resolution | H(KHz) | V(Hz) | Pixel(MHz) |
|--------|------------|--------|-------|------------|
| 720P | 848x480 | 31.02 | 60 | 33.75 |
| | 1280x720 | 44.444 | 60 | 64 |
| | 1280x720 | 44.772 | 60 | 74.5 |
| | 1280x720 | 56.456 | 75 | 95.75 |
| WXGA | 1280x800 | 49.306 | 60 | 71 |
| | 1280x800 | 49.702 | 60 | 83.5 |
| | 1280x800 | 62.795 | 75 | 106.5 |
| WXGA+ | 1440x900 | 55.469 | 60 | 88.75 |
| | 1440x900 | 70.635 | 75 | 136.75 |
| | 1366x768 | 47.712 | 60 | 85.5 |
| WSXGA+ | 1680x1050 | 64.674 | 60 | 119 |
| 1080P | 1920x1080 | 66.587 | 60 | 138.5 |

3.5 VH236/VH232 HDMI **Supported Primary Timings**

| Mode | Resolution | H(KHz) | V(Hz) | Pixel(MHz) |
|-------|------------|---------------|------------|---------------|
| 480P | 640x480P | 31.469/31.5 | 59.94/60 | 25.175/25.2 |
| | 720x480P | 31.469 / 31.5 | 59.94 / 60 | 27 /27.027 |
| | 720x480P | 31.469 / 31.5 | 59.94 / 60 | 27 /27.027 |
| 576P | 720x576P | 31.25 | 50 | 27 |
| | 720x576P | 31.25 | 50 | 27 |
| 720P | 1280x720P | 37.5 | 50 | 74.25 |
| | 1280x720P | 44.955/45 | 59.94/60 | 74.176/74.25 |
| 1080i | 1920x1080i | 28.125 | 50 | 74.25 |
| | 1920x1080i | 33.716/33.75 | 59.94/60 | 74.176/74.25 |
| 1080P | 1920x1080P | 56.25 | 50 | 148.5 |
| | 1920x1080P | 67.433/67.5 | 59.94/60 | 148.352/148.5 |

* Modes not listed in the above tables may not be supported. For optimal resolution, we recommend that you choose a mode listed in the above tables