



LG

Life's Good

OWNER'S MANUAL LCOS PROJECTOR

Please read this manual carefully before operating your set and retain it for future reference.

CF181D

www.lg.com

LCOS PROJECTOR

Warning

This is a class B product. In a domestic environment this product may cause radio interference, in which case the user may be required to take adequate measures.

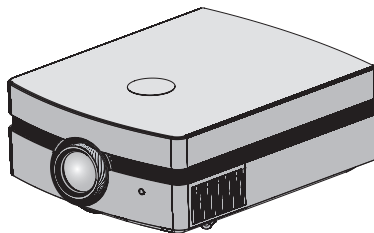

Contents

Safety Instructions 4

Names of parts

Main Body 7
 Connecting Part 8
 Control Panel..... 9
 Remote Control10
 Installing Batteries.....10
 Projector Status Indicators 11
 Accessories12
 Optional Extras.....12

Installing and Composition

Installation Precautions.....13
 Positioning the Projector.....14
 Kensington Security System15
 Turning on the Projector16
 Turning off the Projector16
 Focus and Position of the Screen Image.....17
 Selecting source mode17

Connection

Connecting to a Desktop PC18
 Connecting to a Video Source18
 Connecting to a DVD Player19
 Connecting to a D-TV Set-Top Box19

Function

PICTURE Menu Options

Picture mode.....20
 Adjusting Video20

ADV. PICTURE Menu Options

Auto Iris Function.....21
 TruMotion Demo Function21
 Advanced Control Function.....22
 Advanced Picture Reset Function23

SCREEN Menu Options

To Change PJT Mode24
 Using Aspect Ratio Function24
 Using Keystone Function25
 Test Pattern Function25
 Auto Configure Function.....25
 RGB Config. Function26
 Screen Reset Function.....26

OPTION Menu Options

Using the Still Function 27
 Selecting Language 27
 Using Blank Function.....27
 Selecting Blank image color28
 Sleep time Function28
 Auto sleep Function29
 Option Reset Function.....29

INFORMATION Menu Options

To See The Projector Information.....29

Information

Supported Monitor Display.....30
 Maintenance31
 Replacing the Lamp32
 Specifications35



Disposal of your old appliance

1. When this crossed-out wheeled bin symbol is attached to a product it means the product is covered by the European Directive 2002/96/EC.
2. All electrical and electronic products should be disposed of separately from the municipal waste stream via designated collection facilities appointed by your government or your local authorities.
3. The correct disposal of your old appliance will help prevent potential negative consequences for the environment and human health.
4. For more detailed information about disposal of your old appliance, please contact your city office, waste disposal service or the shop where you purchased the product.

Safety Instructions

Please take note of the safety instructions to prevent any potential accident or misuse of the projector.

- Safety Instructions are given in two forms as detailed below.

 **WARNING** : The violation of this instruction may cause serious injuries and even death.

 **NOTES** : The violation of this instruction may cause injuries or damage to the projector.

- After reading this manual, keep it in the place that you can access easily.

Indoor Installation WARNING

<p>Do not place the Projector in direct sunlight or near heat sources such as radiators, fires, stove etc.</p> <p>This may cause a fire hazard!</p>	<p>Do not place flammable materials in, on or near the projector.</p> <p>This may cause a fire hazard!</p>	<p>Do not hang on the installed projector.</p> <p>It may cause the projector to fall, causing injury or death.</p>
<p>Do not block the vents of the projector or restrict air-flow in any way.</p> <p>This would cause the internal temperature to increase and could cause a fire hazard or damage to the unit!</p>	<p>Do not place the projector close to sources of steam or oil such as a humidifier.</p> <p>This may create a fire hazard or an electric shock hazard!</p>	<p>Do not place the projector where it might be exposed to dust.</p> <p>This may cause a fire hazard or damage to the unit!</p>
<p>Do not use the projector in a damp place such as a bathroom where it is likely to get wet.</p> <p>This may cause a fire or an electric shock hazard!</p>	<p>Do not place the projector directly on a carpet, rug or place where ventilation is restricted.</p> <p>This would cause its internal temperature to increase and might create a fire hazard or damage the unit.</p>	<p>Ensure good ventilation around the projector. The distance between the projector and the wall should be more than 30 cm.</p> <p>An excessive increase in its internal temperature may cause a fire hazard or damage to the unit!</p>

Indoor Installation NOTES

<p>When installing the projector on a table, be careful not to place it near the edge.</p> <p>The projector could fall causing injury and damage to the projector. Only use a suitable stand.</p>	<p>Disconnect from the power supply and remove all connections before moving, or cleaning.</p>	<p>Only use the projector on a level and stable surface.</p> <p>It may fall and cause injury and/or damage to the unit.</p>
--------------------------------------------------------------------------------------------------------------------------------------------------------------------------------------------------------------	------------------------------------------------------------------------------------------------	-----------------------------------------------------------------------------------------------------------------------------

Power WARNING

<p>Earth wire should be connected.</p> <p>Ensure that you connect the earth ground wire to prevent possible electric shock (That is a Projector with a three-prong grounded AC plug must be connected to a three-prong grounded AC outlet). If grounding methods are not possible, have a qualified electrician install a separate circuit breaker. Do not try to ground the unit by connecting it to telephone wires, lightning rods, or gas pipes.</p>	<p>The power cord should be inserted fully into the power outlet to avoid a fire hazard!</p> <p>This may cause a fire hazard or damage the unit.</p>	<p>Do not place heavy objects on the power cord.</p> <p>This may cause a fire or an electric shock hazard!</p>
------------------------------------------------------------------------------------------------------------------------------------------------------------------------------------------------------------------------------------------------------------------------------------------------------------------------------------------------------------------------------------------------------------------------------------------------------------------	------------------------------------------------------------------------------------------------------------------------------------------------------	----------------------------------------------------------------------------------------------------------------

Power  **WARNING**

<p>Never touch the power plug with a wet hand.</p> <p>This may cause an electric shock hazard!</p>	<p>Do not plug-in too many items into one power outlet.</p> <p>It may result in overheating of the outlet and create a fire hazard!</p>	<p>Prevent dust from collecting on the power plug pins or outlet.</p> <p>This may cause a fire hazard!</p>
----------------------------------------------------------------------------------------------------	-----------------------------------------------------------------------------------------------------------------------------------------	------------------------------------------------------------------------------------------------------------

Power  **NOTES**

<p>Hold the plug firmly when unplugging. If you pull the cord, it may be damaged.</p> <p>This may cause a fire hazard!</p>	<p>Do not use if the power cord or the plug is damaged or any part of the power outlet is loose.</p> <p>This may cause a fire or an electric shock hazard or damage to the unit!</p>	<p>Ensure the power cord does not come into contact with sharp or hot objects.</p> <p>This may cause a fire or an electric shock hazard or damage to the unit!</p>
----------------------------------------------------------------------------------------------------------------------------	--------------------------------------------------------------------------------------------------------------------------------------------------------------------------------------	--------------------------------------------------------------------------------------------------------------------------------------------------------------------

<p>Place the projector where people will not trip or tread on the power cord.</p> <p>This may cause a fire or an electric shock hazard or damage to the unit!</p>	<p>Do not turn the projector On/Off by plugging-in or unplugging the power plug to the wall outlet. (Allow the unit to cool before removing power.)</p> <p>It may cause mechanical failure or could cause an electric shock.</p>
-------------------------------------------------------------------------------------------------------------------------------------------------------------------	----------------------------------------------------------------------------------------------------------------------------------------------------------------------------------------------------------------------------------

Using  **WARNING**

<p>Do not place anything containing liquid on top of the projector such as flowerpot, cup, cosmetics or candle.</p> <p>This may cause a fire hazard or damage to the unit!</p>	<p>In case of impact shock or damage to the projector switch it off and unplug it from the power outlet and contact an authorized service center.</p> <p>This may cause a fire or an electric shock hazard or damage to the unit!</p>	<p>Do not allow any objects to fall into the projector.</p> <p>This may cause an electric shock hazard or damage to the unit!</p>
--------------------------------------------------------------------------------------------------------------------------------------------------------------------------------	---------------------------------------------------------------------------------------------------------------------------------------------------------------------------------------------------------------------------------------	-----------------------------------------------------------------------------------------------------------------------------------

<p>If water is spilt into the projector unplug it from the power supply immediately and consult your Service Agent.</p> <p>This may cause an electric shock hazard or damage to the unit!</p>	<p>Dispose of used batteries carefully and safely.</p> <p>In the case of a battery being swallowed by a child please consult a doctor immediately.</p>
-----------------------------------------------------------------------------------------------------------------------------------------------------------------------------------------------	--------------------------------------------------------------------------------------------------------------------------------------------------------

<p>Do not remove any covers. High risk of Electric Shock!</p>	<p>Don't look directly into the lens when the projector is in use. Eye damage may occur!</p>	<p>Do not touch metal parts during or soon after operation since the vents will remain very hot!</p>
---------------------------------------------------------------	----------------------------------------------------------------------------------------------	------------------------------------------------------------------------------------------------------

CAUTION concerning the Power Cord

Do not overload wall outlets or circuit breakers. Overloaded wall outlets, loose or damaged wall outlets, extension cords, frayed power cords, or damaged or cracked wire insulation are dangerous. Any of these conditions could result in electric shock or fire. Periodically examine the cord of your appliance, and if its appearance indicates damage or deterioration, unplug it, discontinue use of the appliance, and have the cord replaced with an exact replacement part by authorized service personnel.

Protect the power cord from physical or mechanical abuse, such as being twisted, kinked, pinched, closed in a door, or walked upon. Pay particular attention to plugs, wall outlets, and the point where the cord exits the appliance.

Using  **WARNING**

<p>If the projector is in a room that experiences a gas leak, do not touch the projector.</p> <p>It can cause a fire or a burn by a spark.</p>	<p>Always open the lens door or remove the lens cap when the projector lamp is on.</p>
------------------------------------------------------------------------------------------------------------------------------------------------	----------------------------------------------------------------------------------------

Using  **NOTES**

<p>Do not place heavy objects on top of projector.</p> <p>This may cause mechanical failure or personal injury!</p>	<p>Take care not to impact the lens particularly when moving the projector.</p>	<p>Do not touch the lens of the projector. It is delicate and easily damaged.</p>
<p>Do not use any sharp tools on the projector as this will damage the casing.</p>	<p>In the event that an image does not appear on the screen please switch it off and unplug it from the power outlet and contact your Service Agent.</p> <p>This may cause a fire or an electric shock hazard or damage to the unit!</p>	<p>Do not drop the projector or allow impact shock.</p> <p>This may cause mechanical failure or personal injury!</p>

Cleaning  **WARNING**

<p>Do not use water while cleaning the projector.</p> <p>This may cause damage to the projector or an electric shock hazard.</p>	<p>In the unlikely event of smoke or a strange smell from the projector, switch it off, unplug it from the wall outlet and contact your dealer or service center.</p> <p>This may cause a fire or an electric shock hazard or damage to the unit!</p>	<p>Use an air spray or soft cloth that is moist with a neutral detergent and water for removing dust or stains on the projection lens.</p>
----------------------------------------------------------------------------------------------------------------------------------	-------------------------------------------------------------------------------------------------------------------------------------------------------------------------------------------------------------------------------------------------------	--------------------------------------------------------------------------------------------------------------------------------------------

Cleaning  **NOTES**

<p>Contact the Service Center once a year to clean the internal parts of the projector.</p> <p>Accumulated dust can cause mechanical failure.</p>	<p>When cleaning the plastic parts such as projector case, unplug the power and wipe it with a soft cloth. Do not use cleanser, spray water or wipe with a wet cloth. Especially, never use cleanser (glass cleaner), automobile or industrial shiner, abrasive or wax, benzene, alcohol etc., which can damage the product. Use an air spray or soft cloth that is moist with a neutral detergent and water for removing dust or stains on the projection lens.</p> <p>It can cause fire, electric shock or product damage (deformation, corrosion and damage).</p>
---------------------------------------------------------------------------------------------------------------------------------------------------	----------------------------------------------------------------------------------------------------------------------------------------------------------------------------------------------------------------------------------------------------------------------------------------------------------------------------------------------------------------------------------------------------------------------------------------------------------------------------------------------------------------------------------------------------------------------

Others  **WARNING**

<p>Do not attempt to service the projector yourself. Contact your dealer or service center.</p> <p>This may cause damage to the projector and could give an electric Shock as well as invalidating the warranty!</p>

Others  **NOTES**

<p>Do not mix new batteries with old batteries.</p> <p>This may cause the batteries to over-heat and leak.</p>	<p>Be sure to unplug if the projector is not to be used for a long period.</p> <p>Accumulated dust may cause a fire hazard or damage to the unit!</p>	<p>Only use the specified type of battery.</p> <p>This could cause damage to the remote control.</p>
<p>Refer lamp servicing to qualified service personnel.</p>		

Names of parts

Main Body

* The projector is manufactured using high-precision technology. You may, however, see on the Projector screen tiny black points and/or bright points (red, blue, or green). This can be a normal result of the manufacturing process and does not always indicate a malfunction.

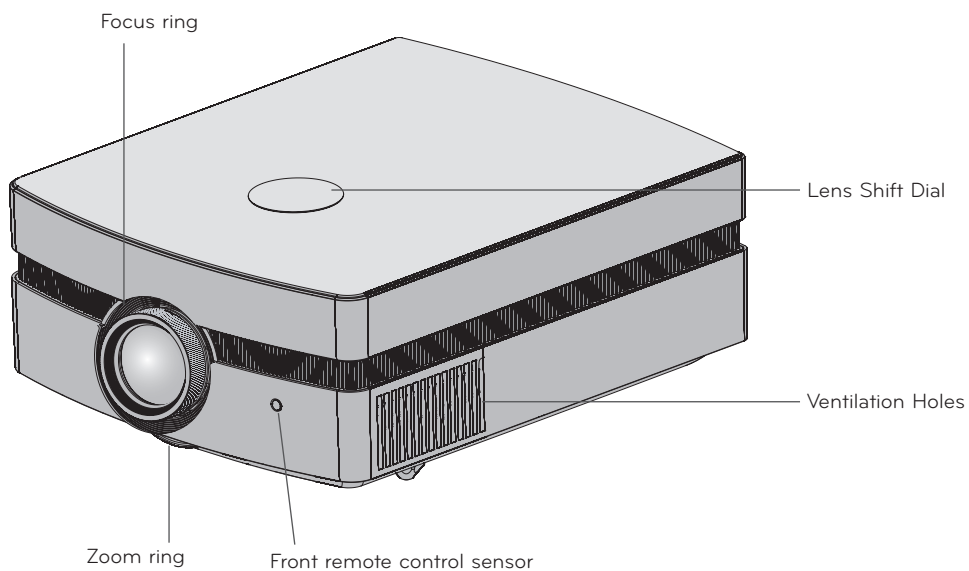

Connecting Part

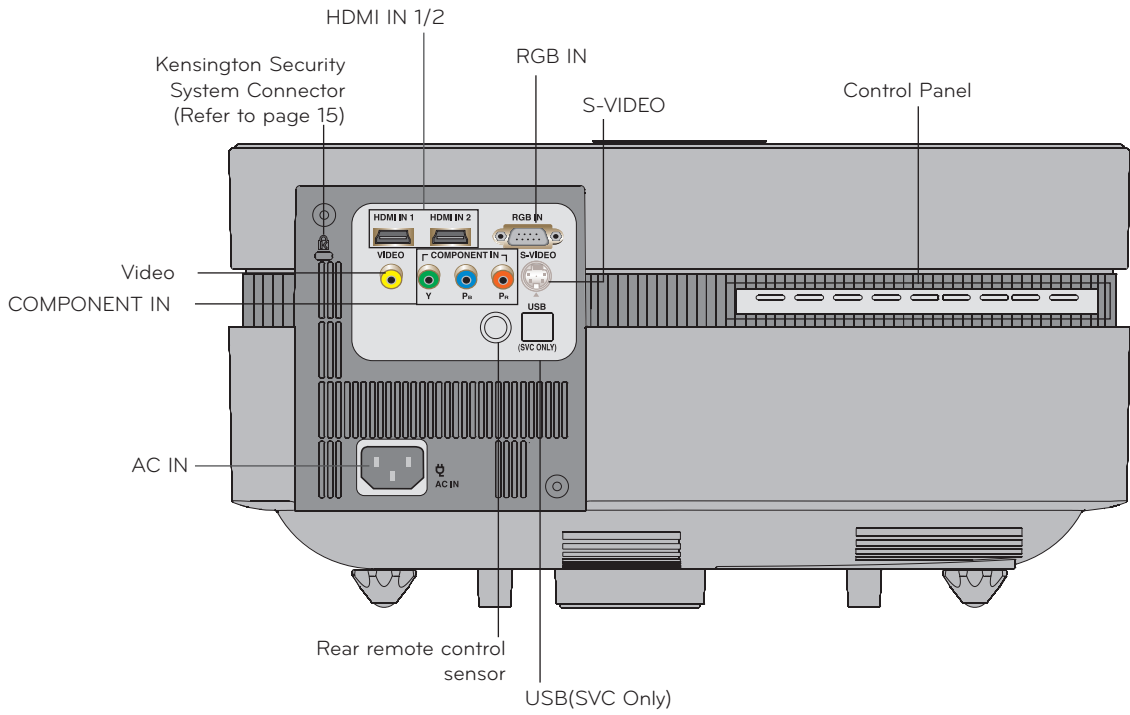

Control Panel

POWER Button

Turn On/Off the projector.

INPUT Button

Switches to RGB, HDMI, Video, S-Video or Component mode.



OK Button

Checks present mode and saves the function changes.

^/v/</> Button

Adjusts functions of menus

MENU Button

Selects or closes menus.

AUTO Button

It automatically corrects the position and shaking of the image in RGB mode.

Remote Control

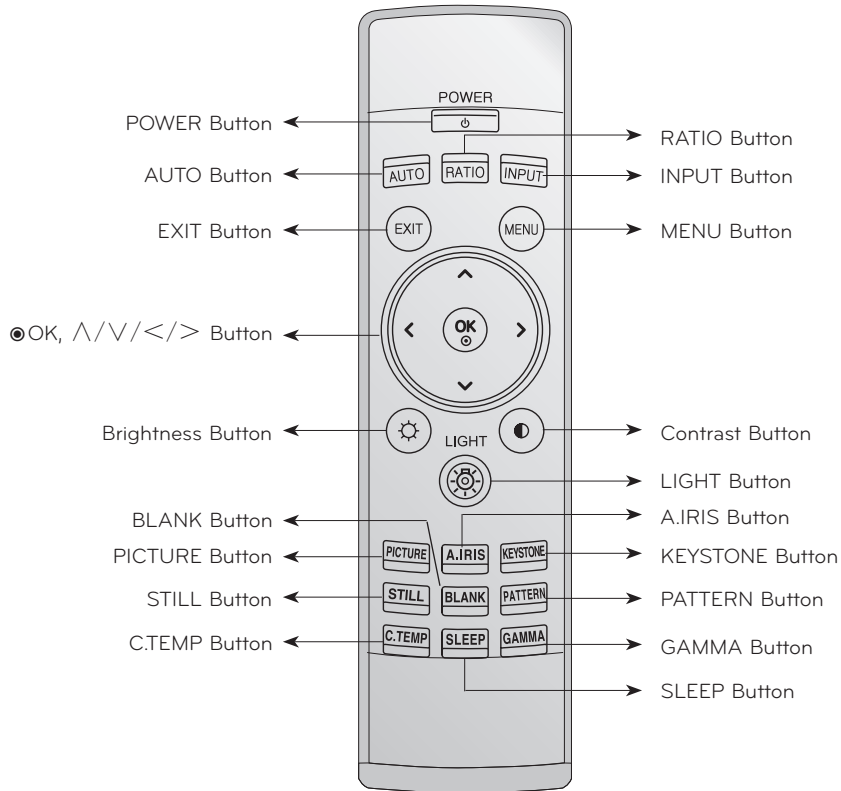

Installing Batteries

CAUTION
RISK OF EXPLOSION IF BATTERY IS REPLACED WITH AN INCORRECT TYPE.
DISPOSE OF USED BATTERIES ACCORDING TO THE INSTRUCTIONS.

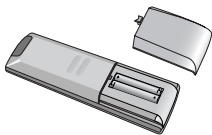

- Open the battery compartment cover on the back of the remote control.
- Insert the specified type of batteries with correct polarity, match "+" with "+", and match "-" with "-".
- Install two 1.5V AAA batteries. Don't mix used batteries with new batteries.

Projector Status Indicators

* Lamp indicator, operation indicator and temperature indicator at the top of the projector show the user the operating status of the projector.

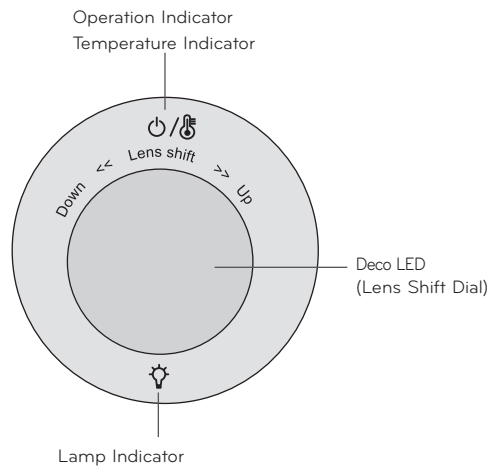
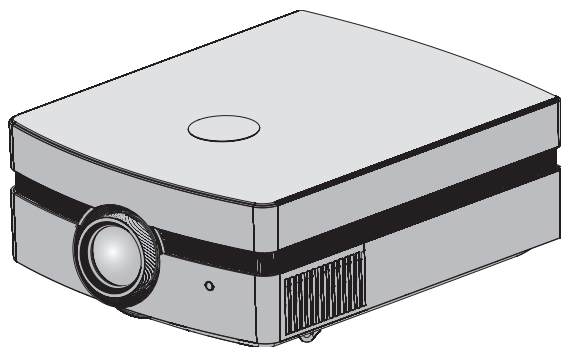

Operation Indicator / Temperature Indicator	Red	Standby.
	Green	Unit is in operation (Lamp is turned on)
	Orange (flashing)	The lamp is cooling (60 seconds).
	Green (flashing)	The projector has been turned off due to excessive heat (60 seconds).
	Off	Power off.
	Orange	This is the warning message of excessive heat when the projector is on. Turn the projector off and check the ventilator.
Lamp Indicator	Red (flashing)	Power has turned off due to problem with the internal cooling fan. Contact your service center.
	Red	Projector lamp is reaching the end of its life and needs to be replaced with a new lamp.
	Red (flashing)	An error has occurred in the projector lamp. Turn the projector on again after sufficient amount of time. If this indicator flashes red again, contact your local service center.
Deco LED (Lens Shift Dial)	Green (flashing)	The lamp cover and filter cover is opened.
	Blue (flashing)	Lamp is starting up.

Accessories



Remote Control



AAA Battery

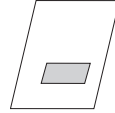

Owner's manual

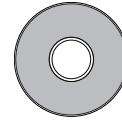

CD Owner's manual



Power Cord



Polishing Cloth



Filter

Optional Extras

* Contact your dealer to purchase these items.

* The lamp is consumable and needs to be replaced with a new one when it is burned out. Contact your dealer or service center for a replacement lamp.

* Optional parts can be changed without notice to improve the quality of the product, and new optional parts can be added.

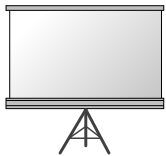

Projection Screen

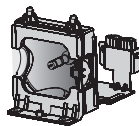

Lamp



SCART to RCA jack



S-Video Cable

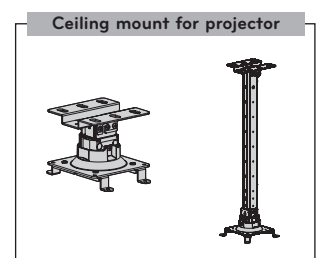

Ceiling mount for projector



HDMI Cable



Component Cable



Computer Cable



Video Cable

Installing and Composition

Installation Precautions

Provide proper ventilation for this projector.

- The projector is equipped with ventilation holes(intake) on the bottom and ventilation holes(exhaust) on the front. Do not block or place anything near these holes. Internal heat build-up may occur, causing picture degradation or damage to the projector.
- Do not place the projector on a carpet, rug or other similar surface. It may prevent a adequate ventilation of the projector bottom. This product should be mounted to a wall or ceiling only.

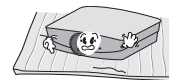
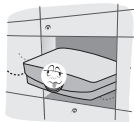

- Never push projector or spill any kind of liquid into the projector.
- Leave an adequate distance (30 cm or more) around the projector.

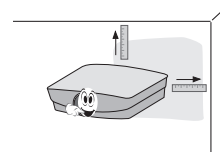

Place this projector in adequate temperature and humidity conditions.

- Install this projector only in a location where adequate temperature and humidity is available. (Refer to page 35)

Don't place the projector where it can be covered with dust.

- This may cause overheating of the projector.

Do not obstruct the slots and openings of the projector. This may cause overheating and create a fire hazard.

This projector is manufactured using high-precision technology. You may, however, see tiny black points and/or bright points (red, blue or green) that continuously appear on the projector Screen. This is a normal result of the manufacturing process and does not indicate a malfunction.

To display DTV programs, it is necessary to purchase a DTV receiver (Set-top Box) and connect it to the projector.

The remote control may not work when a lamp equipped with electronic ballast or a three-wavelength lamp is installed. Replace those lamps with international standard products to use the remote control normally.

Positioning the Projector

1. Place the projector on a sturdy and horizontal surface.
2. Place the projector the desired distance from the screen. The distance between the projector and the screen determines the actual size of the image.
3. Position the projector so that the lens is set at a right angle to the screen. If the projector is not set at a right angle, the screen image will be crooked. Although, slight angles can be counteracted using the Keystone adjustment. (Refer to page 25.).
4. Connect the power cable to the projector and the wall outlet after placing the projector in its desired location.

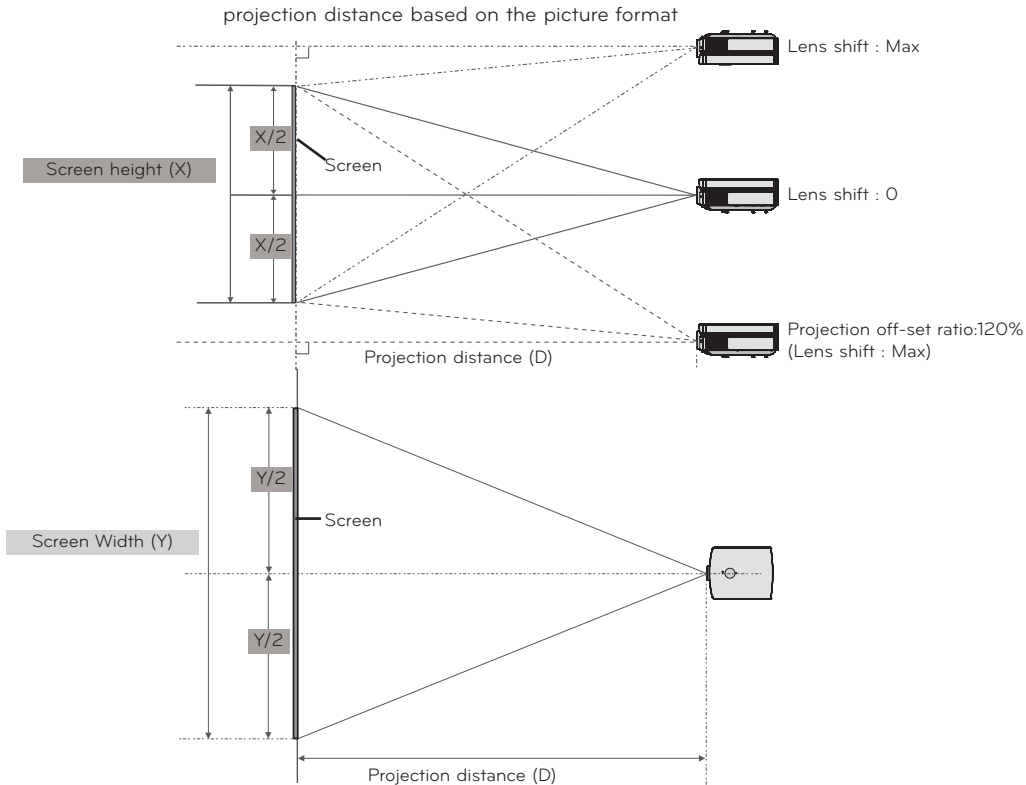

16 : 9 Scale					
Screen				Projection Distance	
Diagonal Size (inch)	Diagonal Size (mm)	Horizontal Size (mm)	Vertical Size (mm)	Shortest Distance (mm)	Longest Distance (mm)
30	762	664	374	877	1605
40	1016	886	498	1181	2152
50	1270	1107	623	1484	2699
60	1524	1328	747	1788	3246
70	1778	1550	872	2092	3794
80	2032	1771	996	2395	4341
90	2286	1992	1121	2699	4888
100	2540	2214	1245	3003	5435
120	3048	2657	1494	3610	6530
140	3556	3099	1743	4218	7624
160	4064	3542	1992	4825	8719
180	4572	3985	2241	5433	9813
200	5080	4428	2491	6040	10907
220	5588	4870	2740	6648	12002
240	6096	5313	2989	7255	13096
260	6604	5756	3238	7863	14191
280	7112	6199	3487	8470	15285
300	7620	6641	3736	9078	16380

* The projector distance can be adjusted using the Zoom function.
 * You can move an image up to 70% of the screen size from the lens center.

Kensington Security System

- This projector has a Kensington Security System Connector on the side panel. Connect the Kensington Security System cable as below.
- For the detailed installation and use of the Kensington Security System, refer to the user's guide included with the Kensington Security System set.
- And for further information, contact <http://www.kensington.com>, the internet homepage of the Kensington company that deals with expensive electronic equipment such as notebook PCs or projectors.
- The Kensington Security System is an optional item.

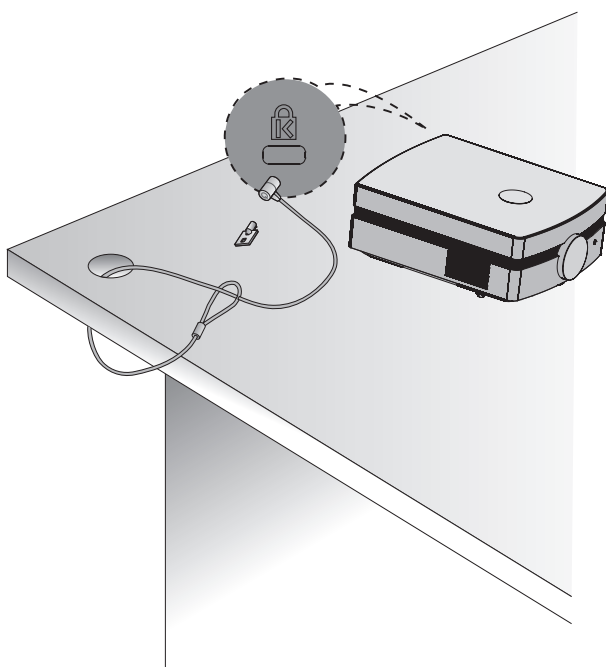

Turning on the Projector

1. Make sure the power cord is connected correctly.
2. Remove the lens cap. If it is left on, it could become deformed due to the heat produced by the projection lamp.
3. Press the **POWER** button on the remote control or back cover.
 - An image will appear after the operation deco LED turns (Blue (flashing))(Refer to page 11).
 - Press the **INPUT** button on the remote control or the **INPUT** button on the control panel to select the input signal you want.

Note!

* Do not disconnect the power cord while the fan is in operation. It may shorten the life of the fan. It will also take longer to activate the lamp when turning the power back on.

Turning off the Projector

1. Press the **POWER** button on the back cover or remote control.
2. Press the **POWER** button on the back cover or remote control again to turn off the power.
3. If the operation indicator is flashing orange, in other words the fan is working (60 seconds), do not disconnect the projector. When the indicator turns red, you may remove the power cord (Refer to page 11).
 - If the operation indicator LED is orange and flashing, the power button on the back cover or on the remote control will not operate.

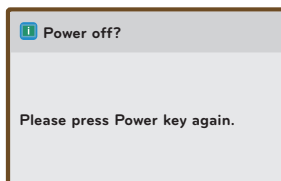

Focus and Position of the Screen Image

When an image appears on the screen, check if it is in focus and fits the screen properly.

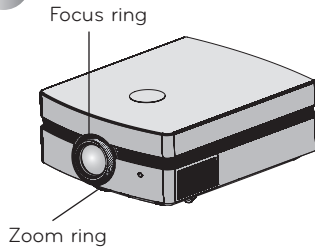

- To adjust the focus of the image, rotate the focus ring which is the outer ring on the lens.
- To adjust the size of the image, rotate the zoom ring which is the under ring on the lens.

When you need to move the screen image up or down, use the Lens shift dial on the projector to adjust the height as shown below.

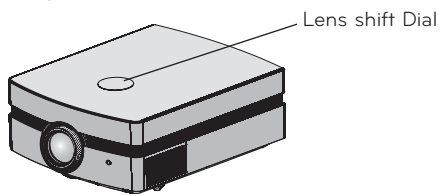

- Turn the Lens shift dial left or right to adjust the projector image up or down.

Note!

Turning the Lens shift dial with excessive power may cause damage to the projector.

Selecting source mode

1. Press the **INPUT** button.

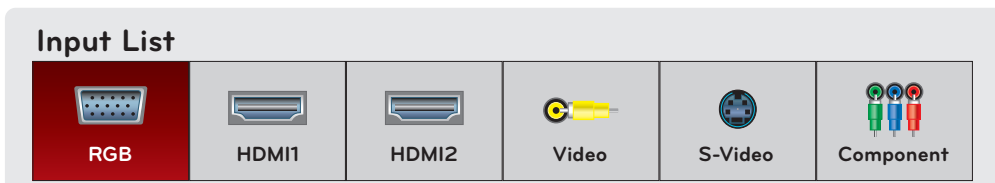

2. Selecting an input signal with the **INPUT** button will only change the projector only to connected inputs. You can change it to any inputs with the <, > button.

Connection

Connecting to a Desktop PC

- * You can connect the projector to a computer with VGA, SVGA, XGA, SXGA and 1080p/60Hz output.
- * Refer to page 30 for resolutions the projector supports.

< How to connect >

Connect the **RGB IN** of the projector and the computer output port with a computer cable.

- * You may have to change the resolution that your PC exports to one supported by the projector. Refer to page 30. This projector may not support output from laptops when the laptop screen is on.

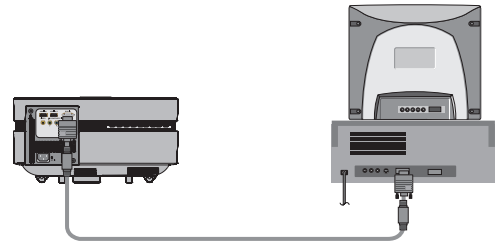

Connecting to a Video Source

- * You can connect a VCR, a camcorder or any other compatible video image source to the projector.

< How to connect 1 >

- a. Connect the Video input jacks of the projector to the output jacks of the A/V source with a video cable.

< How to connect 2 >

- b. Connect the **S-Video** input jack of the projector to the S-Video output jack of an A/V source with an S-Video cable.

- * S-Video supports better video quality than a regular A/V connection.

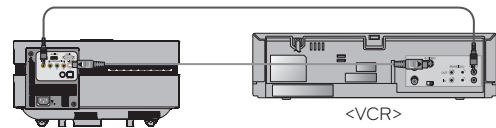

Connecting to a DVD Player

* Depending on the equipment, the component output jacks (Y, Pb, Pr) of the DVD Player may be labeled as Y, Pb, Pr/Y, B-Y, R-Y/ Y, Cb, Cr.

< How to connect >

- a. Connect the DVD Player component cable to the Y, Pb and Pr of the **COMPONENT IN** of the projector.
 - * When connecting the component cable, match the jack colors with the component cable.(Y=green, Pb=blue, Pr=red)
- b. You may use HDMI instead of component if available on the DVD player. HDMI supports better quality than component.

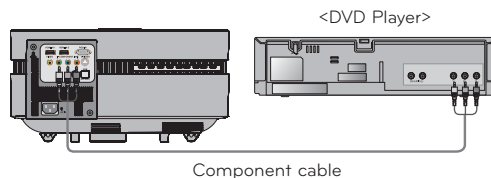

Signal	Component	HDMI
480i	○	X
480p	○	○
720p	○	○
1080i	○	○
1080p	○	○
576i	○	X
576p	○	○

Connecting to a D-TV Set-Top Box

* To receive Digital TV (D-TV) programs, it is necessary to purchase a D-TV receiver (Set-Top Box) and connect it to the projector.
 * Please refer to the owner's manual of the D-TV Set-Top Box for the connection between projector and D-TV Set-Top Box.

< How to connect a HDMI source >

- a. Connect the **HDMI IN** of the projector and the HDMI output port of the DTV set-top box with an HDMI cable.
- b. Set the DTV receiver's resolution to one of the following: 480p(576p)/720p/1080i/1080p mode.

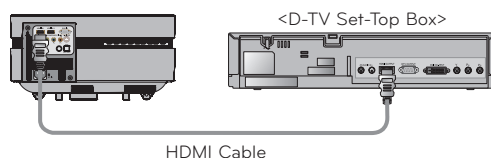

< How to connect a Component source >

- a. Connect the component cable connected to the DTV set-top box to the Y, Pb and Pr of the **COMPONENT IN** of the projector.
 - * When connecting the component cable, match the jack colors. (Y=green, Pb=blue, Pr=red)

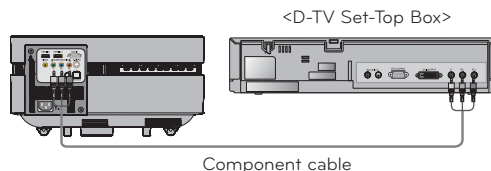

Function

* The On-Screen Display (OSD) in this manual may be slightly different from your projector.

* This operating guide explains operation of RGB(PC) mode mainly.

PICTURE Menu Options

Picture mode

* Use the Picture mode function to set the projector for the best picture appearance.

1. Press the **PICTURE** button on the remote control.
2. Press the <, > button to toggle through the preset picture settings.
 - Each press of the <, > button changes the screen as shown below.

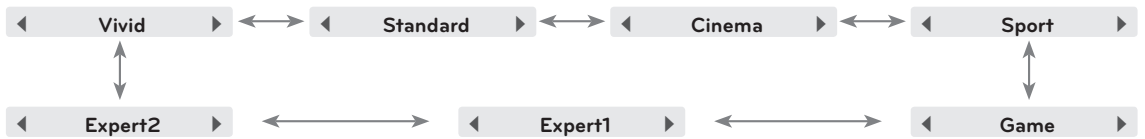

- You can use this function through the **MENU** button.
- To exit the menu display, press the **EXIT** button.

Adjusting Video

1. Press the **MENU** button. Then, move to **PICTURE** with the \wedge , \vee , <, > buttons and press the **OK** button.
2. Move to a sub-item with the > button. Then, use the \wedge , \vee buttons to move to a desired function and press the **OK** button.
3. Use the <, > buttons to make a desired adjustment and then press the **OK** button.

- You can set image values differently for each input and **Picture Mode**.
- Saving after making adjustments will display **(User)** in adjusted **Picture Mode**. (except **Expert 1/2**)
- Execute **Picture Reset** for **Picture Mode** to restore back to default factory settings.
- You can adjust contrast by pressing the \odot button on the remote control.
- You can adjust brightness by pressing the \bullet button on the remote control.
- Press the **MENU** or **EXIT** button to exit the menu screen.

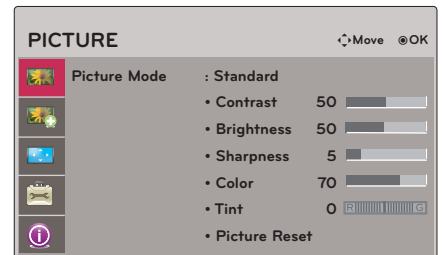

ADV. PICTURE Menu Options

Auto Iris Function

* This function adjusts the brightness of the entire image depending on inputted image to provide optimum image quality.

1. Press the **A.IRIS** button on the remote control.
2. Press the <, > button to adjust the screen condition as you want.
 - Each press of the <, > button changes the screen as shown below.

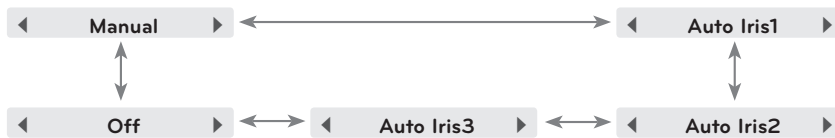

- **Manual** : You can adjust from **0** to **32** on **Advanced Control** of **ADV. PICTURE**.
- You can use this function through the **MENU** button.
- To exit the menu display, press the **EXIT** button.

TruMotion Demo Function

1. Press the **MENU** button. Then, move to **ADV. PICTURE** with the \wedge , \vee , <, > buttons and press the **OK** button.
2. Move to a sub-item with the > button. Then, use the \wedge , \vee buttons to move to **TruMotion Demo** and press the **OK** button.
 - Press the **MENU** or **EXIT** button to exit the menu screen.

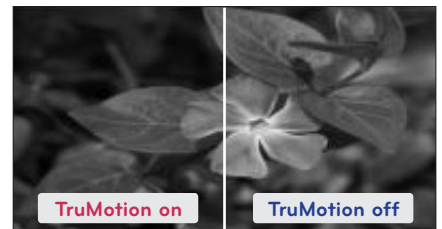
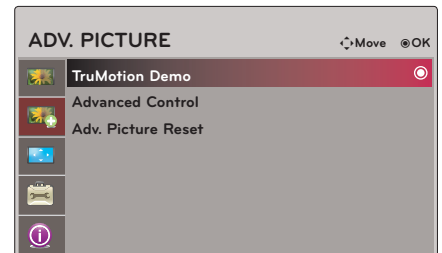

Advanced Control Function

1. Press the **MENU** button. Then, move to **ADV. PICTURE** with the \wedge , \vee , \leftarrow , \rightarrow buttons and press the **OK** button.
2. Move to a sub-item with the \rightarrow button. Then, use the \wedge , \vee buttons to move to **Advanced Control** and press the **OK** button.
3. Move to a desired item with the \wedge , \vee buttons and then press the **OK** button.
4. Use the \leftarrow , \rightarrow buttons to make a desired adjustment and then press the **OK** button.

- You can set image values differently for each input and **Picture Mode**.
- Press the **MENU** or **EXIT** button to exit the menu screen.

< When **Picture Mode** is **Vivid/Standard/Sport/Game** >

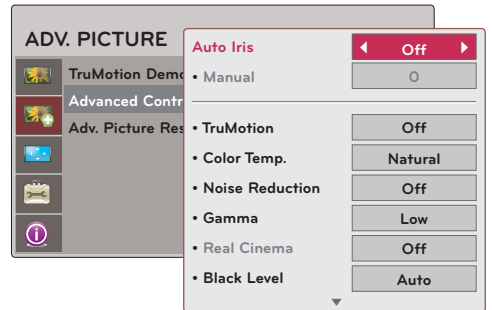

< When **Picture Mode** is **Cinema/Expert 1/2** >

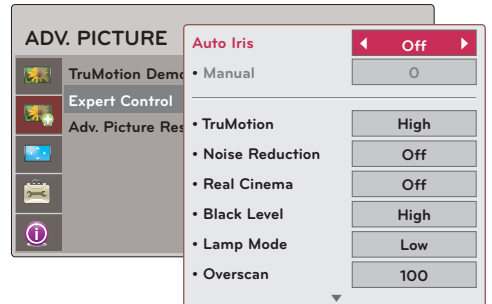

- ▶ **TruMotion** : Makes the moving image smoother through compensation.

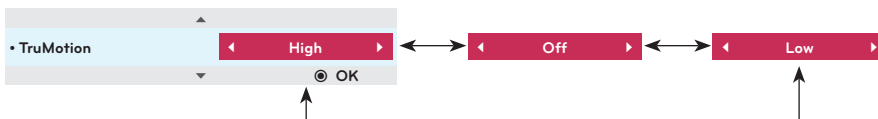

- This function cannot be set when PC signal is input.

- ▶ **Color Temp** : Selects the mood of screen colors.



- You can also use the **C.TEMP** button on the remote control.

- ▶ **Noise Reduction** : Removes noise from image without damaging it.

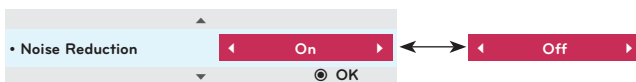

- You can use it only in Video, S-Video, Component(480i, 480p, 576i, 576p) and HDMI(480p, 576p) modes.

- ▶ **Gamma** : Sets the intensity of the picture.

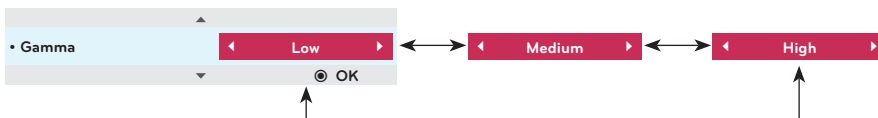

- You can also use the **GAMMA** button on the remote control.

- ▶ **Real Cinema** : Set up the picture for the best picture appearance for viewing movies.

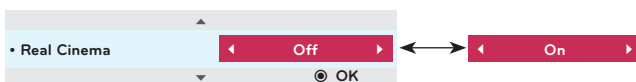

- You can use it only in Video, S-Video, Component(480i/576i/1080i 50/60Hz, 1080p 24Hz) and HDMI(1080i 50/60Hz, 1080p 24Hz) modes.

- ▶ **Black Level** : Adjusting the contrast and the brightness of the screen using the black level of the screen.

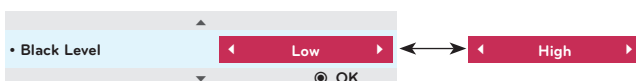

- You cannot set this function in SECAM, PAL 60 and PAL BGDK signals of Video, S-Video and RGB modes.

- ▶ **Lamp Mode** : Adjusts the lamp brightness.



- ▶ **Overscan** : You can adjust from 90, 92, 94...100.

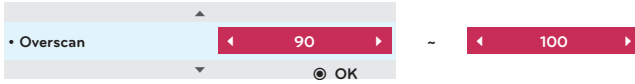

- This function cannot be set when the signal is 1080i and 1080p or **Aspect Ratio** is set as **Justscan**.
- Noise can occur at the edges of the screen at the signal of 1080i/1080p because of the malfunctioning of an image input device. In this case, change the signal into the one that can be set with **Overscan** and set **Overscan**.

- ▶ **Gamma Mode** : You can select this mode only when **Picture Mode** is **Cinema/Expert 1/2**.

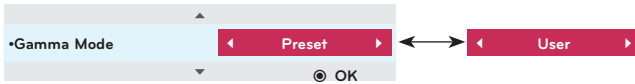

- **Adjustment** : You can select **Low, Medium** or **High**.
- **Level** : You can adjust from **0** to **8**.
- **IRE** : Automatically set from **0** to **100** according to **Level** change.
- When you select **User** -> **Red/Green/Blue** : You can adjust from **-127** to **127**.

- ▶ **White Balance** : Adjusts the overall feeling of the screen to your choice. You can select this function only when **Picture Mode** is **Cinema/Expert 1/2**.

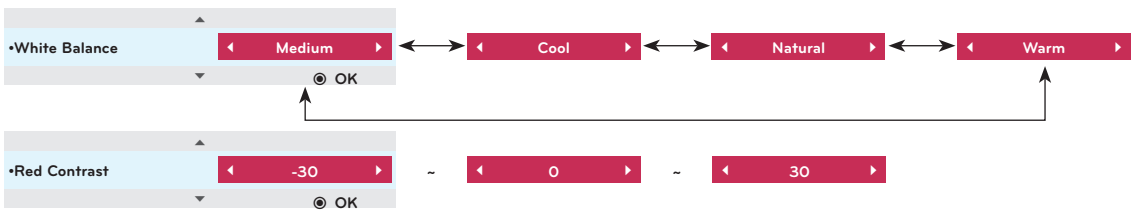

- **Red/Green/Blue Contrast** : You can adjust from **-30** to **30**.
- **Red/Green/Blue Brightness** : You can adjust from **-30** to **30**.

Advanced Picture Reset Function

* Settings of the selected **ADV PICTURE** function for each input and **Picture Mode** return to the default factory settings.

1. Press the **MENU** button. Then, move to **ADV. PICTURE** with the \wedge , \vee , \lt , \gt buttons and press the **OK** button.
2. Move to a sub-item with the \gt button. Then, use the \wedge , \vee buttons to move to **Adv. Picture Reset** and press the **OK** button.
3. Move to Yes with the \lt , \gt buttons and then press the **OK** button.

- Press the **MENU** or **EXIT** button to exit the menu screen.

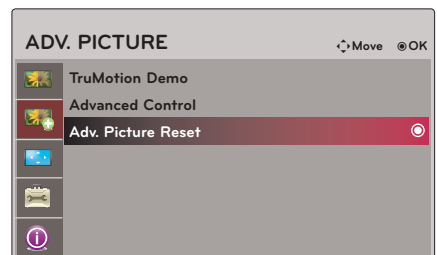

SCREEN Menu Options

To Change PJT Mode

* This function turns the projected image upside down or flips horizontal.

1. Press the **MENU** button. Then, move to **SCREEN** with the \wedge , \vee , $<$, $>$ buttons and press the **OK** button.
2. Move to a sub-item with the $>$ button. Then, use the \wedge , \vee buttons to move to **PJT Mode** and press the **OK** button.
3. Move to a desired item with the \wedge , \vee buttons and then press the **OK** button.

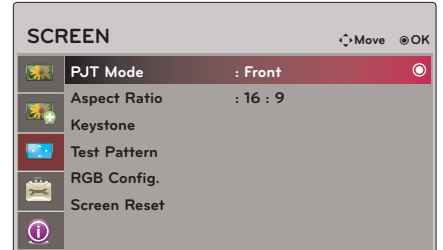

- Select **Rear** when projecting from the back of the transparent screen purchased separately.
- Select **Ceiling** when installing the product on the ceiling.
- Press the **MENU** or **EXIT** button to exit the menu screen.

Using Aspect Ratio Function

1. Press the **RATIO** button on the remote control.
2. Use the $<$, $>$ buttons to select a desired screen size.

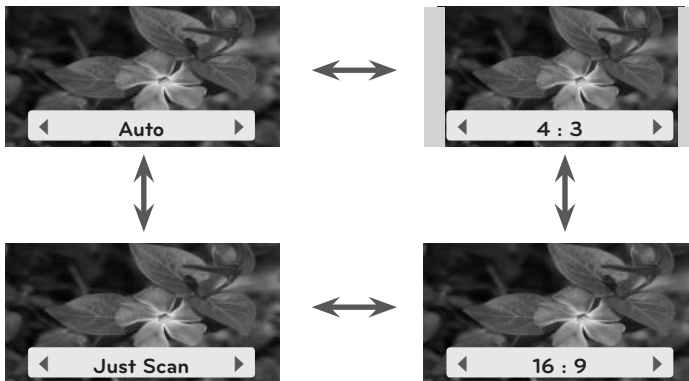

- Some options may not be available depending on input signals.
- You can use this function through the **MENU** button.
- To exit the menu display, press the **EXIT** button.

Using Keystone Function

- * Use this function when the screen is not at a right angle to the projector and the image is a trapezoid shape.
- * Only use the Keystone function when you can't get the best angle of projection.

1. Press the **KEYSTONE** button of remote control.
2. Move to a desired item with the \wedge , \vee buttons and then press the $>$ button.
3. Press the \wedge , \vee , $<$, $>$ button to adjust the screen condition as you want and then press the **OK** button.
 - **Keystone** can be adjusted from **-100** to **100**.
 - Execute **Reset** to restore back to default factory settings.
 - You can use this function through the **MENU** button.
 - To exit the menu display, press the **EXIT** button.

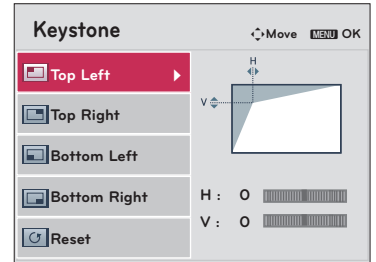

Test Pattern Function

- * Execute this function when installing the projector to adjust the screen size and focus.

Press the **PATTERN** button of remote control.

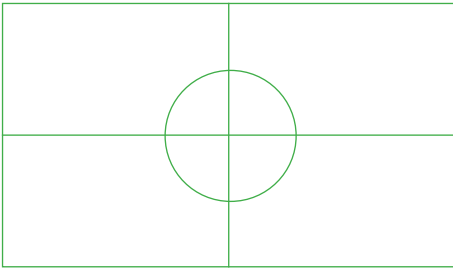

- You can use this function through the **MENU** button.
- To exit the menu display, press the **EXIT** button.

Auto Configure Function

- * This function assures you of getting the best video quality by automatically adjusting the horizontal size and synchronization of the image.
- * Auto Tracking function works in RGB PC input only.

1. Press the **AUTO** button of the remote control.
 - Image positioning and synchronization are automatically adjusted.
2. After automatic adjustments, if further manual adjustments are needed depending on **RGB Config.** on the **SCREEN** menu. In certain circumstances, you can't get the best picture quality by only using auto-correction.

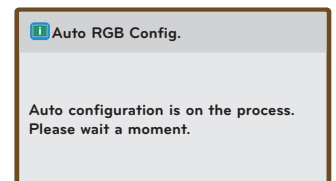

Note!

You can also use this function by using the **MENU** button. (Only in RGB mode)
For best results, perform this function while displaying a still image.

RGB Config. Function

1. Press the **MENU** button. Then, move to **SCREEN** with the \wedge , \vee , $<$, $>$ buttons and press the **OK** button.
2. Move to a sub-item with the $>$ button. Then, use the \wedge , \vee buttons to move to **RGB Config.** and press the **OK** button.
3. Move to a desired item with the \wedge , \vee buttons and then press the $>$ button.
4. Press the \wedge , \vee , $<$, $>$ button to adjust the screen condition as you want and then press the **OK** button.
 - The **Auto Configure** function operates only for RGB input. If you execute screen adjustment for a video from PC graphic signal, optimal state may not be found. Execute the **Auto Configure** function for a still image.
 - The variable range can be different depends on input resolutions.
 - To exit the menu display, press the **EXIT** button.

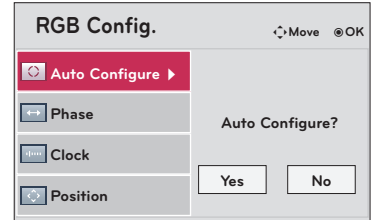

Screen Reset Function

* Settings of the selected **SCREEN** modes return to the default factory settings.

1. Press the **MENU** button. Then, move to **SCREEN** with the \wedge , \vee , $<$, $>$ buttons and press the **OK** button.
2. Move to a sub-item with the $>$ button. Then, use the \wedge , \vee buttons to move to **Screen Reset** and press the **OK** button.
3. Move to **Yes** with the $<$, $>$ buttons and then press the **OK** button.
 - Keystone function is not reset.
 - Press the **MENU** or **EXIT** button to exit the menu screen.

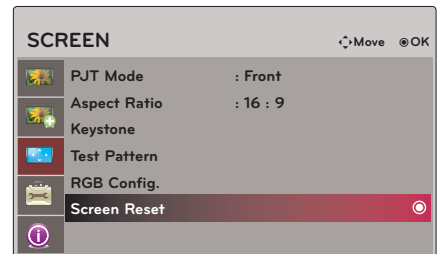

OPTION Menu Options

Using the Still Function

1. Press the **STILL** button on the remote control.
 - * You can freeze the moving image.



2. To exit STILL, press any button.
 - * The STILL function will release automatically after approximately 10 minutes.

Selecting Language

1. Press the **MENU** button. Then, move to **OPTION** with the \wedge , \vee , \lt , \gt buttons and press the **OK** button.
2. Move to a sub-item with the \gt button. Then, use the \wedge , \vee buttons to move to **Language** and press the **OK** button.
3. Move to a desired item with the \wedge , \vee buttons and then press the **OK** button.

- On-Screen-Display (OSD) is displayed in the selected language.
- Press the **MENU** or **EXIT** button to exit the menu screen.

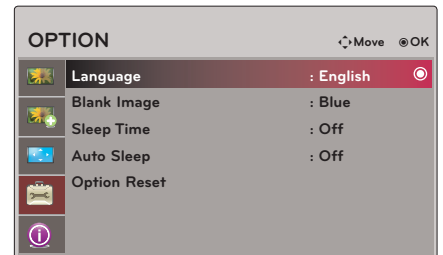

Using Blank Function

* This function may be effective if you need to get the attention of the audience during presentations, meetings or briefings.

1. Press the **BLANK** button on the remote control.
 - The screen turns off to a background color.
 - You can choose the background color. (Refer to '**Selecting Blank image color**')
2. Press any button to cancel the blank function.
 - To temporarily turn off the lamp, press **BLANK** on the remote control. Do not block the projection lens with any objects when the projector is under operation as this could cause the objects to become heated and deformed or even cause a fire.

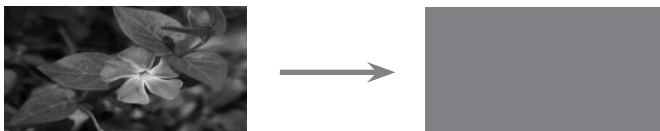

Selecting Blank image color

1. Press the **MENU** button. Then, move to **OPTION** with the \wedge , \vee , $<$, $>$ buttons and press the **OK** button.
2. Move to a sub-item with the $>$ button. Then, use the \wedge , \vee buttons to move to **Blank Image** and press the **OK** button.
3. Move to a desired item with the \wedge , \vee buttons and then press the **OK** button.



- Background color will be altered to the selected **Blank** function color.
- Press the **MENU** or **EXIT** button to exit the menu screen.

Sleep time Function

* The sleep timer turns the projector off at the preset time.

1. Press the **SLEEP** button of remote control.
2. Press the $<$, $>$ button to select the desired preset time.
 - Each press of the $<$, $>$ button changes the screen as shown below.

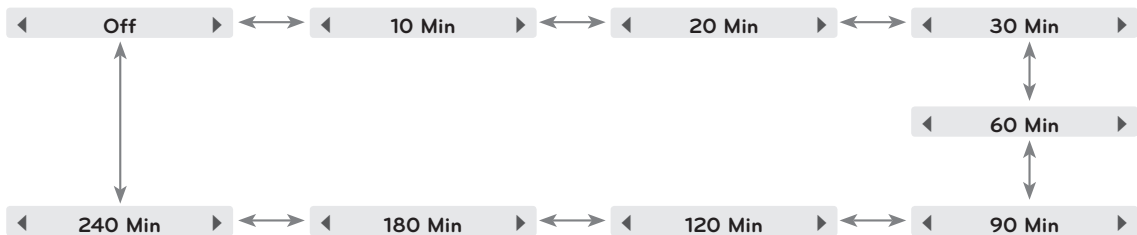

- You can use this function through the **MENU** button.
- To exit the menu display, press the **EXIT** button.

Auto sleep Function

* This function turns the projector off automatically after 10 minutes is passed when there is no signal.

1. Press the **MENU** button. Then, move to **OPTION** with the \wedge , \vee , $<$, $>$ buttons and press the **OK** button.
2. Move to a sub-item with the $>$ button. Then, use the \wedge , \vee buttons to move to **Auto Sleep** and press the **OK** button.
3. Move to **On** with the $<$, $>$ buttons and then press the **OK** button.
 - Press the **MENU** or **EXIT** button to exit the menu screen.

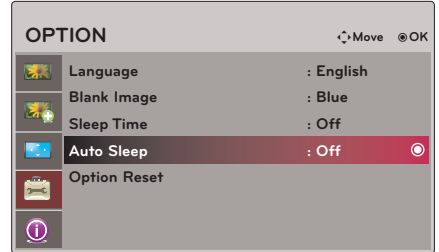

Option Reset Function

* Settings of the selected **OPTION** modes return to the default factory settings.

1. Press the **MENU** button. Then, move to **OPTION** with the \wedge , \vee , $<$, $>$ buttons and press the **OK** button.
2. Move to a sub-item with the $>$ button. Then, use the \wedge , \vee buttons to move to **Option Reset** and press the **OK** button.
3. Move to **Yes** with the $<$, $>$ buttons and then press the **OK** button.
 - **Language** function is not reset.
 - Press the **MENU** or **EXIT** button to exit the menu screen.



INFORMATION Menu Options

To See The Projector Information

1. Press the **MENU** button. Then, move to **INFORMATION** with the \wedge , \vee , $<$, $>$ buttons and press the **OK** button.
2. You can see the current information of the projector.
 - Press the **MENU** or **EXIT** button to exit the menu screen.

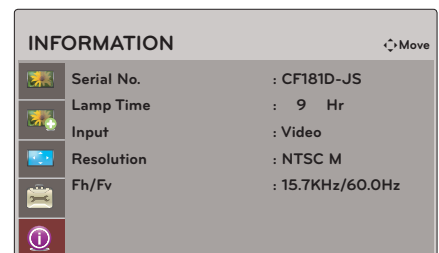

Information

Supported Monitor Display

* The following table lists the display formats supported by the projector.

Format	Vertical Freq.(Hz)	Horizontal Freq.(kHz)
640X480	59.94Hz	31.469kHz
800X600	60.31Hz	37.879kHz
1024X768	60.00Hz	48.363kHz
1152X864	60.05Hz	54.348kHz
1280X720	59.855Hz	44.772kHz
1280X768	60.00Hz	47.693kHz
1280X960	60.00Hz	60.000kHz
1280X1024	60.02Hz	63.981kHz
1400X1050	59.978Hz	65.317kHz
1920X1080	60.00Hz	67.5kHz

* If the projector does not support the input signal, "Out of Range" message appears on the screen.

* The projector supports DDC1/2B type as Plug & Play function. (Auto recognition of PC monitor)

* The Synchronization input form for horizontal and vertical frequencies are Separate.

< DVD/DTV Input >

Signal	Component-*1	HDMI (DTV) -*2
60 Hz	480i	O
	480p	O
	720p	O
	1080i	O
	1080p	O
50 Hz	576i	O
	576p	O
	720p	O
	1080i	O
	1080p	O
24/25/30Hz	1080p	O

* Cable type
1- Component Cable
2- HDMI Cable

Maintenance

* The projector needs little maintenance. You should keep the lens clean because any dirt or stains may appear on the screen. If any parts need to be replaced, contact your dealer. When cleaning any part of the projector, always turn the power off and unplug the projector first.

Cleaning the lens

If there is any dust or stain on the surface of the lens, you must always clean the lens. Use an air spray or cleaning cloth for product exterior, provided with the product, to lightly clean the product. Please use a recommended air spray or lens cleaning product. To clean the lens, spray a small amount of cleaning agent on a swab or a soft cloth and then clean the lens. Please be aware that liquid may flow pass into the lens if the product is sprayed on lens directly.

Cleaning the Projector Case

To clean the projector case, first unplug the power cable. To remove dirt or dust, wipe the casing with the provided polishing cloth. Do not use alcohol, benzene, thinners or other chemical detergents as these can cause the casing to be warped or discolored.

Cleaning the Filter

When prompted to clean the filter while using the projector, take the following steps to clean it.

- 1 Turn off the projector and unplug the power cable. Turn it upside down and place it on a table or flat surface.

- 2 Press as indicated by arrows with both hands and remove the filter cover.

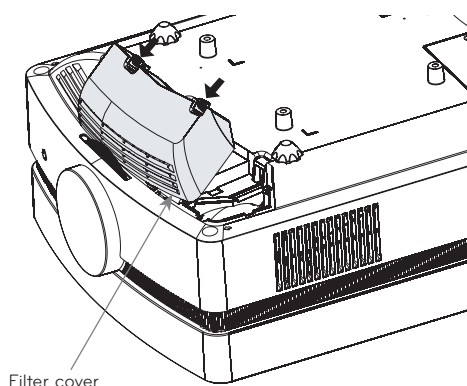

- 3 Turn the filter cover upside down, take the filter out and remove dust from it.

(When the filter is damaged, use additionally-provided new filter.)

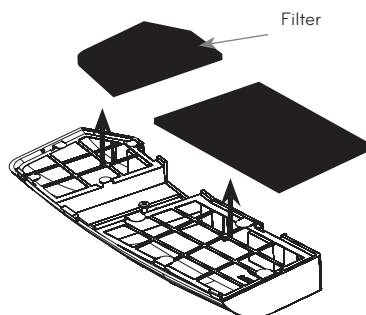

- 4 Insert the filter into the cover. Fit the cover onto the projector and press it until a click sound is heard.

Replacing the Lamp

Lamp Replacement

The change interval of the lamp depends on the use environment of Projector. You can see the used lamp time in the **CHECKING LAMP TIME** section of the Menu (page.29). You must replace the lamp when:

- The projected image gets darker or starts to deteriorate.
- The lamp indicator is red.
- The message "Replace the lamp" appears on the screen when turning the projector on.

<Top panel of the Projector>

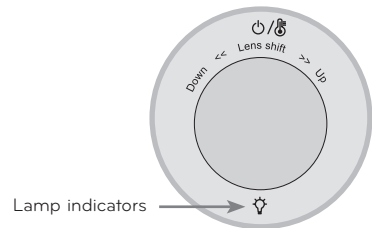

Be careful when replacing lamp

- Press the **POWER** button on the control panel or remote control to turn off power.
- If the operation indicator LED is orange and blinking, do not disconnect the main supply until the operation indicator LED is lit up constantly (red).
- Allow the lamp to cool for 1 hour before replacing it.
- Replace only with the same type lamp from an LG Electronics Service Center. Using another manufacturers lamp may cause damage to the Projector and lamp.
- Pull out the lamp only when replacing the lamp.
- Keep the lamp unit out of reach of children. Keep the Lamp away from heat sources such as radiators, stoves etc.
- To reduce the risk of fire do not expose the lamp to liquids or foreign materials.
- Do not place the lamp near any heat source.
- Make sure the new lamp is securely tightened with screws. If not, the image may be dark or there could be an increased risk of fire.
- Never touch the glass on the lamp. Image quality may be compromised or lamp life may be reduced.

To obtain a replacement Lamp unit

Lamp model number is on page 35. Check the lamp model and then purchase it from an LG Electronics Service Center. Using another manufacturers lamp may cause damage to the projector.

Lamp unit disposal

Dispose of the used lamp by returning it to the LG Electronics Service Center.

Replacing the Lamp

- 1 Turn off the projector and unplug the power cable. Carefully place on a cushioned surface.

(Allow the lamp to cool for 1 hour before removing the used lamp from the projector.)

- 2 Unscrew the screw from the lamp cover using a screwdriver.

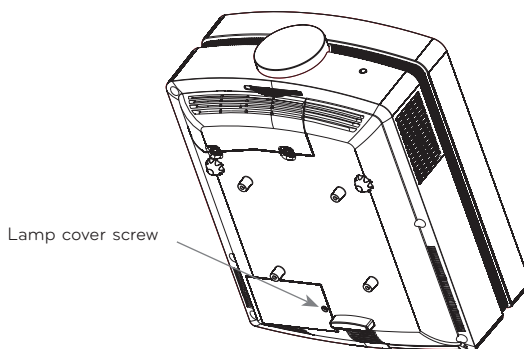

- 3 After lifting the lamp cover off, remove the two retaining screws on the lamp case with a screwdriver.

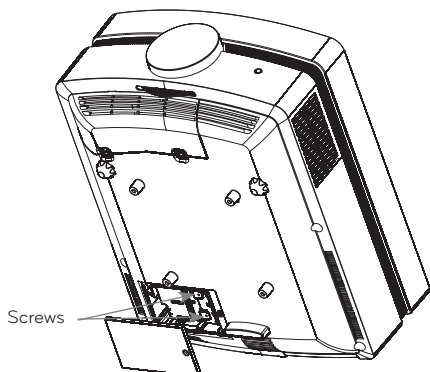

- 4 Lift the lamp up from the projector.

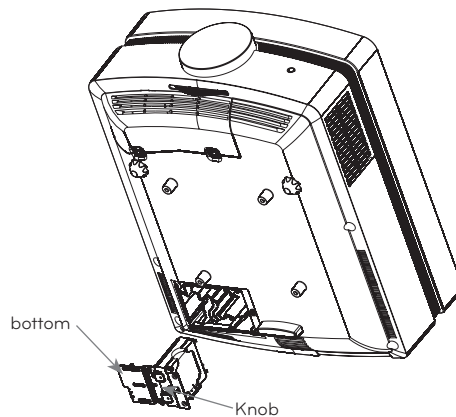

- 5 Pull out the handle slowly and remove the lamp case.

- 6 Insert the new lamp gently into the correct position. Push the lamp bottom to check if it is correctly installed.

- 7 Tighten the screws you removed in step 3.

(Make sure they are fixed firmly.)

- 8 Close the lamp cover and install the screws from step 2 to install the cover.

(If the lamp cover is not installed correctly the unit will not power on.)

Note!

- Using another manufacturer's lamp may cause damage to the projector or lamp.
- Make sure the lamp cover is securely fastened. If the lamp cover is not installed correctly the unit will not power on.
- If this fault persists contact an LG Authorized Service Center.

Regarding the projector lamp control

WARNING

- Don't turn off the projector at least 5 minutes after activating it.
 - The frequent On/Off changes may cause the lamp to deteriorate.
- Don't pull out the power cord while operating the projector or the cooling fan.
 - It will shorten the life of the lamp or damage it.
- The life-span of the projector depends on the user's environment and treatment conditions.
- The projector uses a high pressure mercury lamp. Use caution when handling. The lamp can shatter and cause harm.
- If you continue to use the projector after the lamp timer has recommended replacing the lamp, the lamp could shatter and be difficult and dangerous to remove.
- Do the following if the lamp shatters
 - Unplug the projector immediately.
 - Let some fresh air in immediately (Ventilation).
 - Have service center check the projector for damage and replace the lamp.
 - Don't try to disassemble the projector.

Specifications

MODEL	CF181D (CF181D-JS)
Resolution	1920 (Horizontal) x 1080 (Vertical) pixel
Horizontal / Vertical Ratio	16:9 (horizontal:vertical)
LCOS panel size (mm)	15.4
Screen size (Projection distance)	Wide: 0.9 m ~ 9.1 m (76.2 cm ~ 762.0 cm) Tele: 1.6 m ~ 16.4 m (76.2 cm ~ 762.0 cm)
Projection Offset	120 %
Remote control distance	12 m
Zoom ratio	1:1.8
Video compatibility	NTSC/PAL/SECAM/NTSC4.43/PAL-M/PAL-N/PAL-60
Power	AC 110 V - 240 V~ 50/60 Hz, 3.0 A-1.2 A
Height (mm)	173.0
Width (mm)	366.0
Length (mm)	447.5
Weight (kg)	9.8

Operating Condition

Temperature

In operation : 0°C ~ 40°C
In storage and transit : -20°C ~ 60°C

Humidity

In operation : 0 % ~ 75% relative humidity
Not in operation : 0 % ~ 85% relative humidity

Projector Lamp

Lamp model

AJ-LAF1

Lamp power consumption

220 W



The model and serial number of the projector is located on the back or one side of the projector. Record it below should you ever need service.

MODEL _____

SERIAL _____