

SyncMaster P50HP, P50HP-2, P63FP, P63FP-2

PDP Display

User Manual

The color and the appearance may differ depending on the product, and the specifications are subject to change without prior notice to improve the performance.

Safety Instructions

Notational



Note

These safety instructions must be followed to ensure your safety and prevent property damage.

Make sure to read the instructions carefully and use the product in the correct manner.

Warning / Caution



Failure to follow directions noted by this symbol could result in bodily harm or damage to the equipment.

Note



Prohibited



Important to read and understand at all times



Do not disassemble



Disconnect the plug from the outlet



Do not touch



Ground to prevent an electric shock

Power



When not used for extended period of time, set your computer to DPM.

If using a screen saver, set it to active screen mode.

The images here are for reference only, and are not applicable in all cases (or countries).

Shortcut to Anti-Afterimage Instructions

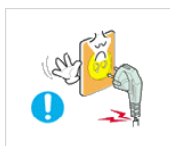

▶ Do not use a damaged power cord or plug or a damaged or loose power outlet.

- Otherwise, this may result in electric shock or fire.



▶ Do not touch the power plug with wet hands when removing or plugging the plug into the outlet.

- Otherwise, this may result in electric shock.

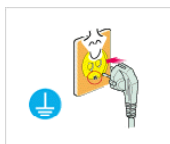

▶ Make sure to connect the power cord to a grounded power outlet.

- Otherwise, it may result in electric shock or personal injury.

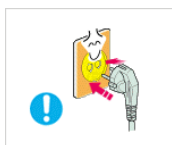

▶ Ensure that the power plug is plugged into the power outlet firmly and correctly.

- Otherwise, this may result in fire.

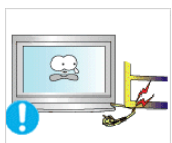

▶ Do not forcefully bend or pull the power plug and do not place any heavy material on it.

- Otherwise, this may result in fire.

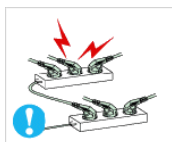

▶ Do not connect multiple appliances to the same power outlet.

- Otherwise, this may cause fire due to overheating.

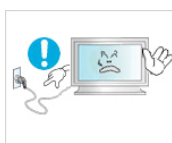

▶ Do not disconnect the power cord while using the product.

- Otherwise, this may result in damage to the product due to electric shock.



▶ To disconnect the apparatus from the mains, the plug must be pulled out from the mains socket, therefore the mains plug shall be readily operable.

- Otherwise, this may cause electric shock or fire.



▶ Use only the power cord provided by our company. Do not use the provided power cord of another product.

- Otherwise, this may result in fire or electric shock.

Installation



Be sure to contact an authorized Service Center when installing your monitor in a location with heavy dust, high or low temperatures, high humidity, and exposed to chemical substances and where it operates for 24 hours such as at airports, train stations etc.

Failure to do so may cause serious damage to your monitor.



▶ Ensure that at least two persons lift and move the product.

- Otherwise, it may be dropped and cause personal injury, and/or damage the product.

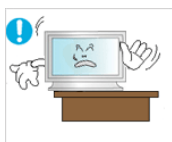

▶ When installing the product in a cabinet or rack, make sure that the front end of the bottom of the product does not project out.

- Otherwise, it may fall or cause personal injury.

• Use a cabinet or rack of a size appropriate to the product.



▶ DO NOT PLACE CANDLES, MOSQUITO REPELLANT, CIGARETTES AND ANY HEATING APPLIANCES NEAR THE PRODUCT.

- Otherwise, this may result in fire.

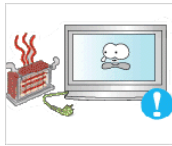

- ▶ Keep heating appliances as far away from the power cord or the product as possible.
- Otherwise, this may result in electric shock or fire.



- ▶ Do not install it in a badly ventilated location such as a bookcase or closet.
- Otherwise, this may result in fire due to an increase in the internal temperature.



- ▶ When putting the product down, make sure to put it down softly.
- Otherwise, this may result in damage to the screen display.



- ▶ Do not place the front of the product on the floor.
- Otherwise, this may result in damage to the screen display.



- ▶ Ensure that an authorized installation company installs the wall mount.
- Otherwise, it may fall and cause personal injury.
- Make sure to install the specified wall mount.

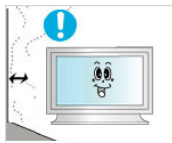

- ▶ Install your product in a well ventilated location. Ensure that there is a clearance of more than 4 inches (10 cm) from the wall.
- Otherwise, it may result in fire due to an increase in the internal temperature.

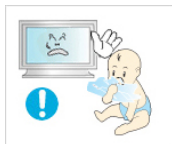

- ▶ Ensure that the packaging vinyl is kept away from children.
- Otherwise, it may result in serious harm (suffocation) if children play with it.

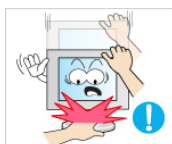

- ▶ If the height of your monitor is adjustable, do not place any object or part of your body on the stand when lowering it.
- This may cause damage to the product or the person carrying it.

Clean



When cleaning the PDP Display case or the surface of the TFT-PDP screen, wipe with a slightly moistened, soft fabric.

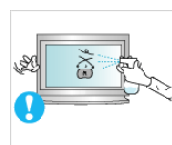

- ▶ Do not spray cleaner directly onto the surface of the product.
- Otherwise, this may result in the discoloration and distortion of the structure and the screen surface may peel off.

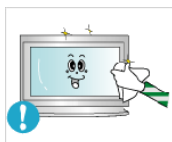

- ▶ Clean the product using a soft cloth with a monitor cleaner only.
- If you must use a cleaner other than the monitor cleaner, dilute it with water at a ratio of 1:10.



▶ When cleaning the power plug pins or dusting the power outlet, clean it with a dry cloth.

- Otherwise, it may result in fire.



▶ When cleaning the product, make sure to disconnect the power cord.

- Otherwise, it may result in electric shock or fire.

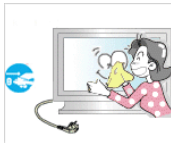

▶ When cleaning the product, disconnect the power cord and clean it with a soft, dry cloth.

- Do not use chemicals such as wax, benzene, alcohol, thinner, mosquito repellent, lubricant, or cleaner.
- These may change the appearance of the product surface and peel off the indication labels on the product.



▶ Since the product housing is easily scratched, make sure to use the specified cloth only.



▶ When cleaning the product, do not spray water directly onto the main body of the product.

- Ensure that water does not enter the product and that it is not wet.
- Otherwise, this may result in electric shock, fire or a malfunction.

Others



▶ The product is a high voltage product. Do not disassemble, repair or modify the product yourself.

- Otherwise, this may result in electric shock or fire.
- If the product needs to be repaired, contact a Service Center.

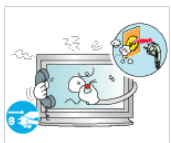

▶ If there is a strange smell or a strange sound or smoke is coming from the product, disconnect the power plug immediately and contact a Service Center.

- Otherwise, this may result in electric shock or fire.

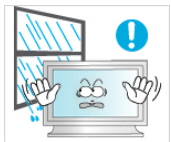

▶ Do not place this product in a location exposed to moisture, dust, smoke, water, or in a car.

- Otherwise, this may result in electric shock or fire.



▶ When you drop the product or the case is broken, turn the power off and disconnect the power cord. Contact a Service Center.

- Otherwise, this may result in electric shock or fire.



- ▶ If thunder or lightning is occurring, do not touch the power cord or antenna cable.
- Otherwise, this may result in electric shock or fire.

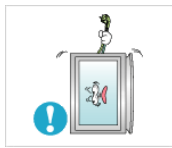

- ▶ Do not try to move the monitor by pulling only the wire or the signal cable.
- Otherwise, it may fall and result in electric shock, damage to the product or fire due to damage to the cable.



- ▶ Do not lift or move the product back and forwards or right and left while only holding the power cord or signal cables.
- Otherwise, it may fall and result in electric shock, damage to the product or fire due to damage to the cable.



- ▶ Make sure that the ventilating opening is not blocked by a table or curtain.
- Otherwise, it may result in fire due to an increase in the internal temperature.

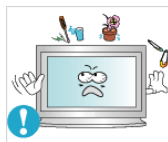

- ▶ Do not place any containers containing water, vases, flower-pots, medicines as well as any metal on the product.
- If water or a foreign material enters the product, disconnect the power cord and contact a Service Center.

- This may result in a product malfunction, electric shock, or fire.

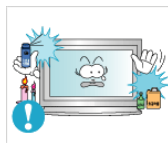

- ▶ Do not use or keep combustible spray or flammable material near the product.
- Otherwise, this may result in an explosion or fire.



- ▶ Do not insert any metal, such as chopsticks, coins, pins and steel, or flammable objects, such as matches or paper, inside the product (through the ventilating openings, input and output terminals, etc).

- If water or foreign material enters the product, disconnect the power cord and contact a Service Center.

- Otherwise, this may result in electric shock or fire.

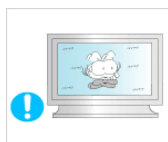

- ▶ When using a fixed screen for a long time, an afterimage or stain may occur.

- If you are not using your product for a long period of time, put it into sleep mode or use a moving screen saver.



- ▶ Set a resolution and frequency appropriate to the product.

- Otherwise, your eyesight may be damaged.

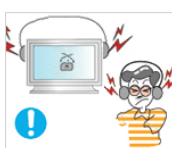

- ▶ When using headphones or earphones, do not turn the volume too high.

- Having the sound too loud may damage your hearing.



▶ To avoid eyestrain, do not sit too close to the product.



▶ Take a rest for at least five (5) minutes after using the monitor for one (1) hour.

- This reduces eye fatigue.



▶ Do not install it in an unstable location such as an unstable rack or uneven surface or a location exposed to vibrations.

- Otherwise, it may fall and cause personal injury and/or damage the product.
- If you use the product in a location exposed to vibrations, it may damage the product and result in fire.



▶ When moving the product, turn the power off and disconnect the power plug, antenna cable, and all the cables connected to the product.

- Otherwise, it may result in electric shock or fire.

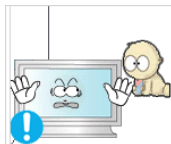

▶ Ensure that children do not hang onto the product or climb up onto the product.

- The product may fall and cause personal injury or death.



▶ If you do not use the product for a long period of time, disconnect the power cord from the power outlet.

- Otherwise, this may result in overheating or fire due to dust, and may result in fire due to electric shock or leakage.

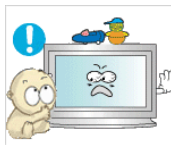

▶ Do not place any heavy items or toys or confectionery, such as cookies etc. that may attract the attention of children and to the product.

- Your children may hang onto the product causing it to fall and this may result in personal injury or death.



▶ Be careful that children do not place the battery in their mouths when removed from the remote control. Place the battery in a location that children or infants cannot reach.

- If children have had the battery in their mouths, consult your doctor immediately.

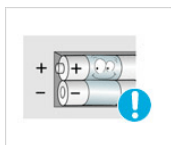

▶ When replacing the battery, insert it with the right polarity (+, -).

- Otherwise, the battery may become damaged or it may cause fire, personal injury or damage due to leakage of the internal liquid.



▶ Use only the specified standardized batteries, and do not use a new battery and a used battery at the same time.

- Otherwise, the batteries may be damaged or cause fire, personal injury or damage due to a leakage of the internal liquid.

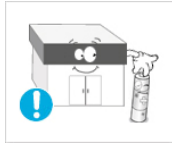

▶ The batteries (and rechargeable batteries) are not ordinary refuse and must be returned for recycling purposes. The customer is responsible for returning the used or rechargeable batteries for recycling.

- The customer can return used or rechargeable batteries to a nearby public recycling center or to a store selling the same type of the battery or rechargeable battery.



▶ Do not place the product in a location exposed to direct sunlight or near any heat such as a fire or heater.

- This may reduce the lifetime of the product, and may result in fire.



▶ Do not drop any objects onto the product or cause any impact to the product.

- Otherwise, this may result in electric shock or fire.



▶ Do not use a humidifier near the product.

- Otherwise, this may result in electric shock or fire.



▶ When there is a gas leak, do not touch the product or the power plug; ventilate immediately.

- If a spark occurs, it may cause an explosion or fire.

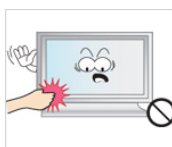

▶ If the product has been turned on for a long time, the display panel becomes hot. Do not touch it.



▶ Keep the small accessories in a location out of the reach of children.

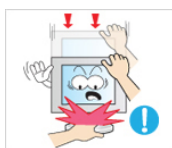

▶ Be careful when adjusting the angle of the product or the height of the stand.

- This may result in personal injury as your hand or fingers may become caught.

- Also, if you tilt the product too far, it may fall and cause personal injury.

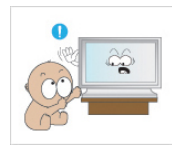

▶ Do not install the product in a location low enough for children to reach.

- Otherwise, it may fall and result in personal injury.

- Since the front part of the product is heavy, install the product on a level and stable surface.



▶ Do not put any heavy objects on the product.

- This may result in personal injury and/or damage to the product.

Introduction

Package Contents



Note

Please make sure the following items are included with your PDP Display.

If any items are missing, contact your dealer.

Contact a local dealer to buy optional items.

Checking the Contents of the Package

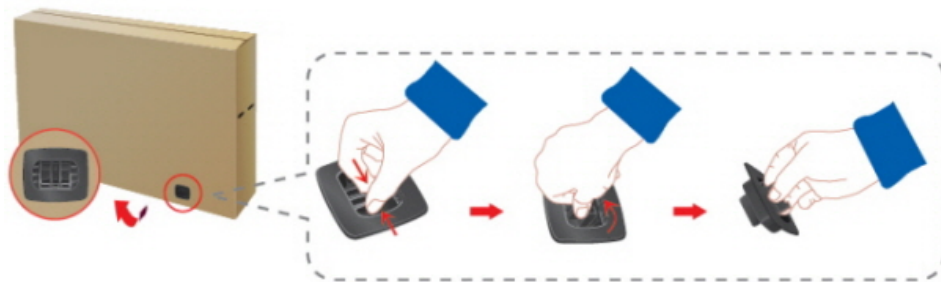

Remove the lock from the package box, as shown in the figure above.



Lift up the package box by holding the grooves on both sides of the package box.

Check the contents of the package.

Remove the Styrofoam and vinyl cover.



Note

- After unpacking the package, make sure to check the contents of the package.
- Make sure to keep the package box for transporting the product in the future.
- After unpacking, you may use the lower part of the package box as a temporary stand for product test or operation check.

Unpacking



PDP Display

Manuals



Quick Setup Guide



Warranty Card

(Not available in all locations)



User's Guide

Cables



Power Cord



D-Sub Cable

Others



Remote Control



Batteries (AAA X 2)

(Not available in all locations)



Ferrite Core for Power Cord

Sold separately



DVI Cable

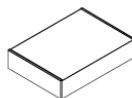

Wall Mount KIT

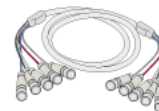

BNC to BNC Cable



Network Box



RGB to BNC Cable

Ferrite Core



- The ferrite cores are used to shield the cables from interference.
- When connecting a cable, open the ferrite core and clip it around the cable near the plug.

Your PDP Display



The PDP device may interfere with an amateur radio or AM radio.

Front

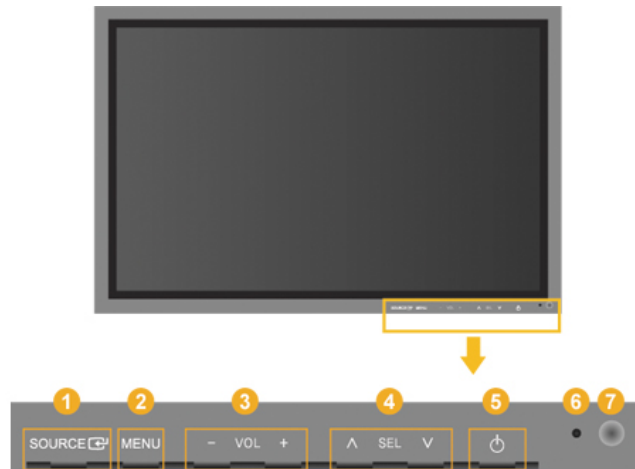

1 SOURCE button [SOURCE]

Switches from PC mode to Video mode. Changing the source is only allowed for external devices that are connected to the PDP Display at the time.

[PC] → [DVI] → [AV] → [HDMI] → [MagicInfo] → [BNC] → [Component]



- **MagicInfo** can only be enabled when a network box is connected.
- The **HDMI** port and network box cannot be connected at the same time.

Enter button [ENTER]

Activates a highlighted menu item.

2 MENU button [MENU]

Opens the on-screen menu and exits from the menu. Also use to exit the OSD menu or return to the previous menu.

3 - VOL +

Moves from one menu item to another horizontally or adjusts selected menu values. When OSD is not on the screen, push the button to adjust volume.

4 ^ SEL v

Moves from one menu item to another vertically or adjusts selected menu values.

5 Power button [POWER]

Use this button for turning the PDP Display on and off.

6 Power indicator

Shows PowerSaver mode by blinking green

 **Note**

See PowerSaver described in the manual for further information regarding power saving functions. For energy conservation, turn your PDP Display OFF when it is not needed or when leaving it unattended for long periods.

7 *Remote Control Sensor*

Aim the remote control towards this spot on the PDP Display.

Rear

 **Note**

For detailed information concerning cable connections, refer to Connecting Cables under Setup. The PDP Display's configuration at the back may vary slightly depending on the PDP Display model.



A

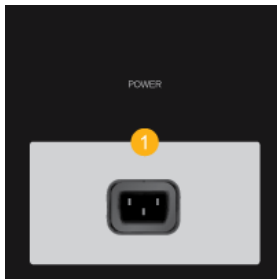

1 *POWER IN*

The power cord plugs into the PDP Display and the wall plug.

B

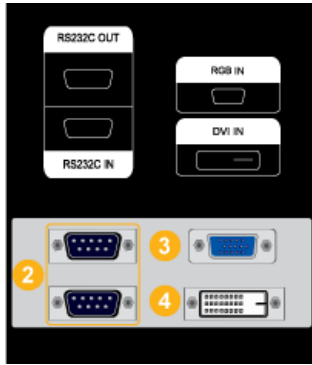

2 *RS232C OUT/IN (RS232C Serial PORT)*

MDC(Multiple Display Control) Program Port

3 *RGB IN (PC Connection Terminal (Input))*

- Use a D-Sub Cable (15 pin D-Sub) - PC mode (Analog PC)
- Connect the RGB IN port on the monitor to the BNC port on the PC using the RGB to BNC cable.

4 *DVI IN (PC Video Connection Terminal)*

Connect the [DVI IN] port on the monitor to the DVI port on the PC using the DVI cable.

C

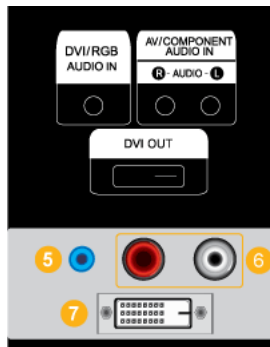

5 *DVI/RGB AUDIO IN (PC/DVI Audio Connection Terminal (Input))*

6 *AV/COMPONENT AUDIO IN [R-AUDIO-L]*

Connect the port of the DVD, VCR (DVD / DTV Set-Top Box) to the [R-AUDIO-L] port of the PDP Display.

7 *DVI OUT*

- Connect a monitor to another monitor through a DVI cable.
- Connect the [DVI OUT] port on the monitor to the [HDMI IN] port on the other monitor using the DVI to HDMI cable.
- DVI, HDMI and network signals sent via the [DVI OUT] port are displayed on the second display which has the DVI IN port.

 **Note**

Up to 6 Full HD or 10 HD monitors can be connected (May differ depending on the product).

D

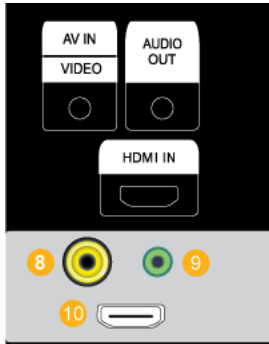

8 AV IN [VIDEO]

Connect the AV IN [VIDEO] terminal of your monitor to the video output terminal of the external device using a VIDEO cable.

9 AUDIO OUT

Headphone/External speaker output terminal.

10 HDMI IN

Connect the HDMI terminal at the back of your PDP Display to the HDMI terminal of your digital output device using a HDMI cable.

Up to HDMI cable 1.2 can be supported.

E

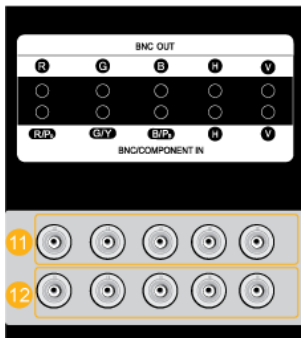

11 BNC OUT [R, G, B, H, V] (BNC Terminal (Output))

BNC (Analog PC) Connection: connecting the R, G, B, H, V ports.

The number of PDP Displays that can be connected to the loopout depends on the cables, signal source, etc. With cables or signal source where there is no degradation, up to 10 PDP Displays can be connected (May not be supported depending on the connected cable).

12 BNC/COMPONENT IN [R/P_R, G/Y, B/P_B, H, V] (BNC/Component Connection Terminal (input))

- During **BNC** input, please check specifications for the input ports below.

- [R/P_R] --> Red port input
- [G/Y] --> Green port input
- [B/P_B] --> Blue port input

- During component input, please check specifications for the input ports below.

- [R/P_R] --> Red port input
- [G/Y] --> Green port input
- [B/P_B] --> Blue port input

F

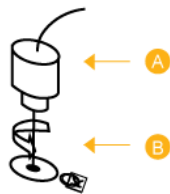
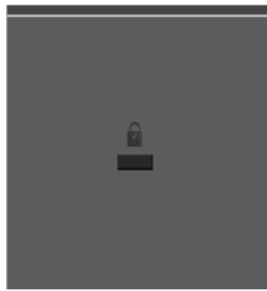

Kensington Lock

The Kensington Lock is a device used to physically fix the system when using it in a public place. The locking device has to be purchased separately. The appearance and locking method may differ from the illustration depending on the manufacturer. Refer to the manual provided with the Kensington Lock for proper use.



Note

The location of the Kensington Lock may be different depending on its model.

Using the Anti-Theft Kensington Lock

1. Insert the locking device into the Kensington slot on the Monitor **B** and turn it in the locking direction **A**.
2. Connect the Kensington Lock cable.
3. Fix the Kensington Lock to a desk or a heavy stationary object.



Note

See Connecting Cables for further information regarding cable connections.

Remote Control







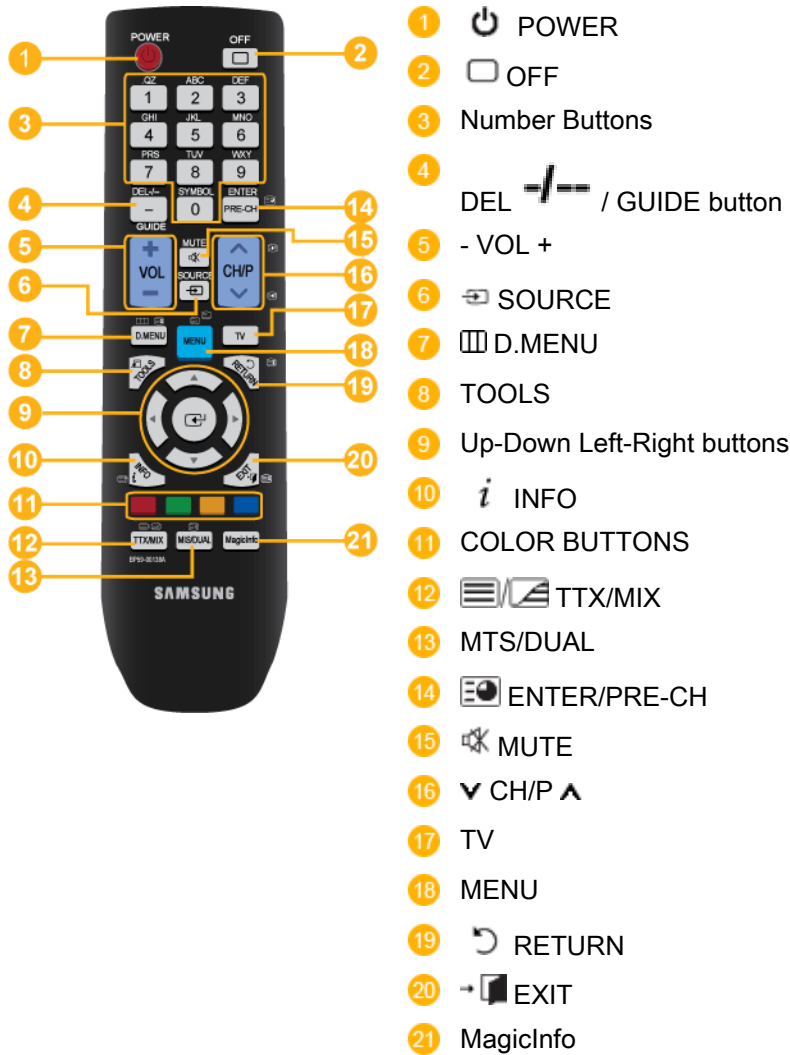



Note

The performance of the remote control may be affected by a TV or other electronic device operating near the PDP Display, causing a malfunction due to interference with the frequency.



- | | |
|------------------------|--|
| 1. POWER | Turns the product On. |
| 2. OFF | Turns the product Off. |
| 3. Number Buttons | Used to enter the password during the OSD adjustment or to use MagicInfo. |
| 4. DEL / GUIDE button | The "-" button is used to select Digital channels.
Electronic Program Guide (EPG) display.
- This button is disabled for this PDP display. |
| 5. - VOL + | Adjusts the audio volume. |
| 6. SOURCE | Press this button to switch to MagicInfo or PC mode or a connected external input source. |
| 7. D.MENU | DTV menu display
- This button is disabled for this PDP display. |
| 8. TOOLS | Use to quickly select frequently used functions.
- This button is disabled for this PDP display. |

9. Up-Down Left-Right buttons
Moves from one menu item to another horizontally, vertically or adjusts selected menu values.
10.  INFO
Current picture information is displayed on the upper left corner of the screen.
11. COLOR BUTTONS
Press to add or delete channels and to store channels to the favorite channel list in the "Channel List" menu.
- This button is disabled for this PDP display.
12.  TTX/MIX
TV channels provide written information services via teletext.
- Teletext Buttons

- This button is disabled for this PDP display.
13. MTS/DUAL
- This function does not work for this PDP Display.
MTS-
You can select MTS (Multichannel Television Stereo) mode.
- | | Audio Type | MTS/S_Mode | Default |
|-----------|------------|---------------|---------------|
| FM Stereo | Mono | Mono | Manual Change |
| | Stereo | Mono ↔ Stereo | Change |
| | SAP | Mono ↔ SAP | Mono |
- DUAL-*
STEREO/MONO, DUAL I / DUAL II and MONO/NICAM MONO/NICAM STEREO can be operated depending on the broadcasting type by using the DUAL button on the remote control while watching TV.
14.  ENTER/PRE-CH
This button is used to return to the immediately previous channel.
- This button is disabled for this PDP display.
15.  MUTE
Pauses (mutes) the audio output temporarily. This is displayed on the lower left corner of the screen. The audio comes back on if MUTE or - VOL + is pressed in the Mute mode.
16.  CH/P 
In **TV** mode, selects TV channels.
- This button is disabled for this PDP display.
17. TV
Selects the TV mode directly.
- This button is disabled for this PDP display.
18. MENU
Opens the on-screen menu and exits from the menu or closes the adjustment menu.
19.  RETURN
Returns to the previous menu.

20. →  EXIT

Exits from the menu screen.

21. MagicInfo

MagicInfo Quick Launch Button.



Note

This button is disabled for products that do not support MagicInfo.

Mechanical Layout(P50HP, P50HP-2)

Mechanical Layout

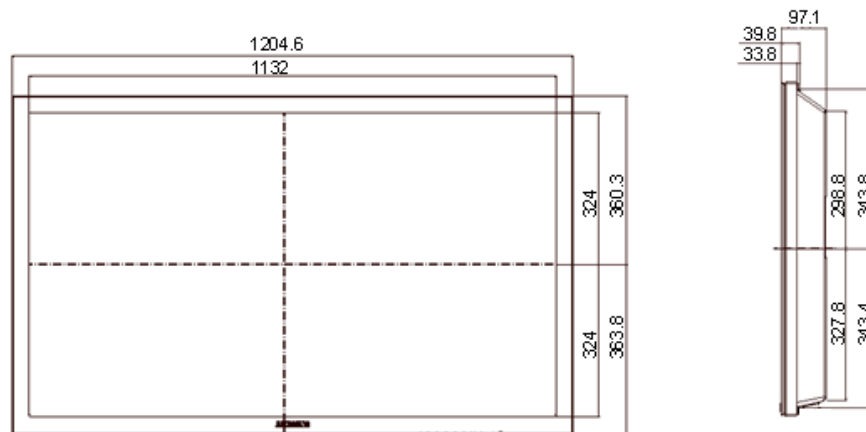

PDP Display Head

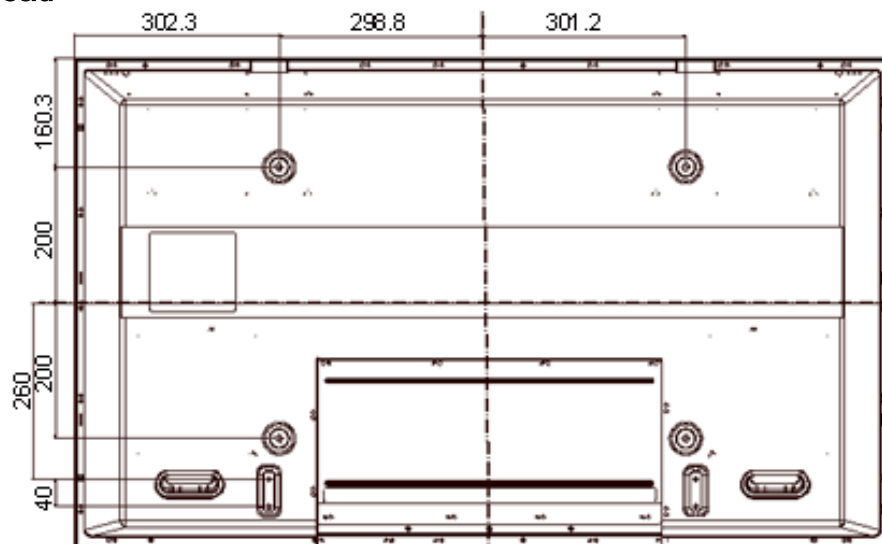

Installation VESA Bracket

- When installing VESA, make sure to comply with the international VESA standards.
- Purchasing VESA Bracket and Installation Information : Please contact your nearest SAMSUNG Distributor to place an order. After your order is placed, installation professionals will visit you and install the bracket.

- At least 2 persons are needed in order to move the PDP Display.
- SAMSUNG is not responsible for any product damage or any injury caused by installation at customer's discretion.

Dimensions

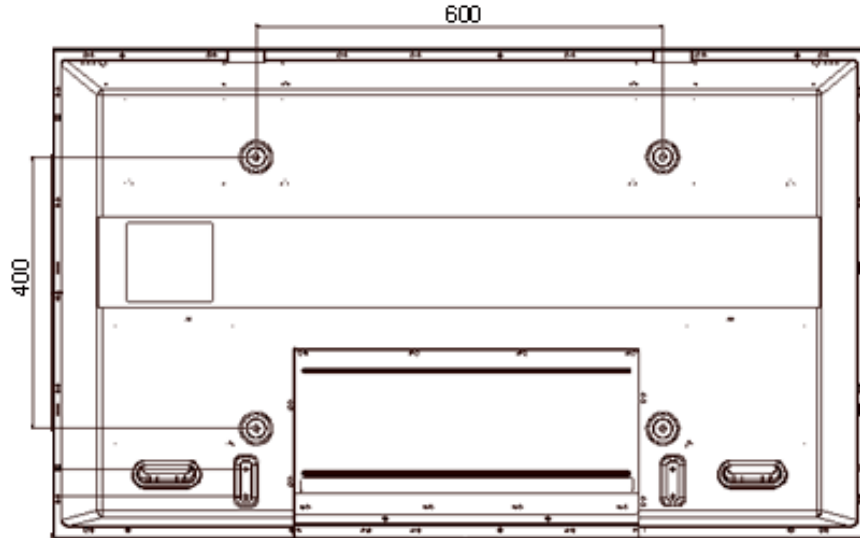

Notice

For securing the bracket on a wall, use only machine screws of 6 mm diameter and 8 to 12 mm length.

Wall Bracket Installation

- Contact a technician for installing the wall bracket.
- SAMSUNG Electronics is not responsible for any damages to the product or harm to customers when the installation is done by the customer.
- This product is for installing on cement walls. The product may not stay in place when installed on plaster or wood.

Components

Only use the components and accessories shipped with the product.



Wall Bracket(1)

Hinge(Left 1, Right 1)

Plastic Hanger (4)

Screw (A)(11)

Screw (B)(4)

Anchor (11)

Wall Bracket Assembly

 **Note**

There are two hinges(left and right). Use the correct one.

1. Insert and tighten the Captive Screw in the direction of the arrow.

When done, mount the wall bracket on the wall.

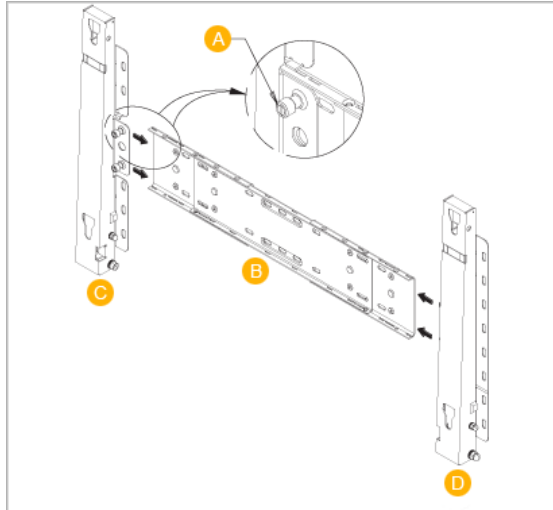

- A - Captive Screw
- B - Wall Bracket
- C - Hinge (Left)
- D - Hinge (Right)

2. Before drilling into the wall, check if the length between the two locking holes at the back of the product is correct.

If the length is too short or long, loosen all or some of the 4screws on the wall bracket to adjust the length.

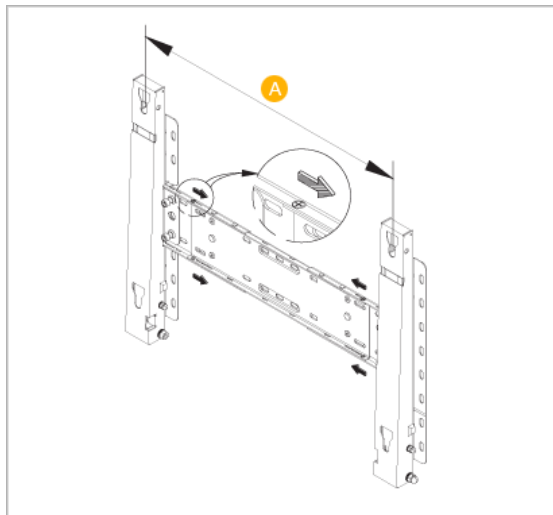

- A - Length between the two locking holes

3. Check the installation diagram and mark the drill points on the wall. Use the 5.0 mm bit to drill holes deeper than 35 mm. Fix each anchor in the corresponding hole. Match each

of the brackets and hinge holes to the corresponding anchor holes and insert and tighten the 11 screws A.

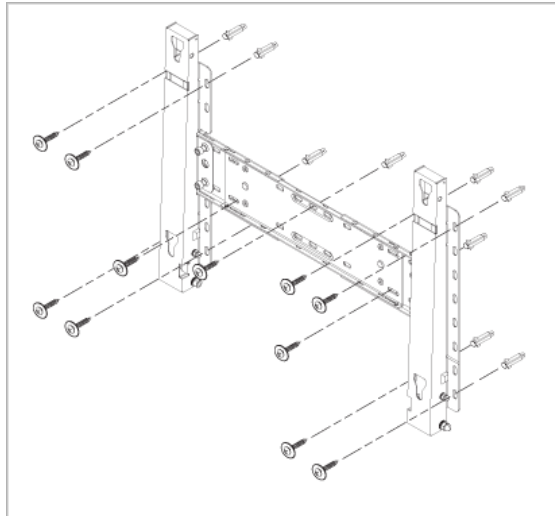

To mount the product on the wall bracket

The shape of the product may vary depending on the model. (The assemblies of the plastic hanger and the screw are the same)

1. Remove the 4 screws on the back of the product.

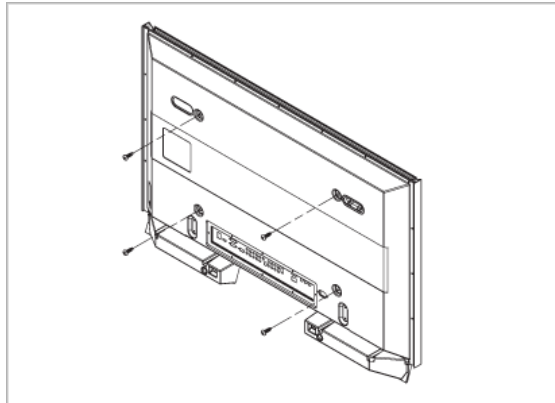

2. Insert the screw B into the plastic hanger.

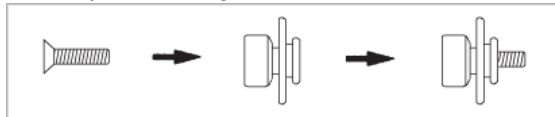

 **Notice**

- Mount the product on the wall bracket and make sure it is properly fixed to the left and right plastic hangers.
 - Be careful when installing the product on the bracket as fingers can be caught in the holes.
 - Make sure the wall bracket is securely fixed to the wall, or the product may not stay in place after installation.
3. Tighten the 4 screws in step 2 (plastic hanger + screw B) to the rear holes of the product.

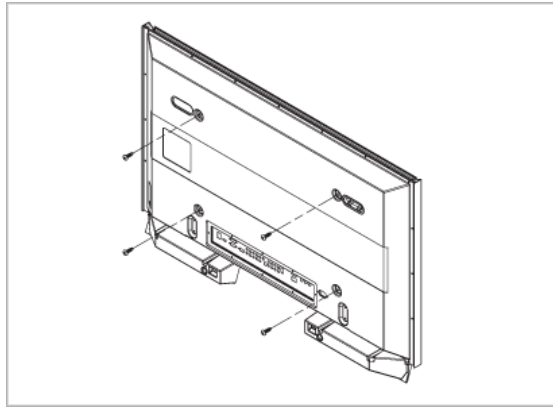

4. Remove safety pin (3) and insert the 4 product holders into the corresponding bracket holes (1). Then place the product(2) so that it is firmly fixed to the bracket. Make sure to re-insert and tighten the safety pin (3) to securely hold the product to the bracket.

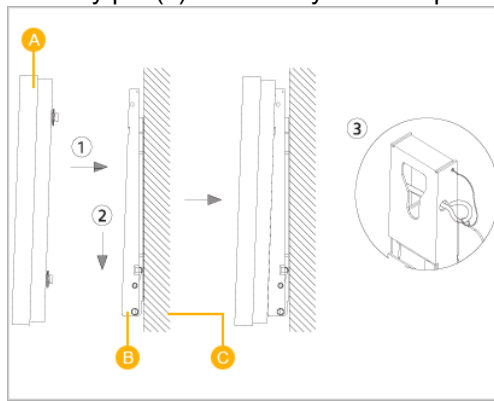

- A - PDP Display
- B - Wall Bracket
- C - Wall

Wall Bracket Angle Adjustment

Adjust the bracket angle to -2° before installing it on the wall.

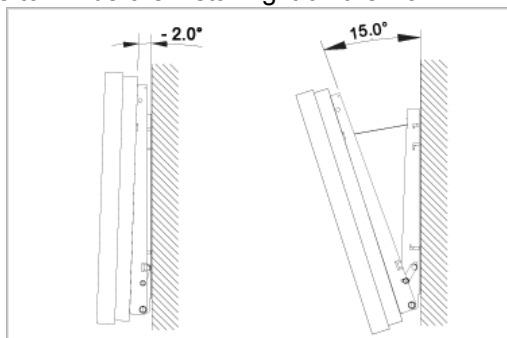

1. Fix the product to the wall bracket.
2. Hold the product at the top in the center and pull it forward (direction of the arrow) to adjust the angle.

 **Note**

You can adjust the bracket angle between -2° and 15° .

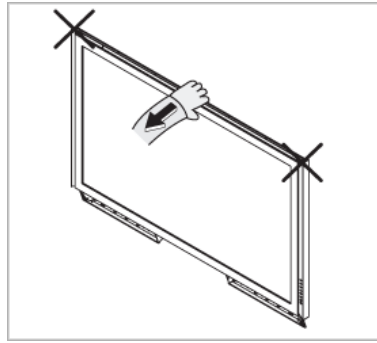

Make sure to use the top center, and not the left or the right side of the product to adjust the angle.

Mechanical Layout(P63FP, P63FP-2)

Mechanical Layout

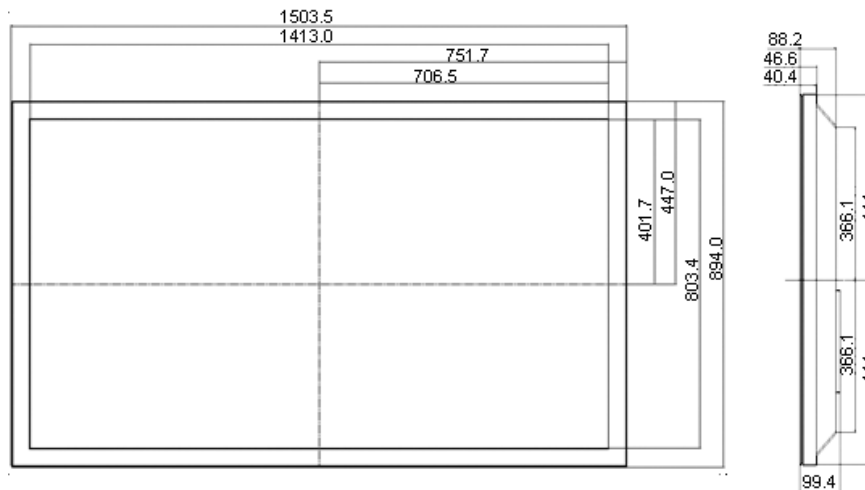

PDP Display Head

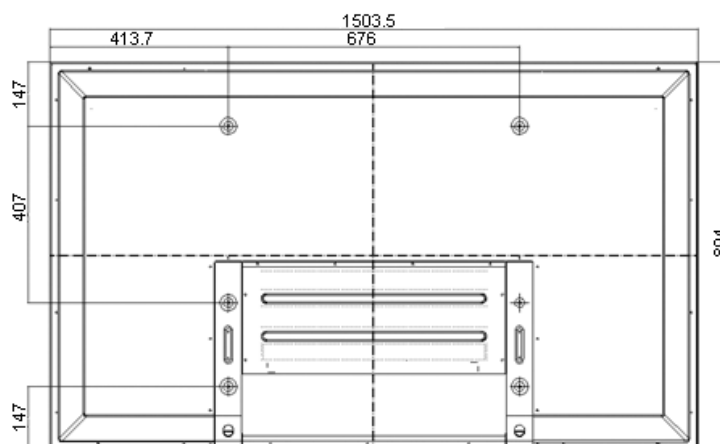

Installation VESA Bracket

- When installing VESA, make sure to comply with the international VESA standards.

- Purchasing VESA Bracket and Installation Information : Please contact your nearest SAMSUNG Distributor to place an order. After your order is placed, installation professionals will visit you and install the bracket.
- At least 2 persons are needed in order to move the PDP Display.
- SAMSUNG is not responsible for any product damage or any injury caused by installation at customer's discretion.

Dimensions

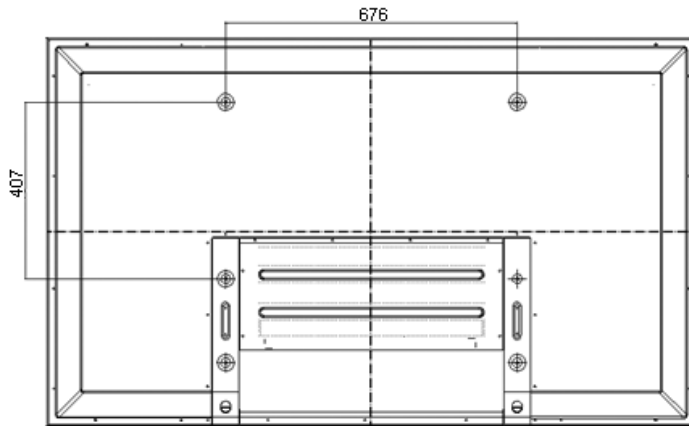

Notice

For securing the bracket on a wall, use only machine screws of 6 mm diameter and 8 to 12 mm length.

Wall Bracket Installation

- Contact a technician for installing the wall bracket.
- SAMSUNG Electronics is not responsible for any damages to the product or harm to customers when the installation is done by the customer.
- This product is for installing on cement walls. The product may not stay in place when installed on plaster or wood.

Components

Only use the components and accessories shipped with the product.



Wall Bracket(1)

Hinge(Left 1, Right 1)

Plastic Hanger (4)

Screw (A)(11)

Screw (B)(4)

Anchor (11)

Wall Bracket Assembly

 **Note**

There are two hinges(left and right). Use the correct one.

1. Insert and tighten the Captive Screw in the direction of the arrow.

When done, mount the wall bracket on the wall.

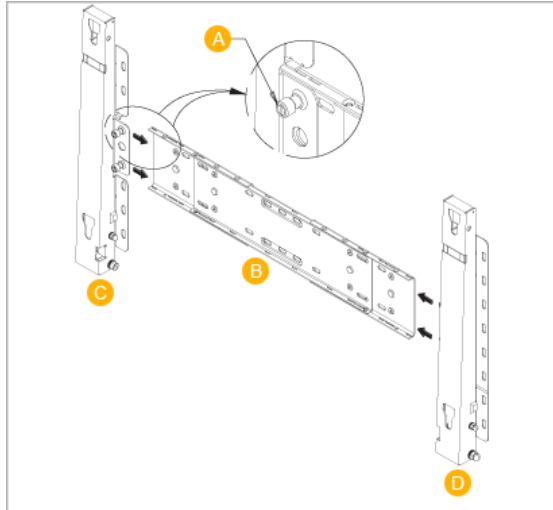

- A - Captive Screw
- B - Wall Bracket
- C - Hinge (Left)
- D - Hinge (Right)

2. Before drilling into the wall, check if the length between the two locking holes at the back of the product is correct.

If the length is too short or long, loosen all or some of the 4screws on the wall bracket to adjust the length.

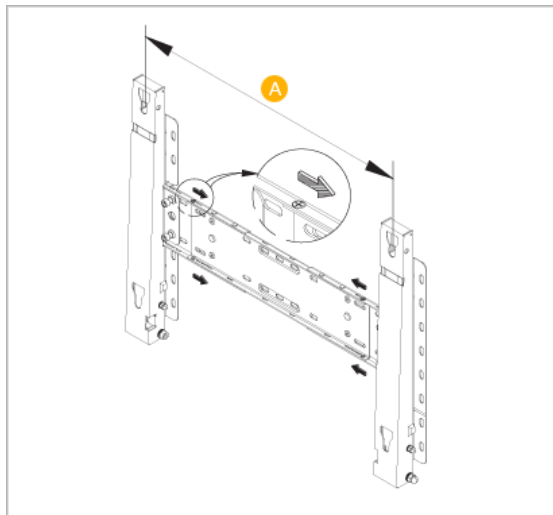

- A - Length between the two locking holes

3. Check the installation diagram and mark the drill points on the wall. Use the 5.0 mm bit to drill holes deeper than 35 mm. Fix each anchor in the corresponding hole. Match each

of the brackets and hinge holes to the corresponding anchor holes and insert and tighten the 11 screws A.

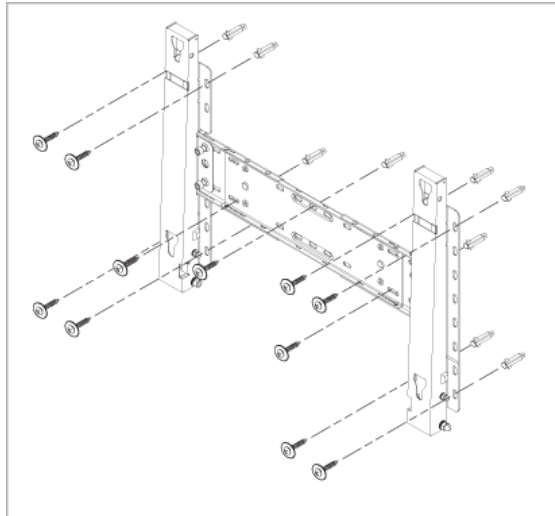

To mount the product on the wall bracket

The shape of the product may vary depending on the model. (The assemblies of the plastic hanger and the screw are the same)

1. Remove the 4 screws on the back of the product.

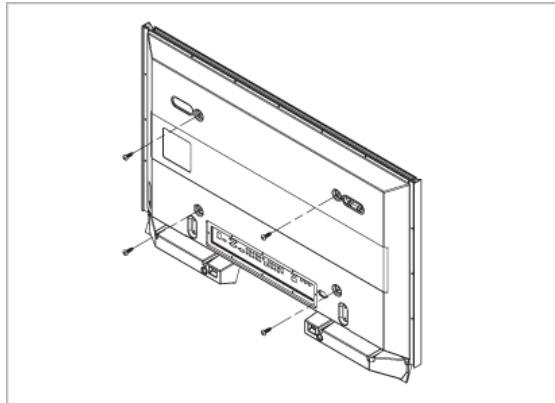

2. Insert the screw B into the plastic hanger.

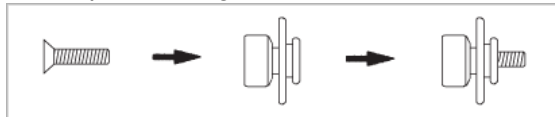

 **Notice**

- Mount the product on the wall bracket and make sure it is properly fixed to the left and right plastic hangers.
 - Be careful when installing the product on the bracket as fingers can be caught in the holes.
 - Make sure the wall bracket is securely fixed to the wall, or the product may not stay in place after installation.
3. Tighten the 4 screws in step 2 (plastic hanger + screw B) to the rear holes of the product.

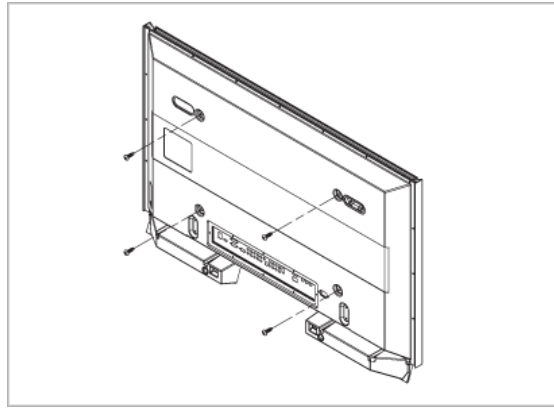

4. Remove safety pin (3) and insert the 4 product holders into the corresponding bracket holes (1). Then place the product(2) so that it is firmly fixed to the bracket. Make sure to re-insert and tighten the safety pin (3) to securely hold the product to the bracket.

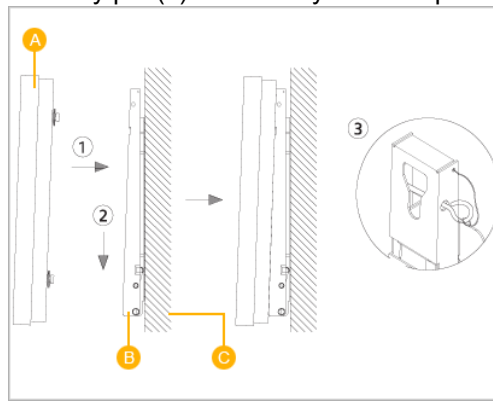

- A - PDP Display
- B - Wall Bracket
- C - Wall

Wall Bracket Angle Adjustment

Adjust the bracket angle to -2° before installing it on the wall.

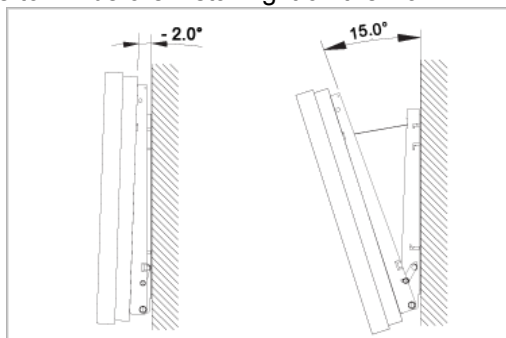

1. Fix the product to the wall bracket.
2. Hold the product at the top in the center and pull it forward (direction of the arrow) to adjust the angle.

 **Note**

You can adjust the bracket angle between -2° and 15° .

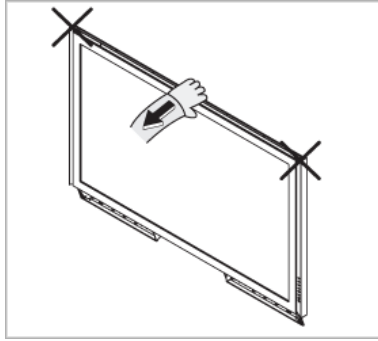

Make sure to use the top center, and not the left or the right side of the product to adjust the angle.

Connections

Connecting a Computer

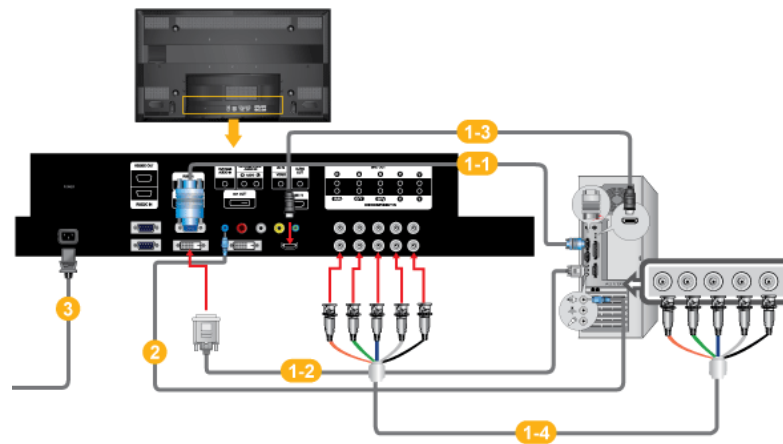

- 1 There are several ways to connect the computer to the monitor. Choose one from the following options.

1-1 Using the D-sub (Analog) connector on the video card.

- Connect the D-sub to the 15-pin, [RGB IN] port on the back of your PDP Display and the 15 pin D-sub Port on the computer.



1-2 Using the DVI (Digital) connector on the video card.

- Connect the DVI Cable to the [DVI IN] port on the back of your PDP Display and the DVI port on the computer.



1-3 Using the HDMI (digital) output on the graphics card.

- Connect the [HDMI IN] port on the PDP Display to the HDMI port on the PC using the HDMI cable.



 **Note**

When the HDMI cable to the PC, ensure that you select **HDMI** from both the **Source List** and **Edit Name** before selecting **PC** or **DVI** device so that normal PC screen and sound can be outputted. Note that sound is only available when connected according to the option **2** that follows.

1-4 Using the BNC (Analog) connector on the video card.

- Connect the [BNC/COMPONENT IN] port on the monitor to the BNC port on the PC using the BNC to BNC cable.

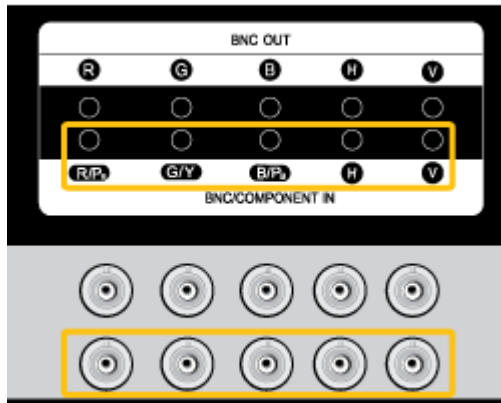

- 2 Connect the audio cable for your PDP Display to the audio port on the back of the PDP Display.
- 3 Connect the power cord for your PDP Display to the power port on the back of the PDP Display. .

 **Note**

- Turn on both your computer and the PDP Display.
- Contact a local SAMSUNG Electronics Service Center to buy optional items.

Connecting to Other devices

- AV input devices such as DVD players, VCRs or camcorders as well as your computer can be connected to the PDP Display. For detailed information on connecting AV input devices, refer to the contents under Adjusting Your PDP Display.
- The PDP Display's configuration at the back may vary slightly depending on the PDP Display model.

Connecting AV Devices

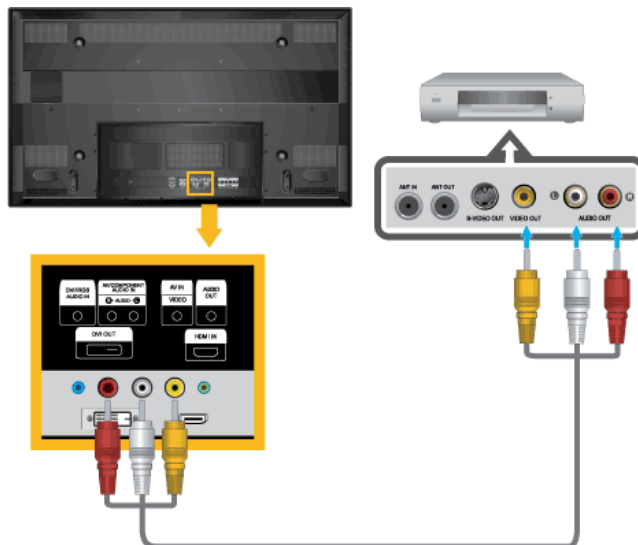

1. Connect an audio cable to the audio output port on the external device and [AV/COMPONENT AUDIO IN[R-AUDIO-L]] port on the monitor, and connect the video output port on the external device to the [AV IN [VIDEO]] port on the monitor.
2. Play the DVD, VCR or Camcorder with a DVD disc or tape inserted.
3. Select **AV** using the SOURCE button on the front of the PDP display or on the remote.

Connecting to a Camcorder

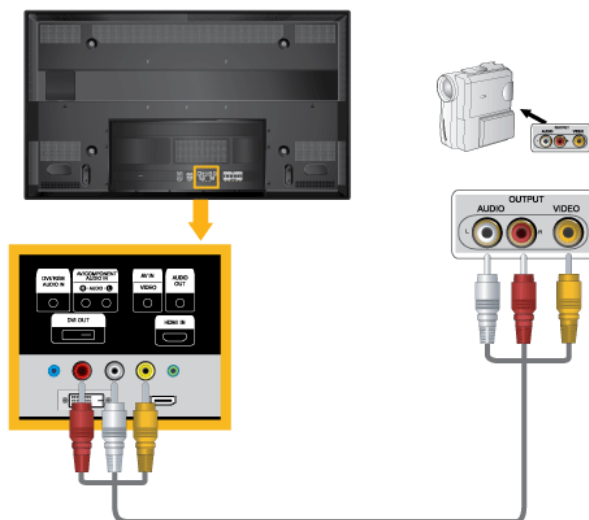

1. Locate the AV output jacks on the camcorder. They are usually found on the side or back of the camcorder. Connect a set of audio cables between the AUDIO OUTPUT jacks on the camcorder and the [AV/COMPONENT AUDIO IN [R-AUDIO-L]] on the PDP Display .
2. Connect a video cable between the VIDEO OUTPUT jack on the camcorder and the [AV IN [VIDEO]] on the PDP Display .
3. Select **AV** for the Camcorder connection using the SOURCE button on the front of the PDP Display or on the remote control.
4. Then, start the Camcorder with a tape inserted.

Note

The audio-video cables shown here are usually included with a Camcorder. (If not, check your local electronics store.) If your camcorder is stereo, you need to connect a set of two cables.

Connecting the BNC to BNC cable

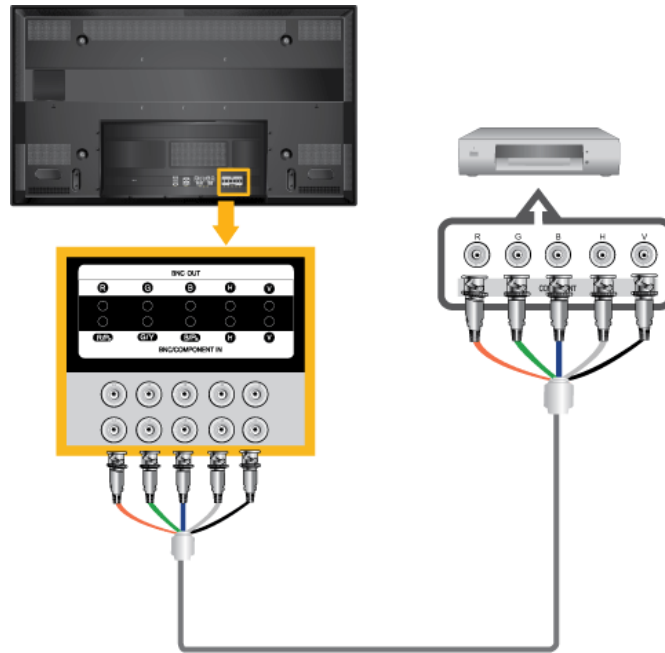

1. Connect the [BNC/COMPONENT IN [R/P_R, G/Y, B/P_B]] ports on the monitor to the BNC port on the external device using the BNC to BNC cable.
2. Select BNC using the SOURCE button on the front of the PDP Display or on the remote control.

Connecting Using a DVI Cable

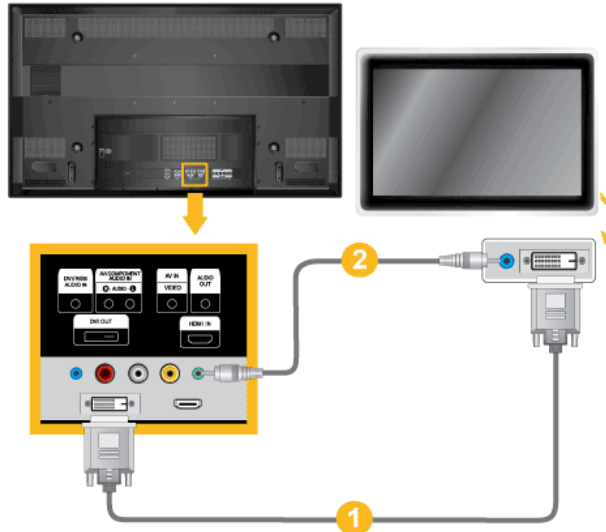

1. Connect between the [DVI OUT] port on the PDP Display and the input port on another monitor using a DVI cable.
2. Connect between the [AUDIO OUT] port on the PDP Display and the audio input port on another monitor using a stereo cable.
3. Select DVI using the SOURCE button on the front of the PDP Display or on the remote control.

 **Note**

DVI OUT does not support HDCP.

Connecting Using a HDMI Cable

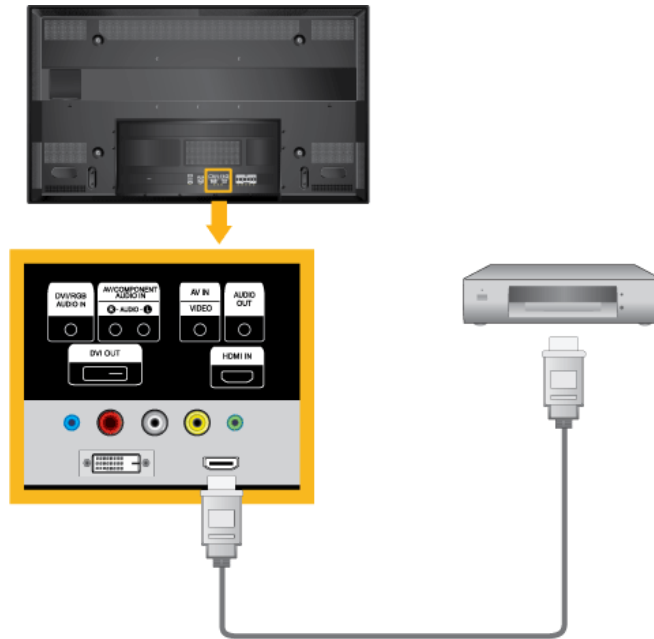

1. Connect input devices such as a Blu-Ray/DVD player to the [HDMI IN] terminal of the PDP Display using an HDMI cable.
2. Select HDMI using the SOURCE button on the front of the PDP Display or on the remote control.

 **Note**

In **HDMI** mode, only PCM format audio is supported.

Connecting Using a DVI to HDMI Cable

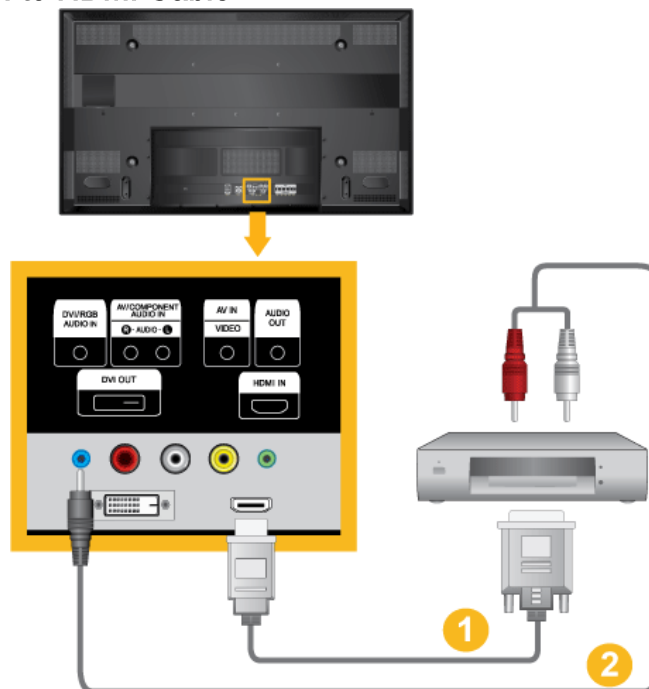

1. Connect the DVI output terminal of a digital output device to the [HDMI IN] terminal of the PDP Display using a DVI to HDMI cable.

2. Connect the red and white jacks of an RCA to stereo (for PC) cable to the same colored audio output terminals of the digital output device, and connect the opposite jack to the [DVI / RGB AUDIO IN] terminal of the PDP Display.
3. Select HDMI using the SOURCE button on the front of the PDP Display or on the remote control.

Connecting a DVD Player

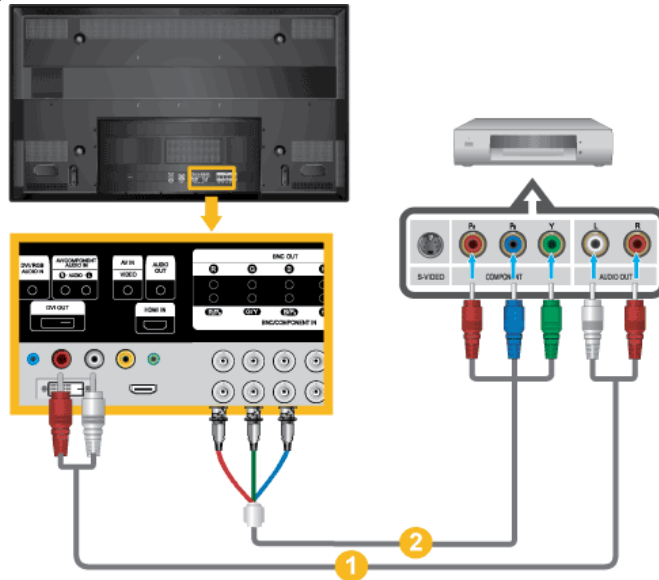

1. Connect a set of audio cables between the [AV/COMPONENT AUDIO IN [R-AUDIO-L]] on the PDP Display and the AUDIO OUT jacks on the DVD player.
2. Connect a Component cable between the [BNC/COMPONENT IN [R/P_R, G/Y, B/P_B]] port on the PDP Display and the P_R, Y, P_B jacks on the DVD player.

Note

- Select **Component** for the connection to a DVD player using the SOURCE button on the front of the PDP Display or on the remote control.
- Then, start the DVD Player with a DVD disc inserted.
- A component cable is optional.
- For an explanation of Component video, consult your DVD manual.

Connecting a DTV Set Top (Cable/Satellite) Box

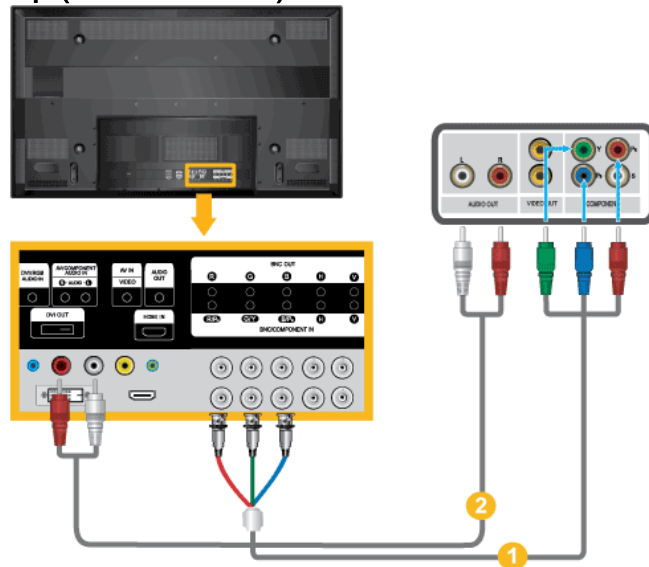

1. Connect a Component cable between the [BNC/COMPONENT IN [R/P_R, G/Y, B/P_B]] port on the PDP Display and the P_R, Y, P_B jacks on the Set Top Box.
2. Connect a set of audio cables between the [AV COMPONENT AUDIO IN [R-AUDIO-L]] on the PDP Display and the AUDIO OUT jacks on the Set Top Box.

Note

- Select **Component** for the connection to a DTV Set Top Box using the SOURCE button on the front of the PDP Display or on the remote control.
- For an explanation of Component video, see your Set Top Box owner's manual.

Connecting to an Audio System

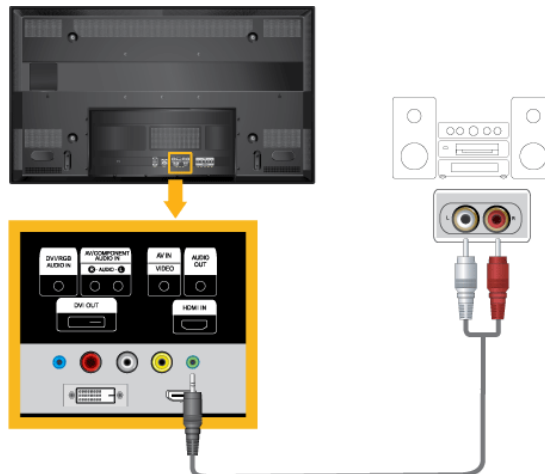



1. Connect a set of audio cables between the AUX L, R jacks on the AUDIO SYSTEM and [AUDIO OUT] on PDP Display.

Using the Software

MDC



Installation

1. Insert the installation CD into the CD-ROM drive.
2. Click the Serial MDC installation program.
 **Note**
If the screen for installing the software does not appear, install it using the Serial MDC execution file in the MDC folder of the CD-ROM.
3. If the installation wizard screen does appear, click "Next."
4. The "License Agreement" screen will appear. Click "Yes."
5. The "Customer Information" window will appear. Register the user information and click "Yes."
6. The "Choose Destination Location" window will appear. Specify the file location to install to and click "Next."
 **Note**
If the file location is not specified, the program will be installed in the default file location.
7. The "Start Copying Files" window will appear. Confirm the file location and click "Next."
8. The installation progress screen will appear.
9. The "InstallShield Wizard Complete" screen will appear. Click "Finish."
 **Note**
Select "Launch Serial MDC" and click "Finish." The MDC program will immediately be run.
10. If the installation is successfully completed, the quick Serial MDC execution icon will appear on the desktop.

MDC execution icon may not appear depending on specification of computer system or monitor. If that happens, press F5 Key.

Installation Problems

The installation of MDC can be affected by such factors as the video card, motherboard and the network environment.

Uninstall

The MDC program can be removed only by using the "Add or Remove Programs" option of the Windows® Control Panel.

Perform the following steps remove MDC.

Select "Setting/Control Panel" on the "Start" menu and then double-click "Add/Delete a program".

Select Serial MDC from the list and then click the "Add/Delete" button.

■ Using Serial MDC

Multiple Display Control *MDC System*

Introduction

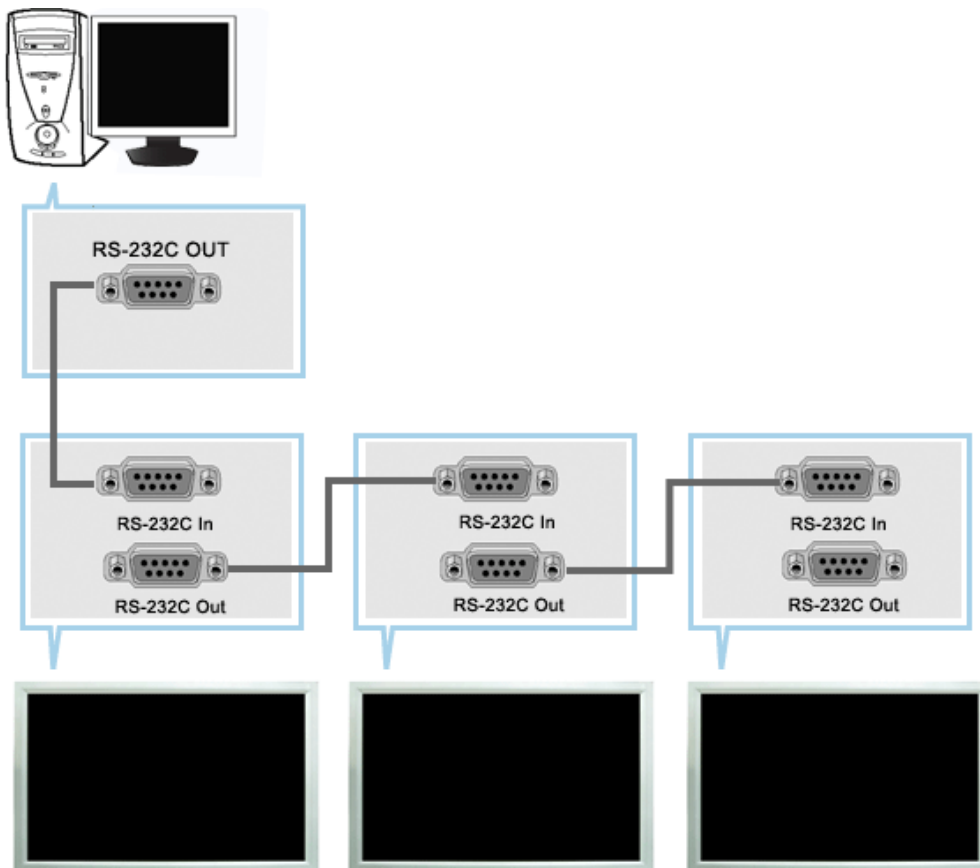

A Multiple Display Control (MDC) is an application allowing various displays to be easily and simultaneously operated on a PC. RS-232C, a standard of serial communication, is used for the communication between a PC and a display. Therefore, a serial cable should be connected between the serial port on a PC and the serial port on a display.

Main Screen

Click Start > Program > Samsung > MDC System to start the program.

Select a set to see the volume of the selected set within the slider.

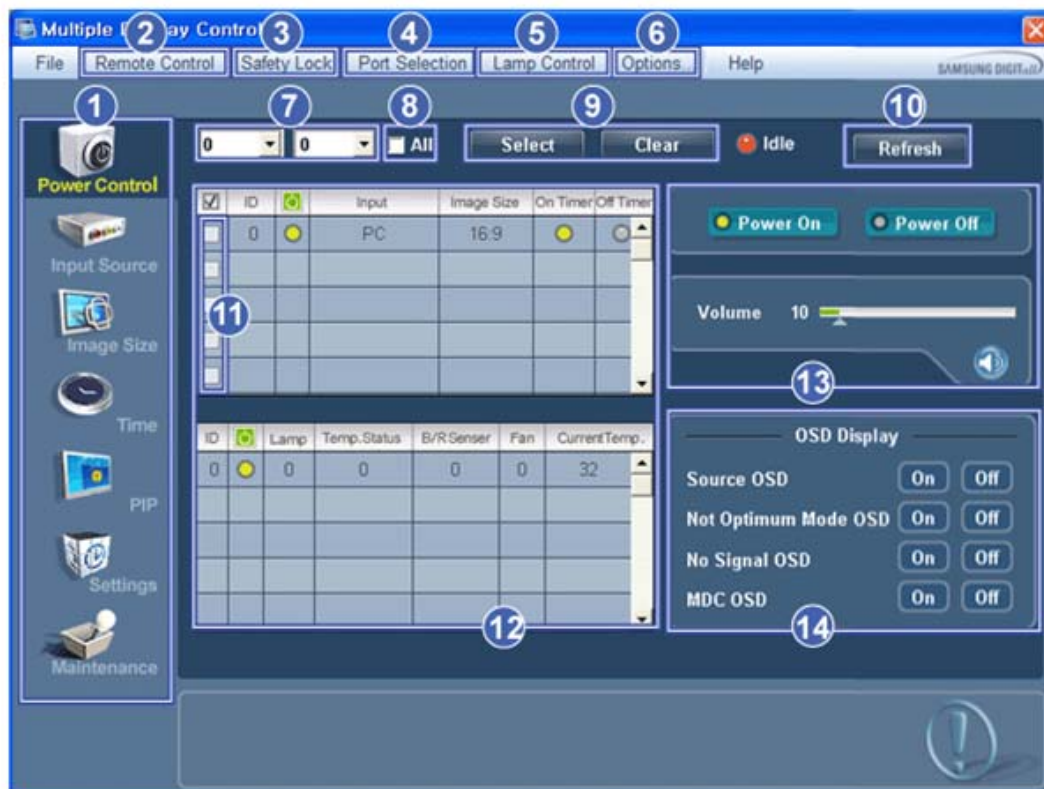

- | | |
|-----------------------------|-----------------------------|
| 1 Main Icons | 8 All |
| 2 Remote control | 9 Selection Buttons |
| 3 Safety Lock | 10 Refresh |
| 4 Port Selection | 11 Display Selection |
| 5 Lamp Control | 12 Info Grid |
| 6 Option... | 13 Control Tools |
| 7 Dropdown Selectors | 14 OSD Display |

1. Use the main icons to switch into each screen.
2. Allows you to enable or disable the remote control signal receiving function of the display unit.
3. Set the Safety Lock function.
When setting the Lock function, you can only operate power and lock buttons on the remote control and set.
4. The setting for the PC Serial Port can change. The original value is COM1.
5. Selects a Lamp adjustment mode.
6. Adjusts the number of LFD IDs and the frequency of search repeats.
7. Defines the range of LFD IDs to display. You can select or deselect the displayed IDs using the Select or Clear button.
8. All of the monitors can be selected or deselected.
9. Selects (Select) or deselects (Clear) LFD IDs displayed by configuring 7 and 8.
10. This searches for monitors. The maximum number is indicated in the Max LFD Id field.
11. Select a display from Display Selection.
12. Use Grid to view brief information on selected display.
13. Use Control Tools to control displays.

14. Switches the OSD function On/Off.
 - May not be supported depending on the product.

<Note> The remote control Enable/Disable function operates whether or not the power is On/Off, and this applies to all displays connected to the MDC. However, regardless of the status at the time the MDC is shut down, the remote control signal receiving function of all displays is initialized to Enable when the MDC is closed.

Port Selection

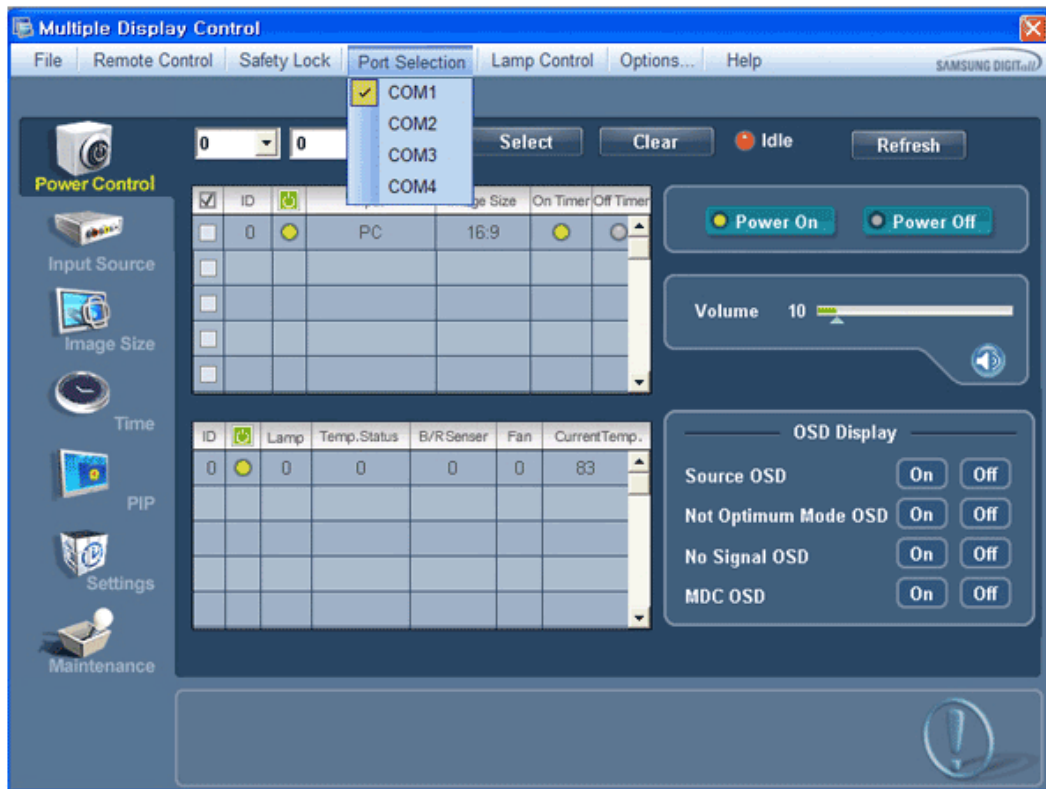

1. The Multiple Display Control is originally set to COM1.
2. If any port other than COM1 is used, COM1 through COM4 can be selected in the Port Selection Menu.
3. If the exact port name that is connected to the LCD Display using a serial cable is not selected, communication will be unavailable.
4. The selected port is stored in the program and used for the next program as well.



Power Control

1. Click Power Control of the main icons and the Power Control screen appears.

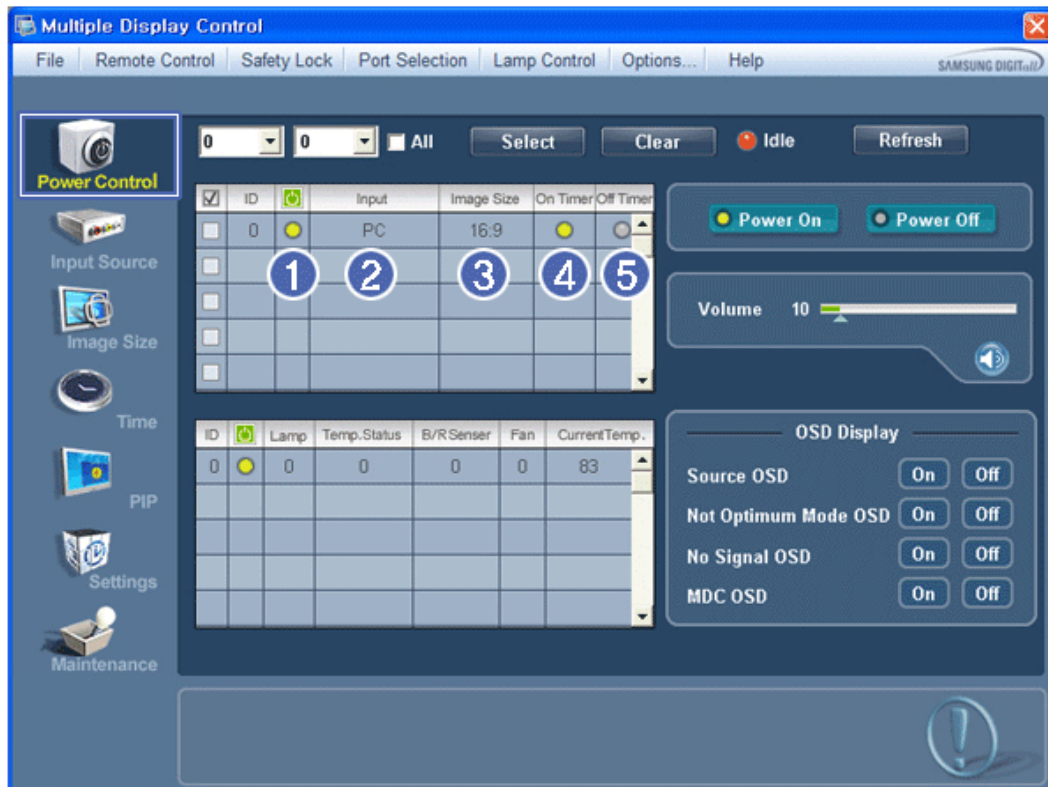

* Info Grid shows some basic information necessary to Power Control.

- 1)  (Power Status)
- 2) Input
- 3) Image Size
- 4) On Timer
- 5) Off Timer

2. Selects displays you want to adjust using the Select button or checkboxes.

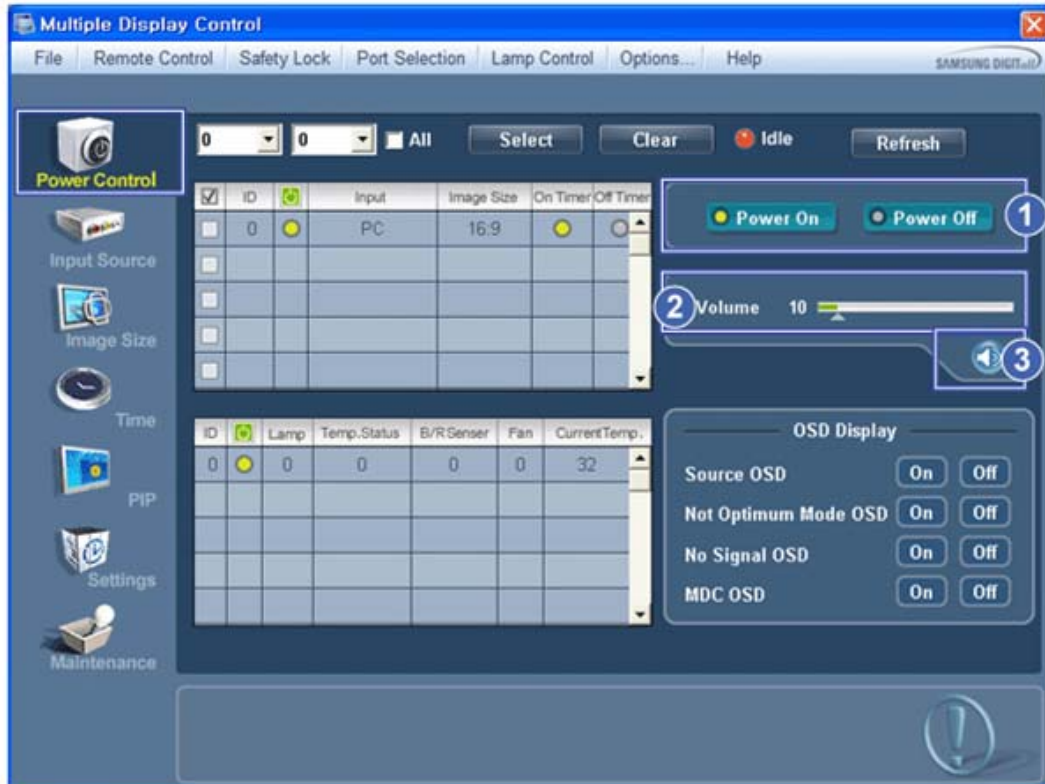

* Power Control allows controlling some of the functions of the selected display.

1) Power On/Off

- Turns the power of the selected display On/Off.

2) Volume

- Controls the volume level of the selected display.

It receives the volume value of the selected display from the sets and displays it in the slider.

(If you deselect a single display or all displays, the default value 10 will be restored.)

3)  (Mute On/Off)

- Turns on/off the Mute function of the selected display.

When selecting one set at a time, turn on the Mute function for the selected set.

The Mute function is disabled automatically when you adjust the volume level.

(The values return to the default settings when you undo the selections or choose "Select All".)

* **The Power Control feature is available for all displays.**

* **The Volume Control and Mute features are available only for the displays whose power status is ON.**

3. Selects whether to display the menu screen using the OSD Display menu.

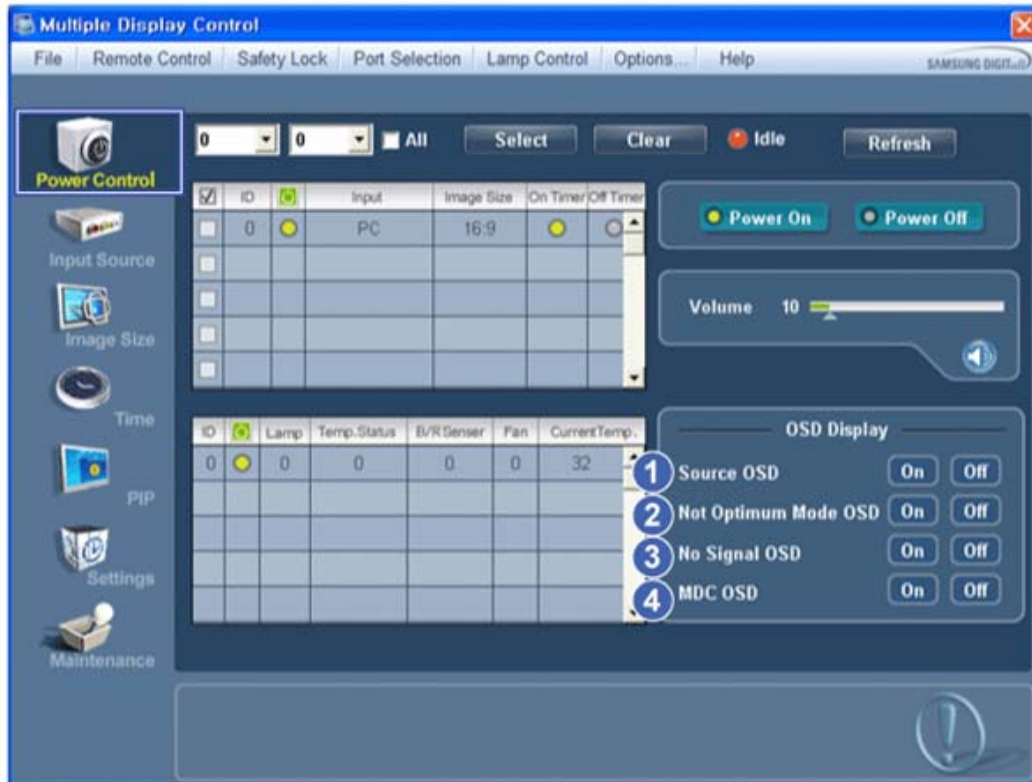

- 1) Source OSD
 - Sets whether the Source OSD will be displayed to indicate when the Source is changed.
- 2) Not Optimum Mode OSD
 - Sets whether the Optimum Mode OSD will be displayed to indicate if the current mode is not supported.
- 3) No Signal OSD
 - Sets whether the No Signal OSD will be displayed to indicate when there is no signal.
- 4) MDC OSD
 - Sets whether the MDC OSD will be displayed to indicate when the settings are changed using the MDC.



Input Source

1. Click Input Source of the main icons and the Input Source control screen appears.
 - Selects displays you want to adjust using the Select button or checkboxes.
- TV Mode

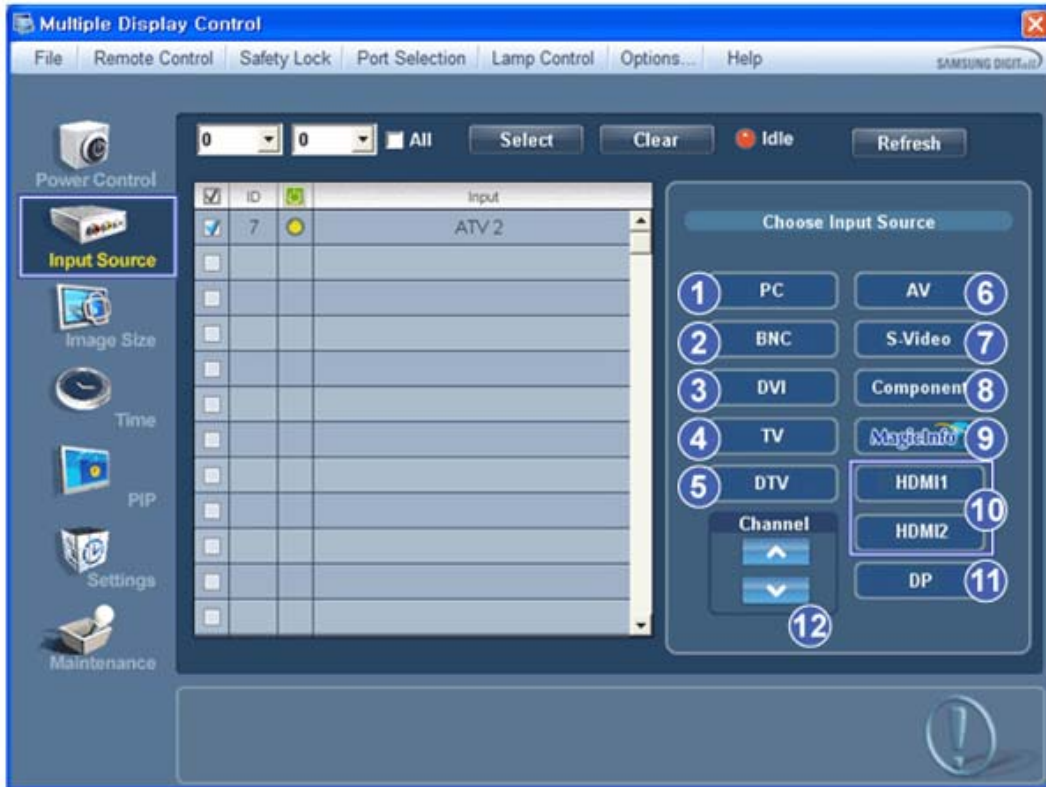

• PC Mode

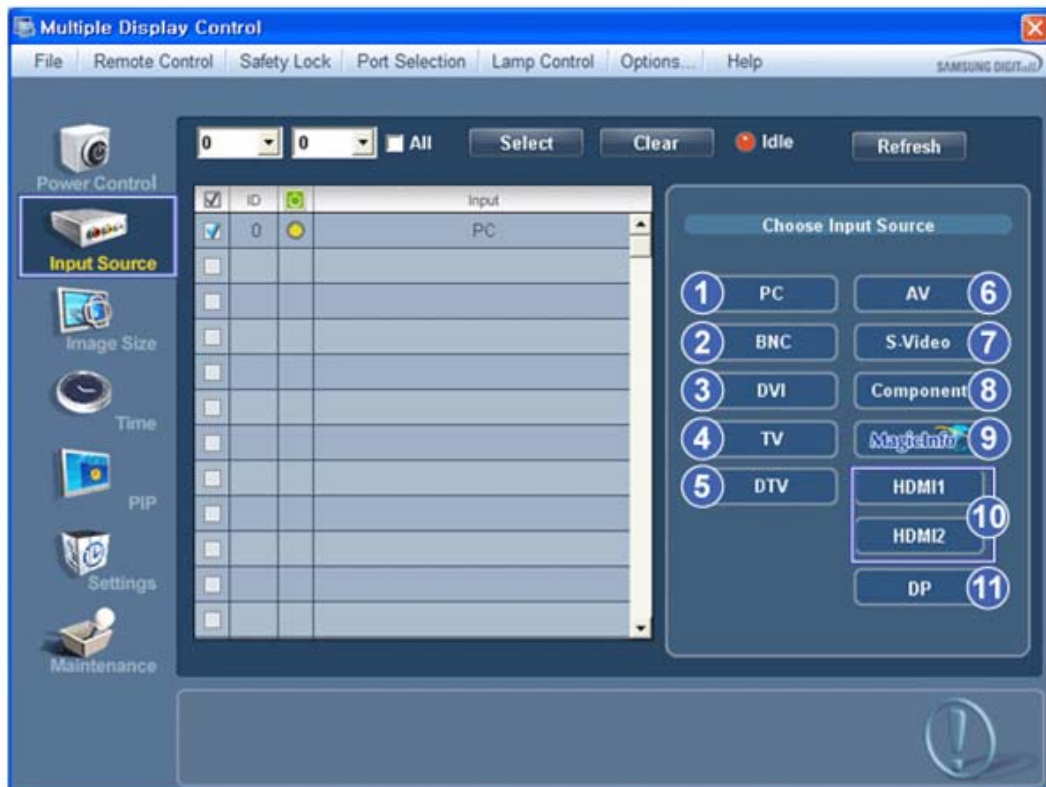

* Info Grid shows some basic information necessary to Input Source Control.

1) PC

- Changes the Input Source of the selected display to PC.
- 2) BNC
 - Changes the Input Source of the selected display to BNC.
- 3) DVI
 - Changes the Input Source of the selected display to DVI.
- 4) TV
 - Changes the Input Source of the selected display to TV.
- 5) DTV
 - Changes the Input Source of the selected display to DTV.
- 6) AV
 - Changes the Input Source of the selected display to AV.
- 7) S-Video
 - Changes the Input Source of the selected display to S-Video.
- 8) Component
 - Changes the Input Source of the selected display to Component.
- 9) MagicInfo
 - The Input source of MagicInfo works only on MagicInfo model.
- 10) HDMI1/HDMI2
 - Changes the Input Source of the selected display to HDMI.
- 11) DP
 - Switches the input source for the selected Display to DP.
- 12) Channel
 - Channel arrow appears when the Input Source is TV.

*** HDMI2 may not be supported depending on the product.**

*** DP may not be supported depending on the product.**

*** TV Source can be selected only in products with TV and controlling channels is allowed only when Input Source is TV.**

*** The Input Source Control feature is available only for the displays whose power status is ON.**



Image Size

PC, BNC, DVI, DP

1. Click Image Size of the main icons and the Image Size control screen appears.

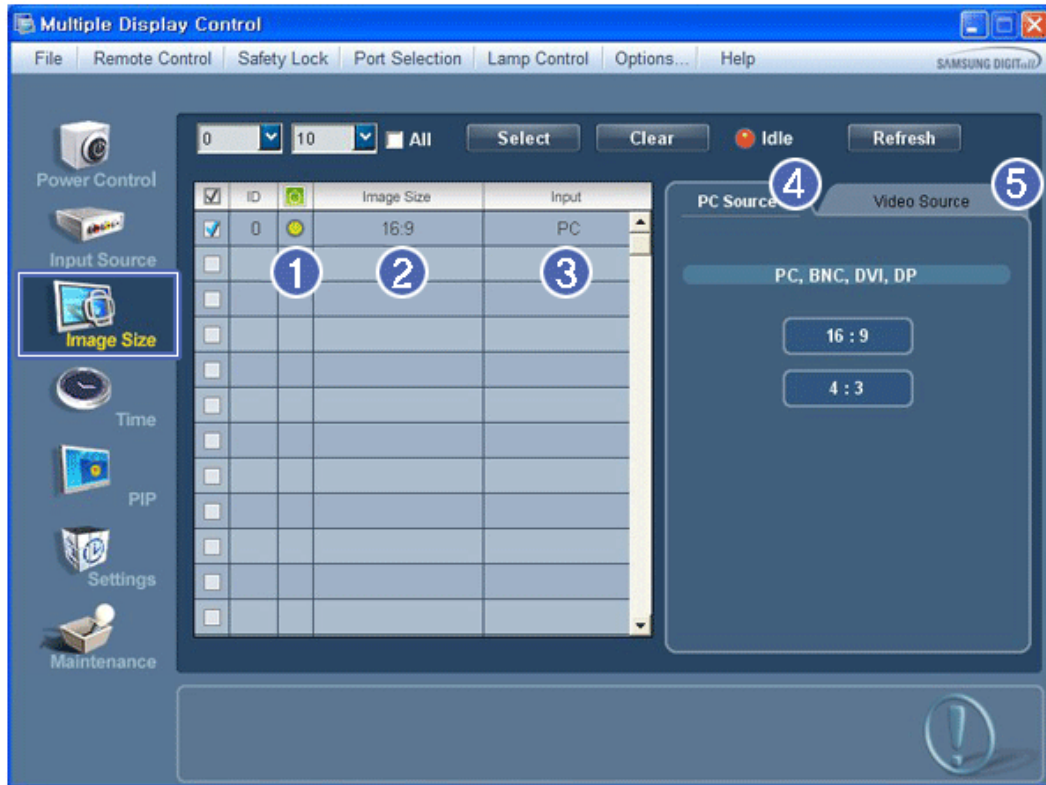

✱ Info Grid shows some basic information necessary to Image Size Control.

- 1)  (Power Status)
 - Shows the power status of the current display.
- 2) Image Size
 - Shows the current Image Size of the display in use.
- 3) Input
 - Info Grid displays only the displays whose Input Source is PC, BNC, DVI and DP.
- 4) PC Source
 - Click Image Size in the main menu to display the PC, BNC, DVI and DP tabs.
 - The Image Size Control button controls Image Size available for PC, BNC, DVI and DP.
- 5) Video Source
 - Using the Image Size adjustment button, you can adjust the Image Size to a value available in the PC, BNC, DVI and DP.

✱ DP may not be supported depending on the product.

✱ The Input source of MagicInfo works only on MagicInfo model.

✱ The Input source of TV works only on TV model.

✱ Image Size Control is available only for the displays for which power status is ON.

Image Size

TV, AV, S-Video, Component, DVI(HDCP), HDMI1, HDMI2, DTV.

1. Click Image Size of the main icons and the Image Size control screen appears.

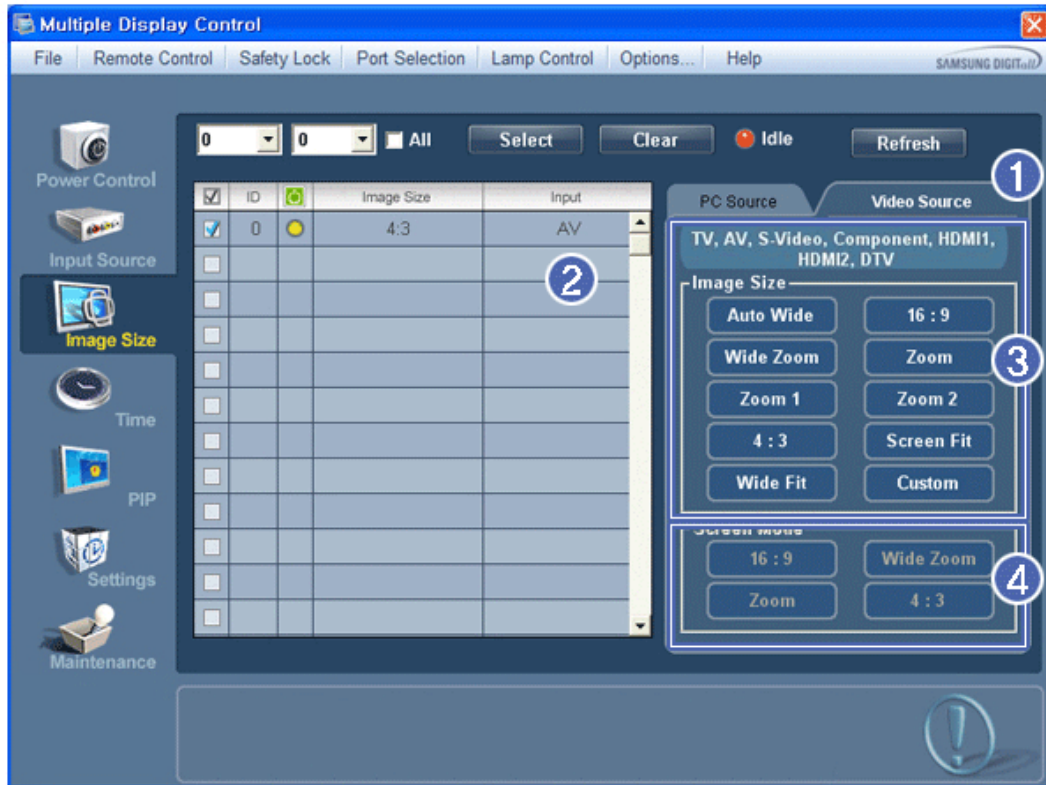

✦ Info Grid shows some basic information necessary to Image Size Control.

- 1) To adjust Image Size in TV, AV, S-Video, Component, HDMI1, HDMI2 or DTV mode, click the Video Source tab. Select the display you want to adjust by using the Select button or by checking the checkbox.
- 2) Info Grid displays only the display having TV, AV, S-Video, Component, HDMI1, HDMI2 or DTV as input source.
- 3) Switch Image Size of the selected display randomly.
- 4) The screen modes can only be adjusted when a TV (PAL only) is connected and the Image Size item is set to Auto Wide.

✦ **HDMI2 may not be supported depending on the product.**

✦ **Custom may not be supported depending on the product.**

✦ **Auto Wide, Zoom1 and Zoom2 are not available for selection when the input signal type for Component and DVI (HDCP) is 720p or 1080i.**
(The Auto Wide mode is available only for TV, AV, and S-Video.)

✦ **The Input source of MagicInfo works only on MagicInfo model.**

✦ **The Input source of TV works only on TV model.**

✦ **The Image Size Control feature is available only for the displays whose power status is ON.**



Time

1. Click Time of the main icons and the Time Control screen appears.

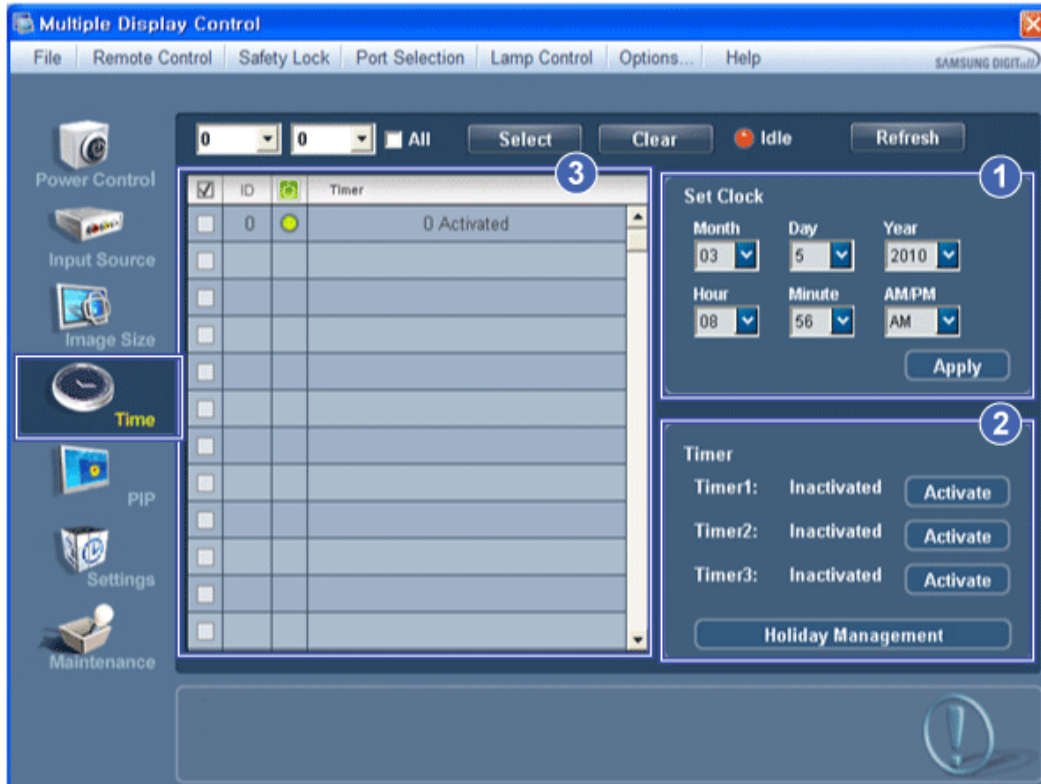

✱ Info Grid shows some basic information necessary to Time Control.

- 1) Set clock
 - Set the current time for the selected display (PC Time).
 - To change the current time, first change the PC Time.
- 2) Timer
 - Sets up Timer1, Timer2, Timer3 and Holiday Management.
- 3) Shows whether Timer is activated.

✱ **The Input source of MagicInfo works only on MagicInfo model.**

✱ **The Input source of TV works only on TV model.**

✱ **Time Control is available only for the displays for which the power status is ON.**



Time

Setting up Timer and Holiday Management

1. 1. Setting up Timer1, Timer2 and Timer3



- 1) On Time
 - Sets the time in hours, in minutes and as AM/PM for turning the selected monitor on.
- 2) Off Time
 - Sets the time in hours, in minutes and as AM/PM for turning the selected monitor off.
- 3) Volume
 - Selects the volume when the selected monitor is turned on.
- 4) Source
 - Selects the external input source that will be displayed when the selected monitor is turned on.
- 5) Holiday
 - Applies the Holiday Management function to the Timer.
- 6) Repeat
 - Available selections include Once, Everyday, Mon~Fri, Mon~Sat, Sat~Sun, and Manual.
 - Once : The Timer goes off only once.
 - Everyday : Everyday: The Timer repeats daily.
 - Mon~Fri : The Timer repeats from Monday through Friday.
 - Mon~Sat : The Timer repeats from Monday through Saturday.
 - Sat~Sun : Sat~Sun: The Timer goes off on Saturday and Sunday.
 - Manual : Select a day of the week you want the Timer to go off.

2. Setting Holiday Management

The Holiday Management function specifies the dates in which the monitor will not be turned on or off by the Timer.

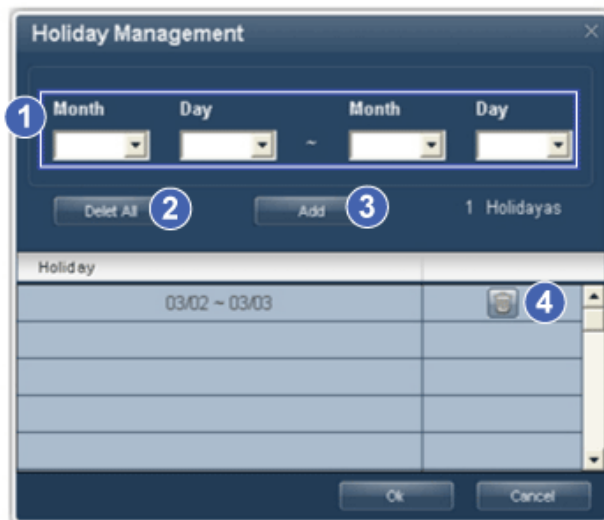

- 1) Specifies the date.
- 2) Delete All
 - Deletes all of the holidays.
- 3) Add
 - Adds the specified date.
- 4) 
 - Deletes the schedule in the selected line.

- * The Holiday Management function can be turned on or off in the Timer setup menu.
- * The Input source of MagicInfo works only on MagicInfo model.
- * The Input source of TV works only on TV model.
- * Time Control is available only for the displays for which the power status is ON.
- * Only enabled for a TV when Source is set to TV in On Time mode.
- * Only enabled for a model with MagicInfo installed when Source is set to MagicInfo in On Time mode.



PIP Size

1. Click PIP of the main icons and the PIP control screen appears.
 - Selects displays you want to adjust using the Select button or checkboxes.

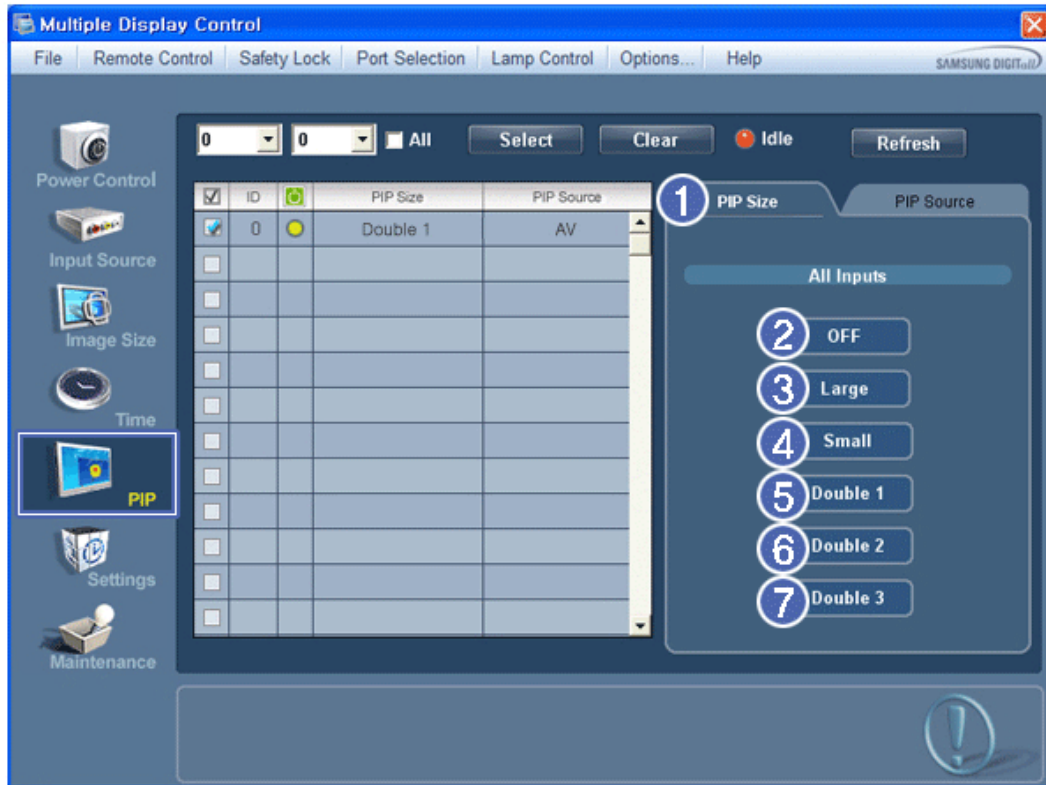

✱ Info Grid shows some basic information necessary to PIP Size Control.

- 1) PIP Size
 - Shows the current PIP Size of the display in use.
- 2) OFF
 - Turns off the PIP of the selected display.
- 3) Large
 - Turns on the PIP of the selected display and changes the size to Large.
- 4) Small
 - Turns on the PIP of the selected display and changes the size to Small.
- 5) Double 1
 - Turns on the PIP of the selected display and changes the size to Double 1.
- 6) Double 2
 - Turns on the PIP of the selected display and changes the size to Double 2.
- 7) Double 3 (Picture By Picture)
 - Turns on the PBP of the selected display and changes the size to Double 3.

- ✱ **The Input source of MagicInfo works only on MagicInfo model.**
- ✱ **The Input source of TV works only on TV model.**
- ✱ **PIP Size can be controlled with turning on the LCD Display power.**



PIP Source

1. Click PIP of the main icons and the PIP control screen appears.

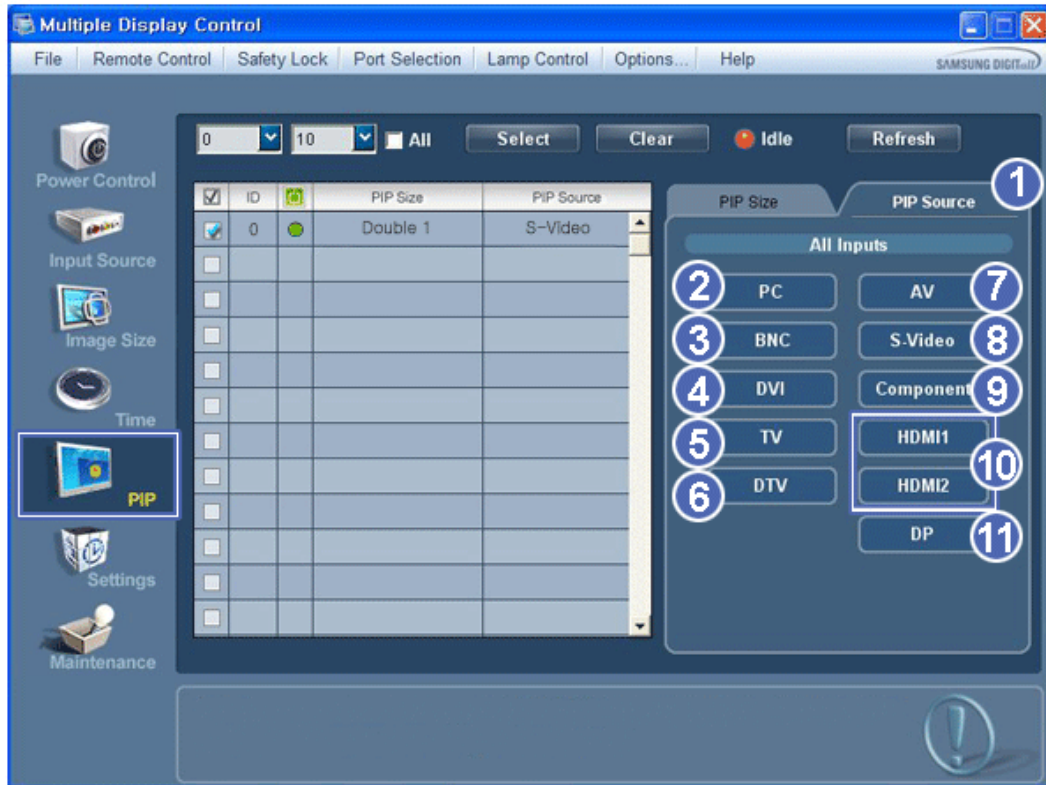

★ Info Grid shows some basic information necessary to PIP Source Control.

- 1) PIP Source
 - PIP Source can be controlled with turning on the LCD Display power.
- 2) PC
 - Changes the source of the PIP of the selected display to PC.
- 3) BNC
 - Changes the source of the PIP of the selected display to BNC.
- 4) DVI
 - Changes the source of the PIP of the selected display to DVI.
- 5) TV
 - Changes the source of the PIP of the selected display to TV.
- 6) DTV
 - Changes the source of the PIP of the selected display to DTV.
- 7) AV
 - Changes the source of the PIP of the selected display to AV.
- 8) S-Video
 - Changes the source of the PIP of the selected display to S-Video.
- 9) Component
 - Changes the source of the PIP of the selected display to Component.
- 10) HDMI1/HDMI2
 - Changes the source of the PIP of the selected display to HDMI.
- 11) DP
 - Switches the PIP Source of the selected Display to DP.

★ **HDMI2 may not be supported depending on the product.**

★ **DP may not be supported depending on the product.**

★ **Some of the PIP Sources may not be available for selection, depending on the input source type of the Main Screen.**

★ **The Input source of MagicInfo works only on MagicInfo model.**

★ **The PIP Control feature is available only for the displays whose power status is ON and the PIP function is set to ON.**



Settings

Picture

1. Click Settings of the main icons and the Settings Control screen appears.

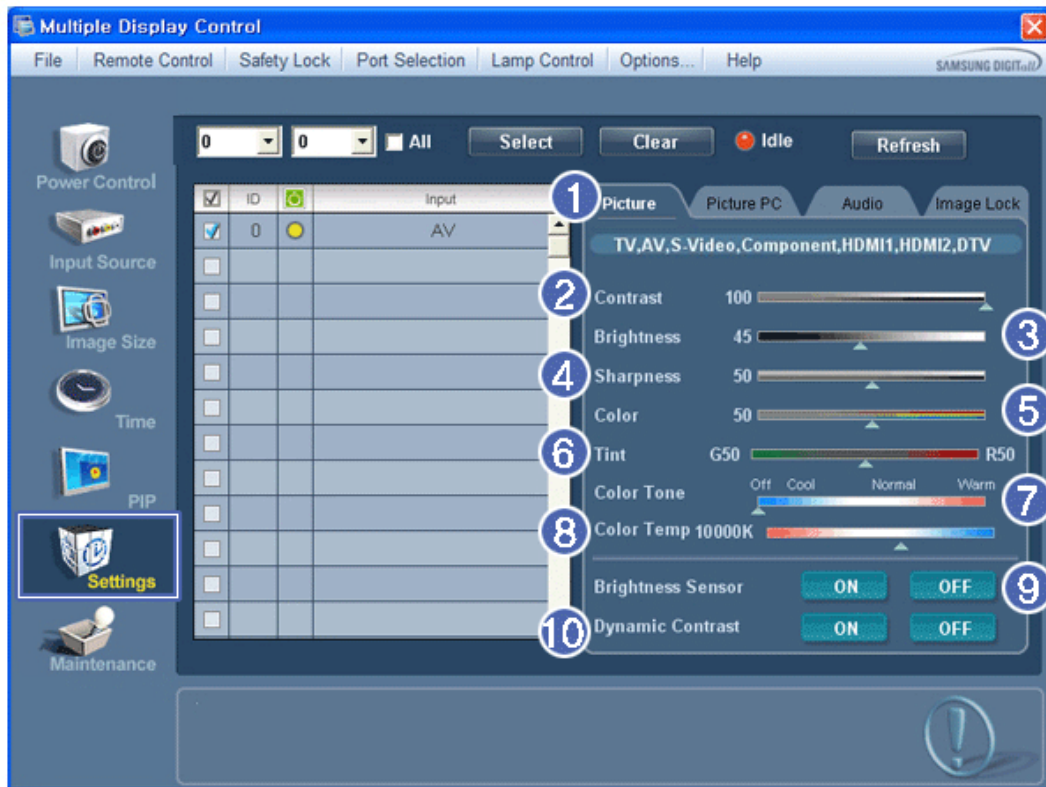

* Basic information required to adjust the Picture is displayed in the main menu. Settings for the selected monitor will be displayed if one of the connected monitors is selected, and the default settings will be displayed if all monitors are selected by clicking All and Select. If a value is changed in this screen, the current mode will automatically switch to custom mode.

- 1) Picture
 - Available only for TV, AV, S-Video, Component, HDMI1, HDMI2, DTV.
- 2) Contrast
 - Adjusts Contrast of the selected display.
- 3) Brightness
 - Adjusts Brightness of the selected display.
- 4) Sharpness
 - Adjusts Sharpness of the selected display.
- 5) Color
 - Adjusts Color of the selected display.
- 6) Tint
 - Adjusts Tint of the selected display.
 - Available only for NT.
- 7) Color Tone
 - Adjusts the Color Tone for the selected display.
- 8) Color Temp

- Adjusts the Color Temp for the selected display.
- 9) Brightness Sensor
 - Adjusts the Brightness Sensor for the selected display.
- 10) Dynamic Contrast
 - Adjusts the Dynamic Contrast for the selected display.

- * **HDMI2 may not be supported depending on the product.**
- * **Brightness Sensor may not be supported depending on the product.**
- * **The Input source of MagicInfo works only on MagicInfo model.**
- * **Color Temp is only enabled if the Color Tone is set to Off.**
- * **The Input source of TV works only on TV model.**
- * **This feature is available only for the displays whose power status is ON and if no selection is made, the factory default is displayed.**

Settings

Picture PC

1. Click Settings of the main icons and the Settings Control screen appears.



- * Basic information required to adjust settings is displayed. Settings for the corresponding SET will be imported and displayed on the slider if a display ID is selected, and the default settings will be displayed if all display IDs are selected by clicking All and Select. If a value is changed in this screen, the current mode will automatically switch to custom mode.

- 1) Picture PC
 - Available only for PC, BNC, DVI and DP.
- 2) Contrast
 - Adjusts Contrast of the selected display.

- 3) Brightness
 - Adjusts Brightness for the selected display.
- 4) Red
 - Adjusts red Color of the selected display.
 - Available only for NT.
- 5) Green
 - Adjusts green Color of the selected display.
 - Available only for NT.
- 6) Blue
 - Adjusts blue Color of the selected display.
 - Available only for NT.
- 7) Color Tone
 - Adjusts the Color Tone for the selected display.
- 8) Color Temp
 - Adjusts the Color Temp for the selected display.
- 9) Brightness Sensor
 - Adjusts the Brightness Sensor for the selected display.
- 10) Dynamic Contrast
 - Adjusts the Dynamic Contrast for the selected display.

*** DP may not be supported depending on the product.**

*** Brightness Sensor may not be supported depending on the product.**

*** The Input source of MagicInfo works only on MagicInfo model.**

*** The Input source of TV works only on TV model.**

*** Color Temp is only enabled if the Color Tone is set to Off.**

*** This feature is available only for the displays whose power status is ON and if no selection is made, the factory default is displayed.**



Settings

Audio

1. Click Settings of the main icons and the Settings Control screen appears.

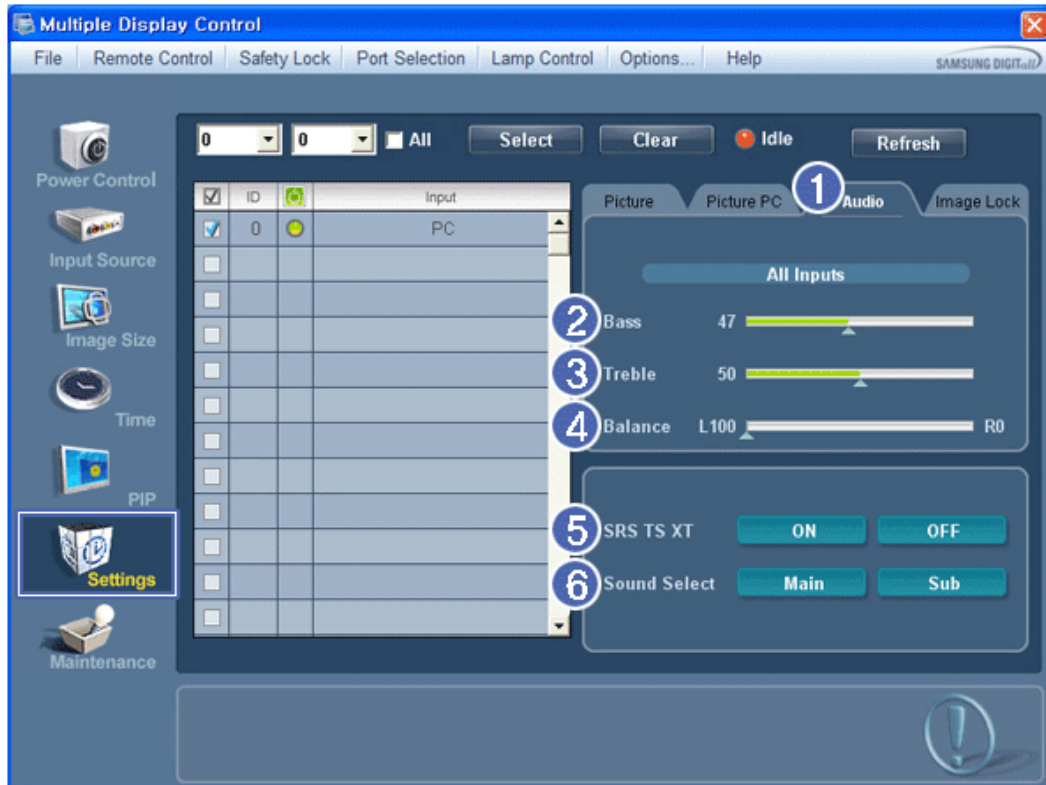

* Basic information required to adjust Audio is displayed in the display window. Settings for the corresponding SET will be imported and displayed on the slider if a display ID is selected, and the default settings will be displayed if all display IDs are selected by clicking All and Select. If a value is changed in this screen, the current mode will automatically switch to custom mode.

- 1) Audio
 - Controls audio settings for all input sources.
- 2) Bass
 - Adjusts Bass of the selected display.
- 3) Treble
 - Adjusts Treble of the selected display.
- 4) Balance
 - Adjusts Balance of the selected display.
- 5) SRS TS XT
 - SRS TS XT Sound ON/OFF of the selected display.
- 6) Sound Select
 - Select either Main or Sub when PIP is On.

* **The Input source of MagicInfo works only on MagicInfo model.**

* **The Input source of TV works only on TV model.**

* **This feature is available only for the displays whose power status is ON and if no selection is made, the factory default is displayed.**



Settings

Image Lock

1. Click Settings of the main icons and the Settings Control screen appears.

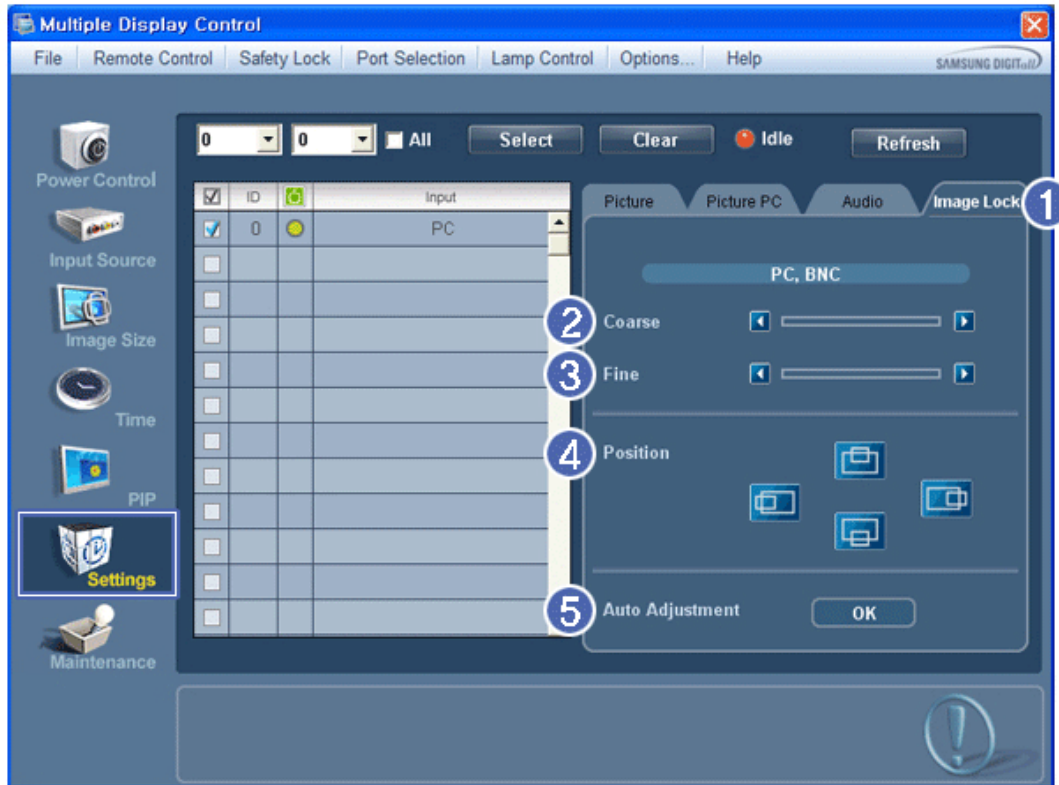

✱ Info Grid shows some basic information necessary to Settings Control.

- 1) Image Lock
 - Available only for PC, BNC.
- 2) Coarse
 - Adjusts Coarse of the selected display.
- 3) Fine
 - Adjusts Fine of the selected display.
- 4) Position
 - Adjusts Position of the selected display.
- 5) Auto Adjustment
 - Self-Adjust to the incoming PC signal.

✱ **The Input source of MagicInfo works only on MagicInfo model.**

✱ **The Input source of TV works only on TV model.**

✱ **Settings Control is available only for the displays for which the power status is ON.**



Maintenance

Lamp Control

1. Click on the "Maintenance" icon in the Main Icon column to display the Maintenance screen.

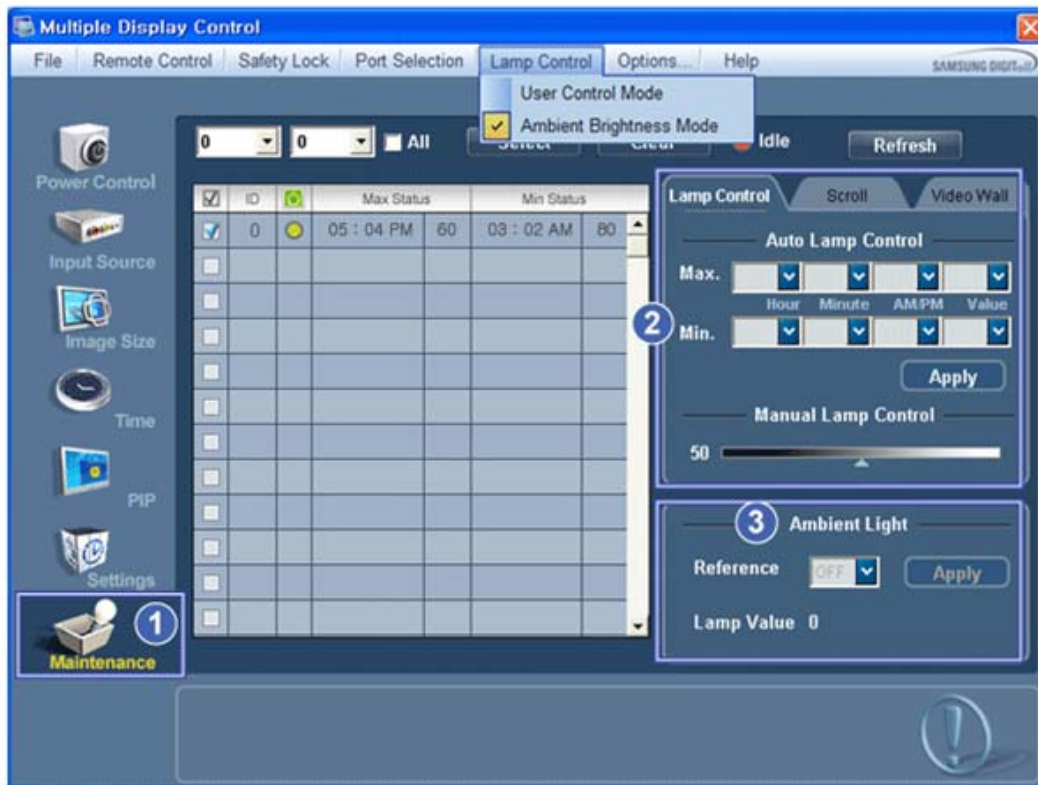

* An "Info Grid" showing several basic data items appears.

1) Maintenance

- Allows the Maintenance Control function for all input sources.

2) Lamp Control

- Automatically adjusts the backlight of the selected display at a specified time.

The Manual Lamp Control automatically turns off if you adjust using the Auto Lamp Control.

- Allows you to adjust the backlight of the selected display regardless of the time.

The Auto Lamp Control automatically turns off if you adjust using the Manual Lamp Control.

3) Ambient Light

- Detects the ambient light intensity at the designated monitor and automatically adjusts the picture brightness.

- You can specify a Reference value and designate a monitor that will automatically determine Lamp Value (the light intensity from the lamp), based on the ambient light intensity.

* **Ambient Light is only supported for models that have a brightness sensor and is only enabled when Ambient Brightness Mode is selected in the Lamp Control menu.**

* **Auto Lamp Control and Manual Lamp Control are only enabled when User Control Mode is selected in the Lamp Control menu.**

* **The Maintenance Control feature is available only for the displays whose power status is ON.**

* **The Input source of MagicInfo works only on MagicInfo model.**

* **The Input source of TV works only on TV model.**



Maintenance

Scroll

1. Click on the "Maintenance" icon in the Main Icon column to display the Maintenance screen.

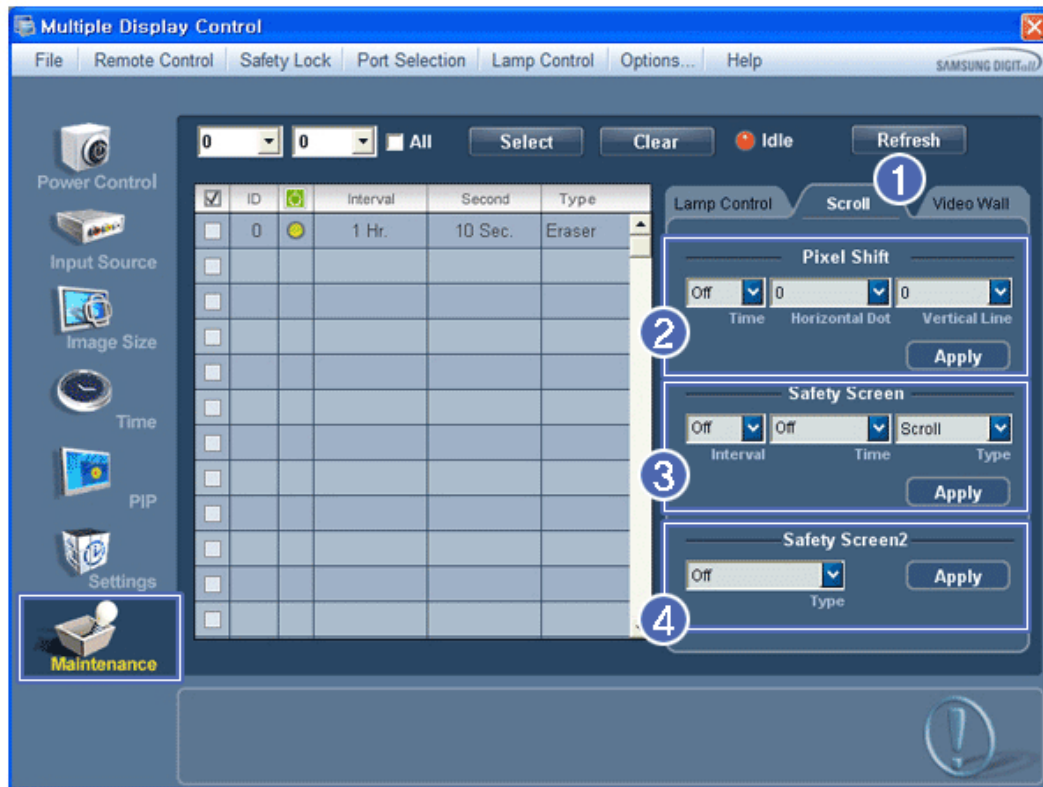

- 1) Scroll
 - This function is used to remove the afterimages that occur when a still screen is displayed on the selected display for a long time.
 - 2) Pixel Shift
 - This allows the screen to be moved finely at the specified time interval.
 - 3) Safety Screen
 - The Safety Screen function is used to prevent afterimages from occurring when a still screen is displayed on the monitor for a long time. The Interval item is used to set the repetition cycle in hour units and the Time item is used to set the time when the Safety Screen function must be performed. The Type item can be set to Scroll, Pixel, Bar, Eraser, All White, or Pattern.
 - 4) Safety Screen2
 - This function is used to prevent afterimages from occurring. There are five (5) types that you can select and control with this function.
- * For the Scroll type, the Time item can be set to 1, 2, 3, 4 or 5. For the Bar and Eraser types, it can be set to 10, 20, 30, 40 or 50. For the All White and Pattern type, it can be set to 1, 5, 10, 20 or 30.
 - * The Input source of MagicInfo works only on MagicInfo model.
 - * The Input source of TV works only on TV model.
 - * The Maintenance Control feature is available only for the displays whose power status is ON.



Maintenance

Video Wall

1. Click on the "Maintenance" icon in the Main Icon column to display the Maintenance screen.

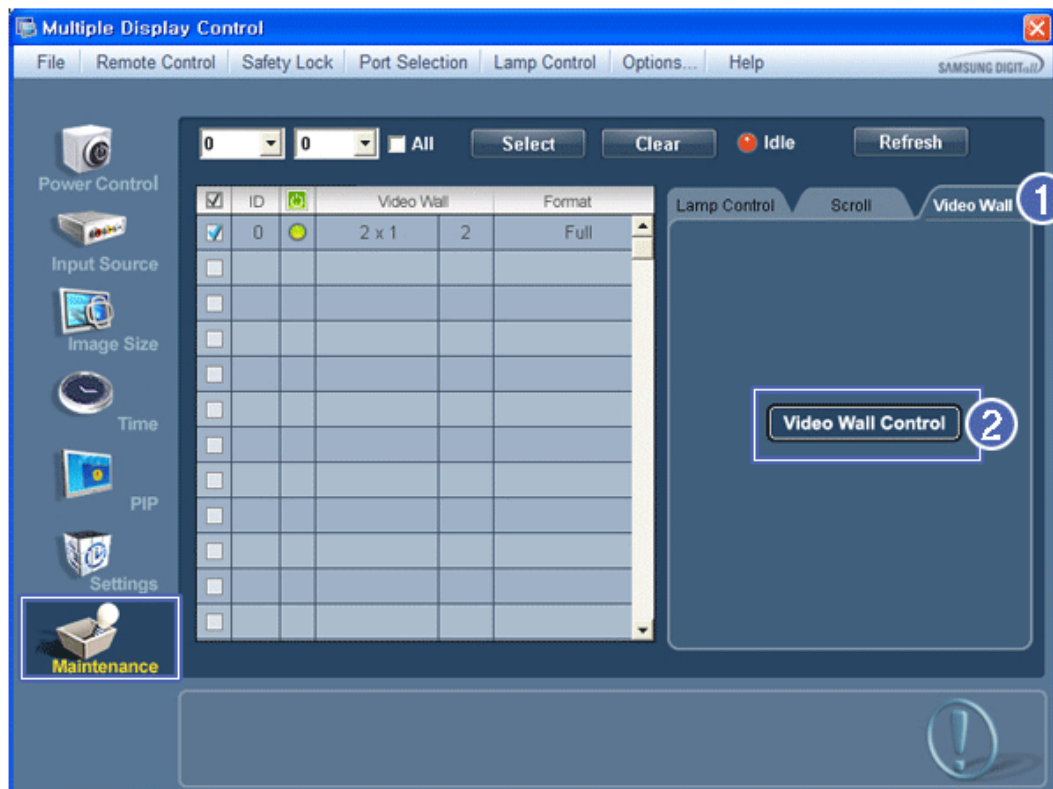

1) Video Wall

- A Video Wall is a set of video screens that are connected together, so that each screen shows a part of the whole picture or so that the same picture is repeated on each screen.

2) Video Wall Control

- Video Wall properties can be configured.

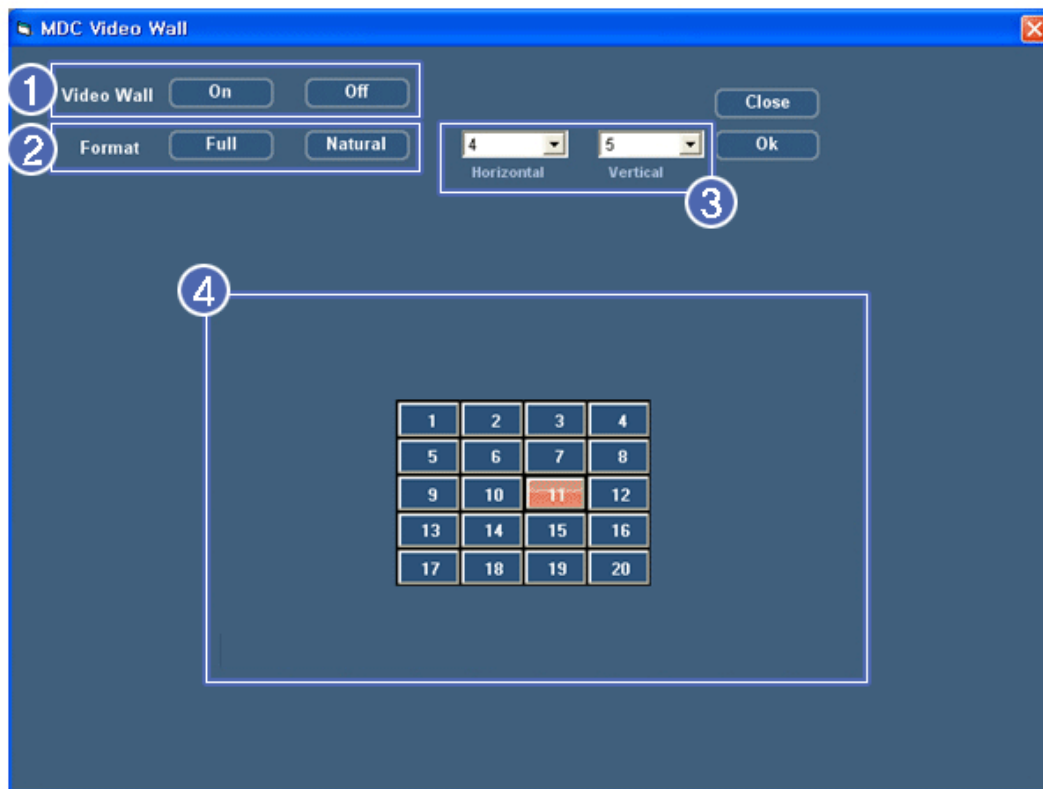

- 1) On / Off
 - Turns on/off the Video Wall function of the selected display.
- 2) Format
 - The format can be selected to see a divided screen.

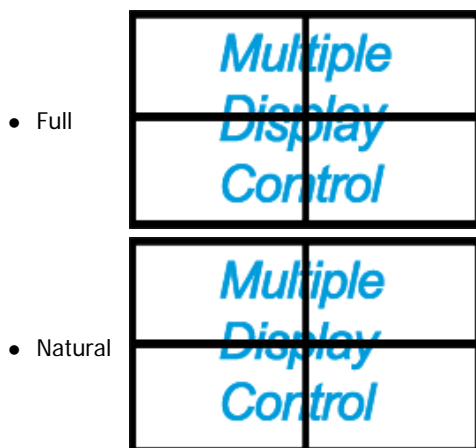

- 3) Video Wall (Screen divider)
 - The screen can be divided into.
 - You can select a number of screens with a different layout when dividing.
 - Select a mode from Screen divider.
 - Select a display from Display Selection.
 - The place will be set up by pressing a number in the selected mode.
 - The maximum number of monitors that can be arranged: Horizontal X Vertical = 100
 - Up to 15 monitors can be arranged in a row. The maximum value for Horizontal is 6 if Vertical is set to 15 while the maximum value for Vertical is 6 if Horizontal is set to 15.
- 4) Viewing Screen Splits
 - You can view and change the layout of screens using the Screen Divider settings.

- * **The range of the Screen Divider setting may differ depending on the model.**
- * **You may not operate this function in MagicInfo.**

- * The Input source of TV works only on TV model.
- * The Maintenance Control function is available only for the displays where the power status is ON.

Troubleshooting

1. The display you wish to control does not appear on the Power Control Info Grid
 - Check the connection of RS232C. (Check if it is properly connected to the Com1 port)
 - Check the displays to see if any of the other displays connected have the same ID. If more than one displays have the same ID, those displays are not properly detected by the program due to data conflict.
 - For monitors that support a Set ID between 0 to 99, you have to set the Set ID to a value between 0 and 99.

Note : Check if the Set ID of the monitor is a value between 0 and 99 (set the value using the Display menu).
2. The display you wish to control does not appear on the other Control Info Grids
 - Check to see if the display power is ON. (You can check this in Power Control Info Grid)
 - Check if you can change the input source of the display.
3. The dialogue box appears repeatedly.
 - Check to see if the display you wish to control is selected. 
4. Both On Timer and Off Timer have been set but different time is showing.
 - Apply current time to synchronize the display clocks.
5. The remote may not function properly when you turn off the remote Function, disconnect the RS-232C cable, or exit the program in an Irregular manner. Rerun the program and turn the remote function again to Restore normal functions.

<Note> This program may malfunction due to problems in communication circuits or interference from electronic appliances nearby.



Settings Value Display In Multiple Display Mode

- * When there are more than one displays connected, the settings values are displayed as follows.
 1. No selection: Displays the Factory Default Value.
 2. Selected one display: Fetches and displays the settings value for the selected display.
 3. Selected one display (ID1) and add another display (ID3): The program, which was displaying the settings value of ID 1, fetches and displays the value of ID3.
 4. If all sets are selected at the same time by clicking All and Select, the default value will be restored.

Adjusting the PDP Display

Input

Available Modes

- **P** PC / DVI / BNC
- **A** AV
- **H** HDMI
- **M** MagicInfo
- **C** Component

Note

- **MagicInfo** can only be enabled when a network box is connected.
- The **HDMI** port and network box cannot be connected at the same time.

Source List **PAHMC**

MENU → ENTER → **[Input]** → ENTER → **[Source List]** → ▲, ▼ → ENTER

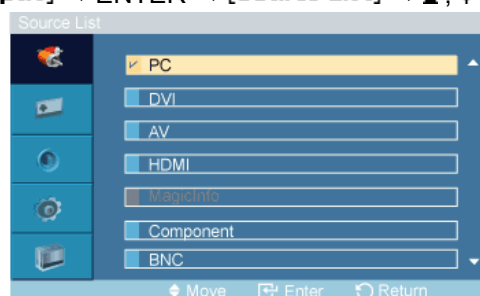

Use to select **PC**, **DVI** or other external input sources connected to the PDP Display. Use to select the screen of your choice.

1. **PC**
2. **DVI**
3. **AV**
4. **HDMI**
5. **MagicInfo**
6. **Component**
7. **BNC**

Note

- The direct button on the remote control is the 'SOURCE' button.

Edit Name **PAHMC**

MENU → ENTER → **[Input]** → ▼ → ENTER → **[Edit Name]** → ▲, ▼ → ENTER



Name the input device connected to the input jacks to make your input source selection easier.

VCR / DVD / Cable STB / HD STB / Satellite STB / AV Receiver / DVD Receiver / Game / Camcorder / DVD Combo / DHR / PC

Note

- When connecting a PC to the HDMI or DVI terminal, set **Edit Name** to PC.
- In other cases, set **Edit Name** to AV.
- However, since 640x480, 720P (1280x720), and 1080p (1920x1080) are common signals for AV and PC, make sure to set the **Edit Name** in accordance with the input signal.
- The **Picture** menu changes depending on the input signal and **Edit Name**.

Picture [PC / DVI / BNC / MagicInfo Mode]

Available Modes

- **P** PC / DVI / BNC
- **A** AV
- **H** HDMI
- **M** MagicInfo
- **G** Component

Note

- **MagicInfo** can only be enabled when a network box is connected.
- The **HDMI** port and network box cannot be connected at the same time.

MagicBright **P**M****

MENU → ▼ → ENTER → [**Picture**] → ENTER → [**MagicBright**] → ▲, ▼ → ENTER

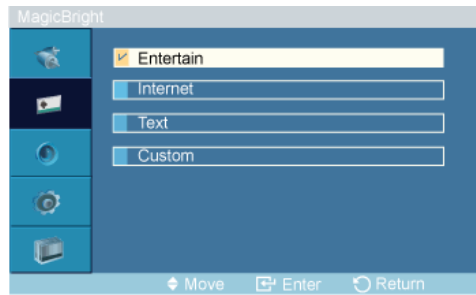

MagicBright is a new feature providing the optimum viewing environment depending on the contents of the image you are watching. Currently four different modes are available: **Entertain**, **Internet**, **Text** and **Custom**. Each mode has its own pre-configured brightness value. You can easily select one of the four settings by simply pressing the **MagicBright** control button.

1. **Entertain**

High brightness

For watching motion pictures such as a DVD or VCR.

2. **Internet**

Medium brightness

For working with a mixture of images such as texts and graphics.

3. **Text**

Normal brightness

For documentations or works involving heavy text.

4. **Custom**

Although the values are carefully chosen by our engineers, the pre-configured values may not be comfortable to your eyes depending on your taste.

If this is the case, adjust the brightness and contrast by using the OSD menu.

Custom PM

By using the on-screen menus, the contrast and brightness can be changed to your personal preference.

MENU → ▼ → ENTER → **[Picture]** → ▼ → ENTER → **[Custom]**

 **Note**

By adjusting the **picture** using the **Custom** function, **MagicBright** will change to **Custom** mode.

Contrast

MENU → ▼ → ENTER → **[Picture]** → ▼ → ENTER → **[Custom]** → ENTER → **[Contrast]**
→ ◀, ▶ → ENTER



Adjusts the Contrast.

Brightness

MENU → ▼ → ENTER → [Picture] → ▼ → ENTER → [Custom] → ▼ → ENTER → [Brightness] → ◀, ▶ → ENTER



Adjusts the Brightness.

Sharpness

MENU → ▼ → ENTER → [Picture] → ▼ → ENTER → [Custom] → ▼ → ▼ → ENTER → [Sharpness] → ◀, ▶ → ENTER



Adjusts the Sharpness.

Color Tone **PM**

MENU → ▼ → ENTER → [Picture] → ▼ → ▼ → ENTER → [Color Tone] → ▲, ▼ → ENTER

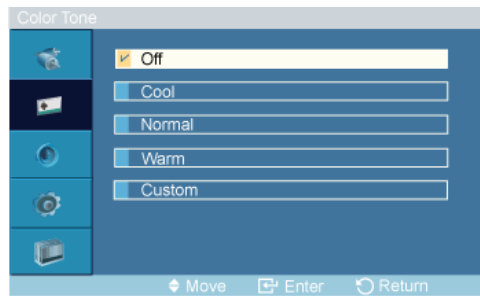

The color tones can be changed.

1. **Off**
2. **Cool**
3. **Normal**
4. **Warm**
5. **Custom**

Note

If you set the **Color Tone** to **Cool**, **Normal**, **Warm**, or **Custom**, the **Color Temp** function is disabled.

If you set the **Color Tone** to **Off**, the **Color Control** function is disabled

Color Control **PM**

Adjusts individual Red, Green, Blue color balance.

MENU → ▼ → ENTER → [Picture] → ▼ → ▼ → ▼ → ENTER → [Color Control]

 **Note**

If you adjust the picture by using the **Color Control** function, **Color Tone** will turn to the **Custom** mode.

Red

MENU → ▼ → ENTER → [Picture] → ▼ → ▼ → ▼ → ENTER → [Color Control] → ENTER → [Red] → ◀ ▶ → ENTER



Green

MENU → ▼ → ENTER → [Picture] → ▼ → ▼ → ▼ → ENTER → [Color Control] → ▼ → ENTER → [Green] → ◀ ▶ → ENTER



Blue

MENU → ▼ → ENTER → [Picture] → ▼ → ▼ → ▼ → ENTER → [Color Control] → ▼ → ▼ → ENTER → [Blue] → ◀ ▶ → ENTER



Color Temp. PM

MENU → ▼ → ENTER → [Picture] → ▼ → ▼ → ▼ → ENTER → [Color Temp.] → ◀ ▶ → ENTER



Color Temp. is a measure of the 'warmth' of the image colors.

 **Note**

This function is only enabled if the **Color Tone** is set to **Off**.

Image Lock P

Image Lock is used to fine-tune and get the best image by removing noise that creates unstable images with jitters and shakiness. If satisfactory results are not obtained using the Fine adjustment, use the Coarse adjustment and then use Fine again.

 **Note**

Available in **PC** mode only

MENU → ▼ → ENTER → [Picture] → ▼ → ▼ → ▼ → ▼ → ENTER → [Image Lock]

Coarse

MENU → ▼ → ENTER → [Picture] → ▼ → ▼ → ▼ → ▼ → ENTER → [Image Lock] → ENTER → [Coarse] → ◀ ▶ → ENTER



Removes noise such as vertical stripes. Coarse adjustment may move the screen image area. You may relocate it to the center using the horizontal control menu.

Fine

MENU → ▼ → ENTER → [Picture] → ▼ → ▼ → ▼ → ▼ → ENTER → [Image Lock] → ▼ → ENTER → [Fine] → ◀ ▶ → ENTER



Removes noise such as horizontal stripes. If the noise persists even after Fine tuning, repeat it after adjusting the frequency (clock speed).

H-Position

MENU → ▼ → ENTER → [Picture] → ▼ → ▼ → ▼ → ▼ → ENTER → [Image Lock] → ▼ → ▼ → ENTER → [H-Position] → ◀ ▶ → ENTER



Adjusts the screen location horizontally.

V-Position

MENU → ▼ → ENTER → [Picture] → ▼ → ▼ → ▼ → ▼ → ENTER → [Image Lock] → ▼ → ▼ → ▼ → ENTER → [V-Position] → ◀ ▶ → ENTER

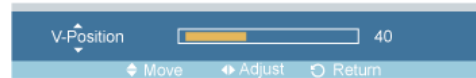

Adjusts the screen location vertically.

Auto Adjustment P

MENU → ▼ → ENTER → [Picture] → ▼ → ▼ → ▼ → ▼ → ENTER → 

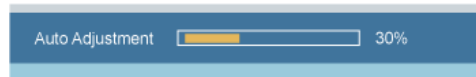

The values of **Fine**, **Coarse**, **Position** are adjusted automatically. By changing the resolution in the control panel, the auto function is performed.

 **Note**

Available in **PC** mode only

Signal Balance P

This is used to make up for the weak RGB signal transmitted by a long signal cable.

MENU → ▼ → ENTER → [Picture] → ▼ → ▼ → ▼ → ▼ → ▼ → ▼ → ENTER → [Signal Balance]

Signal Balance

MENU → ▼ → ENTER → [Picture] → ▼ → ▼ → ▼ → ▼ → ▼ → ▼ → ENTER → [Signal Balance] → ENTER → [Signal Balance] → ▲, ▼ → ENTER

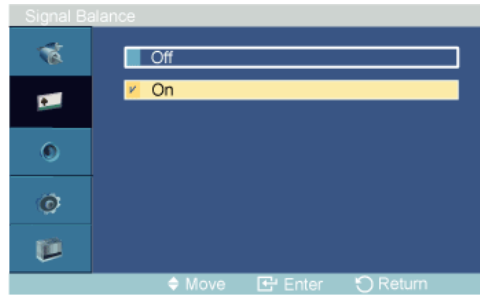

Selects either **On** or **Off** with the **signal Balance**.

Signal Control

MENU → ▼ → ENTER → [Picture] → ▼ → ▼ → ▼ → ▼ → ▼ → ▼ → ENTER → [Signal Balance] → ▼ → ENTER → [Signal Control]

1. R-Gain

MENU → ▼ → ENTER → [Picture] → ▼ → ▼ → ▼ → ▼ → ▼ → ▼ → ENTER → [Signal Balance] → ▼ → ENTER → [Signal Control] → ENTER → [R-Gain] → ◀ ▶ → ENTER



2. G-Gain

MENU → ▼ → ENTER → [Picture] → ▼ → ▼ → ▼ → ▼ → ▼ → ▼ → ENTER → [Signal Balance] → ▼ → ENTER → [Signal Control] → ▼ → ENTER → [G-Gain] → ◀ ▶ → ENTER



3. B-Gain

MENU → ▼ → ENTER → [Picture] → ▼ → ▼ → ▼ → ▼ → ▼ → ▼ → ENTER → [Signal Balance] → ▼ → ENTER → [Signal Control] → ▼ → ▼ → ENTER → [B-Gain] → ◀ ▶ → ENTER



4. R-Offset

MENU → ▼ → ENTER → [Picture] → ▼ → ▼ → ▼ → ▼ → ▼ → ▼ → ENTER → [Signal Balance] → ▼ → ENTER → [Signal Control] → ▼ → ▼ → ▼ → ENTER → [R-Offset] → ◀ ▶ → ENTER



5. G-Offset

MENU → ▼ → ENTER → [Picture] → ▼ → ▼ → ▼ → ▼ → ▼ → ▼ → ENTER → [Signal Balance] → ▼ → ENTER → [Signal Control] → ▼ → ▼ → ▼ → ▼ → ENTER → [G-Offset] → ◀ ▶ → ENTER



6. B-Offset

MENU → ▼ → ENTER → [Picture] → ▼ → ▼ → ▼ → ▼ → ▼ → ▼ → ENTER → [Signal Balance] → ▼ → ENTER → [Signal Control] → ▼ → ▼ → ▼ → ▼ → ▼ → ENTER → [B-Offset] → ◀ ▶ → ENTER



Size **P**

MENU → ▼ → ENTER → [Picture] → ▼ → ▼ → ▼ → ▼ → ▼ → ▼ → ENTER → [Size] → ▲, ▼ → ENTER

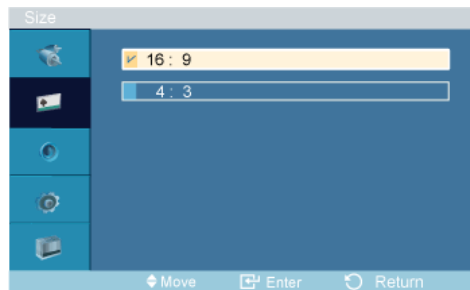

The **Size** can be switched.

1. 16:9
2. 4:3

Picture [AV / HDMI / Component Mode]

Available Modes

- **P** PC / DVI / BNC
- **A** AV
- **H** HDMI
- **M** MagicInfo
- **C** Component

 Note

- **MagicInfo** can only be enabled when a network box is connected.
- The **HDMI** port and network box cannot be connected at the same time.

Mode **AHC**

MENU → ▼ → ENTER → [Picture] → ENTER → [Mode] → ▲, ▼ → ENTER

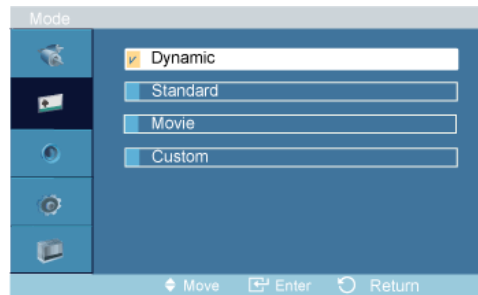

The PDP Display has four automatic picture settings ("**D**ynamic", "**S**tandard", "**M**ovie" and "**C**ustom") that are preset at the factory.

Dynamic, **S**tandard, **M**ovie, or **C**ustom can be activated.

1. **D**ynamic
2. **S**tandard
3. **M**ovie
4. **C**ustom

Custom **AHC**

By using the on-screen menus, the contrast and brightness can be changed to your personal preference.

MENU → ▼ → ENTER → [**P**icture] → ▼ → ENTER → [**C**ustom]

Contrast

MENU → ▼ → ENTER → [**P**icture] → ▼ → ENTER → [**C**ustom] → ENTER → [**C**ontrast] → ◀, ▶ → ENTER



Adjusts the Contrast.

Brightness

MENU → ▼ → ENTER → [**P**icture] → ▼ → ENTER → [**C**ustom] → ▼ → ENTER → [**B**rightness] → ◀, ▶ → ENTER



Adjusts the Brightness.

Sharpness

MENU → ▼ → ENTER → [**P**icture] → ▼ → ENTER → [**C**ustom] → ▼ → ▼ → ENTER → [**S**harpness] → ◀, ▶ → ENTER



Adjusts the picture Sharpness.

Color

MENU → ▼ → ENTER → [Picture] → ▼ → ENTER → [Custom] → ▼ → ▼ → ▼ → ENTER → [Color] → ◀, ▶ → ENTER



Adjusts the picture Color.

Tint

MENU → ▼ → ENTER → [Picture] → ▼ → ENTER → [Custom] → ▼ → ▼ → ▼ → ▼ → ENTER → [Tint] → ◀, ▶ → ENTER



Adds a natural tone to the display.

Color Tone **AHC**

MENU → ▼ → ENTER → [Picture] → ▼ → ▼ → ENTER → [Color Tone] → ▲, ▼ → ENTER

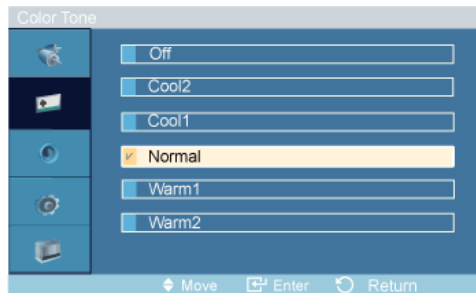

The color tones can be changed. The individual Color components are also user adjustable.

1. Off
2. Cool2
3. Cool1
4. Normal
5. Warm1
6. Warm2

Note

If you set the Color Tone to Cool2, Cool1, Normal, Warm1, or Warm2, the Color Temp function is disabled.

Color Temp. **AHC**

MENU → ▼ → ENTER → [Picture] → ▼ → ▼ → ▼ → ENTER → [Color Temp.] → ◀, ▶ → ENTER



Color temp. is a measure of the 'warmth' of the image colors.

 **Note**

This function is only enabled if the **Color Tone** is set to **Off**.

Size **AHC**

MENU → ▼ → ENTER → [Picture] → ▼ → ▼ → ▼ → ▼ → ENTER →  → ▲, ▼ → ENTER

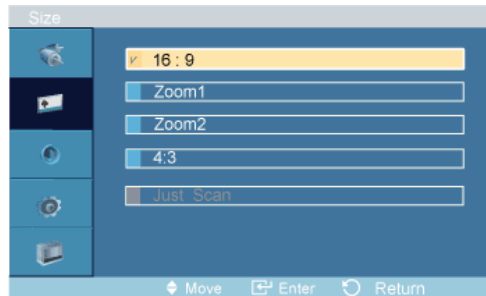

The **Size** can be switched.

1. **16:9** - Sets the picture to 16:9 wide mode.
2. **Zoom 1** - Magnifies the size of the picture on the screen.
3. **Zoom 2** - Magnifies the size of the picture more than “**Zoom 1**”.
4. **4:3** - Sets the picture to 4:3 normal mode.
5. **Just Scan** - Displays the input scenes as they are without any cutoff when **HDMI / Component 720p, 1080i, 1080p** signals are input.

 **Note**

Certain external devices may feed the display an out of spec signal that may cause cutoff even when using the **Just Scan** feature.

ZOOM1, ZOOM2 will be unavailable in **HDMI / Component** mode.

 **Note**

The **Position** and **Reset** functions are available when **Zoom1** or **Zoom2** is run.

Digital NR (Digital Noise Reduction) **AHC**

MENU → ▼ → ENTER → [Picture] → ▼ → ▼ → ▼ → ▼ → ENTER → [Digital NR] → ▲, ▼ → ENTER

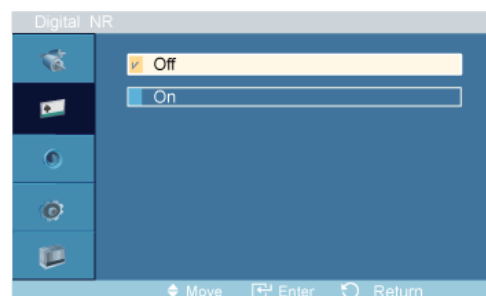

Turns the Digital Noise Reduction feature **Off/On**. The Digital Noise Reduction feature allows you to enjoy clearer and crisper images.

Deactivated in **HDMI / AV** with a resolution of 1080p.

1. Off
2. On



Digital NR function is not available for all resolutions.

Film Mode **ACH**

MENU → ▼ → ENTER → [Picture] → ▼ → ▼ → ▼ → ▼ → ▼ → ▼ → ENTER → [Film Mode] → ▲, ▼ → ENTER

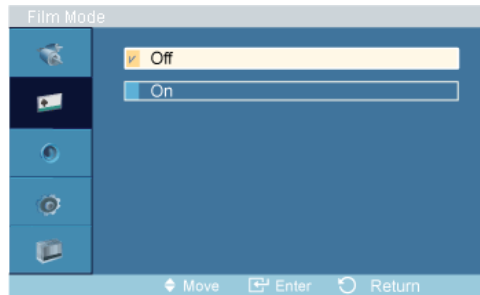

The **Film Mode** feature offers you a theater-quality viewing experience.

Film Mode is supported in AV, Component (480i / 1080i) and HDMI (480i / 1080i).

(In **HDMI** mode, this function can be available when the input signal is interlaced scan; it cannot be available with progressive scan signal.)

1. Off
2. On

Sound

Available Modes

- **P** PC / DVI / BNC
- **A** AV
- **H** HDMI
- **M** MagicInfo
- **C** Component



- **MagicInfo** can only be enabled when a network box is connected.
- The **HDMI** port and network box cannot be connected at the same time.

Mode **PAHMC**

MENU → ▼ → ▼ → ENTER → [Sound] → ENTER → [Mode] → ▲, ▼ → ENTER

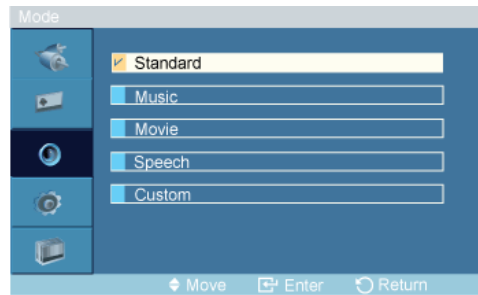

The PDP Display has a built-in high fidelity stereo amplifier.

1. **Standard**

Selects **Standard** for the standard factory settings.

2. **Music**

Selects **Music** when watching music videos or concerts.

3. **Movie**

Selects **Movie** when viewing movies.

4. **Speech**

Selects **Speech** when watching a show that is mostly dialogue (i.e., news).

5. **Custom**

Selects **Custom** if you want to adjust the settings according to your personal preferences.

Custom PAHMG

The sound settings can be adjusted to suit your personal preferences.

MENU → ▼ → ▼ → ENTER → [Sound] → ▼ → ENTER → [Custom]



- You can hear the sound even when sound value is set to 0.
- If you adjust sound using **Custom** function, **Mode** will turn to **Custom** mode.

Bass

MENU → ▼ → ▼ → ENTER → [Sound] → ▼ → ENTER → [Custom] → ENTER → [Bass] → ◀, ▶ → ENTER



Emphasizes low frequency audio.

Treble

MENU → ▼ → ▼ → ENTER → [Sound] → ▼ → ENTER → [Custom] → ▼ → ENTER → [Treble] → ◀, ▶ → ENTER



Emphasizes high frequency audio.

Balance

MENU → ▼ → ▼ → ENTER → [Sound] → ▼ → ENTER → [Custom] → ▼ → ▼ → ENTER → [Balance] → ◀ ▶ → ENTER



Allows you to Adjusts the sound balance between the left and right speakers.

Auto Volume PAHMC

MENU → ▼ → ▼ → ENTER → [Sound] → ▼ → ▼ → ENTER → [Auto Volume] → ▲, ▼ → ENTER

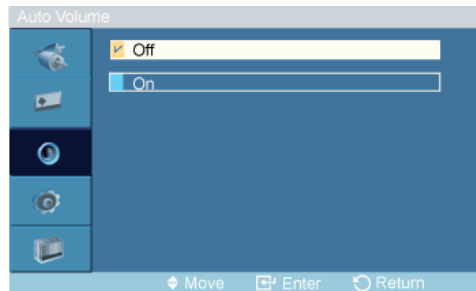

Reduces the difference in volume control between broadcasters.

1. Off
2. On

SRS TS XT PAHMC

MENU → ▼ → ▼ → ENTER → [Sound] → ▼ → ▼ → ▼ → ENTER → [SRS TS XT] → ▲, ▼ → ENTER

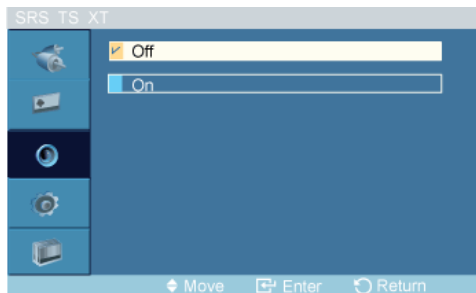

SRS TS XT is a patented SRS technology that solves the problem of playing 5.1 multichannel content over two speakers. TruSurround delivers a compelling, virtual surround sound experience through any two-speaker playback system, including internal television speakers. It is fully compatible with all multichannel formats.

1. Off
2. On

Setup

Available Modes

- **P** PC / DVI / BNC

- **A** AV
- **H** HDMI
- **M** MagicInfo
- **C** Component

 **Note**

- **MagicInfo** can only be enabled when a network box is connected.
- The **HDMI** port and network box cannot be connected at the same time.

Language **PAHMC**

MENU → ▼ → ▼ → ▼ → ENTER → [Setup] → ENTER → [Language] → ▲, ▼ → ENTER



You can choose one of 13 languages.

English, Deutsch, Español, Français, Italiano, Svenska, Русский
Português, Türkçe, 简体中文, 繁體中文, 日本語, 한국어

 **Note**

The language chosen affects only the language of the OSD. It has no effect on any software running on the computer.

Time **PAHMC**

You can set the time.

MENU → ▼ → ▼ → ▼ → ENTER → [Setup] → ▼ → ENTER → [Time]

Clock Set

MENU → ▼ → ▼ → ▼ → ENTER → [Setup] → ▼ → ENTER → [Time] → ENTER → [Clock Set] → ▲, ▼ → ◀, ▶ → ENTER

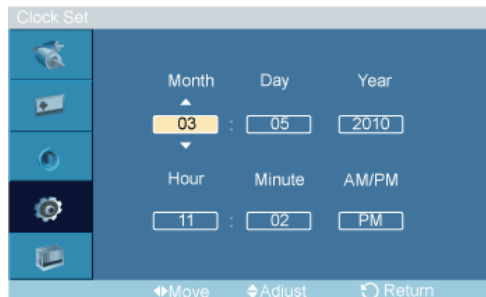

Current Time Setting.

Sleep Timer

MENU → ▼ → ▼ → ▼ → ENTER → [Setup] → ▼ → ENTER → [Time] → ▼ → ENTER → [Sleep Timer] → ▲, ▼ → ENTER

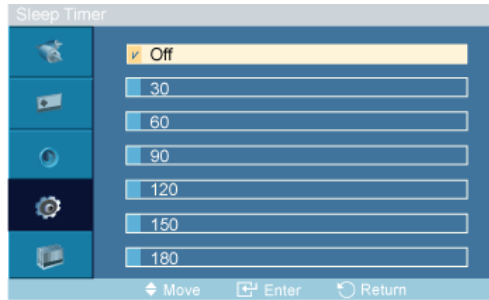

Turns the PDP Display off automatically at certain times.

1. Off
2. 30
3. 60
4. 90
5. 120
6. 150
7. 180

Timer1 / Timer2 / Timer3

MENU → ▼ → ▼ → ▼ → ENTER → [Setup] → ▼ → ENTER → [Time] → ▼ → ▼ → ▼ → ▼ → ▼ → ENTER → [Timer1 / Timer2 / Timer3]

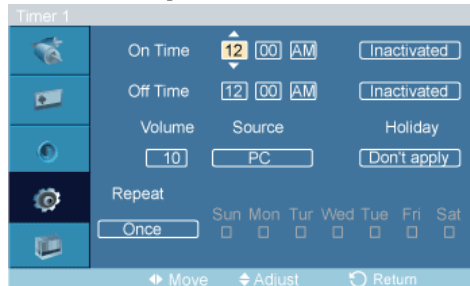

→ ▲, ▼ / ◀, ▶ → ENTER

You can set the PDP display to automatically turn on or off at a specified time.

Note

- Only enabled when the clock is set using the **Clock Set** menu.
- The **Manual** option allows you to select a day of the week.

Holiday Management

MENU → ▼ → ▼ → ▼ → ENTER → [Setup] → ▼ → ENTER → [Time] → ▼ → ▼ → ENTER → [Holiday Management]

- Add

MENU → ▼ → ▼ → ▼ → ENTER → [Setup] → ▼ → ENTER → [Time] → ▼ → ▼ → ▼ → ▼ → ▼ → ENTER → [Holiday Management] → ENTER → [Add]

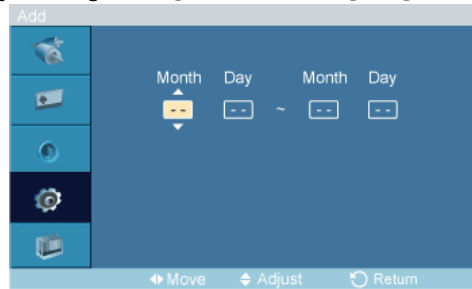

→ ▲, ▼/▲, ▼ → ENTER

You can register holidays.

- **Delete Selected**

MENU → ▼ → ▼ → ▼ → ENTER → [Setup] → ▼ → ENTER → [Time] → ▼ → ▼ → ▼ → ▼ → ▼ → ENTER → [Holiday Management] → ▲, ▼ → ENTER → ► → ▲, ▼ → ENTER → [Delete Selected]

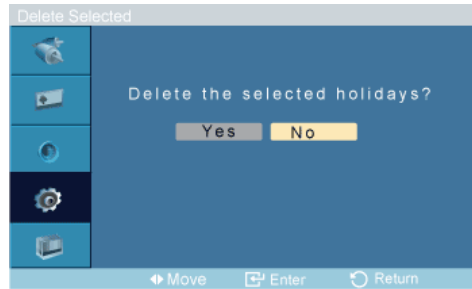

→ ◀, ▶ → ENTER

You can delete selected holidays.

 **Note**

- Only enabled when registered holidays are selected.
- More than one holiday can be selected and deleted.

- **Delete All**

MENU → ▼ → ▼ → ▼ → ENTER → [Setup] → ▼ → ENTER → [Time] → ▼ → ▼ → ▼ → ▼ → ▼ → ENTER → [Holiday Management] → ► → ▼ → ENTER → [Delete All]

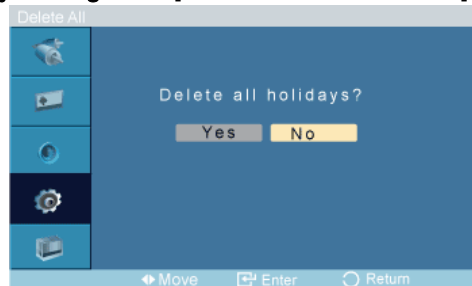

→ ◀, ▶ → ENTER

You can delete all the registered holidays.

Menu Transparency **PAHMC**

MENU → ▼ → ▼ → ▼ → ENTER → [Setup] → ▼ → ▼ → ENTER → [■■■■■■■■■■] → ▲ ,
▼ → ENTER

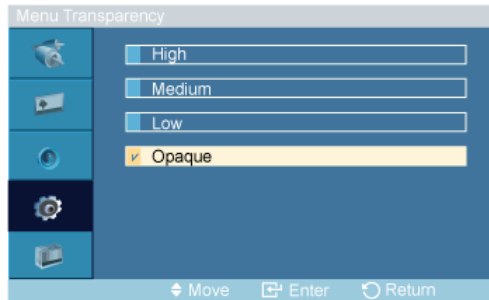

Change the transparency of the background of the OSD.

1. High
2. Medium
3. Low
4. Opaque

Safety Lock **PACHM**

Change PIN

MENU → ▼ → ▼ → ▼ → ENTER → [Setup] → ▼ → ▼ → ▼ → ENTER → [■■■■■■■■■■] → ENTER
→ [■■■■■■■■■■]

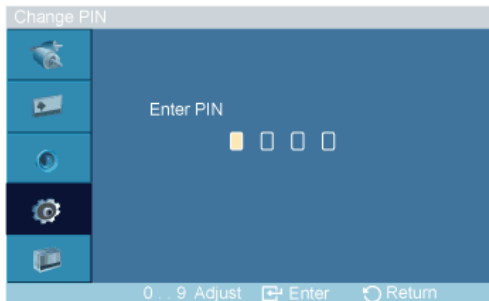

→ [0~9] → [0~9] → [0~9] → [0~9]

The password can be changed.

 **Note**

The preset password for the PDP Display is "0000".

Lock

MENU → ▼ → ▼ → ▼ → ENTER → [Setup] → ▼ → ▼ → ▼ → ENTER → [■■■■■■■■■■] → ▼ →
ENTER → [■■■■]

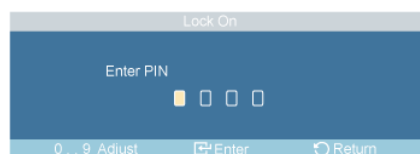

→ [0~9] → [0~9] → [0~9] → [0~9]

This is the function that locks the OSD in order to keep the current settings or to prevent others from adjusting the settings.

Energy Saving **PACHM**

MENU → ▼ → ▼ → ▼ → ENTER → [Setup] → ▼ → ▼ → ▼ → ▼ → ENTER → [Energy Saving] → ▲, ▼ → ENTER

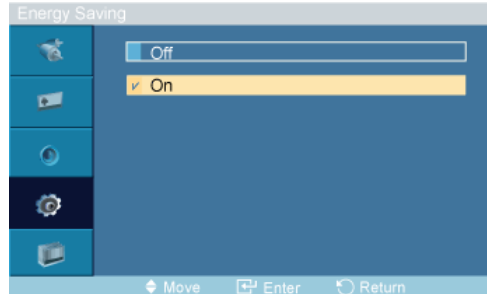

This feature adjusts the power consumption of the unit in order to save energy.

1. Off
2. On

Note

If **Energy Saving** mode is **Off**, you can obtain the maximum display brightness.

HDMI Black Level **H**

MENU → ▼ → ▼ → ▼ → ENTER → [Setup] → ▼ → ▼ → ▼ → ▼ → ▼ → ENTER → [HDMI Black Level] → ▲, ▼ → ENTER

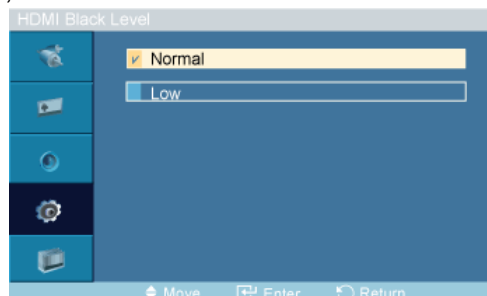

When a DVD or set-top box is connected to your TV via HDMI, it may cause a degradation in the screen quality, such as an increase in the black level, a low contrast, or discoloration, etc., depending on the external device connected. In this case, adjust the screen quality of your TV by configuring the **HDMI black level**.

1. Normal
2. Low

Video Wall **PHAC**

A **Video Wall** is a set of video screens connected together, so that each screen shows a part of the whole picture or where the same picture is repeated on each screen.

When the **Video Wall** is on, you can adjust the **Video Wall** screen setting.

MENU → ▼ → ▼ → ▼ → ENTER → [Setup] → ▼ → ▼ → ▼ → ▼ → ▼ → ▼ → ENTER → [Video Wall]

 **Note**

When **Video Wall** is running, the **Auto Adjustment**, **Image Lock**, and **Size** functions are not available. **Video Wall** does not operate in **MagicInfo** mode.

Video Wall

MENU → ▼ → ▼ → ▼ → ENTER → [Setup] → ▼ → ▼ → ▼ → ▼ → ▼ → ▼ → ENTER → [Video Wall] → ENTER → [Video Wall]

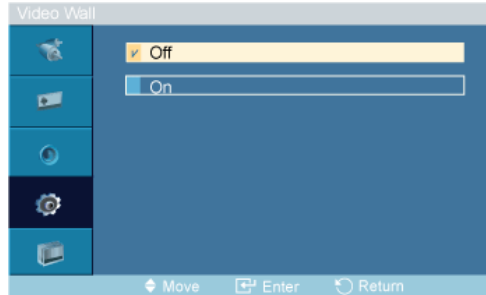

→ ▲, ▼ → ENTER

Turns Off/On the **Video Wall** function of the selected display Off/On.

1. Off
2. On

Format

MENU → ▼ → ▼ → ▼ → ENTER → [Setup] → ▼ → ▼ → ▼ → ▼ → ▼ → ▼ → ENTER → [Video Wall] → ▼ → ENTER → [Format]

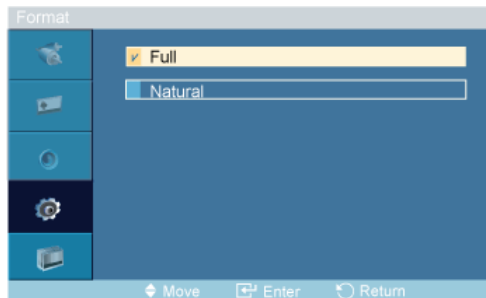

→ ▲, ▼ → ENTER

The **Format** can be selected to see a divided screen.

1. **Full**
Provides a full screen without any margins.
2. **Natural**
Displays a natural image with the original aspect ratio intact.

Horizontal

MENU → ▼ → ▼ → ▼ → ENTER → [Setup] → ▼ → ▼ → ▼ → ▼ → ▼ → ▼ → ENTER → [Video Wall] → ▼ → ▼ → ENTER → [Horizontal]

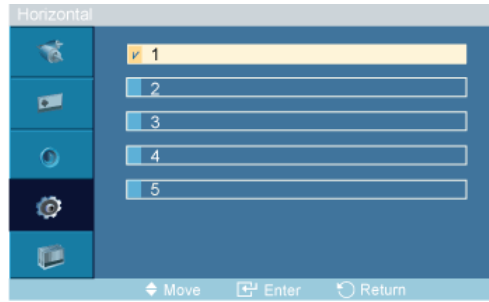

→ ▲, ▼ → ENTER

Sets how many parts the screen should be divided horizontally.

Five adjustment levels: 1, 2, 3, 4, and 5.

Vertical

MENU → ▼ → ▼ → ▼ → ENTER → [Setup] → ▼ → ▼ → ▼ → ▼ → ▼ → ▼ → ENTER → [Video Wall] → ▼ → ▼ → ▼ → ENTER → [Vertical]

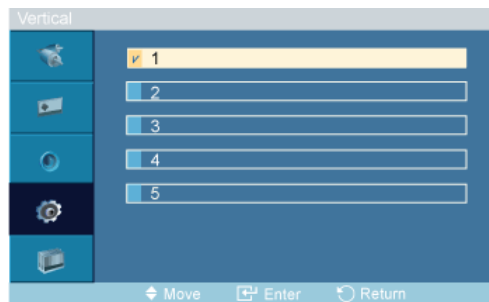

→ ▲, ▼ → ENTER

Sets how many parts the screen should be divided vertically.

Five adjustment levels: 1, 2, 3, 4, and 5.

Screen Divider

MENU → ▼ → ▼ → ▼ → ENTER → [Setup] → ▼ → ▼ → ▼ → ▼ → ▼ → ▼ → ENTER → [Video Wall] → ▼ → ▼ → ▼ → ENTER → [Screen Divider]



The screen can be divided into several images. A number of screens can be selected with a different layout when dividing.

- Select a mode in Screen Divider.
- Select a display in Display Selection.
- The selection will be set up by pressing a number in the selected mode.

Safety Screen **PAHMC**

The **Safety Screen** function is used to prevent afterimages that may appear when a still picture is displayed on the screen over a long time.

- The **Safety Screen** function scrolls the screen for the specified period of time.
- This function is not available when the power is turned off.

MENU → ▼ → ▼ → ▼ → ENTER → [Setup] → ▼ → ▼ → ▼ → ▼ → ▼ → ▼ → ▼ → ENTER → [Safety Screen]

Pixel Shift

Pixel Shift

MENU → ▼ → ▼ → ▼ → ENTER → [Setup] → ▼ → ▼ → ▼ → ▼ → ▼ → ▼ → ▼ → ENTER → [Safety Screen] → ENTER → [Pixel Shift] → ENTER → [Pixel Shift] → ▲, ▼ → ENTER

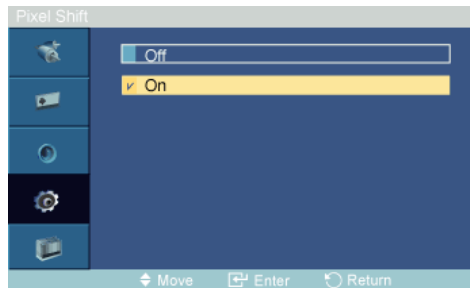

To prevent after-images on the screen you can use this function, so that every minute pixels on the PDP are moved in horizontal or vertical direction.

1. Off
2. On

Horizontal Dot

MENU → ▼ → ▼ → ▼ → ENTER → [Setup] → ▼ → ▼ → ▼ → ▼ → ▼ → ▼ → ▼ → ENTER → [Safety Screen] → ENTER → [Pixel Shift] → ▼ → ENTER → [Horizontal Dot] → ▲, ▼ → ENTER

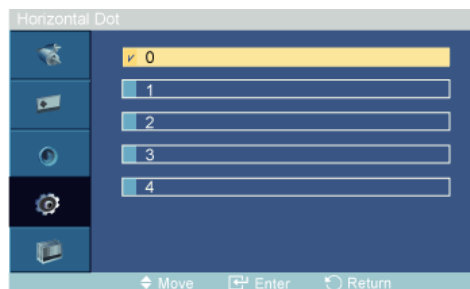

Sets how many pixels the screen moves horizontally.

Five adjustment levels: 0, 1, 2, 3, and 4.

Vertical Line

MENU → ▼ → ▼ → ▼ → ENTER → [Setup] → ▼ → ▼ → ▼ → ▼ → ▼ → ▼ → ▼ → ENTER → [Safety Screen] → ENTER → [Pixel Shift] → ▼ → ▼ → ENTER → [Vertical Line] → ▲, ▼ → ENTER

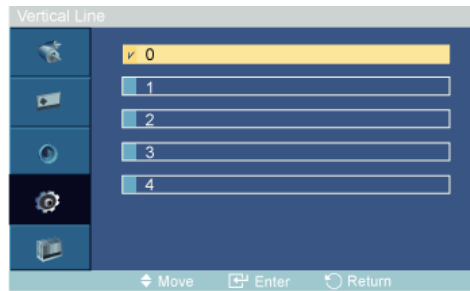

Sets how many pixels the screen moves vertically.

Five adjustment levels: 0, 1, 2, 3, and 4.

Time

MENU → ▼ → ▼ → ▼ → ENTER → [Setup] → ▼ → ▼ → ▼ → ▼ → ▼ → ▼ → ▼ → ENTER → [Safety Screen] → ENTER → [Pixel Shift] → ▼ → ▼ → ▼ → ENTER → [Time] → ▲, ▼ → ENTER



Set the time interval for performing the horizontal or vertical movement, respectively.

Timer

Timer

MENU → ▼ → ▼ → ▼ → ENTER → [Setup] → ▼ → ▼ → ▼ → ▼ → ▼ → ▼ → ▼ → ENTER → [Safety Screen] → ▼ → ENTER → [Timer] → ENTER → [Timer] → ▲, ▼ → ENTER

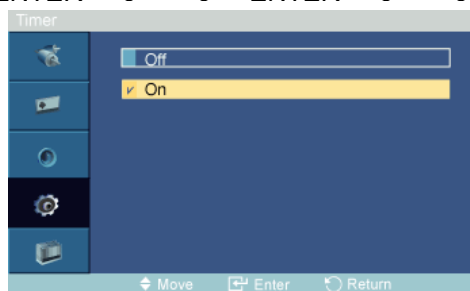

You can set the timer for Screen Burn Protection.

If you start the operation to erase any residual image, the operation will be performed for the set period of time and then automatically finish.

1. Off
2. On

Mode

MENU → ▼ → ▼ → ▼ → ENTER → [Setup] → ▼ → ▼ → ▼ → ▼ → ▼ → ▼ → ▼ → ENTER → [Safety Screen] → ▼ → ENTER → [Timer] → ▼ → ENTER → [Mode] → ▲, ▼ → ENTER



You can change the **Safety Screen** Type.

1. **Scroll**
2. **Bar**
3. **Eraser**
4. **All White**
5. **Pattern**

Period

MENU → ▼ → ▼ → ▼ → ENTER → [Setup] → ▼ → ▼ → ▼ → ▼ → ▼ → ▼ → ▼ → ENTER → [Safety Screen] → ▼ → ENTER → [Timer] → ▼ → ▼ → ENTER → [Period] → ▲, ▼ → ENTER

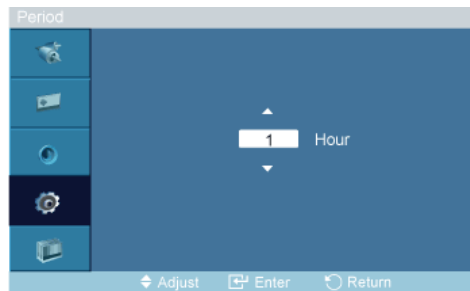

Use this function to set the execution period for each mode set in the timer.

Time

MENU → ▼ → ▼ → ▼ → ENTER → [Setup] → ▼ → ▼ → ▼ → ▼ → ▼ → ▼ → ▼ → ENTER → [Safety Screen] → ▼ → ENTER → [Timer] → ▼ → ▼ → ▼ → ENTER → [Time] → ▲, ▼ → ENTER

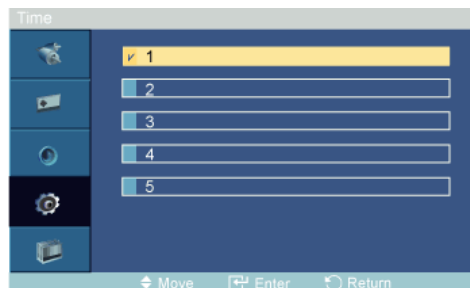

Within the set period of time specify a time for execution.

- **Mode-Scroll** : 1~5 sec
- **Mode-Bar, Eraser** : 10~50 sec

- **Mode-All White, Pattern : 1, 5, 10, 20 30 min**

Scroll

MENU → ▼ → ▼ → ▼ → ENTER → [Setup] → ▼ → ▼ → ▼ → ▼ → ▼ → ▼ → ▼ → ENTER → [Safety Screen] → ▼ → ▼ → ENTER → [Scroll]

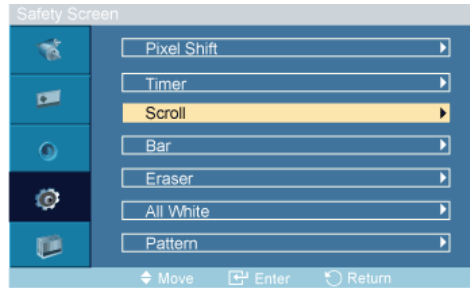

This function prevents after-images on the screen by moving all the pixels on the PDP according to a pattern.

Use this function when there are remaining after-images or symbols on the screen, especially when you displayed a still image on the screen for a long time.

Bar

MENU → ▼ → ▼ → ▼ → ENTER → [Setup] → ▼ → ▼ → ▼ → ▼ → ▼ → ▼ → ▼ → ENTER → [Safety Screen] → ▼ → ▼ → ENTER → [Bar]



This function prevents after-images on the screen by moving long black and white vertical lines.

Eraser

MENU → ▼ → ▼ → ▼ → ENTER → [Setup] → ▼ → ▼ → ▼ → ▼ → ▼ → ▼ → ▼ → ENTER → [Safety Screen] → ▼ → ▼ → ENTER → [Eraser]

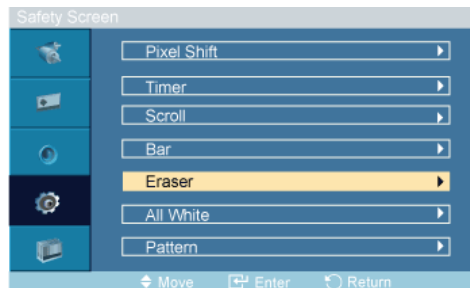

This function prevents after-images on the screen by moving a rectangular pattern.

All White

MENU → ▼ → ▼ → ▼ → ENTER → [Setup] → ▼ → ▼ → ▼ → ▼ → ▼ → ▼ → ▼ → ENTER → [Safety Screen] → ▼ → ▼ → ENTER → [All White]

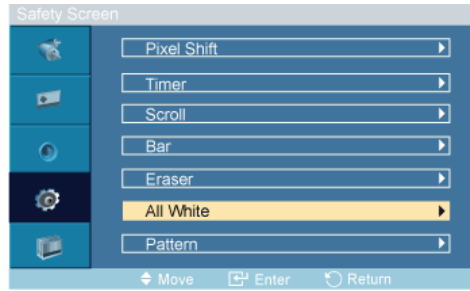

This function prevents after-images on the screen by changing the color of pixels to white.

Use this function when there are remaining after-images or symbols on the screen, especially when you displayed a still image on the screen for a long time.

Pattern

MENU → ▼ → ▼ → ▼ → ENTER → [Setup] → ▼ → ▼ → ▼ → ▼ → ▼ → ▼ → ▼ → ENTER → [Safety Screen] → ▼ → ▼ → ▼ → ▼ → ▼ → ▼ → ENTER → [Pattern]

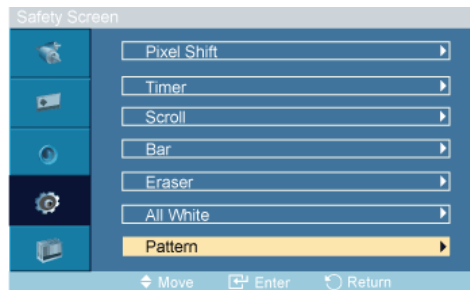

This function prevents after-images on the screen by moving a diagonal pattern stored in the panel repeatedly.

Resolution Select **P**

MENU → ▼ → ▼ → ▼ → ENTER → [Setup] → ▼ → ▼ → ▼ → ▼ → ▼ → ▼ → ▼ → ▼ → ▼ → ENTER → [Resolution Select] → ▲, ▼ → ENTER

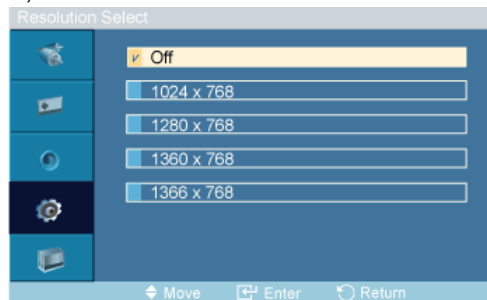

When the picture is not displayed properly on the screen when setting the graphics card resolution of the computer to 1024 x 768 @ 60Hz, 1280 x 768 @ 60Hz, 1360 x 768 @ 60Hz or 1366 x 768 @ 60Hz, by using this function(Resolution Select), you can have the picture displayed on the screen in the specified resolution.

 **Note**

Available in **PC** or **BNC** mode only

1. **Off**
2. **1024 x 768**

3. 1280 x 768
4. 1360 x 768
5. 1366 x 768

 **Note**

Selecting the menu is only allowed when the graphics resolution is set to 1024 x 768 @ 60Hz, 1280 x 768 @ 60Hz, 1360 x 768 @ 60Hz or 1366 x 768 @ 60Hz.

Power On Adjustment **PAHMC**

MENU → ▼ → ▼ → ▼ → ENTER → [Setup] → ▼ → ▼ → ▼ → ▼ → ▼ → ▼ → ▼ → ▼ → ▼ → ▼ → ENTER → [Power On Adjustment] → ▲, ▼ → ENTER



Adjusts the Power On time for the screen.



Caution: Set the Power On time to be longer to avoid overvoltage.

Side Gray **PAHMC**

MENU → ▼ → ▼ → ▼ → ENTER → [Setup] → ▼ → ▼ → ▼ → ▼ → ▼ → ▼ → ▼ → ▼ → ▼ → ▼ → ENTER → [Side Gray] → ▲, ▼ → ENTER

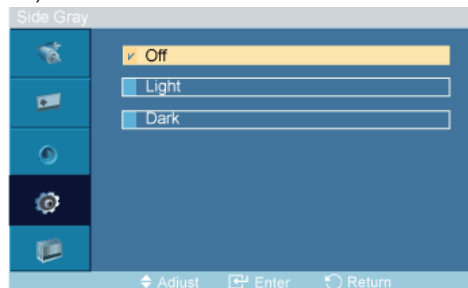

Select the brightness of the grey for the screen background.

1. Off
2. Light
3. Dark

Reset

Reverts the product settings to factory defaults. The Reset function is only available when PC / DVI is being used.

MENU → ▼ → ▼ → ▼ → ENTER → [Setup] → ▼ → ▼ → ▼ → ▼ → ▼ → ▼ → ▼ → ▼ → ▼ → ▼ → ▼ → ▼ → ▼ → ▼ → ENTER → [Reset]

Image Reset **P**

MENU → ▼ → ▼ → ▼ → ENTER → [Setup] → ▼ → ▼ → ▼ → ▼ → ▼ → ▼ → ▼ → ▼ → ▼ → ▼ → ▼ → ▼ → ▼ → ▼ → ENTER → [Reset] → ENTER → [Image Reset] → ◀ ▶ → ENTER



Note

Available in **PC** mode only

The Reset function is not available when **Video Wall** is **On**.

Color Reset **PAHMC**

MENU → ▼ → ▼ → ▼ → ENTER → [Setup] → ▼ → ▼ → ▼ → ▼ → ▼ → ▼ → ▼ → ▼ → ▼ → ▼ → ▼ → ▼ → ▼ → ▼ → ENTER → [Reset] → ▼ → ENTER → [Color Reset] → ◀ ▶ → ENTER



OSD Rotation **PAHMC**

MENU → ▼ → ▼ → ▼ → ENTER → [Setup] → ▼ → ▼ → ▼ → ▼ → ▼ → ▼ → ▼ → ▼ → ▼ → ▼ → ▼ → ▼ → ▼ → ▼ → ▼ → ▼ → ▼ → ENTER → [OSD Rotation]

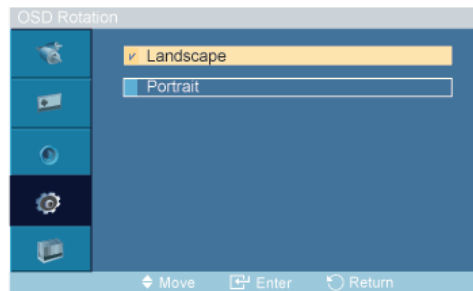

→ ◀ ▶ → ENTER

OSD Rotate

1. Landscape
2. Portrait

Multi Control

Available Modes

- **P** PC / DVI / BNC
- **A** AV
- **H** HDMI
- **M** MagicInfo

- **C** Component

 **Note**

- **MagicInfo** can only be enabled when a network box is connected.
- The **HDMI** port and network box cannot be connected at the same time.

Multi Control **PAHMC**

Assigns an individual ID to the SET.

MENU → ▼ → ▼ → ▼ → ▼ → ENTER → **[Multi Control]** → ENTER → ▲, ▼ → [0~9]



- **ID Setup**

Assigns distinctive IDs to the SET.

- **ID Input**

Use to select the transmitter functions of the individual SET. Only a SET where the ID corresponds to the transmitter setting becomes activated.

MagicInfo

Available Modes

- **P** PC / DVI / BNC
- **A** AV
- **H** HDMI
- **M** MagicInfo
- **C** Component

 **Note**

- **MagicInfo** can only be enabled when a network box is connected.
- The **HDMI** port and network box cannot be connected at the same time.

 **Note**

- The remote control can be used to select **MagicInfo**. However, it is recommended to use a separate USB keyboard to utilize **MagicInfo** fully.

- For **MagicInfo** in Device mode, moving external devices while booting may cause errors. Set up external devices only if the PDP Display turns on.
- Do not unplug the LAN cable used for the network (ex: video display). Otherwise, the program (MagicInfo) may stop. If you do unplug the cable, restart the system.
- Do not unplug the LAN cable used by an USB device (ex: video display). Otherwise, the program (MagicInfo) may stop.
- To access other sources, press the SOURCE button in **MagicInfo**.
- The preset password for the PDP Display is "000000".
- The server program's Power-On option works only if the PDP Display's power is completely shut off.

Please make sure not to use the Power-On option when the PDP Display is in the process of shutting down since this may cause system errors on the PDP Display.

- When using **MagicInfo** with the MagicInfo Server Program: perform Network mode.
- When using **MagicInfo** with the device directly connected to PDP Display : execute Device mode.
- Press ESC to directly go to the **MagicInfo** Window screen.
- To setup **MagicInfo** on a Windows screen, a keyboard and mouse are required.
- To setup **MagicInfo** on a Windows screen, refer to the MagicInfo Server Help.

It is highly recommended not to turn off the AC power during an operation.

- For pivoted PDP Displays, ticker transparency is not supported.
- For pivoted PDP Displays, a screen resolution of up to 720*480(SD) is supported for movies.
- For drive D:, **EFW** is not applied.
- To save Setup contents that have been changed when **EFW** is in the **Enable** state, you must **Commit** them.
- By selecting **Disable**, **Enable** or **Commit**, the system is restarted.

MagicInfo

1. Select Application - step 1

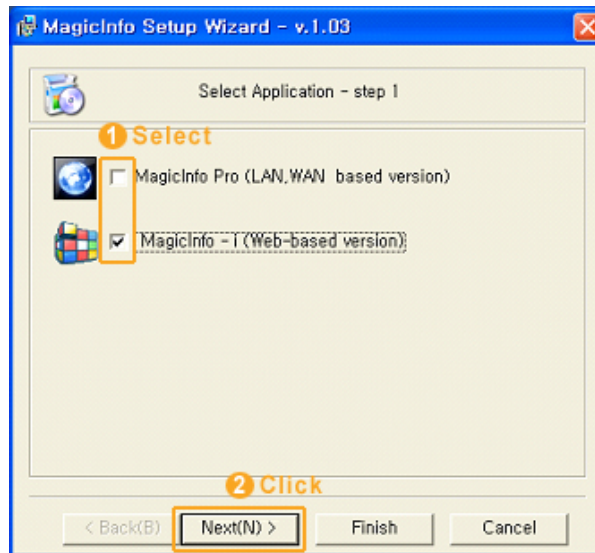

You can select an Application to be executed in your computer when Windows starts.

2. Select TCP/IP - step 2

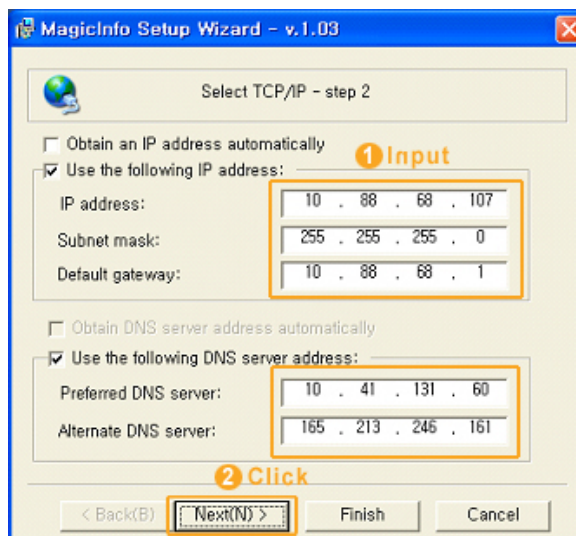

In step 2 of MagicInfo Setup Wizard, you don't have to go to Network Setting on the desktop to make your settings for TCP/IP. You just do that at step 2 of MagicInfo installation.

3. Select Language - step 3



When using multiple languages, you can choose and set a specific language among them.

4. Select Screen Type - step 4

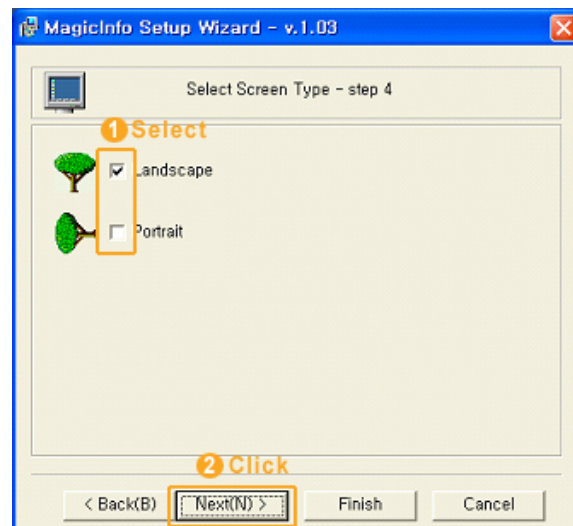

You can select which rotation type will be applied to your device.

5. Setup Information

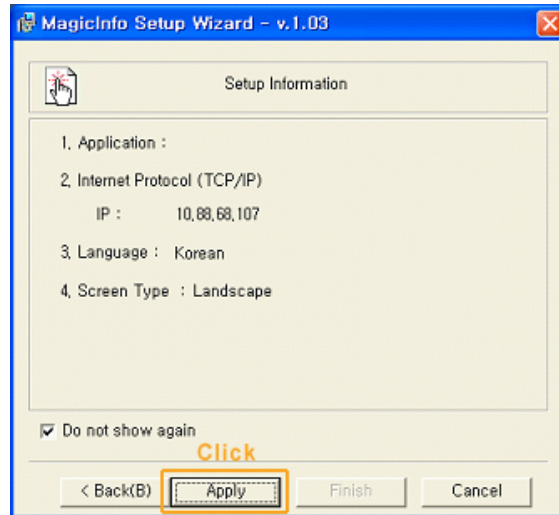

Shows the settings that have been selected by the user.

 **Note**

If the **MagicInfo** icon is not displayed on the notification area, double click the **MagicInfo** icon on the window desktop. The icon will appear.

Troubleshooting

Self-Test Feature Check



Check the following items yourself before calling for assistance. Contact a Service Center for problems that you cannot solve by yourself.

Self-Test Feature Check

1. Turn off both your computer and the PDP Display.
2. Unplug the video cable from the back of the computer.
3. Turn on the PDP Display.

The figure shown below ("**Check Signal Cable**") appears on a black background when the PDP Display is working normally even though no video signal is detected: While in the Self-Test mode, the LED power indicator remains green and the figure moves around on the screen.



4. Turn off your PDP Display and reconnect the video cable; then turn on both your computer and the PDP Display

If your PDP Display screen remains blank after using the previous procedure, check your video controller and computer system; your PDP Display is functioning properly.

Warning Messages

You can even view the screen at a resolution of 1920 x 1080. However, you will receive the following message for a minute; You can choose to change the screen resolution or stay in the current mode during that time. And if the resolution is more than 85Hz, you will see the black screen because the PDP Display does not support over 85Hz.

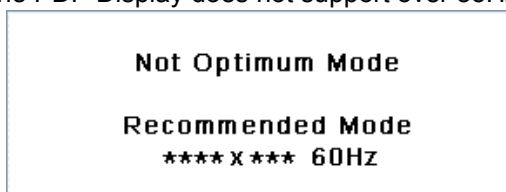

Refer to Specifications > Preset Timing Modes for the resolutions or frequencies supported by the PDP Display.

Maintenance and Cleaning

- 1) Maintaining the PDP Display Case.

Clean with a soft cloth after disconnecting the power cord.



- Do not use benzene, thinner or other flammable substances, or a wet cloth.

2) Maintaining the Flat Panel Display Screen.

Clean with a soft cloth (cotton flannel) smoothly.



- Never use acetone, benzene or thinner.
(They may cause flaws or deformation of the screen surface.)
- The user will be required to pay costs and related expenses for repairing damages caused.

Symptoms and Recommended Actions



Note

A PDP Display recreates visual signals received from the computer. Therefore, if there is a problem with the computer or the video card, this can cause the PDP Display to become blank, have poor coloring, become noisy, and video mode not supported, etc. In this case, first check the source of the problem, and then contact a Service Center or your dealer.

1. Check if the power cord and the video cables are properly connected to the computer.
2. Check if the computer beeps more than 3 times when booting.
(If it does, request an a service for the main board of the computer.)
3. If you installed a new video card or if you assembled the PC, check if you installed the Adaptor(video).
4. Check if the scanning ratio of the video screen is set to between 50 Hz ~ 85 Hz.
(Do not exceed 60Hz when using the maximum resolution.)
5. If you have problems in installing the Adaptor (video) driver, boot the computer in Safe Mode, remove the Display Adaptor in the "Control Panel -> System -> Device Administrator" and then reboot the computer to reinstall the Adaptor (video) driver.

Check List



Note

- The following table lists possible problems and their solutions. Before calling for assistance, check the information in this section to see if you can remedy any problems for yourself. If you do need assistance, please call the phone number on the Information section or contact your dealer.

Problems related to the Installation (PC Mode)



Note

Problems related to the PDP Display installation and their solutions are listed.

Q: The PDP Display screen flickers.

A: Check if the signal cable between the computer and the PDP Display is securely connected.

(Refer to Connecting a Computer)

Problems related to the Screen



Problems related to the PDP Display screen and their solutions are listed.

Q: The screen is blank and the power indicator is off.

A: Ensure that the power cord is firmly connected and the PDP Display is on.

(Refer to the Connecting a Computer)

Q: "**Check Signal Cable**" message.

A: Ensure that the signal cable is firmly connected to the PC or video sources.

(Refer to the Connecting a Computer)

A: Ensure that the PC or video sources are turned on.

Q: "**Not Optimum Mode**" message.

A: Check the maximum resolution and the frequency of the video Adaptor.

A: Compare these values with the data in the Preset Timing Modes Chart.

Q: The picture rolls vertically.

A: Check if the signal cable is securely connected. Re-connect it, if necessary.

(Refer to Connecting a Computer)

Q: The image is not clear; picture is blurred.

A: Run Frequency **Coarse** and **Fine** tuning.

A: Turn on again after removing all accessories (video extension cable, etc.)

A: Set the resolution and frequency to the recommended ranges.

Q: The picture image is unstable and shakes.

A: Check if the resolution and frequency set for the computer video card falls in the range supported by the PDP Display. If not, reset them referring to the current Information under the PDP Display menu and Preset Timing Modes.

Q: Ghost images are shown in the picture.

A: Check if the resolution and frequency set for the computer video card falls in the range supported by the PDP Display. If not, reset them referring to the current Information under the PDP Display menu and Preset Timing Modes.

Q: The image is too light or too dark.

A: Adjusts the **brightness** and **contrast**.

(Refer to the **Brightness, Contrast**)

- Q: The screen color is inconsistent.
- A: Adjust color using **Custom** under OSD Color Adjustment menu.
- Q: The color image is distorted by dark shadows.
- A: Adjust color using **Custom** under OSD Color Adjustment menu.
- Q: The color white is poor.
- A: Adjust color using **Custom** under OSD Color Adjustment menu.
- Q: The Power Indicator blinks.
- A: The PDP Display is currently saving the changes made to the settings to the OSD memory.
- Q: The screen is blank and the power indicator light blinks every 0.5 or 1 seconds. The PDP Display is using its power management system. Press any key on the keyboard.
- A: The PDP Display is using its power management system. Press a key on the keyboard.
- Q: The screen is blank and it is blinking.
- A: If you see the "**TEST GOOD**" message on the screen when you pressing the MENU button, check the cable connection between the PDP Display and the computer to ensure that the connector is properly connected.

Problems related to Audio



Problems related to audio signals and their solutions are listed below.

- Q: No sound.
- A: Ensure that the audio cable is firmly connected to both the audio-in port on your PDP Display and the audio-out port on your sound card.
- (Refer to the Connecting a Computer)
- A: Check the volume level.
- Q: The sound level is too low.
- A: Check the volume level.
- A: If the volume is still too low after turning the control to its maximum, check the volume control on the computer sound card or software program.
- Q: The sound is too high or too low.
- A: Adjusts the **Treble** and **Bass** to the appropriate levels.

Problems related to the Remote Control



Problems related to the remote control and their solutions are listed.

- Q: The remote control buttons do not respond.
- A: Check the polarities (+/-) of the batteries.

- A: Check if the batteries are empty.
- A: Check if the power is on.
- A: Check if the power cord is securely connected.
- A: Check if a special fluorescent or neon lamp is on in the vicinity.

Q & A

Q: How can I change the frequency?

A: The frequency can be changed by reconfiguring the video card.



That video card support can vary, depending on the version of the driver used. (Refer to the computer or the video card manual for details.)

Q: How can I Adjusts the resolution?

A: Windows XP:

Set the resolution in the Control Panel → Appearance and Themes → Display → Settings.

A: Windows ME/2000:

Set the resolution in the Control Panel → Display → Settings.

* Contact the video card manufacturer for details.

Q: How can I set the Power Saving function?

A: Windows XP:

Configure it by selecting Control Panel → Appearance and Themes → Display → Screen Saver Setting or configure it in the BIOS Setup of the computer. (Refer to the Windows / Computer Manual).

A: Windows ME/2000:

Configure it by selecting Control Panel → Display → Screen Saver Setting or Configure it in the BIOS Setup of the computer. (Refer to the Windows / Computer Manual).

Q: How can I clean the outer case/PDP Panel?

A: Disconnect the power cord and then clean the PDP Display with a soft cloth, using either a cleaning solution or plain water.

Do not leave any detergent or scratches on the case. Do not let any water enter the PDP Display.

Q: How can I play the video?

A: The video supports the MPEG1 and WMV codecs only. Install the corresponding codec to play the video. Note that some of the codecs can be incompatible.

 **Note**

Before calling for assistance, check the information in this section to see if you can remedy any problems yourself. If you do need assistance, please call the phone number on the Information section or contact your dealer.

Specifications

General

General		
Model Name	SyncMaster P50HP, P50HP-2 SyncMaster P63FP, P63FP-2	
PDP Panel		
Size	SyncMaster P50HP, P50HP-2	50 " Diagonal (126 cm)
	SyncMaster P63FP, P63FP-2	63 " Diagonal (160 cm)
Display area	SyncMaster P50HP, P50HP-2	1105.65 mm (H) X 622.08 mm (V)
	SyncMaster P63FP, P63FP-2	1393.92 mm (H) X 784.08 mm (V)
Pixel Pitch	SyncMaster P50HP, P50HP-2	0.81 mm (H) X 0.81 mm (V)
	SyncMaster P63FP, P63FP-2	0.726 mm (H) x 0.726 mm (V)
Synchronization		
Horizontal	30 ~ 81 kHz	
Vertical	56 ~ 75 Hz	
Display Color		
16.77 M		
Resolution		
Optimum resolution	P50HP, P50HP-2	1360 x 768 @ 60 Hz depends on graphics card used
	P63FP, P63FP-2	1920 x 1080 @ 60 Hz
Maximum resolution	P50HP, P50HP-2	1920 x 1080 @ 60 Hz
	P63FP, P63FP-2	1920 x 1080 @ 60 Hz
Maximum Pixel Clock		
SyncMaster P50HP, P50HP-2	165MHz (Analog,Digital)	

Maximum Pixel Clock

SyncMaster P63FP, P63FP-2	165MHz (Analog,Digital)
------------------------------	-------------------------

Power Supply

AC 100 - 240 V~ (+/- 10 %), 50/60 Hz ± 3 Hz

Signal connectors

DVI-D In/Out(Can connect up to 10 PDP display units.),

D-sub, AV(Composite, CVBS), HDMI, RS232C In/Out

PC Audio In, Audio In(Stereo), Audio Out(Stereo)

Dimensions (W x H x D) / Weight

SyncMaster P50HP, P50HP-2	1204.6 x 724.1 x 97.1 mm / 47.4 x 28.5 x 3.8 inch / 32.0 kg / 70.6 lbs
------------------------------	---

SyncMaster P63FP, P63FP-2	1503.5 x 894.0 x 99.4 mm / 59.2 x 35.2 x 3.9 inch / 52.0 kg / 114.6 lbs
------------------------------	--

VESA Mounting Interface

SyncMaster P50HP, P50HP-2	600 x 400
------------------------------	-----------

SyncMaster P63FP, P63FP-2	676 x 407
------------------------------	-----------

Environmental considerations

Operating	Temperature : 32°F ~ 104°F (0°C ~ 40°C)
-----------	---

Humidity : 20 % ~ 80 %, non-condensing

Storage	Temperature : -4°F ~ 113°F (-20°C ~ 45°C)
---------	---

Humidity : 5 % ~ 95 %, non-condensing

Plug and Play Capability

This PDP Display can be installed on any Plug & Play compatible system. The interaction of the PDP Display and the computer systems will provide the best operating conditions and PDP Display settings. In most cases, the PDP Display installation will proceed automatically, unless the user wishes to select alternate settings.

Dot Acceptable

PDP panels manufactured by using advanced semiconductor technology with precision of 1ppm (one millionth) above are used for this product. But the pixels of RED, GREEN, BLUE and WHITE color appear to be bright sometimes or some black pixels may be seen. This is not from bad quality and you can use it without any problems.

For example, the number of PDP sub pixels contained in this product are 2,133,440 (P50HP, P50HP-2).

For example, the number of PDP sub pixels contained in this product are 6,220,800 (P63FP, P63FP-2).

 **Note**

Design and specifications are subject to change without prior notice.

 **Class B (Information Communication equipment for residential use)**

This device is registered for EMC requirements for home use (Class B). It can be used in all areas.

(Class B equipment emits less electromagnetic waves than Class A equipment.)

PowerSaver

This PDP Display has a built-in power management system called PowerSaver. This system saves by switching your PDP Display to low-power mode when it has not been used for a certain amount of time. The PDP Display automatically returns to normal operation when you press a key on the keyboard. For energy conservation, turn your PDP Display OFF when it is not needed, or when leaving it unattended for long periods. The PowerSaver system operates with a VESA DPM compliant video card installed in your computer. Use the software utility installed on your computer to set up this feature.

PowerSaver

State		Normal Operation	Power saving mode	Power off
Power Indicator		On	Blinking	Off
Power Consumption (Typical)	MD230	P50HP, P50HP-2 The power consumption may differ depending on the region. Refer to the label on the back of the product.	2 watts	0 watt
		P63FP, P63FP-2 The power consumption may differ depending on the region. Refer to the label on the back of the product.	2 watts	0 watt

 **Note**

- The actual power consumption may be different from the indicated power consumption if the system condition or settings are changed.
- To stop any power consumption, disconnect the power cable on the back. Be sure to disconnect the power if you intend to stay away from home for many hours.

Preset Timing Modes

If the signal transferred from the computer is the same as the following Preset Timing Modes, the screen will be adjusted automatically. However, if the signal differs, the screen may go blank while the power LED is on. Refer to the video card manual and adjusts the screen as follows.

Display Mode	Horizontal Frequency (kHz)	Vertical Frequency (Hz)	Pixel Clock (MHz)	Sync Polarity (H/V)
IBM, 640 x 350	31.469	70.086	25.175	+/-
IBM, 640 x 480	31.469	59.940	25.175	-/-
IBM, 720 x 400	31.469	70.087	28.322	-/+
MAC, 640 x 480	35.000	66.667	30.240	-/-
MAC, 832 x 624	49.726	74.551	57.284	-/-
MAC, 1152 x 870	68.681	75.062	100.000	-/-
VESA, 640 x 480	37.861	72.809	31.500	-/-
VESA, 640 x 480	37.500	75.000	31.500	-/-
VESA, 800 x 600	35.156	56.250	36.000	+/+
VESA, 800 x 600	37.879	60.317	40.000	+/+
VESA, 800 x 600	48.077	72.188	50.000	+/+
VESA, 800 x 600	46.875	75.000	49.500	+/+
VESA, 1024 x 768	48.363	60.004	65.000	-/-
VESA, 1024 x 768	56.476	70.069	75.000	-/-
VESA, 1024 x 768	60.023	75.029	78.750	+/+
VESA, 1152 x 864	67.500	75.000	108.000	+/+
VESA, 1280 x 960	60.000	60.000	108.000	+/+
VESA, 1280 x 1024	63.981	60.020	108.000	+/+
VESA, 1280 x 1024	79.976	75.025	135.000	+/+
VESA, 1360 x 768 (P50HP, P50HP-2)	47.712	60.015	85.500	+/+
VESA, 1920 x 1080 (P63FP, P63FP-2)	66.587	59.934	138.500	+/-

Horizontal Frequency

The time to scan one line connecting the right edge to the left edge of the screen horizontally is called the Horizontal Cycle and the inverse number of the Horizontal Cycle is called the Horizontal Frequency. Unit: kHz



Vertical Frequency

Like a fluorescent lamp, the screen has to repeat the same image many times per second to display an image to the user. The frequency of this repetition is called the Vertical Frequency or Refresh Rate. Unit: Hz

Information

For Better Display

- Adjust the computer resolution and screen injection rate (refresh rate) on the computer as described below to enjoy the best picture quality. You can have an uneven picture quality on screen if the best picture quality is not provided for PDP.
- Resolution: 1360 x 768(P50HP, P50HP-2)
Resolution: 1920 x 1080(P63FP, P63FP-2)
- Vertical frequency (refresh rate): 60 Hz
- PDP panels manufactured by using advanced semiconductor technology with a precision of 1ppm (one millionth) and above is used for this product. But the pixels of RED, GREEN, BLUE and WHITE color seem to be bright sometimes or some of black pixels could be seen. This is not from bad quality and you can use it without any problems.
- For example, the number of PDP sub pixels contained in this product are 3,113,440.(P50HP, P50HP-2)
- For example, the number of PDP sub pixels contained in this product are 6,220,800.(P63FP, P63FP-2)
- When cleaning the monitor and the panel outside, please apply the recommended small amount of cleaner by using a soft cloth to polish. Do not force the PDP area but rub softly. If excessive force is applied, you may stain it.
- If you are not satisfied with the picture quality, you can get better quality of picture by performing the "**Auto Adjustment** function" in display screen that is appeared as window termination button is pressed. If there's still noise after the automatic adjustment, use the **Fine/Coarse** adjustment function.
- When viewing a fixed screen for an extended period of time, a residual image or blurriness may appear. Change the mode to energy save or set a screensaver to move the picture when you need to be away from the monitor for an extended period of time.

PRODUCT INFORMATION (Image Retention Free)

➤ *What is Image Retention ?*

Image retention may not occur when a PDP panel is operated under normal conditions.

Normal conditions are defined as continuously changing video patterns. When the PDP panel is operated for a long time with a fixed pattern .

Phosphor degradation may occur and the brightness is decreased. To prevent this, the video pattern should be changed from time to time.

When viewing a still screen for a long time, the brightness of any part which was bright in the previous fixed pattern becomes lower than that of its surroundings.

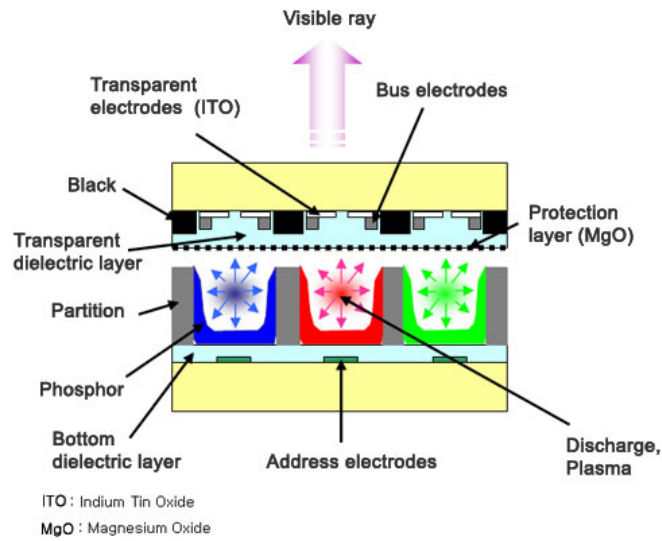

+ *Power Off, Screen Saver, or Power Save Mode*

- Turn the power off for 4 hours after 20 hours in use
- Turn the power off for 2 hours after 12 hours in use
- Set the Monitor to power off with the PC Display Properties Power Scheme.
- Use a Screen saver if possible - Screen saver in one color or a moving image is recommended.

+ *Change the Color Information periodically*

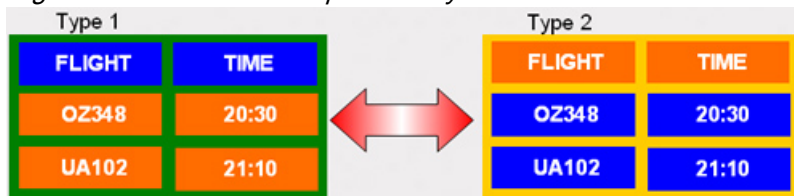

Note

Use Two different colors

Rotate the Color Information with 2 different colors every 30 minutes.

- Avoid using a combination of characters and background color with large difference in luminance.

Avoid using Grey colors, which can cause Image retention easily.

Avoid: Colors with big difference in luminance (Black & White, Grey)



+ *Change the characters color periodically*

- Use Bright colors with little difference in luminance.
 - Cycle : Change the characters color and background color every 30 minutes



- Every 30 minutes, change the characters with movement.



- All area display Moving image together with Logo periodically.
 - Cycle: Display moving image together with Logo for 60 seconds after 4 hours in use.
- The best way to protect your monitor from Image retention is to turn Power off, or set your PC, or System to operate a Screen Saver program when you are not using it. Also Warranty service will be limited based on instruction guide.

+ *Apply the Screen Scroll function on Product*

- Apply the Screen Scroll function
 - Symptom: Horizontal Bar with Black Color move up and down.

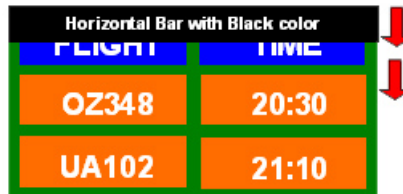

Note

(Please check CD's User Guide at "OSD Function", some model's will not available)

+ *Apply the Screen Pixel function on Product*

- Apply the Screen Pixel function
 - Symptom: Dot with Black Color move up and down.

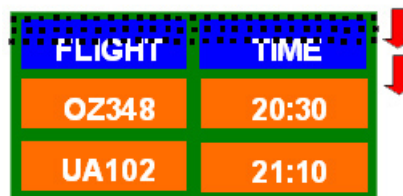

- Apply the Screen Bar function
 - Symptom: Horizontal / Vertical Bar with Black Color move up and down.



 **Note**

(Please check CD's User Guide at "OSD Function", some model's will not available.)

 *Apply the Screen Erasing function on Product*

- Apply the Screen Erasing function
 - Symptom: 2 Vertical blocks move with erasing the display

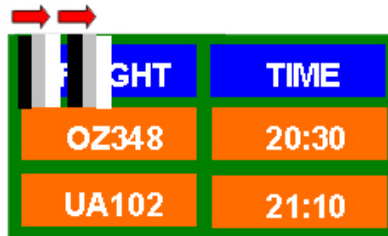

 **Note**

(Please check CD's User Guide at "OSD Function", some model's will not available)

Appendix

Contact SAMSUNG WORLDWIDE



If you have any questions or comments relating to Samsung products, please contact the SAMSUNG customer care center.

North America

U.S.A	1-800-SAMSUNG(726-7864)	http://www.samsung.com
CANADA	1-800-SAMSUNG(726-7864)	http://www.samsung.com
MEXICO	01-800-SAMSUNG (726-7864)	http://www.samsung.com

Latin America

ARGENTINA	0800-333-3733	http://www.samsung.com
BRAZIL	0800-124-421	http://www.samsung.com
	4004-0000	
CHILE	800-SAMSUNG(726-7864)	http://www.samsung.com
COLOMBIA	01-8000112112	http://www.samsung.com
COSTA RICA	0-800-507-7267	http://www.samsung.com
ECUADOR	1-800-10-7267	http://www.samsung.com
EL SALVADOR	800-6225	http://www.samsung.com
GUATEMALA	1-800-299-0013	http://www.samsung.com
HONDURAS	800-7919267	http://www.samsung.com
JAMAICA	1-800-234-7267	http://www.samsung.com
NICARAGUA	00-1800-5077267	http://www.samsung.com
PANAMA	800-7267	http://www.samsung.com
PUERTO RICO	1-800-682-3180	http://www.samsung.com
REP. DOMINICA	1-800-751-2676	http://www.samsung.com
TRINIDAD & TOBAGO	1-800-SAMSUNG(726-7864)	http://www.samsung.com
VENEZUELA	0-800-100-5303	http://www.samsung.com

Europe

AUSTRIA	0810 - SAMSUNG (7267864, € 0.07/min)	http://www.samsung.com
BELGIUM	02-201-24-18	http://www.samsung.com/be (Dutch) http://www.samsung.com/ be_fr (French)
CZECH	800 - SAMSUNG (800-726786)	http://www.samsung.com
DENMARK	70 70 19 70	http://www.samsung.com

Distributor pro Českou republiku:
Samsung Žrt, česká organizační složka, Oasis Florenc, Sokolovská394/17, 180 00, Praha 8

Europe

EIRE	0818 717100	http://www.samsung.com
ESTONIA	800-7267	http://www.samsung.com
FINLAND	030 - 6227 515	http://www.samsung.com
FRANCE	01 48 63 00 00	http://www.samsung.com
GERMANY	01805 - SAMSUNG (726-7864, € 0,14/Min)	http://www.samsung.com
HUNGARY	06-80-SAMSUNG (726-7864)	http://www.samsung.com
ITALIA	800-SAMSUNG (726-7864)	http://www.samsung.com
LATVIA	8000-7267	http://www.samsung.com
LITHUANIA	8-800-77777	http://www.samsung.com
LUXEMBURG	261 03 710	http://www.samsung.com
NETHERLANDS	0900-SAMSUNG (0900-7267864) (€ 0,10/Min)	http://www.samsung.com
NORWAY	815-56 480	http://www.samsung.com
POLAND	0 801 1SAMSUNG(172678) 022-607-93-33	http://www.samsung.com
PORTUGAL	80820 - SAMSUNG (7267864)	http://www.samsung.com
SLOVAKIA	0800 - SAMSUNG(726-7864)	http://www.samsung.com
SPAIN	902 - 1 - SAMSUNG (902 172 678)	http://www.samsung.com
SWEDEN	0771 726 7864 (SAMSUNG)	http://www.samsung.com
SWITZERLAND	0848 - SAMSUNG (7267864, CHF 0.08/min)	<a href="http://www.samsung.com/ch
ch_fr/(French)">http://www.samsung.com/ ch_fr/(French)
U.K	0845 SAMSUNG (7267864)	http://www.samsung.com

CIS

ARMENIA	0-800-05-555	
AZERBAIJAN	088-55-55-555	
BELARUS	810-800-500-55-500	
GEORGIA	8-800-555-555	
KAZAKHSTAN	8-10-800-500-55-500	
KYRGYZSTAN	00-800-500-55-500	http://www.samsung.com
MOLDOVA	00-800-500-55-500	
RUSSIA	8-800-555-55-55	http://www.samsung.com
TADJIKISTAN	8-10-800-500-55-500	http://www.samsung.com
UKRAINE	0-800-502-000	http://www.samsung.com/ua
		http://www.samsung.com/ ua_ru
UZBEKISTAN	8-10-800-500-55-500	http://www.samsung.com

Asia Pacific

AUSTRALIA	1300 362 603	http://www.samsung.com
CHINA	400-810-5858	http://www.samsung.com
	010-6475 1880	
HONG KONG	(852) 3698 - 4698	http://www.samsung.com/hk
		http://www.samsung.com/hk_en/
INDIA	3030 8282	http://www.samsung.com
	1800 110011	
	1800 3000 8282	
	1800 266 8282	
INDONESIA	0800-112-8888	http://www.samsung.com
	021-5699-7777	
JAPAN	0120-327-527	http://www.samsung.com
MALAYSIA	1800-88-9999	http://www.samsung.com
NEW ZEALAND	0800 SAMSUNG (0800 726 786)	http://www.samsung.com
PHILIPPINES	1-800-10-SAMSUNG (726-7864)	http://www.samsung.com
	1-800-3-SAMSUNG (726-7864)	
	1-800-8-SAMSUNG (726-7864)	
	02-5805777	
SINGAPORE	1800-SAMSUNG(726-7864)	http://www.samsung.com
TAIWAN	0800-329-999	http://www.samsung.com
THAILAND	1800-29-3232	http://www.samsung.com
	02-689-3232	
VIETNAM	1 800 588 889	http://www.samsung.com

Middle East & Africa

BAHRAIN	8000-4726	
JORDAN	800-22273	
SOUTH AFRICA	0860-SAMSUNG(726-7864)	http://www.samsung.com
TURKEY	444 77 11	http://www.samsung.com
U.A.E	800-SAMSUNG(726-7864)	http://www.samsung.com

Terms

Dot Pitch	The image on a monitor is composed of red, green and blue dots. The closer the dots, the higher the resolution. The distance between two dots of the same color is called the 'Dot Pitch'. Unit: mm
-----------	---

Vertical Frequency	<p>The screen must be redrawn several times per second in order to create and display an image for the user. The frequency of this repetition per second is called the Vertical Frequency or Refresh Rate. Unit: Hz</p> <p>Example: If the same light repeats itself 60 times per second, this is regarded as 60 Hz.</p>
Horizontal Frequency	<p>The time to scan one line connecting the right edge to the left edge of the screen horizontally is called the Horizontal Cycle. The inverse number of the Horizontal Cycle is called Horizontal Frequency. Unit: kHz</p>
Interlace and Non-Interlace Methods	<p>Showing the horizontal lines of the screen from the top to the bottom sequentially is called the Non-Interlace method while showing odd lines and then even lines in turn is called the Interlace method. The Non-Interlace method is used for the majority of monitors to ensure a clear image. The Interlace method is the same as that used in TVs.</p>
Plug & Play	<p>This is a function that provides the best quality screen for the user by allowing the computer and the monitor to exchange information automatically. This monitor follows the international standard VESA DDC for the Plug & Play function.</p>
Resolution	<p>The number of horizontal and vertical dots used to compose the screen image is called the 'resolution'. This number shows the accuracy of the display. A high resolution is good for performing multiple tasks as more image information can be shown on the screen.</p> <p>Example: If the resolution is 1360(1920) x 768(1080), this means the screen is composed of 1360(1920) horizontal dots (horizontal resolution) and 768(1080) vertical lines (vertical resolution).</p>
SRS TS XT	<p>This feature outputs sonorous and vivid 3D sound as for 5.1 channel speaker sound but through a 2-channel speaker. It has a good effect when stereo signals are input.</p>
Multiple Display Control (MDC)	<p>A Multiple Display Control (MDC) is an application allowing various displays to be easily and simultaneously operated on a PC. RS-232C, a standard of serial communication, is used for communicating between a PC and a display.</p>

Correct Disposal

Correct Disposal of This Product (Waste Electrical & Electronic Equipment) - Europe only



(Applicable in the European Union and other European countries with separate collection systems)

This marking on the product, accessories or literature indicates that the product and its electronic accessories (e.g. charger, headset, USB cable) should not be disposed of with other household waste at the end of their working life. To prevent possible harm to the environment or human health from uncontrolled waste disposal, please separate these items

Correct Disposal of This Product (Waste Electrical & Electronic Equipment) - Europe only

from other types of waste and recycle them responsibly to promote the sustainable reuse of material resources.

Household users should contact either the retailer where they purchased this product, or their local government office, for details of where and how they can take these items for environmentally safe recycling.

Business users should contact their supplier and check the terms and conditions of the purchase contract. This product and its electronic accessories should not be mixed with other commercial wastes for disposal.

Correct disposal of batteries in this product - Europe only



(Applicable in the European Union and other European countries with separate battery return systems.)

This marking on the battery, manual or packaging indicates that the batteries in this product should not be disposed of with other household waste at the end of their working life. Where marked, the chemical symbols Hg, Cd or Pb indicate that the battery contains mercury, cadmium or lead above the reference levels in EC Directive 2006/66. If batteries are not properly disposed of, these substances can cause harm to human health or the environment.

To protect natural resources and to promote material reuse, please separate batteries from other types of waste and recycle them through your local, free battery return system.



Note

The rechargeable battery incorporated in this product is not user replaceable. For information on its replacement, please contact your service provider.

Authority

Information in this document is subject to change without notice.

© 2010 Samsung Electronics Co., Ltd. All rights reserved.

Reproduction in any manner whatsoever without the written permission of Samsung Electronics Co., Ltd. is strictly forbidden.

Samsung Electronics Co., Ltd. shall not be liable for errors contained herein or for incidental or consequential damages in connection with the furnishing, performance, or use of this material.

Samsung is the registered trademark of Samsung Electronics Co., Ltd.; Microsoft, Windows and Windows NT are registered trademarks of Microsoft Corporation; VESA, DPM and DDC are registered trademarks of Video Electronics Standard Association; the ENERGY STAR® name and logo are registered trademarks of the U.S. Environmental Protection Agency (EPA). All other product names mentioned herein may be the trademarks or registered trademarks of their respective owners.



TruSurround XT, SRS and  Symbol are trademarks of SRS Labs, Inc. TruSurround XT technology is incorporated under license from SRS Labs, Inc.

CALIFORNIA USA ONLY (Applicable for networking models only.)

This Perchlorate warning applies only to primary CR(Manganese Dioxide) Lithium coin cells in the product sold or distributed ONLY in California USA

*Perchlorate Material - special handling may apply,
See www.dtsc.ca.gov/hazardouswaste/perchlorate.*