

SAMSUNG

PDP-MONITOR **(PLASMA DISPLAY PANEL)**

PPM42M5S

PPM42M5H

PPM50M5H

PPM63M5H

Owner's Instructions

Before operating the unit,
please read this manual thoroughly,
and retain it for future reference.

Intended for Commercial Use and Operation

ON-SCREEN MENUS
Picture In Picture (PIP)
VIDEO WALL
MDC (Multiple Display Control)
Screen Burn Protection

DNie™ Digital Natural Image engine

This device is a Class A digital apparatus.
Register your product at www.samsung.com/global/register

User Instructions

◆ **Screen Image retention**

Do not display a still image (such as on a video game or when hooking up a PC to this PDP Monitor) on the plasma monitor panel for more than 2 hours as it can cause screen image retention. This image retention is also known as "screen burn". To avoid such image retention, reduce the degree of brightness and contrast of the screen when displaying a still image.

◆ **Height**

The PDP Monitor can normally operate only under 2000m in height. It might abnormally function at a place over 2000m in height so do not install and operate there.

◆ **Heat on the top of the PDP Monitor**

The top side of the product may be hot after long periods of use as heat dissipates from the panel through the vent hole in the upper part of the product.

This is normal and does not indicate any defect or operation failure of the product. However, children should be prevented from touching the upper part of the product.

◆ **The product is making a 'cracking' noise.**

A 'cracking' noise may occur when the product contracts or expands due to a change of surrounding environment such as temperature or humidity. This is normal and not a defect of the unit.

◆ **Cell Defects**

The PDP Monitor uses a panel consisting of 1,230,000(SD-level) to 3,150,000(HD-level) pixels which require sophisticated technology to produce. However, there may be a few bright or dark pixels on the screen. These pixels will have no impact on the performance of the product.

◆ **Avoid operating the PDP Monitor at temperatures below 5°C(41°F)**

◆ **A still image displayed too long may cause permanent damage to the PDP Monitor Panel**



Watching the PDP Monitor in 4:3 format for a long period of time may leave traces of borders displayed on the left, right and center of the screen caused by the difference of light emission on the screen.

Playing a DVD or a game console may cause similar effect to the screen. Damage caused by the above effect are not covered by the Warranty.

◆ **Afterimage on the Screen.**

Displaying still images from Video games and PC for longer than a certain period of time may produce partial afterimages.

To prevent this effect, reduce the 'brightness' and 'contrast' when displaying still images for a long time.

◆ **Warranty**

- Warranty does not cover any damage caused by image retention.
- Burn-in is not covered by the warranty.

◆ **Installation**

Be sure to contact an authorized service center, when installing your monitor in a location with heavy dust, high or low temperatures, high humidity, chemical substance and where it operates for 24 hours such as the airport, the train station or etc.

Failure to do so may cause a serious damage to your monitor.

Installing the product in an airtight place may shorten the lifetime of the product.

Checking Parts



Owner's Instructions

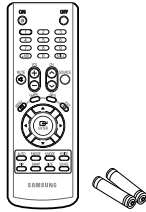

Remote Control/
AAA Batteries



Power Cord

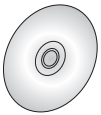

Install CD
- MDC Software (RS-232C)



Ferrite Cores for
Speaker Wire (2EA)
(Refer to page 14)

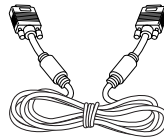

PC Cable

PPM42M5S/
42M5H/50M5H

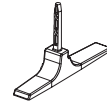

Stand-Base
(2EA)



Screws
(4EA)

Contents

◆ FOREWORD	
■ User Instructions.....	2
◆ CONNECTING AND PREPARING YOUR DISPLAY	
■ Control Panel.....	6
■ Infrared Remote Control.....	8
■ Inserting the Batteries in the Remote Control.....	9
■ Assembling the Stand-Base	9
■ Installing the Display on the Wall Attachment Panel	10
■ Installing the Display Vertically	12
■ Before Using the Video Wall and the Multiple Display Control function	12
■ Connecting Speakers	13
■ Switching Your PDP Monitor On and Off.....	15
■ Choosing Your Language.....	15
◆ USING YOUR DISPLAY	
■ Changing the Picture Standard	16
■ Customizing the Picture Settings.....	17
■ Adjusting the RGB Color (PC Mode).....	18
■ Setting the Picture (PC Mode).....	19
■ Using Zoom function (PC Mode)	21
■ Viewing the PC Information	22
■ Selecting the Picture Size.....	23
■ Freezing the Current Picture	24
■ Changing the Sound Standard	24
■ Extra Sound Settings.....	25
■ Activating Panel Button Lock.....	26
■ Activating Remote Control Button Lock.....	27
■ Setting Up Your Personal ID Number.....	28

Contents (continued)

◆ USING YOUR DISPLAY (CONTINUED)	
■ Setting the MDC (Multiple Display Control)	29
■ Preventing Screen Burn-in	30
■ Reducing the Effects of Screen Burn	31
■ Setting the Screen Burn Protection Timer	32
■ Setting the Multiple Screen.....	33
■ Displaying the Setting Information.....	34
■ Setting and Displaying the Current Time.....	34
■ Switching the PDP Monitor On and Off Automatically.....	35
■ Selecting the Fan.....	37
■ Setting the Film Mode.....	38
■ Viewing the Picture in Picture (PIP).....	39
■ Listening to the Sound of the Sub Picture	41
■ Viewing an External Signal Source	42
◆ ADDITIONAL INFORMATION AND CONNECTIONS	
■ Connecting to the Audio/Video Input	43
■ Connecting to the S-Video Input.....	44
■ Connecting to the Component Input.....	44
■ Connecting to the DVD/DTV Receiver Input	45
■ Connecting to the DVI Input	46
■ Connecting to the PC Input	46
■ Setting up Your PC Software (Windows only).....	47
■ Input Mode (PC/DVI)	48
■ Power Saver (PC1 mode only)	49
◆ RECOMMENDATIONS FOR USE	
■ Troubleshooting: Before Contacting Service Personnel.....	50
■ Technical Specifications	51
■ Dimension.....	52

Symbols



Press



Important





Note

Control Panel

- The actual configuration of your PDP Monitor may be different, depending on your model.

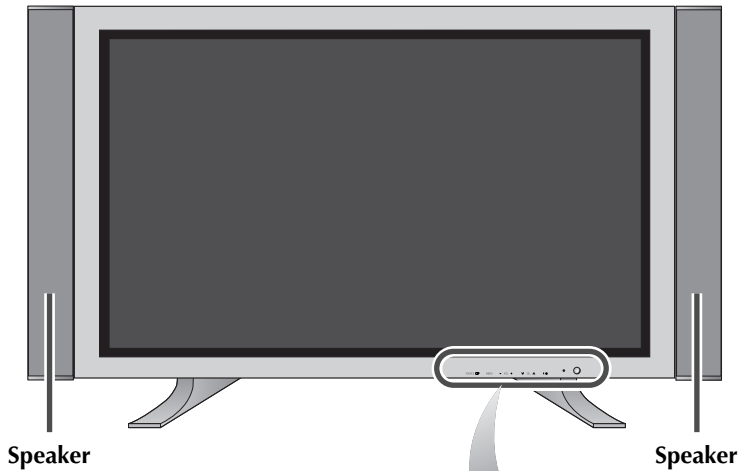
Front of the PDP Monitor



- a**
- SOURCE** 
- Select the external input source.
 - Store your settings in the menu.
 - When the Main menu is displayed on screen, the Main menu is not operated with source key.
- MENU**
- Display the on-screen menu.
- VOL +**
- Adjust the volume.
 - Adjust an option value respectively. (VOL + : Enter to the selected menu.)
- ▽ SEL ▲**
- Control the cursor in the menu.
- I / ⏻**
- Press to turn the PDP Monitor on and off.

- b**
- Power Indicator**
- Power Off; Black
 - Power On; Green
- c**
- Remote Control Sensor**
- Aim the remote control towards this spot on the PDP Monitor.

-
- ◆ You can use the **SEL** **▽**, **▲** buttons to switch on the PDP Monitor when it is in standby mode depending on the model.
 - ◆ The **VOL** **-**, **+** and **SEL** **▽**, **▲** buttons have the same function as the **▲/▼/◀/▶** buttons on the remote control.
 - ◆ If the remote control no longer works or you have misplaced it, you can use the controls on the panel of the PDP Monitor.

Control Panel (continued)

- The actual configuration of your PDP Monitor may be different, depending on your model.

Rear Panel

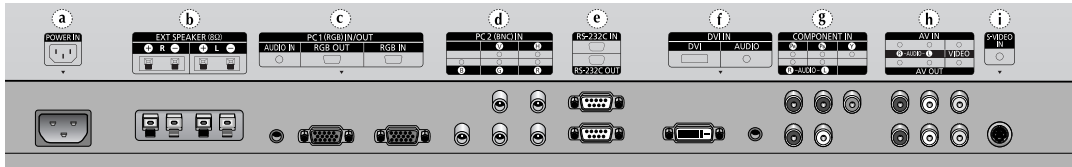

- a) **POWER IN**
Connect the supplied power cord.
- b) **EXT SPEAKER (8Ω)**
Connect external speakers.
- c) **PC1 IN/OUT**
 - **IN** : Connect to the video output jack on your PC.
 - **OUT** : Connect to the video input jack on external devices.
 - **AUDIO** : Connect to the audio output jack on your PC.
- AUDIO is an audio input jack for PC1 and PC2 modes.
- d) **PC2 (BNC) IN**
Connect for RGB(Y/P_B/P_R)HV video signal input from the PC.
- “PC Mode” from this page onward means PC1/PC2 mode using **RGB1(PC1)** and **RGB2(PC2)**.
- e) **RS-232C**
 - **IN** : Used for the MDC function when connecting PC or RS-232C output of another PDP Monitor.
 - **OUT** : Used for the MDC function when connecting with RS-232C input of another PDP Monitor.
- For further details about connections, refer to Page 12.
- For further details about connection, refer to pages 43–46.
- Whenever you connect an audio or video system to your PDP Monitor, ensure that all elements are switched off. Refer to the documentation supplied with your equipment for detailed connection instructions and associated safety precautions.
- f) **DVI IN**
 - **DVI** : Connect to the video output jack for device with DVI output.
 - **AUDIO** : Connect to the audio output jack for devices with DVI output.
- g) **COMPONENT IN**
Video (Y/P_B/P_R) and audio (L/R) inputs for component.
- h) **AV (VIDEO/AUDIO L/R)**
 - **IN** : Video and audio inputs for external devices, such as a camcorder or VCR.
 - **OUT** : Outputs for external devices.
- i) **S-VIDEO IN**
Video input for external devices with an S-Video output, such as a camcorder or VCR.

Infrared Remote Control

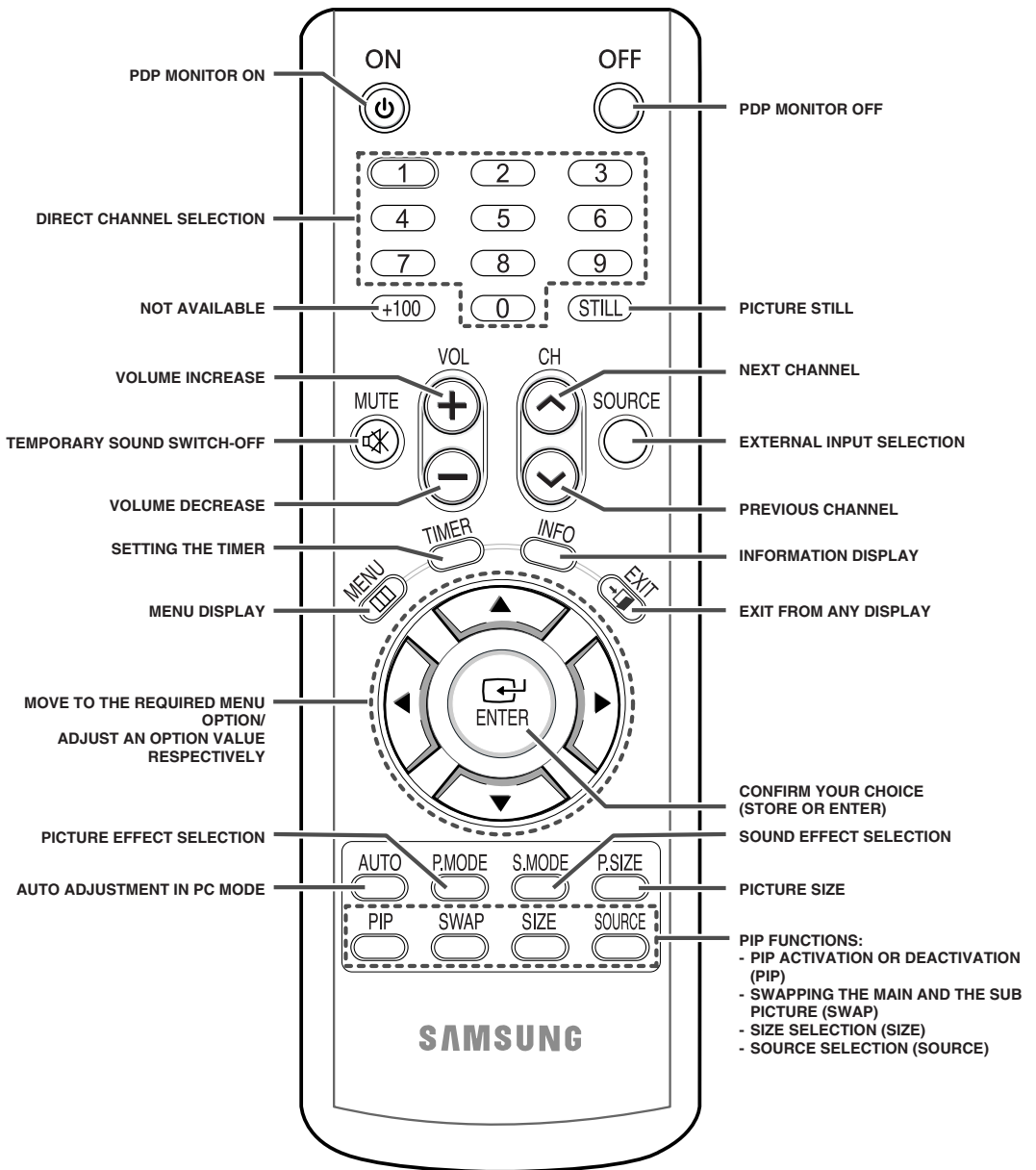

➤ *The performance of the remote control may be affected by bright light.*

Inserting the Batteries in the Remote Control

You must insert or replace the batteries in the remote control when you:

- ◆ Purchase the PDP Monitor
- ◆ Find that the remote control is no longer operating correctly

- 1 Remove the cover on the rear of the remote control by pressing the symbol (▼) downwards and then pulling firmly to remove it.
- 2 Insert two R03, UM4, "AAA" 1.5V or equivalent batteries taking care to respect the polarities:
 - ◆ - on the battery against - on the remote control
 - ◆ + on the battery against + on the remote control
- 3 Replace the cover by aligning it with the base of the remote control and pressing it back into place.
Do not mix battery types, i.e. alkaline and manganese.

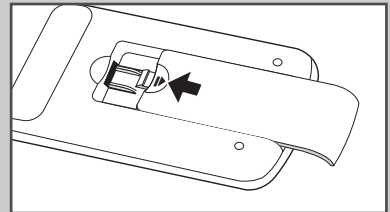
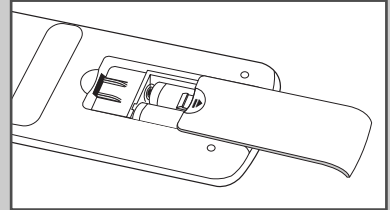
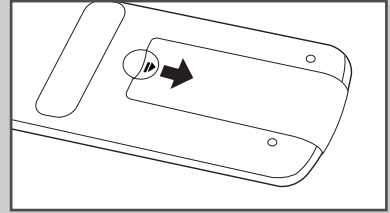

Assembling the Stand-Base

- 1 Assemble the PDP Monitor with the stand and firmly secure the PDP Monitor using 4 screws provided.
- Two or more people should carry the PDP Monitor. Never lay the PDP Monitor on the floor because of possible damage to the screen. Always store the PDP Monitor upright.

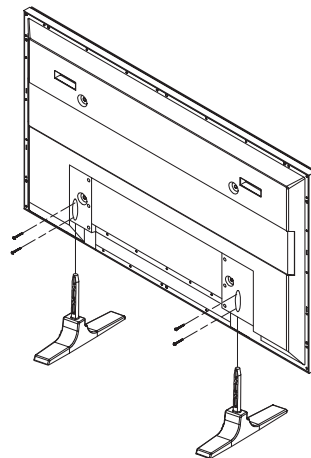

Installing the Display on the Wall Attachment Panel

➤ Refer to the correct installation guide according to your wall bracket.

Installation Notes

- ◆ Contact a technician for installing the wall bracket.
- ◆ Samsung Electronics is not responsible for any damages to the product or harm to customers when the installation is done by the customer.
- ◆ This product is for installing on cement walls. The product may not stay in place when installed on plaster or wood.

Components

- ◆ Only use the components and accessories shipped with the product.

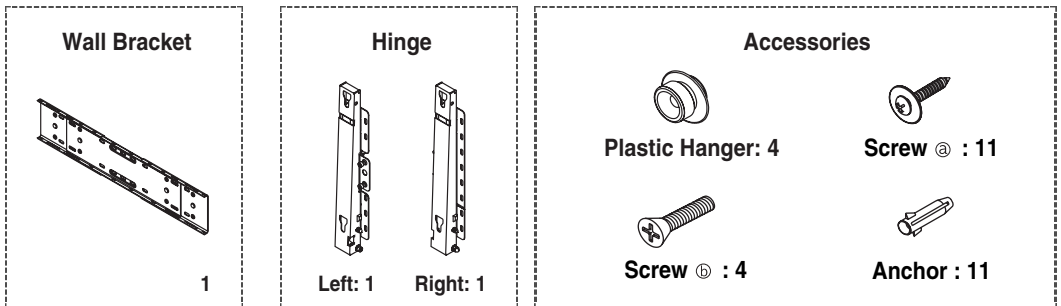

Wall Bracket Assembly

- 1 Insert and tighten the Captive Screw in the direction of the arrow. When done, mount the wall bracket on the wall.

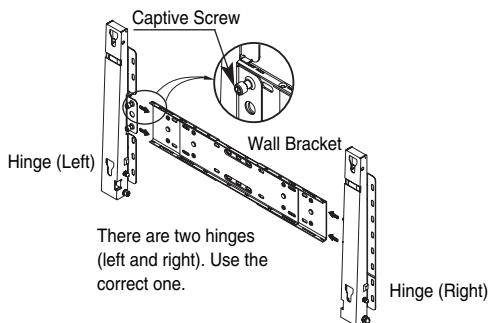

- 2 Before drilling into the wall, check if the length between the two locking holes at the back of the product is correct. If the length is too short or long, loosen all or some of the 4 screws on the wall bracket to adjust the length.

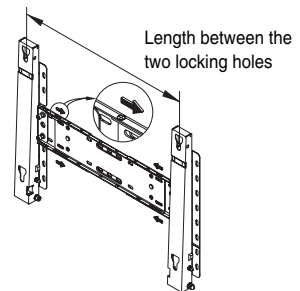

- 3 Check the installation diagram and mark the drill points on the wall. Use the 5.0 mm bit to drill holes deeper than 35 mm. Fix each anchor in the corresponding hole. Match each of the brackets and hinge holes to the corresponding anchor holes and insert and tighten the 11 screws Ⓐ.

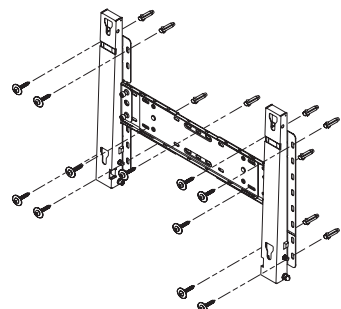

Installing the Display on the Wall Attachment Panel (continued)

To mount the product on the wall bracket

- ◆ The shape of the product may vary depending on the model. (The assemblies of the plastic hanger and the screw are the same)

1 Remove the 4 screws on the back of the product.

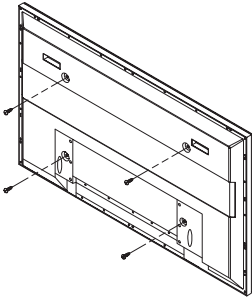

2 Insert the screw ⑤ into the plastic hanger. (See the figure below)

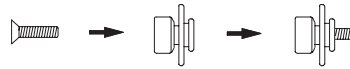

- ◆ Mount the product on the wall bracket and make sure it is properly fixed to the left and right plastic hangers.
- ◆ Be careful when installing the product on the bracket as fingers can be caught in the holes.
- ◆ Make sure the wall bracket is securely fixed to the wall, or the product may not stay in place after installation.

3 Tighten the 4 screws in step 2 (plastic hanger + screw ⑤) to the rear holes of the product.

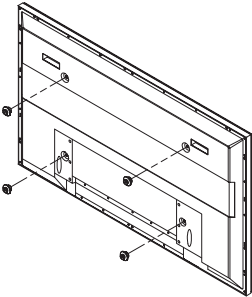

4 Remove safety pin ③ and insert the 4 product holders into the corresponding bracket holes ①. Then place the product ② so that it is firmly fixed to the bracket. Make sure to reinsert and tighten the safety pin ③ to securely hold the product to the bracket.

PDP Monitor

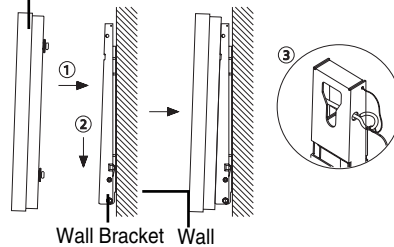

Wall Bracket Angle Adjustment

- Adjust the bracket angle to -2° before installing it on the wall.

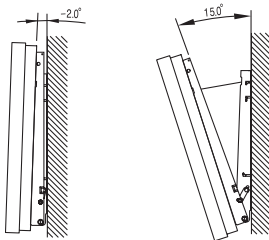

1 Fix the product to the wall bracket.

2 Hold the product at the top in the center and pull it forward (direction of the arrow) to adjust the angle. (See the figure to the right)

3 You can adjust the bracket angle between -2° and 15° .

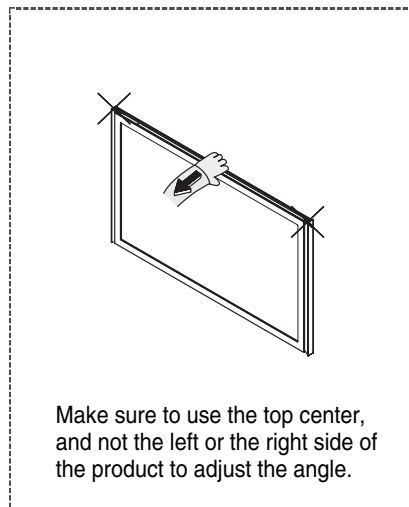

Installing the Display Vertically

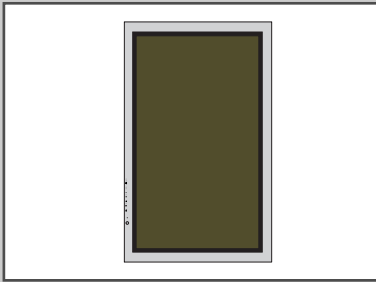

You can install the PDP Monitor vertically. In this case, the fan automatically works. If you wish to stop the fan, position the PDP Monitor horizontally and then set "Fan" to "Off" in the "Function" menu.

Please use the wall attachment panel exclusively when installing vertically. And you have to put left side of the PDP Monitor on top when viewed from front.

Before Using the Video Wall and the Multiple Display Control function

- 1 Please create ID for each PDP Monitor before installing them close together. It may be difficult to create IDs when operating the remote control for PDPs that are installed close to each other.
- 2 For details about Video Wall configuration and operation, refer to "Setting the Multiple Screen" on page 33.

Example for 2x2 Video Wall function

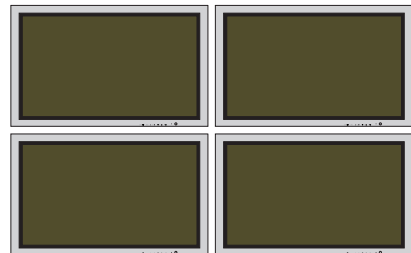

Example for 2x2 Video Wall connections

Rear of the PDP Monitor

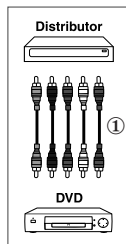
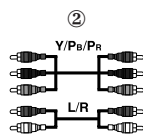
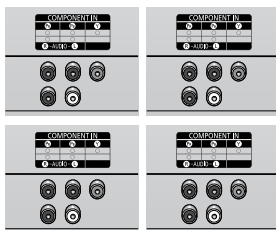

Rear of the PDP Monitor

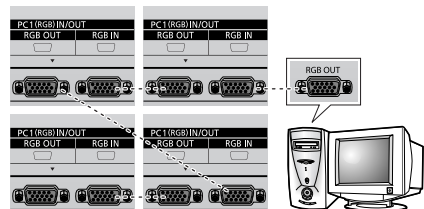

- ◆ You can connect a Composite (Video) without a distributor as you would connect a PC.
- ◆ Select ID input on the menu. Use the numeric buttons to enter the ID for PDP Monitor adjustment. You can operate the remote control only for the PDP Monitor that has been selected.
- ◆ For details about Multiple Display Control, refer to "Setting the MDC (Multiple Display Control)" on page 29 and the Help section in MDC program CD.

Example for Multiple Display Control connections

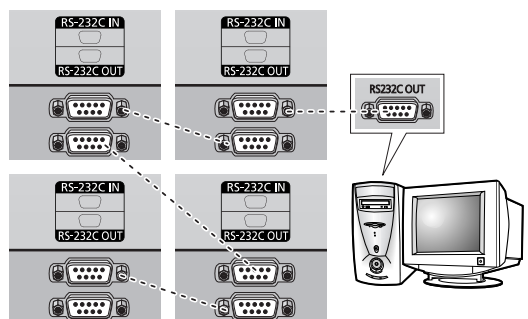

Connecting Speakers

- Speakers are optional. You have to purchase the speakers additionally.

- 1 Remove the screws on the rear of the PDP Monitor.

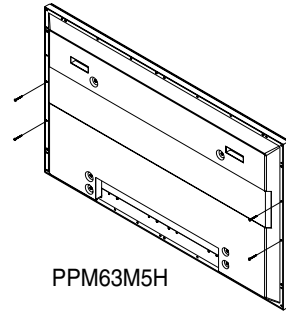
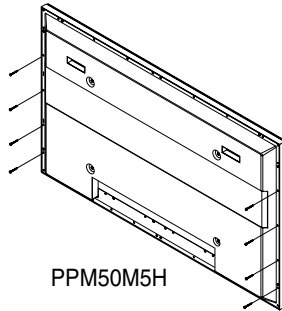
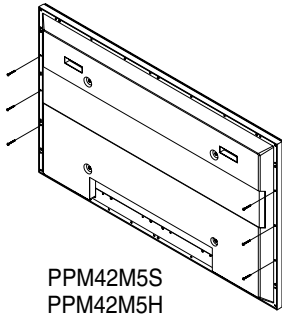

- 2 Hang the two "T" shaped hangers on the square holes on the rear of the PDP Monitor.

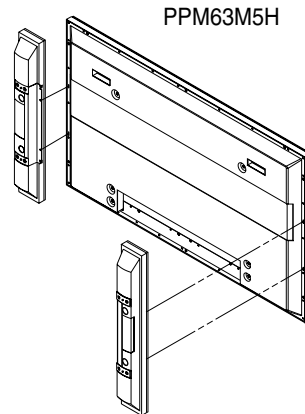
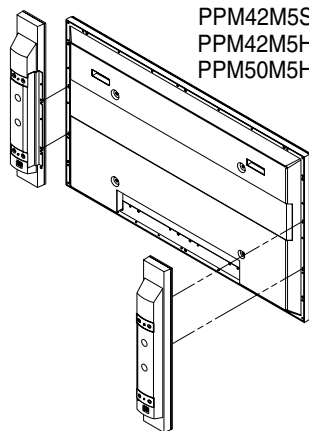

- 3 Tighten the PDP Monitor and the speaker bracket using the screws removed from the PDP Monitor.

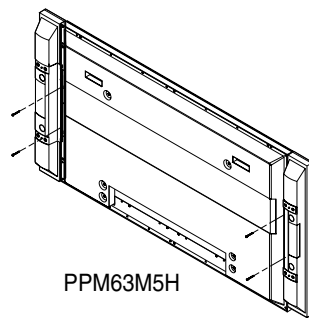
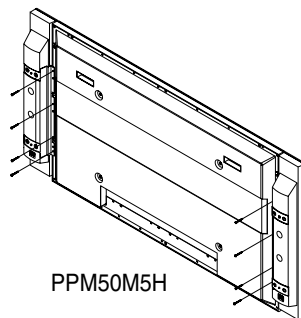
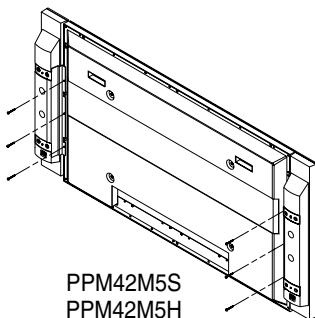

- When moving your PDP Monitor, do NOT hold the speaker connected to your PDP Monitor. It may damage the bracket clamping the speaker and your PDP Monitor together and result in a drop of your PDP Monitor and a risk of personal damage and injury.

Connecting Speakers (continued)

Connect the speaker audio cable to the external speaker output jack on the rear of the PDP Monitor matching the "+" and "-" ends of the cable with the diagram on the PDP Monitor.

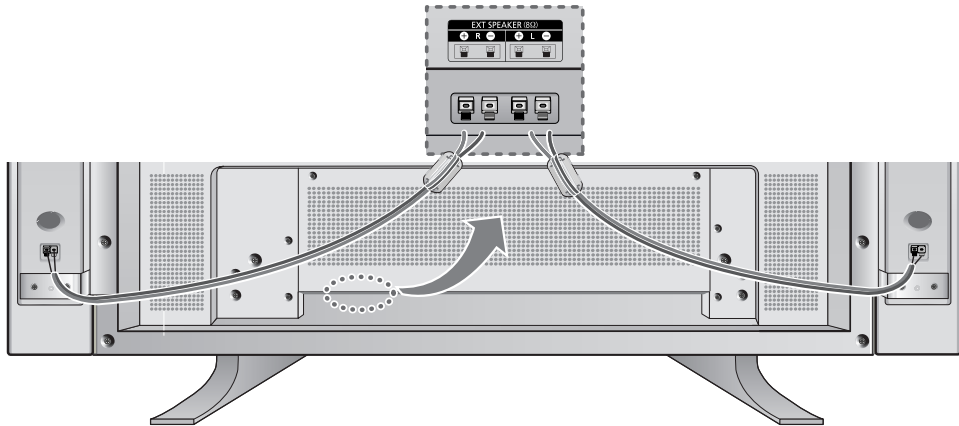

- ◆ The speakers MUST have a power handling capability of 10 watts minimum (impedance 8Ω).
- ◆ When you connect the speaker wire to the external speaker out connector, first bind the speaker wire round the ferrite core to secure it.

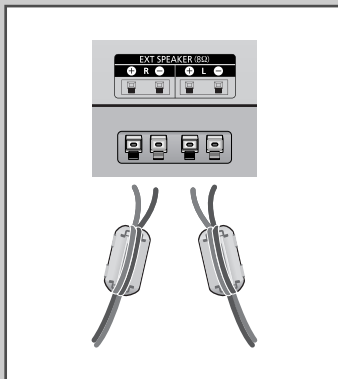

Ferrite Cores

The ferrite cores are used to attenuate undesired signals. When connecting cables, attach one of these ferrite cores to the cable near the connector.

Switching Your PDP Monitor On and Off

The mains lead is attached to the rear of your PDP Monitor.

- 1 Plug the mains lead into an appropriate socket.
Result: The Standby indicator on the front of the PDP Monitor lights up.
➤ The main voltage is indicated on the rear of the PDP Monitor and the frequency is 50 or 60Hz.
- 2 Press the “|/⏻” button on the front of the PDP Monitor (or the **ON** (⏻) button on the remote control) to switch the PDP Monitor on.
- 3 To switch your PDP Monitor off, press the “|/⏻” button again (or the **OFF** (⏻) button on the remote control).

Front of the PDP Monitor

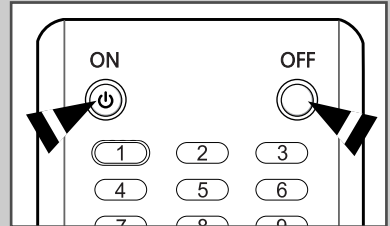

Choosing Your Language

When you start using your PDP Monitor for the first time, you must select the language which will be used for displaying menus and indications.

- 1 Press the **MENU** (□□□) button.
Result: The main menu is displayed.
- 2 Press the **▲** or **▼** button to select **Setup**.
Result: The **Setup** menu is displayed.
- 3 Press the **ENTER** (↵) button.
- 4 Press the **▲** or **▼** button to select **Language**. Press the **ENTER** (↵) button.
Result: The available languages are listed.
- 5 Select the appropriate language by pressing the **▲** or **▼** button. Press the **ENTER** (↵) button.



Changing the Picture Standard

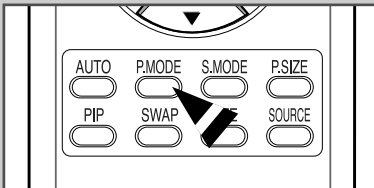
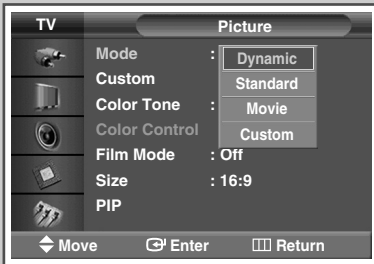
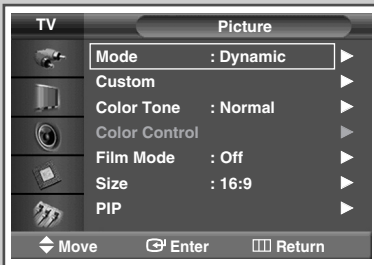

You can select the type of picture which best corresponds to your viewing requirements.

- 1 Press the **MENU** () button.
Result: The main menu is displayed.

- 2 Press the **▲** or **▼** button to select **Picture**.
Result: The **Picture** menu is displayed.

- 3 Press the **ENTER** () button.
Result: The **Mode** is selected.

- 4 Press the **ENTER** () button again.
Result: The available options are listed.

- 5 Select the required option by pressing the **▲** or **▼** button.
Result: The following options are available.
 - ◆ **Dynamic - Standard - Movie - Custom**
 - ◆ **Entertain - Internet - Text - Custom**
: PC or DVI Mode.

- 6 Press the **ENTER** () button.

➤ You can also set these options simply by pressing the **P.MODE** (Picture Mode) button on the remote control.

Customizing the Picture Settings

Your PDP Monitor has several setting options that allow you to control the picture quality.

- 1 Press the **MENU** () button.
Result: The main menu is displayed.

- 2 Press the **▲** or **▼** button to select **Picture**.
Result: The **Picture** menu is displayed.

- 3 Press the **ENTER** () button.
Result: The **Mode** is selected.

- 4 Press the **▲** or **▼** button to select **Custom**.
Press the **ENTER** () button.

- 5 Select the required option by pressing the **▲** or **▼** button.
Result: The following options are available.
 - ◆ **Contrast - Brightness - Sharpness - Color - Tint** (NTSC only)
 - ◆ **Contrast - Brightness** : PC or DVI Mode.

- 6 Press the **ENTER** () button.
Result: The horizontal bar is displayed.
Press the **◀** or **▶** button until you reach the optimal setting.
 - ◆ Press the **▲** or **▼** button to select other option(s).
 - ◆ When the picture mode is set to **Custom**, the settings values may vary depending on the input source. (ex. AV, Component, PC, or DVI.)

- 7 Press the **ENTER** () button.

- 8 Press the **MENU** () button to return to the **Picture** menu.
Press the **▲** or **▼** button to select **Color Tone**.
Press the **ENTER** () button.

- 9 Select the required option by pressing the **▲** or **▼** button.
Result: The following options are available.
 - ◆ **Cool12 - Cool11 - Normal - Warm1 - Warm2**
 - ◆ **Custom - Cool - Normal - Warm** : PC Mode.
 - ◆ **Cool - Normal - Warm** : DVI Mode.

- 10 Press the **ENTER** () button.

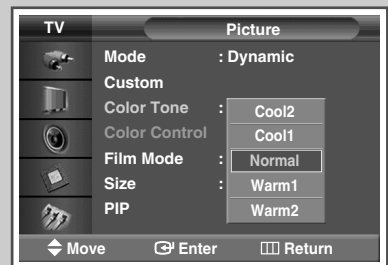
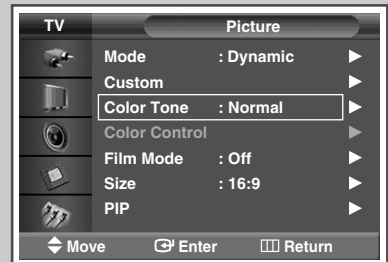
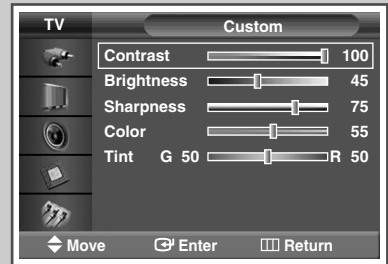
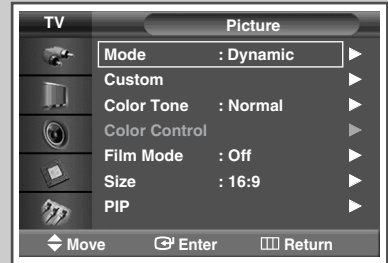

Adjusting the RGB Color (PC Mode)

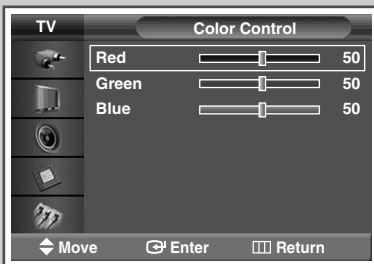
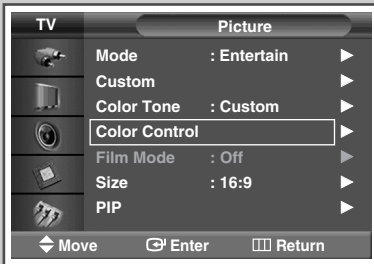
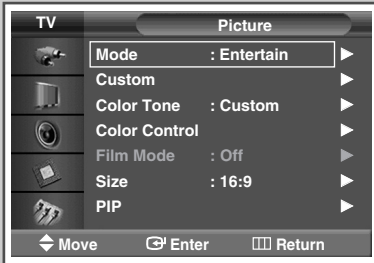



➤ Preset to the **PC** mode by pressing the **SOURCE** () button.

- 1 Press the **MENU** () button.
Result: The main menu is displayed.

- 2 Press the **▲** or **▼** button to select **Picture**.
Result: The **Picture** menu is displayed.

- 3 Press the **ENTER** () button.

- 4 Press the **▲** or **▼** button to select **Color Tone**.
Press the **ENTER** () button.

- 5 Press the **▲** or **▼** button to select **Custom**.
Press the **ENTER** () button.
➤ This feature is not available when the input source is DVI mode.

- 6 Press the **▲** or **▼** button to select **Color Control**.
Press the **ENTER** () button.

- 7 Select the required option (**Red**, **Green**, or **Blue**) by pressing the **▲** or **▼** button.

- 8 Press the **ENTER** () button.
Result: The horizontal bar is displayed.
Press the **◀** or **▶** button until you reach the optimal setting.
➤ Press the **▲** or **▼** button to select other option(s).

- 9 Press the **ENTER** () button.

Setting the Picture (PC Mode)

➤ Preset to the **PC** mode by pressing the **SOURCE** () button.

1 Press the **MENU** () button.

Result: The main menu is displayed.

2 Press the **▲** or **▼** button to select **Setup**.

Result: The **Setup** menu is displayed.

3 Press the **ENTER** () button.

4 Press the **▲** or **▼** button to select **PC**.
Press the **ENTER** () button.

Result: The **PC** menu is displayed.

5 Press the **ENTER** () button again to select **Auto Adjustment**.

Result: The screen quality and position are automatically reset.
The settings are all finished, and the PDP Monitor will automatically return to the previous picture.

6 Press the **▲** or **▼** button to select **Image Lock**.
Press the **ENTER** () button.

7 Press the **▲** or **▼** button to select the option (**Coarse** or **Fine**) to be adjusted. Press the **ENTER** () button.

Result: The horizontal bar is displayed.
Press the **◀** or **▶** button until you reach the optimal setting.

➤ Press the **▲** or **▼** button to select other option(s).

8 Press the **ENTER** () button.

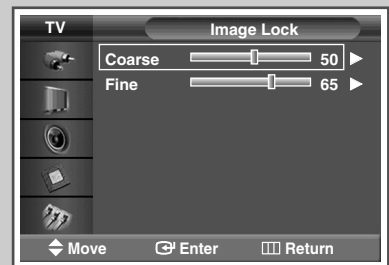
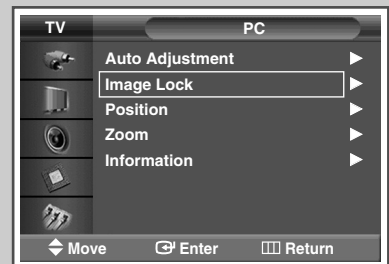
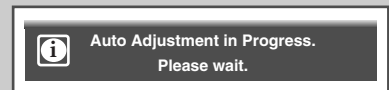
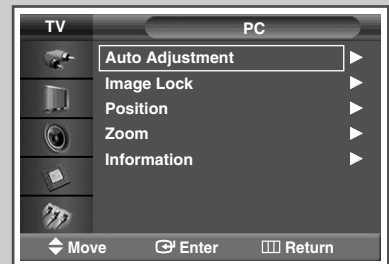

Setting the Picture (PC Mode) (continued)

- Preset to the **PC** mode by pressing the **SOURCE** () button.

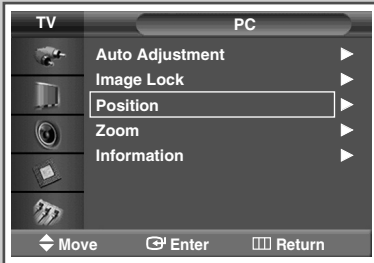

- 9** Press the **MENU** () button.

Result: The **PC** menu is displayed again.

- 10** Press the **▲** or **▼** button to select **Position**.
Press the **ENTER** () button.

- 11** Adjust the position by pressing the **▲**, **▼**, **◀**, or **▶** button.

- 12** Press the **ENTER** () button.

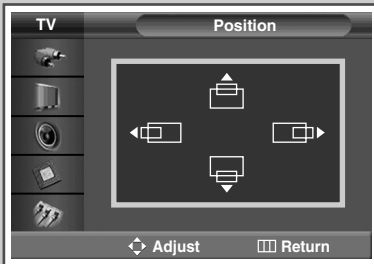

Using Zoom function (PC Mode)

➤ Preset to the **PC** mode by pressing the **SOURCE** ([-]) button.

1 Press the **MENU** ([]) button.

Result: The main menu is displayed.

2 Press the **▲** or **▼** button to select **Setup**.

Result: The **Setup** menu is displayed.

3 Press the **ENTER** ([]) button.

4 Press the **▲** or **▼** button to select **PC**.
Press the **ENTER** ([]) button.

Result: The **PC** menu is displayed.

5 Press the **▲** or **▼** button to select **Zoom**.
Press the **ENTER** ([]) button.

6 Press the **ENTER** ([]) button again.
Select the required option by pressing the **▲** or **▼** button.

Result: The following options are available.

0 - 1 - 2 - 3 - 4 - 5 - 6

- ◆ Option 0 represents a normal screen.
The greater the number, the more magnified the screen.
- ◆ You can select the position and reset functions by selecting options 1 through 6. (If you select option 0, the position and reset functions are not selected.)
- ◆ If you have selected the Zoom function as between 1~6, you will not be able to select the Auto Adjustment function.

7 Press the **ENTER** ([]) button.

8 Press the **▲** or **▼** button to select **Position**.
Press the **ENTER** ([]) button.

9 Adjust the position by pressing the **▲**, **▼**, **◀**, or **▶** button.

10 Press the **MENU** ([]) button.

Result: The **zoom** menu is displayed again.

11 To return the factory defaults, select **Reset** by pressing the **▲** or **▼** button. Press the **ENTER** ([]) button.

Result: The previously adjusted settings will be reset to the factory defaults.

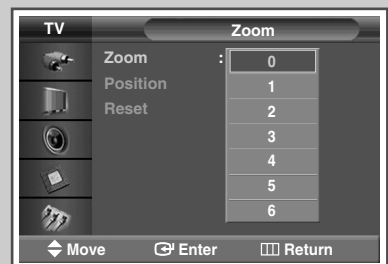
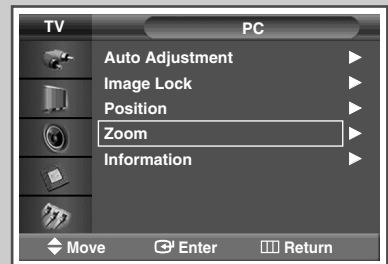



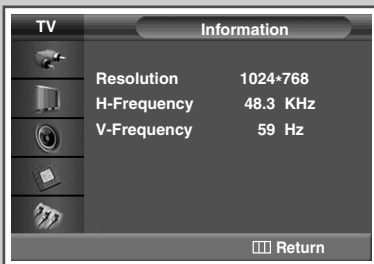
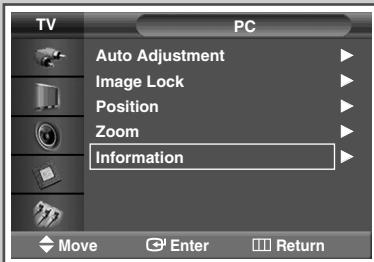

Viewing the PC Information

- Preset to the **PC** mode by pressing the **SOURCE** () button.

You can view the current resolution and frequency of your pc.



- 1 Press the **MENU** () button.
Result: The main menu is displayed.
- 2 Press the **▲** or **▼** button to select **Setup**.
Result: The **Setup** menu is displayed.
- 3 Press the **ENTER** () button.
- 4 Press the **▲** or **▼** button to select **PC**.
Press the **ENTER** () button.
Result: The **PC** menu is displayed.
- 5 Press the **▲** or **▼** button to select **Information**.
- 6 Press the **ENTER** () button.
Result: The resolution, vertical frequency and horizontal frequency are displayed.
- 7 Press the **MENU** () button.

Selecting the Picture Size

You can select the picture size which best corresponds to your viewing requirements.

- 1 Press the **MENU** () button.

Result: The main menu is displayed.

- 2 Press the **▲** or **▼** button to select **Picture**.

Result: The **Picture** menu is displayed.

- 3 Press the **ENTER** () button.

- 4 Press the **▲** or **▼** button to select **Size**.

Press the **ENTER** () button.

- 5 Select the required option by pressing the **▲** or **▼** button.

Result: The following options are available.

- ◆ **16:9** : Sets the picture to 16:9 wide mode.
- ◆ **Panorama** : Use this mode for the wide aspect ratio of a panoramic picture.
- ◆ **Zoom1** : The screen size when wide screen is vertically enlarged.
- ◆ **Zoom2** : The screen size when the **Zoom1** screen is vertically enlarged.
- ◆ **14:9** : Magnify the size of the picture more than 4:3.
- ◆ **4:3** : Sets the picture to 4:3 normal mode.

- 6 Press the **ENTER** () button.

- ◆ You can select these options simply by pressing the **P.SIZE** button on the remote control.
- ◆ If you change the picture size In PIP mode, PIP disappears automatically.
- ◆ Depending on the input source, the **P.SIZE** options may vary.
- ◆ Check if the Video Wall (refer to page 33) is On if the Picture size is not function. Picture size does not function when the Video Wall is set to On. Change the setting to Off and try it again.

Positioning and Sizing the screen using Zoom

- ◆ Resizing the screen using the **Zoom** enables the positioning and sizing of the screen to up/down direction using the **▲** or **▼** button as well as the screen size.
- ◆ Move the screen up/down using the **▲** or **▼** button after selecting the  by pressing the **◀** or **▶** button.
- ◆ Screen enlargement operates only in AV/S-Video/Component input modes.
- ◆ In PC or DVI mode, you can select either 16:9 or 4:3.

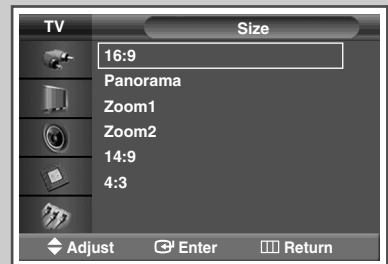
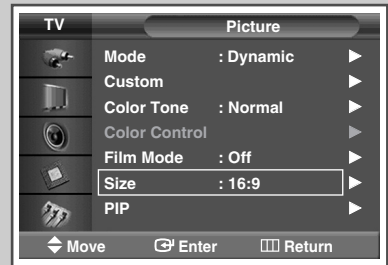

PC to DVI Mode

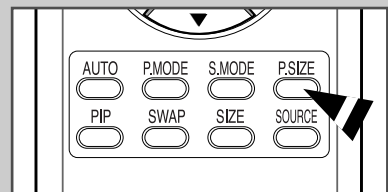
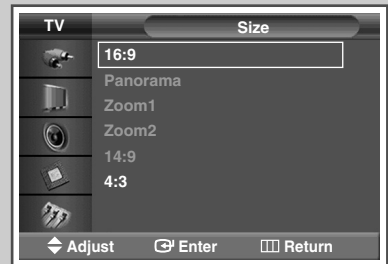

Freezing the Current Picture

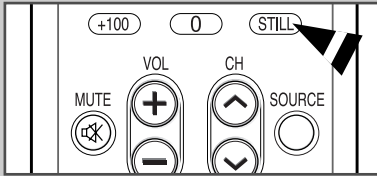

You can freeze the picture when watching a moving picture simply by pressing the “STILL” button. To return to normal viewing, press it again.

- The Still function in PIP mode will be applied to the main picture and not to the sub picture.

Changing the Sound Standard

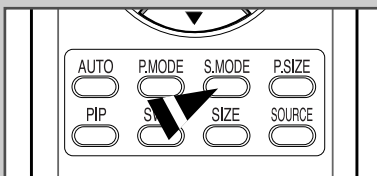
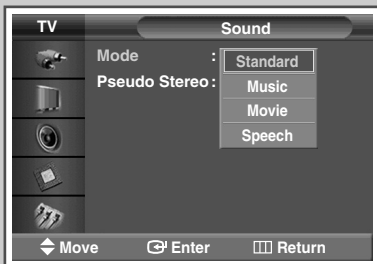
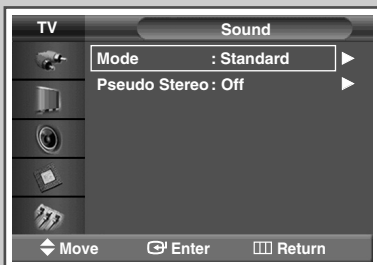

You can select the type of special sound effect to be used when watching a given broadcast.

- 1 Press the **MENU** (□□□) button.
Result: The main menu is displayed.

- 2 Press the **▲** or **▼** button to select **Sound**.
Result: The **Sound** menu is displayed.

- 3 Press the **ENTER** (↵) button.
Result: The **Mode** is selected.

- 4 Press the **ENTER** (↵) button again.
Select the required option by pressing the **▲** or **▼** button.
Result: The following options are available.
Standard - Music - Movie - Speech

- 5 Press the **ENTER** (↵) button.

- You can select these options by simply pressing the **S.MODE** (Sound Mode) button on the remote control.

Extra Sound Settings

◆ Pseudo Stereo

Pseudo Stereo feature converts a monaural sound signal into two identical left and right channels. Once the **Pseudo Stereo** is set to **On** or **Off**, these settings apply to the sound effects such as **Standard**, **Music**, **Movie**, and **Speech**.

- 1 Press the **MENU** () button.
Result: The main menu is displayed.
- 2 Press the **▲** or **▼** button to select **Sound**.
Result: The **Sound** menu is displayed.
- 3 Press the **ENTER** () button.
- 4 Press the **▲** or **▼** button to select **Pseudo Stereo**. Press the **ENTER** () button.
- 5 Select **Off** or **On** by pressing the **▲** or **▼** button. Press the **ENTER** () button.

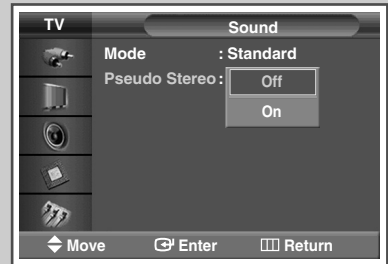
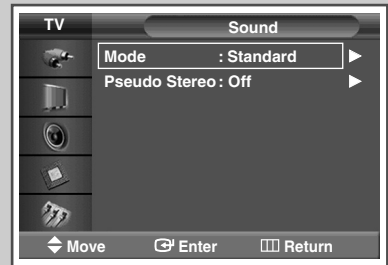

Activating Panel Button Lock



This feature allows you to lock the PDP Monitor panel buttons so that it cannot be operated via the PDP Monitor panel. It can, however, still be operated via the remote control. Only remote control can release the panel lock setting, so keep the remote control away from unauthorized users.

- 1 Press the **MENU** () button.
Result: The main menu is displayed.
- 2 Press the **▲** or **▼** button to select **Function**.
Result: The **Function** menu is displayed.
- 3 Press the **ENTER** () button.
- 4 Press the **▲** or **▼** button to select **Safety Lock**.
Press the **ENTER** () button.
- 5 Press the **ENTER** () button again to select **Key Lock**.
- 6 Select **Off** or **On** by pressing the **▲** or **▼** button.
Press the **ENTER** () button.

Activating Remote Control Button Lock

This feature allows you to lock the remote control so that it cannot be operated via the remote control. It can, however, still be operated via the PDP Monitor Panel buttons.

- 1 Press the **MENU** (□□□) button.

Result: The main menu is displayed.

- 2 Press the ▲ or ▼ button to select **Function**.

Result: The **Function** menu is displayed.

- 3 Press the **ENTER** (↵) button.

- 4 Press the ▲ or ▼ button to select **Safety Lock**.
Press the **ENTER** (↵) button.

- 5 Press the ▲ or ▼ button to select **IR Lock**.
Press the **ENTER** (↵) button.

- When IR Lock is set to On, you will not be able to use the remote control even if the remote control button is pressed. To cancel the Remote Control Button Lock, press "0000" using the numeric buttons on the remote control.

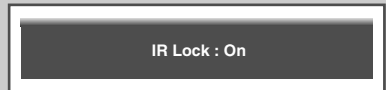

Setting Up Your Personal ID Number

This feature sets viewing restrictions and prevents unauthorized access to your PDP Monitor through the PIN (Personal Identification Number), which is a 4 digit number.

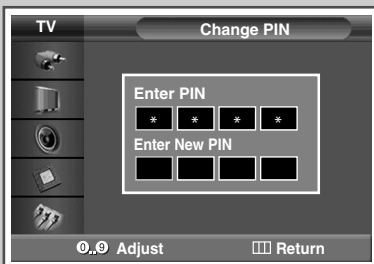
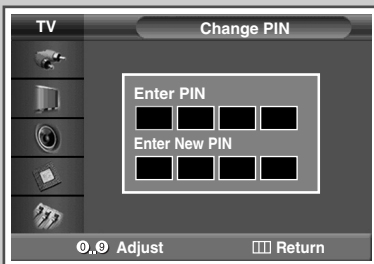

- 1 Press the **MENU** (□□□) button.
Result: The main menu is displayed.
- 2 Press the **▲** or **▼** button to select **Function**.
Result: The **Function** menu is displayed.
- 3 Press the **ENTER** (⏏) button.
- 4 Press the **▲** or **▼** button to select **Safety Lock**. Press the **ENTER** (⏏) button.
- 5 Press the **▲** or **▼** button to select **Change PIN**. Press the **ENTER** (⏏) button.
- 6 Press the number buttons to enter your current 4-digit pin number.
➤ The default pin number for a new PDP Monitor set is "0000".
- 7 Press the numeric buttons to enter your new 4-digit pin number. Re-enter your new pin number to confirm.

- If you forget the pin number, press the remote control buttons in the following sequence, which resets the pin to 0-0-0-0: MUTE, 1, 8, 6.

Setting the MDC (Multiple Display Control)

This function enables you to easily control the connected monitors on the PC by specifying IDs to connected monitors.

- 1 Press the **MENU** () button.

Result: The main menu is displayed.

- 2 Press the **▲** or **▼** button to select **Function**.



Result: The **Function** menu is displayed.

- 3 Press the **ENTER** () button.

- 4 Press the **▲** or **▼** button to select **Multi Control**.

- 5 Press the **ENTER** () button.

Result: The **Multi Control** menu is displayed with the **ID Setup** selected.

- 6 Press the **ENTER** () button again.
Select the ID setup number by pressing the **▲** , **▼** , or numeric buttons.
Press the **ENTER** () button.

- 7 Press the **▲** or **▼** button to select **ID Input**.
Press the **ENTER** () button.

- 8 Enter ID input number by using the numeric buttons.
Press the **ENTER** () button.

- To operate the multi control function, PDP1 and PDP2 should be set in the ID Setup mode. When entering the ID Input number of PDP1 while the PDP Monitor is set in the ID Input mode, only PDP1 is switched to the Menu screen and you can operate the remote control. At this time, PDP2 doesn't operate with the remote control and displays the standby mode of ID Input.
- For further details, refer to the MDC program guide.

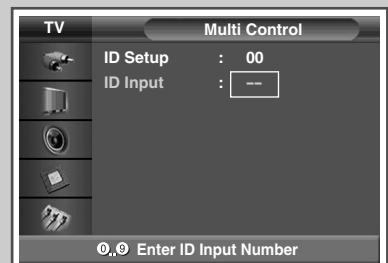
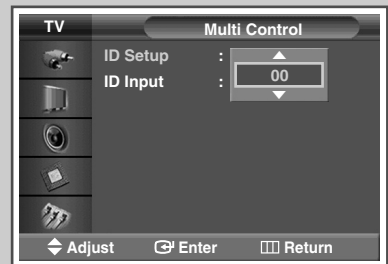
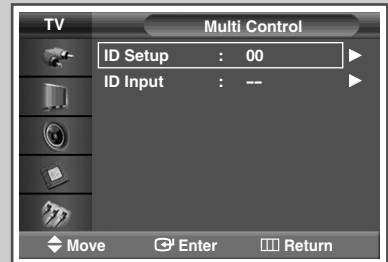

Preventing Screen Burn-in

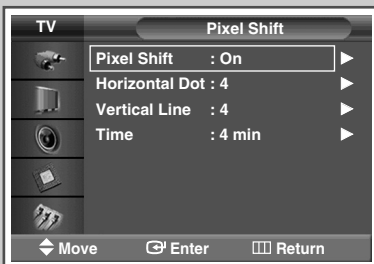
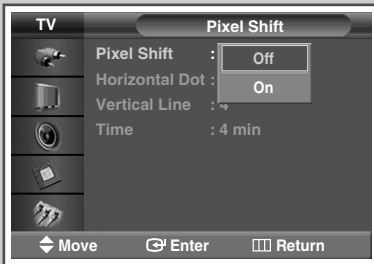
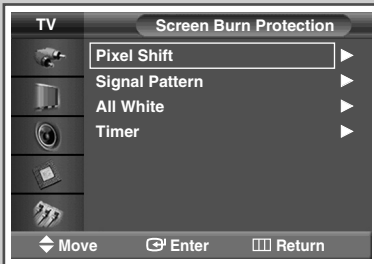

To reduce the possibility of screen burn, this unit is equipped with screen burn prevention technology. This technology enables you to set picture movement up/down (Vertical Line) and side to side (Horizontal Dot). The Time setting allows you to program the time between movement of the picture in minutes.

- 1 Press the **MENU** () button.
Result: The main menu is displayed.

- 2 Press the **▲** or **▼** button to select **Function**.
Result: The **Function** menu is displayed.

- 3 Press the **ENTER** () button.

- 4 Press the **▲** or **▼** button to select **Screen Burn Protection**. Press the **ENTER** () button.
Result: The **Screen Burn Protection** menu is displayed with the **Pixel Shift** selected.

- 5 Press the **ENTER** () button again.
Result: The **Pixel Shift** menu is selected.

- 6 Press the **ENTER** () button. Select **On** by pressing the **▲** or **▼** button for making the screen move per regular hour and preventing the residual image. Press the **ENTER** () button.
➤ **Pixel Shift:** Using this function, you can minutely move pixels on the PDP in horizontal or vertical direction to prevent after image on the screen.

- 7 Select the required option (**Horizontal Dot**, **Vertical Line**, or **Time**) by pressing the **▲** or **▼** button. Press the **ENTER** () button.

- 8 Press the **▲** or **▼** button until you reach the optimal setting. Press the **ENTER** () button.
➤ Optimum condition for pixel shift;

	PPM42M5S	PPM42M5H	PPM50/63M5H
Horizontal Dot	2	2	4
Vertical Line	4	4	4
Time	4 min	4 min	4 min

Reducing the Effects of Screen Burn

If screen burn has occurred, you can select a white screen or signal pattern (rolling screen) to help remove screen burn artifacts.

- 1 Press the **MENU** () button.

Result: The main menu is displayed.

- 2 Press the **▲** or **▼** button to select **Function**.

Result: The **Function** menu is displayed.

- 3 Press the **ENTER** () button.

- 4 Press the **▲** or **▼** button to select **Screen Burn Protection**. Press the **ENTER** () button.

Result: The **Screen Burn Protection** menu is displayed with the **Pixel Shift** selected.

- 5 Press the **▲** or **▼** button to select the option (**Signal Pattern** or **All White**). Press the **ENTER** () button.

- **Signal Pattern:** This function removes after images on the screen by moving all the pixels on the PDP according to a pattern. Use this function when there are remaining after images or symbols on the screen especially when you displayed a still image on the screen for a long time.
- **All White:** This function removes after images on the screen by changing the color of pixels to white. Use this function when there are remaining after images or symbols on the screen especially when you displayed a still image on the screen for a long time.

- 6 Press the **ENTER** () button.

- To remove after images on the screen, use either “**All White**” or “**Signal Pattern**” function. Although both of the two functions remove after images on the screen, “**Signal Pattern**” is more effective.
- The after image removal function has to be executed for a long time (approximately 1 hour) to effectively remove after images on the screen. If after image is not removed after the execution of the function, repeat the function additionally.

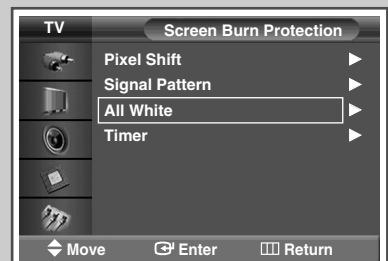
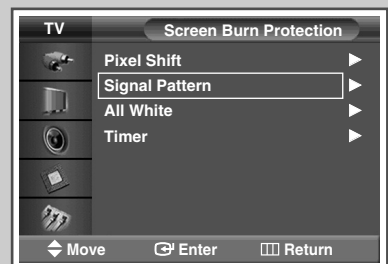
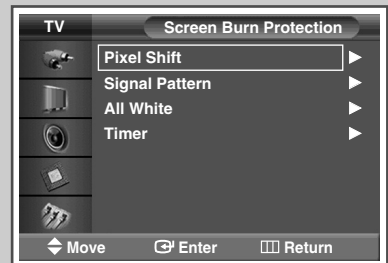

Setting the Screen Burn Protection Timer

You can set the timer for Screen Burn Protection (hours, minutes). If you start the operation to erase any residual image, the operation will be performed for the set period of time and then automatically finish.

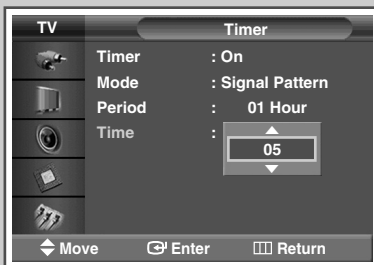
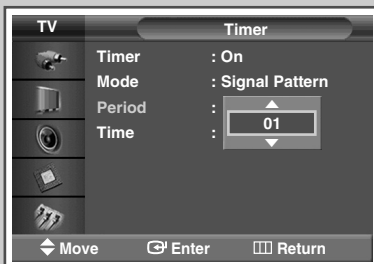
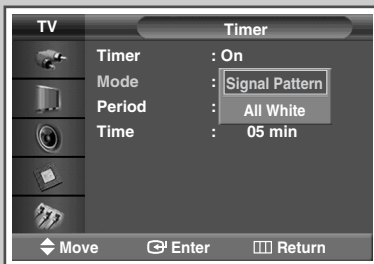
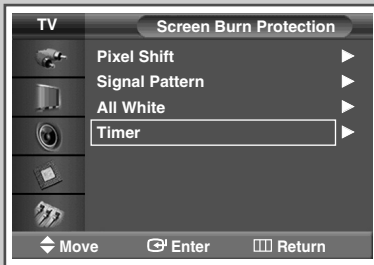

- 1 Press the **MENU** ([]) button.
Result: The main menu is displayed.

- 2 Press the **▲** or **▼** button to select **Function**.
Result: The **Function** menu is displayed.

- 3 Press the **ENTER** ([]) button.

- 4 Press the **▲** or **▼** button to select **Screen Burn Protection**. Press the **ENTER** ([]) button.

- 5 Press the **▲** or **▼** button to select **Timer**. Press the **ENTER** ([]) button.
Result: The **Timer** menu is displayed.











- 6 Press the **ENTER** ([]) button again.

- 7 Select **On** by pressing the **▲** or **▼** button. Press the **ENTER** ([]) button.

- 8 Select the required option by pressing the **▲** or **▼** button.
Result: The following options are available.
 - ◆ **Mode** : **Signal Pattern, All White**
 - ◆ **Period** : **Hour (1~24)**
 - ◆ **Time** : **Minute (1~30)**

Setting the Multiple Screen

You can get various display effects with many PDPs.

- 1 Press the **MENU** () button.
Result: The main menu is displayed.
- 2 Press the **▲** or **▼** button to select **Function**.
Result: The **Function** menu is displayed.
- 3 Press the **ENTER** () button.
- 4 Press the **▲** or **▼** button to select **Video Wall**.
- 5 Press the **ENTER** () button.
Result: The **video Wall** menu is displayed with the **video Wall** selected.
- 6 Press the **ENTER** () button.
Select **On** by pressing the **▲** or **▼** button.
Press the **ENTER** () button.
- 7 Press the **▲** or **▼** button to select **Format**.
Press the **ENTER** () button.
- 8 Select the required option by pressing the **▲** or **▼** button.
Result: The following options are available.
 - ◆ Full : This option displays divided images on multiple monitors without missing parts as if only the viewable part of the separate monitors were simply part of a large single monitor.
 - ◆ Natural : This option displays divided images on multiple monitors as if the separate monitors were simply part of a large single monitor. Therefore there are missing parts on the edge of the monitors.Press the **ENTER** () button.
- 9 Press the **▲** or **▼** button to select **Screen Divider**.
Press the **ENTER** () button.
- 10 Select the option (**2x2**, **3x3**, **4x4**, **1x5**, or **5x1**) by pressing the **▲** or **▼** button. Press the **ENTER** () button.
- 11 Press the **◀** or **▶** button to select the position of the screens.
- 12 Press the **MENU** () button.

- The PIP function and Picture Size do not work during the Video Wall operation.

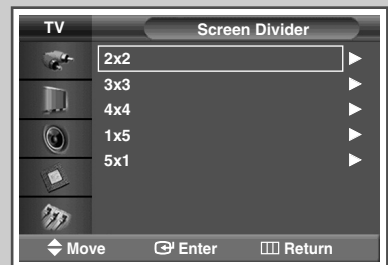
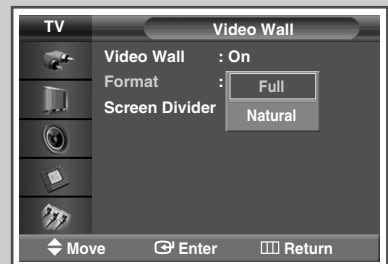
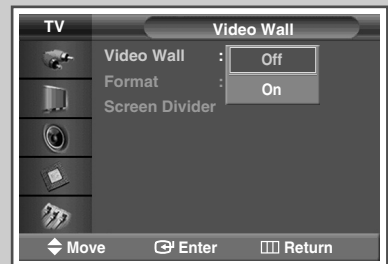
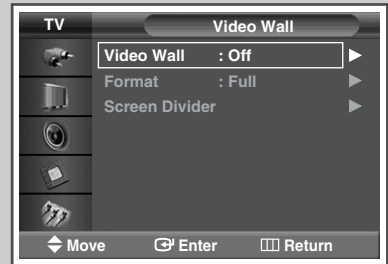

Displaying the Setting Information



You can view the setting status you select by pressing the “INFO” button on the remote control.

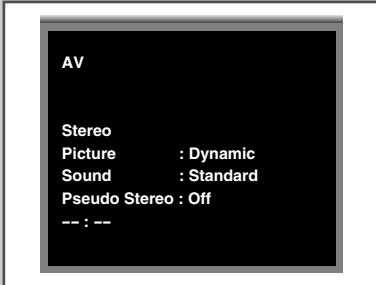

Setting and Displaying the Current Time

You can set the PDP Monitor’s clock so that the current time is displayed by pressing the “INFO ()” button. You must also set the time if you wish to use the automatic on or off timers.



1 Press the **MENU** () button.
Result: The main menu is displayed.

2 Press the **▲** or **▼** button to select **Setup**.
Result: The **Setup** menu is displayed.

3 Press the **ENTER** () button.

4 Press the **▲** or **▼** button to select **Time**.
Press the **ENTER** () button.
Result: The **Cl**ock **S**et is selected.

5 Press the **ENTER** () button again.

6 Press the **◀** or **▶** button to select **Hour** or **min**.
Set these by pressing the **▲** or **▼** button.

7 Press the **MENU** () button.

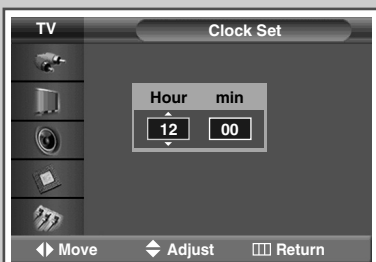
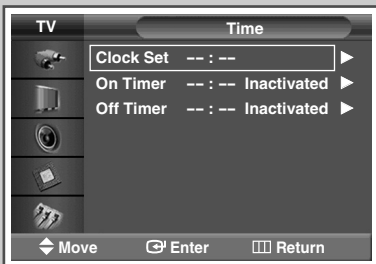

Switching the PDP Monitor On and Off Automatically

You can set the on or off timers so that the PDP Monitor will:

- ◆ Switch on automatically and tune source of your choice at the time you select.
- ◆ Switch off automatically at the time you select.

➤ The first step is to set the PDP Monitor's clock (refer to "Setting and Displaying the Current Time" on page 34).

- 1 Press the **MENU** (□□□) button.
Result: The main menu is displayed.
- 2 Press the **▲** or **▼** button to select **Setup**.
Result: The **Setup** menu is displayed.
- 3 Press the **ENTER** (↵) button.
- 4 Press the **▲** or **▼** button to select **Time**.
Press the **ENTER** (↵) button.
Result: The **Time** menu is displayed.
- 5 Press the **▲** or **▼** button to select **On Timer**.
Press the **ENTER** (↵) button.
Result: The **On Timer** menu is displayed.
- 6 Select **Hour**, **min**, **Activation**, **Volume**, or **Source** by pressing the **◀** or **▶** button.
Set these by pressing the **▲** or **▼** button.
- 7 To activate **On Timer** with the setting entered, select **Yes** by pressing the **▲** or **▼** button.
- 8 Press the **MENU** (□□□) button.
Result: The **Time** menu is displayed again.

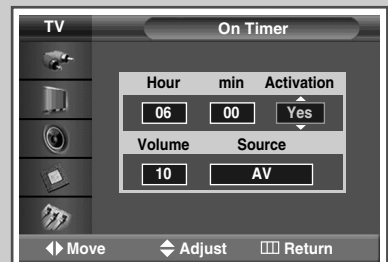
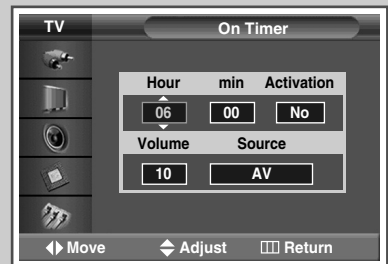
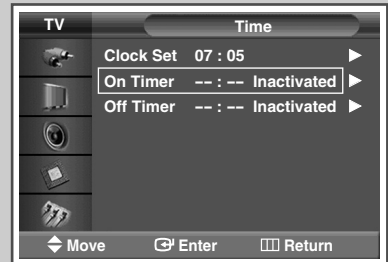

Switching the PDP Monitor On and Off Automatically (continued)

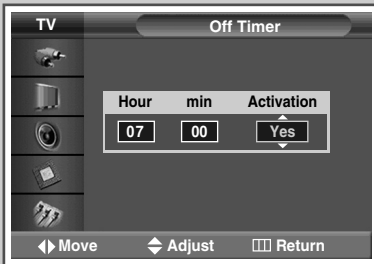
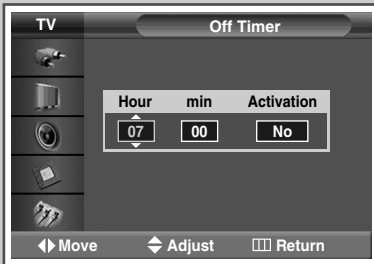
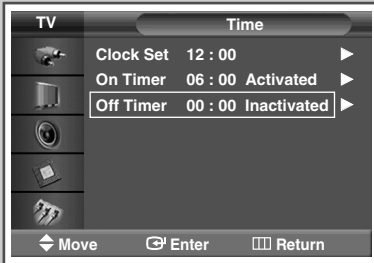

- 9 Press the ▲ or ▼ button to select **Off Timer**. Press the **ENTER** (⏏) button.
Result: The **Off Timer** menu is displayed.
- 10 Select **Hour** or **min** by pressing the ◀ or ▶ button. Set these by pressing the ▲ or ▼ button.
- 11 Press the ◀ or ▶ button to select **Activation**.
- 12 To activate **Off Timer** with the setting entered, select **Yes** by pressing the ▲ or ▼ button.
- 13 Press the **MENU** (⏏) button.



Auto Power Off

When you set the timer "On", the PDP Monitor will eventually turn off, if no controls are operated for 3 hours after the PDP Monitor was turned on by timer. This function is only available in timer "On" mode and prevents overheating or leakages, which may occur if a PDP Monitor is on for too long (when you are on vacation, for example).

Selecting the Fan

Fans inside the PDP Monitor are used to lower the temperature of the tops and the front of the PDP Monitor. To reduce the noise of the fan, you may stop the fan by setting the Fan to "Off".

The temperature of the top and the front of the PDP Monitor may increase when you watch the PDP Monitor for a long period of time while the fan is stopped, but the PDP Monitor will operate normally.

1 Press the **MENU** () button.

Result: The main menu is displayed.

2 Press the **▲** or **▼** button to select **Function**.

Result: The **Function** menu is displayed.

3 Press the **ENTER** () button.

4 Press the **▲** or **▼** button to select **Fan**.
Press the **ENTER** () button.

5 Select **Off** or **On** by pressing the **▲** or **▼** button.
Press the **ENTER** () button.





- ◆ If your PDP Monitor is displayed vertically, the fan automatically works.
- ◆ The message **Check Fan** is displayed if there is a fan problem.
- ◆ Please use the fan when the temperature is over 35 degrees.
- ◆ The Fan function for the models PPM-42M5SS, PPM42M5SS, PPM-42M5SB and PPM42M5SB is not available.

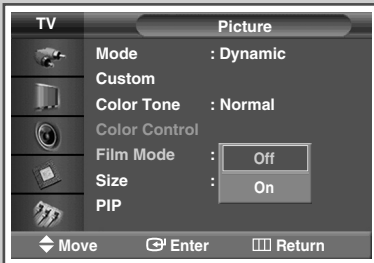
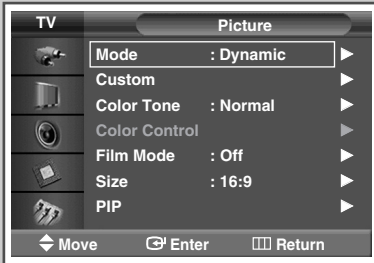

Setting the Film Mode



When a video input source is from a film such as movies, this feature identifies the source and changes to the corresponding screen.

- 1 Press the **MENU** () button.
Result: The main menu is displayed.
 - 2 Press the **▲** or **▼** button to select **Picture**.
Result: The **Picture** menu is displayed.
 - 3 Press the **ENTER** () button.
 - 4 Press the **▲** or **▼** button to select **Film Mode**.
Press the **ENTER** () button.
 - 5 Select **Off** or **On** by pressing the **▲** or **▼** button.
Press the **ENTER** () button.
- ◆ Automatically senses and processes film signals from all sources and adjusts the picture for optimum quality.
- ◆ Available in AV, S-Video, and Component (480i) modes.
- ◆ Unavailable in PC1, PC2, DVI mode.

Viewing the Picture in Picture (PIP)



You can display a sub picture within the main picture of external A/V devices. In this way you can monitor the video input from any connected devices while monitoring other video inputs.

- 1 Press the **MENU** () button.
Result: The main menu is displayed.

- 2 Press the **▲** or **▼** button to select **Picture**.
Result: The **Picture** menu is displayed.

- 3 Press the **ENTER** () button.





- 4 Press the **▲** or **▼** button to select **PIP**.
Press the **ENTER** () button.
Result: The **PIP** is selected.

- 5 Press the **ENTER** () button again.
To activate, set **PIP** to **On** by pressing the **▲** or **▼** button.
Press the **ENTER** () button.

- 6 Press the **▲** or **▼** button to select **Source**.
Press the **ENTER** () button.
Result: The following options are available.
AV - S-Video - Component - PC1 - PC2 - DVI

- 7 Select a source of the sub picture by pressing the **▲** or **▼** button.
Press the **ENTER** () button.

- 8 Press the **▲** or **▼** button to select **Swap**.
Press the **ENTER** () button.
Result: The main picture and sub picture are interchanged.

- 9 Press the **▲** or **▼** button to select **Size**.
Press the **ENTER** () button.
Result: The following options are available.
   
(Large) – (Small) – (Double Window) – (Double Wide)

- 10 Select a size of the sub picture by pressing the **▲** or **▼** button.
Press the **ENTER** () button.

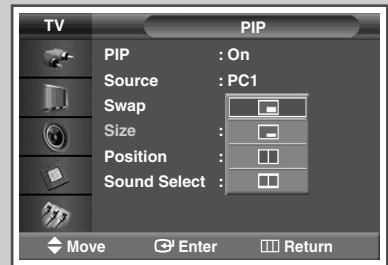
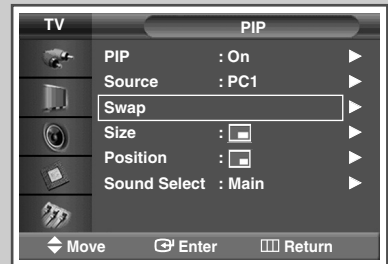
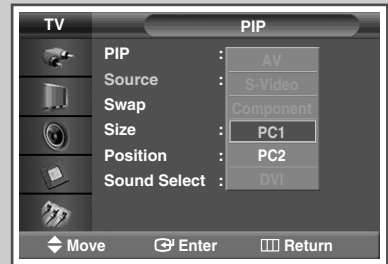
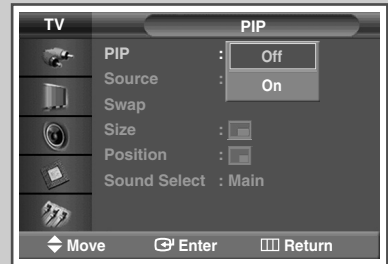
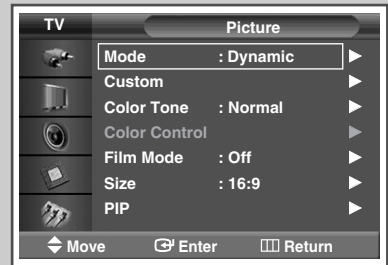

Viewing the Picture in Picture (PIP) (continued)

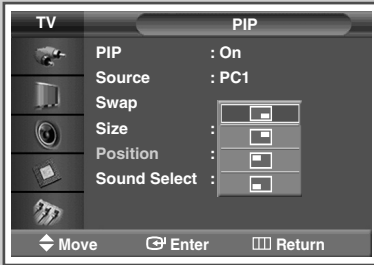

- 11 Press the ▲ or ▼ button to select **Position**. Press the **ENTER** (↵) button.

Result: The following options are available.



- The **Position** menu is available when the **Size** is large (Large) mode and small (Small) mode.

- 12 Select a position of the sub picture by pressing the ▲ or ▼ button. Press the **ENTER** (↵) button.

- Check if the Video Wall (refer to page 33) is On if the PIP On/Off does not function. PIP does not function when the Video Wall is set to On. Change the setting to Off and try it again.

Easy functions of the remote control.

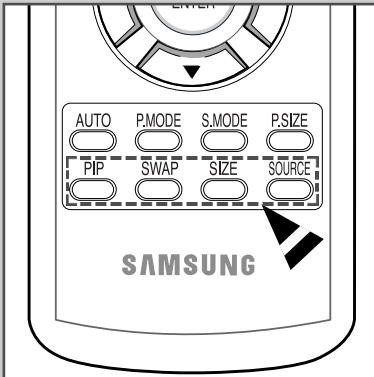

Buttons	Feature
PIP	Used to activate or deactivate the PIP function directly.
SWAP	Used to interchange the main picture and the sub picture.
SIZE	Used to select a size of the sub picture (Large), (Small), (Double Window), or (Double Wide)).
SOURCE	Used to assign a source of the sub picture (AV, S-Video, Component, PC1, PC2, or DVI).







Table of PIP Settings

X - This PIP combination is not available.
O - This PIP combination is available.

Sub	Main	AV	S-Video	Component	PC1	PC2(BNC)	DVI
AV		X	X	X	O	O	X
S-Video		X	X	X	O	O	X
Component		X	X	X	O	O	X
PC1		O	O	O	X	X	O
PC2(BNC)		O	O	O	X	X	O
DVI		X	X	X	O	O	X

Listening to the Sound of the Sub Picture

While the PIP feature is activating, you can listen to the sound of the sub picture.

- 1 Press the **MENU** () button.
Result: The main menu is displayed.
- 2 Press the **▲** or **▼** button to select **Picture**.
Result: The **Picture** menu is displayed.
- 3 Press the **ENTER** () button.
- 4 Press the **▲** or **▼** button to select **PIP**.
Press the **ENTER** () button.
Result: The **PIP** is selected.
- 5 Press the **ENTER** () button.
To activate, set **PIP** to **On** by pressing the **▲** or **▼** button.
Press the **ENTER** () button.
- 6 Press the **▲** or **▼** button to select **Sound Select**.
Press the **ENTER** () button.
Result: You can listen to the sound of the sub picture.
➤ To listen the sound of the current main picture, set to **Main**.
- 7 Set to sub by pressing the **▲** or **▼** button.
Press the **ENTER** () button.

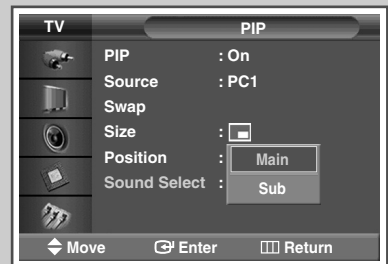
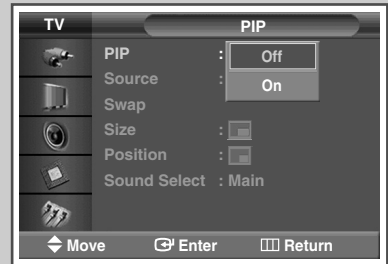
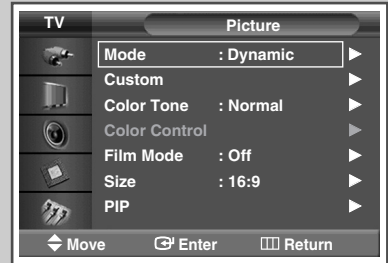

Viewing an External Signal Source

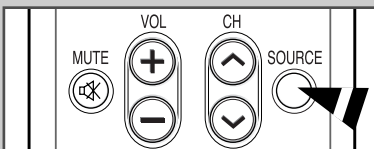
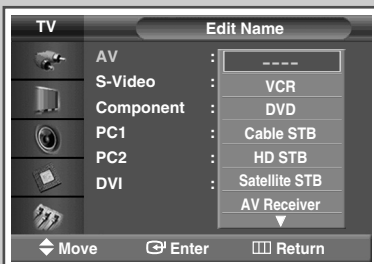
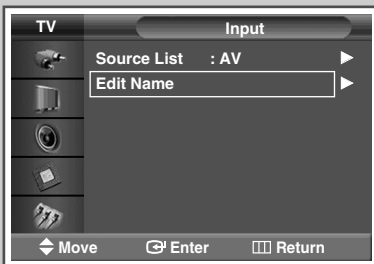
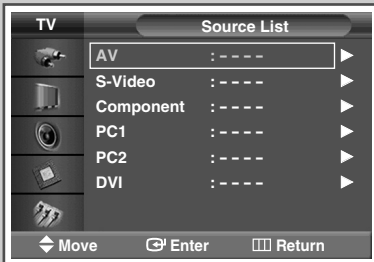
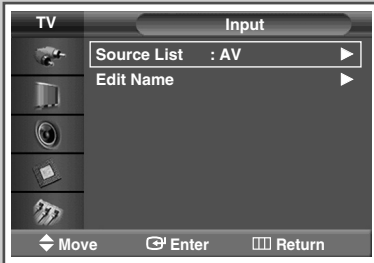

Once you have connected up your various audio and video systems, you can view different sources by selecting the appropriate input.

- 1 Press the **MENU** () button.
Result: The main menu is displayed.

- 2 Press the **▲** or **▼** button to select **Input**.
Result: The **Input** menu is displayed.

- 3 Press the **ENTER** () button.
Result: The **Source List** is selected.

- 4 Press the **ENTER** () button again.

- 5 Press the **▲** or **▼** button to select the signal source, press the **ENTER** () button.
Result: The available signal sources are listed.
➤ ◆ **AV, S-Video, Component, PC1, PC2, or DVI**
◆ You can also set these options simply by pressing the **SOURCE** () button on the remote control.

- 6 Repeat steps 1 to 3.
Result: The **Input** menu is displayed again.

- 7 Press the **▲** or **▼** button to select **Edit Name**. Press the **ENTER** () button.

- 8 Press the **▲** or **▼** button to select external source to be edited. Press the **ENTER** () button.
Result: The available device names are listed.
VCR, DVD, Cable STB, HD STB, Satellite STB, AV Receiver, DVD Receiver, Game, Camcorder, DVD Combo, DHR (DVD HDD Recorder), or PC

- 9 Select the required device by pressing the **▲** or **▼** button. Press the **ENTER** () button.

➤ If you change the external source while viewing, it might take a short period of time for picture to be switched.

Connecting to the Audio/Video Input

The "AV IN" connectors are used for the equipment with an Composite Video output, such as video game devices or video disc players.

Rear of the PDP Monitor (Input)

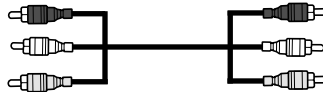
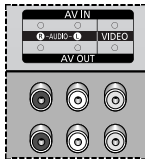

The "AV OUT" connectors are used for the equipment with an Composite Video input, such as a camcorder or VCR.

Rear of the PDP Monitor (Output)

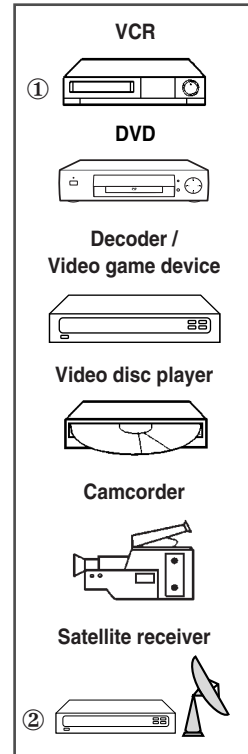
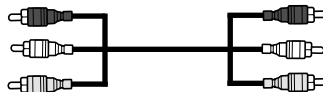
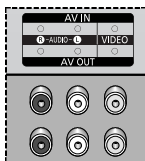

- ① If you have a second VCR and wish to copy cassettes tape, connect the source VCR to "AV IN" and the target VCR to "AV OUT" so that you can redirect the signal from "AV IN" to "AV OUT".
 - ② When you wish to record a programme, connect the receiver to "AV IN" and the VCR to "AV OUT" so that you can redirect the signal from "AV IN" to "AV OUT".
- Signal is outputted through the AV OUT only when the signal source is AV.

Whenever you connect an audio or video system to your PDP Monitor, ensure that all elements are switched off.

Refer to the documentation supplied with your equipment for detailed connection instructions and associated safety precautions.

Connecting to the S-Video Input

The S-VIDEO and RCA (AUDIO-L/R) connectors are used for equipment with an S-Video output, such as a camcorder or VCR.

Rear of the PDP Monitor

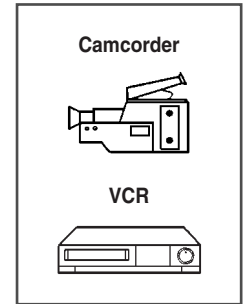
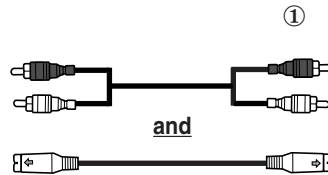
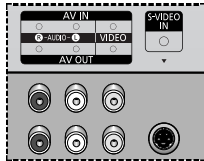

① To play picture and sound, both the S-VIDEO and RCA connectors must be used.

Connecting to the Component Input

Rear of the PDP Monitor

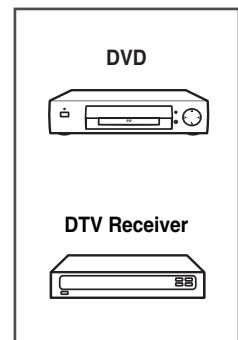
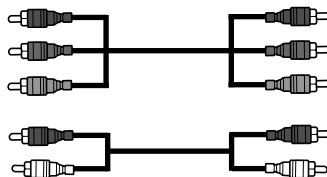
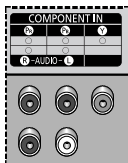

The **COMPONENT IN** connectors are used for DTV receiver or DVD.
(480i,p/576i,p/720p/1080i)

Connecting to the DVD/DTV Receiver Input

Rear of the PDP Monitor

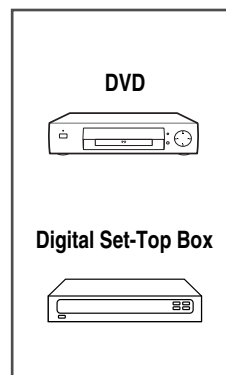
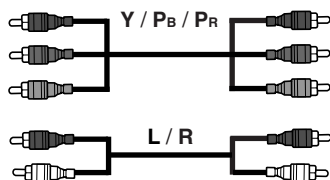
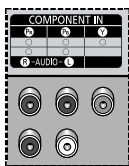

The "COMPONENT IN" (or "Y/P_B/P_R" (video) and "AUDIO") connectors are used for equipment with a DVD/DTV Receiver output. (480i, 576i, 480p, 576p, 720p, 1080i)

Connecting to the DVI Input

The “DVI IN” (video) and “AUDIO” connectors are used for equipment with a DVI output.

Rear of the PDP Monitor

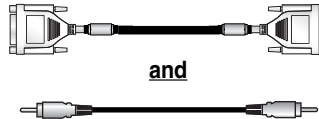
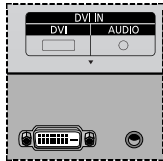

and

Personal Computer



Connecting to the PC Input

The “PC 1” (or “PC 2 (BNC IN)”) and “AUDIO” connectors are used for interfacing with your PC.

Rear of the PDP Monitor

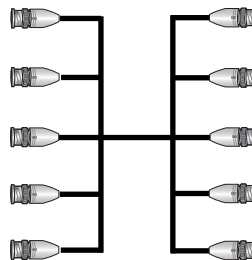
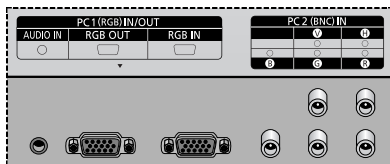

or

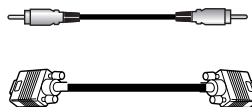

Personal Computer



Only when watching TV in **PC1** mode, you can use the **RGB OUT** port to connect the current screen to another PDP in the same mode.

Setting up Your PC Software (Windows only)

The Windows display-settings for a typical computer are shown below. But the actual screens on your PC will probably be different, depending upon your particular version of Windows and your particular video card. But even if your actual screens look different, the same, basic set-up information will apply in almost all cases. (If not, contact your computer manufacturer or Samsung Dealer.)



- 1 Right click the mouse on the Windows Desktop, then click on **Properties**. The **Display Properties** will be displayed.

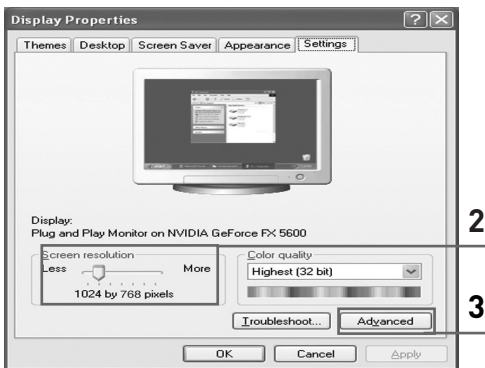

- 2 Click on **Settings** tab, then set the Display Mode with reference to the Display Modes Table. You do not need to change the Colours settings.
- 3 Click on **Advanced**. A new settings dialog box will be displayed.
- 4 Click on the **Monitor** tab, then set the **Screen refresh rate** with reference to the Display Modes Table. Set the Vertical Frequency and Horizontal Frequency individually if you can do so instead of setting the **Screen refresh rate**.
- 5 Click on **OK** to close the window, then Click on **OK** button to the **Display Properties** window. Automatic re-booting may commence at this moment.



- 6 Shutdown the PC, and connect it to your PDP Monitor. ("Connecting to the PC Input" on page 46)
- ♦ The actual screens on your PC may look different, depending on your particular version of Windows and the type of your PC.
 - ♦ When you use your PDP Monitor as a PC monitor, it supports Colours up to 32 bits.
 - ♦ In this case, the display on the PDP Monitor may look different depending on your particular version of Windows or the PC manufacturer.
 - ♦ When connecting a PC (including the DVI connection), you must set it to the display settings that are supported by the PDP Monitor. Otherwise, the message **Out of input range** will be displayed.

Input Mode (PC/DVI)

Both screen position and size will vary depending on the type of PC monitor and its resolution. The table below shows all of the display modes that are supported:

Resolution		Vertical frequency (Hz)	Horizontal frequency (kHz)	PPM42M5S	PPM42M5H	PPM50M5H	PPM63M5H
VGA	640 x 350	70	31.5	✓	✓	✓	✓
		85	37.9	✓	✓	✓	✓
	640 x 400	85	37.9	✓	✓	✓	✓
		720 x 400	70	31.5	✓	✓	✓
	640 x 480	85	37.9	✓	✓	✓	✓
		60	31.5	✓/☺	✓/☺	✓/☺	✓/☺
		72	37.9	✓	✓	✓	✓
		75	37.5	✓	✓	✓	✓
SVGA	800 x 600	85	43.3	✓	✓	✓	✓
		56	35.2	✓	✓	✓	✓
		60	37.9	✓/☺	✓/☺	✓/☺	✓/☺
		72	48.1	✓	✓	✓	✓
		75	46.9	✓	✓	✓	✓
XGA	1024 x 768	85	53.7	✓	✓	✓	✓
		60	48.4	✓/☺	✓	✓	✓
		70	56.5	✓	✓	✓	✓
		75	60.0	✓	✓/☺	✓/☺	✓/☺
WVGA	848 x 480	*85	68.7	✓	✓	✓	✓
		60	29.8	✓/☺	✓/☺	✓/☺	✓/☺
		72	35.1	✓	✓	✓	✓
		75	36.0	✓	✓	✓	✓
		*85	37.0	✓	✓	✓	✓
	*852 x 480	60	31.8	✓/☺			
	*1152 x 864	75	67.5	✓	✓	✓	✓
*SXGA	1280 x 1024	60	64.0	✓	✓/☺	✓/☺	✓/☺
		75	80.0		✓	✓	✓
WXGA	*1280 x 768	60	47.7	✓	✓	✓	✓
		75	60.1		✓	✓/☺	✓/☺
	1360 x 768	60	47.8			✓/☺	✓/☺
	*1366 x 768	60	48.2			✓/☺	✓/☺
*UXGA	1600 x 1200	60	75.0		✓	✓	✓

- ◆ “*” mode does not work with DVI mode.
- ◆ The interlace mode is not supported.
- ◆ The PDP might operate abnormally if a non-standard video format is selected.
- ◆ The **1366 x 768 / 852 x 480** mode is only supported by a particular video card (**PIXEL PERFECT** made by **IMAGINE GRAPHICS Ltd.**).
- ◆ In 1360 x 768 resolution, the screen displays 1360 pixels horizontally.
- ◆ A “✓” mark means that this mode can be supported.
- ◆ A “☺” mark means that this mode is recommended.

Power Saver (PC1 mode only)

This monitor has a built-in power management system called Power Saver. This power management system saves energy by switching your monitor into a low-power mode when it has not been used for a certain amount of time. You use a software utility installed on your computer to set up this feature. See the table below for details.

State	Normal Operation	Power-saving Function Mode	
		Suspend Mode Position A1	Power-off Mode Position A2
Horizontal Sync	Active	Active	Inactive
Vertical Sync	Active	Inactive	Inactive
Video	Active	Blanked	Blanked
Power Indicator	Green On	Green Blinking (3 sec Interval)	Green Blinking (3 sec Interval)

- ◆ If the horizontal sync is inactive and the vertical sync active, this monitor goes to the screen mute state.
- ◆ This monitor automatically returns to normal operation when horizontal and vertical sync return.
- ◆ This occurs when moving the computer's mouse or pressing a key on the keyboard.
- ◆ For energy conservation, turn your monitor OFF when it is not needed, or when leaving it unattended for long periods.

Troubleshooting: Before Contacting Service Personnel

Before contacting Samsung after-sales service, perform the following simple checks.

If you cannot solve the problem using the instructions below, note the model and serial number of the PDP Monitor and contact your local dealer.

No sound or picture	<ul style="list-style-type: none">◆ Check that the mains lead has been connected to a wall socket.◆ Check that you have pressed the ON or OFF button on the remote control.◆ Check the picture contrast and brightness settings.◆ Check the volume.
Normal picture but no sound	<ul style="list-style-type: none">◆ Check the volume.◆ Check whether the volume MUTE button on the remote control has been pressed.
No picture or black and white picture	<ul style="list-style-type: none">◆ Adjust the color settings.◆ Check that the video system selected is correct.
Sound and picture interference	<ul style="list-style-type: none">◆ Plug your PDP Monitor into a different mains socket.
Remote control malfunctions	<ul style="list-style-type: none">◆ Replace the remote control batteries.◆ Clean the upper edge of the remote control (transmission window).◆ Check the battery terminals.
Screen is black and power indicator light blinks steadily.	<ul style="list-style-type: none">◆ On your computer check: Power, Signal Cable. The TV is using its power management system. Move the computer's mouse or press any key on the keyboard.

Technical Specifications

Exterior design and product specifications are subject to change without prior notice to improve the performance of this product.

This is a class A product. In a domestic environment this product may cause radio interference in which case the user may be required to take adequate measures. (Class A product only)

Dimensions (W x D x H)	PPM42M5S/PPM42M5H – 1027 x 79 x 630.5 mm ; 40.43 x 3.11 x 24.82 inches PPM50M5H – 1204.6 x 79 x 724 mm ; 47.43 x 3.11 x 28.5 inches PPM63M5H – 1503.4 x 89 x 893.8 mm ; 59.19 x 3.5 x 35.19 inches
Weight (Without stand)	PPM42M5S/PPM42M5H – 34.5 kg PPM50M5H – 46.5 kg PPM63M5H – 69 kg
Screen aspect ratio	16:9
Screen size	PPM42M5S/PPM42M5H – 42 inch PPM50M5H – 50 inch PPM63M5H – 63 inch
Native pixel resolution (H x V)	PPM42M5S – 852 x 480 PPM42M5H – 1024 x 768 PPM50M5H/PPM63M5H – 1366 x 768
Color systems	PAL, SECAM, NTSC (NT3.58/NT4.43)
Sound	Stereo, Virtual Dolby
Audio output power	10W + 10W (8Ω)
Power supply	U.S.A/Canada – AC120V~, 60Hz Other countries – AC100-250V~, 50/60Hz
Power consumption	PPM42M5S – 330 Watts PPM42M5H – 380 Watts PPM50M5H – 490 Watts PPM63M5H – 630 Watts
Video inputs	VIDEO IN – AV/S-VIDEO COMPONENT IN – Y/Pb/Pr (RCA, 3P, 480i~1080i) RGB1(PC1) IN – D-SUB, 15P RGB2(PC2) IN VGA~XGA (R/G/B/H/V) DVI IN – DVI-D type
Monitor outputs	VIDEO OUT – VIDEO/L/R (RCA, 3P)
Audio inputs	VIDEO IN – L/R COMPONENT IN – L/R (RCA, 2P) AUDIO (Stereo jack for RGB1/2(PC1/2) and DVI input, 2 x mini jack)
Audio outputs	EXT SPEAKER (8Ω) - R+/-, L+/-
External control	RS232C – IN/OUT (D-SUB, 9P)

Dimension

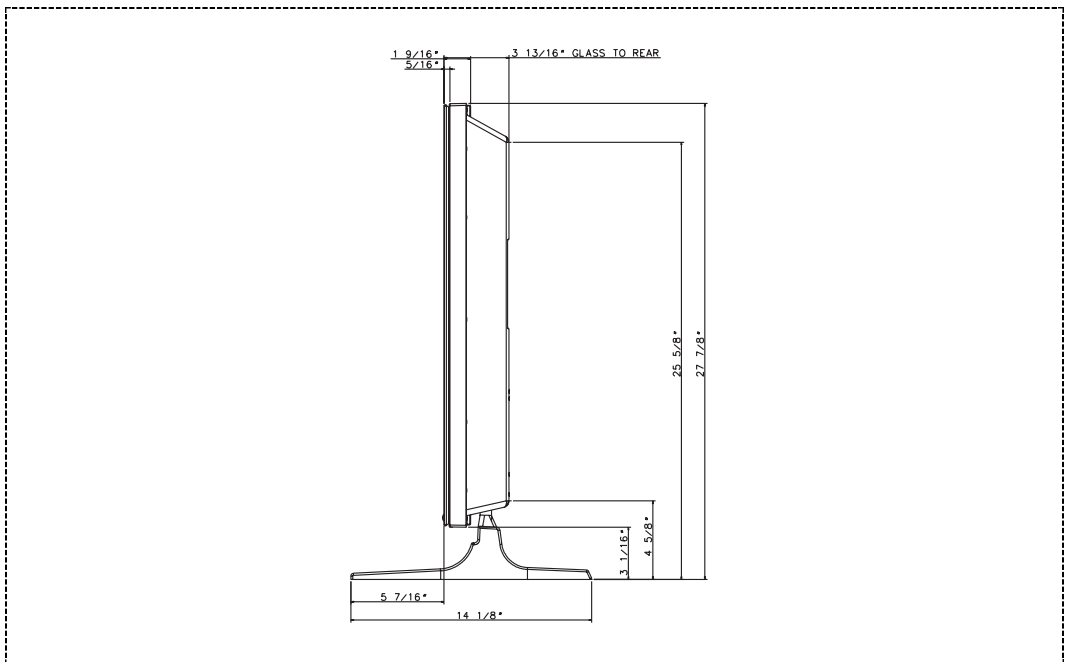
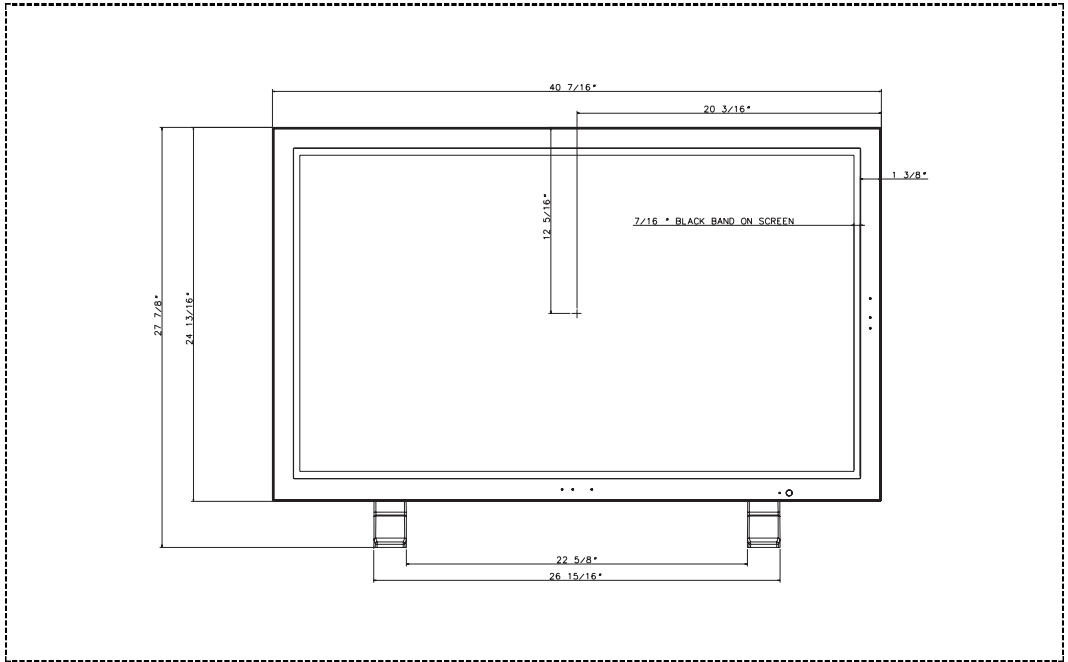

Dimension (continued)

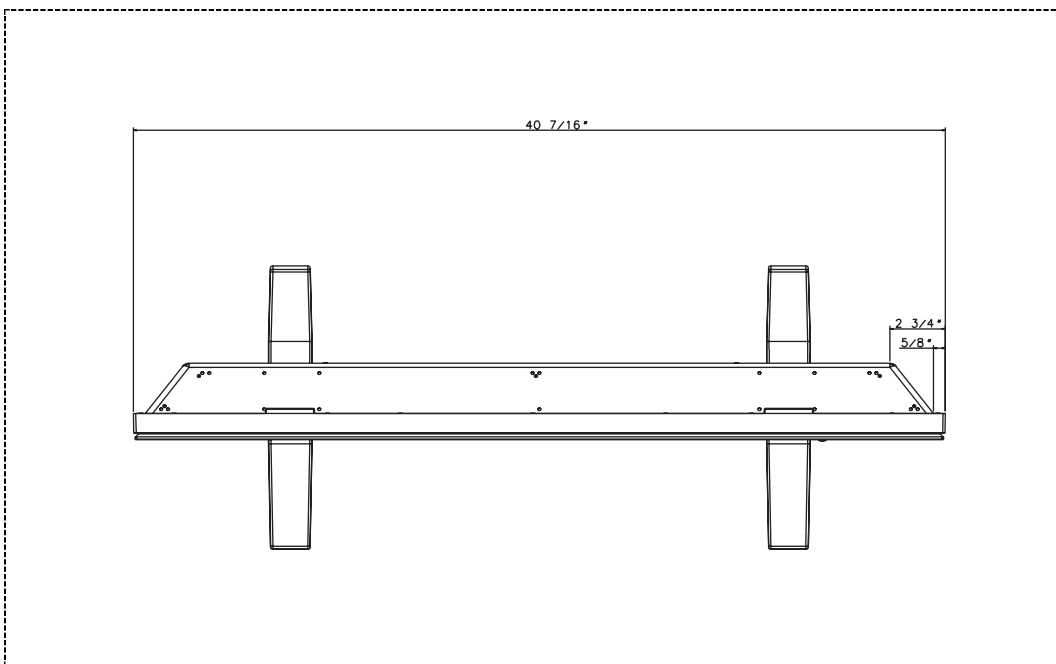
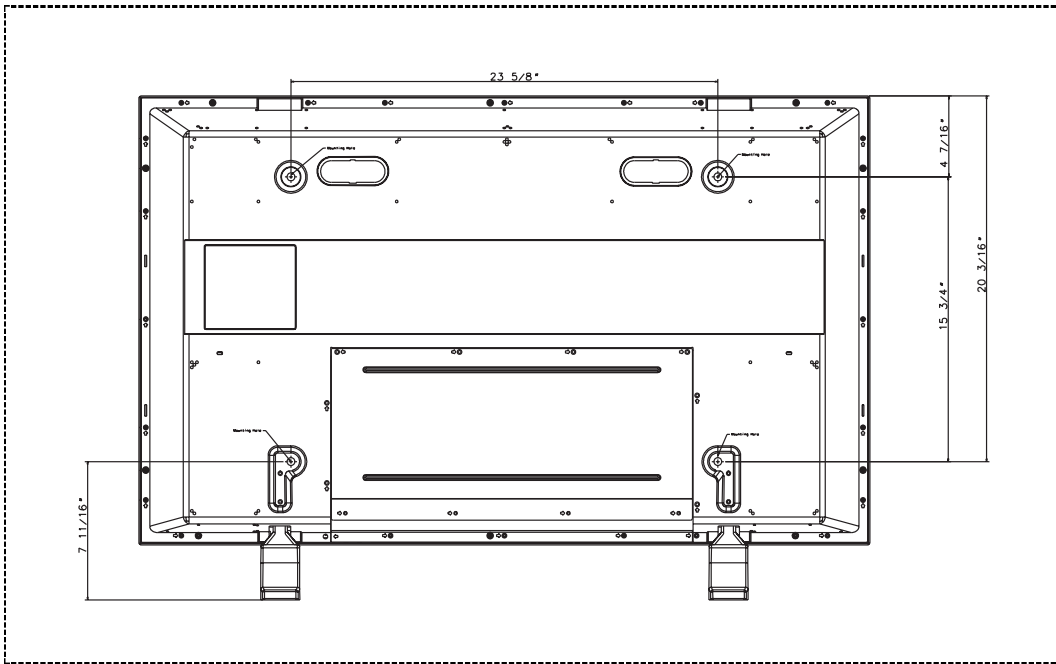

Memo

Memo

Memo

Memo

- AFTER SALES SERVICE

- Do not hesitate to contact your retailer or service agent if a change in the performance of your product indicates that a faulty condition may be present.

