

HAMEG

Instruments

MANUAL

Oscilloscope HM 204-2

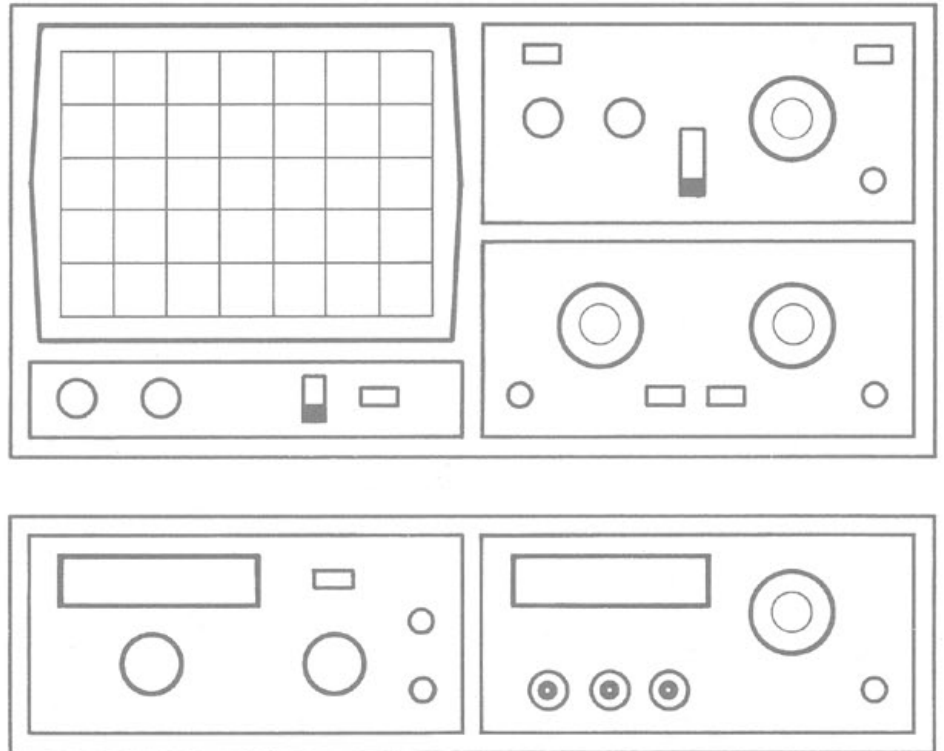

Technical Data	P 1
Accessories	Z 1
 Operating Instructions	
Use of tilt handle	M 1
Safety	M 1
Operating Conditions	M 1
Warranty	M 2
Mains/Line Voltage Change	M 2
Type of Signal	M 2
Amplitude Measurements	M 3
Time Measurements	M 4
Connection of Test Signal	M 5
Operating	M 6
First Time Operation	M 7
Trace Rotation	M 7
DC Balance Adjustment	M 7
Use and Compensation of Probe	M 8
Operating Modes of the Y-Amplifier	M 9
X-Y Operation	M10
X-Y Phase Measurements	M10
Dual-Trace Phase Difference Measurement	M10
Y Overscanning Measurements	M11
Triggering and Timebase	M11
Single Sweep Operation	M13
Sweep Delay	M14
Delay Mode Indication	M15
Component Tester	M15
Test Patterns	M19
 Short Instruction	K 1
 Front Panel Elements	
Folder with Front View	K 2
 Test Instructions	
General	T 1
Cathode Ray Tube: Brightness, Focus, Linearity, Raster Distortion	T 1
Astigmatism Check	T 1
Symmetry and Drift of the Vertical Amplifier	T 2
Calibration of the Vertical Amplifier	T 2
Transmission Performance of the Vertical Amplifier	T 2
Operating Modes: CHI/II, DUAL, ADD, CHOP., INV.I, X-Y Operation	T 2
Triggering Checks	T 3
Timebase	T 3
Sweep Delay	T 4
Component-Tester	T 4
Trace Alignment	T 5
Miscellaneous	T 5

Oscilloscope HM 204-2

 Service Instructions	
Instrument Case Removal	S 1
Operating Voltages	S 1
Maximum and Minimum Brightness	S 1
Astigmatism Control	S 2
Trigger Threshold	S 2
Trouble Shooting the Instrument	S 2
Replacement of Components and Parts	S 2
Replacement of the Power Transformer	S 3
Adjustments	S 3
 Circuit Diagrams	
Block Diagram	D 1
Identification of Electrical Components	D 2
Y-Input, Attenuator, Preamplifier, Component Locations Preamplifier	D 3
Y-Intermediate Amplifier, Channel Flip-Flop, Chopper Generator, Gates, Component Tester	D 4
Y-Board (Component Locations)	D 5
Y-Final Amplifier, Overscan Circuit, YF-Board (Component Locations)	D 6
Trigger Circuit, Delay Circuit	D 7
Timebase Circuit, Hold-Off Circuit, Trig. and X-Signal Amplifier, X-Final Amplifier	D 8
Timebase Board (Component Locations)	D 9
CRT-Circuit, Unblanking Circuit, Power Supply	D10
Calibrator, Z-Board, CRT-Board, TR-, Delay-, Cal.-Board (Component Locations)	D11
Adjusting Advices	D12
 Adjusting Plan	A 1

Specification

Operating Modes

Channel I, Channel II, Channel I and II alternate or chopped (chop frequency ≈ 0.5 MHz). sum or difference Ch.II \pm Ch.I (with Ch.I INV. button)
X-Y mode: same sensitivity in both directions.

Vertical Deflection (Y)

Bandwidth of both channels
 DC to 20 MHz (-3 dB), DC to 28 MHz (-6 dB).
 Risetime: ≈ 17.5 ns. Overshoot: max. 1%.
Deflection coefficients: 12 calibrated steps, 5 mV/cm to 20 V/cm in 1-2-5 sequence, with variable control 2.5:1 up to at least 50 V/cm. Accuracy in calibrated position: $\pm 3\%$.
Y-Magnification x5 calibrated to 1 mV/cm, bandwidth: DC to 5 MHz (-3 dB).
Input impedance: 1 M Ω || 30 pF.
 Input coupling: DC-AC-GND.
 Input voltage: max. 400V (DC + peak AC).
Y-Output from Ch.I or Ch.II: ≈ 45 mV/cm into 50 Ω .
 Y-Overscanning indication: with 2 LEDs.
Delay line: to view leading trigger edge.

Timebase

Time coefficients: 21 calibrated steps, 0.1 μ s/cm to 0.5 s/cm in 1-2-5 sequence, with variable control 2.5:1 to at least 1.25 s/cm, with **X-Magnification x10** ($\pm 5\%$) to 10 ns/cm. Accuracy in calibrated position: $\pm 3\%$.
Hold-off time: variable control 10:1.
 Ramp output: approx. 5V (on rear panel).
Trigger system: Automatic (peak-to-peak value) or Normal Trig. LED indication for trig. action.
Single sweep: Single-Reset buttons with LED ind. Slope: positive or negative.
 Sources: Ch. I, Ch. II, alternate Ch.I/II, line, external.
 Coupling: AC-DC-HF-LF (TV frame).
Threshold: internal 5mm, external 50mV.
 Bandwidth: DC to 50MHz.
Sweep delay: 7 decade steps, 100ns to 0.1 s, with variable fine control, approx. 10:1 to 1 s.
 Modes: Search, Delay. With LED indication.

Horizontal Deflection (X)

Bandwidth: DC to 2 MHz (-3 dB).
 Input: via Ch. II (see Y deflection spec.).
X-Y phase shift: $< 3^\circ$ up to 120 kHz.

Component Tester

Test voltage: max. 8.5V rms (open circuit).
Test current: max. 24 mA rms (shorted).
Test frequency: 50 or 60 Hz (line frequency).
 One test lead is grounded (Safety Earth).

General Information

Cathode-ray tube: D14-362 P43/93, P7/93 optional (long decay characteristic), rectangular screen, internal graticule 8x10 cm. Accelerating potential: 2000V.
 Graticule illumination: three-position switch.
 Trace rotation: adjustable on front panel.
 Z-Modulation input: positive TTL level = bright.
Calibrator: square-wave generator, ≈ 1 kHz/1 MHz switchable, risetime < 5 ns, for probe compensation, output voltages: 0.2V and 2V $\pm 1\%$.
Regulated DC power supplies: all voltages.
Protective system: Safety Class I (IEC 348).
 Line voltages: 110, 125, 220, 240V AC.
 Permissible line fluctuation: $\pm 10\%$.
 Line frequency range: 50 to 400 Hz.
Power consumption: approx. 41 Watts.
 Weight: approx. 7.7 kg. Color: techno-brown.
 Cabinet (mm): W 285, H 145, D 380.
 Lockable tilt handle.

Subject to change.

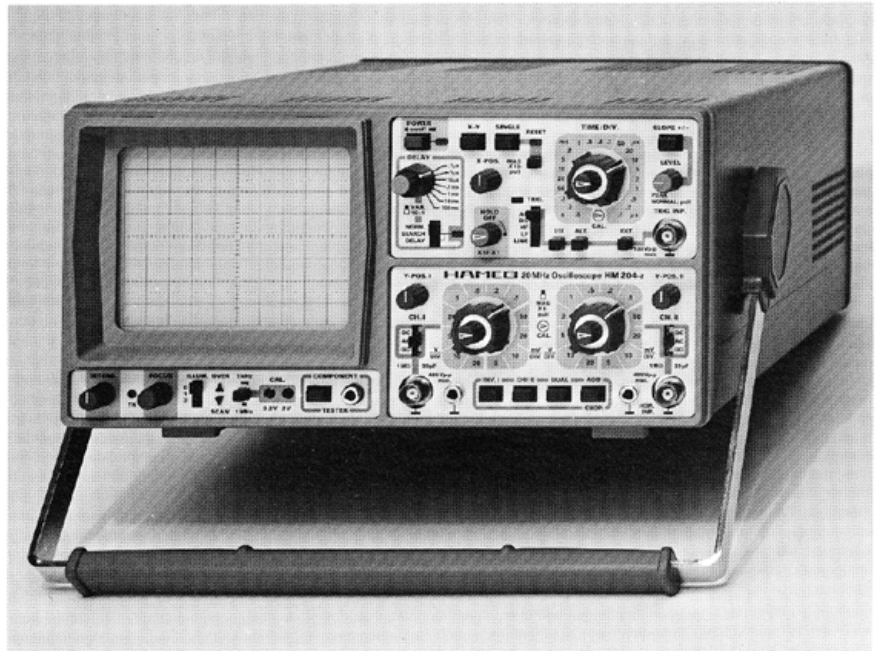

20 MHz Multifunction Oscilloscope

Y: 2 channels, DC-20MHz, max. 1 mV/cm, delay line;

X: 1.25s/cm - 10ns/cm incl. x10 magnification, delayed sweep; triggering up to 50MHz; var. hold-off time; Component Tester.

Particularly the **HM204** demonstrates the **high performance** standards and design philosophy found in **HAMEG's 20MHz-Oscilloscopes**.

The most outstanding features of this instrument are the maximum **time resolution** of up to **10ns/div.** (incl. 10x magnification) and the built-in **signal delay line** for viewing the trigger edge – features not found until now in this class and price range. Like instruments with a second timebase, the HM204's **variable sweep delay** enables detailed signal analysis by expanding any section of a waveform.

Other key features of this oscilloscope are normal and **peak-value triggering** up to **50MHz**, alternate trigger for display of two asynchronous signals, and single sweep operation. The **variable hold-off time** facilitates stable displays of complex and aperiodic waveforms.

A **Component Tester** for checking electronic components individually or in-circuit is also incorporated as an indispensable asset for troubleshooting. Yet another unique feature is the switchable **1kHz/1MHz calibrator** for checking transient response of scope and probes.

Despite its versatility, the HM204 has been specifically designed for durability and ease of operation. Operator comfort is increased by **LED indicators** for overscan, delay mode, single sweep, and trigger action. The overscan LEDs indicate if any part of a waveform passes the vertical screen limits. A fully shielded and burn-in resistant rectangular CRT with **illuminated internal graticule** and trace rotation underline the quality of this oscilloscope.

Accessories optional

Probes: 1X, 10X, 10X(HF), 100X, 1X/10X; demodulating probe; test cables BNC-BNC and banana-BNC; 50 Ω BNC termination; 4-Channel Amplifier; viewing hood; carrying case; etc.

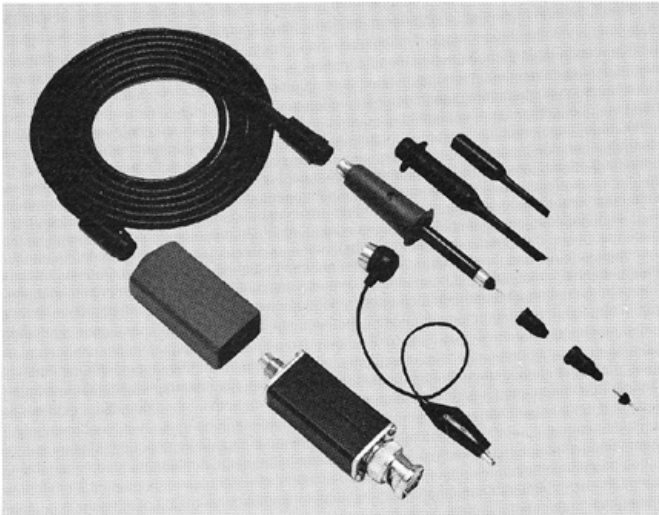

Modular Probes

The clear advantage over ordinary probes are field replaceable parts and the **HF-compensation feature** on the 10:1 attenuator probes. For the first time, probes in this price range allow adjustments of their HF-characteristics to match individually the input impedance of each scope. This is particularly important for scopes with higher bandwidths (>50MHz), as otherwise strong overshoot or rounding may occur, when measuring fast-rising square-waves. An exact HF-compensation, however, is only possible with square-wave generators having a risetime <5ns. The HM204-2, HM208 and HM605 already feature such a calibration generator. For other oscilloscopes, it is available as accessory item HZ60. At present the following Modular Probes are available:

Type	HZ50	HZ51	HZ52	HZ53	HZ54 selectable
Attenuation Ratio	1:1	10:1	10:1 (HF)	100:1	1:1 / 10:1
Bandwidth min. (MHz)	30	150	250	150	10 / 150
Risetime (ns)	11	<2	<1.4	<2	35 / <2
Inp. Capacitance (pF)	45	16	16	6.5	40 / 18
Inp. Resistance (MΩ)	1	10	10	100	1 / 10
Inp. Voltage max. (V _p)	600	600	600	1200	600
Cable Length (m)	1.2	1.2	1.5	1.5	1.2

Demodulator Probe

HZ55

Special probe for AM-demodulation and wobulator measurements. HF-Bandwidth 100kHz - 500MHz (±1dB). AC Input Voltage 250mV - 50V_{rms}. DC Isolation Voltage 200V DC including peak AC. Cable length 1.2m.

Conventional Probes

These popular standard probes are well suited for all oscilloscopes up to 50MHz bandwidth.

Type	HZ30	HZ35	HZ36 selectable
Attenuation Ratio	10:1	1:1	1:1 / 10:1
Bandwidth min. (MHz)	100	10	10 / 100
Risetime (ns)	3.5	35	35 / 3.5
Inp. Capacitance (pF)	13	47	47 / 13
Inp. Resistance (MΩ)	10	1	1 / 10
Inp. Voltage max. (V _p)	600	600	600
Cable Length (m)	1.5	1.5	1.5

Test Cable – 4mm Banana

HZ32

Coaxial test cable; length 1.15m, characteristic impedance 50Ω, cable capacitance 120pF. Input voltage max. 500V_p.

Test Cable BNC-BNC

HZ34

Coaxial test cable; length 1.2m, characteristic impedance 50Ω, cable capacitance 126pF. Input voltage max. 500V_p.

Adapter 4mm Banana to BNC

HZ20

Two 4mm binding posts (19mm between centers) to standard BNC male plus. Input voltage max. 500V_p.

50Ω Through-Termination

HZ22

For terminating systems with 50Ω characteristic impedance. Maximum load 2W. Max. voltage 10V_{rms}.

Carrying Cases

For HM203 and HM203-3	HZ42
For HM312, HM412, HM512, and HM705	HZ43
For HM307, HZ62, and HZ64	HZ44
For HM103	HZ45
For HM203-4, HM203-5, HM204, HM204-2 HM208 and HM605	HZ46

Viewing Hoods

HZ47

For HM203, HM204, HM208, HM605, HM705, HM808, HM312, HM412, HM512, and HM812

Scope Tester

HZ60

For checking the Y amplifier, timebase, and compensation of all probes, the HZ60 provides a crystal-controlled, fast-rising (typ. 3ns) square-wave generator with switchable frequencies of 1, 10, 100kHz, and 1MHz. Three BNC outputs provide signals of 25mV_{pp} into 50Ω, 0.25V_{pp} and 2.5V_{pp} (open circuit for 10X and 100X probes); accuracy ±1%. Battery-powered or AC supply operated (optional).

Component Tester

HZ65

Indispensable for trouble-shooting in electronic circuits. Single component and in-circuit tests are both possible. The HZ65 operates with all scopes, which can be switched to X-Y operation (ext. horizontal deflection). Non-destructive tests can be carried out on almost all semiconductors, resistors, capacitors, and coils. Two sockets provide for quick testing of the 3 junction areas in any small power transistor. Other components are connected by using 2 banana jacks. Test leads supplied.

Examples of Test Displays

Short circuit Capacitor 33μF Junction E-C Z-diode <8V



Operating Instructions

General information

The new HM204-2 is as easy to use as all HAMEG instruments. The logical arrangement of the controls and connectors on the front panel ensures that the user will quickly become familiar with the operation of the instrument. However, even experienced operators are advised to read the following instructions thoroughly, as they include important information relating to the use of the HM204-2.

Check that the instrument is set to the correct mains/line voltage. If not, refer to instructions on page M2.

Use of tilt handle

The handle of the oscilloscope can be fixed in four positions, two for use as a carrying handle and two positions as a tilt stand. With the tilt handle the instrument can be inclined 10° or 20° to the horizontal.

- Place the instrument on its rear feet (Position A). The front drop-in pins in the hinges will fall back into the front groove of the notched discs (fixed on the cabinet).
- Pull the handle only about 5 mm out of its locking position and turn it towards the lower edge of the front panel.
- Lock the handle into the required position by pushing it back towards the hinges.
- Place the instrument in its work area.

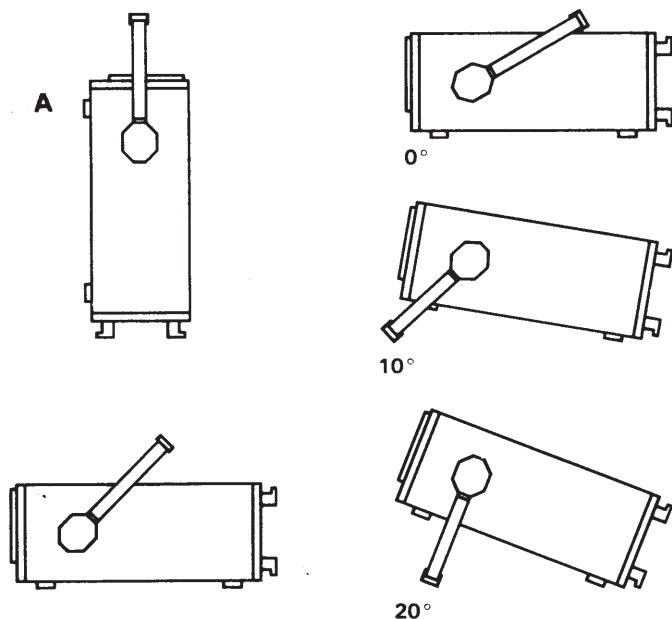

Safety

This instrument is designed and tested according to international safety standards (e.g. **IEC 348: Safety requirements for electric measuring apparatus**). The instrument has left the factory in perfect safety condition. To preserve this state and to ensure operation without danger, the user must observe all recommendations and warning remarks in these Operating, Test, and Service Instructions. **The case,**

chassis, and all measuring terminals are connected to the Safety Earth conductor. The specification of the instrument corresponds to **Safety Class I** (three-conductor AC power cable). The grounded accessible metal parts (case, sockets, jacks) and the power line circuit are tested against one another with 1500V 50Hz. Under certain conditions, 50Hz or 60Hz hum voltages can occur in the measuring circuit due to interconnection with other mains/line powered instruments or devices. This can be avoided by using a protective isolating transformer between the mains/line outlet and power plug of the instrument. Without an isolating transformer, the instrument's power cable must be plugged into an approved three-contact electrical outlet, which meets International Electrotechnical Commission (IEC) safety standards.

Warning!

Any interruption of the protective conductor inside or outside the instrument or disconnection of the protective earth terminal is likely to make the instrument dangerous. Intentional interruption is prohibited.

If a protective isolating transformer is used for the display of signals with high zero potential, it should be noted that these voltages are also connected to the oscilloscope's case and other accessible metal parts. Voltages up to 42 V are not dangerous. Higher voltages, however, involve a shock hazard. In this case, special safety measures must be taken and must be supervised by qualified personnel.

As with most electron tubes, the cathode-ray tube develops X-rays. With this instrument **the dose equivalent rate falls far below the maximum permissible value of 36 pA/kg.**

The instrument must be disconnected and secured against unintentional operation if there is any suggestion that safe operation is not possible. This may occur:

- if the instrument has visible damage,
- if the instrument has loose parts,
- if the instrument does not function,
- after long storage under unfavourable circumstances (e.g. out of doors or in moist environments),
- after excessive transportation stress (e.g. in poor packaging).

Operating Conditions

Admissible ambient temperature range during operation: $+10^\circ\text{C} \dots +40^\circ\text{C}$. Admissible ambient temperature range for storage or transportation: $-40^\circ\text{C} \dots +70^\circ\text{C}$. If condensed water exists in the instrument it should not be turned on before acclimatization is achieved. In some cases (an extremely cold oscilloscope) about two hours should be allowed before putting the instrument into operation. The instrument should be placed in a clean and dry room. In

other words, the instrument may not be put into operation in explosive, corrosive, dusty, or moist environments. The instrument may be operated in any position, however, the convection cooling must not be impaired. Therefore, when the instrument is in continuous operation it should be used in the horizontal position preferably on its tilt stand.

Warranty

Before being shipped each instrument must pass a 10 hour quality control test. Most failures can be detected by means of intermittent operation during this test. Nevertheless, a component may fail but only after a longer period of operation. Therefore, **all HAMEG instruments are under warranty for a period of two years**, provided that the instrument has not undergone any modifications. HAMEG will repair or replace products which prove to be defective during the warranty period. No other warranty is expressed or implied. HAMEG is not liable for consequential damages. It is recommended that the instrument be repackaged in the original manner for maximum protection. We regret that transportation damage due to poor packaging is not covered by this warranty.

In case of any complaint, attach a tag to the instrument with a description of the fault observed. Please supply name and department, address and telephone number to ensure rapid service.

Maintenance

Within the context of maintenance, it is recommended that the most important characteristics and criteria of this oscilloscope be periodically checked. The Test Instructions indicate only those tests, which can be performed without the use of expensive ancillary instruments. However, we recommend the procurement of the new HAMEG Scope-Tester HZ60. Despite its fairly low price the HZ60 fulfills all these tasks excellently.

Mains/Line Voltage Change

On delivery, the instrument is set to AC 220V \pm 10% (50-400 Hz) mains/line voltage.

The instrument has an appliance inlet at the rear. This device contains the power fuse, which is interchangeable for the different mains/line voltages. The fuse holder with its square top plate can be pulled out by means of a small screwdriver (after disconnection of the power cord from the plug-in unit), and **changing of the power voltage** is possible by turning this plate 90 degrees for each of the four power voltages marked on the plate (see triangle **above** the fuse holder). The fuse holder should then be plugged in again in the desired position, which should be **the closest value of the measured mains/line voltage in your area**.

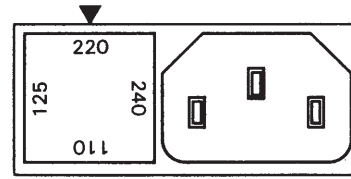

Required power fuse-link:

5x20 mm, time lag (slow-blow), **250V~**, **C**, to IEC 127/III; DIN 41662.

Mains/line voltage	Rated current
110V~ \pm 10%	T 0.63 A
125V~ \pm 10%	T 0.63 A
220V~ \pm 10%	T 0.315A
240V~ \pm 10%	T 0.315A

The power fuse has to match the set mains/line voltage and must be changed if necessary. It should be checked that only fuses of the specified type and current are used in this case. Patched fuses or short circuit of the fuse holder must not be used as an alternative.

Type of Signal

All types of signals with a frequency spectrum below 20MHz can be displayed on the HM204-2. The display of simple electrical processes such as sinusoidal RF and AF signals or ripple poses no problems. However, when square or pulse-shaped signals are displayed it must be remembered that their **harmonic content** must also be transmitted. In this case, the bandwidth of the vertical amplifier must be considerably higher than the repetition frequency of the signal. In view of this, accurate evaluation of such signals with the HM204-2 is only possible up to a maximum repetition rate of 2 MHz. Operating problems can sometimes occur when composite signals are to be displayed, especially if they do not contain any suitable level components and repetition frequency which can be used for triggering. This occurs, for example, with burst signals. To obtain a stably triggered display in these cases, it may be necessary to use Normal Triggering, **HOLD OFF** time control, and/or **TIME/DIV.** variable control. **Television video signals are relatively easy to trigger.** However, when investigating signals at frame rate, the **TRIG.** selector slide switch has to be set in **LF** position (low-pass filter). In this mode, the more rapid line pulses are attenuated so that, with appropriate level adjustment, triggering can easily be carried out on the leading or trailing edge of the frame synchronizing pulse.

For optional operation as a DC or AC voltage amplifier, each channel is provided with a **DC-AC** coupling switch. The **DC** position should only be used with an attenuator probe or at very low frequencies or if the determination of DC voltage content of the signal is absolutely necessary.

However, when investigating very low-frequency pulses, misleading ramp-offs may occur with **AC** coupling. In this case, **DC** operation is to be preferred if the signal voltage is not superimposed on a too high DC voltage level. Otherwise, a capacitor of adequate capacitance must be connected before the input of the vertical amplifier (switched to **DC** coupling). It should be remembered that this capacitor must have a sufficiently high breakdown voltage. **DC** operation is also recommended for the display of logic and pulse signals, particularly if their pulse duty factor changes permanently during operation. Otherwise, the display will move up and down with any change. DC voltages can only be measured in the **DC** position.

Amplitude Measurements

In general electrical engineering, alternating voltage data normally refers to effective values (rms = root-mean-square value). However, for signal magnitudes and voltage designations in oscilloscope measurements, the peak-to-peak voltage (V_{pp}) value is applied. The latter corresponds to the real potential difference between the most positive and most negative points of a signal waveform.

If a sinusoidal waveform, displayed on the oscilloscope screen, is to be converted into an effective (rms) value, the resulting peak-to-peak value must be divided by $2 \times \sqrt{2} = 2.83$. Conversely, it should be observed that sinusoidal voltages indicated in V_{rms} (V_{eff}) have 2.83 times the potential difference in V_{pp} . The relationship between the different voltage magnitudes can be seen from the following figure.

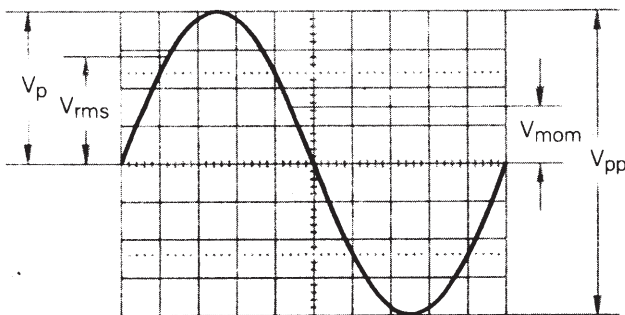

Voltage values of a sine curve

V_{rms} = effective value; V_p = simple peak or crest value;
 V_{pp} = peak-to-peak value; V_{mom} = momentary value.

The minimum signal voltage required at the vertical amplifier input for a display of 1 cm is approximately **1 mV_{pp}**. This is achieved with the attenuator control set at **5 mV/cm**, its **variable control in the fully clockwise position and pulled out**. However, smaller signals than this may also be displayed. The **deflection coefficients** on the input attenuators are indicated in **mV/cm** or **V/cm** (peak-to-peak value).

The magnitude of the applied voltage is ascertained by multiplying the selected deflection coefficient by the vertical display height in cm.

If an attenuator probe X10 is used, a further multiplication by a factor of 10 is required to ascertain the correct voltage value.

For exact amplitude measurements the variable control on the attenuator switch must be set to its calibrated detent CAL. When turning the variable control ccw the sensitivity will be decreased by a factor of 2.5.

Therefore every intermediate value is possible within the 1-2-5 sequence.

With direct connection to the vertical input, **signals up to 400 V_{pp}** may be displayed (attenuator set to **20 V/cm**, variable control ccw).

When pulling the variable control knob (**MAG x5**), the sensitivity is increased by a factor of 5. Hence follows a min. deflection coefficient of **1 mV/cm**.

With the designations

H = display height in cm,

U = signal voltage in V_{pp} at the vertical input,

D = deflection coefficient in **V/cm** at attenuator switch, the required quantity can be calculated from the two given quantities:

$$U = D \cdot H$$

$$H = \frac{U}{D}$$

$$D = \frac{U}{H}$$

However, these three values are not freely selectable. They have to be within the following limits (trigger threshold, accuracy of reading):

H between 0.5 and 8 cm, if possible 3.2 to 8 cm,

U between 1 mV_{pp} and 160 V_{pp}.

D between 5 mV/cm and 20 V/cm in 1-2-5 sequence.

D between 1 mV/cm and 4 V/cm in 1-2-5 sequence (**with pulled MAG X5 knob**).

Examples:

Set deflection coefficient **D** = 50 mV/cm \triangleq 0.05 V/cm, observed display height **H** = 4.6 cm, **required voltage U** = 0.05 · 4.6 = **0.23 V_{pp}**.

Input voltage **U** = 5 V_{pp},

set deflection coefficient **D** = 1 V/cm,

required display height H = 5 : 1 = **5 cm**

Signal voltage **U** = 220 V_{rms} · 2 · $\sqrt{2}$ = 622 V_{pp}

(voltage > 160 V_{pp}, with probe X10 : **U** = 62.2 V_{pp}),

desired display height **H** = min. 3.2 cm, max. 8 cm,

max. deflection coefficient **D** = 62.2 : 3.2 = 19.4 V/cm,

min. deflection coefficient **D** = 62.2 : 8 = 7.8 V/cm,

adjusted deflection coefficient D = **10 V/cm**

If the applied signal is superimposed on a DC (direct voltage) level the total value (DC + peak value of the alternating voltage) of the signal across the Y-input must not exceed $\pm 400V$ (see figure). This same limit applies to normal X10 attenuator probes, the attenuation ratio of which allows signal voltages up to approximately 1,000V_{pp} to be evaluated. Voltages of up to approximately 2,400V_{pp} may be measured by using the HZ53 high voltage probe which has an attenuation ratio of 100:1. It should be noted that its V_{rms} value is derated at higher frequencies. If a normal X10 probe is used to measure high voltages there is the risk that the compensation trimmer bridging the attenuator series resistor will break down causing damage to the input of the oscilloscope. However, if for example only the residual ripple of a high voltage is to be displayed on the oscilloscope, a normal X10 probe is sufficient. In this case, an appropriate high voltage capacitor (approx. 22-68nF) must be connected in series with the input tip of the probe.

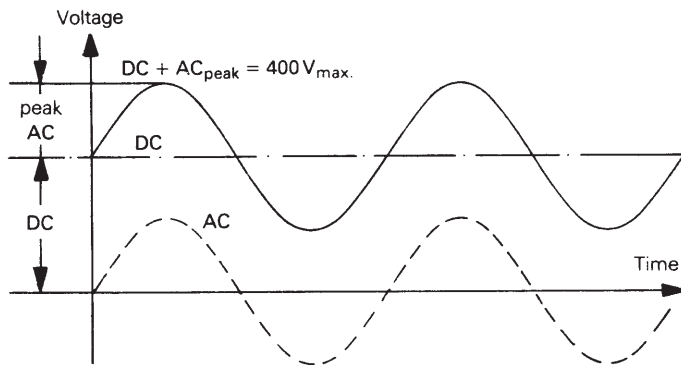

Total value of input voltage

The dotted line shows a voltage alternating at zero volt level. When superimposed a DC level, the addition of the positive peak on the DC voltage results in the max. voltage (DC + AC_{peak}).

It is very important that the oscilloscope input coupling is set to **DC**, if an attenuator probe is used for voltages higher than 400V (see page M5: Connection of Test Signal).

Time Measurements

As a rule, all signals to be displayed are periodically repeating processes and can also be designated as periods. The number of periods per second is the recurrence frequency or repetition rate. One or more signal periods or even part of a period may be shown as a function of the adjustment of the **TIME/DIV.** switch. The time coefficients on the **TIME/DIV.** switch are indicated in **s/cm**, **ms/cm**, and **μs/cm**. Accordingly, the dial is subdivided into three sectors. **The duration of a signal period or a portion of the waveform is ascertained by multiplying the relevant time (horizontal distance in cm) by the time coefficient selected on the TIME/DIV. switch. The time variable control (small knob on the TIME/DIV. switch) must be in its calibrated detent CAL. for accurate measurement** (arrow horizontal and pointing to the right).

With the designations

L = displayed wave length in cm of one period,

T = time in seconds for one period,

F = recurrence frequency in Hz of the signal,

T_c = time coefficient in s/cm on timebase switch

and the relation **F = 1/T**, the following equations can be stated:

$$\begin{aligned} T &= L \cdot T_c & L &= \frac{T}{T_c} & T_c &= \frac{T}{L} \\ F &= \frac{1}{L \cdot T_c} & L &= \frac{1}{F \cdot T_c} & T_c &= \frac{1}{L \cdot F} \end{aligned}$$

With X-Pos. knob pulled (MAG. X10) the T_c value must be divided by 10.

However, these four values are not freely selectable. They have to be within the following limits:

L between 0.2 and 10 cm, if possible 4 to 10 cm,

T between 5 ns and 5 s,

F between 0.2 Hz and 20 MHz,

T_c between 100 ns/cm and 0,5 s/cm in 1-2-5 sequence (with **MAG. X10** pushed in out position), and

T_c between 10 ns/cm and 50 ms/cm in 1-2-5 sequence (with pulled **MAG. X10** knob).

Examples:

Displayed wavelength **L** = 7 cm,

set time coefficient **T_c** = 0.5 μs/cm,

required period T = 7 · 0.5 · 10⁻⁶ = **3.5 μs**

required rec. freq. F = 1 : (3.5 · 10⁻⁶) = **286 kHz**.

Signal period **T** = 0.5 s,

set time coefficient **T_c** = 0.2 s/cm,

required wavelength L = 0.5 : 0.2 = **2.5 cm**.

Displayed ripple wavelength **L** = 1 cm,

set time coefficient **T_c** = 10 ms/cm,

required ripple freq. F = 1 : (1 · 10 · 10⁻³) = **100 Hz**.

TV-line frequency **F** = 15 625 Hz,

set time coefficient **T_c** = 10 μs/cm,

required wavelength L = 1 : (15 625 · 10⁻⁵) = **6.4 cm**.

Sine wavelength **L** = min. 4 cm, max. 10 cm,

Frequency **F** = 1 kHz,

max. time coefficient **T_c** = 1 : (4 · 10³) = 0.25 ms/cm,

min. time coefficient **T_c** = 1 : (10 · 10³) = 0.1 ms/cm,

set time coefficient T_c = **0.2 ms/cm**,

required wavelength L = 1 : (10³ · 0,2 · 10⁻³) = **5 cm**.

Displayed wavelength **L** = 0.8 cm,

set time coefficient **T_c** = 0.5 μs/cm,

pressed MAG X10 button: T_c = 0.05 μs/cm,

required rec. freq. F = 1 : (0.8 · 0.05 · 10⁻⁶) = **25 MHz**,

required period T = 1 : (25 · 10⁶) = **40 ns**.

If the time is relatively short as compared with the complete signal period, an expanded time scale should always be applied (**MAG X10** knob pulled). In this case, the ascertained time values have to be divided by **10**. Very small time intervals at optional points of the signal can be measured more exactly with the aid of the sweep delay. With it, the display and measurement of time intervals, which are smaller than 1% of the full signal period, are possible. The smallest measurable time interval is, on the whole, dependent on the obtainable brightness of the CRT. The limit is an expansion of approximately 200 times. Using a Viewing Hood HZ47, more expansion is possible, provided that the time coefficient set on the **TIME/DIV.** switch is greater than **2µs/cm** (and using the **MAG X10** facility) for the signal's basic period. Otherwise, the fastest sweep speed determines the greatest possible expansion.

When investigating pulse or square waveforms, the critical feature is the **risetime of the voltage step**. To ensure that transients, ramp-offs, and bandwidth limits do not unduly influence the measuring accuracy, the risetime is generally measured between **10%** and **90%** of the vertical pulse height. For peak-to-peak signal amplitude of **5cm** height, which are symmetrically adjusted to the horizontal center line, the internal graticule of the CRT has two horizontal dotted lines $\pm 2.5\text{cm}$ from the center line. Adjust the Y attenuator switch with its variable control together with the **Y-POS.** control so that the pulse height is precisely aligned with these 0 and 100% lines. The 10% and 90% points of the signal will now coincide with the two lines, which have a distance of $\pm 2\text{cm}$ from the horizontal center line and an additional subdivision of 0.2cm. **The risetime is given by the product of the horizontal distance in cm between these two coincidence points and the time coefficient setting.** If magnification is used, this product must be divided by 10. The **fall time** of a pulse can also be measured by using this method.

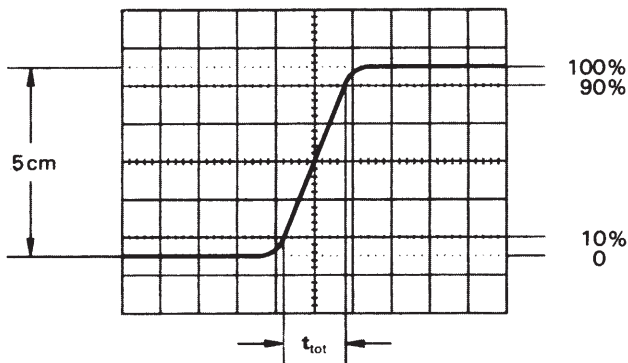

The following figure shows correct positioning of the oscilloscope trace for accurate risetime measurement.

With a time coefficient of $0.2\mu\text{s/cm}$ and pulled **MAG X10** knob the example shown in the above figure results in a measured total risetime of

$$t_{\text{tot}} = 1.6\text{cm} \cdot 0.2\mu\text{s/cm} : 10 = \mathbf{32\text{ns}}$$

When very fast risetimes are being measured, the risetime of the oscilloscope amplifier and the attenuator probe has to be deducted from the measured time value. The risetime of the signal can be calculated using the following formula.

$$t_r = \sqrt{t_{\text{tot}}^2 - t_{\text{osc}}^2 - t_p^2}$$

In this t_{tot} is the total measured risetime, t_{osc} is the risetime of the oscilloscope amplifier (approx. 17.5ns), and t_p the risetime of the probe (e.g. = 2ns). If t_{tot} is greater than 100ns, then t_{tot} can be taken as the risetime of the pulse, and calculation is unnecessary.

Calculation of the example in the figure above results in a signal risetime

$$t_r = \sqrt{32^2 - 17.5^2 - 2^2} = \mathbf{26.7\text{ns}}$$

Connection of Test Signal

Caution: When connecting unknown signals to the oscilloscope input, always use automatic triggering and set the **DC-AC** input coupling switch to **AC**. The attenuator switch should initially be set to **20V/cm**. Pay attention to the Y overscanning indication (see paragraph "Y Overscanning Indication").

Sometimes the trace will disappear after an input signal has been applied. The attenuator switch must then be turned back to the left, until the vertical signal height is only 3-8cm. With a signal amplitude greater than $160V_{pp}$, an attenuator probe must be inserted before the oscilloscope's vertical input. If, after applying the signal, the trace is nearly blanked, the period of the signal is probably substantially longer than the set value on the **TIME/DIV.** switch. It should be turned to the left to an adequately greater time coefficient.

The signal to be displayed should be fed to the vertical input of the oscilloscope by means of a shielded test cable, e.g. the HZ32 or HZ34, or by a X10 or X100 attenuator probe. The use of these shielded cables with high impedance circuits is only recommended for relatively low frequencies (up to approx. 50kHz). For higher frequencies, and when the signal source is of low impedance, a cable of matched characteristic impedance (usually 50Ω) is recommended. In addition, and especially when investigating square or pulse waveforms, a resistor equivalent to the characteristic impedance of the cable must also be connected to the cable directly at the input of the oscilloscope. When using a 50Ω cable, such as the HZ34, a 50Ω through-termination type HZ22 is available from HAMEG. When investigating square or pulse waveforms with fast risetimes, transient phenomena on both the edge and top of the signal may become visible if the correct termination is not used. It must be remembered that the 50Ω through-termination will only

dissipate a maximum of 2 watts. This power consumption is reached with $10V_{rms}$ or with $28V_{pp}$ sine signal.

If a X10 attenuator probe (e.g. HZ51) is used, no termination is necessary. In this case, the connecting cable is matched directly to the high impedance input of the oscilloscope. When using attenuator probes even high internal impedance sources are only slightly loaded (by approximately $10M\Omega || 16pF$). Therefore, when the voltage loss due to the attenuation of the probe can be compensated by a higher sensitivity setting on the HM204-2, the probe should always be used. Also it should be remembered that the series impedance of the probe provides a certain amount of protection for the input of the oscilloscope amplifier. It should be noted that all attenuator probes must be compensated in conjunction with the oscilloscope (see: Probe Adjustment, page M8).

If a X10 or X100 attenuator probe is used, the DC input coupling must always be set. With **AC** coupling, the attenuation is frequency-dependent, the pulses displayed can exhibit ramp-off, DC-voltage contents are suppressed – but loads the respective input coupling capacitor of the oscilloscope. The electric strength of which is maximum 400V (DC + peak AC). For the suppression of unwanted DC voltages, a **capacitor** of adequate capacitance and electric strength **may be connected before the input tip of the probe** (e.g. for ripple measurements).

With the HZ53 X100 probe the permissible AC input voltage is frequency-dependent limited:

below 20kHz (TV line frequency!) up to

$$\text{max. } 1200 V_p \triangleq 2400 V_{pp} \triangleq 850 V_{rms};$$

above 20kHz (with f in MHz) up to

$$\frac{212}{\sqrt{f}} V_p \triangleq \frac{424}{\sqrt{f}} V_{pp} \triangleq \frac{150}{\sqrt{f}} V_{rms}.$$

It is important to remember that when low voltage signals are being investigated the position of the ground point on the test circuit can be critical. This ground point should always be located as close as possible to the measuring point. If this is not done, serious signal deformation may result from any spurious currents through the ground leads or test chassis parts. This comment also applies to the ground leads on attenuator probes which ideally should be as short and as thick as possible. For connection of a probe to a BNC socket, a BNC-adaptor should be used. It forms often a part of the probe accessory. Grounding and matching problems are then eliminated.

Hum or interference voltage appearing in the measuring circuit (especially with a small deflection coefficient) is possibly caused by multiple grounding, because equalizing currents can flow in the shielding of the measuring cables (voltage drop between non-fused earthed conductors of other line powered devices, which are connected to the oscilloscope or test object, e.g. signal generators with anti-interference capacitors).

Operating

For a better understanding of these Operating Instructions the front panel picture at the end of these instructions can be unfolded for reference alongside the text.

The front panel is subdivided into three sections according to the various functions. The **INTENS.**, **FOCUS** and **TR** (trace rotation) controls are arranged on the left directly below the screen of the cathode-ray tube (CRT). Following next a slide switch for the graticule illumination (**ILLUM.**), two LEDs for **OVERSCAN** indication, switch for calibrator frequency selection (**1kHz/1MHz**) and calibrator output sockets 0.2V/2V (**CAL.**). The **COMPONENT TESTER** pushbutton and its measuring socket are located on the right side.

The X-Section, located on the upper right, next to the screen, contains the red **POWER** pushbutton and indicating lamp, all controls for timebase (**TIME/DIV.**), triggering (**TRIG.**), horizontal trace position (**X-POS.**), and sweep delay (**DELAY**).

The lower Y-Section contains the controls for the vertical deflection system. On the right and left in this section are located: vertical input connector, **DC-AC-GD** input coupling slide switch, **Y-POS.** control, attenuator switch with variable control, and ground jack. All these controls and connectors exist in duplicate for each of the Channels I and II. Four pushbuttons for selecting the operating mode are arranged below the attenuator switches: **INV. I**, **CHI/II**, **DUAL**, **ADD/CHOP**.

The instrument is so designed that even incorrect operation will not cause serious damage. The pushbuttons control only minor functions, and it is recommended that before commencement of operation all pushbuttons are in the "out" position. After this the pushbuttons can be operated depending upon the mode of operation required.

The HM204-2 accepts all signals from DC (direct voltage) up to a frequency of at least 20 MHz (-3dB). For sine wave voltages the upper frequency limit will be 30-35 MHz. However, in this higher frequency range the vertical display height on the screen is limited to approx. 4-5cm. The time resolution poses no problem. For example, with 25MHz and the fastest adjustable sweep rate (10ns/cm), one cycle will be displayed every 4cm. The tolerance on indicated values amounts to $\pm 3\%$ in both deflection directions. All values to be measured can therefore be determined relatively accurately. However, from approximately 6MHz upwards the measuring error will increase as a result of loss of gain. At 12MHz this reduction is about 10%. Thus, approximately 11% should be added to the measured voltage at this frequency. As the bandwidth of the amplifiers differ (normally between 20 and 25 MHz), the measured values in

the upper limit range cannot be defined exactly. Additionally, as already mentioned, for frequencies above 20MHz the dynamic range of the display height steadily decreases. The vertical amplifier is designed so that the transmission performance is not affected by its own overshoot.

First Time Operation

Check that the instrument is set to the correct mains/line voltage. (Refer to page M2).

Before applying power to the oscilloscope it is recommended that the following simple procedures are performed:

- Check that all pushbuttons are in the **out** position, i.e. released.
- Rotate the four variable controls with arrows, i.e. **TIME/DIV.** variable control, **HOLD-OFF**, **CH.I** and **CH.II** attenuator variable controls, fully clockwise to their calibrated detent.
- Set the variable controls with marker lines to their mid-range position (marker lines pointing vertically).
- The **LEVEL** control knob (push-pull operated) should be depressed for **PEAK** mode.
- Both slide switches in the X-Section should be set to their uppermost position.
- Both input coupling slide switches for **CH.I** and **CH.II** in the Y-Section should be set to the **GD** position.

Switch on the oscilloscope by depressing the red **POWER** pushbutton. An LED will illuminate to indicate working order. The trace, displaying one baseline, should be visible after a short warm-up period of 10 seconds. Adjust **Y-POS.I** and **X-POS.** controls to center the baseline. Adjust **INTENS.** (intensity) and **FOCUS** controls for medium brightness and optimum sharpness of the trace. The oscilloscope is now ready for use.

If only a spot appears (**CAUTION!** CRT phosphor can be damaged.), reduce the intensity immediately and check that the **X-Y** pushbutton is in the released (out) position. If the trace is not visible, check the correct positions of all knobs and switches (particularly **LEVEL** knob depressed and **DELAY MODE** slide switch to **NORM.**).

To obtain the maximum life from the cathode-ray tube, the minimum intensity setting necessary for the measurement in hand and the ambient light conditions should be used.

Particular care is required when a single spot is displayed, as a very high intensity setting may cause damage to the fluorescent screen of the CRT. Switching the oscilloscope off and on at short intervals stresses the cathode of the CRT and should therefore be avoided.

Trace Rotation TR

In spite of Mumetal-shielding of the CRT, effects of the earth's magnetic field on the horizontal trace position cannot be completely avoided. This is dependent upon the orientation of the oscilloscope on the place of work. A centred trace may not align exactly with the horizontal center line of the graticule. A few degrees of misalignment can be corrected by a potentiometer accessible through an opening on the front panel marked TR.

DC Balance Adjustment

The vertical preamplifiers for **CH.I** and **CH.II** contain matched dual FETs connected as input source followers. After long periods of use the FET characteristics may change which can alter the DC balance of the vertical amplifier.

A quick check of DC Balance can be made on each channel by pulling the fine amplitude control **MAG x5** and pushing it back. If the trace moves from the vertical position (up or down) more than 1 mm, the DC Balance will require readjustment. This check should be made after a 20-minute warm-up period.

Adjustment procedure

The following instructions should be performed to obtain the correct DC balance adjustment of both channels.

- Remove all input cables and adjust oscilloscope controls to display the baseline.
- Center the baseline using **Y-POS.** and **X-POS.** controls.
- Set attenuator switches to **5 mV/cm** and input coupling switches to **GD**.
- Release all pushbuttons in the Y-Section.
- Place the oscilloscope so that it rests firmly on its back (upright position) and locate DC balance adjustment potentiometer access holes – marked **CH.I DC-BALANCE CH.II** – which are found underneath the instrument.
- Insert a screwdriver (blade approx. 3mm, length min. 20mm) in **CH.I** hole. A plastic guide with slotted bottom is located behind the hole.
- Pull and push the **CH.I** variable control **MAG x5** and adjust balance pot so that the baseline no longer moves up or down. When the trace remains steady, correction of **CH.I** is completed.
- Depress **CH.I/II** button. Repeat adjustment procedure for **CH.II**.

Use and Compensation of Probes

To display an undistorted waveform on an oscilloscope, the probe must be matched to the individual input impedance of the vertical amplifier.

The HM204-2's built-in calibration generator provides a squarewave signal with a very low risetime (<5ns), and switch-selectable frequencies of approx. 1kHz and 1MHz at two output sockets below the CRT screen. One output provides **0.2V_{pp} ±1%** for 10:1 probes, and **2V_{pp} ±1%** are present at the other, for 100:1 probes.

When the attenuator switches are set to **5mV/cm** vertical deflection coefficient, these calibration voltages correspond to a screen amplitude of **4cm**.

The output sockets have an internal diameter of 4.9mm to accommodate the internationally accepted shielding tube diameter of modern **Modular Probes** and **F-series** slimline probes. Only this type of construction ensures the extremely short ground connections which are essential for an undistorted waveform reproduction of non-sinusoidal high frequency signals.

Adjustment at 1kHz

This C-trimmer adjustment compensates the capacitive loading on the oscilloscope input (approx. 30pF with the HM204-2). By this adjustment, the capacitive division assumes the same division ratio as the ohmic voltage divider to ensure an equal division ratio for high and low frequencies, as for DC. (For 1:1 probes or switchable probes set to 1:1, this adjustment is neither required nor possible). A baseline exactly parallel to the horizontal graticule lines is a major condition for accurate probe adjustments. (See also 'Trace Rotation **TR**').

Connect the probes (Types HZ51, 52, 53, 54, or HZ36) to **CH.I** input. All pushbuttons should be released (in the 'out' position), and all pull switches pushed 'in'. Set the input coupling switch to **DC**, the attenuator switch to **5mV/cm**, and the **TIME/DIV.** switch to **0.2ms/cm**, and all variable controls to **CAL.** position. Plug the probetip into the appropriate calibrator output socket, i.e. 10:1 probes into the **0.2V** socket, 100:1 probes into the **2.0V** socket.

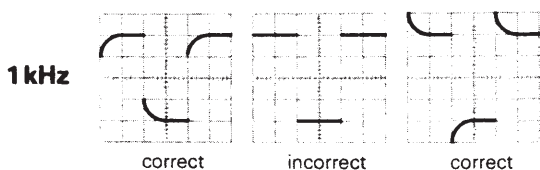

Approximately 2 complete waveform periods are displayed on the CRT screen. Now the compensation trimmer has to be adjusted. Normally, this trimmer is located in the probe head. On the 100:1 probe HZ53, however, it is located in the connecting box at the other end of the cable. Using a

small insulated non-metallic screwdriver or trimming tool, the trimmer has to be adjusted slowly until the tops of the squarewave signal are exactly parallel to the horizontal graticule lines. (See Fig. above for 1kHz). The signal amplitude shown should be $4\text{ cm} \pm 1.2\text{ mm}$ (= 3%). During this adjustment, the signal edges will remain invisible.

Adjustment at 1MHz

Probes HZ51, 52, and 54 will also allow for HF-adjustments. They incorporate resonance deemphasizing networks (R-trimmer in conjunction with inductances and capacitors) which permit – for the first time – probe compensation in the range of the upper frequency limits of the vertical oscilloscope amplifier. Only this compensation/adjustment ensures optimum utilisation of the full bandwidth, together with constant group delay at the high frequency end, thereby reducing characteristic transient distortion near the leading signal edge (e.g. overshoot, rounding, ringing, holes or bumps) to an absolute minimum.

Using the probes HZ51, 52, and 54, the full bandwidth of the HM204-2 can be utilized without risk of unwanted waveform distortion.

Prerequisite for this HF-adjustment is a squarewave generator with fast risetime (typical 4ns), and low output impedance (approx. 50Ω), providing 0.2V and 2V at a frequency of approx. 1MHz. The calibrator output of the HM204-2 meets these requirements when the pushbutton 1MHz is depressed.

Connect the probe (HZ51, 52, or 54) to **CH.I** input. Depress the calibrator pushbutton **1MHz**. All other pushbuttons should be released ('out' position). Set the input coupling switch to **DC**, attenuator switch to **5mV/cm**, and **TIME/DIV.** switch to **0.1µs/cm**. Set all variable controls to **CAL.** position.

Insert the probe tip into the output socket marked **0.2V**. A waveform will be displayed on the CRT screen, with leading and trailing edges clearly visible. For the HF-adjustment now to be performed, it will be necessary to observe the rising edge as well as the upper left corner of the pulse top. To gain access to the HF-compensation trimmer, the plastic cover of the probe connecting box has to be slid off after unscrewing the probe cable. The connecting boxes of the HZ51 and HZ54 contain one trimmer screw, each, while that of the HZ52 provides three. These trimmers have to be adjusted in such a manner that the beginning of the pulse top is as straight as possible. Overshoot or excessive rounding are unacceptable. This is relatively easy on the HZ51 and HZ54, but slightly more difficult on the HZ52. The rising edge should be as steep as possible, with the pulse top remaining as straight and horizontal as possible.

On the HZ52, each of the three trimmers has a clearly

defined area of influence on the waveform shape (see Fig.), offering the added advantage of being able to 'straighten out' waveform aberrations near the leading edge.

Adjustment points of the probes

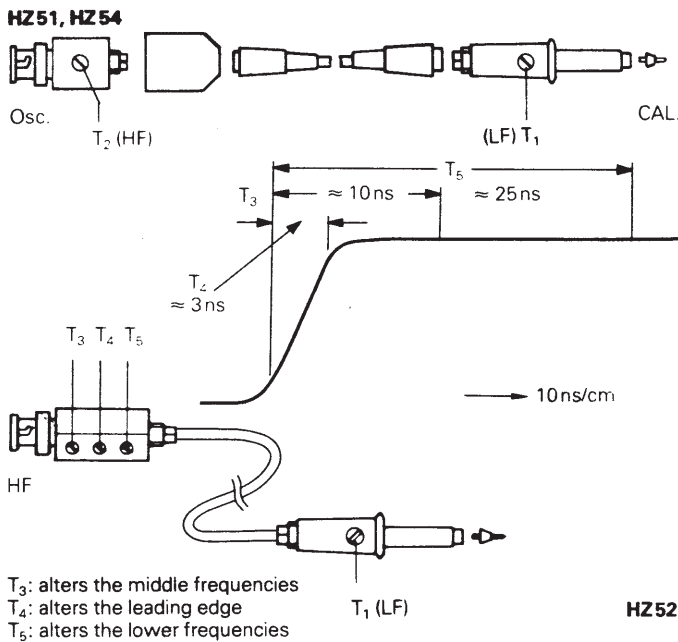

After completion of the HF-adjustment, the signal amplitude displayed on the CRT screen should have the same value as during the 1 kHz adjustment.

Probes other than those mentioned above, normally have a larger tip diameter and may not fit into the calibrator outputs. Whilst it is not difficult for an experienced operator to build a suitable 'adapter', it should be pointed out that most of these probes have a slower risetime with the effect that the total bandwidth of scope together with probe may fall far below that of the HM 204-2. Furthermore, the HF-adjustment feature is nearly always missing so that waveform distortion can not be entirely excluded.

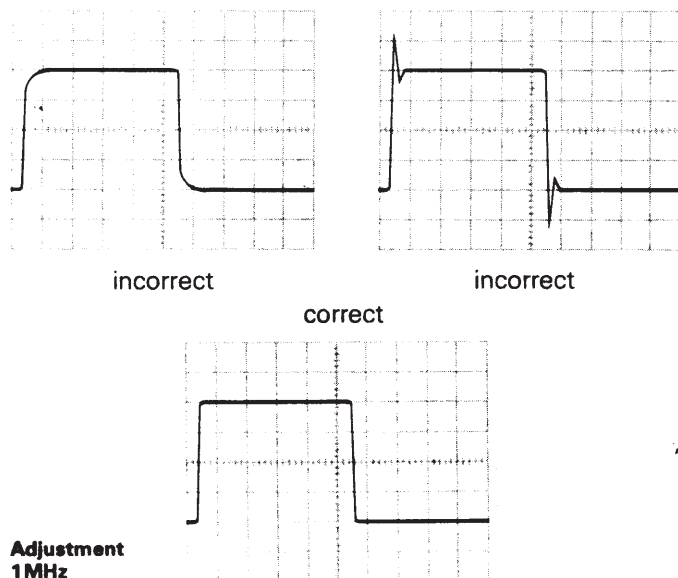

The adjustment sequence must be followed in the order described, i.e. first at 1 kHz, then at 1 MHz. The calibrator frequencies should not be used for timebase calibrations. The pulse duty cycle deviates from 1:1 ratio.

Prerequisites for precise and easy probe adjustments, as well as checks of deflection coefficients, are straight horizontal pulse tops, calibrated pulse amplitude, and zero-potential at the pulse base. Frequency and duty cycle are relatively uncritical. For interpretations of transient response, fast pulse risetimes and low-impedance generator outputs are of particular importance.

Providing these essential features, as well as switch-selectable output-frequencies, the calibrator of the HM204-2 can, under certain conditions, replace expensive squarewave generators when testing or compensating wideband-attenuators or -amplifiers. In such a case, the input of an appropriate circuit will be connected to one of the **CAL.**-outputs via a suitable probe.

The voltage provided at a high-impedance input ($1\text{ M}\Omega \parallel 15\text{-}50\text{ pF}$) will correspond to the division ratio of the probe used ($10:1 = 20\text{ mV}_{pp}$, $100:1 = \text{also } 20\text{ mV}_{pp}$ from 2 V output). Suitable probes are HZ51, 52, 53, and 54.

For low-impedance inputs (e.g. $50\ \Omega$), a 1:1 probe can be employed which, however, must be fully terminated with a $50\ \Omega$ through-termination. Suitable probe types are HZ50 and HZ54. The latter must be switched to the 1:1 position, and the HF-trimmer in the connecting box turned fully counterclockwise.

When connected to the **0.2V CAL.** socket, and using the HZ50, this arrangement will provide approx. 40 mV_{pp} at $50\ \Omega$ circuit input, and approx. 24 mV_{pp} if the HZ54 is used.

The voltages given here will have larger tolerances than 1% since operation of a 1:1 probe together with a $50\ \Omega$ load is very uncommon.

Using the **2V CAL.** socket under similar conditions is only possible with the **HZ54** probe. The potential obtained at the $50\ \Omega$ input will then be approx. 190 mV_{pp} , but with almost twice the risetime. Accurate readings of the available input voltage can be shown directly on the HM204-2 when connecting a $50\ \Omega$ through-termination between the BNC plug of the probe and the input of the oscilloscope.

Operating Modes of the Y Amplifier

The required operating modes are selected on four pushbuttons located in the Y-Section. For **Mono** operation all pushbuttons should be in the out position, the instrument is then operating on **Channel I** only.

For **Mono** operation with **Channel II**, the **CHI/II** pushbutton has to be pressed; then the small **I/II** trigger pushbutton switch in the X-Section should be pressed to **II**. When the **DUAL** button is depressed, the HM204-2 is in **Dual** channel operation. In this mode, the channels are displayed consecutively (alternate mode). This mode is not suitable for the display of very low frequency signals (<1 kHz), as the trace will appear to flicker or jump. Under these conditions, the **ADD/CHOP.** button should be depressed additionally selecting chopped mode. In this position, both channels then share the trace during each sweep period. For the display of high frequency signals, the type of channel switching selected is less important.

To select the **add mode** only the **ADD/CHOP.** button should be depressed. The signals on both channels are then added together. If in this mode Channel I is **inverted** (pushbutton **INV.I** depressed), then the **difference** between the two channels is displayed. For both of these operating modes, the vertical position of the trace depends on the setting of the **Y-POS.** controls of both channels.

Differential measurements techniques allow direct measurement of the voltage drop across floating components (both ends above ground). Two identical probes should be used for both vertical inputs. Using a separate ground connection and **not** connecting the probe or cable shields to the circuit under test avoid ground loops (hum, common-mode disturbances).

X-Y Operation

For **X-Y operation**, the pushbutton in the X-Section marked **X-Y** must be depressed. The X signal is then derived from the **Channel II (HOR. INP.)**. **The calibration of the X signal during X-Y operation is determined by the setting of the Channel II input attenuator and variable control.** This means that the sensitivity ranges and input impedances are identical for both the X and Y axes. However, the **Y-POS.II** control is disconnected in this mode. Its function is taken over by the **X-POS.** control. It is important to note that the **MAG. X10** facility, normally used for expanding the sweep, should not be operated in the X-Y mode. It should also be noted that the bandwidth of the X amplifier is approximately 2 MHz (-3dB), and therefore an increase in phase difference between both axes is noticeable from 50kHz upwards.

The Y-Input signal may be inverted by using the **INV.I** facility.

X-Y Phase Measurements

The X-Y phase measurement method can be used to measure the phase difference between two signals of the same frequency. This provides a method of measurement for sig-

nal frequencies up to 120kHz. However, above this frequency the inherent phase difference between the vertical and horizontal system makes accurate measurements difficult. In this mode, one of the sinewave signals provides horizontal deflection (X) while the other signal provides the vertical deflection (Y).

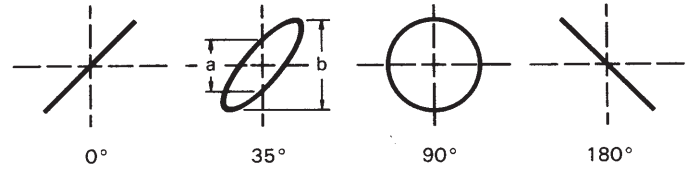

The phase angle between the two signals can be determined from the Lissajous pattern as follows:

$$\sin \varphi = \frac{a}{b}$$

$$\cos \varphi = \sqrt{1 - \left(\frac{a}{b}\right)^2}$$

$$\varphi = \arcsin \frac{a}{b}$$

This simple formula works for angles less than 90°. For angles over 90° (leftward tilt), add 90° to the calculated angle.

Caution!

If a single spot appears (both deflection voltages are missing) reduce the intensity immediately, as a high intensity setting may cause damage to the fluorescent screen of the CRT.

Dual-Trace Phase Difference Measurements

Phase comparison between two signals of the same frequency can be made using the dual-trace feature (**DUAL** button depressed). This method of phase difference measurement can be used up to the frequency limit of the vertical system. To make the comparison, use the following procedure:

Set the Input Coupling switches to the same position, and the **Trigger** pushbutton (**I/II**) to the channel where the reference signal (Phase 0°) is connected. Select **ALT.** channel switching for frequencies below 1 kHz, and **CHOP.** for frequencies above 1 kHz. Use probes which have equal time delay to connect the signals to the input connectors. Set the Input Attenuator switches and the CHI and CHII variable controls so the displays are approximately equal and about five divisions in amplitude. Set the **TIME/DIV.** switch to a sweep rate which displays about one cycle of the waveform. Move the waveforms to the center of the graticule with the **Y-POS.I** and **Y-POS.II** controls.

Turn the Variable Time Control until one cycle of the reference signal occupies exactly 10 divisions (see figure below). Each division represents 36° of the cycle.

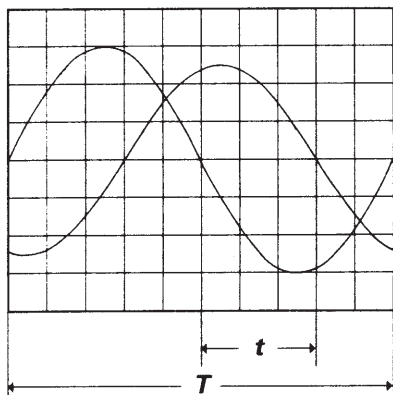

Dual-Trace Phase Difference Measurements

T = Horizontal distance *for one period* (cm).

t = Horizontal distance of zero-crossing points (cm).

Assume a horizontal difference of 3 divisions (**t** = 3 cm) and a period of 10 divisions (**T** = 10 cm), the phase difference φ can be calculated using the following formula:

$$\varphi^\circ = \frac{t}{T} \cdot 360^\circ = \frac{3}{10} \cdot 360^\circ = 108^\circ$$

or

$$\text{arc } \varphi = \frac{t}{T} \cdot 2\pi = \frac{3}{10} \cdot 2\pi = 1,885 \text{ rad}$$

respectively.

Y Overscanning Indication

This indicating facility shows any overscanning of the usable screen dimensions *in the vertical direction*, if the baseline or signal portions with more than 100ns duration (e.g. needle pulses) are not within the graticule. The indication is achieved by 2 light-emitting diodes, marked **OVER-SCAN**, which are located in the center of the small section directly below the screen. Should one LED illuminate without an input signal, this means that the respective vertical positioning control has been improperly adjusted. Because each LED correlates with one of both possible directions, it can be seen in which direction the trace has left the screen. With dual channel operation, misadjustment of both **Y-POS.** controls can occur. If both traces lie in the same direction, one LED illuminates likewise. If one trace is positioned above and the other below the graticule, both LEDs are illuminated. The indication of the Y position after crossing the graticule area occurs *in each operating mode*, also when, due to missing time deflection, no baseline is displayed, or when the oscilloscope is in the X-Y mode.

As previously written in the paragraph "First Time Operation", the **LEVEL** control knob should be pressed (**PEAK**) if possible, as a baseline is then permanently displayed, also without any input signal. The trace disappears at times after applying an input signal. The LED indication shows, in which direction the trace has left the screen, above or below the graticule. Illumination of both LEDs at the same time after applying a signal means that the vertical deflection has overscanned the graticule edges in both vertical directions. With **DC** input coupling and an applied signal with a relatively high DC offset, smaller sizes also of displayed signals can over-scan the raster edges, because the DC voltage causes a vertical position shift of the display height, which seemed correctly adjusted. In this case, a smaller display height must be accepted, or **AC** input coupling has to be selected. Lighting of the overscan LEDs does not imply that the signal's shape is always distorted in the setting just selected. The vertical amplifier has a certain overdriving reserve. However, it is better to check that the maximum output voltage swing is not exceeded. This can be done by turning the attenuator switch one step to the left. If the overscanning indication is extinguished thereby, the foregoing setting can be used for checking e.g. the tops of square pulses with vertical expansion. Of course, this is not valid for pulses with frequency spectra beyond 8MHz, because in this case the overdriving reserve naturally diminishes.

Triggering and Timebase

In order to obtain a satisfactory stable display, the timebase must be triggered synchronously with the test signal. The trigger signal can be derived from the test signal itself, when internal triggering is selected, or from a frequency related signal applied to the external trigger input.

If the **LEVEL** control knob in the X-Section is in the depressed position **PEAK (Automatic Peak-To-Peak Triggering)**, the sweep generator will be triggered automatically. In the **PEAK** position and with proper trigger control settings, the sweep can be started by virtually all uncomplicated signals with repetition rates above about 30Hz and within the frequency range selected by the trigger coupling switch, provided that the displayed signal height is at least **5mm** (trigger threshold for internal triggering). In the absence of an adequate trigger signal or when the trigger controls are misadjusted, the sweep free-runs and produces a baseline (time axis) as a reference trace. The trigger point on the signal curve is selected with the **LEVEL** control. Its capture range is balanced automatically always to the peak-to-peak amplitude of the signal just applied. The advantage of this trigger mode is that the trigger point shift is more independent of the display height just selected and of the signal's shape. For instance, the pulse duty factor of a square signal may change from 1:1 to 100:1 without triggering failure. However, it may happen during the course of a foregoing measurement that the **LEVEL** control was

adjusted nearly to its stop. The triggering may then possibly fail during the next measurement as a result of a change in display height and/or signal shape. A small adjustment of the **LEVEL** control towards midrange is enough, however, to recover a stable display. This Automatic Peak-To-Peak Triggering operates in principle also with external triggering via the **EXT. TRIG.** connector. However, the (synchronous) trigger voltage required for it should be approximately in the 0.05-0.5V_{pp} range.

With **Normal Triggering** (**LEVEL** knob pulled) and **LEVEL** adjustment, the sweep can be started by signals within the frequency range selected by the trigger coupling switch. In the absence of an adequate trigger signal or when the trigger controls (particularly the **LEVEL** control) are misadjusted, no trace is visible, i.e. the screen is blanked completely. When using the internal Normal Triggering mode, it is possible to trigger at any amplitude point of a signal edge, even with very complex signal shapes, by adjusting the **LEVEL** control. Its adjusting range is directly dependent on the display height, which should be at least **5mm**. If it is smaller than 1 cm, the **LEVEL** adjustment needs to be operated with a sensitive touch. In the external Normal Triggering mode, the same applies to the external trigger voltage amplitude.

Triggering can be selected on either the rising or falling edge of the trigger signal depending on whether the **SLOPE +/–** pushbutton is in the out or in position. In the out position, triggering from the positive-going edge is selected. The correct slope setting is important in obtaining a display when only a portion of a cycle is being displayed.

With **internal triggering** in the **Mono channel mode** on the Y amplifier, the trigger signal must be derived from the respective channel in use. For this, the trigger **I/II** pushbutton in the X-Section has to be released or depressed. In the **Dual channel mode**, the internal trigger signal may be selected from either **Channel I** or **Channel II** using the same **I/II** button; in the out position, the trigger signal is derived from Channel I. However, it is always preferable to trigger from the less complicated signal.

With **internal alternate triggering** (**ALT** pushbutton in the X-Section depressed) in the **DUAL** channel alternate mode of the Y amplifier, the trigger voltage is derived **alternately from Channel I and Channel II**. This trigger mode is particularly useful when **two asynchronous signals** are being investigated. Normal triggering (**LEVEL** knob depressed) should be preferable in this mode. The display of one signal only is not possible on the alternate trigger mode. On all other modes, only Channel I is connected through with depressed **ALT** button.

For **external triggering**, the **EXT.** pushbutton in the X-Section must be depressed. The sync. signal (**50 mV_{pp}-0.5 V_{pp}**) must then be fed to the **TRIG. INP.** input socket.

However, an **alternative method** may be used **for external triggering**. On Mono channel operation with Channel I, an "external" triggering is possible via the input of the unemployed Channel II (**I/II** pushbutton in the X-Section depressed). This method is particularly advisable, if the amplitude of the external trigger signal is not in the range 0.05-0.5V_{pp} or if it is of unknown value. In this case, the trigger amplitude can be adjusted by means of the **CH.II** attenuator switch and its variable control in the range from 5mV_{pp} up to approximately 150V_{pp}, matching the trigger input requirements of the timebase in an optimum manner. It is advantageous, if the external trigger signal is first displayed and adjusted to a height of 2-6cm. For this, the **CH.I/II** pushbutton has to be pressed. After this, the **CH.I/II** button can be released to **CH.I** display. However, the **I/II** button in the X-Section remains in the depressed **II** position. This method can be reversed with a mutual exchange of Channel I for Channel II, but it can only be used in the Mono channel operating mode.

Coupling mode and frequency range of the trigger signal are selected with the **TRIG.** slide switch in the X-Section for internal and external triggering. The HM204-2 has 4 coupling modes: **AC, DC, HF, LF**. The **AC** coupling mode is mainly used. **DC** trigger coupling is only recommended, when very low frequency signals are being investigated and triggering at a particular value is necessary, or when pulses, which significantly change in duty cycle during observation time, have to be displayed. If **DC** coupling is selected, it is advisable to use the **normal triggering** mode (**LEVEL** control knob pulled), as there is the possibility that, in the **PEAK** mode, triggering may not be achieved on signals without zero-axis crossing point (DC offset). Although, automatic peak-to-peak value triggering is possible with **DC** trigger coupling, it needs a precise adjustment of the DC input balance.

In the **HF** coupling mode, a **high pass filter** is switched into the trigger amplifier. This filter cuts off the DC content of the trigger signal and the frequency range under 1 kHz.

In the **LF** coupling mode, a **low-pass filter** is switched into the trigger amplifier. This filter cuts off any amplifier noise and the frequency range of the trigger signal above 1 kHz.

For the purpose of **line triggering** (**TRIG.** slide switch in the X-Section to **LINE**) a (divided) secondary voltage of the power transformer is used as a trigger signal (50-60Hz). This trigger mode is independent of the signal amplitude or display height and allows a display below the (internal) trigger threshold. Line triggering is recommended for all signals which are time-related (multiple or submultiple) to the mains/line frequency or when it is desirable to provide a stable display of a line-frequency component in complex waveforms. Therefore it is especially suited for the measurement of small ripple voltages from power supply rectifiers or of magnetic or static leakage fields in a circuit.

In some countries, the standard power plug has symmetrically arranged plugs (interchanging of **Line** and **Neutral** is possible). In such cases, the **SLOPE +/-** pushbutton may indicate the wrong polarity compared with the display (triggering with falling edge instead of rising edge). For correction, the power plug of the instrument has to be turned.

If the **video signal** of a television set is to be displayed at **frame frequency**, synchronization is generally difficult due to the presence of the higher line frequency pulses contained in the signal. The line pulses can be attenuated by switching the **TRIG.** selector switch in the X-Section to **LF**. With **normal triggering** and correct setting of the **SLOPE +/-** button, it will now be found that the trigger **LEVEL** control can be adjusted to trigger from either the leading or trailing edge of the frame pulse. This setting is advantageous for triggering from other signals that have a recurrence frequency of 800 Hz or less, as high frequency harmonics or noise in the signal are suppressed by the presence of the low-pass filter. However, **TV triggering at line frequency** needs **AC** or **HF** (or **DC** if necessary) setting of the **TRIG.** slide switch in the X-Section. In both cases **Normal Triggering** with **LEVEL** adjustment should always be used.

As already mentioned, simple signals may be triggered automatically in the automatic trigger mode (**LEVEL** control knob depressed in **PEAK** position). The repetition rate may also vary in such cases. However, if the pulse duty factor on square-wave or pulse signals changes drastically or deforms to a needle pulse, the **Normal Triggering** mode with **LEVEL** adjustment may well become necessary. With composite signals, the trigger facility is dependent on the occurrence of certain periodically recurring levels. The **LEVEL** adjustment of these signals will require some care.

Function of var. HOLD-OFF control

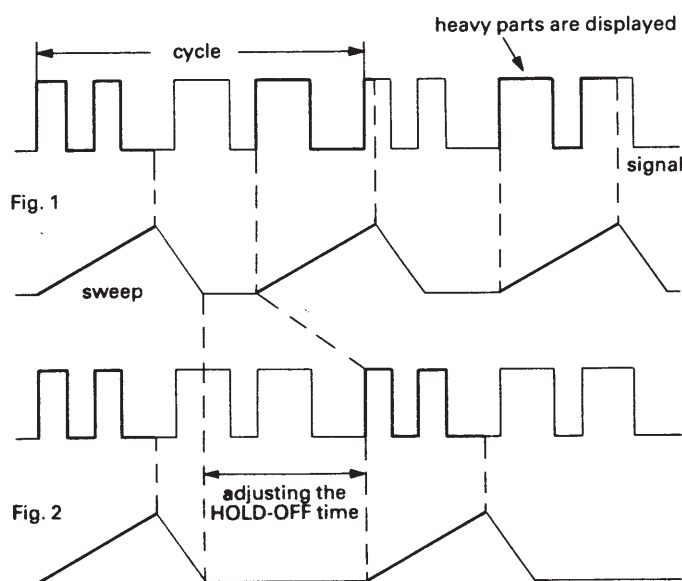

Fig. 1 shows a case where the **HOLD-OFF** knob is in the **X1** position and various different waveforms are overlapped on the screen, making the signal observation unsuccessful.

Fig. 2 shows a case where only the desired parts of the signal are displayed, providing a stable picture.

If it is found that a trigger point cannot be located on extremely complex signals even after repeated and careful adjustment of the **LEVEL** control in the **Normal Triggering** mode, a stable display may be obtained using the **HOLD-OFF X1-X10** control (in the X-Section). This facility varies the hold-off time between two sweep periods up to the ratio 10:1. Pulses or other signal waveforms appearing during this off period cannot trigger the timebase. Particularly with burst signals or aperiodic pulse trains of the same amplitude, the start of the sweep can be shifted to the optimum or required moment. After specific use the **HOLD-OFF** control should be re-set into its calibration detent **X1**, otherwise the brightness of the display is reduced drastically.

Single Sweep Operation

Single processes or events, e.g. current surge, voltage on contact breaking, or the display of the decay of a resonant circuit after pulse excitation can be represented with single sweep. For this, the **SINGLE** pushbutton in the X-Section has to be depressed. On the right of this button an LED marked **RESET** indicates the readiness of the sweep. If the **RESET** lamp is not illuminated, the pushbutton below this LED must also be pressed. Indeed, it is possible in some cases to operate with Automatic Peak-to-Peak Value Triggering (**PEAK**). The trace starts then approximately on the baseline level. This trigger mode is very sensitive: hence small unwanted signals can prematurely trigger a single sweep. For the triggering at higher or lower level values or with very slow frequencies the **Normal Triggering** is much more advantageous. It is favorable to previously determine the best setting of the **LEVEL** control in normal timebase operation using a similar signal voltage. If it is correctly adjusted, the next suitable trigger pulse starts the single sweep. After its run the **RESET** lamp goes out. For a repetition of the action, the **RESET** button must be pressed once more. With single shot, only relatively slow processes can be observed visually. Usually a photographic record is more advantageous.

The time coefficient settings on the **TIME/DIV.** switch are calibrated when the variable control (small knob on the **TIME/DIV.** switch) is set in the **CAL.** position. When this control is set fully counter-clockwise, the sweep speed is decreased by a factor of at least 2.5. This factor is not precisely calibrated. When the **x10** expansion of the sweep (**MAG. X10** button pressed) is operated, a maximum sweep speed of approximately 10 ns/cm is obtained (**TIME/DIV.** switch to **0.1 μs/cm**). The choice of the optimum time coefficient depends on the repetition rate of the signal being measured. The number of cycles displayed will increase with the time coefficient (by turning the **TIME/DIV.** switch counter-clockwise).

Sweep Delay

With the sweep delay, the start of the sweep can be delayed from the trigger point by a selectable time (100 ns to maximum 1 s). It is therefore possible to start the sweep at practically any point of a waveform. The interval, which follows the start of the sweep, can be greatly expanded by the increase of the sweep speed. From the **2 μs/cm TIME/DIV.** range downwards to slower sweep speeds, an expansion of at least 20 times, and with the aid of the **MAG. X10** expansion of even 200 times, is possible. With time coefficients higher than 5 μs/cm, the maximum expansion increases proportionally. However, with increasing the expansion, the display brightness decreases. Under very high ambient light conditions a Viewing Hood like HZ47 can overcome this problem. It should be noted that there are some difficulties with higher expansions, if the test signal has inherent jitter.

Operation of the sweep delay is relatively easy, as normally only 3 controls in the X-Section need to be used: the DELAY operating mode slide switch (**NORM.-SEARCH-DELAY**), the **DELAY** rotary switch (delay time range), and its variable control **VAR. 10:1** (small knob on the **DELAY** switch). The latter, a twenty-turn precision potentiometer with overwind protection, can increase the delay time range tenfold. An LED near the DELAY mode switch indicates the operating mode.

For reliable operation of the sweep delay, it is recommended that the following procedure should always be adopted; also reference to the accompanying figures will be of assistance.

Figure 1

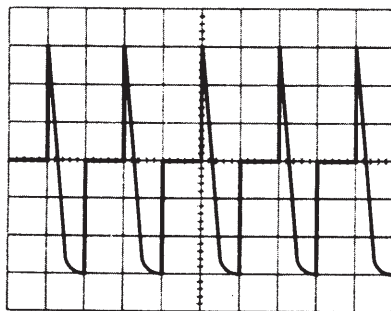

MODE : **NORM.**
 TIME/DIV. : **0.5 ms/cm**
 LED : off

Initially, the sweep delay mode slide switch should be set in the **NORM.** position. In this mode, the complete waveform under investigation will be displayed as for normal oscilloscope operation. The mode indicator LED is not illuminated in **NORM.** mode. The time coefficient on the **TIME/DIV.** switch is selected so that **1 to 3 basic periods of the signal** are displayed. A larger number unnecessarily decreases the brightness and maximum expansion. The display of only a

portion of a period limits the choice of the expanded time interval and possibly complicates the triggering. On the other hand, the range of 1 to 3 basic periods can always be set unconstrainedly with the **TIME/DIV.** switch. In doing so, the **x10 expansion must be switched off temporarily** (**MAG. X10** button is in out position). In the X-Section, the **HOLD-OFF** control should be set to **X1** and the variable control to **CAL.** The **LEVEL** control is adjusted so that a stable triggering is ensured (**TRIG.** LED is illuminated).

The mode switch should now be set to the **SEARCH** position; it will be seen that the start of the display will shift to the right. The amount of shift indicates the exact delay time. If a display is not obtained in this mode, then a lower delay time range should be selected. For example, when investigating the waveform shown in the figures, a display could not be obtained with a delay time setting of **10 ms**, as the display is completely blanked. However, as a result of setting the **DELAY** rotary switch to **0.1 μs**, the shifting is not visible. The **DELAY** range switch should then be rotated clockwise until the display starts just prior to the short time interval to be investigated. The precise adjustment to this start is done with the **VAR. 10:1** delay time control. The rotating range of the latter has no stop. On the range limits a certain snapping noise is audible. Initially, this control should be set in the left start position. In the **SEARCH** mode, the LED indicator will flash.

Figure 2

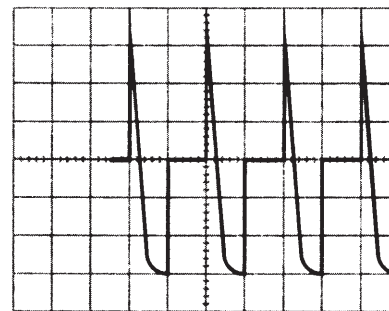

MODE : **SEARCH**
 DELAY range : **1 ms**
 TIME/DIV. : **0.5 ms/cm**
 LED : flashing

Delay time = 2.5 cm · 0.5 ms/cm = 1.25 ms

In figure 2 it can be seen that the delay time is also measurable as the blanked portion or apparent shift of the start of the trace. This time can be determined by multiplication of (the horizontal shifting in cm) by (the time coefficient set on the **TIME/DIV.** switch).

Now the mode switch can be set to **DELAY.** In this mode, the LED is permanently illuminated. The display will now shift to the left and the trace will commence in the same position as for a normal display; however, the short time interval under investigation now starts on the first or left vertical graticule line.

Figure 3

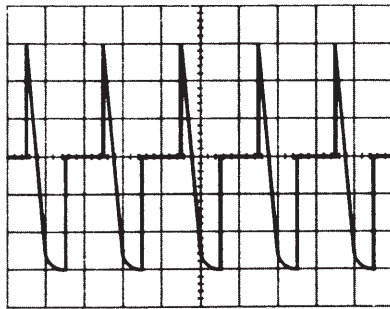

MODE : **DELAY**
 DELAY range : **1 ms**
 TIME/DIV. : **0.5 ms/cm**
 LED : illuminated

If the timebase sweep speed is increased (rotate **TIME/DIV.** switch clockwise), then the short time interval will be expanded. It may be found that, as the amount of expansion is increased, the trace will tend to shift. If this happens, the **VAR.** delay time control can be readjusted — also subsequently at any time — to enable the exact point of interest to be displayed.

In the example shown in figure 4, it can be seen that an expansion of **X10** was obtained by increasing the timebase sweep speed **from 0.5 ms/cm to 50 μs/cm**. Also the precise measurement for the delayed portion of the waveform is possible. In the example, this was found to be 250 μs on multiplication of the horizontal length in cm (of an optional signal section) by the time coefficient just adjusted.

Figure 4

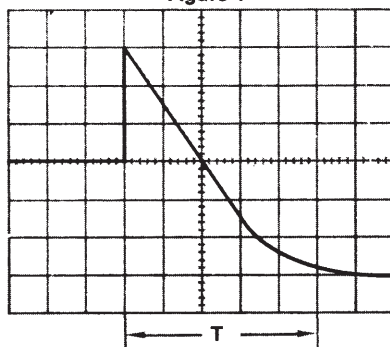

MODE : **DELAY**
 DELAY range : **1 ms**
 TIME/DIV. : **50 μs/cm**
 LED : illuminated
 Expansion : $0.5 \cdot 10^{-3} : 50 \cdot 10^{-6} = 10$
 $T = 5 \text{ cm} \cdot 50 \mu\text{s/cm} = 250 \mu\text{s}$

Operation of the sweep delay requires a constant trigger point. All signals, which have a constant phase shift between the expanded section and trigger point, pose no problems. This means all electrical signal shapes, which contain signal edges of the same polarity and with triggerable level values, which are constantly repeated with the recurring frequency. If there is no constant phase shift, the triggering may fail after switching from the **SEARCH** to

DELAY position or with changing of the time coefficient. It is best to attempt to find a trigger point, which has a constant phase shift up to the signal section to be expanded in the **NORMAL** mode. With complicated composite signals, the display of the basic period could become superimposed by other signal portions. These disappear as a rule when the sweep is increased. Otherwise, a stable expanded display is obtained by adjusting the **LEVEL** and the variable sweep control or by means of the **HOLD-OFF** control.

Using the **MAG. X10** button, a **tenfold expansion** of the desired signal section is possible without any change of triggering or timebase. This can be of assistance with complicated or difficult-to-trigger signals.

Operation of the sweep delay needs some experience, particularly with composite signals. However, the display of sections from simple signal waveforms is easily possible. It is recommended to operate only the sequence **NORM.-SEARCH-DELAY**, because otherwise location of the short time interval to be investigated will be relatively difficult. The sweep delay facility can be used in the following modes: **Mono**, **Dual**, and **Algebraic Addition (I+II)**.

Delay Mode Indication

Both operating modes of the sweep delay are indicated with an LED, located to the right of the DELAY mode slide switch. In **SEARCH** position, the LED will flash. This is an indication of the temporary operating state. The **DELAY** position is indicated by constant lighting of the LED. However, should this be noted, and normal operating mode is required then the change-over of the slide switch to its **NORM.** position has been overlooked. This could cause errors in displaying a signal by complete or partial blanking. This indication, therefore, should be closely observed.

Component Tester

General

The HM204-2 has a built-in electronic Component Tester (abbreviated **CT**), which is used for instant display of a test pattern to indicate whether or not components are faulty. The **CT** can be used for quick checks of semiconductors (e.g. diodes and transistors), resistors, capacitors, and inductors. Certain tests can also be made to integrated circuits. All these components can be tested in and out of circuit.

The test principle is fascinatingly simple. The power transformer of the oscilloscope delivers a sine voltage, which is applied across the component under test and a built-in fixed resistor. The sine voltage across the test object is used for the horizontal deflection, and the voltage drop across the resistor (i.e. current through test object) is used for vertical deflection of the oscilloscope. The test pattern shows a current-voltage characteristic of the test object.

Since this circuit operates with mains/line frequency (50 or 60 Hz) and a voltage of 8.5 V max. (open circuit), the indicating range of the **CT** is limited. The impedance of the component under test is limited to a range from $20\ \Omega$ to $4.7\ \text{k}\Omega$. Below and above these values, the test pattern shows only short-circuit or open-circuit. For the interpretation of the displayed test pattern, these limits should always be borne in mind. However, most electronic components can normally be tested without any restriction.

Using the Component Tester

The **CT** is switched on by depressing the **CT** pushbutton in the Y-Section. This makes the vertical preamplifier and the timebase generator inoperative. A shortened horizontal trace will be observed. It is not necessary to disconnect scope input cables unless in-circuit measurements are to be carried out. In the **CT** mode, the only controls which can be operated are **INTENS.**, **FOCUS**, and **X-POS.**. All other controls and settings have no influence on the test operation.

For the component connection, two simple test leads with 4 mm \varnothing banana plugs, and with test prod, alligator clip or sprung hook, are required. The test leads are connected to the insulated **CT** socket and the adjacent ground socket in the Y-Section. The component can be connected to the test leads either way round.

After use, to return the oscilloscope to normal operation, release the **CT** pushbutton.

Test Procedure

Caution! Do not test any component in live circuitry – remove all grounds, power and signals connected to the component under test. Set up Component Tester as stated above. Connect test leads across component to be tested. Observe oscilloscope display.

Only discharged capacitors are allowed to be tested!

A built-in quick-acting fuse protects the **CT** and the oscilloscope against mis-operation, e.g. device under test not disconnected from mains/line supply. In that case the fuse will blow. For fuse replacement the oscilloscope has to be opened (see service instruction page S1 "Instrument Case Removal"). The fuse is located on the bottom side of the instrument (close to the **CT** pushbutton). Make sure that only fuses of the specified type are used for replacement: **5x20 mm, quick-acting, 250V, C, 50mA** (IEC 127/II or DIN 41661).

Test Pattern Displays

Page M19 shows typical test patterns displayed by the various components under test.

- **Open circuit is indicated by a straight horizontal line.**
- **Short circuit is shown by a straight vertical line.**

Testing Resistors

If the test object has a linear ohmic resistance, both deflecting voltages are in the same phase. The test pattern expected from a resistor is therefore a sloping straight line. The angle of slope is determined by the resistance of the resistor under test. With high values of resistance, the slope will tend towards the horizontal axis, and with low values, the slope will move towards the vertical axis.

Values of resistance from $20\ \Omega$ to $4.7\ \text{k}\Omega$ can be approximately evaluated. The determination of actual values will come with experience, or by direct comparison with a component of a known value.

Testing Capacitors and Inductors

Capacitors and inductors cause a phase difference between current and voltage, and therefore between the X and Y deflection, giving an ellipse-shaped display. The position and opening width of the ellipse will vary according to the impedance value (at 50 or 60 Hz) of the component under test.

A horizontal ellipse indicates a high impedance or a relatively small capacitance or a relatively high inductance.

A vertical ellipse indicates a small impedance or a relatively large capacitance or a relatively small inductance.

A sloping ellipse means that the component has a considerable ohmic resistance in addition to its reactance.

The values of capacitance of normal or electrolytic capacitors from $0.1\ \mu\text{F}$ to $1000\ \mu\text{F}$ can be displayed and approximate values obtained. More precise measurement can be obtained in a smaller range by comparing the capacitor under test with a capacitor of known value. Inductive components (coils, transformers) can also be tested. The determination of the value of inductance needs some experience, because inductors have usually a higher ohmic series resistance. However, the impedance value (at 50 or 60 Hz) of an inductor in the range from $20\ \Omega$ to $4.7\ \text{k}\Omega$ can easily be obtained or compared.

Testing Semiconductors

Most semiconductor devices, such as diodes, Z-diodes, transistors, FETs can be tested. The test pattern displays vary according to the component type as shown in the figures below.

The main characteristic displayed during semiconductor testing is the voltage dependent knee caused by the junction changing from the conducting state to the non conducting state. It should be noted that both the forward and the reverse characteristic are displayed simultaneously. This is

always a two-terminal test, therefore testing of transistor amplification is not possible, but testing of a single junction is easily and quickly possible. Since the **CT** test voltage applied is only very low (max. $8.5V_{rms}$), all sections of most semiconductors can be tested without damage. However, checking the breakdown or reverse voltage of high voltage semiconductors is not possible. More important is testing components for open or short-circuit, which from experience is most frequently needed.

Testing Diodes

Diodes normally show at least their knee in the forward characteristic. This is not valid for some high voltage diode types, because they contain a series connection of several diodes. Possibly only a small portion of the knee is visible. Z-diodes always show their forward knee and, up to approx. 10V, their Z-breakdown, forms a second knee in the opposite direction. A Z-breakdown voltage of more than 12V can not be displayed.



Type: Normal Diode High Voltage Diode Z-Diode 12V
 Terminals: Cathode-Anode Cathode-Anode Cathode-Anode
 Connections: (CT-GD) (CT-GD) (CT-GD)

The polarity of an unknown diode can be identified by comparison with a known diode.

Testing Transistors

Three different tests can be made to transistors: base-emitter, base-collector and emitter-collector. The resulting test patterns are shown below.

The basic equivalent circuit of a transistor is a Z-diode between base and emitter and a normal diode with reverse polarity between base and collector in series connection. There are three different test patterns:

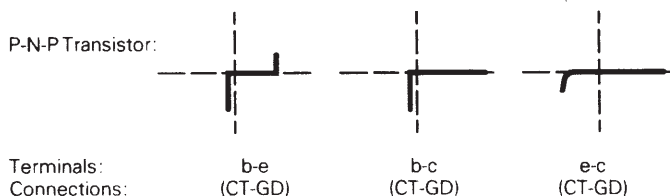
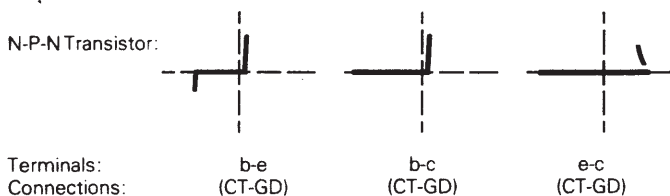

For a transistor the figures b-e and b-c are important. The figure e-c can vary; but a vertical line only shows short circuit condition.

These transistor test patterns are valid in most cases, but there are exceptions to the rule (e.g. Darlington, FETs). With the **CT**, the distinction between a P-N-P to a N-P-N transistor is discernible. In case of doubt, comparison with a known type is helpful. It should be noted that the same socket connection (**CT** or ground) for the same terminal is then absolutely necessary. A connection inversion effects a rotation of the test pattern by 180 degrees round about the center point of the scope graticule.

Pay attention to the usual caution with single MOS-components relating to static charge or frictional electricity!

In-Circuit Tests

Caution! During in-circuit tests make sure the circuit is dead. No power from mains/line or battery and no signal inputs are permitted. Remove all ground connections inclusive Safety Earth (pull out power plug from outlet). Remove all measuring cables inclusive probes between oscilloscope and circuit under test. Otherwise the connection of both CT test leads is not recommended.

In-circuit tests are possible in many cases. However, they are not so well-defined. Caused by shunt connection of real or complex impedances – especially if they are of relatively low impedance at 50 or 60Hz – to the component under test, often great differences result compared with single components. In case of doubt, one component terminal may be unsoldered. This terminal should then be connected to the insulated **CT** socket avoiding hum distortion of the test pattern.

Another way is a test pattern comparison to an operating circuit with the same circuit diagram (likewise without power and any external connections). Using the test prods, identical test points in each circuit can be checked, and a defect can be determined quickly and easily. Possibly the device itself under test contains a reference circuit (e.g. a second stereo channel, push-pull amplifier, symmetrical bridge circuit), which is not defective.

The test patterns on page M19 show some typical displays for in-circuit tests.

Miscellaneous

A positive-going **sawtooth voltage** of approximately $5V_{pp}$ coincident with display's sweep time is available at a BNC output connector on the rear panel. This ramp output is

marked with a sawtooth symbol. The load resistance should not be less than $10\text{k}\Omega$. If the DC potential of the ramp output is not required, a capacitor should be connected in series with the output. The ramp output can be used for different measuring tasks in combination with the oscilloscope and other instruments, e.g. 4-Channel-Amplifier HZ64, triggering of signal sources, swept-frequency signal generators and so on.

Blanking or intensity **Z-modulation** respectively of the CRT display is possible using the input connector marked **Z** on the rear panel. Low TTL level (positive logic) effects blanking, high level gives unblanking. No higher voltages than $5V_{pp}$ are permitted. The sine- or square-wave generator, required for a blanking signal, must have an output impedance under 600Ω . A square-wave generator with negative pulses to ground (chassis) is not suitable. Also an offset (DC) voltage is not allowed for periodic modulation. For setting the blanking duty factor, the output voltage of a sine-wave generator should be adjustable. The Z-modulation occurs in bright-dark steps. An analog Z-modulation with continuous gradation of tones is not possible. The modulating generator should have a sync input or – at least – an incremental frequency control, if an evaluation of the Z-modulation is necessary (blanking gaps as time markers). Generally, it is suitable to generate the Z-modulating frequency by multiplying the measuring frequency. Then the display shows stationary time markers.

The Z-modulation may also be effected with a **mechanical switch**, connected directly parallel to the **Z** connector, **without any power source**:

contact closed \triangleq dark trace
contact open \triangleq bright trace

This facility simplifies for instance contact time measurements and chatter tests on switches (relay). For periodical switch operation, the mechanical drive unit should deliver functionally a trigger signal. Only with synchronous operation of the Z-modulation and the sweep is a stationary display obtained.

The oscilloscope also contains a **vertical output** with BNC connector marked **Y** on the rear panel. The output voltage is $45\text{mV}_{pp}/\text{cm}$ display height (into 50Ω). It is picked off from the vertical amplifier like the trigger signal and it is similarly switchable. Channel **I** or **II** is selected with the **I/II** trigger pushbutton in the X-Section. With alternate channel switching (**DUAL** button in the Y-Section depressed) and alternate triggering (**ALT.** button in the X-Section depressed), the vertical output is consecutively driven (in time with the sweep period) from Channel I and Channel II. The vertical output is not dependent on the vertical trace position. It does not respond to the adjustment of the **Y-POS.I** and **Y-POS.II** controls and to the depressing of the **INVERT I** button. The

vertical output is DC coupled and has approximately zero level to ground. The bandwidth of the output is approx. 20MHz (with 50Ω termination).

Especially for the photographic recording of displays, the oscilloscope has a **raster illumination**. Normally, the raster, which is necessary for the point-by-point evaluation, is not visible without illumination. Variation of the brightness is possible on two steps with a slide switch marked **ILLUM.**, which is mounted below the screen. In the uppermost position, the illumination is switched off. The optimum setting depends on the camera and film exposure index used. Possibly some test pictures are required for a good representation of the graticule.

Accessories

Each HAMEG oscilloscope is supplied with an Instruction Manual only. However, a wide range of accessories, which include test cables and probes, are available and should be ordered according to the particular application.

Single Components

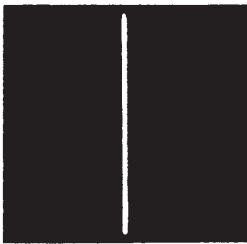

Short circuit

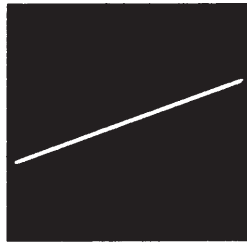

Resistor 510Ω



Mains transformer prim.

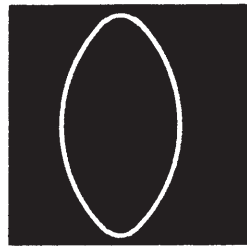

Capacitor 33μF

Single Transistors



Junction B-C

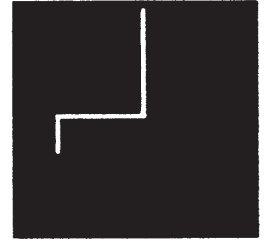

Junction B-E



Junction E-C



FET

Single Diodes



Z-diode under 8V



Z-diode beyond 12V



Diode paralleled by 680Ω

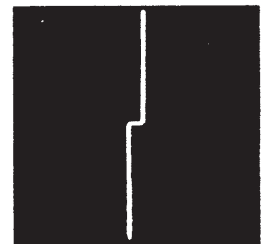

2 Diodes antiparallel



Silicon diode



Germanium diode



Diode in series with 51Ω



B-E paralleled by 680Ω



Rectifier



Thyristor G + A together



B-E with 1μF + 680Ω



Si-diode with 10μF

First Time Operation

Connect the instrument to power outlet. Switch on **POWER** pushbutton. No other button is pressed. LED indicates operating condition. **Case, chassis, and all measuring connectors are connected to the Safety Earth Conductor (Safety Class I).**

TRIG. selector switch to **AC**, **LEVEL** knob pressed to **PEAK** (Automatic Triggering).

DELAY slide switch to **NORM.** and **HOLD-OFF** control **X1**.

Adjust **INTENS.** control for average brightness.

Center trace on screen using **X-POS.** and **Y-POS.I** controls. Then focus trace using **FOCUS** control.

Operating Modes of the Vertical System

Channel **I**: All pushbuttons in out position.

Channel **II**: **CH.I/II** button pressed.

Channel **I and Channel II**: **DUAL** button pressed.

Alternate channel switching: **ADD/CHOP.** button in out position.

Chopped channel switching: **ADD/CHOP.** button pressed. Signals <1 kHz with **CHOP.**

Channel **I + II** (sum): **I + II (ADD/CHOP.)** button pressed only.

Channel **-I + II** (difference): **I + II (ADD/CHOP.) and INV.I** buttons pressed.

Trigger Modes

Automatic Triggering: **LEVEL** knob pressed to **PEAK**. Trace always visible.

Normal Triggering: **LEVEL** knob pulled to **NORM.** Trace visible when triggered.

Triggering from positive-going signal edge: **SLOPE +/—** button is in out position.

Triggering from negative-going signal edge: **SLOPE +/—** button pressed.

This facility is important when only a portion of a cycle is being displayed.

Internal triggering from Channel **I**: **I/II** button in out position.

Internal triggering from Channel **II**: **I/II** button pressed.

These both internal trigger modes are valid also for dual channel operation.

Internal alternate triggering: **ALT** button is pressed (only with alternate channel switching).

External triggering from **TRIG. INP.** connector: **EXT.** button pressed.

External trigger signal: 50 mV-0.5 V_{pp}, time-related to vertical input signal.

Line triggering: **TRIG.** selector switch in **LINE** position.

Trigger coupling selected with **TRIG.**, switch **AC-DC-HF-LF** (**DC** coupling needs normal triggering).

Trig. freq. range: **AC** and **DC** to 10 MHz, **HF** above 10 MHz, **LF** below 1 kHz.

Video signal mixtures with line freq.: **TRIG.** switch to **AC**, possibly to **DC**. Use normal triggering.

Video signal mixtures with frame freq.: **TRIG.** switch to **LF**. Use normal triggering.

Pay attention to **TRIG.** indication LED!

Single sweep: with **SINGLE** and **RESET** buttons. Readiness: **RESET** LED is illuminated.

Measuring

Connect test signal to **CH.I** and/or **CH.II** vertical input connector.

Compensate attenuator probe using **CAL.** square-wave signal.

Select **AC** or **DC** input coupling. **GD**: Y amplifier is disconnected from input and grounded.

Adjust required display height of signal with attenuator switch and variable control.

Pay attention to **OVERSCAN** indication!

Select sweep speed with **TIME/DIV.** switch and variable control.

Adjust trigger point with **LEVEL** control.

Calibrated amplitude measurement with attenuator variable control to **CAL.**

Calibrated time measurement with **TIME/DIV.** variable control to **CAL.**

Trigger complex or aperiodic signals using **HOLD-OFF** control in normal trigger mode.

Horizontal x10 expansion: **MAG. X10** button pressed.

External horizontal deflection: (**X-Y operation**) with **X-Y** button pressed (X input via **CH.II**).

Sweep Delay Operation

NORM.: normal oscilloscope operation. **DELAY** LED dark.

SEARCH: use **DELAY** range switch and **VAR. 10:1** fine control to select point of interest on displayed wave-form. **DELAY** LED flashing.

DELAY: delayed signal now displayed. Expansion obtained by rotating **TIME/DIV.** switch clockwise. Press **MAG. X10** button if necessary. **DELAY** LED illuminated.

Component Tester

Press **COMPONENT TESTER** button. Connect both component terminals to **CT** and ground jacks.

In-circuit test: Test circuit must be disconnected to power, signals and ground (earth).

Pull out power plug, remove all connections to HM204-2 (cable, probe), then start testing.

Front Panel Elements

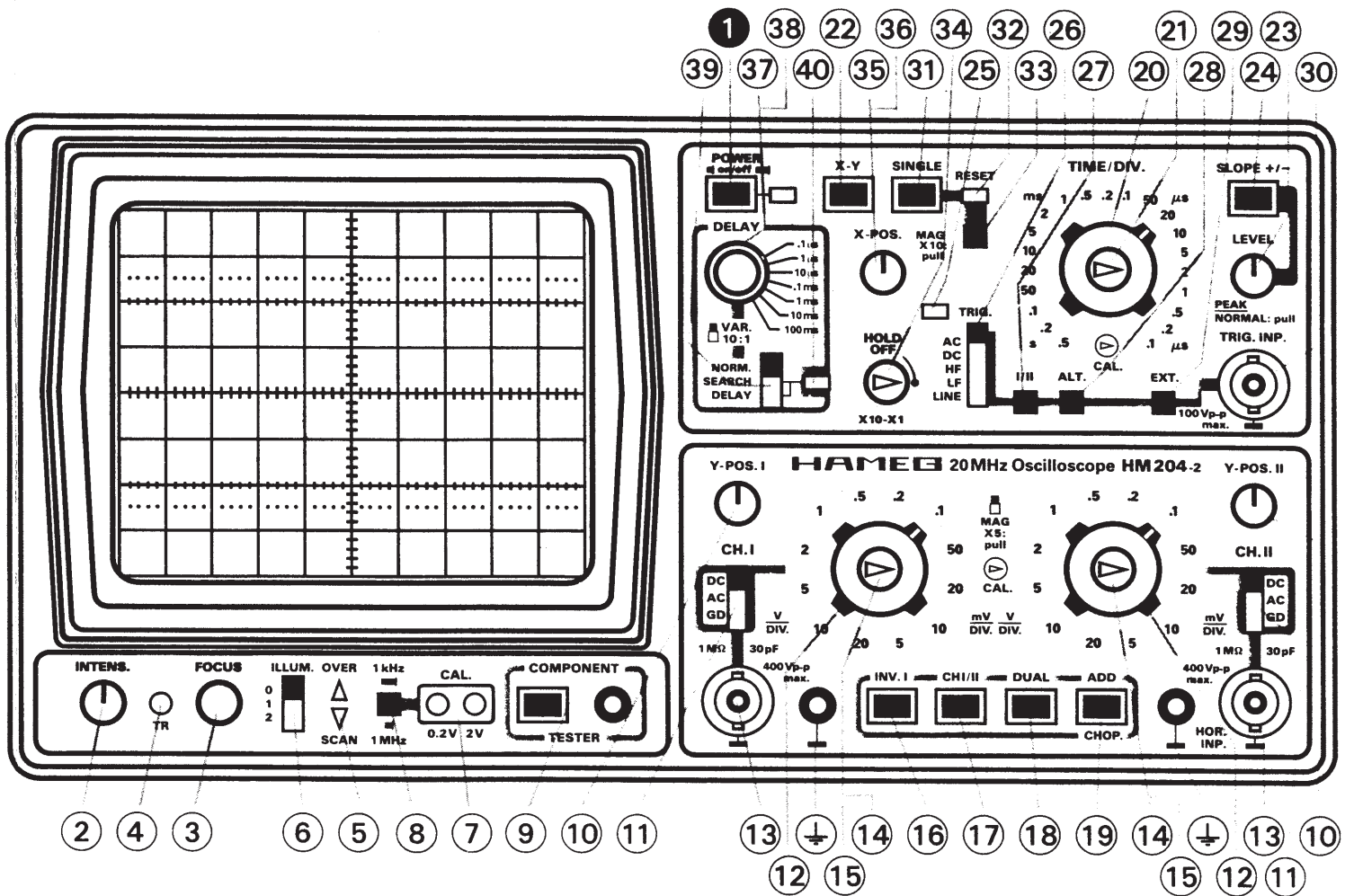

Elements located on rear panel of instrument

Front Panel Element	Function
42 APPLIANCE INLET	Use only 3-pin power cord supplied with instrument to connect to line supply.
43 LINE VOLTAGE SELECTOR	Holds fuse and selects supply voltage.

Front Panel Element	Function
41 BNC SOCKETS: \mathcal{W} -OUTPUT	Output for timebase ramp signal.
45 Z - INPUT	Input for trace modulation signal (Z-modulation).
46 Y - OUTPUT	Signal output of Channel I or II.

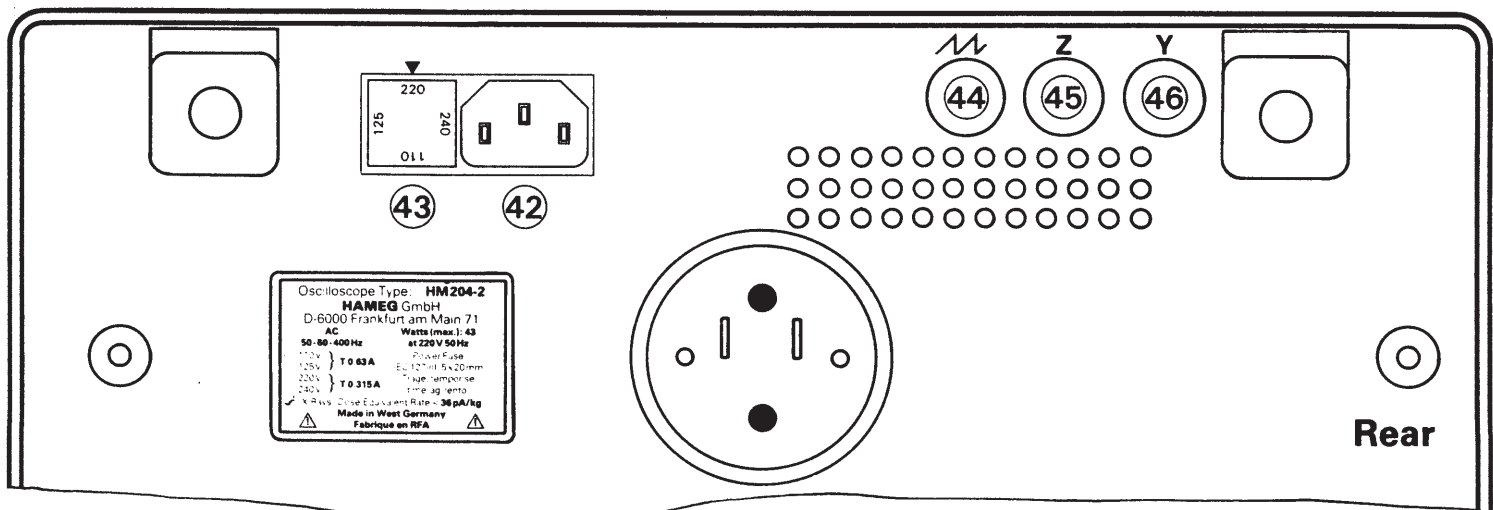

Front Panel Elements HM204-2

The HAMEG HM204-2 front panel is divided into sections according to the various oscilloscope functions.

The following table gives a short description of each front panel element.

Front Panel Element	Function	Front Panel Element	Function
① POWER on/off (pushbutton switch) and power LED	Line master switch Power on is indicated by illuminated LED.	⑳ TIME/DIV. (rotary switch)	Timebase selector switch (0.5 s/cm to 0.1 μ s/cm).
② INTENS control	Intensity control for adjustment of CRT display brightness.	㉑ TIME/DIV. (center pot.)	Timebase variable control for fine adjustment. This control should normally be reset to the CAL. (calibrated) position.
③ FOCUS control	Control to adjust display focus (sharpness).	㉒ X-Y (pushbutton switch)	Selects X-Y operation. Switches off the internal timebase generator and connects channel II (HOR. INP.) to the X-amplifier.
④ TR (Trimmer Pot.)	Trace Rotation – used to correct trace angle.	㉓ LEVEL- PEAK/NORMAL (push-pull switch)	Control for adjusting trigger level. Push for automatic peak value triggering.
⑤ OVERSCAN (LED Indicators)	Direction Indicators – will illuminate when trace passes vertical screen limits.	㉔ SLOPE +/- (pushbutton switch)	Switch to select triggering on positive- or negative-going edge of signal.
⑥ ILLUM – 0, 1, 2 (3-position slide switch)	Controls graticule illumination. Off, Dim, Bright	㉕ TRIG. (LED indicator)	Trigger lamp to indicate when timebase is triggered.
⑦ CAL 2V, 0.2V (Test sockets)	Calibrator square-wave signal source.	㉖ TRIG. AC/DC/HF/LF/Line (slide switch)	Selects trigger coupling (AC, DC, HF, LF). Set to LINE for line triggering.
⑧ CAL 1 kHz/1 MHz (pushbutton switch)	Selects calibrator frequency 1 kHz or 1 MHz.	㉗ I/II (pushbutton switch)	Selects trigger signal from Channel I or Channel II.
⑨ COMPONENT TESTER (pushbutton switch and single pole socket)	Switch to convert oscilloscope to component tester mode. Connector for single test lead. Second test lead is connected to chassis ground socket.	㉘ ALT (pushbutton switch)	Selects alternate trigger mode from Channel I and Channel II.
⑩ Y POS I, Y POS II (Control pot.)	Adjusts vertical position of trace for Channel I and Channel II.	㉙ EXT. (pushbutton)	Selects external trigger mode.
⑪ CH. I, DC, AC, GD CH. II, DC, AC, GD (3-position slide switch)	Input coupling selector switch for each channel. DC – direct connection, AC – via capacitor, GD – input grounded (signal disconnected).	㉚ TRIG. INP. (BNC connector)	Input for external trigger source.
⑫ Input attenuator Amplitude control (Multi-position rotary switch)	Selects the Y amplifier gain and indicates the scale factor of vertical display in V/cm and mV/cm.	㉛ SINGLE (pushbutton)	Selects single sweep operation.
⑬ CHI (II) BNC sockets and supplementary ground sockets	Signal input for Channel I (left) and Channel II or horizontal X-input (right). Input impedance: 1 M Ω 30 pF.	㉜ RESET (LED indicator)	Ready lamp to indicate that oscilloscope is armed for single sweep operation.
⑭ Amplitude variable control (Center Pot.)	For fine adjustment of vertical amplitude. Should normally be reset to CAL. position. Decreases Y sensitivity when turning counter- clockwise.	㉝ RESET (pushbutton switch)	Press to reset.
⑮ MAG x5 (push-pull switch)	Increases Y sensitivity by a factor of 5.	㉞ HOLD OFF (Pot.)	Fine adjustment of time interval between timebase sweeps.
⑯ INV.I (pushbutton switch)	Inverts display on Channel I	㉟ X-POS. (Control Pot.)	Adjusts horizontal position of trace.
⑰ CHI/II (pushbutton switch)	Selects channel to be displayed in MONO mode.	㊱ MAG. X10 (push-pull switch)	Trace magnifier – expands the X-axis by a factor of 10.
⑱ DUAL (pushbutton switch)	Selects single (MONO) or dual trace operation.	㊲ DELAY (8 position rotary switch)	Coarse adjustment of sweep delay time. Operative only during SEARCH and DELAY modes.
⑲ ADD/CHOP (pushbutton switch)	Selects alternate or chopped display in DUAL mode. In MONO mode, displays the sum of two signals. (DUAL switch has to be released).	㊳ DELAY (Center pot.)	20 turn helical pot. for fine adjustment of sweep delay time.
		㊴ DELAY – NORM, SEARCH, DELAY (3 position slide switch)	Selector switch for delay mode operation.
		㊵ DELAY (LED indicator)	Lamp will flash in SEARCH mode and is permanently illuminated in DELAY mode.
Controls located underneath the instrument			
		㊶ DC BALANCE	To adjust DC balance of the vertical (Y) preamplifiers

Test Instructions

General

These Test Instructions are intended as an aid for checking the most important characteristics of the HM204-2 at regular intervals without the need for expensive test equipment. Resulting corrections and readjustments inside the instrument, detected by the following tests, are described in the Service Instructions or on the Adjusting Plan. They should only be undertaken by qualified personnel.

As with the First Time Operation instructions, care should be taken that all knobs with arrows are set to their calibrated positions. None of the pushbuttons should be depressed. **LEVEL** knob depressed in **PEAK** position, **TRIG.** selector switch to **AC**, **DELAY** slide switch to **NORM.** It is recommended to switch on the instrument for about 15 minutes prior to the commencement of any check.

Cathode-Ray Tube: Brightness and Focus, Linearity, Raster Distortions

Normally, the CRT of the HM204-2 has very good brightness. Any reduction of this brightness can only be judged visually. However, decreased brightness may be the result of reduced high voltage. This is easily recognized by the greatly increased sensitivity of the vertical amplifier. The control range for maximum and minimum brightness (intensity) must be such that the beam just disappears before reaching the left hand stop of the **INTENS.** control (particularly when the **X-Y** button is depressed), while with the control at the right hand stop the focus and the line width are just acceptable.

With maximum intensity the timebase fly-back must on no account be visible. It should be noted that with wide variations in brightness, refocusing is always necessary. Moreover, with maximum brightness, no "pumping" of the display must occur. If pumping does occur, it is normally due to a fault in the regulation circuitry for the high voltage supply. The presetting pots for the high voltage circuit, minimum and maximum intensity, are only accessible inside the instrument (see Adjusting Plan and Service Instructions).

A certain out-of-focus condition in the edge zone of the screen must be accepted. It is limited by standards of the CRT manufacturer. The same is valid for tolerances of the orthogonality, the undeflected spot position, the non-linearity and the raster distortion in the marginal zone of the screen in accordance with international standards (see CRT data book). These limit values are strictly supervised by HAMEG. The selection of a cathode-ray tube without any tolerances is practically impossible.

Astigmatism Check

Check whether the horizontal and vertical sharpness of the display are equal. This is best seen by displaying a square-

wave signal with the repetition rate of approximately 1 MHz. Focus the horizontal tops of the square-wave signal at normal intensity, then check the sharpness of the vertical edges. If it is possible to improve this vertical sharpness by turning the **FOCUS** control, then an adjustment of the astigmatism control is necessary. An alternative method is to check the shape of the spot with both vertical inputs switched to **GD** position (and the **X-Y** pushbutton depressed); the **FOCUS** control is then repeatedly varied around the optimum focusing point. The shape of the spot (not its size), whether round or oval or rectangular, must stay the same to the right and left of the optimum focusing point. A potentiometer of 50 k Ω (see Adjusting Plan) is provided inside the instrument for the correction of astigmatism (see Service Instructions). A certain loss of marginal sharpness of the CRT is unavoidable; this is due to the manufacturing process of the CRT.

Symmetry and Drift of the Vertical Amplifier

Both of these characteristics are substantially determined by the input stages of the amplifiers. **The checking and correction of the DC balance for the amplifiers should be carried out as already described in the Operating Instructions.**

The symmetry of Channel I and the vertical final amplifier can be checked by inverting Channel I (depress **INV.I** pushbutton). The vertical position of the trace should not change by more than 5 mm. However, a change of 1 cm is just permissible. Larger deviations indicate that changes have occurred in the amplifier.

A further check of the vertical amplifier symmetry is possible by checking the control range of the **Y-POS.** controls. A sine-wave signal of 10-100 kHz is applied to the amplifier input. When the **Y-POS.** control is then turned fully in both directions from stop to stop with a display height of approximately **8 cm**, the upper and lower positions of the trace that are visible should be approximately of the same height. Differences of up to 1 cm are permissible (input coupling should be set to **AC**).

Checking the drift is relatively simple. **Ten minutes after switching on the instrument**, set the baseline exactly on the horizontal center line of the graticule. The beam position must not change by more than **5 mm** during the following hour. Larger deviations generally result from different characteristics of the dual FETs in both channel inputs to the Y amplifier. To some extent, fluctuations in drift are caused by offset current on the gate. The drift is too high, if the vertical trace position drifts by more than **0.5 mm** on turning the appropriate attenuator switch through all 12 steps. Sometimes such effects occur after long periods of operation.

Calibration of the Vertical Amplifier

Two square-wave voltages of 200mV_{pp} and $2\text{V}_{\text{pp}} \pm 1\%$ are present at the output sockets of the calibrator (**CAL.**). If a direct connection is made between the 200mV output and the input of the vertical amplifier, the displayed signal in the **50mV/cm** position (variable control to **CAL.**) should be **4cm** high (**DC** input coupling). Maximum deviations of 1.2mm (3%) are permissible. If a **X10 probe** is connected between the 2V-output socket and Y input, the same display height should result. With higher tolerances it should first be investigated whether the cause lies, within the amplifier or in the amplitude of the square-wave signal. On occasions it is possible that the probe is faulty or incorrectly compensated. If necessary the measuring amplifier can be calibrated with an accurately known DC voltage (**DC** input coupling). The trace position should then vary in accordance with the deflection coefficient set.

With variable control at the attenuator switch fully counter-clockwise, the input sensitivity is decreased at least by the factor 2.5 in each position. In the **50mV/cm** position, the displayed calibrator signal height should vary from 4cm to at least 1.6cm.

When pulling the Y-expansion x5 knob (**MAG x5**), the sensitivity is increased by the factor 5. In the **0.2mV/cm** position the displayed signal should change from 1cm to 5cm by pulling the **MAG x5** knob.

Transmission Performance of the Vertical Amplifier

The transient response and the delay distortion correction can only be checked with the aid of a square-wave generator with a fast risetime (**max. 5ns**). The signal coaxial cable (e.g. HZ34) must be terminated at the vertical input of the oscilloscope with a resistor equal to the characteristic impedance of the cable (e.g. with HZ22). Checks should be made at 100Hz, 1kHz, 10kHz, 100kHz and 1MHz, the deflection coefficient should be set at **5mV/cm** with **DC** input coupling (Y variable control in **CAL.** position). In so doing, the square pulses must have a flat top without ramp-off, spikes and glitches; no overshoot is permitted, especially at 1MHz and a display height of **4-5cm**. At the same time, the leading top corner of the pulse must not be rounded. In general, no great changes occur after the instrument has left the factory, and it is left to the operator's discretion whether this test is undertaken or not.

Of course, the quality of the transmission performance is not only dependent on the vertical amplifier. **The input attenuators**, located in the front of the amplifier, **are frequency-compensated in each position**. Even small capacitive changes can reduce the transmission performance. Faults of this kind are as a rule most easily detected

with a square-wave signal with a low repetition rate (e.g. 1kHz). If a suitable generator with max. output of 40V_{pp} is available, it is advisable to check at regular intervals the deflection coefficients on all positions of the input attenuators and readjust them as necessary. A compensated **2:1 series attenuator** is also necessary, and this must be matched to the input impedance of the oscilloscope. This attenuator can be made up locally. It is important that this attenuator is shielded. For local manufacture, the electrical components required are a $1\text{M}\Omega \pm 1\%$ resistor and, in parallel with it, a trimmer 3-15pF in parallel with approx. 20pF. One side of this parallel circuit is connected directly to the input connector of the vertical amplifier and the other side is connected to the generator, if possible via a low-capacitance coaxial cable. The series attenuator must be matched to the input impedance of the oscilloscope in the **5mV/cm** position (variable control to **CAL.**, **DC** input coupling; square tops exactly horizontal; no ramp-off is permitted). This is achieved by adjusting the trimmer located in the 2:1 attenuator. **The shape of the square-wave should then be the same in each input attenuator position.**

Operating Modes: CH.I/II, DUAL, ADD, CHOP., INV.I and X-Y Operation

On depressing the **DUAL** pushbutton, two traces must appear immediately. On actuation of the **Y-POS.** controls, the trace positions should have no effect on each other. Nevertheless, this cannot be entirely avoided, even in fully serviceable instruments. When one trace is shifted vertically across the entire screen, the position of the other trace must not vary by more than 0.5mm.

A criterion in chopped operation is trace widening and shadowing around and within the two traces in the upper or lower region of the screen. Set **TIME/DIV.** switch to **1 $\mu\text{s}/\text{cm}$** , depress the **DUAL** and **CHOP.** pushbutton, set input coupling of both channels to **GD** and advance the **INTENS.** control fully clockwise. Adjust **FOCUS** for a sharp display. With the **Y-POS.** controls shift one of the traces to a +2cm, the other to a -2cm vertical position from the horizontal center line of the graticule. Do not try to synchronize the chop frequency (1MHz)! Then alternately release and depress the **CHOP.** pushbutton. Check for negligible trace widening and periodic shadowing in the chopped mode.

It is important to note that in the **I+II** add mode (only **ADD** depressed) or the **-I+II** difference mode (**INV.I** button depressed in addition) the vertical position of the trace can be adjusted by using **both** the Channel I and Channel II **Y-POS.** controls. If a trace is not visible in either these modes, the overscanning LEDs will indicate the position of the trace.

In X-Y Operation (**X-Y** pushbutton depressed), the sensitivity in both deflection directions will be the same. When the

signal from the built-in square-wave generator is applied to the input of Channel II, then, as with Channel I in the vertical direction, there must be a horizontal deflection of **4 cm** when the deflection coefficient is set to **50 mV/cm** position (variable control set to its **CAL.** position, **MAG. X10** depressed). The check of the mono channel display with the **CHI/II** button is unnecessary; it is contained indirectly in the tests above stated.

Triggering Checks

The internal trigger threshold is important as it determines the display height from which a signal will be stably displayed. It should be approx. 3-5 mm (frequency-dependent) for the HM204-2. An increased trigger sensitivity creates the risk of response to the noise level in the trigger circuit, especially when the sensitivity of the vertical input is increased by pulling the **MAG. x5** knob. This can produce double-triggering with two out-of-phase traces. Alteration of the trigger threshold is only possible internally. Checks can be made with any **sine-wave voltage** between 50 Hz and 1 MHz. The **LEVEL** knob should be in depressed **PEAK** position. Following this it should be ascertained whether the same trigger sensitivity is also present with Normal Triggering (**LEVEL** knob pulled in **NORMAL** position). In both trigger modes, a **LEVEL** adjustment is necessary. The checks should show the same trigger threshold with the same frequency. On depressing the **SLOPE +/-** button, the start of the sweep changes from the positive-going to the negative-going edge of the trigger signal. As described in the Operating Instructions, the trigger frequency range is dependent on the trigger coupling selected. For higher frequencies the **HF** coupling mode must be selected. In this mode, triggering up to at least 50 MHz (sine-wave) is possible. Internally the HM204-2 should trigger perfectly at a display height of approx. 5 mm, when the appropriate trigger coupling mode is set.

For external triggering (**EXT.** button depressed), the **EXT. TRIG.** input connector requires a signal voltage of at least 50 mV_{pp} , which is in synchronism with the Y input signal. The voltage value is dependent on the frequency and the trigger coupling mode (**AC-DC-HF-LF**).

Checking of the internal TV triggering is possible with a video signal of any given polarity. In the **LF** position only, reliable triggering on **frame** frequency is possible. However, triggering on **line** (horizontal scanning) frequency requires **AC** (possibly **DC**) trigger coupling. If no video signal is available, the function of the **LF** position (low-pass filter) can be checked using mains/line frequency or the built-in calibrator signal. With a mains/line frequency signal (50-60 Hz), switching from **AC** to **LF** trigger coupling should have no effect. In contrast, the minimum signal voltage required for reliable triggering should be at least double, when the 1 kHz calibration signal is applied.

The display should not shift horizontally during a change of the trigger coupling from **AC** to **DC** with a sine-wave signal without DC offset. The basic requirement for this is a correct **DC Balance Adjustment** on the input of the vertical amplifier (see Operating Instructions, page M2).

In the **dual channel mode** (**DUAL** button depressed) **with alternate channel switching and with alternate triggering** (**ALT.** button in the X-Section depressed), two non-frequency related signals (e.g. mains/line frequency signal and calibrator signal) should reliably be triggered internally dependent on the positions of the **I/II** and the **ALT.** pushbuttons. In the dual channel mode with chop channel switching and depressed **ALT.** button, only triggering from Channel **I** should be possible. Periodical signal blanks (due to the chopper frequency 1 MHz) should not be visible.

If both vertical inputs are **AC** coupled to the same signal and both traces are brought to coincide exactly on the screen, when working in the **alternate dual channel mode**, then no change in display should be noticeable, when the **I/II** or the **ALT.** button are depressed or released.

Checking of the line/mains frequency triggering (50-60 Hz) is possible, when the input signal is time-related (multiple or submultiple) to the power line frequency (**TRIG.** selector switch to **LINE**). In this trigger mode, there is no trigger threshold. Even very small input signals are triggered stably (e.g. ripple voltage). For the check, use an input of approx. 1 V. The displayed signal height can then be varied by turning the respective input attenuator switch and its variable control.

Timebase

Before checking the timebase it should be ascertained that the **trace length is precisely 10 cm**. If not, it can be corrected with the potentiometer for sweep amplitude (see Adjusting Plan). This adjustment should be made with the **TIME/DIV.** switch in a mid position (i.e. **5 $\mu\text{s/cm}$**). Prior to the commencement of any check set the time variable control to **CAL.** and the **HOLD-OFF** time control to **X1**. The **MAG. X10** knob should be depressed. This condition should be maintained until the variation ranges of these controls are checked.

Check that the **sweep runs from the left to the right side of the screen** (**TIME/DIV.** switch to **0.5 s/cm**; **X-POS.** control in mid-range). This check is only necessary after changing the cathode-ray tube.

If a precise marker signal is not available for checking the **Timebase** time coefficients, then an accurate sine-wave generator may be used. Its frequency tolerance should not be greater than $\pm 1\%$. The timebase accuracy of the HM204-2 is given as $\pm 3\%$, but as a rule it is considerably

better than this. For the simultaneous checking of timebase linearity and accuracy at least 10 oscillations, i.e. **1 cycle every cm**, should always be displayed. For precise determination, set the peak of the first marker or cycle peak exactly behind the first vertical graticule line using the **X-POS.** control. Deviation tendencies can be noted after some of the marker or cycle peaks.

The **20** and **10 ms/cm** ranges of the **TIME/DIV.** switch can be checked very precisely with line frequency (**50Hz** only). On the **20 ms/cm** range a cycle will be displayed every cm, while on the **10 ms/cm** range it will be every 2 cm.

If a precise Time Mark Generator is used for checking, e.g. HZ62, Normal Triggering (**LEVEL** knob pulled) and **LEVEL** control adjustment is recommended.

The following table shows which frequencies are required for the particular ranges.

0.5 s/cm – 2 Hz	0.1 ms/cm – 10 kHz
0.2 s/cm – 5 Hz	50 μ s/cm – 20 kHz
0.1 s/cm – 10 Hz	20 μ s/cm – 50 kHz
50 ms/cm – 20 Hz	10 μ s/cm – 100 kHz
20 ms/cm – 50 Hz	5 μ s/cm – 200 kHz
10 ms/cm – 100 Hz	2 μ s/cm – 500 kHz
5 ms/cm – 200 Hz	1 μ s/cm – 1 MHz
2 ms/cm – 500 Hz	0.5 μ s/cm – 2 MHz
1 ms/cm – 1 kHz	0.2 μ s/cm – 5 MHz
0.5 ms/cm – 2 kHz	0.1 μ s/cm – 10 MHz
0.2 ms/cm – 5 kHz	

The **time variable control** range can also be checked. The sweep speed becomes slower by turning this variable control counter-clockwise to its left stop. 2.5 cycles at least every **cm** should be displayed (with **MAG. X10** button depressed; measurement in the **5 μ s/cm** range).

When the **MAG. X10** button is pulled, a marker or cycle peak will be displayed every 10 cm $\pm 5\%$ (with variable control in **CAL.** position; measurement in the **5 μ s/cm** range). The tolerance is better measurable in the **50 μ s/cm** range (one cycle every 1 cm).

Check the ramp output voltage on rear panel (BNC connector marked by a sawtooth symbol) with a Test Oscilloscope. **Test Scope setting: 1V/cm; Timebase** to one step slower sweep speed than on the HM 204-2 under test. The latter must have no input and no trigger voltage (free-running sweep; input coupling switch to **GD**). The sawtooth voltage is applied with a 50 Ω -BNC-BNC cable **without termination** from the ramp output connector to the input of the Test Scope. The Test Scope should show a positive-going linear sawtooth with an amplitude of approx. **5V_{pp}**. At the same time the function of the **HOLD-OFF** control **X1-**

X10 can be checked. The hold-off time variation cannot be measured precisely with this method, because the unblanking pulse of the timebase generator is smaller than the ramp width.

Sweep Delay

When the Sweep DELAY mode slide switch is set to the **NORM.** mode, the delay should have no effect on the display of the **1 kHz calibration signal**. When the Sweep Delay is set in the **SEARCH** mode (refer to Sweep Delay Operating Instructions), it is possible to check the delay time by means of a distance measurement of the blanked baseline. For this, the **DELAY VAR. 10:1** control must be set to x1 (rotate counterclockwise until a snap noise is audible). When **DELAY** mode is selected, the trace reverts to the full 10 cm display without any blanking.

Over the full range of adjustment of the DELAY VAR. 10:1 control, the displayed waveform of the calibration signal should be shifted without any jitter, jumping or intermittent blanking. Control settings: Connect calibrator socket (0.2V/1 kHz) to **CH.I** input connector, **DC** input coupling, deflection coefficient **50 mV/cm**, **TRIG.** selector switch to **AC**, time coefficient **1 ms/cm**, no pushbutton depressed, all controls in calibrated position, **DELAY** mode switch in **NORM.** position, **LEVEL** knob depressed in **PEAK** position. Now the calibrator signal is displayed with a signal height of 4 cm and approx. 1 cycle per cm. After switching to **SEARCH**, the mode indication lamp blinks. Set the **DELAY** range switch to **1 ms**. Rotate the **DELAY VAR.** control until the left half of the display is blanked. The delay time is now **5 ms**. After switching to **DELAY**, the display is again fully visible. The **DELAY** mode indication shows continuously. The displayed signal can now be expanded. To this purpose turn the **TIME/DIV.** switch clockwise to **5 μ s/cm**. The expansion is now x200. With the **DELAY VAR.** control, the nearest edge of the calibration signal can be brought in the screen center and checked on the above-mentioned criteria. With x200 expansion, the display brightness normally needs increasing (with **INTENS.** and **FOCUS** control). However, larger expansion than x200 is quite possible, but the decrease of brightness and the jitter restricts the evaluation.

Component Tester

After pressing the **CT** button, a horizontal straight line has to appear immediately when the **CT** socket is open. The length of this trace should be approx. **8 cm**. With connection of the **CT** socket to one of the ground jacks in the Y-Section, a vertical straight line with approx. 6 cm height should be displayed. The above stated measurements have some tolerances. They are dependent among other things on the mains/line voltage.

Trace Alignment

The CRT has an admissible angular deviation $\pm 5^\circ$ between the X deflection plane D1-D2 and the horizontal center line of the internal graticule. This deviation, due to tube production tolerances (and only important after changing the CRT), and also the influence of the earth's magnetic field, which is dependent on the instrument's North orientation, are corrected by means of the **TR** potentiometer. In general, the trace rotation range is asymmetric. It should be checked, whether the baseline can be adjusted somewhat sloping **to both sides** round about the horizontal center line of the graticule. With the HM 204-2 in its closed case, an angle of rotation $\pm 0.57^\circ$ (1 mm difference in elevation per 10 cm graticule length) is sufficient for the compensation of the earth's magnetic field.

Miscellaneous

Checking the blanking facility on the **Z** modulation connector (rear panel) is possible with a sine- or square-wave generator, which must have a relatively low output impedance (max. $600\ \Omega$, max. $5V_{pp}$). The sine-wave generator requires an output voltage control. The square-wave generator must deliver positive pulses to ground (chassis). Alternatively a small adjustable sine voltage from a (separate) power transformer may be used. For the latter set the **TIME/DIV.** range to e.g. **10 ms/cm**. With the TIMEBASE variable control, the gap in the baseline can be brought acceptably to a standstill. Better is line frequency triggering (**TRIG.** selector switch to **LINE**). The length ratio from bright to dark lines on the display is dependent on the sine voltage amplitude. Without a modulating generator, the function of the Z modulation can be checked coarsely by short-circuiting the **Z** connector. Then the baseline is blanked fully.

A check of the **Y** output (rear panel) is possible on the screen using the dual channel mode by means of the calibrator signal. To this a connection is made from the calibrator socket ($0.2V/1\text{ kHz}$) to the **CH.I** input connector and – using a BNC-BNC cable and a $50\ \Omega$ through-termination – a second connection from the **Y** output to **CH.II** input connector. **Settings:** **CH.I** attenuator switch to **50 mV/cm**, **CH.II** attenuator switch to **0.1 V/cm**, **CH.I** input coupling to **DC**, **CH.II** input coupling to **GD**, **TIME/DIV.** switch to **0.5 ms/cm**, automatic triggering (**LEVEL** knob depressed to **PEAK**), **TRIG.** selector to **AC**, no button depressed. Now the square-wave signal is visible with **4 cm** display height. With **Y-POS.I** control, the tops of the square-wave are adjusted to $\pm 2\text{ cm}$ from the horizontal center line of the graticule. Then the **DUAL** button has to be pressed. The appearing second trace (without signal) is adjusted to -2 cm using the **Y-POS.II** control. Then the **CH.II** input coupling is set to **DC**. Now the signal across the **Y** output appears with the same phase position as the calibrator signal via Channel I. As well as the DC offset (e.g. $+0.8\text{ cm} \triangleq +80\text{ mV}$) the amplitude

(e.g. $1.6\text{ cm} \triangleq 0.16V_{pp}$) of the **Y** output can be measured. In the example, the sensitivity of the **Y** output can be calculated as $0.16V:4\text{ cm} = \mathbf{40\text{ mV/cm}}$.

If a variable mains/line transformer is available, the characteristics of the HM 204-2 on power voltage fluctuations of $\pm 10\%$, referred to the voltage indicated by a triangle above the fuse holder (rear panel), should be checked. Under these conditions no variations should be detected on the display in either the vertical or horizontal axis.

Service Instructions

General

The following instructions are intended as an aid for the electronic technician, who is carrying out readjustments on the HM204-2, if the nominal values do not meet the specifications. These instructions primarily refer to those faults, which were found after using the Test Instructions. However, this work should only be carried out by properly qualified personnel. For any further technical information call or write to HAMEG. Addresses are provided at the back of the manual. It is recommended to use only the original packing material, should the instrument be shipped to HAMEG for service or repair (see also Warranty, page M2).

Instrument Case Removal

The rear cover can be taken off after unplugging the power cord's triple-contact connector and after two cross recessed pan head screws (M4x30mm) with two washers on it have been removed. While the instrument case is firmly held, the entire chassis with its front panel can be withdrawn forward. When the chassis is inserted into the case later on, it should be noticed that the case has to fit under the flange of the front panel. The same applies for the rear of the case, on which the rear cover is put.

Caution

During opening or closing of the case, the instrument must be disconnected from all power sources for maintenance work or a change of parts or components. If a measurement, trouble-shooting, or an adjustment is unavoidable, this work must be done by a specialist, who is familiar with the risk involved.

When the instrument is set into operation after the case has been removed, attention must be paid to the acceleration voltage for the CRT – 2000V – and to the operating voltages for both final amplifier stages – together 220V. Potentials of these voltages are on the CRT socket, on the upper and the lower horizontal PCBs, and on the lateral PCB directly beside the CRT neck. High voltages of max. 2000V are also at the INTENS. and FOCUS potentiometers (lower left corner on the rear of the front chassis). Such potentials are moreover on the checkpoint strips on the upper and the lower PCB (7- and 5-pole). They are highly dangerous and therefore precautions must be taken. It should be noted furthermore that shorts occurring on different points of the CRT high voltage and unblanking circuitry will definitely damage some semiconductors and the opto-coupler. For the same reason it is very risky to connect capacitors to these points while the instrument is on.

Capacitors in the instrument may still be charged, even when the instrument is disconnected from all voltage

sources. Normally, the capacitors are discharged 6 seconds after switching off. However, with a defective instrument an interruption of the load is not impossible. Therefore, after switching off, it is recommended to connect one by one all terminals of the check strips on the upper and the lower PCBs across 1k Ω to ground (chassis) for a period of 1 second.

Handling of the CRT needs utmost caution. The glass bulb must not be allowed – under any circumstances – to come into contact with hardened tools, nor should it undergo local superheating (e.g. by soldering iron) or local undercooling (e.g. by cryogenic-spray). We recommend the wearing of safety goggles (implosion danger).

Operating Voltages

Besides the two AC voltages for the CRT heating (6.3V) and graticule illumination, Component Tester and line triggering (12V) there are seven electronically regulated DC operating voltages generated (+12V, +5V, –12V, +140V, +220V, –1900V, and 22V for the unblanking circuit). These different operating voltages are fixed voltages, except the +140V (vertical final stage) and the high voltage, which can be adjusted. The variation of the fixed voltages greater than $\pm 5\%$ from the nominal value indicates a fault. Both adjustable voltages have to be set precisely for +140V and –1900V respectively by the adjustments of two potentiometers 2.5k Ω and 25k Ω . These voltages are measured on the checkpoint strip with reference to ground (see Adjusting Plan). Measurements of the high voltage may only be accomplished by the use of a sufficient highly resistive voltmeter ($>10\text{M}\Omega$). You must make absolutely sure that the electric strength of the voltmeter is sufficiently high. The 22V for the unblanking circuit can be measured as the difference between two high voltages with reference to ground. It is recommended to check the ripple and also the interaction from other possible sources. Excessive values might be very often the reason for incomprehensible faults.

Maximum and Minimum Brightness

Two variable resistors of 500k Ω each, located on the Z-PCB, are used for these adjustment procedures (see Adjusting Plan). They may only be touched by a properly insulating screwdriver (Caution! High voltage!). The adjustments may possibly have to be repeated, because the functions of both variable resistors are dependent on each other. Correct adjustment is achieved, when the trace can be blanked while **X-Y** pushbutton is depressed and, in addition, when the requirement described in the Test Instructions are met.

Astigmatism control

The ratio of vertical and horizontal sharpness can be adjusted by the variable resistor of 50k Ω , located on the Z-PCB (see Adjusting Plan). As a precaution however, the voltage for the vertical deflecting plates (approx. +85V) should firstly be checked, because this voltage will affect the astigmatism correction. While the adjustment is being carried out (with pressed **X-Y** button and medium brightness), the **FOCUS** control knob has to be repeatedly turned to and fro until the shape of the luminous spot, whether round or oval or rectangular, stays the same to the right and left of the optimum focusing. The interaction of focus adjustment and astigmatism correction should be noted. After this adjustment, a square-wave should be displayed and verified once more in accordance with the Test Instructions. The final adjustment has always to be the **FOCUS** control.

Trigger Threshold

The internal trigger threshold should be in the range 3 to 5 mm display height. It is strongly dependent on the NE 529 comparator IC. If there are compelling reasons to replace this comparator, it may be that triggering becomes too sensitive or too insensitive caused by the IC gain tolerances (see Test Instructions: "Triggering Checks", page T3). The 3.9k Ω resistor across pin 4 and 9 has to be changed then by replacing or possibly by parallel connection of a second resistor. The appropriate value should be tried out. Generally, the optimum value should be between 3k Ω and 4.7k Ω .

Trouble-Shooting the Instrument

For this job, at least an isolating variable mains/line transformer (protection class II), a signal generator, an adequate precise multimeter, and, if possible, an oscilloscope are needed. This last item is required for complex faults, which can be traced by the display of signal or ripple voltages. As noted before, the regulated high voltage and the supply voltage for the final stages (approx. 220V) are highly dangerous. Therefore it is recommended to use **totally insulated extended probe tips**, when trouble-shooting the instrument. Accidental contact with dangerous voltage potentials is then unlikely. Of course, these instructions cannot thoroughly cover all kinds of faults. Some common-sense will certainly be required, when a complex fault has to be investigated.

If trouble is suspected, visually inspect the instrument thoroughly after removal of the case. Look for loose or badly contacted or discolored components (caused by overheating). Check to see that all circuit board connections are making good contact and are not shorting to an adjacent circuit. Especially inspect the connections between the PCBs, to the power transformer, to front chassis parts, to CRT sock-

et, to trace rotation coil (inside of CRT's shielding), to the 3 BNC connectors at the rear chassis, and to the control potentiometers and switches on top of and beneath both main-PCBs. Furthermore, the soldering connections of the transistors and Fixed Three-Terminal Regulators resp. on the rear chassis. This visual inspection can lead to success much more quickly than a systematic fault location using measuring instruments. Prior to any extensive trouble-shooting, also check the external power source.

If the instrument fails completely, the first and most important step – **after checking the mains/line voltage and power fuse** – will be to measure the deflecting plate voltages of the CRT. In almost any case, the faulty section can be located. The sections represent:

1. Vertical deflection.
2. Horizontal Deflection.
3. CRT circuit.
4. Power supply.

While the measurement takes place, the position controls of both deflection devices must be in mid-position. When the deflection devices are operating properly, the separate voltages of each plate pair are almost equal then (Y \approx 85V and X \approx 105V). If the separate voltages of a plate pair are very different, the associated circuit must be faulty. An absent trace in spite of correct plate voltages means a fault in the CRT circuit. Missing deflection plate voltages is probably caused by a defect in the power supply.

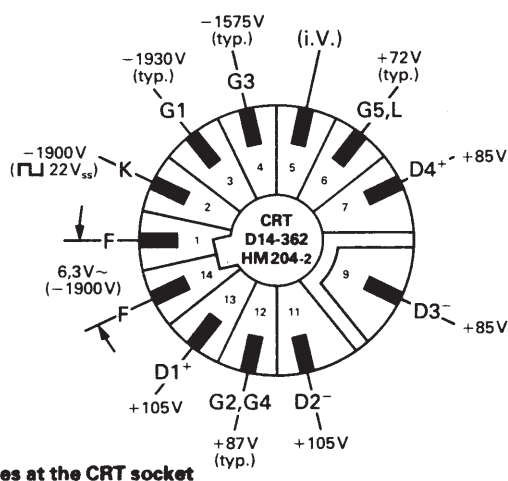

Voltages at the CRT socket

Replacement of Components and Parts

For the replacement of parts and components use only parts of the same or equivalent type. Resistors without specific data in the diagrams have a power dissipation of 0.25Watt and a tolerance of 2%. Resistors in the high voltage circuit must have sufficient electric strength. Capacitors without a voltage value must be rated for an operating voltage of 63V. The capacitance tolerance should not exceed 20%. Many semiconductors are selected, especially the gate-diodes 1N4154, and all amplifier transistors, which are contained in push-pull circuits (including the

FETs). If a selected semiconductor is defective, all gate-diodes or both push-pull transistors of a stage should be replaced by selected components, because otherwise there are possibly deviations of the specified data or functions. The HAMEG Service Department can give you advice for troubleshooting and replaceable parts. Replacement parts can be ordered by letter or telephone from the nearest HAMEG Service Office. Please supply the following information: Instrument type and serial number, description of the part (including function and location in the instrument), quantity desired.

Replacement of the Power Transformer

Should it be necessary to replace the mains/line transformer, the correct terminal sequence (color identification) for primary and secondary windings must be followed (see diagram "Power Supply" and the figure below). In addition, the relevant Safety Regulations must be observed. Here, we refer only to those requirements relative to the parts conductively connected to the supply mains:

- The construction of the instrument shall be such as to prevent any short-circuiting or bridging of the insulation, clearances or creepage distances between those parts connected to the supply mains and any accessible conductive parts due to accidental loosening or freeing of the wiring, screws, etc.
- The rigidity of the mains wiring connections, which may be subject to mechanical stresses, shall not be dependent upon the soldering alone. To meet this requirement, the bare ends of the wires must be pushed through the holes in the respective soldering tab, bent over with a pair of pliers, and subsequently fixed by soldering.
- The minimum cross section of the protective earth connection between the instrument's power inlet and the connecting soldering tab on the rear chassis must be 0.81 mm² in North America and 0.75 mm² in Western Europe. The connecting soldering tab on the rear chassis has to be secured mechanically against loosening (e.g. with lock washer).

After replacing the power transformer, all remaining bits of wire, solder and other foreign matter must be removed from the PCBs, the vicinity of the power transformer and from within the insulating connecting box by shaking, brushing and blowing. Finally, the top plate of the insulating connecting box has to be replaced. Before connecting the instrument to the power supply, replace the possibly defective fuse, press the **POWER** button and make sure that there is an adequate insulation state between chassis (= safety earth conductor) on the one hand, and the live/line pin as well as the neutral pin, on the other. Only after proper insulation has been established may further function tests with open chassis follow, but with appropriate precautionary measures.

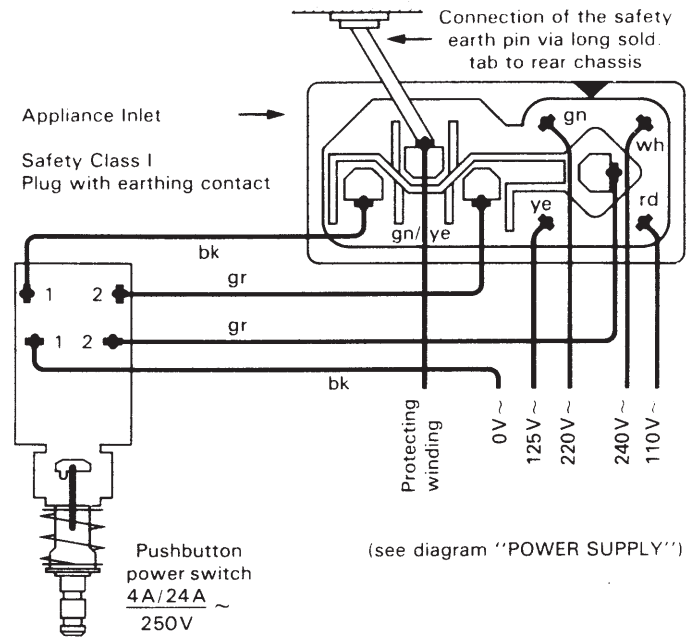

Rear View of Power Switch and Appliance Inlet with Voltage Selector and Fuse

Adjustments

As advised in the Operating, Test and Service Instructions, small corrections and adjustments are easily carried out with the aid of the Circuit Diagrams and **Adjusting Plan**. However, a complete recalibration of the scope should not be attempted by an inexperienced operator, but only someone with sufficient expertise. Several precision measuring instruments with cables and adapters are required, and only then should the pots and trimmers be readjusted, provided that the result of each adjustment can be exactly determined. Thus for each operating mode and switch position, a signal with the appropriate sine or square waveform, frequency, amplitude, risetime and duty cycle is required.

Bezeichnung der Bauteile

Die elektrischen Bauteile sind so gekennzeichnet, daß die erste Nummer mit der Baugruppen-Nummer übereinstimmt:

- 0.. Chassis**
Y-Eingang, ext. Triggereingang, Spule für Strahlidrehung, Geräterestecker, Netzschalter, Netztransformator usw.
- 1.. EY-Board I + II**
Eingangsteiler, Y-Vorverstärker (Kanal I + II).
- 2.. Y-Board**
Y-Zwischenverstärker, Kanalschaltungs-Flip-Flop, Dioden Schaltung, Chopper-Generator, Niederspannungsvorsorgung, Testleiste (Pkt. 6-12).
- 3.. TB-Board**
Triggerschaltung, Zeitbasis, Ablenkverzögerung, Hold-off Schaltung, X-Endverstärker, Hellkastung
- 4.. Calibrator Board**
- 5.. YF-Board**
Y-Endverstärker, Overscan (Bereichsüberschreitung)
- 6.. Z-Board**
Beschaltung der Kathodenstrahlröhre, Rücklaufaustastung, Hochspannungs-Netzteil, Testleiste (Pkt. 1-5)
- 7.. DEL-Board**
Pot. für horizontale Strahlage, Schalter für Ablenkverzögerung
- 8.. TR-Board**
LED-Anzeigen, Potentiometer für Strahlidrehung
- 9.. CRT-Board**

TB-Board

P2-3/1

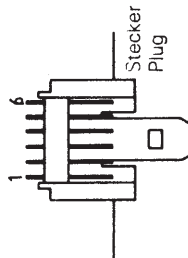

Buchse
Socket

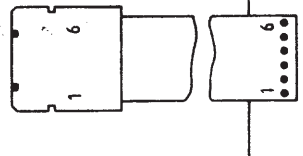

Y-Board

W2-3/1

HM204-2

Electrical components on certain parts of the oscilloscope are marked such that the first numeral is on:

- 0.. Chassis**
Y-inputs, Trig. ext. input, Trace rotation coil, Appliance inlet, Power switch, Power transformer.
- 1.. EY-Board I + II**
Attenuator and Preamplifier CH.I + II.
- 2.. Y-Board**
Y-intermediate amplifier CH.I + II, Channel selection flip-flop, Y-gate driver stages, Chopper generator, Trig. gate driver stages, LV-Power, Check point strip 6-12
- 3.. Timebase Board (TB-Board)**
Trigger circuit, Timebase circuit, Unblanking circuit, Delay circuit, Hold-off circuit, X-Final amplifier
- 4.. CAL-Board**
- 5.. YF-Board**
Y-Final amplifier, overscan circuit
- 6.. Z-Board**
CRT-Circuit, Unblanking, HV-supply, Check-point strip 1-5
- 7.. DEL-Board**
X-pos. pot., Delay Mode switch
- 8.. TR-Board**
LED-indicators, TR-pot.
- 9.. CRT-Board**

Widerstand- / Resistor identification

- Widerstand / Resistor 0.25W 2% (carbon film)
- Widerstand / Resistor 0.25W 1% tc = 50 · 10⁻⁶/K (metal film)
- Widerstand / Resistor 0.25W 0.5% tc = 50 · 10⁻⁶/K (metal film)
- Widerstand / Resistor 0.5W 2% (carbon film)
- Widerstand / Resistor 4W 2% tc = 400 · 10⁻⁶/K (metal oxide film)

Beispiel: P2-3/1-5 bzw. W2-3/1-5

- P = Flachkabelstecker (auf Board,)
- W = Flachkabelverbindung: eine Seite verlötet, andere Seite Buchsenleiste
- 2-3 = Verbindung zwischen Board 2 und Board 3
- 1 = 1. Flachkabelverbindung zwischen Board 2 und 3
- 5 = Draht-Nummer des Flachkabels

Example: P2-3/1-5 or W2-3/1-5 respectively

- P = Flat cable plug (soldered on board)
- W = Flat cable wiring (directly soldered on board) with socket (movable)
- 2-3 = Connection between Board 2 (Y-Board) and Board 3 (TB-Board)
- 1 = First flat cable connection between Board 2 and 3
- 5 = Serial number of the wire (in the flat cable)

Identification of electrical components

Abkürzungen / Abbreviations

- Al... Geräterestecker / Appliance inlet
- BR... Brückengleichrichter / Bridge rectifier
- C... Kondensator / Capacitor
- ChP... Testpunkt / Check point
- CN... Steckverbinder / Connector
- CRT... Kathodenstrahlröhre / Cathode-ray tube
- D... Diode
- E... Lotöse / Eyelet
- F... Sicherung / Fuse
- IC... Integr. Schaltung / Integrated Circuit
- L... Spule, Drossel / Inductor, Coil
- LED... Leuchtdiode / Light emitting diode
- NTC... NTC-Widerstand / NTC resistor
- P... Stecker / Plug
- R... Widerstand / Resistor
- S... Schalter / Switch
- T... Transistor
- TR... Transformator / Transformer
- VC... Trimmkondensator / Variable capacitor
- VR... Potentiometer / Variable resistor
- VVC... Kapazitätsdiode / Voltage variable capacitor
- W... Draht / Wire
- Z... Zenerdiode / Z-Diode

Testleisten Check strip

Y-Board

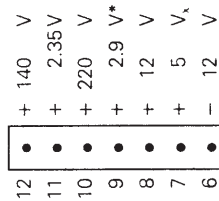

* gegen -12V gemessen
-12V antipole

Z-Board

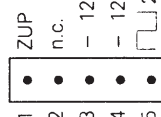

Farbkenzeichnung der Anschlußdrähte / Color-Abbreviations for insulated wire

- bk = schwarz / black
- bn = braun / brown
- rd = rot / red
- or = orange / orange
- ye = gelb / yellow
- gn = grün / green
- bl = blau / blue
- vi = violett / violet
- gr = grau / grey
- wh = weiß / white
- trp = transparent / transparent
- gn/ye = grün-gelb / green-yellow
- gn/yellow stripe = grün-gelb / green-yellow stripe

Anschlußfolge der Transistoren	BC 237 B	BC 550 C	BC 557 B	BC 547 C	BF 199	BF 422	BF 423	BF 458	BF 459	BUX 86/87	BD 232	BSX 19	U 440	78XXCU
Terminals of Transistors	E C B	E C B	E C B	E C B	E C B	E C B	E C B	B C E	B C E	E C B	E C B	E C B	G1 S2 D1 D2 S1 LG2	D1 D2 G2 L S1
Ansicht von unten Bottom View	E C B	E C B	E C B	E C B	E C B	E C B	E C B	B C E	B C E	E C B	E C B	E C B	G1 S2 D1 D2 S1 LG2	D1 D2 G2 L S1
Ansicht von oben Top View	E C B	E C B	E C B	E C B	E C B	E C B	E C B	E C B	E C B	E C B	E C B	E C B	G1 S2 D1 D2 S1 LG2	D1 D2 G2 L S1

BESTÜCKUNGSPLAN, Y-BOARD COMPONENT LOCATIONS, Y-BOARD

② HM204-2

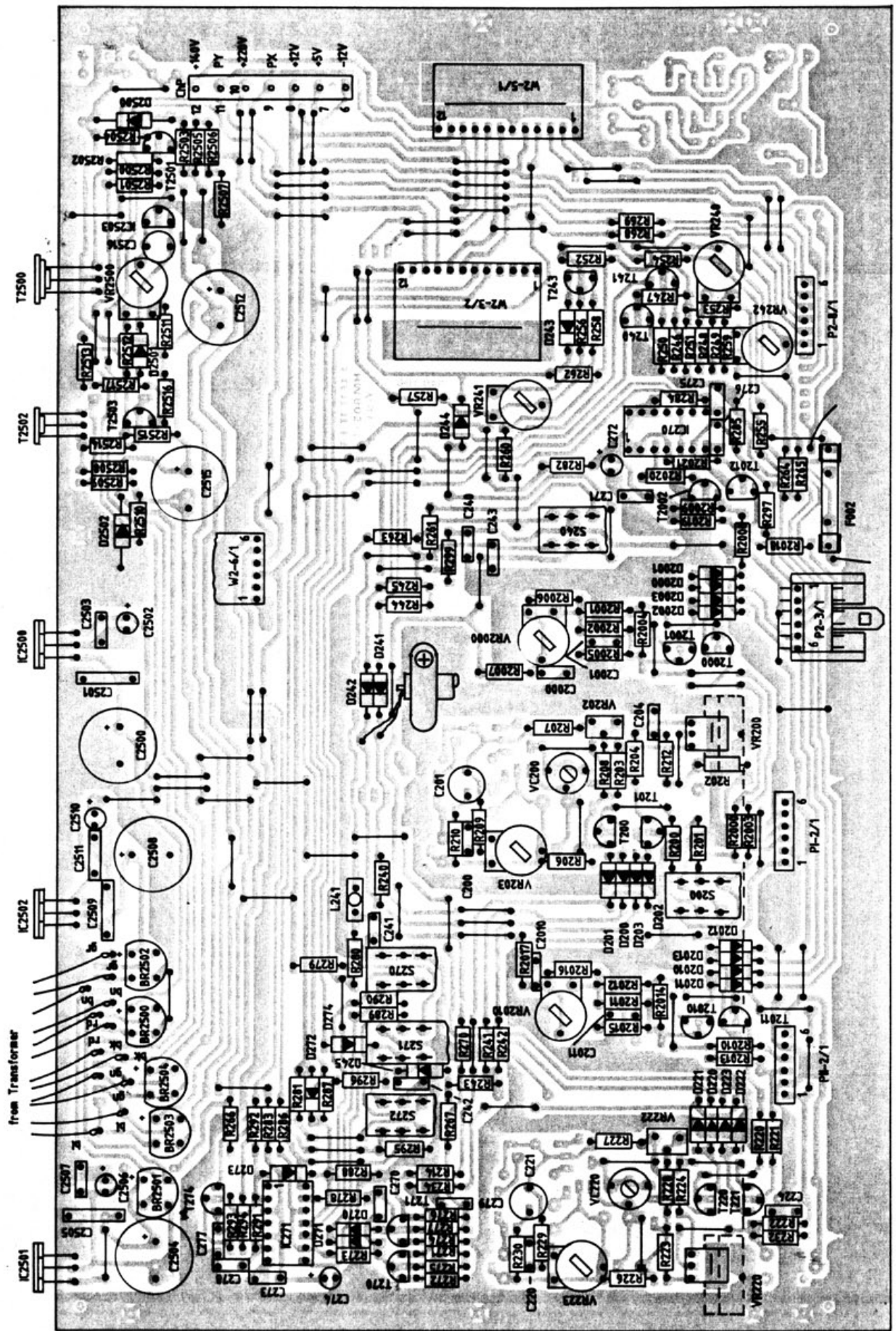

Y-ENDVERSTÄRKER, OVERSCAN-SCHALTUNG Y-FINAL AMPLIFIER, OVERSCAN CIRCUIT

⑤ HM204-2

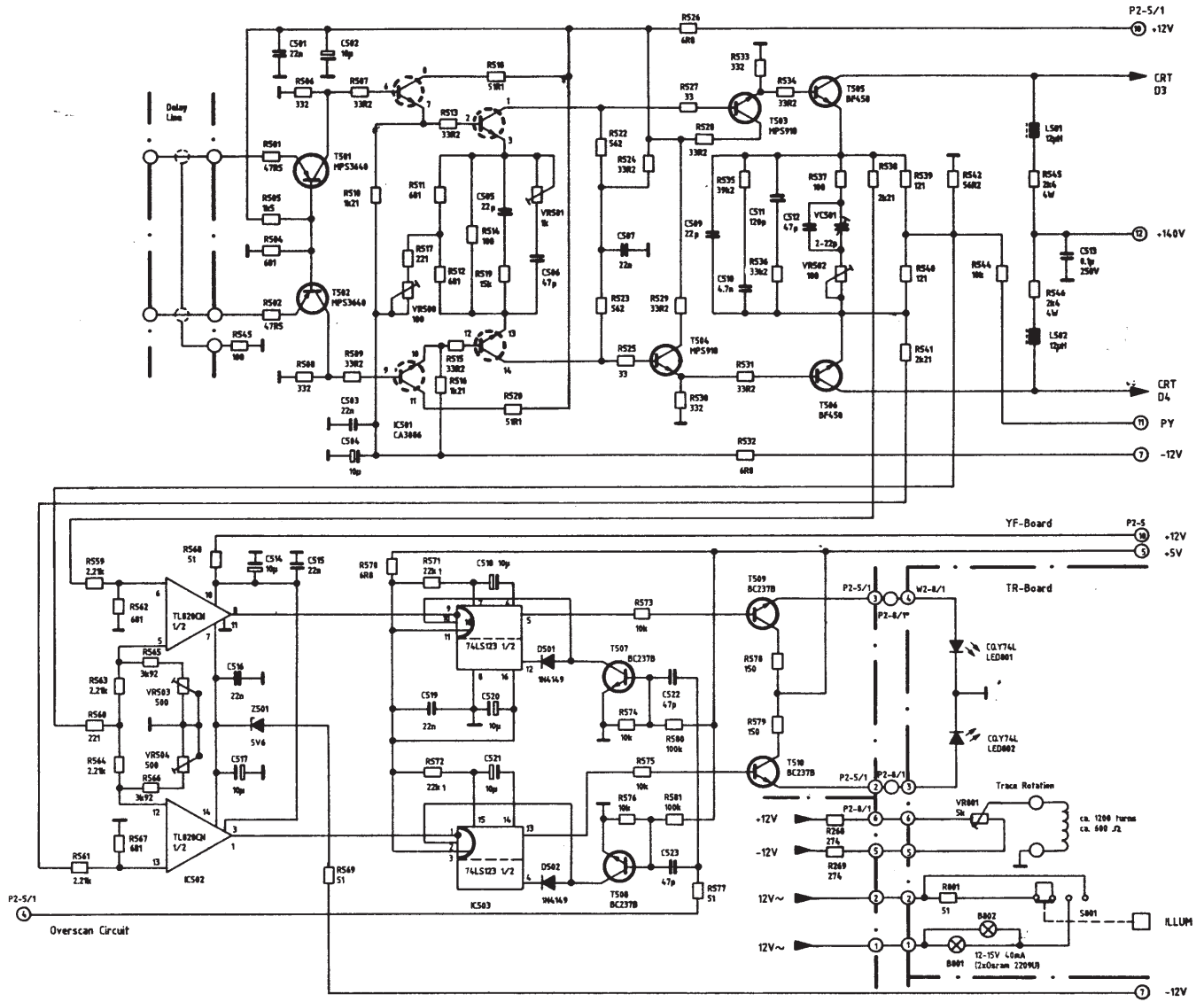

BESTÜCKUNGSPLAN/ COMPONENT LOCATIONS YF-BOARD YF-BOARD ⑤

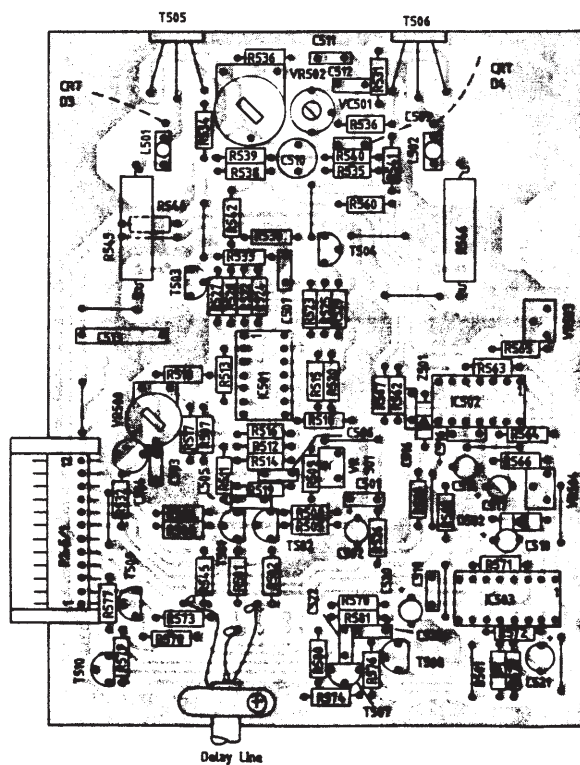

TRIGGER-SCHALTUNG, ABLENKVERZÖGERUNG TRIGGER CIRCUIT, DELAY CIRCUIT

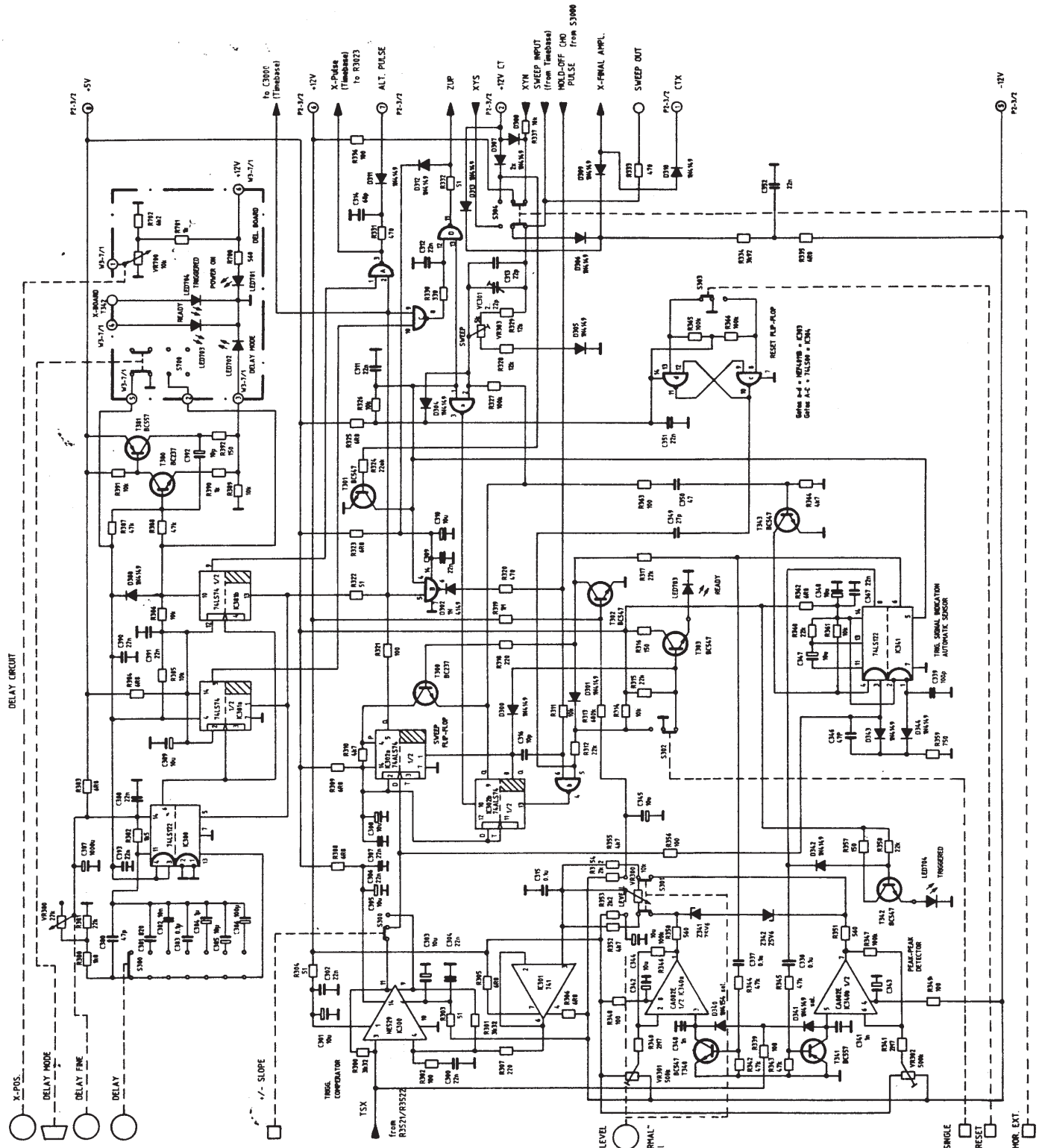

DELAY CIRCUIT

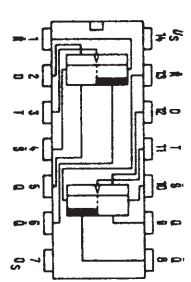

74LS74

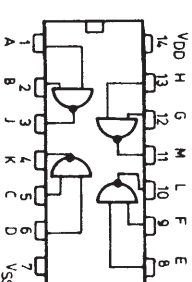

HEF4011

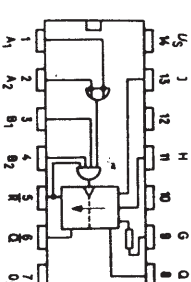

74LS122

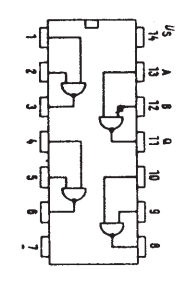

74LS00

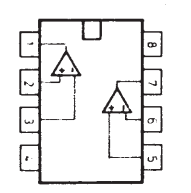

CA082

ZEITBASIS, HOLD-OFF-SCHALTUNG, TRIGGER- UND EXT. X-VERSTÄRKER, X-ENDVERSTÄRKER
TIMEBASE CIRCUIT, HOLD-OFF CIRCUIT, TRIG. AND X-SIGNAL AMPLIFIER, X-FINAL AMPLIFIER

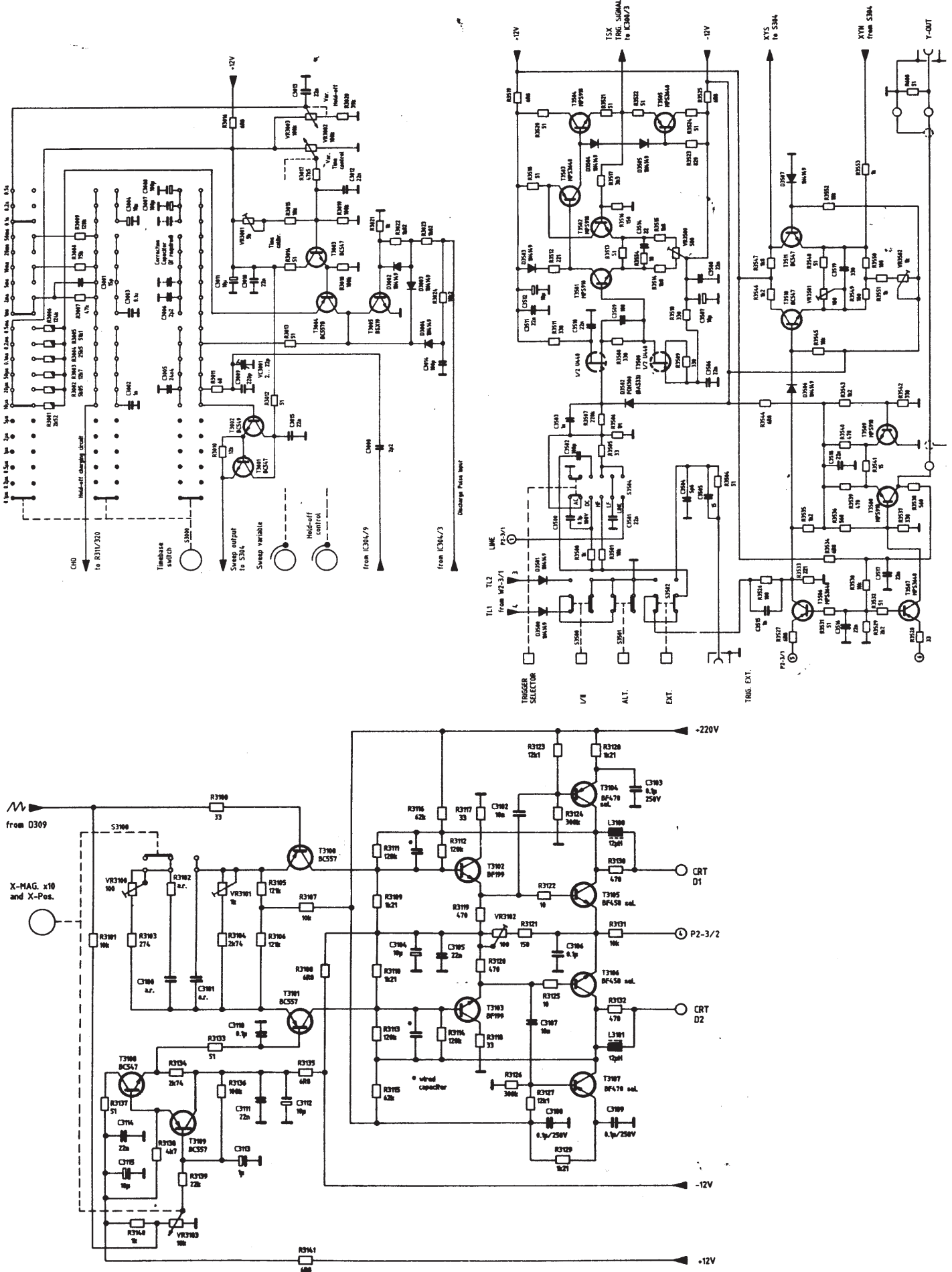

**BESTÜCKUNGSPLAN, TB-BOARD
COMPONENT LOCATIONS TB-BOARD**

③ HM204-2

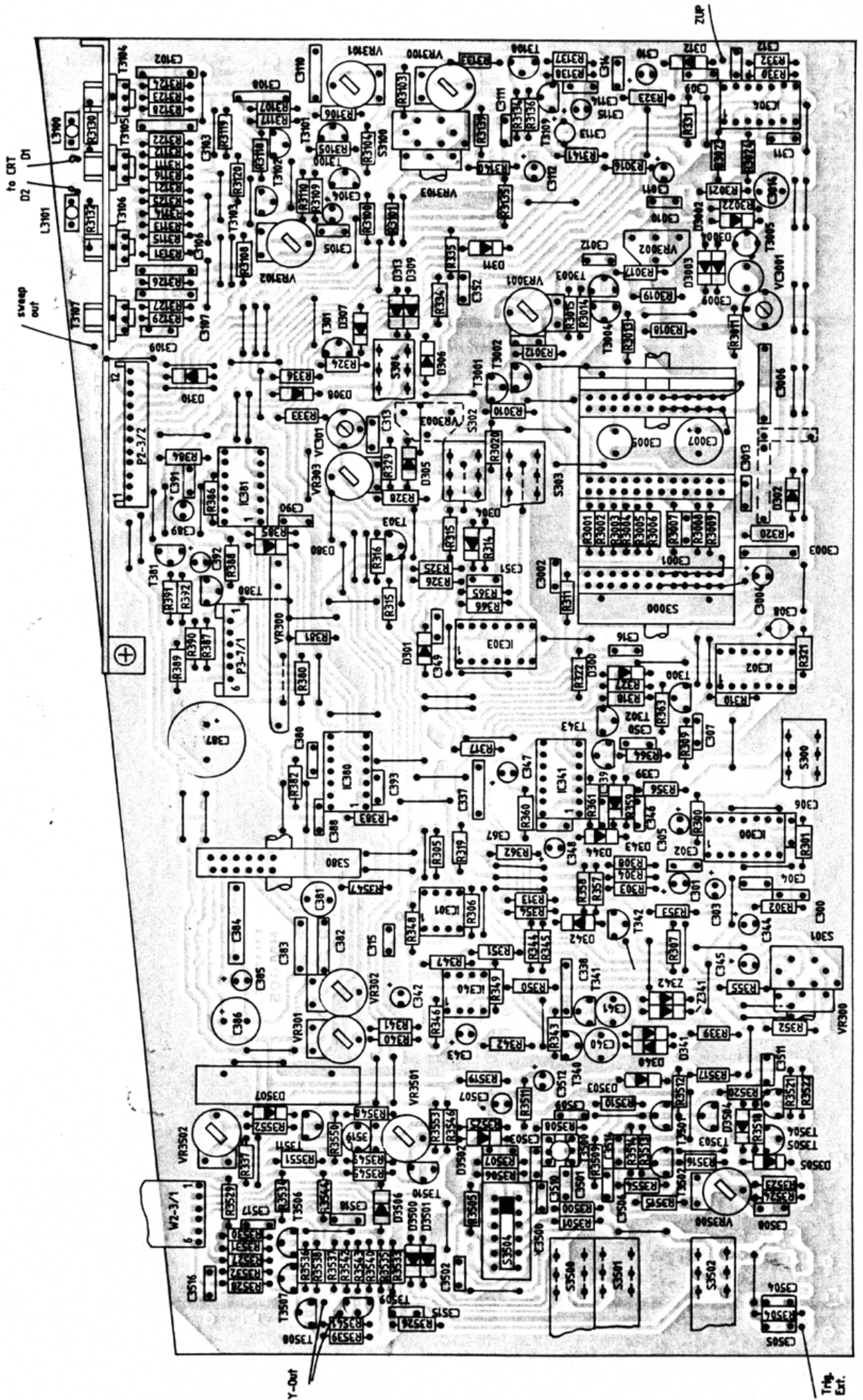

KATHODENSTRAHLRÖHRE, HELLTASTUNG CRT-CIRCUIT, UNBLANKING CIRCUIT

⑥ HM204-2

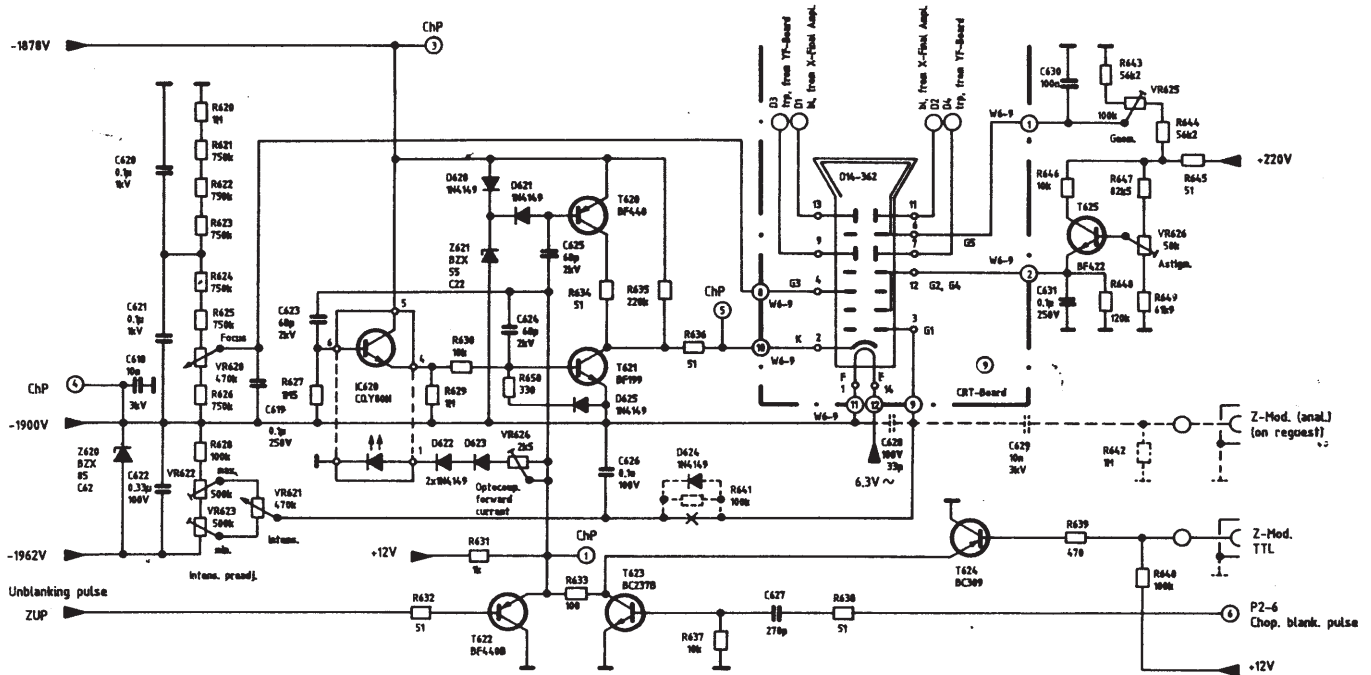

NETZTEIL POWER SUPPLY

② HM204-2

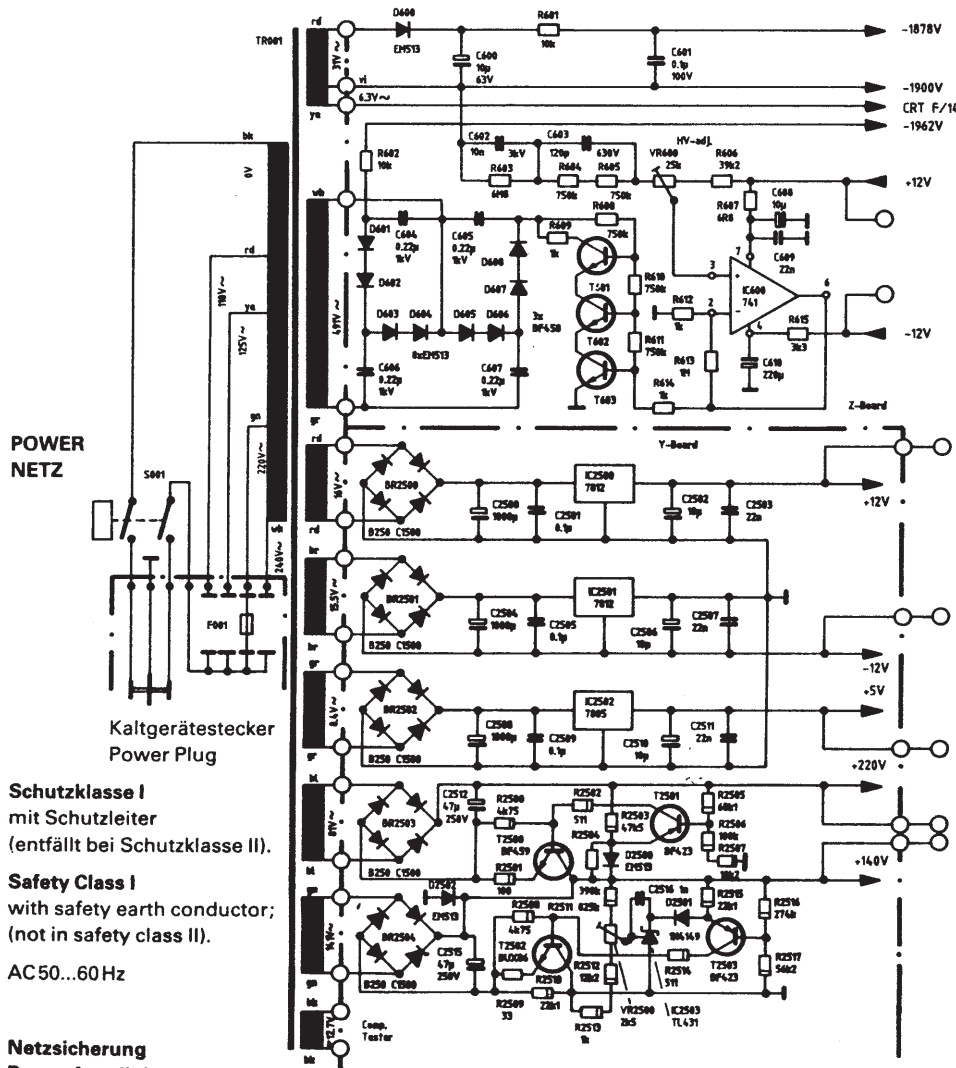

Gleichspannungen zu Verbindung DC-Voltages to connection

+ 12V	- ChP ⑧	W2-3/2 ⑦
	W2-5/1 ⑩	W2-6/1 ⑤
	WI/II-2/1 ①	
- 12V	- ChP ⑥	W2-3/2 ⑧
	W2-5/1 ⑦	W2-6/1 ③
	WI/II-2/1 ⑥	
+ 5V	- ChP ⑦	W2-3/2 ⑤
	W2-5/1 ⑤	
+ 140V	- ChP ⑫	W2-5/1 ⑫
+ 220V	- ChP ⑩	W2-3/2 ⑩
	W2-6/1 ④	

POWER NETZ

Kaltgerätestecker
Power Plug

Schutzklasse I
mit Schutzleiter
(entfällt bei Schutzklasse II).

Safety Class I
with safety earth conductor;
(not in safety class II).

AC50...60Hz

Netzversicherung
Power fuse links

Type: IEC 127-III	110V	} T 0.63 A	5 x 20 mm, träge;	max. Leistung: 41W bei 220V/50Hz.
DIN 41662	125V			
SEV 1064	220V	} T 0.315 A	5 x 20 mm, time lag.	WATTS (max.): 41 at 220V 50Hz.
BS 4265	240V			

CALIBRATOR – BESTÜCKUNGSPLÄNE: Z-BOARD, TR-BOARD, DELAY-BOARD HM204-2
CALIBRATOR – COMPONENT-LOCATIONS: Z-BOARD, TR-BOARD, DELAY-BOARD

⑥ Z-BOARD

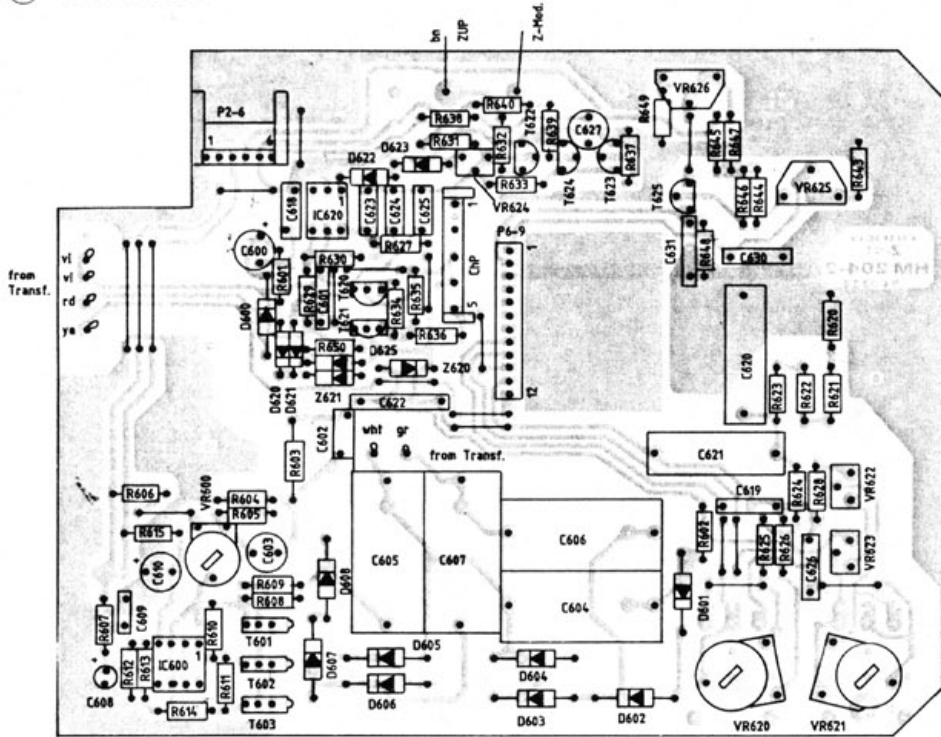

CRT-BOARD ⑨

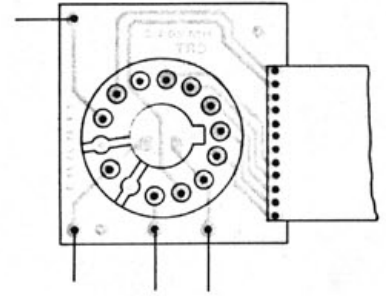

⑧ TR-BOARD

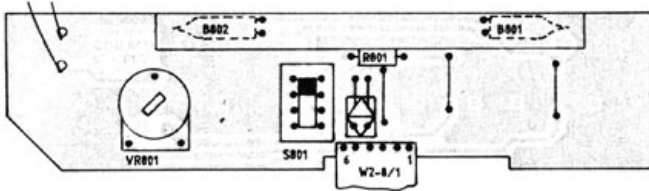

⑦ DELAY-BBOARD

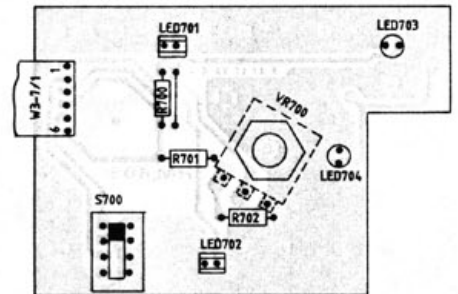

④ CAL.-BOARD

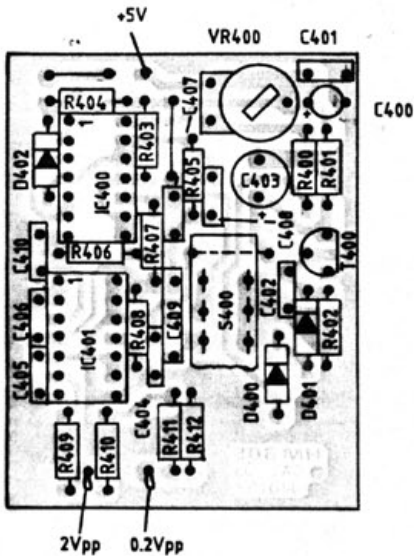

④ CALIBRATOR

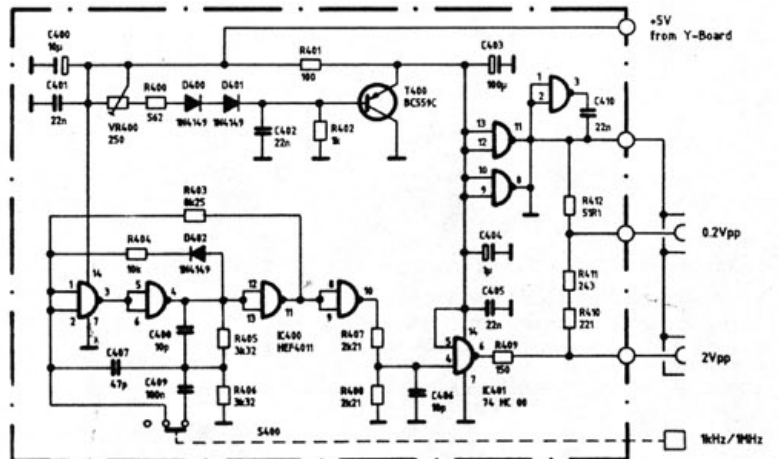

(siehe Justierplan, Seite A1)

Überprüfung des Hellstimpulses, ChP5

Impulsamplitude = $22V_{pp} \pm 5\%$; ist der Hochspannung ($-1900V$) überlagert. **(Vorsicht!)**

Die Überprüfung erfolgt mit einem Testoszilloskop unter Verwendung eines 10:1 Tastkopfes sowie eines vorgeschalteten HV-Kondensators ($10nF/2kV$).

Einstellungen am HM204-2: Eingangskopplung in Stellung **GD**. Zeitbasis **50 μ s/cm**, Triggerung automatisch (**PEAK**). Eingangsteiler auf **5mV/cm**.

Einstellungen am Testoszilloskop: **1V/cm (DC)**, **0,1ms/cm**, **autom. Triggerung. Anzeige am Testoszilloskop:** (sh. Diagramm)

Die negativen Impulsdächer müssen exakt waagrecht verlaufen (Schreibstrahl am HM204-2). Die positiven Impulsdächer angenähert waagrecht (Rücklauf = dunkel).

Einstellung von VR624

Der Strom muß auf den Mittelwert folgender Grenzen eingestellt werden:

- heller Punkt auf der linken Seite des Strahles (Bildschirm HM204-2)
- verkürzter Schreibstrahl (Bildschirm HM204-2).

Zwischen diesen zwei Punkten ist ein großer Bereich. Er wird benötigt, um interne Temperaturschwankungen aufzufangen. Bei korrekter Einstellung dürfen die Flanken des Rechtecks auf dem Testoszilloskop nicht sichtbar sein.

Jetzt Zeitbasiseinstellung am HM204-2 auf **0,5 μ s/cm**, am Testoszilloskop auf **1 μ s/cm**.

Nun sollen steile Flanken am Testoszilloskop sichtbar sein.

Hellstimpuls am ChP5.
Schirmbild am
Testoszilloskop

Unblanking pulse on ChP5
(triggering: free run),
seen on test oscilloscope.

Schreibstrahl am HM204-2:
Baseline on HM204-2 screen:

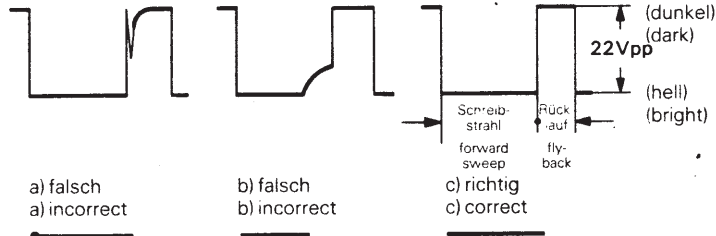

Einige wichtige Einstellungen

Balance CH.I: Einstellung an **VR130** (s. S. M8).

Einstellung von **VR134**, Invert Balance (sh. S. T1).

Balance CH.II: Einstellung wie Balance CH.I. **CH.I/II**-Taste drücken, **CH.II**-Balance Pot. einstellen (sh. S. M8).

Verstärkung CH.II (Y-Gain): Normalerweise ist **VR222** eingestellt. Falls Korrektur notwendig: Rechteck 1kHz, $20mV_{pp}$ an **CH.II**-Eingang, Eingangskopplung **DC**, **CH.I/II**-Taste gedrückt. YII-Abschwächer auf $5mV/cm$. Mit **VR222** 4cm Bildhöhe am HM204-2 einstellen.

X-Verstärkung (CH.II): Eingangskopplung auf **AC**. Keine Taste im Y-Feld gedrückt. Taste **X-Y** gedrückt. Es sind zwei Punkte in horizontaler Richtung sichtbar. Bei gleichem Eingangssignal und gleicher Einstellung beträgt der Abstand 4cm. Nachstellung am Pot. **VR3501**.

Verstärkung CH.I: Einstellung, falls nötig, am **VR202** (wie Verstärkung CH.II).

PEAK (automatische) Triggerung: Abschwächer Kanal I auf $10mV/cm$. Eingang Sinus, $50mV_{pp}/50kHz$ (Schirmbild = 5cm hoch). **PEAK/NORMAL** gedrückt. Abschwächer nun auf $0,1V/cm$ (5mm Bildhöhe).

VR301 so einstellen, daß Triggerung gerade erfolgt. Abschwächer auf $0,2V/cm$: Triggerung darf nicht erfolgen.

Taste **SLOPE \pm** drücken; Abschwächer auf $0,1V/cm$.

VR302 wie VR301 einstellen. Einstellungen wiederholen.

NORMAL-Triggerung: **LEVEL**-Knopf ziehen. Kontrolle der Normaltriggerung durch Einstellung des **LEVEL**-Knopfes, dabei **SLOPE \pm** ein- und ausschalten.

Triggerung auch bei 20MHz überprüfen.

DC-Triggerung: Triggerkopplung auf **AC**, **LEVEL**-Knopf gezogen. Kanal I, **DC**-Kopplung. Eingangssignal Sinus, 50kHz. Bildhöhe = 5mm (wie **PEAK**-Triggerung). Mit **LEVEL** stehendes Bild einstellen. Dann Triggerkopplung auf **DC**. Mit **VR2000** einstellen.

Gleiche Reihenfolge auch für Kanal II: Triggereinstellung an **VR2010**.

X-Y Empfindlichkeit: Taste **CH.I/II** drücken. Eingangskopplung **CH.II** auf **AC**, Abschwächer auf **5mV/cm**. Eingangssignal: 50kHz/Sinus, auf 6cm Bildhöhe einstellen. Knöpfe **DUAL**, **ADD/CHOP** und **X-Y** drücken.

Auf dem Bildschirm erscheint eine horizontale und eine diagonale Linie.

X-POS. und **Y-POS. I** und **II** so einstellen, daß beide Linien in der Mitte des Bildschirms sind.

Die Länge der horizontalen Linie und die (projizierte) Höhe der diagonalen Linie sollen 6cm betragen. der Schnittpunkt der Linien soll ungefähr in der Bildschirmitte liegen.

(see Adjusting Plan on page A1)

Check of the Unblanking Pulse on ChP5

Pulse amplitude $22V_{pp} \pm 5\%$ added with $-1900V$ (**Caution!**).

Check with **test oscilloscope** by means of a **10X probe with 10nF 2kV capacitor between ChP5 and probe input tip.**

HM204-2 settings: Input coupling to **GD** (no input signal), **50 μ s/cm**, **PEAK** triggering (free running), input attenuator $5mV/cm$ (unless otherwise specified).

Test scope settings: **1V/cm (DC)**, **0,1ms/cm**, **internal automatic triggering.**

Display on test scope:

Negative pulse tops exactly horizontal (forward sweep = bright trace on HM204-2). Positive pulse tops approx. horizontal (fly back = blanked trace).

Readjustment of VR624

Adjust the forward current of the optocoupler diode in the middle of the following points:

a) bright spot on the left side of the trace (screen of the HM204-2),

b) shortening on right side of the trace (screen of the HM204-2).

Between these two points is a wide range (needed for temperature variation). With correct adjustment, the edges of the square-wave should not be visible on the test scope.

Then change both **TIMEBASE** settings to **0.5 μ s/cm** (HM204-2) and **1 μ s/cm** (test scope). Now steep square-wave edges must be visible on the test scope.

Sequence for important adjustments

Balance CH.I: Adj. **VR130** (see page M8).

Adj. **VR134** using **INV. I** button (see page T1).

Balance CH.II: Same as CH.I, switch to CH.II, adj. CH.II-Bal. pot.

Gain CH.II: Normally, **VR222** is adj. If not, $20mV_{pp}$, 1kHz square-wave to **CH.II** input, **DC**, depress **CH.I/II** button.

Then adjust **VR222** for a display of 4cm on HM204-2 screen at $5mV/cm$ setting.

X gain (CH.II): Set **AC** input coupling, release all buttons in the Y-section, depress **X-Y** button with same input signal. Two points are visible in the horizontal axis.

Adj. **VR3501** for 4cm spacing.

Gain CH.I: If necessary, adj. **VR202** (in the same way as CH.II).

Automatic Triggering (PEAK): Set **CH.I** attenuator to $10mV/cm$, input $50mV$ 50kHz sine (5cm display height).

Set attenuator to $0,1V/cm$ (5mm display height).

Adj. **VR301 (LEVEL)** button depressed for just triggering. Attenuator to $0,2V/cm$: No triggering must be possible.

Depress **SLOPE \pm** button, attenuator to $0,1V/cm$.

Adj. **VR302** for same trigger threshold. Repeat triggering adjustments.

Normal Triggering: Pull **LEVEL** button, adj. **LEVEL** control.

Check normal trigger mode using **LEVEL** control with **SLOPE \pm** button depressed and released.

Check triggering at 20MHz in same way.

DC triggering: TRIGGER SELECTOR to **AC**, pull **LEVEL** button. **CH.I** with **DC** input coupling, input signal 50kHz sine, 5mm display height (see above Automatic Triggering), adj. **LEVEL** control. Then TRIGGER SELECTOR to **DC**, adj. **VR2000**.

Repeat this adj. sequence for **CH.II**, adj. **VR2010**.

X-Y sensitivity: Depress **CH.I/II** button, set **CH.II** input coupl. to **AC**, attenuator to **5mV/cm**, apply 50kHz sine for 6cm display height. Depress **DUAL**, **ADD/CHOP**, **X-Y** buttons.

Now display shows a horizontal and a crossing sloping line.

Adj. **X-POS.** and **Y-POS. I** and **II** controls so that the horizontal and the sloping line are centered.

Length of horizontal line and (projected) height of sloping line should be 6cm.

The point of intersection should be approx. in center of graticule.

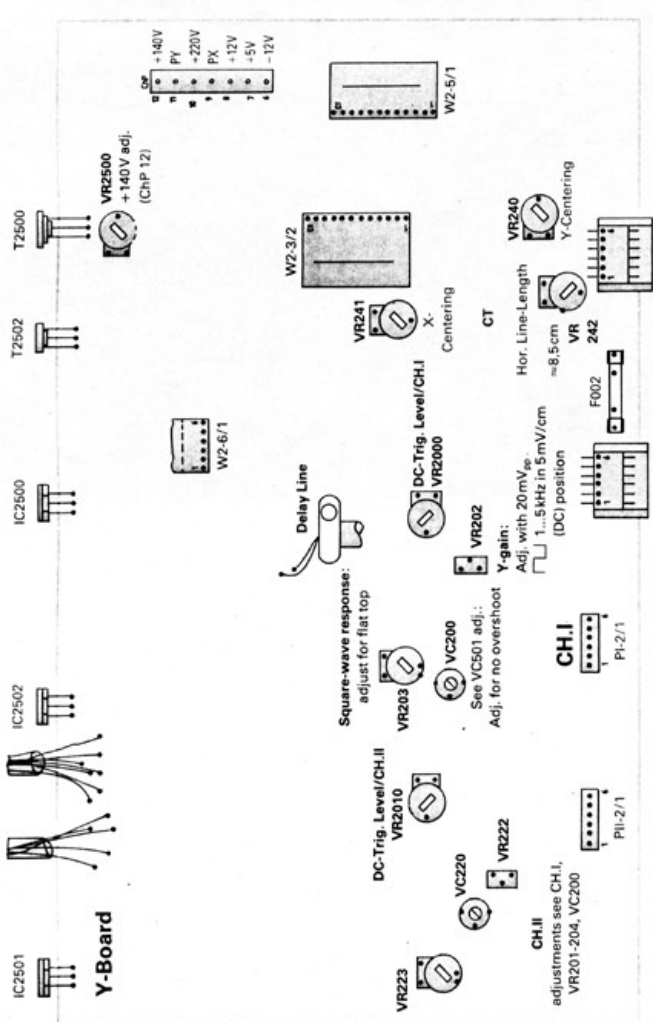

HM 204-2

**ADJUSTING PLAN
PLAN D'AJUSTAGE
ABGLEICHPLAN
PLAN DE AJUSTES**

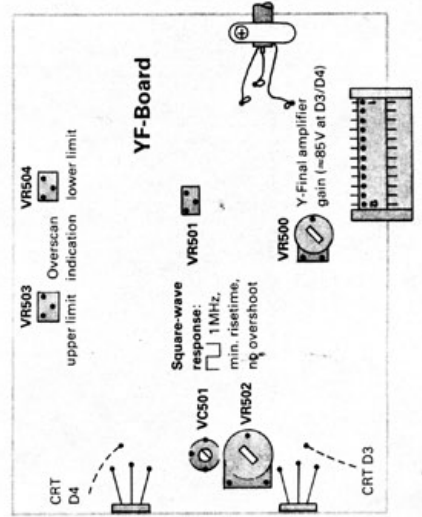
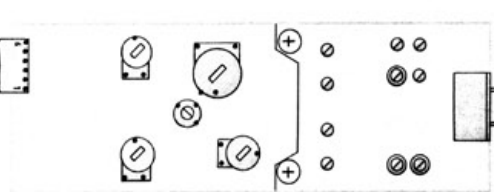
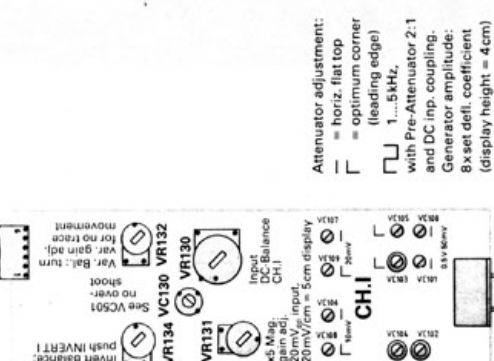
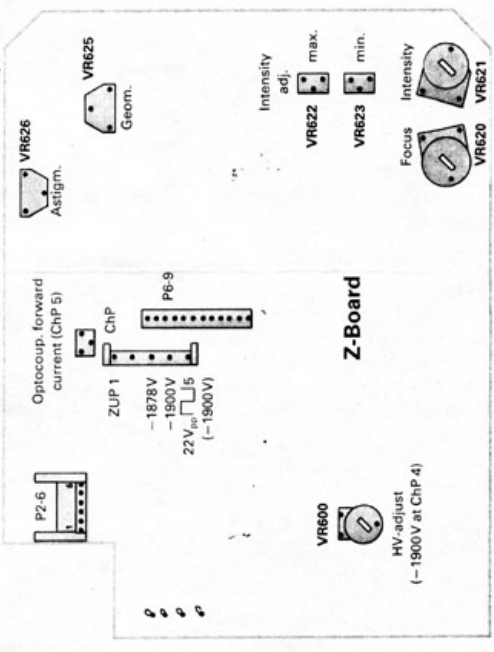
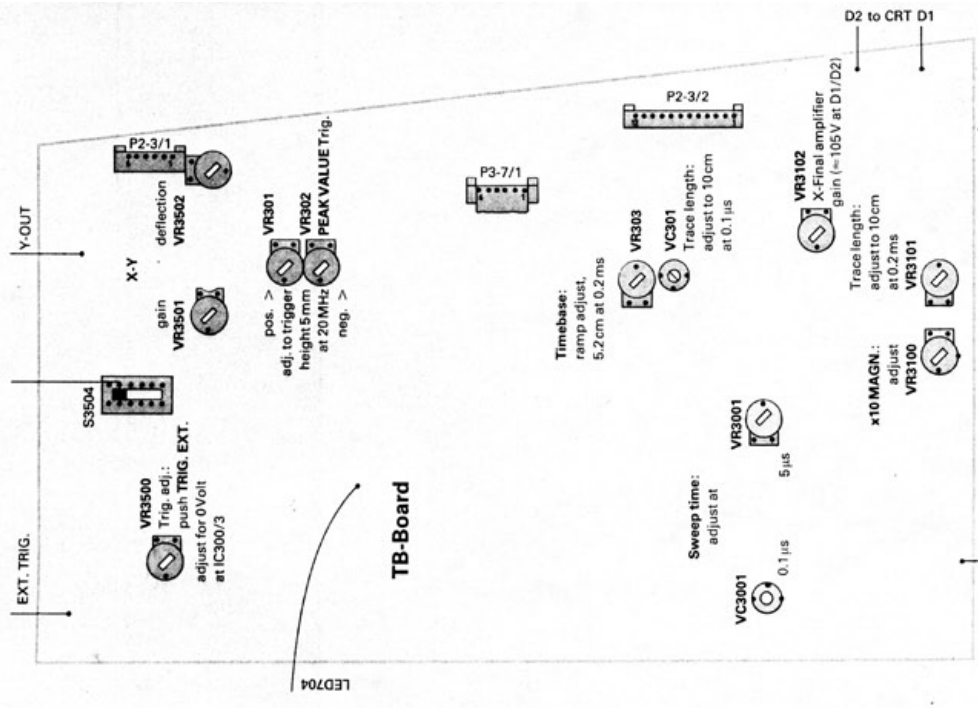

HAMEG

Oscilloscopes
Multimeters
Counter Timers
Power Supplies
Calibrators
Signal
Generators
Check Point
Testers

Distributed by:



West Germany

HAMEG GmbH

Kelsterbacher Str. 15-19
6000 FRANKFURT am Main 71
Tel. (0611) 67.60.17 • Telex 4.13.866

France

HAMEG S.a.r.l.

5-9, av. de la République
94800-VILLEJUIF
Tél. (1) 678.09.98 • Telex 270.705

Spain

HAMEG IBERICA S.A.

Villarroel 172-174
BARCELONA-36
Teléf. (93) 230.15.97

Great Britain

HAMEG LTD

74-78 Collingdon Street
LUTON, Bedfordshire LU1 1RX
Tel. (0582) 41.31.74 • Telex 825.484

United States of America

HAMEG, Inc.

88-90 Harbor Road
PORT WASHINGTON, New York 11050
Phone (516) 883.3837 • TWX (510) 223.0889