

Assets Download: [YAS-203 Zip \(7.38 MB\)](#)

Please use the images, video, etc. provided in the 'Assets Download' file to generate your local site content. The layout below is provided for marketing copy, context and visual reference.

Go Live Date*: Tuesday, September 02, 2014

*Do not publish this page until the release date (go live date) listed above.

YAS-203

MSRP: \$399.95

Immersive Home Theater Sound with Deep Bass

Make all of your movies and TV shows come to life with clear, spacious sound. The piano-black finish of the sound bar looks great with your TV and the wireless subwoofer can be placed anywhere in the room to deliver rich, impactful bass. BLUETOOTH® lets you wirelessly stream music from your iPhone®, iPad® and Android™ devices.

- Wireless subwoofer for deep bass with flexible placement
- Bluetooth® wireless music streaming from a smartphone or tablet
- Extremely easy set up with a single-cable connection
- Learning feature lets you use your TV remote to control volume
- Low-profile design - mount on wall or place on TV stand



Videos

YAS-203 Overview



Embed HTML <>

Features

AIR SURROUND XTREME Provides Superior Virtual Surround

Yamaha-exclusive AIR SURROUND XTREME reproduces virtual 7.1-channel surround sound with high quality, excellent imaging and rich presence far superior to other virtual surround technologies. You'll experience an extremely realistic and impressive sound field with clear dialogue in the front and dynamic sound action effects from behind.



Realistic and Impressive Sound

The sound bar houses a digital amp and two 2-1/8" cone speakers with large magnets to ensure high quality sound. Its structural design allows the sound bar to perform with power and clarity in a slim body chassis. Yamaha's original advanced bass extension processing delivers powerful bass for enhanced performance.

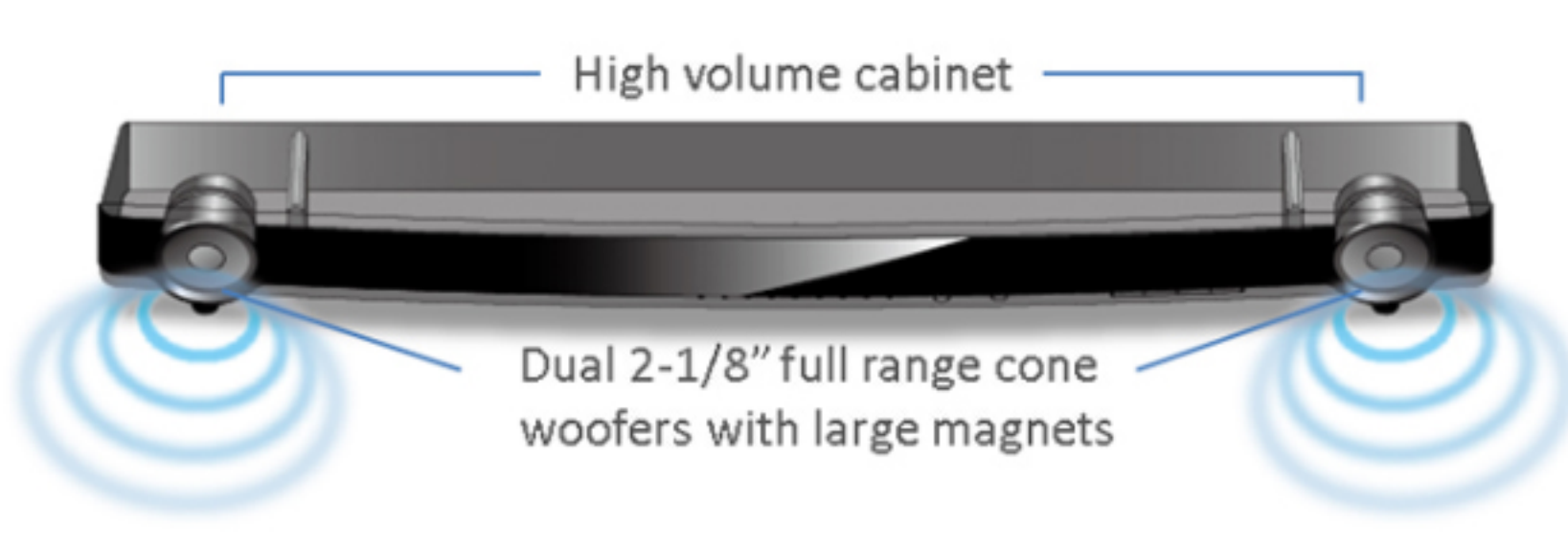

Easy to Place Wireless Powered Subwoofer

This subwoofer features a large magnet, a front-firing configuration, proprietary Yamaha's Advanced YST II and a linear port to produce deep and smooth bass. And, because there is no need to connect cables, it's easy to set up and place.

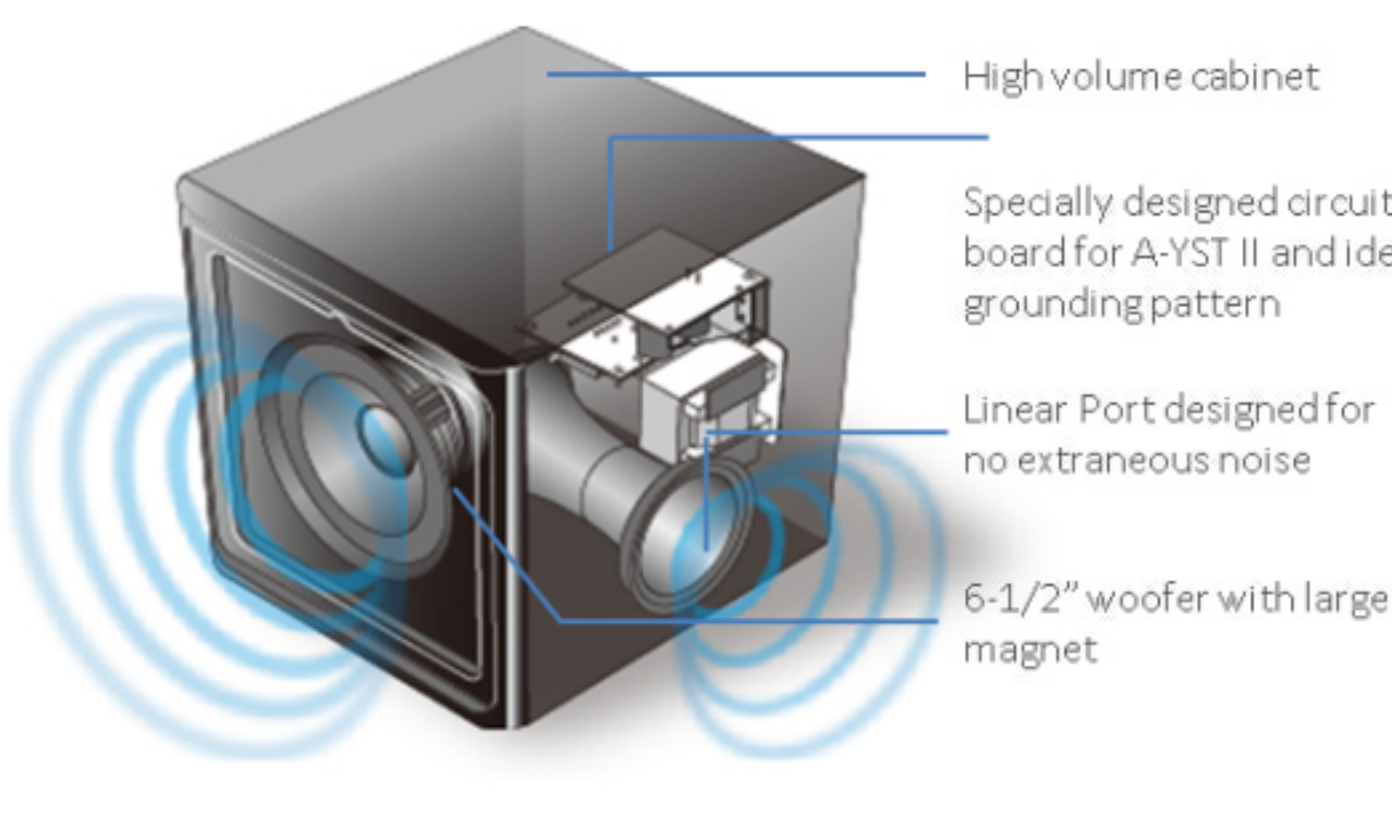

Bluetooth® Wireless Music Streaming from Your Smartphone or Tablet

Fill your home with music the quick and easy way! Stream music from Bluetooth®-compatible smartphones, tablets and computers. And with support for aptX® audio coding, performance is better than ever. The YAS-203 can also be set in Bluetooth® standby mode, enabling the bar's power to turn on or off automatically for energy-saving convenience.



Clear Voice Makes Dialogue and Narrations Easy to Hear

Clear Voice raises the level of dialogue and narrations while maintaining overall sound quality. Movies, TV shows, sports and news broadcasts are more clearly audible.

UniVolume™ Maintains the Same Volume Level

This welcome feature, made possible by Yamaha developed technology, maintains a consistent volume level between different channels, programs, commercials and input sources. It can be switched on and off.

Low-profile Design

With a height of only 3-1/8", the YAS-203 can be easily positioned in front of most TVs. To straddle a TV stand, simply attach the included feet.



Elegance and Simplicity

The sophisticated design features a piano black finish bringing elegance and quality to the room.



Wall-mountable

The YAS-203 can be mounted to a wall using commercially available hardware. A paper mounting template is included to assist with the installation process.



Easy Operation from Your Smartphone or Tablet

Download the free Home Theater Controller app for iOS and Android™ to easily perform a variety of basic functions. Select surround modes or make sound adjustments for the best listening experience.

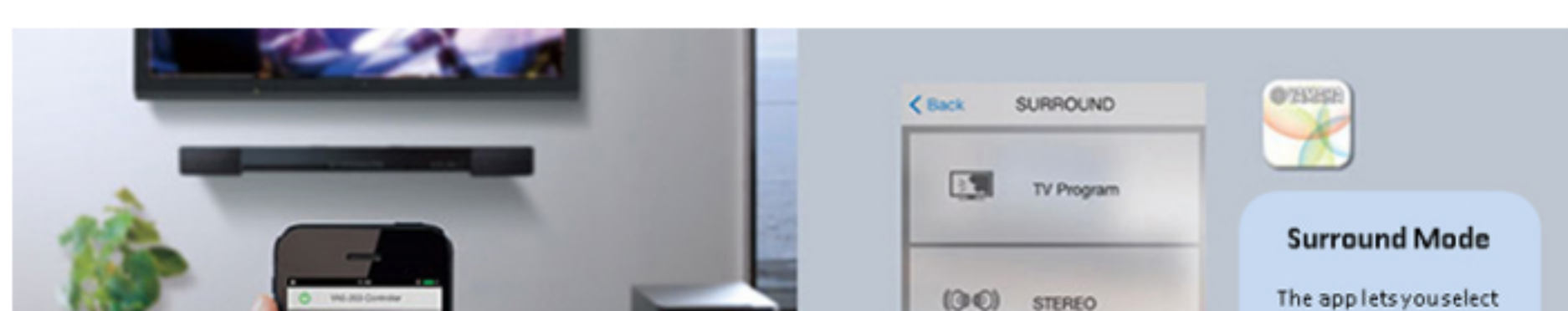

TV Remote Repeater for Signal Transmission

Even if the YAS-203 blocks the TV remote's signal, the TV Remote Repeater transmits the signal to the TV so operation is unaffected.

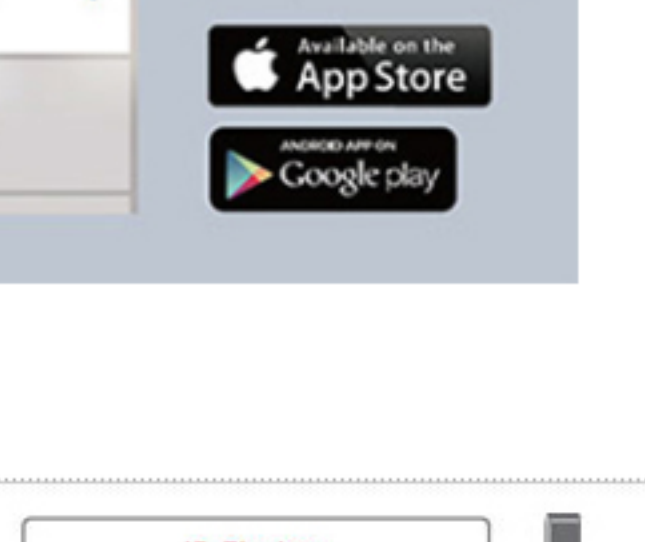

Learning Function Allows Operation with the TV Remote Control

The YAS-203 can "learn" the TV remote control signal, so you can use the TV remote control to turn the YAS-203 on and off, adjust its volume, and even control the mute function.

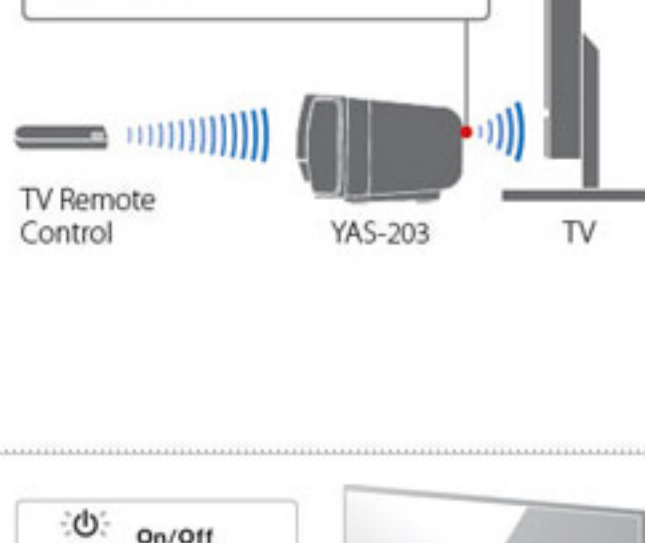

Specs

Sound Bars

General	Drivers	Front speaker system: 2-1/8" cone x 2, Subwoofers: 6-1/2" cone woofer
	Output Power	200 W total power: 50 W x 2 (6 ohms, 1 kHz, 10 % THD) + 100 W subwoofer (5.5 ohms, 100Hz, 10 % THD)
	Power Consumption	26 W (Front speaker system), 45 W (Subwoofer)
	Standby Power Consumption	0.4 W (Front speaker system)
	Subwoofer	Bass-reflex (Advanced YST II with Linear Port)
	Dimensions (W x H x D)	34-7/8" x 3-1/8" (with feet; 3-5/8") x 4-3/4" (Front speaker system), 11-3/8" x 11-1/2" x 12-1/2" (Subwoofer)
	Weight	6.4 lbs. (Front speaker system), 17.9 lbs. (Subwoofer)
Input / Output	Digital Optical	1 in
	Digital Coaxial	1 in
	Analog Audio	1 in
Sound Technology	Surround Technology	AIR SURROUND XTREME
	UniVolume	Yes
	Clear Voice	Yes
Audio Formats	Dolby Digital	Yes
	Dolby Pro Logic II	Yes
	DTS	Yes
Connectivity	Wireless Music Streaming	Yes (with Bluetooth)
	Bluetooth Version/Profile	Ver. 2.1 + EDR / A2DP, SPP
	Wireless Subwoofer	Yes
Other Features	App Control	Yes
	TV Remote Repeater	Yes
	Learning Function	Yes

Technology

AIR SURROUND XTREME

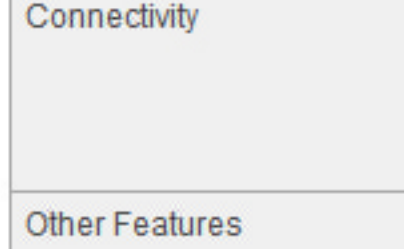

AIR SURROUND XTREME employs a virtual 7.1 channel technology that generates surround and surround back sound images without using dedicated surround speakers. The result is accurate sound directionality while maintaining an immersive surround sound environment. Hear clear dialogue from the front while distinctly separate surround effects move smoothly throughout the entire sound field.

Dolby® Digital

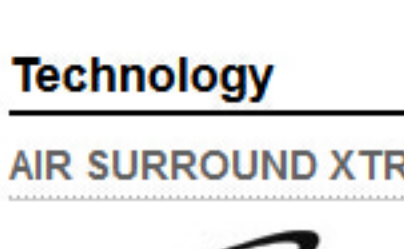

The most popular 5.1-channel home theater sound system. An improvement over Dolby® Pro Logic® offering: 1) Full frequency response in all channels (3 Hz — 20 kHz), 2) discrete surround channels, and 3) a separate track for bass, only, called the Low-Frequency Effects channel.

DTS Digital Surround™



DTS Digital Surround™ was developed to replace the analog soundtracks of movies with a multichannel digital sound track. This system produces practically distortion-free 6-channel sound (front left and right, center, surround left and right and subwoofer low frequency effect channels for a total of 5.1-channels).

Bluetooth®



Bluetooth® is a technology for wireless communication between devices within an area of about 33' employing the 2.4 GHz frequency band, a band which can be used without a license.

aptX®



aptX® audio coding delivers CD-quality wireless over Bluetooth, enabling users to lose the wires without compromising on audio quality. With the aptX® audio codec source material is transparently delivered over the Bluetooth® link, whether it is stored uncompressed or in an alternative compression (MP3, AAC, FLAC) format. Low audio coding delay minimizes latency and lip-sync issues.

UniVolume™



UniVolume™ is a Yamaha technology that maintains a consistent volume level between different channels, programs, commercials and input sources. For instance, when watching TV while using UniVolume™, the volume of commercials will not be louder than the program being viewed. The same is true when switching sources to watch a DVD or Blu-ray Disc™ movie or to listen to music on a CD. This is particularly helpful for late night watching and listening when spikes in volume can disturb others in the house.

Advanced YST



Advanced Yamaha Active Servo Technology (Advanced YST) is a unique system in which the speaker and amplifier work together to cancel out impedance so the speaker unit has a perfectly linear motion. Advanced YST helps to ensure the highest levels of sound pressure and overall performance.