

TOSHIBA
Leading Innovation >>>

REGZA

Owner's Manual

Integrated High Definition LCD Television

COLOR STREAM[®] HD

DOLBY
DIGITAL

DOLBY
VOLUME

HDMI HDTV CINEMA SERIES

40XV648U
46XV648U
52XV648U

For an overview of steps for setting up your new TV, see page 9.

Note: To display a High Definition picture, the TV must be receiving a High Definition signal (such as an over-the-air High Definition TV broadcast, a High Definition digital cable program, or a High Definition digital satellite program). For details, please contact your TV antenna installer, cable provider, or satellite provider.

© 2009 TOSHIBA CORPORATION
All Rights Reserved

Owner's Record

The model number and serial number are on the back and side of your TV. Record these numbers in the spaces below. Refer to these numbers whenever you communicate with your Toshiba dealer about this TV.

Model number: _____

Serial number: _____



TDM VX1A00144500

Dear Customer,

Thank you for purchasing this Toshiba LCD TV. This manual will help you use the many exciting features of your new LCD TV. **Before operating your LCD TV, please read this manual completely**, and keep it nearby for future reference.

Safety Precautions

WARNING: TO REDUCE THE RISK OF FIRE OR ELECTRIC SHOCK, DO NOT EXPOSE THIS APPLIANCE TO RAIN OR MOISTURE.



WARNING: TO REDUCE THE RISK OF ELECTRIC SHOCK, DO NOT REMOVE COVER (OR BACK). NO USER-SERVICEABLE PARTS INSIDE. REFER SERVICING TO QUALIFIED SERVICE PERSONNEL.



The lightning flash with arrowhead symbol, within an equilateral triangle, is intended to alert the user to the presence of uninsulated "dangerous voltage" within the product's enclosure that may be of sufficient magnitude to constitute a risk of electric shock to persons.



The exclamation point within an equilateral triangle is intended to alert the user to the presence of important operating and maintenance (servicing) instructions in the literature accompanying the appliance.

WARNING

To prevent injury, this apparatus must be securely attached to the floor/wall in accordance with the installation instructions. See item 23 on page 3 and instructions on page 5.

WARNING: If you decide to wall mount this television, always use a UL Listed wall bracket appropriate for the size and weight of this television. The use of any wall bracket other than a UL Listed wall bracket appropriate for the size and weight of this television for wall mounting this television could result in serious bodily injury and/or property damage. See "Removing the Pedestal Stand" (page 5).

NOTE TO CATV INSTALLERS

This is a reminder to call the CATV system installer's attention to Article 820-40 of the U.S. NEC, which provides guidelines for proper grounding and, in particular, specifies that the cable ground shall be connected to the grounding system of the building, as close to the point of cable entry as practical. For additional antenna grounding information, see items 30 and 31 on page 4.

CHILD SAFETY:

It Makes A Difference How and Where You Use Your Flat Panel Display

Congratulations on your purchase! As you enjoy your new product, please keep these safety tips in mind:

The Issue

The home theater entertainment experience is a growing trend and larger flat panel displays are popular purchases. However, flat panel displays are not always supported on the proper stands or installed according to the manufacturer's recommendations.



- Flat panel displays that are inappropriately situated on dressers, bookcases, shelves, desks, speakers, chests or carts may fall over and cause injury.

TOSHIBA Cares!

- The consumer electronics industry is committed to making home entertainment enjoyable and safe.

Tune Into Safety

- One size does NOT fit all. Follow the manufacturer's recommendations for the safe installation and use of your flat panel display.
- Carefully read and understand all enclosed instructions for proper use of this product.
- Don't allow children to climb on or play with furniture and television sets.
- Don't place flat panel displays on furniture that can easily be used as steps, such as a chest of drawers.
- Remember that children can become excited while watching a program, especially on a "larger than life" flat panel display. Care should be taken to place or install the display where it cannot be pushed, pulled over, or knocked down.
- Care should be taken to route all cords and cables connected to the flat panel display so that they cannot be pulled or grabbed by curious children.

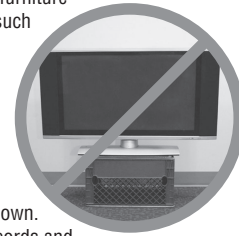



Wall Mounting: If you decide to wall mount your flat panel display, always:

- Use a mount that has been recommended by the display manufacturer and/or listed by an independent laboratory (such as UL, CSA, ETL).
- Follow all instructions supplied by the display and wall mount manufacturers.
- If you have any doubts about your ability to safely install your flat panel display, contact your retailer about professional installation.
- Make sure that the wall where you are mounting the display is appropriate. Some wall mounts are not designed to be mounted to walls with steel studs or old cinder block construction. If you are unsure, contact a professional installer.
- A minimum of two people are required for installation. Flat panel displays can be heavy.

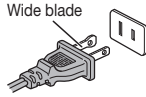
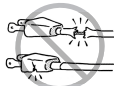

www.CE.org/safety

Important Safety Instructions

- 1) **Read these instructions.**
 - 2) **Keep these instructions.**
 - 3) **Heed all warnings.**
 - 4) **Follow all instructions.**
- 
-
- 5) **Do not use this apparatus near water.**
-
- 6) **Clean only with dry cloth.**
-
- 7) **Do not block any ventilation openings.** Install in accordance with the manufacturer's instructions.
-
- 8) **Do not install near any heat sources** such as radiators, heat registers, stoves, or other apparatus (including amplifiers) that produce heat.
-
- 9) **Do not defeat the safety purpose of the polarized or grounding type plug.** A polarized plug has two blades with one wider than the other. A grounding type plug has two blades and a third grounding prong. The wide blade or the third prong are provided for your safety. If the provided plug does not fit into your outlet, consult an electrician for replacement of the obsolete outlet.
 
-
- 10) **Protect the power cord** from being walked on or pinched, particularly at plugs, convenience receptacles, and the point where they exit from the apparatus.
 
-
- 11) **Only use attachments/accessories specified by the manufacturer.**
-
- 12) **Use only with the cart, stand, tripod, bracket, or table specified by the manufacturer, or sold with the apparatus.** When a cart is used, use caution when moving the cart/apparatus combination to avoid injury from tip-over.
 
-
- 13) **Unplug this apparatus during lightning storms or when unused for long periods of time.**
-
- 14) **Refer all servicing to qualified service personnel.** Servicing is required when the apparatus has been damaged in any way, such as power-supply cord or plug is damaged, liquid has been spilled or objects have fallen into the apparatus, the apparatus has been exposed to rain or moisture, does not operate normally, or has been dropped.

Additional Safety Precautions

- 14a) **CAUTION:** If the TV is dropped and the cabinet or enclosure surface has been damaged or the TV does not operate normally, take the following precautions:
- ALWAYS turn off the TV and unplug the power cord to avoid possible electric shock or fire.
 - NEVER allow your body to come in contact with any broken glass or liquid from the damaged television. The LCD panel inside the TV contains glass and a toxic liquid. If the liquid comes in contact with your mouth or eyes, or your skin is cut by broken glass, rinse the affected area thoroughly with water and consult your doctor.



- ALWAYS contact a service technician to inspect the TV any time it has been damaged or dropped.

- 15) **CAUTION:**
 - To reduce the risk of electric shock, do not use the polarized plug with an extension cord, receptacle, or other outlet unless the blades can be inserted completely to prevent blade exposure.
 - To prevent electric shock, match wide blade of plug to wide slot; fully insert.
- 16) **WARNING:** To prevent the spread of fire, keep candles or other open flames away from this product at all times.

Installation, Care, and Service

Installation

Follow these recommendations and precautions and heed all warnings when installing your TV:

- 17)  **WARNING: NEVER expose batteries to excessive heat such as sunshine, fire or the like.**
- 18) ALWAYS plug the product into an outlet that is located in such a manner that it can be easily unplugged in case the product requires service.
- 19) NEVER route the product's power cord inside a wall or similar enclosed area.
- 20) Never modify this equipment. Changes or modifications may void: a) the warranty, and b) the user's authority to operate this equipment under the rules of the Federal Communications Commission.
- 21)  **DANGER: RISK OF SERIOUS PERSONAL INJURY, DEATH, OR EQUIPMENT DAMAGE!**

Never place the TV on an unstable cart, stand, or table. The TV may fall, causing serious personal injury, death, or serious damage to the TV.
- 22) To avoid damage to this product, never place or store the TV in direct sunlight; hot, humid areas; or areas subject to excessive dust or vibration.
- 23) Always place the TV on the floor or a sturdy, level, stable surface that can support the weight of the unit. In order to maintain stability and prevent the TV falling over, secure the TV with a sturdy strap from the hooks on the rear of the TV pedestal to a wall stud, pillar, or other immovable structure. Make sure the strap is tight, secure, and parallel to the floor.

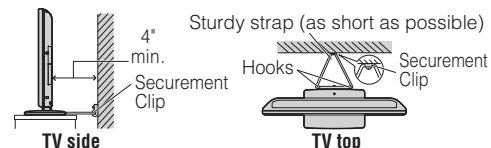

- 24) The apparatus shall not be exposed to dripping or splashing, and that no objects filled with liquids, such as vases, shall be placed on the apparatus.

25) Never block or cover the slots or openings in the TV cabinet back, bottom, and sides. Never place the TV:

- on a bed, sofa, rug, or similar surface;
- too close to drapes, curtains, or walls; or
- in a confined space such as a bookcase, built-in cabinet, or any other place with poor ventilation.



The slots and openings are provided to protect the TV from overheating and to help maintain reliable operation of the TV. Leave a space of at least 4 (four) inches around the TV.

26) Always place the back of the television at least four (4) inches away from any vertical surface (such as a wall) to allow proper ventilation.

27) Never allow anything to rest on or roll over the power cord, and never place the TV where the power cord is subject to wear or abuse.

28) Never overload wall outlets and extension cords.

29) Always operate this equipment from a 120 VAC, 60 Hz power source only.

30) Always make sure the antenna system is properly grounded to provide adequate protection against voltage surges and built-up static charges (see Section 810 of the National Electric Code).

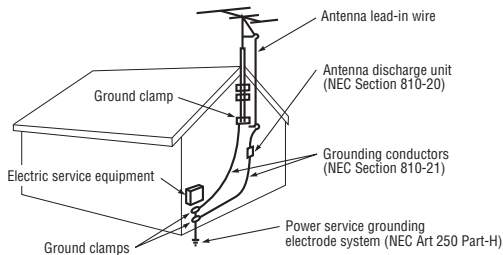

31) **! DANGER: RISK OF SERIOUS PERSONAL INJURY OR DEATH!**

- Use extreme care to make sure you are never in a position where your body (or any item you are in contact with, such as a ladder or screwdriver) can accidentally touch overhead power lines. Never locate the antenna near overhead power lines or other electrical circuits.
- Never attempt to install any of the following during lightning activity: a) an antenna system; or b) cables, wires, or any home theater component connected to an antenna or phone system.

Care

For better performance and safer operation of your TOSHIBA TV, follow these recommendations and precautions:

32) If you use the TV in a room whose temperature is 32 °F (0 °C) or below, the picture brightness may vary until the LCD warms up. This is not a sign of malfunction.

33) Always unplug the TV before cleaning. When cleaning your TV, please first remove any dirt or dust from the surface. Gently wipe the cabinet and the display panel surface (the TV screen) with a dry, soft cloth only (cotton, flannel, etc.). The enclosed cleaning cloth is for cabinet cleaning. Harsh rubbing or use of a dirty or stiff cloth will scratch the TV surface. Avoid contact with alcohol, thinner, benzene, acidic or alkaline solvent cleaners, abrasive cleaners, or chemical cloths, which may damage the TV surface. Never spray volatile compounds such as insecticide on the TV surface. Such products may damage or discolor the TV.



34) **! WARNING: RISK OF ELECTRIC SHOCK!** Never spill liquids or push objects of any kind into the TV cabinet slots.

35) While it is thundering, do not touch the connecting cables or apparatus.

36) For added protection of your TV from lightning and power surges, always unplug the power cord and disconnect the antenna from the TV if you leave the TV unattended or unused for long periods of time.

37) ALWAYS unplug the TV to completely disconnect from mains power. When the TV is turned off using the on/off switch, it is not completely disconnected from power and a minute amount of current is still consumed.

38) During normal use, the TV may make occasional snapping or popping sounds. This is normal, especially when the unit is being turned on or off. If these sounds become frequent or continuous, unplug the power cord and contact a Toshiba Authorized Service Center.

39) **! WARNING: RISK OF SERIOUS PERSONAL INJURY OR EQUIPMENT DAMAGE!**

Never strike the screen with a sharp or heavy object.



40) • The LCD screen of this product can be damaged by ultraviolet radiation from the sun. When selecting a location for the television, avoid locations where the screen may be exposed to direct sunlight, such as in front of a window.
• Never touch, press, or place anything on the LCD screen. These actions will damage the LCD screen. If you need to clean the LCD screen, follow the instructions in item 33 on this page.

Service

41)



WARNING: RISK OF ELECTRIC SHOCK!



Never attempt to service the TV yourself. Opening and removing the covers may expose you to dangerous voltage or other hazards. Failure to follow this WARNING may result in death or serious injury. Refer all servicing not specified in this manual to a Toshiba Authorized Service Center.

42) If you have the TV serviced:

- Ask the service technician to use only replacement parts specified by the manufacturer.
- Upon completion of service, ask the service technician to perform routine safety checks to determine that the TV is in safe operating condition.

43) The fluorescent lamp(s) in the LCD panel contain a small amount of mercury.

When the TV reaches the end of its useful life, dispose of the used TV by the approved method for your area, or ask a qualified service technician to properly dispose of the TV.



Note: The lamp(s) inside this product contain mercury. Disposal may be regulated due to environmental considerations. For disposal or recycling information, contact your local authorities or the Electronics Industries Alliance (www.eiae.org).

Choosing a location for your LCD TV

To Display your LCD TV on the included Pedestal Stand:

Observe the following safety precautions:

- 1) Read and Follow the pedestal assembly instructions included with the pedestal.

CAUTION: Before beginning pedestal assembly, carefully lay the front of the LCD Panel face down on a flat, cushioned surface such as a quilt or blanket. Leave the bottom of the unit protruding over the edge of the surface and assemble the pedestal as indicated below.

Note: Extreme care should always be used when attaching the pedestal stand to avoid damage to the LCD panel.

- 2) Place the TV on a sturdy, level surface that can support the weight of the TV.
- 3) Be sure to secure the TV to a wall stud, pillar, surface, or other immovable structure. To secure the TV in this manner: (1) attach the provided securement clip to an immovable structure, then (2) pass a sturdy strap through the securement clip and attach each end to the hooks located on the back of the TV. Be sure to leave at least 4 inches between the TV and the wall or similar structure for ventilation. See item 23, page 3 for additional details.

To Display your LCD TV using a Wall Bracket:

If you decide to wall mount your LCD TV, always use a UL listed wall bracket appropriate for the size and weight of the LCD TV (see page 2) :

- 1) **CAUTION:** Two people are required for installation.
- 2) Unplug and remove any cables and/or other component connectors from the rear of the TV.
- 3) Follow the instructions provided with your wall bracket. Before proceeding, make sure the appropriate bracket(s) are attached to the wall and the back of the TV as described in the instructions provided with the wall bracket.
- 4) After attaching the appropriate bracket(s) to the wall and the back of the TV, remove the pedestal stand from the TV as described below.

Removing the Pedestal Stand

- 1) Carefully lay the front of the unit face down on a flat, cushioned surface such as a quilt or blanket. Leave the stand protruding over the edge of the surface.

Note: Extreme care should always be used when removing the pedestal stand to avoid damage to the LCD panel.

- 2) Remove the four screws shown in the diagram below. This will allow removal of the pedestal stand.
- 3) Once you have removed all four screws holding the pedestal stand in place, remove the pedestal stand from the TV by sliding the pedestal stand away from the TV.

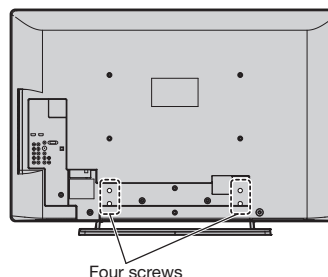

FCC Declaration of Conformity Compliance Statement (Part 15):

The **Toshiba 40XV648U, 46XV648U and 52XV648U Televisions** comply with Part 15 of the FCC rules.

Operation is subject to the following two conditions: (1) this device may not cause harmful interference, and (2) this device must accept any interference received, including interference that may cause undesired operation.

The party responsible for compliance to these rules is:

Toshiba America Consumer Products, L.L.C.

82 Totowa Rd. Wayne, NJ 07470.

Ph: 1-800-631-3811

Note: *This equipment has been tested and found to comply with the limits for a Class B digital device, pursuant to Part 15 of the FCC rules. These limits are designed to provide reasonable protection against harmful interference in a residential installation. This equipment generates, uses, and can radiate radio frequency energy and, if not installed and used in accordance with the instructions, may cause harmful interference to radio communications. However, there is no guarantee that interference will not occur in a particular installation. If this equipment does cause harmful interference to radio or television reception, which can be determined by removing and applying power to the equipment, the user is encouraged to try to correct the interference by one or more of the following measures:*

- Reorient or relocate the receiving antenna.
- Increase the separation between the equipment and the receiver.
- Connect the equipment into an outlet on a circuit different from that to which the receiver is connected.
- Consult the dealer or an experienced radio/TV technician for help.

Caution: *Changes or modifications to this equipment not expressly approved by Toshiba could void the user's authority to operate this equipment.*

ENERGY STAR® User Information

ENERGY STAR User Information Statement: the factory default settings of this television meet ENERGY STAR® requirements. Enabling or changing certain features and functionality (e.g. Picture Settings, Auto Brightness Sensor, Power-On Mode) may increase energy consumption, possibly beyond the limits required for ENERGY STAR qualification.

To ensure your television is operating at optimal energy efficiency, select [Home] mode during initial activation. To return to [Home] mode settings, select [AutoView] picture mode, set the Auto Brightness Sensor to [On] mode, and set the Power-On mode to [Power-Saving]. [AutoView] mode is recommended for normal home use.

For more information, see page 30 and 39.



ENERGY STAR® qualified TV. Products that earn the ENERGY STAR prevent greenhouse gas emissions by meeting strict guidelines set by the U.S. Environmental Protection Agency. ENERGY STAR and the ENERGY STAR mark are registered U.S. marks.

Important notes about your LCD TV

The following symptoms are technical limitations of LCD Display technology and are not an indication of malfunction; therefore, Toshiba is not responsible for perceived issues resulting from these symptoms.

- 1) An afterimage (ghost) may appear on the screen if a fixed, non-moving image is displayed for a long period of time. The afterimage is not permanent and will disappear in a short period of time.
- 2) The LCD panel contained in this TV is manufactured using an extremely high level of precision technology; however, there may be an occasional pixel (dot of light) that does not operate properly (does not light, remains constantly lit, etc.). This is a structural property of LCD technology, is not a sign of malfunction, and is not covered under your warranty. Such pixels are not visible when the picture is viewed from a normal viewing distance.

Note: *Interactive video games that involve shooting a "gun" type of joystick at an on-screen target may not work with this TV.*

Trademark Information

- Manufactured under license from Dolby Laboratories. Dolby and the double-D symbol are trademarks of Dolby Laboratories.
- HDMI, the HDMI logo and High-Definition Multimedia Interface are trademarks or registered trademarks of HDMI Licensing LLC.
- INSTAPORT™ and INSTAPORT logo are trademarks of Silicon Image, Inc. in the United States and other countries.

Contents

Important Safety Instructions	3
Installation, Care, and Service	3
Choosing a location for your LCD TV	5
Chapter 1: Introduction	9
Features of your new TV	9
Overview of steps for installing, setting up, and using your new TV	9
TV front and side panel controls and connections	10
TV back panel connections	11
Chapter 2: Connecting your TV	12
Overview of cable types	12
About the connection illustrations	12
Connecting a VCR (or a VCR with S-video) and antenna, Cable TV or Camcorder	13
Connecting a DVD player with ColorStream® (component video), a VCR, and a satellite receiver	14
Connecting an HDMI™ or DVI device to the HDMI input	15
REGZA-LINK® connection	16
Connecting a digital audio system	17
Connecting an audio system	17
Connecting a personal computer (PC)	18
Chapter 3: Using the remote control	19
Preparing the remote control for use	19
Installing the remote control batteries	19
Learning about the remote control	20
Using the remote control to control your other devices	21
Remote Control functional key chart	22
Programming the remote control to control your other devices	23
Remote control codes	24
Chapter 4: Menu layout and navigation	26
Main menu layout	26
Navigating the menu system	26
Chapter 5: Setting up your TV	27
Initial Setup	27
Quick Setup from the SETUP menu	27
Selecting the menu language	27
Configuring the antenna input source for the ANT/CABLE terminal	28
Programming channels into the TV's channel memory	28
Auto Tuning	28
Manual Tuning	28
Setting channel skip	29
Setting video input skip	29
Labeling video input sources	29
Setting the time zone	30
Selecting the location	30
Selecting the TOSHIBA Illumination mode	30
Selecting the Power-On Mode	30
Using Blue Screen	30
Setting the screen transparency	30
Viewing the system status	31
Reset Factory Defaults	31
Chapter 6: Using the TV's features	32
Selecting the video input source to view	32
Tuning channels	33
Tuning channels using the Channel Browser™	33
Setting the Channel Tuning Mode	35
Tuning to the next programmed channel	35
Tuning to a specific channel (programmed or unprogrammed)	35
Switching between two channels using Channel Return	35
Switching between two channels using SurfLock™	35
Selecting the picture size	36
Scrolling the picture	38
Using the Auto Aspect Ratio feature	38
Using the 4:3 Stretch	38
Using the FREEZE feature	38
Adjusting the picture	39
Selecting the picture mode	39
Adjusting the picture quality	39
Using the TheaterLock™ feature	40
Viewing the Control Visualization window	40
Using the closed caption mode	40
Analog CC Mode	40
Digital CC Settings	41
CC Selector	41
Adjusting the audio	42
Muting the sound	42
Using the digital audio selector	42
Selecting stereo/SAP broadcasts	42
Adjusting the audio quality	42
Selecting the optical audio output format	43
Using the Dolby® Digital Dynamic Range Control feature	43
Using Dolby® Volume	43
Setting the PIN code	43
Registering a new PIN code	43
Changing or deleting your PIN code	43
If you cannot remember your PIN code	43
Blocking TV programs and movies by rating (V-Chip)	44
Downloading an additional rating system for blocking TV programs and movies	44
Unlocking programs	45
Locking channels	46
Using the input lock feature	46
Using the GameTimer® feature	46
Using the panel lock feature	46
Using the PC settings feature	47
Setting the PC Audio	47
Setting the On Timer	48
Setting the Sleep Timer	48
Using REGZA-LINK®	49
REGZA-LINK® playback device (DVD player, etc.) control	49

(continued)

REGZA-LINK® input source selection	49
Amplifier VOLUME and MUTE controls	50
Other REGZA-LINK® functions	50
REGZA-LINK® PC Link	50
Using the HDMI™ settings feature	51
Setting the HDMI™ audio mode	51
Displaying TV status information	52
Understanding the auto power off feature	52
Understanding the last mode memory feature	52
Chapter 7: Using the TV's advanced features	53
Using the advanced picture settings features	53
Using the Resolution+™ feature	53
Using the DynaLight™ feature	53
Using the Dynamic Contrast	53
Using the Static Gamma	53
Using the Film Stabilization	53
Using Expert Mode	54
Using the ClearFrame™ feature	54
Using the MPEG NR feature	54
Using the DNR feature	54
Using the Auto Brightness Sensor	55
Using the Backlight Adjustment Pro	55
Using the ColorMaster™ feature	55
Using the Base Color Adjustment	55
Selecting the color temperature	56
Using the advanced sound setting features	56
Using the surround sound feature	56
Using the Media Player	57
Media Player Specifications	57
Basic operation	57
Viewing JPEG files	58
Chapter 8: Troubleshooting	59
General troubleshooting	59
LED indications	61
Chapter 9: Appendix	62
Specifications	62
Acceptable signal formats for	
PC IN and HDMI terminals	63
PC IN signal formats	63
HDMI signal formats	64
Limited United States Warranty	
for LCD Televisions 26" and Larger	65
Limited Canadian Warranty	
for Toshiba Brand Flat Panel Televisions	66
Index	69

Chapter 1: Introduction

Features of your new TV

The following are just a few of the many exciting features of your new Toshiba widescreen, integrated HD, LCD TV:

- **Integrated digital tuning (8VSB ATSC and QAM)** eliminates the need for a separate digital converter set-top box (in most cases).
- **1080p output resolution.**
- **Three HDMI™** digital, high-definition multimedia interfaces with 1080p input support (see page 15).
- **HDMI capabilities**
 - Deep Color** feature allows the HDMI source to increase the available colors bits within the boundaries defined by the RGB or YCbCr color space.
 - Lip-Sync** feature activates an auto audio/video display timing adjustment function that allows HDMI source devices to accurately perform synchronization automatically.
 - HDMI INSTAPORT™** technology reduces lag time when switching HDMI sources.
 - RGB Range** feature adjusts RGB full range signal automatically.
- **REGZA-LINK®** allows control of external devices from the TV remote via HDMI connection (see page 49).
- **Two sets of ColorStream® HD** high-resolution component video inputs (see page 14).
- **Digital Audio Out** optical audio connection with Dolby® Digital optical output format (see page 17).
- **PC IN (Analog RGB)** computer terminal (see page 18).
- **ColorMaster™** allows you to adjust the TV's standard colors (see page 55).
- **Expert Mode** allows detailed calibration with red, green and blue color selections (see page 54).
- **ClearFrame™** 120 Hz anti-blur feature (see page 54).
- **Resolution+™** upconverts and enhances for a more detailed picture (see page 53).
- **AutoView™** allows you to automatically adjust picture settings based on ambient light conditions and input signal content (see page 39).
- **Dolby® Volume** eliminates inconsistent TV volume when changing channels or viewing commercials (see page 43).
- **Media Player** allows you to view your JPEG pictures (see page 57).



ENERGY STAR® qualified

Overview of steps for installing, setting up, and using your new TV

Follow these steps to set up your TV and begin using its many exciting features.

- 1 Observe the following when choosing a location for the TV:
 - Read "Important notes about your LCD TV" (see page 6).
 - Place the TV in a proper location (see pages 2–5).
 - 2 Do not plug in any power cords until AFTER you have connected all cables and devices to your TV.
 - 3 BEFORE connecting cables or devices to the TV, learn the functions of the TV's connections and controls (see pages 10–11).
 - 4 Connect your other electronic device(s) to the TV (see pages 12–18).
 - 5 See "Chapter 3: Using the remote control" (see page 19) for an overview of the buttons on the remote control, install the batteries and prepare to operate your other device(s).
 - 6 AFTER connecting all cables and devices, plug in the power cords for your TV and other devices.
- Note:** After you turn on the TV, the Initial Setup menu appears automatically by default.
- 7 See "Menu layout and navigation" for a quick overview of navigating the TV's menu system (see page 26).
 - 8 Program channels into the TV's channel memory (see page 28).
 - 9 For details on using the TV's features, see Chapters 6 and 7.
 - 10 For help, refer to the Troubleshooting Guide, see Chapter 8.
 - 11 For technical specifications and warranty information, see Chapter 9.

TV front and side panel controls and connections

Model 46XV648U is used in this manual for illustration purposes.

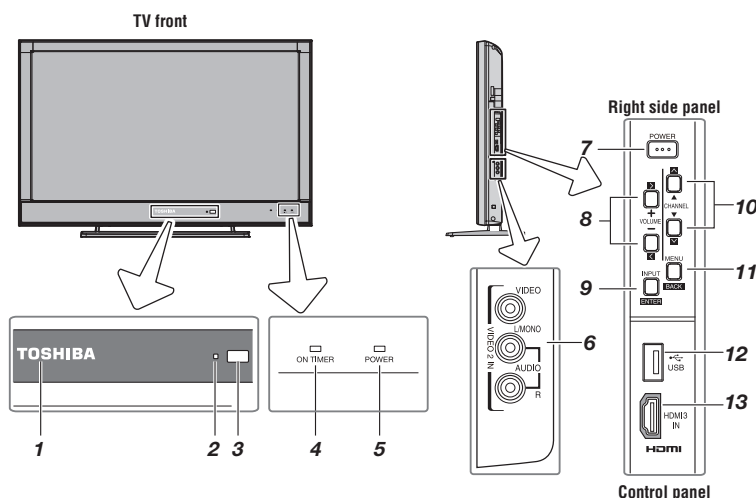

1 TOSHIBA Illumination

The TOSHIBA logo will be illuminated. See "Selecting the TOSHIBA Illumination mode" on page 30 for additional information.

2 Auto Brightness Sensor

This sensor will detect the ambient light conditions to optimize the backlighting levels. See "Using the Auto Brightness Sensor" on page 55 for additional information.

3 Remote sensor

Point the remote control toward this remote sensor.

Effective range:

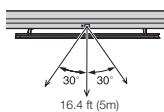

4 On Timer LED

See "Setting the On Timer" on page 48.

5 Power LED

See "LED indications" on page 61 for additional information.

6 VIDEO 2 IN

The side panel A/V connections are referred to as "VIDEO 2" and include standard A/V connections.

7 POWER

Press to turn the TV on and off. If the TV stops responding to the controls on the remote control or TV control panel and you cannot turn off the TV, press and hold the **POWER** button on the TV control panel for 5 or more seconds to reset the TV.

8 VOLUME+ -

These buttons adjust the volume level. **ARROWS < >** — When a menu is on-screen, these buttons function as left/right menu navigation buttons.

9 INPUT/ENTER

Repeatedly press to change the source you are viewing (**ANT/CABLE, VIDEO 1, VIDEO 2, ColorStream HD1, ColorStream HD2, HDMI 1, HDMI 2, HDMI 3, PC**). When a menu is on-screen, the **INPUT** button on the TV's control panel functions as the **ENTER** button.

10 CHANNEL ▲ ▼

When no menu is on-screen, these buttons change the channel (programmed channels only; see page 28). **ARROWS ^ v** — When a menu is on-screen, these buttons function as up/down menu navigation buttons.

11 MENU/BACK

Press to access the menu system (see page 26). When a menu is on-screen, the **MENU** button on the TV's control panel functions as the **BACK** button.

12 USB terminal

For use when inserting a USB device.

13 HDMI™ IN

High-Definition Multimedia Interface (HDMI 3) input receives digital audio and uncompressed digital video from an HDMI device or uncompressed digital video from a DVI device. HDMI connection is necessary to receive 1080p signals.

TV back panel connections

For an explanation of cable types and connections, see pages 12–18.

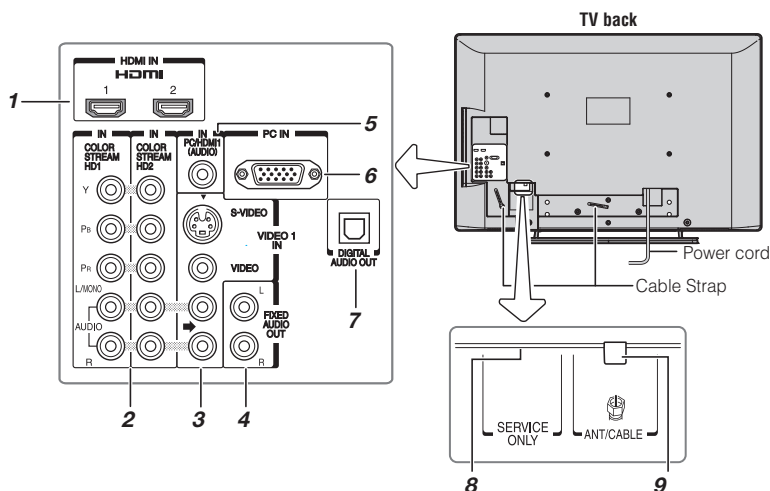

- 1 HDMI™ IN** — High-Definition Multimedia Interface input receives digital audio and uncompressed digital video from an HDMI device or uncompressed digital video from a DVI device. Also see item 5. HDMI connection is necessary to receive 1080p signals.
- 2 ColorStream® HD1 and ColorStream® HD2** — Two sets of ColorStream high-definition component video inputs (with standard stereo audio inputs) for connecting devices with component video output, such as a Toshiba DVD player with ColorStream.
Note: Component video cables carry only video information; separate audio cables are required for a complete connection.
- 3 VIDEO 1 IN** — Standard (composite) video and standard audio inputs plus optional S-video inputs for connecting devices with composite video or S-video output.
Note: Standard (composite) video and S-video cables carry only video information; separate audio cables are required for a complete connection.
- 4 FIXED AUDIO OUT** — Analog audio outputs for connecting an audio amplifier.
- 5 PC/HDMI 1 (AUDIO) IN** — PC audio input terminal is shared with HDMI 1 analog audio input terminal, and its use can be configured in the **AV Connection** menu (page 47).
- 6 PC IN** — For use when connecting a personal computer.

- 7 DIGITAL AUDIO OUT** — Optical audio output in Dolby Digital or PCM (pulse-code modulation) format for connecting an external Dolby Digital decoder, amplifier, or home theater system with optical audio input.
- 8 Service port** — For service use only. Used for updating the television's firmware.
- 9 ANT/CABLE** — Input that supports analog (NTSC) and digital (ATSC) off-air antenna signals and analog and digital Cable TV (QAM) signals.

HDMI, the HDMI logo and High-Definition Multimedia Interface are trademarks or registered trademarks of HDMI Licensing LLC.
Manufactured under license from Dolby Laboratories. Dolby and the double-D symbol are trademarks of Dolby Laboratories.

Chapter 2: Connecting your TV

Overview of cable types

Cables can be purchased from most stores that sell audio/video devices. Before purchasing any cables, be sure of connector types required by your devices and the length of each cable.

Coaxial (F-type) cable



Coaxial (F-type) cable is used for connecting your antenna, cable TV service, and/or cable converter box to the **ANT/CABLE** input on your TV.

Standard A/V cables (red/white/yellow)



Standard A/V cables (composite video) usually come in sets of three and are for use with video devices with analog audio and composite video output. These cables (and the related inputs on your TV) are typically color-coded according to use: yellow for video, red for stereo right audio, and white for stereo left (or mono) audio.

S-video cable



S-video cable is for use with video devices with S-video output. Separate audio cables are required for a complete connection.

Note: An S-video cable provides better picture performance than a composite video cable. If you connect an S-video cable, be sure to disconnect the standard (composite) video cable or the picture performance will be unacceptable.

Component video cables (red/green/blue)



Component video cables come in sets of three and are for use with video devices with component video output. (ColorStream® is Toshiba's brand of component video.) These cables are typically color-coded red, green, and blue. Separate audio cables are required for a complete connection.

Note: Component video cables provide better picture performance than a standard (composite) video or S-video cable.

HDMI™ cable (with HDMI Logo “HDMI”)



HDMI (High-Definition Multimedia Interface) cable is for use with devices with an HDMI output. An HDMI cable delivers digital audio and video in its native format. This cable carries both video and audio information; therefore, separate audio cables are not required for a complete HDMI device connection (see page 15, 16 and 18).

Note: An HDMI cable provides the best audio and picture performance.

Optical audio cable



Optical audio cable is for connecting receivers with Dolby Digital or PCM (pulse-code modulation) optical audio input to the TV's **DIGITAL AUDIO OUT** terminal (see page 17).

Analog RGB (15-pin) computer cable

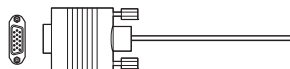

Analog RGB (15-pin) computer cable is for connecting a PC to the TV's **PC IN** terminal (see page 18).

Note: Separate audio cables are required for a complete connection.

About the connection illustrations

You can connect different types and brands of devices to your TV in several different configurations. The connection illustrations in this manual are representative of typical device connections only. The input/output terminals on your devices may differ from those illustrated herein. For details on connecting and using your specific devices, refer to each device's owner's manual.

Connecting a VCR (or a VCR with S-video) and antenna, Cable TV or Camcorder

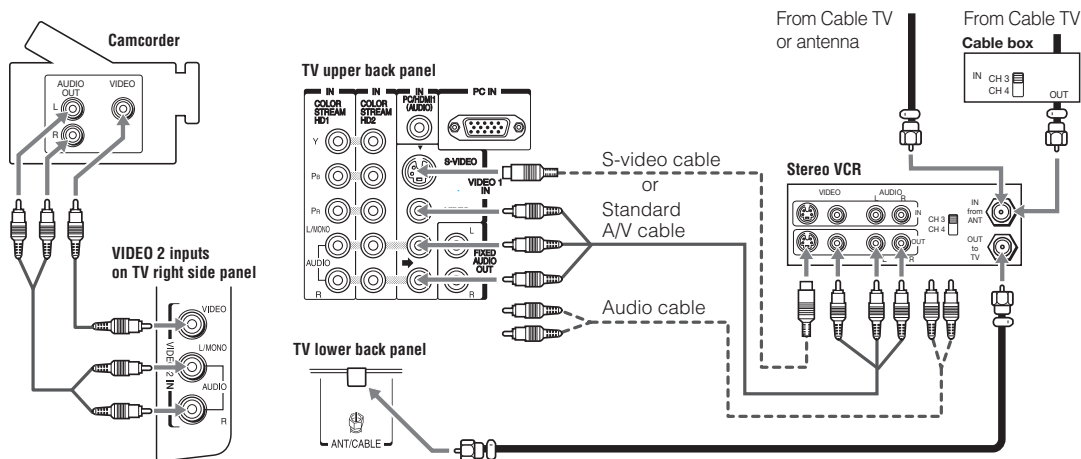

You will need:

- coaxial cables
- standard A/V cables
 - For better picture performance, if your VCR has S-video, use an S-video cable (plus the audio cables) instead of the standard video cable.
 - For better picture performance, if your camcorder has S-video, connect an S-video cable (plus the audio cables) to **VIDEO 1** on the TV back instead of the **VIDEO 2** on the TV right side panel.
 - If you have a mono VCR, connect **L/MONO** on the TV to your VCR's audio out terminal using the white audio cable only.
- S-video cable (if your VCR or camcorder has S-video)
 - Do not connect both types of video cable to **VIDEO 1** at the same time or the picture performance will be unacceptable.
- standard audio cables (if your VCR or camcorder has S-video)

Note: When you use a Cable box, you may not be able to use the remote control to program or access certain features on the TV.

To view the antenna or Cable signal:

Select the **ANT/CABLE** video input source on the TV.*

To view basic and premium Cable channels:

Turn OFF the VCR. Select the **ANT/CABLE** video input source on the TV.* Tune the TV to channel 3 or 4 (whichever channel the Cable box output is set to). Use the Cable box controls to change channels.

To view the VCR:

Turn ON the VCR. Select the **VIDEO 1** video input source on the TV.*

To view the camcorder video:

Select the **VIDEO 2** video input source on the TV.*

* To select the video input source, press **INPUT** on the remote control (page 32). To program the TV remote control to operate other devices, see Chapter 3.

The unauthorized recording, use, distribution, or revision of television programs, videotapes, DVDs, and other materials is prohibited under the Copyright Laws of the United States and other countries, and may subject you to civil and criminal liability.

Chapter 2: Connecting your TV

Connecting a DVD player with ColorStream® (component video), a VCR, and a satellite receiver

Your TV has two sets of ColorStream® (component video) inputs.

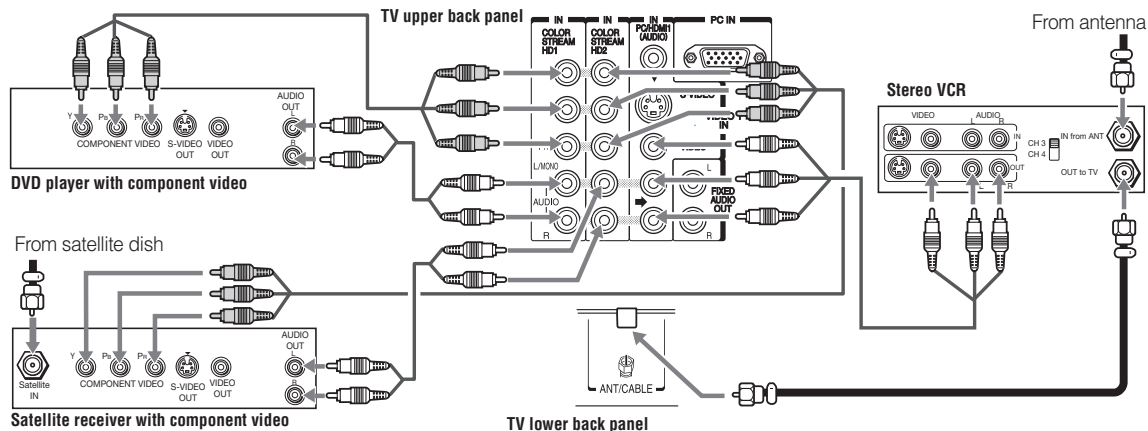

You will need:

- coaxial cables
- standard A/V cables
 - For better picture performance, if your VCR has S-video, use an S-video cable (plus the audio cables) instead of the standard video cable. Do not connect both types of video cable to **VIDEO 1** at the same time or the picture performance will be unacceptable.
 - If you have a mono VCR, connect **L/MONO** on the TV to your VCR's audio out terminal using the white audio cable only.
- standard audio cables
- component video cables
 - You can connect the component video cables (plus audio cables) from the DVD player or satellite receiver to either set of **ColorStream** terminals on the TV (**HD1** or **HD2**). The **ColorStream HD1** and **HD2** terminals can be used to display Progressive (480p, 720p, 1080p) and Interlaced (480i, 1080i). Please check the Owner's Manual of the DVD player or satellite receiver in order to determine the best output signal available (1080p 24 Hz/30 Hz/50 Hz/25 Hz are not supported).
 - If your DVD player or satellite receiver does not have component video, connect a standard A/V cable to **VIDEO 2** on the side panel. If your DVD player has HDMI video, see page 15.

To view antenna or Cable channels:

Select the **ANT/CABLE** video input source on the TV.*

To view the DVD player:

Turn ON the DVD player. Select the **ColorStream HD1** video input source on the TV.*

To view satellite programs using the component video connections:

Turn on the satellite receiver. Select the **ColorStream HD2** video input source on the TV.*

To view the VCR or view and record antenna channels:

Turn ON the VCR. Tune the VCR to the channel you want to watch. Select the **VIDEO 1** video input source on the TV.*

To record a TV program while watching a DVD:

Turn ON the VCR. Tune the VCR to the channel to record. Select the **ColorStream HD1** video input source on the TV* to view the DVD.

* To select the video input source, press **INPUT** on the remote control (page 32). To program the TV remote control to operate other devices, see Chapter 3.

The unauthorized recording, use, distribution, or revision of television programs, videotapes, DVDs, and other materials is prohibited under the Copyright Laws of the United States and other countries, and may subject you to civil and criminal liability.

Connecting an HDMI™ or DVI device to the HDMI input

The HDMI input on your TV receives digital audio and uncompressed digital video from an HDMI source device, or uncompressed digital video from a DVI (Digital Visual Interface) source device. This input is designed to accept HDCP (High-Bandwidth Digital-Content Protection) program material in digital form from EIA/CEA-861-E-compliant^[1] consumer electronic devices (such as a set-top box or DVD player with HDMI or DVI output). The HDMI input can accept and display VGA, SVGA, XGA, WXGA, SXGA, 480i (60 Hz), 480p (60 Hz), 720p (60 Hz), 1080i (60 Hz), and 1080p (24 Hz/60 Hz) signal formats. For detailed signal specifications, see page 64. Supported Audio format: Linear PCM, sampling rate 32/44.1/48 kHz

Note:

- To connect a PC to the HDMI input, see page 18.
- Some legacy HDMI sources may not work properly with your HDMI TV, due to the adoption of new standards. Please try setting the following four options (Deep Color, Lip Sync, and INSTAPOINT™) to Off. Your legacy HDMI source should operate properly with your TV. See page 51.

To connect an HDMI device, you will need:

- one HDMI cable per HDMI device
 - For proper operation, it is recommended that you use an HDMI cable with the HDMI Logo (HDMI).
 - To display an 1080p/60 Hz signal format, you will need a High Speed HDMI™ cable. Conventional HDMI/DVI cable may not work properly.
 - HDMI cable transfers both video and audio. Separate analog audio cables are not required (see illustration).
 - See “Setting the HDMI audio mode” (page 51).

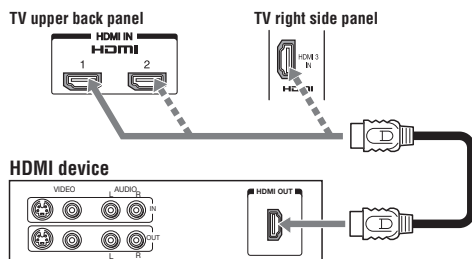

To view the HDMI device video:

Select the HDMI 1, HDMI 2, or HDMI 3 video input source on the TV.*

* To select the video input source, press **INPUT** on the remote control (page 32). To program the TV remote control to operate other devices, see Chapter 3.

To connect a DVI device, you will need:

- one HDMI-to-DVI adapter cable
 - For proper operation, the length of an HDMI-to-DVI adapter cable should not exceed 9.8 ft (3m). The recommended length is 6.6 ft (2m).
- one 3.5mm Stereo to RCA Y-Cable
 - An HDMI-to-DVI adapter cable transfers video only. Make sure to connect this cable to the HDMI 1 input on the TV. Separate analog audio cables are required (see illustration).
 - See “Setting the HDMI audio mode” (page 51).

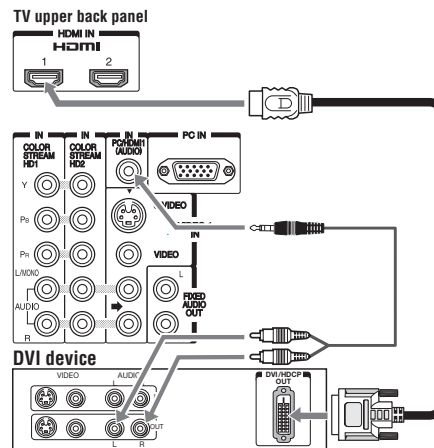

Note: To ensure that the HDMI or DVI device is reset properly, it is recommended that you follow these procedures:

- When turning on your electronic components, **turn on the TV first** and then the HDMI or DVI device.
- When turning off your electronic components, **turn off the HDMI or DVI device first** and then the TV.

[1] EIA/CEA-861-E compliance covers the transmission of uncompressed digital video with high-bandwidth digital content protection, which is being standardized for reception of high-definition video signals. Because this is an evolving technology, it is possible that some devices may not operate properly with the TV.

HDMI, the HDMI logo and High-Definition Multimedia Interface are trademarks or registered trademarks of HDMI Licensing LLC.

Chapter 2: Connecting your TV

REGZA-LINK® connection

You can control the basic functions of connected audio/video devices using the TV's remote control if you connect a REGZA-LINK® compatible audio receiver or playback device. For an explanation of setup and operations, see pages 49–50.

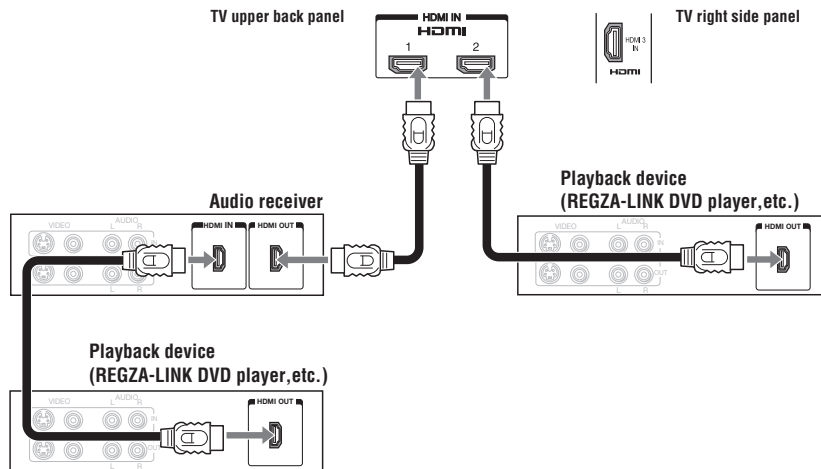

To connect an audio receiver and playback devices, you will need:

- HDMI cables (☞ page 12)

Note:

- If several devices are connected, REGZA-LINK® feature may not operate properly.
- For proper operation, it is recommended that you use HDMI cables with the HDMI Logo (HDMI).

Before controlling the device(s):

- After completing the above connections, set the **REGZA-LINK Setup** menu as you desire (☞ page 50).
- The connected devices must also be set. For details, see the operation manual for each device.
- The REGZA-LINK® feature uses the CEC technology as regulated by the HDMI standard.
- This feature is limited to models incorporating Toshiba's REGZA-LINK. However, Toshiba is not liable for those operations. Refer to the individual instruction manuals for compatibility information.

Chapter 2: Connecting your TV

Connecting a digital audio system

The TV's **DIGITAL AUDIO OUT** terminal outputs a Dolby® Digital  or 2-channel down-mixed PCM (pulse-code modulation) signal for use with an external Dolby® Digital decoder or other external audio system with optical audio input.

You will need:

- optical audio cable (Use an optical audio cable that has the larger "TosLink" connector and not the smaller "mini-optical" connector.)

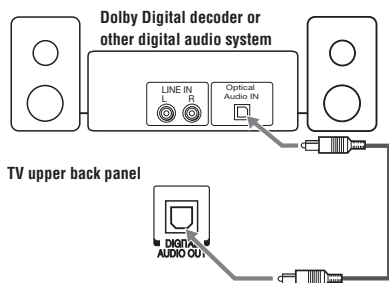

To control the audio:

- Turn on the TV and the digital audio device.
- Press **MENU** on the remote control to open the **SETUP** menu.
- Press **▲** or **▼** to select **AV Connection** and press **ENTER**.

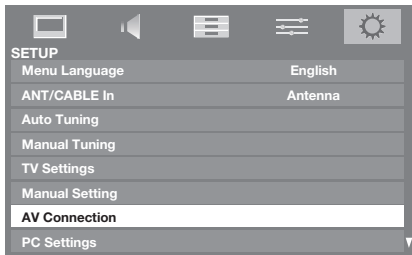

- Press **▲** or **▼** to select **Digital Audio Output**, and then press **◀** or **▶** to select either **Auto** or **PCM** (see "Selecting the optical audio output format" on page 43).

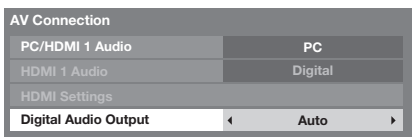

Note:

- Some audio systems may not be compatible with Dolby Digital bitstream signals. Older audio systems that are not compatible with standard optical out signals may not work properly, creating a high noise level that may

damage speakers or headphones. THIS DAMAGE IS NOT COVERED BY YOUR WARRANTY.

- The **DIGITAL AUDIO OUT** terminal may not output some digital audio sources because of copy restrictions.
- The Dolby Digital format is only available when tuned to a digital RF channel.

* Manufactured under license from Dolby Laboratories. Dolby, and the double-D symbol are trademarks of Dolby Laboratories.

Connecting an audio system

This connection allows you to use external speakers with an external analog audio amplifier to adjust the sound level.

You will need:

- standard audio cables

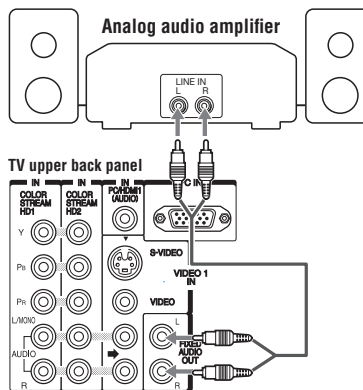

To control the audio:

- Turn on the TV and the stereo amplifier.
- Minimize the sound volume from the TV's built-in speakers and control the volume level using the amplifier's remote control.

Connecting a personal computer (PC)

With either the PC IN or HDMI connection, you can watch your computer's display on the TV and hear the sound from the TV's speakers.

To connect a PC to the PC IN terminal on the TV:
When connecting a PC to the PC IN terminal on the TV, use an analog RGB (15-pin) computer cable and a PC audio cable.

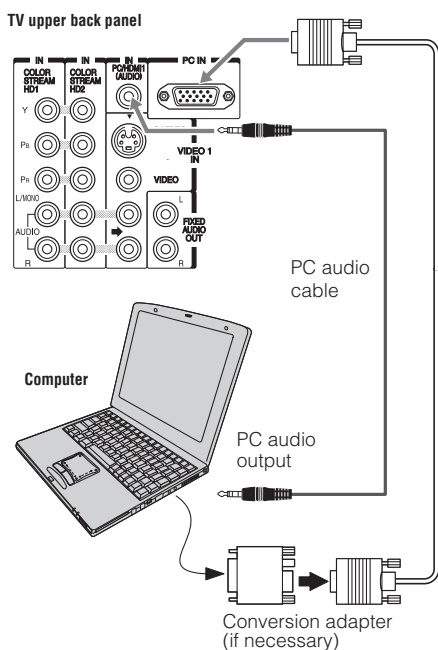

- To use a PC, set the monitor output resolution on the PC before connecting it to the TV. The PC IN terminal can accept and display VGA, SVGA, XGA, WXGA, and SXGA signal formats. For detailed signal specifications, see page 63.
- To display the optimum picture, use the PC settings feature (see "Using the PC settings feature" on page 47).

Note:

- The PC audio input terminals on the TV are shared with the HDMI 1 analog audio input terminals.
- Some PC models cannot be connected to this TV.
- An adapter is not needed for computers with a compatible mini D-sub 15-pin terminal.
- Depending on the DVD's title and the specifications of the PC on which you are playing the DVD-Video, some scenes may be skipped or you may not be able to pause during multi-angle scenes.

- Signal names for mini D-sub 15-pin connector

Pin No.	Signal name	Pin No.	Signal name	Pin No.	Signal name
1	R	6	Ground	11	NC
2	G	7	Ground	12	NC
3	B	8	Ground	13	H-sync
4	NC *	9	NC	14	V-sync
5	NC	10	Ground	15	NC

*NC=Not connected

To connect a PC to the HDMI terminal on the TV:
When connecting a PC to the HDMI terminal on the TV, use an adapter cable and analog audio cables. If connecting a PC with an HDMI terminal, use an HDMI cable. Separate analog cables are not necessary (see page 12).

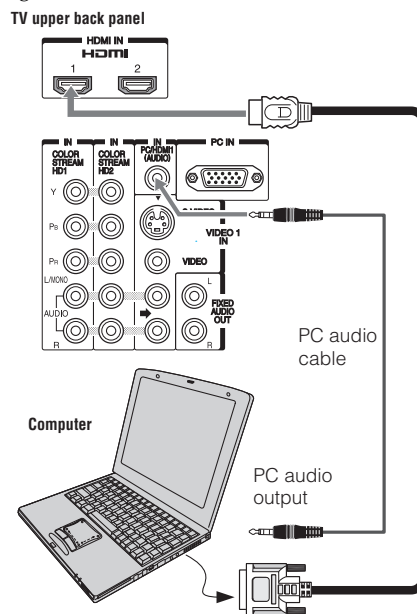

The HDMI input can accept and display VGA, SVGA, XGA, WXGA, SXGA, 480i (60 Hz), 480p (60 Hz), 720p (60 Hz), 1080i (60 Hz), and 1080p (24 Hz/60 Hz) signal formats. For detailed signal specifications, see page 64.

Note:

- The edges of the images may be hidden.
- If receiving a 480i (HDMI), 480p (HDMI), 720p, 1080i, or 1080p signal program, Native mode scales the video to display the entire picture within the borders of the screen (i.e. no overscanning).

Chapter 3: Using the remote control

Preparing the remote control for use

Your TV remote control can operate your TV and many other devices such as cable converter boxes, satellite receivers, VCRs, DVD players, and HTIBs (home theater in a box), even if they are different brands.

If you have a Toshiba device:

Your TV remote control is preprogrammed to operate most Toshiba devices (see page 22).

If you have a non-Toshiba device or a Toshiba device that the remote control is not preprogrammed to operate:

You can program the TV remote control so it will operate the other device (see page 23).

Installing the remote control batteries

- 1 Slide the battery cover off the back of the remote control.

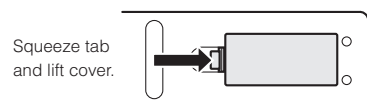

- 2 Install two "AAA" size alkaline batteries. Match the + and - symbols on the batteries to the symbols on the battery compartment.

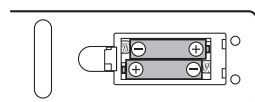

- 3 Slide the battery cover on to the remote control until the lock snaps.

Caution: Batteries must not be exposed to excessive heat such as sunshine, fire or the like.

Note:

- Be sure to use AAA size alkaline batteries.
- Dispose of batteries in a designated disposal area.
- Batteries should always be disposed of with the environment in mind. Always dispose of batteries in accordance with applicable laws and regulations.
- If the remote control does not operate correctly, or if the operating range becomes reduced, replace batteries with new ones.
- When necessary to replace batteries in the remote control, always replace both batteries with new ones. Never mix battery types or use new and used batteries in combination.
- Always remove batteries from the remote control if they are dead or if the remote control is not to be used for an extended period of time. This will prevent battery acid from leaking into the battery compartment.

Chapter 3: Using the remote control

Learning about the remote control

The buttons used for operating the TV only are described here. For the REGZA-LINK remote control functions, see the section "Using REGZA-LINK" (page 49). For a complete list of the remote control's functions, see the remote control functional key chart (page 22).

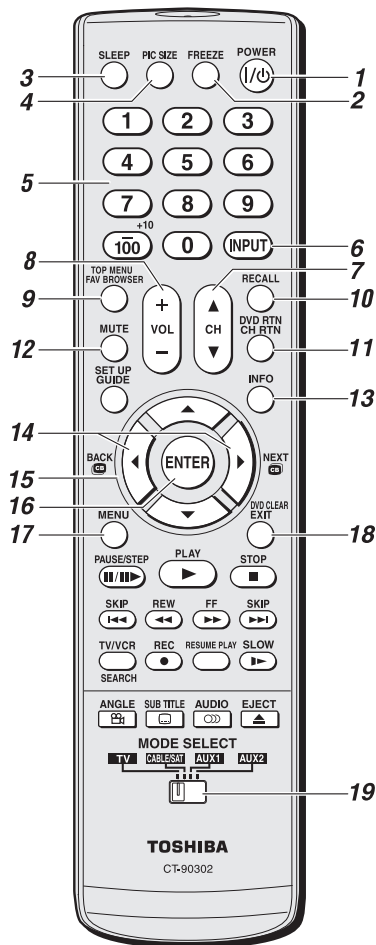

Note: The error message "Not Available" may appear if you press a key for a function that is not available.

- 1 **POWER** turns the TV on and off. When the TV is on, the green LED indicator on the TV front will be illuminated.
- 2 **FREEZE** freezes the picture. Press again to restore the moving picture (page 38).
- 3 **SLEEP** accesses the sleep timer (page 48).
- 4 **PIC SIZE** cycles through the picture sizes (page 36).
- 5 **Channel Numbers (0–9, –/100)** directly tune channels. The **100** button is used to enter two part channel numbers (page 35) or to edit the Favorites List (page 33).
- 6 **INPUT** selects the video input source (page 32).
- 7 **CH ▲▼** cycles through programmed channels when no menu is on-screen (page 35).
- 8 **VOL + –** adjusts the volume level.
- 9 **FAV BROWSER** accesses the Favorites List in the Channel Browser™ (page 33).
- 10 **RECALL** displays TV status information (page 52).
- 11 **CH RTN** returns to the last viewed channel or source (page 35).
- 12 **MUTE** reduces or turns off the sound (page 42).
- 13 **INFO** displays TV status information as well as program details, when available (page 52).
- 14 **BACK ◀ / ▶ NEXT** While watching TV, these buttons open the Channel Browser™ and tune to the previous/next channel in the channel history (page 34).
- 15 **Arrow buttons (▲▼◀▶)** When a menu is on-screen, these buttons select or adjust programming menus.
- 16 **ENTER** activates highlighted items in the main menu system.
- 17 **MENU** accesses the main TV menu system (page 26).
- 18 **EXIT** closes on-screen menus.
- 19 **MODE SELECT** switch selects between TV, CABLE/SAT, AUX1, and AUX2 modes. Set to "TV" to control the TV.

Using the remote control to control your other devices

If you have a non-Toshiba device or a Toshiba device that the remote control is not preprogrammed to operate, you must first program the remote control to recognize the device (if you have not already done so) (page 23).

To use your TV remote control to operate:

- Cable converter box or satellite receiver, set the **MODE SELECT** switch to **CABLE/SAT**.
- VCR, set the **MODE SELECT** switch to **AUX1**.
- DVD player or HTIB, set the **MODE SELECT** switch to **AUX2**.

Note: Even after the TV remote control is programmed, it may not operate certain features on any other devices. If this happens and you wish to use those features, you will need to use the device's original remote control.

Point the remote control directly at the device.

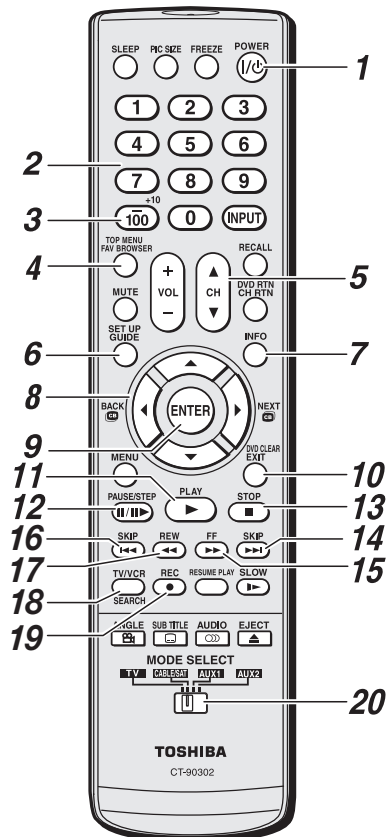

- 1 POWER** Turns the selected device on and off.
- 2 Channel Numbers (0-9)** Press to directly access channels (as opposed to).
- 3 +10** Press to directly access DVD chapters higher than 10.
- 4 TOP MENU** Accesses a DVD's top menu.
- 5 CH ▲▼** For channels programmed into the channel memory (page 28):
 - ▲ selects the next higher channel.
 - ▼ selects the next lower channel.
- 6 GUIDE** Displays the channel guide in the CABLE/SAT mode.
 - SET UP** Accesses a DVD's setup menu in the AUX mode.
- 7 INFO** Displays TV status information on-screen.
- 8 ▲▼◀▶** Press to navigate DVD menus (may not work on some DVD players).
- 9 ENTER** Required by some satellite receivers and DVD players to activate certain functions.
- 10 DVD CLEAR** Press to reset the title and chapter number.
- 11 PLAY** Begins playback of a tape or DVD.
- 12 PAUSE** Press during play or record mode to pause the picture; press again to restart.
- 13 STOP** Stops the tape or DVD.
- 14 SKIP** Skips forward to locate later DVD chapters.
- 15 FF** Fast-forwards the tape or DVD. (Press during play mode to view the picture moving rapidly forward.)
- 16 SKIP** Skips back to beginning of current DVD chapter, or locates previous chapters.
- 17 REW** Rewinds/reverses the tape or DVD. (Press during play mode to view the picture moving rapidly backward.)
- 18 TV/VCR** To view one program while recording another, press to select TV mode.
 - SEARCH** Selects a specific DVD chapter, title or time.
- 19 REC** Starts tape recording.
- 20 MODE SELECT** Switches Set to "TV" to control the TV; "CABLE/SAT" to control a cable converter box or satellite receiver; "AUX1" to control a VCR; "AUX2" to control a DVD player or HTIB.

Chapter 3: Using the remote control

Remote Control functional key chart

REMOTE CONTROL KEY	Toshiba TV	CABLE	SAT (satellite)	AUX 1 (VCR)	AUX 2 (DVD or HTIB)
POWER	Power	Power	Power	Power	Power
SLEEP	Sleep timer	← TV	← TV	← TV	← TV
PIC SIZE	Picture size	← TV	← TV	← TV	← TV
FREEZE	FREEZE	← TV	← TV	← TV	← TV
1-9	Digit 1-9	Digit 1-9	Digit 1-9	Digit 1-9	Digit 1-9
0	Digit 0	Digit 0	Digit 0	Digit 0	Digit 0
100/-/+10	– (sub CH)	---	– (sub CH)	100	+10
INPUT	TV/Video select	← TV	← TV	← TV	← TV
FAV BROWSER/ TOP MENU	FAV BROWSER	---	---	---	Top Menu
MUTE	Sound mute	← TV	← TV	← TV	← TV
SET UP/GUIDE	---	---	SAT Guide	---	Setup
VOL + –	Volume up/down	← TV	← TV	← TV	← TV
CH▲▼	Channel up/down	Channel up/down	Channel up/down	Channel up/down	Channel up/down
RECALL	RECALL	← TV	← TV	← TV	← TV
CH RTN/DVD RTN	Previous channel	---	---	---	DVD Return
INFO	Info	---	Info	---	Display
ENTER	Enter	---	Select, Enter	---	Enter
▲▼	Menu up/down	---	Menu up/down	---	Menu up/down
◀	Menu left/ Channel Browser™	---	Menu left	---	Menu left
▶	Menu right/ Channel Browser™	---	Menu right	---	Menu right
MENU	Menu	---	Action Menu	---	DVD Menu
EXIT/DVD CLEAR	Exit	---	Exit	---	DVD Clear
PAUSE/STEP	Pause*	---	---	Pause	Pause
PLAY	Play*	---	---	Play	Play
STOP	Stop*	---	---	Stop	Stop
SKIP ◀◀	Skip REW*	---	---	---	Skip REW
SKIP ▶▶	Skip FWD*	---	---	---	Skip FWD
REW	Rewind*	---	---	Rewind	Rewind
FF	Fast FWD*	---	---	Fast FWD	Fast FWD
TV/VCR/ SEARCH	---	---	---	TV/VCR	DVD search
REC	---	---	---	Record (2 click)	Record (2 click)
RESUME PLAY	---	---	---	---	Resume Play
SLOW +	---	---	---	---	SLOW FWD
ANGLE	---	---	---	---	DVD Angle
SUB TITLE	---	---	---	---	DVD Sub title
AUDIO	---	---	---	---	DVD Audio
EJECT	---	---	---	---	DVD Eject

Note:

- “---” = key does not send a signal in that remote control mode.
- “← TV” = key will affect the TV, even though the remote control is in another mode.
- “*” = This function is available for REGZA-LINK® (page 49).

Programming the remote control to control your other devices

Your Toshiba TV remote control is preprogrammed to operate most Toshiba devices. To program your TV remote control to operate a non-Toshiba device (or a Toshiba device that it is not preprogrammed to operate), follow the steps below. For details on using the remote control to operate the device, see page 21.

- 1 In the remote control code table (pages 24–25), find the code for your device. If more than one code is listed, try each one separately until you find one that works.
- 2 Set the **MODE SELECT** switch to the type of device you are programming the remote control to operate — CABLE/SAT (for a cable converter box or satellite receiver), AUX1 (for a VCR or TV/VCR combo), or AUX2 (for a DVD player or HTIB [home theater in a box]).
- 3 While holding down **RECALL**, press the Channel Number buttons to enter the 3-digit code for your device.
- 4 To test the code, turn on the device, point the remote control at it, and press **POWER**. See notes below.
 - If the correct code was entered, the device will turn off.
 - If the device does not respond, repeat steps 1–4 using another code.
 - If the device does not respond to another code, you will need to use the remote control that came with the device.
- 5 Remember to set the **MODE SELECT** switch back to “TV” to control the TV.
- 6 For future reference, write down the code(s) you used:

DEVICE	CODE	DEVICE	CODE

Note:

- In addition to **POWER**, confirm that all necessary keys on the TV remote control operate your device. If some keys are not operational, repeat the device code setup using another code (if other codes are listed for your device). If, after trying all listed codes, the necessary keys do not operate your device, use the device’s original remote control.
- Every time you change the batteries, you will need to reprogram the remote control.

- Some newer VCRs respond to either of two codes. These VCRs have a switch labeled “VCR1/VCR2.” If your VCR has this kind of switch and does not respond to the codes for your VCR brand, set the switch to the other position (“VCR1” or “VCR2”) and reprogram the remote control.

Remote control codes

In some cases, you may not be able to operate your device with the TV remote control. Your device may use a code that is not recognized by the TV remote control. If this happens, use the device's remote control.

Cable converter box

ABC	061, 062, 063, 082, 084, 087, 092, 096, 098
Archer	065, 092, 097, 099
Cableview	064, 094
Century	092
Citizen	090, 092, 097
Contec	083, 085, 086, 088, 093, 098
Diamond	093
GE	061, 062
Gemini	069, 070, 094
Hamlin	093
Hitachi	062, 095, 096
Jasco	097
Motorola/GI/Jerrold	062, 069, 071, 082, 086, 089, 096, 107
Magnavox	072, 096
Memorex	092, 104
Multi Canal	090
Novavision	101
Panasonic	081, 083, 085
Philco	087
Philips	066, 067, 068, 070, 072, 073, 074, 075, 092
Pioneer	076, 077
Proscan	061, 062
Radio Shack	092, 097, 099
RCA	064, 081
Realistic	065
Recoton	102
Samsung	077, 090
Scientific Atlanta	063, 078, 079, 080, 088, 098, 101, 105
Sears	095
Signature	062
Signature 2000	096
Sprucer	081, 085
Starcom	069, 082, 087, 096, 103, 104
Stargate	069, 090
Sylvania	095, 100
Television	090
Texscan	100
Tocom	071, 084, 085
U. S. Electronics	087, 096, 098
United Cable	082
Universal	065, 092, 097, 099, 102, 103
Wards	096

Satellite receiver

Alphastar	038, 059
Chaparral	034
DISH Network	057
Drake	020, 040, 044, 046, 050, 053
Echostar	018, 041, 051
Express Vu	057
Fujitsu	027
GE	008, 009, 013
General Instruments	010, 011, 012, 022, 023, 031, 049
Hitachi	033
Hughes	033
Hughes Network Systems	019
Intersat	048
Janeil	027
JVC	017, 057
Kenwood	029
Magnavox	060
Optimus	058
Pansat	036, 052
Primestar	015, 042
Proscan	008, 009, 013
Radio Shack	022, 023, 030
RCA	008, 009, 013, 016
Realistic	030
Samsung	059
Sony	014, 055
Star Choice	057, 106
Star Trak	025, 026, 037, 054
STS	024
Toshiba	000, 001, 002, 003, 004, 005, 006, 007, 020, 031, 056
Uniden	021, 028, 030, 032, 035, 039, 043, 045, 047, 058
Zenith	027
Action	078
GE	059, 062
Goldstar	065
Panasonic	065
Precision	078
Quasar	065
Realistic	079
Sony	074
Toshiba	057
Zenith	065
Totevision	009, 010, 065

TV/VCR Combo

Action	078
GE	059, 062
Goldstar	065
Panasonic	065
Precision	078
Quasar	065
Realistic	079
Sony	074
Toshiba	057
Zenith	065
Totevision	009, 010, 065

DVD/VCR Combo

Go Video	DVD=087, VCR=081
JVC	DVD=088, VCR=082
RCA	DVD=089, VCR=083
Samsung	DVD=090, VCR=084
Sanyo	DVD=091, VCR=085
Zenith	DVD=092,

VCR=086

DVD player

Aiwa	006, 015
Apex	016, 017
BOSE	097
Broksonic	018
Clarion	019
Classic	020
Daewoo	021
Denon	022, 023, 024, 025
Emerson	026, 027
Fisher	028
Funai	027
GE	001, 029, 030
Go Video	087
GPX	031
Hitachi	005, 032, 033, 034, 035
JVC	003, 007, 036, 042, 088
Kenwood	037
Konka	008, 009
Magnavox	004, 038
Memorex	039
Mintek	040
NAD	026
Nakamichi	041
Norcent	043
Onkyo	044
Oritron	058
Panasonic	010, 045, 046, 047, 048, 049, 050
Philips	004, 051
Pioneer	052, 053, 054, 055
Proscan	001, 056
Qwestar	057, 058
RCA	001, 002, 059, 089
Sampo	060
Samsung	061, 062, 086, 090
Sansui	073
Sanyo	063, 091
Sharp	064, 067
Sherwood	074
Sony	011, 012, 065, 066, 068, 069, 070
Sylvania	027
Teac	071
Technics	072
Techwood	075
Toshiba	000, 013, 076, 077, 078
Yamaha	079, 080, 081
Zenith	014, 082, 092

Portable DVD player

Aiwa	093
Audiovox	094, 095
Panasonic	024, 096, 099
RCA	098

VCR

Admiral	049
Aiko	019
Aiwa	018
Akai	003, 004, 037, 038,





Chapter 3: Using the remote control

Audiovox	039, 058, 069	Minolta	024, 025, 035, 063	Symphonic	044, 072
Bell & Howell	010	Mitsubishi	020, 024, 025, 028, 039, 043, 065		018, 050, 051, 053, 073, 079
Broksonic	007, 068	Montgomery Ward	049	Tandy	007
Calix	008, 017	Motorola	049	Tashiko	010
Carver	010	MTC	009, 046, 061	Tatung	037
CCE	026	Multitech	009, 012, 018	Teac	018, 029, 037
Citizen	019	NEC	005, 006, 007, 012, 014, 037, 043, 053, 054, 067, 070	Technics	036
	009, 010, 011, 012, 013, 014, 015, 019, 057, 073	Nikko	010	Teknika	010, 018, 065
Colortyme	005	Noblex	009	Toshiba	000, 011, 021, 023, 024, 028, 030, 039, 057, 074, 078, 079, 100, 101
Craig	009, 010, 016, 061, 065, 079	Optimus	010, 049, 065		
Curtis Mathes	001, 005, 009, 012, 014, 040, 048, 053, 056, 057	Optonica	031	Totevision	009, 010, 065
Daewoo	011, 013, 015, 017, 018, 019, 057, 078	Orion	054, 057, 062, 065, 068, 072	Unitec	073
Daytron	078	Panasonic	036, 045, 046, 057, 061, 072, 079	Unitech	009
Denon	063	Pentax	012, 024, 025, 035, 042, 053, 063	Vector Research	005, 006, 011, 012, 053
Dimensia	001, 048	Pentex Research	014	Video Concepts	005, 006, 011, 012, 039, 053
Electrohome	010, 020, 065	Philco	026, 027, 063	Wards	009, 010, 011, 016, 018, 020, 024, 025, 031, 035, 049, 051, 056, 057, 060, 065, 066, 079
Emerson	003, 008, 010, 011, 017, 018, 020, 028, 039, 054, 057, 062, 065, 068, 072	Philips	026, 031, 044, 057	White Westinghouse	073
Fisher	007, 016, 021, 022, 023, 057, 064, 068, 070, 071, 079	Pioneer	006, 024, 043, 055	XR-1000	018
Fuji	004, 041	Portland	012, 013, 015	Yamaha	005, 006, 007, 014, 037, 053
Funai	018, 073	Proscan	001, 002, 048	Zenith	004, 032, 034, 041, 047, 069, 086
Garrard	018	Proton	061		
GE	001, 002, 009, 040, 042, 048, 056	Quasar	045	HTIB	
Go Video	056, 059, 061, 081	Radio Shack	010, 031, 065	Lasonic	083
Goldstar	005, 010, 014, 054, 056, 065, 067	Radio Shack/Realistic	007, 009, 010, 016, 018, 020, 021, 022, 031, 049	Panasonic	084
Gradiente	018, 065	Radix	010	Venturer	085
Harman Kardon	005	RCA	001, 002, 003, 009, 024, 025, 029, 035, 040, 042, 045, 048, 055, 056, 063, 071, 083		
Hitachi	024, 025, 035, 037, 042, 063, 070, 080	Realistic	007, 009, 010, 011, 016, 018, 020, 021, 022, 031, 049, 051, 056, 060, 065, 075, 079		
JBL	076	Ricoh	047		
JC Penney	005, 006, 007, 008, 009, 010, 023, 024, 025, 026, 035, 056, 061, 063, 065	Runco	034		
Jensen	024, 025, 037, 050	Samsung	009, 011, 038, 056, 073, 084		
JVC	005, 006, 007, 014, 037, 043, 055, 062, 063, 068, 082	Sansui	006, 037, 043, 061		
Kenwood	005, 006, 007, 012, 014, 037, 043, 050, 053, 068, 071	Sanyo	007, 009, 016, 054, 064, 068, 071, 075, 079, 085		
Kodak	010	Scott	008, 011, 017, 028, 030, 057, 065, 072		
LG	010	Sears	007, 010, 016, 021, 022, 023, 024, 025, 035, 053, 057, 063, 064, 065, 068, 071, 075, 079		
Lloyds	053, 073, 079	Sharp	013, 020, 031, 049, 051, 060, 066		
Logik	061	Shintom	004, 025, 032, 061		
LXI	010	Signature	049		
Magnasonic	061, 065, 078	Signature 2000	075		
Magnavox	026, 027, 034, 044, 057, 061, 072	Singer	047, 061		
Marantz	005, 006, 007, 012, 014, 026, 053, 067	Sony	004, 032, 033, 041, 052, 058, 070, 074, 076, 077, 080		
Memorex	007, 009, 010, 016, 018, 034, 049, 063, 065, 066, 068, 075, 079	STS	035		
MGA	020, 028, 039	Sylvania	018, 026, 027, 028,		
MGN	056				

Chapter 4: Menu layout and navigation

Main menu layout

To open the main menus (illustrated below), press **MENU**  on the remote control or TV control panel.

Icon	Item	Page
PICTURE 	Picture Mode	39
	Reset	39
	Backlight	39
	Contrast	39
	Brightness	39
	Color	39
	Tint	39
	Sharpness	39
	Advanced Picture Settings	53
	Control Visualization	40
	TheaterLock	40
	SOUND 	MTS
Bass		42
Treble		42
Balance		42
Advanced Sound Settings		56
Dolby Volume		43
Dynamic Range Control		43
Media Player		57
APPLICATIONS 	Channel Browser	33
	Favorites Browser	33
	REGZA-LINK Player Control	49
	On Timer	48
	Sleep Timer	48
	REGZA-LINK Setup	49
	Photo Viewer Setup	58
PREFERENCES 	Channel Browser Setup	33
	CC and Digital Audio Selectors	41
	PIN Setting	43
	Parental Control and Locks	44
	Auto Aspect	38
	4:3 Stretch	38
	Blue Screen	30
	Transparency	30
	TOSHIBA Illumination	30



Icon	Item	Page
SETUP 	Menu Language	27
	ANT/CABLE In	28
	Auto Tuning	28
	Manual Tuning	28
	TV Settings	29
	Manual Setting	29
	AV Connection	51
	PC Settings	47
	Picture Position	38
	Quick Setup	27
	Power-On Mode	30
	Location	30
	System Information	31
	Reset TV	31

Navigating the menu system

You can use the buttons on the remote control or TV control panel to access and navigate your TV's on-screen menu system.

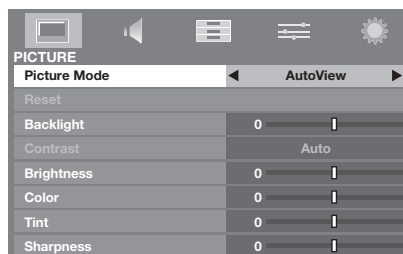
- Press **MENU**  to open the menu.



- Press **◀** or **▶** on the remote control or TV control panel to select the top menu, its respective items will appear below.
- To use the items, press **▲** or **▼** on the remote control or TV control panel to move up and down through them.
- Press **◀** or **▶** to adjust settings.
- All menus close automatically if you do not make a selection within 60 seconds.
- To close a menu instantly, press **MENU**  or **EXIT** .

Chapter 5: Setting up your TV

Initial Setup

When you first turn on or reset the TV, the Initial Setup window will appear.

- 1 In the **Menu Language** field, press ◀ or ▶ to select your preferred language.
- 2 Press ▲ or ▼ to select **Time Zone** and set your desired time zone with ◀ or ▶ and press ENTER.
- 3 Next, the **Location** setting window will appear. For normal home use, press ◀ or ▶ to select **Home** and press ENTER.
- 4 Next, **ANT/CABLE In** setup window will appear. Press ◀ or ▶ to select the input source (**Cable** or **Antenna**) for the **ANT/CABLE** input on the TV.
- 5 If you select **Antenna**, the **Channel Tuning Mode** setup window will appear. To tune only digital channels, select **Digital**. To tune digital channels preferentially over analog when entering channel number directly, select **Auto**. For normal tuning, select **Standard**. Press ENTER to continue to Auto Tuning.
- 6 Press ENTER to select **Start Scan** and continue with the Auto Tuning.

You can stop the Initial Setup with EXIT. However if you do not finish the entire Initial Setup process, the Initial Setup window will appear every time you turn on the TV.

Quick Setup from the SETUP menu

You can conveniently change various basic TV settings from the Quick Setup item located under the SETUP menu.

- 1 Press MENU to open the **SETUP** menu.
- 2 Press ▲ or ▼ to select **Quick Setup** and press ENTER.
- 3 A confirmation message will appear on the screen, press ◀ or ▶ to select **Yes** and press ENTER.
- 4 Other procedures are the same as **Initial Setup** (see left-hand column).

Selecting the menu language

You can choose from three different languages (English, Français and Español) for the on-screen display of menus and messages.

- 1 From the **SETUP** menu, highlight **Menu Language**.
- 2 Press ◀ or ▶ to select your preferred menu language.

Configuring the antenna input source for the ANT/CABLE terminal

- 1 From the **SETUP** menu, highlight **ANT/CABLE In.**
- 2 Press ◀ or ▶ to select the input source (**Antenna** or **Cable**) for the **ANT/CABLE** input on the TV and press **EXIT**.

Programming channels into the TV's channel memory

When you press **CH** or **CH** on the remote control or TV control panel, your TV will stop only on the channels you programmed into the TV's channel memory. Follow the steps below to program channels into the TV's channel memory.

Auto Tuning

Your TV can automatically detect all active channels in your area and store them in its memory. After the channels are programmed automatically, you can manually add or erase individual channels in the channel memory.

Note:

- You must configure the **ANT/CABLE** input source before programming channels.
- If the **ANT/CABLE** input is configured for **Cable**, the automatic channel programming process erases channels that were previously programmed into the TV's memory.
- If the **ANT/CABLE** input is configured for **Antenna**, the automatic channel programming process adds newly found channels to the existing set of programmed channels (and does NOT erase channels that were previously programmed into the TV's memory.) To remove an Antenna source channel from the memory, you must set it to Skip.
- To tune the TV to a channel not programmed in the channel memory, you must use the Channel Number buttons on the remote control.
- Programming channels when the **ANT/CABLE** input is configured for **Cable** will take substantially longer than when the antenna input is configured for **Antenna**. This is normal; however, once channel programming is finished, you should not have to repeat the programming process again unless your Cable TV service lineup changes significantly.

- 1 Configure the **ANT/CABLE** input, if you have not already done so (see left-hand column).
- 2 From the **SETUP** menu, highlight **Auto Tuning**.
- 3 A screen will appear warning that previous programs and settings will be deleted.
- 4 Press **ENTER** to start Auto Tuning. The TV will automatically cycle through all the channels, and store all active channels in the channel memory. When Auto Tuning is finished, press **CH** or **CH** to view the programmed channels.

Manual Tuning

After automatically programming channels into the channel memory, you can manually enter channels if the physical channel is known.

- 1 From the **SETUP** menu, highlight **Manual Tuning** and press **ENTER**.
- 2 Use the channel number buttons on the remote control to enter the channel number (up to three-digit number) and press **ENTER**.

If channels are found, they will be listed at the bottom of the screen. Analog channels will be noted by an "ATV" symbol and digital channels by a "DTV" symbol.

Setting channel skip

To prevent certain channels from being viewed, channel positions can be skipped.

- 1 From the **SETUP** menu, highlight **TV Settings** and press **ENTER**.
- 2 Press **▲** or **▼** to select **Channel Options** and press **ENTER**. The list of channels will appear.

Ch.	Type			
5-1	DTV		<input type="checkbox"/>	<input type="checkbox"/>
6	ATV		<input type="checkbox"/>	<input type="checkbox"/>
6-1	DTV		<input type="checkbox"/>	<input type="checkbox"/>
8	ATV		<input type="checkbox"/>	<input type="checkbox"/>
9	ATV		<input type="checkbox"/>	<input type="checkbox"/>
10	ATV		<input type="checkbox"/>	<input type="checkbox"/>
11	ATV		<input type="checkbox"/>	<input type="checkbox"/>
12	ATV		<input type="checkbox"/>	<input type="checkbox"/>

- 3 Press **▲** or **▼** to select a channel position to be skipped and press **ENTER**. A tick will appear in the box. To remove the tick, press **ENTER** again.

Note: Skipped channels cannot be selected with **CH** or **CH**; however, they can still be accessed using the number keys on the remote control.

Setting video input skip

If you set a video input source to be skipped, it will be skipped over when selecting the input by repeatedly pressing **INPUT**.

To turn on the skip:

- 1 Tune to the video input source to be skipped.
- 2 From the **SETUP** menu, highlight **Manual Setting** and press **ENTER**. The setting window will appear.
- 3 Press **▲** or **▼** to select **⏮** (skip on) and press **EXIT**.

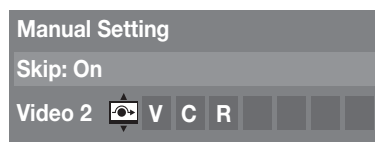

To turn off the skip:

- 1 Select the video input that is set to skip by direct number entry or by using **▲** or **▼** and then press **ENTER** (see "Selecting the video input source to view" on page 32).
- 2 From the **SETUP** menu, highlight **Manual Setting** and press **ENTER**. The setting window will appear.
- 3 Press **▲** or **▼** to select **⏭** (skip off) and press **EXIT**.

Labeling video input sources

You can label video input sources.

- 1 Tune to the input you want to label.
- 2 From the **SETUP** menu, highlight **Manual Setting** and press **ENTER**. The setting window will appear.
- 3 Press **▶** to move from the skip selection in order to select a label, press **▲** or **▼** to put in the desired characters, and press **ENTER**.



- 4 Repeat steps 1 through 3 for other inputs.
- 5 To save your settings, press **ENTER**.

Note: Available characters are 0-9, A-Z, (,), *, +, -, and /.

Setting the time zone

The Time Zone setup will allow you to specify the correct time zone for your region. This feature will allow the TV status information to show the correct time zone information for your viewing area.

- 1 From the **SETUP** menu, highlight **TV Settings** and press **ENTER**.
- 2 Press **▲** or **▼** to select **Local Time Setting** and press **ENTER**.
- 3 Highlight **Time Zone** and press **◀** or **▶** to set your desired time zone.
- 4 If you want to activate the daylight saving time, highlight **Daylight Saving Time**.
- 5 Press **◀** or **▶** to select **On** and press **EXIT**.

Selecting the location

You can select Home or Store for the TV location. For normal home use, select Home.

- 1 From the **SETUP** menu, highlight **Location**.
- 2 Press **◀** or **▶** to select **Home** and press **EXIT**.

Selecting the TOSHIBA Illumination mode

You can set the illumination mode of the TOSHIBA logo located on the front panel to On or Off.

- 1 From the **PREFERENCES** menu, highlight **TOSHIBA Illumination**.
- 2 Press **◀** or **▶** to select either **On** or **Off**, and then press **EXIT**.

Selecting the Power-On Mode

You can select either Power-Saving or Fast mode.

- **Power-Saving** mode keeps power consumption in standby mode to below 1W. As a result, it takes a bit longer for the TV to turn on.
- **Fast** mode increases power consumption in standby mode. As a result, the TV will turn on more quickly.

- 1 From the **SETUP** menu, highlight **Power-On Mode**.
- 2 Press **◀** or **▶** to select either **Power-Saving** or **Fast**, and then press **EXIT**.
Select **Power-Saving** for optimal energy efficiency.

Using Blue Screen

With the Blue Screen feature, the screen will turn blue, and the sound will be muted on analog channels and external input modes when no signal is received.

- 1 From the **PREFERENCES** menu, highlight **Blue Screen**.
- 2 Press **◀** or **▶** to select **On**, and press **EXIT**.

Setting the screen transparency

You can set the transparency of the on-screen display system.

- 1 From the **PREFERENCES** menu, highlight **Transparency**.
- 2 Press **◀** or **▶** to select **Low**, **Middle**, **High** or **Off**, and press **EXIT**.

Viewing the system status

- 1 From the **SETUP** menu, highlight **System Information**.
- 2 Press **ENTER** to display the system information.

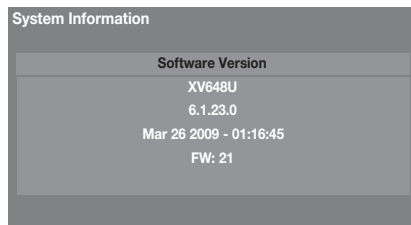

Reset Factory Defaults

You can reset all settings and channels to their factory default values.

- 1 From the **SETUP** menu, highlight **Reset TV** and press **ENTER**.
- 2 Enter your PIN code (if PIN code has been set).
- 3 Press **◀** or **▶** to select **Yes** and press **ENTER**. The TV will turn off automatically.

To cancel the reset:

Press **◀** or **▶** to select **No** and press **ENTER**.

Chapter 6: Using the TV's features

Selecting the video input source to view

To select the video input source to view:

- 1 Press **INPUT** on the remote control or TV control panel.
- 2 And then either:
 - a) Press 0–8; or
 - b) Repeatedly press **▲** or **▼** on the remote control and then press **ENTER** to change the input; or
 - c) Repeatedly press **INPUT** on the remote control or TV control panel to change the input.

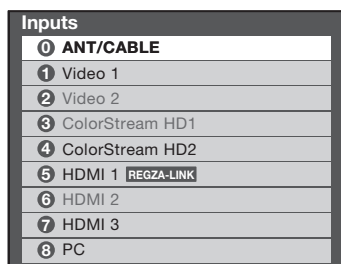

Note:

- You can label the video input sources according to the specific devices you have connected to the TV (see "Labeling video input sources" on page 29).
- Sources can also be skipped (see "Setting video input skip" on page 29).
- Inputs that are set to skip will be grayed out and will be skipped over only when selecting inputs by repeatedly pressing **INPUT**.
- If one or more REGZA-LINK® devices are connected to an HDMI input, the REGZA-LINK® icon will appear. In this case, the label (see page 29) will not appear in the input selector.

To select a REGZA-LINK® device:

- 1 Press **▲** or **▼** to highlight an appropriate HDMI input.
- 2 Press **▶** to display the list of REGZA-LINK® devices for that input.
- 3 If there are multiple REGZA-LINK® devices on the input, use **▲** or **▼** to highlight a particular device.
- 4 Press **ENTER** to select the device and change inputs.

Tuning channels

Tuning channels using the Channel Browser™

The Channel Browser™ provides an easy navigation interface for all your channels and inputs. This feature allows you to:

- Navigate the contents of all of your inputs.
- Keep a list of your favorite channels (see "Favorites Browser," below).
- Keep a history of the last 32 channels or inputs viewed.
- Quickly surf and tune your recently viewed channels/inputs from the Channel Browser™ History List (illustrated on the next page).
- Surf via Browse mode (to immediately tune channels as you highlight them in the Channel Browser™) or Select mode (to surf over channels in the Channel Browser™ before you select one to tune).
- Quickly change inputs from the Inputs List.
- Quickly select REGZA-LINK® devices from the REGZA-LINK List.

Favorites Browser

The Favorites Browser allows you to quickly set up a favorite channels/inputs list that is integrated into the Channel Browser™.

To add a favorite channel/input:

- 1 Tune to the channel or input.
- 2 Press and hold **FAV BROWSER** on the remote control for 3 seconds.

Note: Additions are added to the beginning of the Favorites list on the left side of the Channel Browser™.

To delete a favorite channel/input:

- 1 Press **FAV BROWSER** to open the Favorites browser list.
- 2 Highlight the channel or input to delete by pressing **BACK** or **NEXT**.
- 3 Press and hold **100** for 3 seconds. The channel/input will be removed from the Favorites list.

To set up the Channel Browser™:

- 1 From the **PREFERENCES** menu, highlight **Channel Browser Setup** and press **ENTER**.
- 2 Press **▼** or **▲** to highlight **Navigation**, and then press **◀** or **▶** to select either **Select Mode** or **Browse Mode**.
- 3 Press **▼** or **▲** to highlight **History List**, and then press **◀** or **▶** to select the setting you prefer: **On** or **Off**.

Note: **History List** will be cleared every time the TV is powered off.

- 4 Press **▼** or **▲** to highlight **ANT/CABLE List**, and then press **◀** or **▶** to select **On** or **Off**.
- 5 Press **▼** or **▲** to highlight **Inputs List**, and then press **◀** or **▶** to select **On** or **Off**.
- 6 Press **▼** or **▲** to highlight **Favorites List**, and then press **◀** or **▶** to select **On** or **Off**.
- 7 Press **▼** or **▲** to highlight **REGZA-LINK List**, and then press **◀** or **▶** to select **On** or **Off**.

Note: **REGZA-LINK List** will be automatically grayed out and set to **Off** when **Enable REGZA-LINK** is switched to **Off**. (page 50)

- 8 To return to factory defaults, highlight **Reset** and press **ENTER**.

To open the Channel Browser™:

- Press **BACK** or **NEXT** on the remote control.
- Press **BACK** or **NEXT** to surf backward or forward through the tuned 32 channels in the History list, the channels in the ANT/CABLE channel list, the inputs in the Inputs list, the REGZA-LINK® devices in the REGZA-LINK list, or the favorite channels/inputs in the Favorites list.

Elements of the Channel Browser™

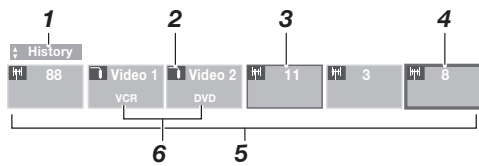

- 1 Current list (**History**, **ANT/CABLE**, **Inputs**, **Favorites**, or **REGZA-LINK**)
- 2 Input type
- 3 Channel or input currently being viewed
- 4 Channel or input that is currently highlighted in the browser
- 5 Channels stored in the History List
- 6 Input labels

To toggle among the available lists:

After opening the Channel Browser™, press ▲ or ▼ to toggle among **History**, **ANT/CABLE**, **Inputs**, **Favorites**, and **REGZA-LINK**.

Note:

- The Channel Browser™ opens in **History List** by default. Once another list has been selected, the Channel Browser™ will open in the last selected list.
- If all lists are turned off, pressing **BACK** ◀ or **NEXT** ▶, or **FAV BROWSER** will not display the Channel Browser™. If **Favorites List** is turned off, **FAV BROWSER** will have no effect.
- Pressing **FAV BROWSER** will bring up the Channel Browser™ Favorites list regardless of the last selected list in the Channel Browser™.

To tune to a channel or input in Browse mode:

- 1 While watching TV, press **BACK** ◀ or **NEXT** ▶ to open the Channel Browser™ and surf back to a previous item or surf forward to the next item in the list. In **Browse Mode**, when you stop on an item in the Channel Browser™, it will be highlighted and the TV will automatically tune to the channel or input.
- 2 Press **EXIT** to close the Channel Browser™.

To tune to a channel or input in Select mode:

- 1 While watching TV, press **BACK** ◀ or **NEXT** ▶ to open the Channel Browser™ and surf back to a previous item or forward to the next item in the list. In **Select Mode**, when you stop on an item in the Channel Browser™, it will be highlighted but you must press **ENTER** to tune the TV to the highlighted item.
- 2 Press **ENTER** to tune the TV to the highlighted item.
- 3 Press **EXIT** to close the Channel Browser™.

Adding and clearing channels and inputs in the History List

Adding channels and inputs to the History List:

As a channel or input is tuned, the Channel Browser™ adds it to the History List and displays it on the “right side” of the Channel Browser™. Previously tuned channels/inputs are “shifted” to the left, eventually moving off the left side. Press **BACK** ◀ to surf backward through the previously tuned channels/inputs. Any channel or input that is tuned repeatedly will not be repeated in the History List but instead will be moved to the end of the list on the right side of the Channel Browser™.

The Channel Browser™ will store the following channels:

- All channels that are tuned using the numeric buttons on the remote control.
- All channels that are tuned for at least 5 seconds using **CH** or **CH** on the remote control.

Note: Whenever an item is selected that cannot be tuned (for various reasons), the TV will automatically tune to the previously viewed channel or input.

Clearing channels from the History List:

- Reconfiguring the **ANT/CABLE** input will clear the History List.

Note: See page 28 for details on configuring the antenna input.



- Once 32 channels or inputs are stored in the History List, the oldest item will be removed from the list when a new channel or input is tuned.
- Turning off the TV will clear the History List.

Setting the Channel Tuning Mode







This feature allows you to choose how tuning will be handled for analog and digital channels when the TV is in Antenna mode.

Note: To use this feature, **ANT/CABLE In** must be set to **Antenna** (see page 28).

The channel tuning mode has three options.

Mode	Description
Standard	Both analog and digital channels can be tuned normally
Auto (default)	Digital channels will have priority when manually entering a channel number using the Channel Numbers (0-9) on the remote control, analog channels can still be tuned by  /  if available
Digital	Only digital channels can be tuned



To set the Channel Tuning Mode:

- 1 From the **SETUP** menu, highlight **TV Settings** and press .
- 2 Press  or  to highlight **Channel Tuning Mode**.
- 3 Press  or  to select your desired mode and then press .

Note: The Channel Options window as well as the Channel Browser ANT/CABLE List will be updated automatically when you change the mode. Also, the History List will be cleared, but the Favorites List will be saved.

Tuning to the next programmed channel

To tune to the next programmed channel:

Press  or  on the remote control or TV control panel.



Note: This feature will not work unless you program channels into the TV's channel memory (see page 28).

Tuning to a specific channel (programmed or unprogrammed)

Tuning analog channels:



Press the Channel Number (0-9) on the remote control. For example, to select channel 125, press 1, 2, 5, then .

Tuning digital channels:

Enter the major Channel Number (0-9) on the remote control, followed by the dash () button and then the sub-channel number. For example, to select digital channel 125-1, press 1, 2, 5, -, 1, and then .



Switching between two channels using Channel Return





The Channel Return feature allows you to switch between two channels without entering an actual channel number each time.

- 1 Select the first channel you want to view.
- 2 Select a second channel using the Channel Number buttons (and the dash () button if needed).
- 3 Press  on the remote control. The previous channel will display. Each time you press , the TV will switch back and forth between the last two channels that were tuned.

Note: If you press  from a non-antenna input, the TV will return to the last-viewed input.

Switching between two channels using SurfLock™

The SurfLock™ feature temporarily “memorizes” one channel to the  button, so you can return to that channel quickly from any other channel by pressing . To memorize a channel to the  button:

- 1 Tune the TV to the channel you want to program into the  button.
- 2 Press and hold  for about 2 seconds until the message “Memorized” appears on-screen. The channel has been programmed to the .
- 3 You can then change channels repeatedly, and when you press , the memorized channel will be tuned.

The TV will return to the memorized channel one time only. Once you press  and then change channels again, the CH RTN memory will be cleared and the button will function as Channel Return, by switching back and forth between the last two channels that are tuned. This feature also works for external inputs.

Selecting the picture size

You can view many program formats in a variety of picture sizes—**Native**, **4:3**, **Full**, **TheaterWide 1**, **TheaterWide 2**, **TheaterWide 3**, **Normal** and **Dot by Dot**.

Note: The "picture size" illustrations are examples only. The format of the image (in any of the picture sizes) will vary depending on the format of the signal you are currently watching. Select the picture size that displays the current program the way that looks best to you.

You can save separate picture size preferences for each input on your TV.

To select the picture size using the remote control:

- 1 Press **PIC SIZE** on the remote control.
- 2 While the **Picture Size** screen is open, you can do one of the following to select the desired picture size:
 - Repeatedly press **PIC SIZE**.
 - Press the corresponding Number button while the **Picture Size** screen is open.
 - Press **▲** or **▼** and **ENTER** while the **Picture Size** screen is open.

Note: Some of the picture sizes may not be available depending on the receiving signal format.

Using these functions to change the picture size (i.e., changing the height/ width ratio) for any purpose other than your private viewing may be prohibited under the Copyright Laws of the United States and other countries, and may subject you to civil and criminal liability.

Note: If you select one of the TheaterWide® picture sizes, the top and bottom edges of the picture (including subtitles or captions) may be hidden. To view the hidden edges, either adjust the **Picture Position** or try viewing the program in **4:3** or **Full** picture size.

Chapter 6: Using the TV's features

Picture Size

Native
(for 480i (HDMI), 480p (HDMI), 720p, 1080i, and 1080p signal programs)

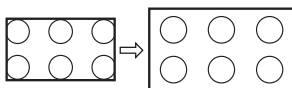

- If receiving a 1080i, 1080p, 720p, 480i (HDMI), or 480p (HDMI) signal program, Native mode scales the video to display the entire picture within the borders of the screen (i.e. no overscanning).
- This is especially useful for external HD sources such as DVHS movies, Video Games or PC graphics.
- None of the picture is hidden.

Note:

- This mode is supported only for HDMI (1080i, 1080p, 720p, 480i, and 480p), ColorStream (1080i and 720p), and ANT/CABLE (digital) inputs (1080i, 1080p, and 720p).
- Depending on the input signals, the border of the picture may be hidden, displayed in black, or noisy.

4:3

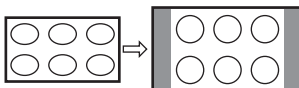
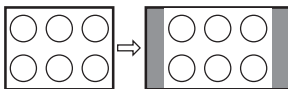

Some program formats will display with sidebars and/or bars at the top and bottom.

Full

(for 16:9 [480i, 480p] source programs only)

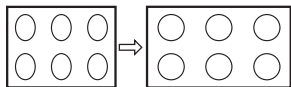

If receiving a squeezed 4:3 format program, the picture is stretched wider to fill the width of the screen but not stretched taller.

(for 1080i, 1080p, and 720p program sources)

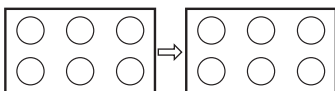

The edges surrounding the picture may be hidden.

Picture Size

TheaterWide 1
(for 4:3 format programs)

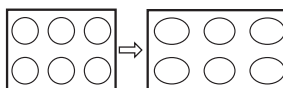

The center of the picture remains close to its original proportion, but the left and right edges are stretched wider to fill the screen.

TheaterWide 2
(for letter box programs)

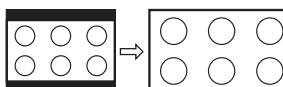

The top and bottom edges of the picture may be hidden*.

TheaterWide 3
(for letter box programs with subtitles)

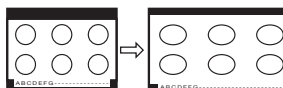

The top and bottom edges are hidden*.

Normal

(for VGA, SVGA, XGA, WXGA, and SXGA sources only)

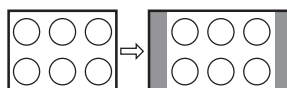

"Normal" is a non-stretched display. Some input signal formats will display with sidebars and/or bars at the top and bottom.

Dot by Dot

(for VGA, SVGA, XGA, WXGA, and SXGA sources only)

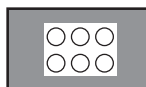

"Dot by Dot" is a non-scaling display. Depending on the input signal format, the picture is displayed with sidebars and/or bars at the top and bottom. (Example: VGA input source)

* To view the hidden areas (such as subtitles or captions), see "Scrolling the Picture" (page 38).

Scrolling the picture

If the edges of the picture are cut off, you can adjust the image position.

Note: You can adjust the picture position when the picture size is set to **TheaterWide 2** or **TheaterWide 3**.

- 1 From the **SETUP** menu, highlight **Picture Position** and press **ENTER**.
- 2 Press **▲** or **▼** to select **Vertical Position**.
- 3 Press **◀** or **▶** to make the appropriate adjustments. The adjustment range is from **-5** to **+10**.

Note: This feature is not available on digital channels.

Using the Auto Aspect Ratio feature

When the auto aspect ratio feature is set to **On**, the TV will automatically select the picture size when one of the following input sources is received:

- A 480i, 480p, 720p, 1080i digital signal from the **ANT/CABLE** input
- A 480i signal from the **Video 1** or **Video 2** input
- A 480i signal from the **ColorStream HD1** or **HD2** input
- A 480i, 480p, 720p, 1080i, 1080p, or VGA (60/72/75 Hz) signal from the **HDMI 1/2/3** input

Note: The auto aspect ratio feature is not applicable to the PC input.

- 1 From the **PREFERENCES** menu, highlight **Auto Aspect**.
- 2 Press **◀** or **▶** to select **On**, and then press **EXIT**.

Using the 4:3 Stretch

When 4:3 Stretch is activated, the size switching system changes 4:3 programs into full screen picture.

- 1 From the **PREFERENCES** menu, highlight **4:3 Stretch**.
- 2 Press **◀** or **▶** to select **On**, and then press **EXIT**.

Note: When **Auto Aspect** is set to **Off**, this feature will be grayed out.

Using the FREEZE feature

- 1 When viewing the TV, press **FREEZE** to make the picture a still picture.
- 2 To return to moving picture, press **FREEZE** again.

Note: If the TV is left in **FREEZE** mode for more than 15 minutes, the **FREEZE** mode will automatically be released and the TV will return to moving picture.

Using the **FREEZE** function for any purpose other than your private viewing may be prohibited under the Copyright Laws of the United States and other countries, and may subject you to civil and criminal liability.

Adjusting the picture

Selecting the picture mode

You can select your desired picture settings from the following modes, as described below.

Mode	Picture Quality
AutoView™	Automatically adjusts picture settings based on ambient light conditions and input signal content
Sports	Bright and dynamic picture
Standard	Standard picture settings
Movie	Lower contrast for darkened room
Game	Designed for playing a video game requiring split-second timing between the on-screen display and input from the controller
PC	Designed for viewing of PC tables and documents

Note:

- Because the **AutoView** mode automatically adjusts picture settings based on ambient light conditions and input signal content, some menus will be grayed out when it is selected.
- **PC** mode is available for HDMI and PC inputs only (not displayed for other input sources).
- **Game** mode cannot be turned on when the **ANT/CABLE** input is selected.

- 1 From the **PICTURE** menu, highlight **Picture Mode**.
- 2 Press ◀ or ▶ to select the picture mode you prefer and press **EXIT**.

Note: The picture mode you select affects the current input only. You can select a different picture mode for each input.

Adjusting the picture quality

The picture quality you adjusted under a certain picture mode is saved to the picture mode of same name.

Selection	Pressing ◀	Pressing ▶
Backlight*	darker	lighter
Contrast	lower	higher
Brightness	darker	lighter
Color	paler	deeper
Tint	reddish	greenish
Sharpness	softer	sharper

* This feature adjusts the brightness of the entire screen. When in video mode and no signal is input, this will automatically be set to 0. (Settings are stored in memory.)

Note: Some menus cannot be adjusted when the picture mode is set to **AutoView** or **TheaterLock** is set to On.

To adjust the picture quality:

- 1 From the **PICTURE** menu, highlight the setting you would like to adjust (**Backlight, Contrast, Brightness, Color, Tint, or Sharpness**).
- 2 Once you select the desire item, press ◀ or ▶ to adjust the setting, as described in the table above, and then press **EXIT**.

Note: The picture setting that you adjusted affects the current input only. You can adjust the picture quality separately for each input.

To revert to the factory defaults:

- 1 Select the picture mode you want to reset.
- 2 From the **PICTURE** menu, highlight **Reset** and press **ENTER**.
- 3 A confirmation message will appear. Press ◀ or ▶ to select **Yes**, and then press **ENTER**.

Using the TheaterLock™ feature

The TheaterLock feature allows you to “lock” items in the PICTURE menu that affect the picture display. These items will be grayed out and unavailable when the TheaterLock setting is set to “On”.

- 1 From the **PICTURE** menu, highlight **TheaterLock**.
- 2 Press ◀ or ▶ to select **On**, and then press **ENTER**.

Viewing the Control Visualization window

This feature displays a histogram and control curve illustrating the brightness of the TV.

- 1 From the **PICTURE** menu, highlight **Control Visualization** and press **ENTER**. The histogram window will appear.

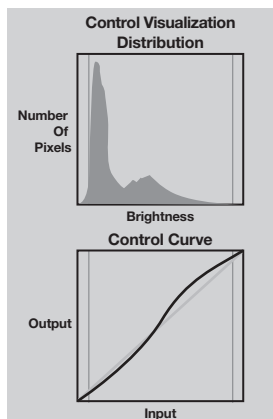

- 2 Press **CHRTN** to close the window and go back to menu. If no key is pressed within 10 minutes, it closes automatically.

Using the closed caption mode

Analog CC Mode

The closed caption mode has two options:

- **Captions**—An on-screen display of the dialogue, narration, and sound effects of TV programs and videos that are closed captioned (usually marked “CC” in program guides).
- **Text**—An on-screen display of information not related to the current program, such as weather or stock data (when provided by individual stations).

To turn on the closed caption mode:

- 1 From the **SETUP** menu, highlight **TV Settings** and press **ENTER**.
- 2 Press ▼ or ▲ to select **Closed Captions Settings** and press **ENTER**.
- 3 Press ▼ or ▲ to select **Closed Captions** and press ◀ or ▶ to select **On**.

To view captions or text:

From the **Closed Captions Settings** menu, highlight the **Analog CC Mode**.

- **To view captions:**
Press ◀ or ▶ to highlight **CC1**, **CC2**, **CC3**, or **CC4**.



Note: If the program or video you selected is not closed captioned, no captions will display on-screen.

- **To view text:**
Press ◀ or ▶ to highlight **T1**, **T2**, **T3**, or **T4**.

A black and white image of a panda eating bamboo leaves. Below the image, a table titled "WORLD WEATHER" displays weather information for four cities: London, Moscow, Paris, and Tokyo. The table includes columns for temperature in Fahrenheit and Celsius, and the current weather condition.

	Temps		Current Weather
	F	C	
LONDON	51	11	Clear
MOSCOW	57	15	Cloudy
PARIS	53	12	Clear
HONG KONG	66	19	Cloudy
TOKYO	65	18	Rain

Note: If text is not available in your area, a black rectangle may appear on screen. If this happens, set the Closed Captions setting to **Off**.

Note: A closed caption signal may not display in the following situations:

- When a videotape has been dubbed
- When the signal reception is weak
- When the signal reception is non-standard

Digital CC Settings

You can customize the closed caption display characteristics by changing the background color, opacity, text size, type, edge, and color.

Note:

- This feature is available for digital channels only.
- You cannot set the Caption Text and Background as the same color.

Mode	Description
Caption Size	Auto, Small, Standard, Large
Caption Text Type	Auto, Default, Mono w. Serif, Prop. w. Serif, Mono w/o Serif, Prop. w/o Serif, Casual, Cursive, Small Capitals
Caption Text Edge	Auto, None, Raised, Depressed, Uniform, Left Drop Shadow, Right Drop shadow
Caption Text Color	Auto, Black, White, Red, Green, Blue, Yellow, Magenta, Cyan
Text Foreground Opacity	Auto, Transparent, Translucent, Flashing, Solid
Background Color	Auto, Black, White, Red, Green, Blue, Yellow, Magenta, Cyan
Text Background Opacity	Auto, Transparent, Translucent, Flashing, Solid
Caption Text Edge Color	Auto, Black, White, Red, Green, Blue, Yellow, Magenta, Cyan

To customize the closed captions:

- 1 From the **SETUP** menu, highlight **TV Settings** and press **ENTER**.
- 2 Press **▲** or **▼** to select **Closed Captions Settings** and press **ENTER**.
- 3 Then highlight **Digital CC Settings** and press **ENTER**.
- 4 Press **▲** or **▼** to highlight the characteristic you want to change, and then press **◀** or **▶** to select the format for that characteristic (see table above).

CC Selector

You can use the **CC and Digital Audio Selectors** to temporarily override the default analog caption mode (set in **Analog CC Mode**) for a particular channel. However, once you change to another analog channel, the closed caption setting will automatically change back to the current **Analog CC Mode** setting. You can also use the **CC Selector** to select digital closed caption services (if available). When such services are not available, the **CC Selector** presents a default list of services. If the selected service is not available, the next best service will be used instead.

To select closed captions:

- 1 From the **PREFERENCES** menu, highlight **CC and Digital Audio Selectors** and press **ENTER**.
- 2 Press **▲** or **▼** to highlight **Closed Caption**, press **◀** or **▶** to select the desired service, and then press **EXIT**.

Adjusting the audio

Muting the sound

Press **MUTE** on the remote control to partially reduce (1/2 MUTE) or turn off (MUTE) the sound. Each time you press **MUTE**, the mute mode will change in the following order:



If the closed caption mode is set to **Off** when you select "MUTE" mode, the closed caption feature is automatically activated if the TV program is Closed Captioned. To mute the audio without automatically activating the closed caption feature, use **VOL** to set the volume to 0. See "Using the closed caption mode" (page 40) for more information on closed caption modes.

Note: If you modify items in the **SOUND** menu while mute is active, the mute will automatically be cancelled to allow for proper adjustment.

Using the digital audio selector

You can use the **Digital Audio** setting to conveniently switch between audio tracks on a digital channel (for those channels that have multiple audio tracks).

To use the digital audio selector:

- 1 From the **PREFERENCES** menu, highlight **CC and Digital Audio Selectors** and press **ENTER**.
- 2 Press **▲** or **▼** to select **Digital Audio**.
- 3 Press **◀** or **▶** to select the desired service, and then press **EXIT**.

Selecting stereo/SAP broadcasts

The multi-channel TV sound (MTS) feature allows you to output high-fidelity stereo sound. MTS also can transmit a second audio program (SAP) containing a second language, music, or other audio information (when provided by individual stations).

When the TV receives a stereo or SAP broadcast, the word "STEREO" or "SAP" appears on-screen when **RECALL** is pressed. The MTS feature is only available for analog signals on the **ANT/CABLE** input.

To listen a stereo sound:

- 1 From the **SOUND** menu, highlight **MTS**.
- 2 Press **◀** or **▶** to select **Stereo** and press **EXIT**.

Note:

- You can typically leave the TV in **Stereo** mode because it will automatically output the type of sound being broadcast (stereo or monaural).
- If the stereo sound is noisy, select **Mono** to reduce the noise.

To listen a second audio program on an analog station (if available):

Select **SAP** in step 2.

Note:

- A Second Audio Program (SAP) can be heard only on those TV stations that offer it. For example, a station might broadcast another language as a second audio program. If you have SAP on, you will see the current program on the screen but hear the other language instead of the program's normal audio.
- If you have SAP on and the station you are watching is not broadcasting a second audio program, the station's normal audio will be output. However, occasionally there is no sound at all in **SAP** mode. If this happens, set the MTS feature to **Stereo** mode.

Adjusting the audio quality

You can adjust the audio quality by adjusting the bass, treble, and balance.

- 1 From the **SOUND** menu, highlight the item you want to adjust (**Bass**, **Treble**, or **Balance**).
- 2 Press **◀** or **▶** to adjust the level of the desired item, and then press **EXIT**.
 - **◀** makes the bass or treble weaker or increases the balance in the left channel (depending on the item selected).
 - **▶** makes the bass or treble stronger or increases the balance in the right channel (depending on the item selected).

Selecting the optical audio output format

You can use this feature to select the optical audio output format when you connect a Dolby Digital decoder or other digital audio system to the **DIGITAL AUDIO OUT** terminal on the TV.

- 1 Tune to a digital source on the **ANT/CABLE** input.
- 2 From the **SETUP** menu, highlight **AV Connection** and press **ENTER**.
- 3 Press **▲** or **▼** to select **Digital Audio Output**.
- 4 Press **◀** or **▶** to select **Auto** or **PCM**, and then press **EXIT**.
Auto: this mode outputs Dolby Digital or PCM to the digital audio output socket providing what is being broadcast.
PCM: this mode outputs PCM format to the digital audio output socket.

Using the Dolby® Digital Dynamic Range Control feature

This dynamic range control feature causes the ATSC dynamic range to be further compressed, allowing you to switch from digital to analog broadcasts at the same dynamic range.

- 1 From the **SOUND** menu, highlight **Dynamic Range Control**.
- 2 Press **◀** or **▶** to select **On**, and then press **EXIT**.

Note:

- This feature is only available on digital channels.
- This feature will also affect to the Digital Audio Output when the optical audio output format is set to PCM.

Using Dolby® Volume

This feature provides a consistent sound volume regardless of programs, channels or input sources.

- 1 From the **SOUND** menu, highlight the **Dolby Volume**.
- 2 Press **◀** or **▶** to select **Low**, **High** or **Off**.

Note:

- If *Dynamic Range Control* is set to **On**, this feature will be grayed out.
- This feature does not affect the audio signal output from the **DIGITAL AUDIO OUT** and **FIXED AUDIO** terminals.

Setting the PIN code

A PIN code is necessary for some menus.

Registering a new PIN code

- 1 From the **PREFERENCES** menu, highlight **PIN Setting** and press **ENTER**. A new screen will display.
- 2 Press the number buttons to enter a four-digit number. Re-enter the PIN code to confirm it.

Changing or deleting your PIN code

- 1 From the **PREFERENCES** menu, highlight **PIN Setting** and press **ENTER**. The PIN code screen will display.
- 2 Press the number buttons to enter your four-digit PIN code.
 - Change PIN
Highlight **Change PIN** and press **ENTER**.
 - Delete PIN
Highlight **Delete PIN** and press **ENTER**.
If you delete the PIN code, the settings of **Parental Control and Locks** are reset.

If you cannot remember your PIN code

While the PIN code entering screen is displayed, press **RECALL** four times within five seconds. The PIN code will be cleared and you can enter a new PIN code.

Blocking TV programs and movies by rating (V-Chip)

Some TV programs and movies include signals that classify the content of the program (violence, sex, dialogue, language). The V-Chip feature in this TV detects the signals and blocks the programs according to the ratings you select. (For rating descriptions, see the tables on the next page.)

Note: Rating blocking is a function of the V-Chip feature in this TV, which supports the U.S. V-Chip system only.

To block and unblock TV programs and movies:

- 1 From the **PREFERENCES** menu, highlight **Parental Control and Locks** and press **ENTER**.
- 2 Enter your four-digit PIN code.
- 3 Press **▲** or **▼** to highlight **Enable Rating Blocking**.
- 4 Press **◀** or **▶** to select **On**.
- 5 Press **▼** to highlight **Edit Rating Limits** and press **ENTER**.
The **Edit Rating Limits** screen appears.
- 6 Press **▲**, **▼**, **◀** or **▶** and then press **ENTER** to select the level of blocking you prefer. A box with an "X" is a rating that will be blocked. As you highlight a rating, a definition for the rating appears at the bottom of the screen.

Downloading an additional rating system for blocking TV programs and movies

An additional rating system may be available for use in selectively blocking programs.

Note: The currently tuned station must be receiving a digital signal before an additional rating system can be downloaded.

To download the additional rating system (if available):

- 1 From the **PREFERENCES** menu, highlight **Parental Control and Locks** and press **ENTER**.
- 2 Enter your four-digit PIN code. **Parental Control and Locks** window is displayed.
- 3 Press **▲** or **▼** to highlight **Enable Rating Blocking**.
- 4 Press **◀** or **▶** to select **On**.
- 5 Press **▼** to highlight **Edit Rating Limits** and press **ENTER**.
The **Edit Rating Limits** screen appears.
- 6 Highlight **Alt RS** and press **ENTER**. The **Edit Alternate Ratings** screen will appear.
Note:
 - The **Alt RS** button will only be available if an additional rating system is currently available.
 - It may take several minutes for the TV to download the additional rating system.
 - The information displayed in the **Alternate Ratings** screen will depend on the configuration of the additional rating system available at the time of download.
- 7 Press **▲**, **▼**, **◀** or **▶**, and then press **ENTER** to select the level of blocking you prefer. A box with an "X" is a rating that will be blocked.

Note:

- The additional rating system can only be downloaded one time. You will not be able to download any updates to the rating system should such updates become available.
- The additional rating system is not designed, transmitted, or controlled by the TV or Toshiba, nor is the availability of an additional rating system determined or controlled by Toshiba. Similarly, the rating of programs in an additional rating system is not determined, transmitted, or controlled by the TV or Toshiba.
- The additional rating system is an evolving technology; therefore, availability, content, and format may vary.

Chapter 6: Using the TV's features

Independent rating system for broadcasters	
Ratings	Description and Content themes
TV-MA	Mature Audience Only (This program is specifically designed to be viewed by adults and therefore may be unsuitable for children under 17.) L) Crude or indecent language S) Explicit sexual activity V) Graphic violence
TV-14	Parents Strongly Cautioned (This program contains some material that many parents would find unsuitable for children under 14 years of age.) D) Intensely suggestive dialogue L) Strong, coarse language S) Intense sexual situations V) Intense violence
TV-PG	Parental Guidance Suggested (This program contains material parents may find unsuitable for younger children.) D) Some suggestive dialogue L) Infrequent coarse language S) Some sexual situations V) Moderate violence
TV-G	General Audience (Most parents would find this program suitable for all ages.)
TV-Y7, TV-Y7FV	Directed to Older Children (This program is designed for children age 7 and above. Note: Programs in which fantasy violence may be more intense or more combative than other programs in this category are designated TV-Y7FV.)
TV-Y	All Children (This program is designed to be appropriate for all children.)

Independent rating system for movies	
Ratings	Description and Content themes
X	X-rated (For adults only)
NC-17	Not intended for anyone 17 and under
R	Restricted (Under 17 requires accompanying parent or adult)
PG-13	Parents Strongly Cautioned (Some material may be inappropriate for children under 13)
PG	Parental Guidance Suggested (Some material may not be suitable for children)
G	General Audience (Appropriate for all ages)

Note:

- If you place an "X" in the box next to "None Rated", programs rated "None" or "Not Rated" will be blocked; however, programs that do not provide any rating information will not be blocked.
- To display the rating of the program you are watching, press **RECALL** on the remote control. If it is rated "None," the word "NONE" appears in the **RECALL** screen (as shown below right). If rating information is not provided, no rating will appear in the **RECALL** screen.

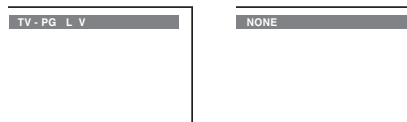

Unlocking programs

If you try to tune the TV to a program that exceeds the rating limits you set, the TV will enter program lock mode and a warning message will appear on-screen. Follow the instructions to temporarily unlock the program.

Locking channels

With the Lock feature, you can lock specific channels. The locked channels can only be accessed by entering the PIN.

- 1 From the **SETUP** menu, highlight **TV Settings** and press **ENTER**.
- 2 Press **▲** or **▼** to select **Channel Options** and press **ENTER**. The list of channels will appear.

Ch.	Type		
5-1	DTV	<input type="checkbox"/>	<input type="checkbox"/>
6	ATV	<input type="checkbox"/>	<input type="checkbox"/>
6-1	DTV	<input type="checkbox"/>	<input type="checkbox"/>
8	ATV	<input type="checkbox"/>	<input type="checkbox"/>
9	ATV	<input type="checkbox"/>	<input type="checkbox"/>
10	ATV	<input type="checkbox"/>	<input type="checkbox"/>
11	ATV	<input type="checkbox"/>	<input type="checkbox"/>
12	ATV	<input type="checkbox"/>	<input type="checkbox"/>

- 3 Press **▶** and then **▲** or **▼** to select a channel in the lock column.
- 4 PIN code entry will be required to set a locked channel.

Note: If the PIN code has not been set yet, a warning message will appear.

- 5 A tick will appear in the box. To remove the tick, press **ENTER** again.

Using the input lock feature

You can use the Input Lock feature to lock the video inputs (**Video 1**, **Video 2**, **ColorStream HD1**, **ColorStream HD2**, **HDMI 1**, **HDMI 2**, **HDMI 3**, and **PC**) and channels 3 and 4. You will not be able to view the input sources or channels until you unlock the inputs.

- 1 From the **PREFERENCES** menu, highlight **Parental Control and Locks** and press **ENTER**.
- 2 Enter your four-digit PIN code.
- 3 Press **▲** or **▼** to highlight **Input Lock**.
- 4 Press **◀** or **▶** to select **Video**, **Video+** or **Off** and press **EXIT**.

Mode	Description
Video	Locks Video 1, Video 2, ColorStream HD1/HD2, HDMI 1, HDMI 2, HDMI 3, and PC.
Video+	Locks Video 1, Video 2, ColorStream HD1/HD2, HDMI 1, HDMI 2, HDMI 3, PC, and channels 3 and 4. <ul style="list-style-type: none"> • Select Video+ if you play video tapes via the ANT/CABLE input.
Off	Unlocks all video inputs and channels 3 and 4.

Using the GameTimer® feature

You can use the GameTimer® to set a time limit for playing a video game (30–120 minutes). When the GameTimer expires, the TV enters Input Lock mode and locks out the input source for the video game device.

- 1 From the **PREFERENCES** menu, highlight **Parental Control and Locks** and press **ENTER**.
- 2 Enter your four-digit PIN code.
- 3 Press **▼** or **▲** to select **GameTimer**, and then press **◀** or **▶** to select **30**, **60**, **90**, or **120** minutes.

To cancel the GameTimer®:

Select **Off** in step 3 above.

To deactivate the Input Lock once the GameTimer® has activated it:

Set the **Input Lock** to **Off** (left-hand column).

Note:

- A message will appear when 10 minutes, 3 minutes, and 1 minute remain on the GameTimer.
- If the TV loses power with time remaining on the GameTimer, when power is restored the TV will enter Input Lock mode (as if the GameTimer had been activated), and you will have to deactivate the Input Lock (left-hand column).

Using the panel lock feature

You can lock the control panel to prevent your settings from being changed accidentally (by children, for example). When **Panel Lock** is **On**, none of the controls on the TV control panel will operate except **POWER**.

- 1 From the **PREFERENCES** menu, highlight **Parental Control and Locks** and press **ENTER**.
- 2 Enter your four-digit PIN code.
- 3 Press **▲** or **▼** to select **Panel Lock**, and then press **◀** or **▶** to select **On**.
When **Panel Lock** is set to **On**, a reminder will appear when the buttons on the TV control panel are pressed. If the **POWER** button is pressed the TV will switch off and can only be brought out of standby by using the remote control.

To unlock the control panel:

Select **Off** in step 3 above.

Using the PC settings feature

You can view an image from a PC on the TV screen. When a PC is connected to the TV's PC IN terminal, you can use the PC Settings feature to make adjustments to the image.

If the edges of the picture are cut off, readjust the **Horizontal Position** and **Vertical Position**. If the picture is affected by interference, readjust the **Clock Phase** and **Sampling Clock**.

- 1 Select PC input mode (ⓘ "Selecting the video input source to view" on page 32).
- 2 From the **SETUP** menu, highlight **PC Settings** and press **ENTER**.
- 3 Press **▲** or **▼** to highlight the item you want to adjust.
- 4 Press **◀** or **▶** to make any appropriate adjustments.

Note: The screen is disrupted momentarily when adjusting the PC settings. This is not a sign of malfunction.

Mode	Description
Horizontal Position	Moves the picture left/right. The adjustment range is within ± 10 from center.*
Vertical Position	Moves the picture up/down. The adjustment range is within ± 10 from center.*
Clock Phase	Helps to reduce noise and sharpen the picture. The adjustment range is within ± 32 from center.
Sampling Clock	Helps to reduce noise and minimize periodic vertical stripes on the screen. The adjustment range is within ± 5 from center.

* The default settings and /or adjustment ranges vary depending on the input signal format.

Setting the PC Audio

This function allows you to output sound from your PC when connecting using the PC IN terminal and an analog RGB cable.

- 1 From the **SETUP** menu, highlight **AV Connection** and press **ENTER**.
- 2 Press **▲** or **▼** to select **PC/HDMI 1 Audio**.
- 3 Press **◀** or **▶** to select **PC**.

Note: Setting PC/HDMI 1 to **PC** will force **HDMI 1 Audio** (ⓘ page 51) to **Digital** mode.

Setting the On Timer

You can set the on timer to automatically turn on the TV to a preset channel or input at a preset time.

To activate the On Timer:

- 1 From the **APPLICATIONS** menu, highlight **On Timer** and press **ENTER**.
- 2 Press **▲** or **▼** to select **Enable On Timer**, and then press **◀** or **▶** to select **On**.

Note: If the *Enable On Timer* is set to **Off**, other menus under *On Timer* cannot be changed.

To set the On Timer:

- 1 From the **APPLICATIONS** menu, highlight **On Timer** and press **ENTER**.
- 2 Press **▲** or **▼** to highlight the item you want to change, and then press **◀** or **▶** to make your desired adjustment.

Item	Description
Input	To select video input source (ANT/CABLE, Video 1, Video 2, ColorStream HD1, ColorStream HD2, HDMI 1, HDMI 2, HDMI 3, or PC).
Channel	To select the channel when the TV turns on.
Volume	To set the volume when the TV turns on.
Time until Power On	To set the time when the TV turns on from now with ◀ or ▶ or the number buttons (maximum of 12 hours and 50 minutes).

Note:

- When the **On Timer** is set to **On**, the *On Timer LED* is turned on (see "LED indications" on page 61).
- If you do not operate the TV for 1 hour after it is powered on by the *On Timer* feature, the TV will automatically turn itself off.

To cancel the On Timer:

- 1 From the **APPLICATIONS** menu, highlight **On Timer** and press **ENTER**.
- 2 Press **▲** or **▼** to select **Enable On Timer**.
- 3 Press **◀** or **▶** to select **Off**.

Setting the Sleep Timer

You can set the sleep timer to turn off the TV after a set length of time (maximum of 12 hours and 50 minutes).

To set the sleep timer using the remote control:

Press **SLEEP** on the remote control to set the length of time until the TV turns off. Repeatedly press **SLEEP** to increase the time in 10-minute increments, or press **▲** or **▼** to increase or decrease the time in 10-minute increments, to a maximum of 12 hours and 50 minutes.

To set the sleep timer using the on-screen menus:

- 1 From the **APPLICATIONS** menu, highlight **Sleep Timer**.
- 2 Press the number buttons to enter the length of time or press **◀** or **▶** to increase or decrease in 10-minute increments (maximum of 12 hours and 50 minutes).

Note: When a power failure occurs, the sleep timer setting may be cleared.

To display the remaining sleep time:

Press **SLEEP**.

To cancel the sleep timer:

Repeatedly press **SLEEP** until it is set to 0 minutes.

Using REGZA-LINK®











This feature uses CEC technology and allows you to control Toshiba REGZA-LINK® compatible devices from the TV remote via HDMI connection (☞ page 16). When **Enable REGZA-LINK** in the **REGZA-LINK Setup** menu is set to **On**, the following REGZA-LINK® functions will be enabled.

REGZA-LINK® playback device (DVD player, etc.) control

With your TV's remote control, or using the REGZA-LINK Player Control menu, you can control the connected REGZA-LINK® playback device you are watching.





Available remote control key functions:

Before using the following key functions, first set the MODE SELECT switch on the remote control to **TV**.

Button	Description
	Begins playback.
	Stops playback.
	Pauses the picture during play or record mode.
	Skips forward.
	Skips backward.
	Fast-forwards.
	Rewinds/reverses.
	Navigates contents menu, etc.
	Enters contents menu, etc.
	Returns to the previous menu.
	Closes the menu.

Note: These functions depend on the devices connected.

REGZA-LINK® Player Control menu functions:

- From the **APPLICATIONS** menu, highlight **REGZA-LINK Player Control** and press .
- Press  or  to select the item you want to control and press .

Item	Description
Power	Turns the selected device on and off.
Root Menu	Accesses the top menu of the selected device.
Contents Menu	Accesses the contents list when you press  . At this time, the REGZA-LINK Player Control menu will disappear.
Setup Menu	Accesses the setup menu of a DVD player.
Top Menu	Accesses the top menu of a DVD during playback.
Menu	Accesses the menu of a DVD during playback.

Note:



- These functions depend on the devices connected.
- The **REGZA-LINK Player Control** item will be grayed out in the following conditions:
 - A non-HDMI input is currently selected.
 - The **Enable REGZA-LINK** item is set to **Off**.
 - The connected REGZA-LINK® device is not a playback or recording device.

REGZA-LINK® input source selection

If a REGZA-LINK® device with HDMI switching capability (e.g. Amplifier) is connected to the HDMI input, you can select another REGZA-LINK® device that is connected to the master HDMI device using  on the remote control or the TV control panel (☞ page 32).

Amplifier VOLUME and MUTE controls

With your TV's remote control, you can adjust or mute the sound volume of your amplifier. First, set the MODE SELECT switch on the remote control to **TV**.

-  adjust the volume level.
-  turns off the sound.

Note:

- To use this function:
 - Set **Speaker Preference** to **Amplifier** in the **REGZA-LINK Setup** menu.
 - Confirm that a connected REGZA-LINK® device (such as DVD player, etc) is selected for the Amplifier input source.
- You can also use this function when the amplifier is connected to the TV's **DIGITAL AUDIO OUT** terminal (not HDMI connection). In this case, select a digital audio input mode on the amplifier.
- These functions depend on the device connected.

Other REGZA-LINK® functions

When **Enable REGZA-LINK** and each item in the **REGZA-LINK Setup** menu are set to **On**, the following functions will be enabled.

Item	Description
TV Auto Power On	If a REGZA-LINK® device is turned on, the TV turns on automatically.
Auto Standby	If the TV is turned off, the TV will send a message to turn off all of the REGZA-LINK® devices connected to the TV.
Amplifier Control	If Amplifier Control is set to On , you can adjust the sound volume or turn off the sound using the remote control.
Speaker Preference	From this item, you can set your audio output preference to the TV speakers or the amplifier. When this item is set to Amplifier , the remote control can be used to adjust or mute the volume of the audio. This item will be grayed out and set to TV speakers automatically unless a REGZA-LINK® compatible audio receiver is connected.

Note: When you turn on the amplifier, change its input source, or adjust the sound volume, the sound will be output from the amplifier's speakers even if **TV Speakers** has been selected. Turn the TV off and on again to output the sound from the TV speakers.

To set the REGZA-LINK® Setup:

- 1 From the **PREFERENCES** menu, highlight **REGZA-LINK Setup** and press **ENTER**.
- 2 Press **▲** or **▼** to highlight **Enable REGZA-LINK**.
- 3 Press **◀** or **▶** to select **On**.

Note: If you set **Enable REGZA-LINK** to **Off**, the other items under REGZA-LINK Setup will be grayed out.
- 4 Press **▲** or **▼** to highlight the **REGZA-LINK** setup item you want to use, and press **◀** or **▶** to select **On** or the desired mode.
 - TV Auto Power On: On/Off
 - Auto Standby: On/Off
 - Amplifier Control: On/Off
 - Speaker Preference: TV Speakers/Amplifier

REGZA-LINK® PC Link

This feature automatically sets suitable widescreen formats and picture preferences when the TV is connected to a REGZA-LINK® PC.

Note: This feature depends on the type of equipment connected.

Using the HDMI™ settings feature

This menu consists of the following items (new HDMI capabilities) and will be grayed out on non-HDMI inputs.

Some HDMI legacy sources may not work properly with your HDMI TV, please try setting the following options (Deep Color, Lip Sync, and INSTAPORT™) to **Off**. Adjusting these settings should allow your HDMI legacy source to operate properly with your TV.

- **Deep Color: On**
This feature allows the HDMI source to increase available colors bits within the boundaries defined by the RGB or YCbCr color space.
- **Lip Sync: On**
The Lip Sync feature allows your HDMI source such as an audio receiver to adjust audio delay to match the video processing delay of the TV.
- **INSTAPORT™: On**
This feature reduces the lag time when switching HDMI sources.
- **RGB Range: Auto**
This feature adjusts RGB full range signal automatically.
When **Limit** is selected, RGB output signal is output in the range from 16 to 235. When **Full** is selected, RGB output signal is output in the range from 0 to 255.

All of the above HDMI settings need proper HDMI source devices. If an HDMI source device does not support these features, the TV may not work properly when these features are enabled.

Note: If your HDMI connection is capable of 1080p and/or your TV is capable of refresh rates greater than 60 Hz or supports Deep Color, you will need a High Speed HDMI™ cable. Conventional HDMI/DVI cables may not work properly with this mode.

- 1 Select the appropriate HDMI input mode (HDMI 1, HDMI 2, or HDMI 3).
- 2 From the **SETUP** menu, highlight **AV Connection** and press **ENTER**.
- 3 Press **▲** or **▼** to select **HDMI Settings**.
- 4 Press **▲** or **▼** to highlight the item you want to set.
- 5 Press **◀** or **▶** to select your desired setting.

Setting the HDMI™ audio mode

To set the HDMI audio mode:

- 1 From the **SETUP** menu, highlight **AV Connection** and press **ENTER**.
- 2 Press **▲** or **▼** to select **PC/HDMI 1 Audio**.
- 3 Press **◀** or **▶** to select **HDMI 1**.
- 4 Press **▲** or **▼** to select **HDMI 1 Audio**.
- 5 Press **◀** or **▶** to select **Auto, Digital** or **Analog**, (**Auto** is the recommended mode) and press **EXIT**.

Mode	Description
Auto	When viewing the HDMI 1 input, if digital audio from the HDMI input is available, it will be output. If not, the TV will automatically detect and output analog audio from the PC/HDMI 1 Audio input.
Digital	When viewing the HDMI 1 input, digital audio from the HDMI input will be output.
Analog	When viewing the HDMI 1 input, analog audio from the PC/HDMI 1 Audio input will be output.

Displaying TV status information

To display TV status information using RECALL:

Press **RECALL** on the remote control.

The following information will display (if applicable):

- Current input (**ANT/CABLE, Video 1**, etc.)
- If ANT/CABLE is the current input, either "CABLE" (for cable TV) or "ANT" (for over-the-air broadcasts).
- Channel number (if in **ANT/CABLE** mode)
- Input label (if set)
- Digital signal strength indicator (bar graph in lower right corner of box; for ATSC signal only)
- Stereo, Mono or SAP audio status (when HDMI input mode, Dolby Digital or PCM)
- Video resolution
- Aspect ratio of incoming video signal (4:3 or 16:9)
- V-Chip rating status
- GameTimer (if set)



To close the RECALL screen:

Press **RECALL** again.

To display TV status information using INFO:

(only available for **ANT/CABLE** input)

Press **INFO** on the remote control.

The following additional information will display for off air digital channels (if applicable):

- Title
- Duration
- Detailed description

To display Next information, press **INFO** on the remote control again. Pressing **INFO** a third time will remove the entire banner.

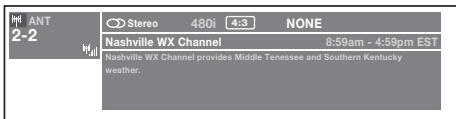

Note: The location of the banner can be moved to the top or bottom of the screen by pressing **▲** or **▼** while the **RECALL** or **INFO** display is on-screen. (The last position will be stored to memory.)

Understanding the auto power off feature

The TV will automatically turn itself off after approximately 15 minutes if it is tuned to a vacant channel or a station that completes its broadcast for the day. This feature functions in **ANT/CABLE** mode only.

Note: If it is possible that you will be away from the TV for an extended period of time, you should unplug the power cord.

Understanding the last mode memory feature

If the power is cut off while you are viewing the TV, the Last Mode Memory feature automatically turns on the TV when the power is resupplied.

Chapter 7: Using the TV's advanced features

Using the advanced picture settings features

Note: Some of the Advanced Picture Settings features will not be available for adjustment when the Picture Mode is set to **AutoView**.

Using the Resolution+™ feature

The Resolution+™ feature allows you to adjust the levels for your desired picture settings and to get a sharp picture.

To set Resolution+™:

- 1 From the **PICTURE** menu, highlight **Advanced Picture Settings** and press **ENTER**.
- 2 Press **▲** or **▼** to highlight **Resolution+**, and press **ENTER**.
- 3 Press **◀** or **▶** to select **On**.
- 4 Press **▲** or **▼** to highlight the **Level**, press **◀** or **▶** to select either **1, 2, 3, 4, or 5**, and press **ENTER**.

Note:

- If the Picture Mode is set to **AutoView**, the level range is from **-2** to **+2**.
- If the Picture Mode is set to **Game** or **PC**, this feature will be grayed out.
- This feature may not work properly depending on the content.
- Noise may appear on the image depending on the device connected to the TV (e.g. a device with a specific enhancer function).

Using the DynaLight™ feature

The DynaLight™ feature automatically strengthens the black coloring of dark areas in the video according to the level of darkness.

- 1 From the **PICTURE** menu, highlight **Advanced Picture Settings** and press **ENTER**.
- 2 Press **▲** or **▼** to select **DynaLight**.
- 3 Press **◀** or **▶** to select **On** or **Off** and press **EXIT**.

Using the Dynamic Contrast

Dynamic Contrast detects changes in picture quality that affect the appearance of your contrast settings and then automatically adjusts the video.

- 1 From the **PICTURE** menu, highlight **Advanced Picture Settings** and press **ENTER**.
- 2 Press **▲** or **▼** to select **Dynamic Contrast**.
- 3 Press **◀** or **▶** to adjust the level, and then press **ENTER**. The adjustment range is from **0** to **10**.

Note: If the Picture Mode is set to **AutoView**, the level range is from **-5** to **+5**.

Using the Static Gamma

The static gamma feature allows you to adjust the levels of black in the picture.

To adjust the static gamma settings:

- 1 From the **PICTURE** menu, highlight **Advanced Picture Settings** and press **ENTER**.
- 2 Press **▲** or **▼** to select **Static Gamma**.
- 3 Press **◀** or **▶** to adjust the level and press **ENTER**. The adjustment range is within **±15** from center.
 - If the setting is moved in the minus direction, the detail of black colors will be decreased.
 - If the setting is moved in the plus direction, the detail of black colors will be increased.

Using the Film Stabilization

This feature helps to eliminate video shaking.

- 1 From the **PICTURE** menu, highlight **Advanced Picture Settings** and press **ENTER**.
- 2 Press **▲** or **▼** to select **Film Stabilization**.
- 3 Press **◀** or **▶** to select **Smooth, Standard** or **Off** and press **EXIT**.

Note:

- If the Picture Mode is set to **Game**, this feature is set to **Off** automatically.
- If the Picture Mode is set to **AutoView**, select **Auto, Smooth, Standard** or **Off**.

Using Expert Mode

This feature individually enables/disables the Red, Green, and Blue components of the picture to allow for more accurate adjustment of each color.

- 1 From the **PICTURE** menu, highlight **Advanced Picture Settings** and press **ENTER**.
- 2 Press **▲** or **▼** to select **Expert Mode**, and then press **ENTER**.
- 3 Press **▲** or **▼** to select either **Red**, **Green** or **Blue**.
- 4 Press **◀** or **▶** to select **On**.
- 5 Press **▼** to select **Color** or **Tint**, press **◀** or **▶** to adjust, and then press **EXIT**.

Note:

- If the Picture Mode is set to **AutoView**, this feature will be grayed out.
- When the Expert Mode menu is exited, the **Red**, **Green** and **Blue** components will be re-enabled.
- It is not possible to turn off all three colors at the same time.

Using the ClearFrame™ feature

The ClearFrame 120 Hz anti-blur technology doubles the frame rate from 60 frames per second to 120 frames per second, virtually eliminating motion blur without adding flicker or reducing image brightness.

- 1 From the **PICTURE** menu, highlight **Advanced Picture Settings** and press **ENTER**.
- 2 Press **▲** or **▼** to select **ClearFrame**.
- 3 Press **◀** or **▶** to select **On**, and then press **EXIT**.

Note: If the Picture Mode is set to **Game**, this feature will be grayed out.

Using the MPEG NR feature

The MPEG noise reduction feature allows you to reduce visible interference caused by MPEG compression.

- 1 From the **PICTURE** menu, highlight **Advanced Picture Settings** and press **ENTER**.
- 2 Press **▲** or **▼** to select **Noise Reduction** and press **ENTER**.
- 3 Press **▲** or **▼** to highlight the **MPEG NR**.
- 4 Press **◀** or **▶** to select either **Off**, **Low**, **Middle**, or **High** and press **ENTER**.

Note: If the Picture Mode is set to **Game**, this feature will be grayed out.

Using the DNR feature

DNR enables you to “soften” the screen representation of a weak signal to reduce the noise effect.

- 1 From the **PICTURE** menu, highlight **Advanced Picture Settings** and press **ENTER**.
- 2 Press **▲** or **▼** to select **Noise Reduction** and press **ENTER**.
- 3 Press **▲** or **▼** to select **DNR**.
- 4 Press **◀** or **▶** to select **Low**, **Middle**, **High**, **Auto** or **Off** and press **ENTER**.

Note:

- If the Picture Mode is set to **Game**, this feature will be grayed out.
- The differences may not always be noticeable (for the best result use lower settings as picture quality can be lost if the setting is too high)

Using the Auto Brightness Sensor

When the Auto Brightness Sensor feature is set to On, the TV will automatically optimize the backlighting levels to suit ambient light conditions.

- 1 From the **PICTURE** menu, highlight **Advanced Picture Settings** and press **ENTER**.
- 2 Press **▲** or **▼** to select **Auto Brightness Sensor Settings** and press **ENTER**.
- 3 Press **▲** or **▼** to highlight **Auto Brightness Sensor**.
- 4 Press **◀** or **▶** to select **On** or **Off** and press **ENTER**.

Note: If the Picture Mode is set to **AutoView**, this feature will be automatically set to **On** and grayed out.

Using the Backlight Adjustment Pro

This feature adjusts the backlight so that it can change to match the ambient light conditions.

- 1 From the **PICTURE** menu, highlight **Advanced Picture Settings** and press **ENTER**.
- 2 Press **▲** or **▼** to select **Auto Brightness Sensor Settings** and press **ENTER**.
- 3 Press **▲** or **▼** to highlight **Backlight Adjustment Pro** and press **ENTER**. The Backlight Control Level window will appear.
- 4 Press **ENTER** to display the adjustment window. Press **◀** or **▶** to select the point and press **▲** or **▼** to adjust the level. The adjustment range is from 0 to 100.

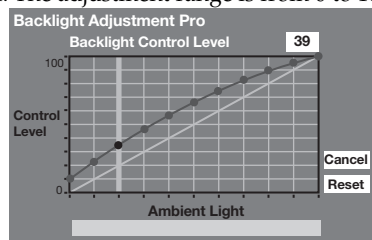

- 5 Press **ENTER** to fix the adjustment. To cancel the adjustment when selecting a point, select **Cancel** on the screen. To revert the adjustments of all points to the factory defaults, select **Reset** on the screen and press **ENTER**.

Note: If the Auto Brightness Sensor is set to **Off**, this feature will be grayed out.

Using the ColorMaster™ feature

The ColorMaster™ feature allows you to adjust standard colors.

- 1 From the **PICTURE** menu, highlight **Advanced Picture Settings** and press **ENTER**.
- 2 Press **▲** or **▼** to select **ColorMaster**, press **◀** or **▶** to select **On**, and then press **EXIT**.

Using the Base Color Adjustment

When ColorMaster™ is set to On, the list of base colors will be displayed. You can select a base color to adjust.

- 1 From the **PICTURE** menu, highlight **Advanced Picture Settings** and press **ENTER**.
- 2 Press **▲** or **▼** to select **Base Color Adjustment** and press **ENTER**. The **Base Color Adjustment** window will appear.
- 3 Press **▲** or **▼** to highlight the color you want to adjust, and then press **▶**.
- 4 Press **◀** or **▶** to select either **Hue**, **Saturation**, or **Brightness**.
- 5 Press **▲** or **▼** to adjust the setting.
- 6 Repeat steps 3 through 5 to adjust any other color. To revert the adjustments to the factory defaults, select **Reset** on the screen and press **ENTER**.

Selecting the color temperature

To adjust the color temperature:

- 1 From the **PICTURE** menu, highlight **Advanced Picture Settings** and press **ENTER**.
- 2 Press **▲** or **▼** to select **Color Temperature** and press **ENTER**.
- 3 Press **▲** or **▼** to highlight **Color Temperature**.
- 4 Press **◀** or **▶** to adjust the level. The adjustment range is 0 (warm) to 10 (cool). Then, press **EXIT**.

Note: If the Picture Mode is set to **AutoView**, the adjustment range is -5 to +5.

To adjust RGB Offset and RGB Gain:

- 1 From the **PICTURE** menu, highlight **Advanced Picture Settings** and press **ENTER**.
- 2 Press **▲** or **▼** to select **Color Temperature** and press **ENTER**.
- 3 Press **▲** or **▼** to highlight the menu you want to adjust, press **◀** or **▶** to adjust the setting, and press **ENTER** to return to the previous menu.
- 4 To revert the adjustments to the factory defaults, select **Reset** on the screen and press **ENTER**.

Note: If Picture Mode is set to **AutoView**, only the **Color Temperature** setting will be available.

Using the advanced sound settings features

Using the surround sound feature

Stereo Extension, Voice Enhancement, and Dynamic Bass Boost help to create a thrilling surround sound experience with deep, rich bass from stereo sound sources. Your TV's audio will sound fuller, richer, and wider.

- 1 Put the TV in **STEREO** mode (see "Selecting stereo/SAP broadcasts" on page 42).
- 2 From the **SOUND** menu, highlight **Advanced Sound Settings** and press **ENTER**.
- 3 Press **▼** or **▲** to highlight the feature you want to adjust, and then press **◀** or **▶** to adjust the item.

Mode	Description
Stereo Extension	To turn the surround sound effect On or Off . Note: If the broadcast is monaural, the Stereo Extension effect will not work.
Voice Enhancement	To turn the vocal emphasis effect On or Off .
Dynamic Bass Boost	To select the desired bass expansion level (Off , Low , or High).

Using the Media Player

The TV allows you to enjoy photos stored on a USB device.

Note:

- Do not insert/remove the USB device while in use.
- **MENU** is not available during playback.

Media Player Specifications

Device

USB device:

USB Mass Storage Class devices (MSC)

Note:

- Connectivity is not guaranteed for all devices.
- Connect the USB device to the TV directly.
- Do not use a USB hub.

Supported file system

FAT12, FAT16 and FAT32

You must obtain any required permission from copyright owners to download or use copyrighted content. Toshiba cannot and does not grant such permission.

Basic operation

To set Auto Start:

- 1 From the **APPLICATIONS** menu, highlight **Media Player** and press **ENTER**.
- 2 Press **▲** or **▼** to highlight **Auto Start**.
- 3 Press **◀** or **▶** to select **On**.

Auto Start:

- 1 Insert USB device into the **USB** terminal on the right side of the TV.
- 2 A prompt will appear. Press **◀** or **▶** to select **Yes** and press **ENTER**.
- 3 Press **▲** or **▼** to select **Photo** and press **ENTER**. The thumbnail view will appear.

Note: If Auto Start is set to **Off**, you can start the Media Player manually.

Manual Start:

- 1 Insert USB device into the **USB** terminal on the right side of the TV.
- 2 From the **APPLICATIONS** menu, highlight **Media Player** and press **ENTER**.
- 3 Press **▲** or **▼** to select **Photo** and press **ENTER**. The thumbnail view will appear.

To close the Media Player:

Press **EXIT**. The TV will return to the last-viewed channel or video input.

Viewing JPEG files

To view in Single View mode:

- 1 When the thumbnail view appears after starting the Media Player (see page 57), press ◀▶▼ or ▲ to select a file or folder.
- 2 Press **ENTER** to begin viewing the selected file or to open the selected folder.
Press **CH RTN** to return to the previous layer.
- 3 Press ▶ to view the next file, or press ◀ to view the previous file.

Note: If the previous or next file is not compatible, it will be skipped automatically.

To view in Slideshow mode:

- 1 To switch to the Slideshow mode, press **ENTER** while in Single View mode.
To return to Single View mode, press **ENTER** again.
- 2 Press ▶ to view the next file, or press ◀ to view the previous file.

Note: If the previous or next file is not compatible, it will be skipped automatically.

- 3 To close the Media Player, press **EXIT**.

To set the Slideshow mode settings:

- 1 From the **PREFERENCES** menu, highlight **Photo Viewer Setup** and press **ENTER**.
- 2 Press ▲ or ▼ to highlight **Interval Time** or **Repeat**.
- 3 Press ◀ or ▶ to adjust the setting and press **ENTER**.

Item	Description
Interval Time	To set a time interval to view photos at your preferred intervals (3sec, 5sec, 10sec, 15sec, 30sec, 60sec, or 90sec).
Repeat	To display photos in the same directory repeatedly. On/Off

To rotate the image:

While viewing the image in Single View mode, press ▲ to rotate the image 90 degrees clockwise, press ▼ to rotate the image 90 degrees counterclockwise.

To return to the thumbnail:

Press **CH RTN** while in Single View mode or Slideshow mode.

To display file status information:

- 1 Press **RECALL**. The following information will be displayed on the bottom of the screen.
 - Content number/Total number (only for the contents stored in the same directory)
 - Photo title
 - Date and time taken
 - File size
 - Slideshow icon (if applicable)
 - Repeat play icon (if applicable)
 - Operation guide
- 2 Press **RECALL** again to remove the information from the screen.

Note: The file status information will disappear after about 6 seconds.

File Compatibility:

Data compatibility: JPEG Exif ver 2.2

File format: DCF ver 1.1

Maximum viewable resolution: 16384 × 16384 pixels
(Total number of pixels: 10,000,000)

Maximum photo size: 9 MB

Total number of files: Less than 2000 per folder

Chapter 8: Troubleshooting

General troubleshooting

Before calling a service technician, please check this chapter for a possible cause of the problem and some solutions you can try.

Black box on-screen

- The closed caption feature is set to one of the Text modes (**T1**, **T2**, **T3**, or **T4**). Set the closed caption feature to **Off** (page 40).

TV stops responding to controls

- If the TV stops responding to the controls on the remote control or TV control panel and you cannot turn off the TV, press and hold the **POWER** button on the TV control panel for 5 or more seconds to reset the TV.

Other problems

- If your TV's problem is not addressed in this Troubleshooting section or the recommended solution has not worked, use the Reset Factory Defaults procedure (page 31).

TV will not turn on

- Make sure the power cord is plugged in, and then press **POWER**.
- The remote control batteries may be dead. Replace the batteries or try the control panel buttons.

Picture problems

General picture problems

- Check the antenna/cable connections (Chapter 2).
- Press **(INPUT)** on the remote control or the TV and select a valid video input source (page 32). If no device is connected to a particular input on the TV, no picture will display when you select that particular input source. For device connection details, see Chapter 2.
- Antenna reception may be poor. Use a highly directional outdoor antenna (if applicable).
- The station may have broadcast difficulties. Try another channel.
- Adjust the picture qualities (page 39).
- If you are using a VCR, make sure **(VCR)** on the remote control is set correctly (page 23).
- Do not connect both a standard video cable and an S-video cable to the **VIDEO 1** input at the same time (page 13).

Video Input Selection problems

- If the **Input Selection** window does not appear when you press **(INPUT)** on the remote control or the TV control panel, press **(INPUT)** a second time, which will change to the next video input source and display the **Input Selection** window.

Cannot view external signals or channel 3 or 4

- If you cannot view signals from external devices connected to **VIDEO 1**, **VIDEO 2**, **ColorStream HD1**, **ColorStream HD2**, **HDMI 1**, **HDMI 2**, **HDMI 3**, **PC** or

from channels 3 or 4, make sure the **Input Lock** is set to **Off** (page 46).

Poor color or no color

- The station may have broadcast difficulties. Try another channel.
- Adjust the **Tint** and/or **Color** (page 39).

Poor composite or S-video picture

- If the TV is connected to an external A/V device (e.g. DVD player, video game system, set-top box, etc.) try using a **ColorStream** or **HDMI** video connection instead.
- If you connect an S-video cable, be sure to disconnect the standard (composite) video cable. Do not connect both types of video cable at the same time.

Picture and sound are out of sync

- As with all products that contain a digital display, in rare instances, when viewing certain content (e.g. television broadcasts, video games, DVDs), you may notice that the sound and picture are slightly out of sync. This phenomenon can be caused by various factors including, without limitation, video processing within the TV, video processing in an attached gaming system, and video processing or different compression rates used by broadcasters in their programming. You may want to try one or more of the following suggestions, which may help to reduce the effect of this phenomenon:
 - If the TV is connected to an A/V receiver that has a programmable audio delay feature, use this feature to help synchronize the sound to the picture.
 - If you notice this phenomenon only on certain TV channels, please contact your local broadcast, cable, or satellite provider to inform them of this issue.

Sound problems

- Check the antenna/cable connections (Chapter 2).
- The station may have broadcast difficulties. Try another channel.
- The sound may be muted. Press **VOLUME**.
- If you hear no sound, try setting the **MTS** feature to **Stereo** mode (page 42).
- If you are not receiving a second audio program from a known SAP source, make sure the **MTS** feature is set to **SAP** mode (page 42).
- If you hear audio that seems "incorrect" for the program you are watching (such as music or a foreign language), the SAP mode may be on. Set the **MTS** feature to **Stereo** mode (page 42).
- If you connect a PC using either the **PC IN** terminal or an **HDMI** terminal, make sure that the **PC Audio** setting is properly set (page 47).

Remote control problems

- Make sure the remote control is set to the correct device mode (page 23).
- Remove all obstructions between the remote control and the TV.
- The remote control batteries may be dead. Replace the batteries (page 19).

(continued)

Chapter 8: Troubleshooting

- Your TV remote control may not operate certain features on your external device. Refer to the owner's manual for your other device to determine its available features. If your TV remote control does not operate a specific feature on another device, use the remote control that came with the device.
- If the TV still does not act as expected, use the Reset Factory Defaults procedure (page 31).

Channel tuning problems

- Make sure the remote control is set to the correct device mode (page 23).
- The channel may have been erased from the channel memory by the **Auto Tuning** feature. Add the channel to the channel memory (page 28).
- The channel may be blocked by the **Lock** feature. Unblock the channel (page 46).
- If you are unable to tune digital channels, check the antenna configuration (page 28). If you are still unable to tune digital channels, clear all channels from the channel list and reprogram channels into the channel memory (page 28). If you are still unable to tune digital channels, use the Reset Factory Defaults procedure (page 31). Also see "TV stops responding to controls" and "Other problems" (page 59).

Closed caption problems

- If the program or video you selected is not closed-captioned, no captions will display.
- If text is not available, a black rectangle may appear. If this happens, turn off the closed caption feature (page 40).
- A closed-caption signal may not display correctly in the following situations: a) when a videotape has been dubbed; b) when the signal reception is weak; or c) when the signal reception is nonstandard (page 40).

Rating blocking (V-Chip) problems

- If you forget your PIN code: While the PIN code entering screen is displayed, press **RECALL** four times within 5 seconds. The PIN code you previously stored will be cleared (page 43).
- The V-Chip feature is available for the U.S. V-Chip system only (page 44).

No REGZA-LINK operation

- The REGZA-LINK feature is available for Toshiba REGZA-LINK compatible devices.
- Make sure the HDMI cables with the HDMI Logo (**HDMI**) are used.
- When the connected REGZA-LINK device does not work correctly after you have changed settings of the device, turn off your TV and unplug the power cord, and then plug and turn on again.
- If several devices are connected, REGZA-LINK feature may not operate properly.
- Read the instruction manual furnished with the connected REGZA-LINK device.

HDMI problems

For HDMI cables

- Make sure the HDMI cables with the HDMI Logo (**HDMI**) are used (page 12).

For Deep Color

- You should need to use High Speed HDMI cable to work properly. Normal HDMI cable or DVI cable may not work with this option (pages 15 and 51).

For Legacy HDMI source

- Some legacy HDMI sources may not work properly with the latest HDMI TV products, due to new standard adoption. Please try setting the following HDMI Setting items to Off (Deep Color, Lip Sync, INSTAPORT™) (page 51). Your legacy HDMI source should operate properly with this TV product.

Media Player problems

- Make sure that devices are connected correctly.
- If you connect a USB device with separate cable or through USB hub, the TV does not recognize the USB device.

LED indications

The Power and On Timer LED lights on the TV front indicate the TV's status, as described below.

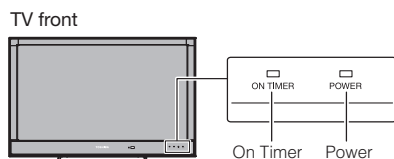

LED Indication

Power LED

- **Green is ON (solid)**

The TV is operating properly.

- **Orange is ON (solid)**

Standby with Power-On Mode set to Fast. See "Selecting the Power-On Mode" (page 30).

- **Green blinks three times**

TV is powering up. Wait several seconds until the green LED stops blinking.

- **Green blinks**

Abnormal operation of BUS line. Turn OFF the TV and unplug the power cord. Plug the power cord in again and turn ON the TV.

- **Red blinks**

Power protect detection. Turn OFF the TV and unplug the power cord. Plug the power cord in again and turn ON the TV.

- **Orange blinks**

Abnormal operation of back light. Turn OFF the TV and unplug the power cord. Plug the power cord in again and turn ON the TV.

On Timer LED

- **Green is ON (solid)**

On Timer is set.

- **Green blinks (if applicable)**

Fan Stopped. Turn Off the TV and unplug the power cord. Plug the power cord in again and turn ON the TV.

If, after trying the solutions, the problem still exists:

- In the U.S., call TACP Consumer Solutions at 1-800-631-3811.
- In Canada, locate the nearest Toshiba authorized service depot by directing your web browser to www.toshiba.ca; click "Home Entertainment," and then click "Support."

Chapter 9: Appendix

Specifications

Note:

- *This model complies with the specifications listed below.*
- *Designs and specifications are subject to change without notice.*
- *This model may not be compatible with features and/or specifications that may be added in the future.*

Television System

NTSC standard
ATSC standard (8VSB)
Digital Cable (64 QAM, 256 QAM; in-the-clear, unencrypted)

Channel Coverage

VHF: 2 through 13
UHF: 14 through 69
Cable TV: Mid band (A-8 through A-1, A through I)
Super band (J through W)
Hyper band (AA through ZZ, AAA, BBB)
Ultra band (65 through 94, 100 through 135)

Power Source: 120 V AC, 60 Hz

Power Consumption

40XV648U: 1.9 A(rms) (maximum current)
0.2 W in standby mode
46XV648U: 2.3 A(rms) (maximum current)
0.3 W in standby mode
52XV648U: 2.9 A(rms) (maximum current)
0.3 W in standby mode

Audio Power: 10 W + 10 W

Speaker Type

Main: Two 1-3/8 × 6-3/8 inches (35 × 160 mm)

Video/Audio Terminals

S-VIDEO INPUT:

Y: 1 V(p-p), 75 ohm, negative sync.
C: 0.286 V(p-p) (burst signal), 75 ohm

VIDEO/AUDIO INPUT:

VIDEO: 1 V(p-p), 75 ohm, negative sync.
AUDIO: 150 mV(rms) (30% modulation equivalent, 22 k ohm or greater)

ColorStream® (component video) HD INPUT:

VIDEO: Y: 1V(p-p), 75 ohm
PR: 0.7 V(p-p), 75 ohm
PB: 0.7 V(p-p), 75 ohm
Suggested formats: 1080p, 1080i, 720p, 480p, 480i
AUDIO: 150 mV(rms), 22 k ohm or greater

HDMI™ INPUT:

HDMI compliant
HDCP compliant
Audio Lip Sync supported
Deep Color supported (10 bit 4:4:4, 12 bit 4:4:4)
Suggested formats: See table on the next page.
HDMI Audio: 2-channel Linear-PCM; 32/44.1/48 kHz sampling frequency; 16/20/24 bits per sample

FIXED AUDIO OUTPUT:

150 mV (rms) (30% modulation equivalent, 2.2 k ohm or less)

DIGITAL AUDIO OUTPUT:

Optical type

PC INPUT:

15-Pin D-sub Analog RGB

Dimensions (include foot stand)

40XV648U: Width: 38-7/16 inches (976 mm)
Height: 26-1/8 inches (663 mm)
Depth: 10-3/8 inches (263 mm)
46XV648U: Width: 43-5/8 inches (1,108 mm)
Height: 29-5/32 inches (740 mm)
Depth: 11-25/32 inches (299 mm)
52XV648U: Width: 49-5/16 inches (1,252 mm)
Height: 33-1/32 inches (839 mm)
Depth: 13-7/8 inches (352 mm)

Mass (weight)

40XV648U: 41.9 lbs (19.0 kg)
46XV648U: 52.9 lbs (24.0 kg)
52XV648U: 70.6 lbs (32.5 kg)

Operating conditions

Temperature: 32°F - 95°F (0°C - 35°C)
Humidity: 20 - 80% (no moisture condensation)

Supplied Accessories

- Remote control with two size “AAA” alkaline batteries
- Owner’s manual (this book)
- Securement Clip
Use this clip to attach the TV to a wall stud, pillar, or other immovable structure. See item 23 on page 3 and instructions on page 5.
- Cleaning cloth (to clean the cabinet and control panel)

Acceptable signal formats for PC IN and HDMI terminals

PC IN signal formats

Note:

- The PC IN on this TV only accepts signal formats which are compliant with VESA-DMT as shown in the table below. Since some PCs have input signals that are different from the resolution and frequency described in the table below, the following phenomenon may occur: incorrect display, false format detection, picture position failure, blur, or judder. In this case, set the monitor output format on your PC to conform to any signals in the table below.
- The signals whose vertical frequency are 56 Hz, 70 Hz, 72 Hz, or 75 Hz are converted to 60 Hz signal.
- When you connect a PC to this TV, it is recommended to set the refresh rate of your PC to 60 Hz.
- The PC IN on this TV does not accept the Sync on Green, Composite Sync and Interlace signals.

Format	Resolution	V. Frequency	H. Frequency	Pixel Clock Frequency	VESA Standard (DMT)
VGA	640 × 480	59.940 Hz	31.469 kHz	25.175 MHz	●
		72.809 Hz	37.861 kHz	31.500 MHz	●
		75.000 Hz	37.500 kHz	31.500 MHz	●
SVGA	800 × 600	56.250 Hz	35.156 kHz	36.000 MHz	●
		60.317 Hz	37.879 kHz	40.000 MHz	●
		72.188 Hz	48.077 kHz	50.000 MHz	●
		75.000 Hz	46.875 kHz	49.500 MHz	●
XGA	1024 × 768	60.004 Hz	48.363 kHz	65.000 MHz	●
		70.069 Hz	56.476 kHz	75.000 MHz	●
		75.029 Hz	60.023 kHz	78.750 MHz	●
WXGA	1280 × 768	59.995 Hz	47.396 kHz	68.250 MHz	●
		59.870 Hz	47.776 kHz	79.500 MHz	●
		74.893 Hz	60.289 kHz	102.250 MHz	●
	1360 × 768	60.015 Hz	47.712 kHz	85.500 MHz	●
	SXGA	1280 × 1024	60.020 Hz	63.981 kHz	108.000 MHz
75.025 Hz			79.976 kHz	135.000 MHz	●

HDMI signal formats

Note:

- The HDMI inputs on this TV only accept VGA, SVGA, XGA, WXGA, and SXGA signal formats which are compliant with VESA as shown in the table below. Since some PCs and HDMI or DVI devices have input signals that are different from the resolution and frequency described in the table below, the following phenomenon may occur: incorrect display, false format detection, picture position failure, blur, or judder. In this case, set the monitor output format on your PC, HDMI or DVI device to conform to any signals in the table below.
- The signals whose vertical frequency are 24 Hz, 56 Hz, 70 Hz, 72 Hz, or 75 Hz are converted to 60 Hz signal.
- When you connect a PC to this TV, it is recommended to set the refresh rate of your PC to 60 Hz.

Format	Resolution	V. Frequency	H. Frequency	Pixel Clock Frequency	VESA Standard
VGA	640 × 480	59.940 Hz	31.469 kHz	25.175 MHz	●
		72.809 Hz	37.861 kHz	31.500 MHz	●
		75.000 Hz	37.500 kHz	31.500 MHz	●
SVGA	800 × 600	56.250 Hz	35.156 kHz	36.000 MHz	●
		60.317 Hz	37.879 kHz	40.000 MHz	●
		72.188 Hz	48.077 kHz	50.000 MHz	●
		75.000 Hz	46.875 kHz	49.500 MHz	●
XGA	1024 × 768	60.004 Hz	48.363 kHz	65.000 MHz	●
		70.069 Hz	56.476 kHz	75.000 MHz	●
		75.029 Hz	60.023 kHz	78.750 MHz	●
WXGA	1280 × 768	59.995 Hz	47.396 kHz	68.250 MHz	●
		59.870 Hz	47.776 kHz	79.500 MHz	●
		74.893 Hz	60.289 kHz	102.250 MHz	●
	1360 × 768	60.015 Hz	47.712 kHz	85.500 MHz	●
SXGA	1280 × 1024	60.020 Hz	63.981 kHz	108.000 MHz	●
		75.000 Hz	79.976 kHz	135.000 MHz	●
480i	720 × 480i	59.940/60 Hz	15.734/15.750 kHz	27.000/27.027 MHz	
480p	720 × 480p	59.940/60 Hz	31.469/31.500 kHz	27.000/27.027 MHz	
720p	1280 × 720p	59.940/60 Hz	44.955/45.000 kHz	74.176/74.250 MHz	
1080i	1920 × 1080i	59.940/60 Hz	33.716/33.750 kHz	74.176/74.250 MHz	
1080p	1920 × 1080p	23.976/24 Hz	26.973/27.000 kHz	74.176/74.250 MHz	
		59.940/60 Hz	67.433/67.500 kHz	148.352/148.500 MHz	

Limited United States Warranty for LCD Televisions 26" and Larger

Toshiba America Consumer Products, L.L.C. ("TACP") makes the following limited warranties to original consumers in the United States.

THESE LIMITED WARRANTIES EXTEND TO THE ORIGINAL CONSUMER PURCHASER OR ANY PERSON RECEIVING THIS LCD TELEVISION AS A GIFT FROM THE ORIGINAL CONSUMER PURCHASER AND TO NO OTHER PURCHASER OR TRANSFEREE.

LCD TELEVISIONS PURCHASED IN THE U.S.A. AND USED ANYWHERE OUTSIDE OF THE U.S.A., INCLUDING, WITHOUT LIMITATION, CANADA AND MEXICO, ARE NOT COVERED BY THESE WARRANTIES.

LCD TELEVISIONS PURCHASED ANYWHERE OUTSIDE OF THE U.S.A., INCLUDING, WITHOUT LIMITATION, CANADA AND MEXICO, AND USED IN THE U.S.A., ARE NOT COVERED BY THESE WARRANTIES.

Limited One (1) Year Warranty on Parts and Labor

TACP warrants this LCD Television and its parts against defects in materials or workmanship for a period of one (1) year after the date of original retail purchase. DURING THIS PERIOD, TACP WILL, AT TACP'S OPTION, REPAIR OR REPLACE A DEFECTIVE PART WITH A NEW OR REFURBISHED PART WITHOUT CHARGE TO YOU FOR PARTS OR LABOR. During this period, TACP Authorized Service Station personnel will come to your home when warranty service is required. Depending on the type of repair required, the service will either be performed in your home or the LCD Television will be taken to a TACP Authorized Service Station for repair and returned to your home at no cost to you.

Rental Units

The warranty for LCD Television rental units begins on the date of the first rental or thirty (30) days after the date of shipment to the rental firm, whichever comes first.

Limited Warranty for Commercial Units

TACP warrants LCD Televisions that are sold and used for commercial purposes as follows: all parts are warranted against defects in materials or workmanship for a period of one (1) year after the date of original retail purchase. DURING THIS PERIOD, TACP WILL, AT TACP'S OPTION, REPAIR OR REPLACE A DEFECTIVE PART WITH A NEW OR REFURBISHED PART WITHOUT CHARGE TO YOU.

Owner's Manual and Product Registration Card

Read this owner's manual thoroughly before operating this LCD Television.

Complete and mail the enclosed product registration card or register your LCD Television online at www.tacp.toshiba.com/service as soon as possible. By registering your LCD Television you will enable TACP to bring you new products specifically designed to meet your needs

and help us to contact you in the unlikely event a safety notification is required under the U.S. Consumer Product Safety Act. **Failure to complete and return the product registration card does not diminish your warranty rights.**

Your Responsibility

THE ABOVE WARRANTIES ARE SUBJECT TO THE FOLLOWING CONDITIONS:

- (1) You must retain your original bill of sale or provide other proof of purchase.
- (2) All warranty servicing of this LCD Television must be performed by an Authorized TACP Service Station.
- (3) The warranties from TACP are effective only if this LCD Television is purchased and operated in the Continental U.S.A. or Puerto Rico.
- (4) Labor service charges for set installation, setup, adjustment of customer controls, and installation or repair of antenna systems are not covered by this warranty. Reception problems caused by inadequate antenna systems, misaligned satellite dishes, cable television distribution, VCRs, DVD players/recorders, personal computer level IEEE-1394 devices, and any other connected signal source device are your responsibility.
- (5) Warranties extend only to defects in materials or workmanship as limited above, and do not extend to any LCD Television or parts that have been lost or discarded by you or to damage to the LCD Television or parts caused by fires, misuse, accident, Acts of God (such as lightning or fluctuations in electric power), improper installation, improper maintenance, or use in violation of instructions furnished by TACP; use or malfunction through simultaneous use of this LCD Television and connected equipment; or to units that have been modified or had the serial number removed, altered, defaced, or rendered illegible.

How to Obtain Warranty Service

If, after following all of the operating instructions in this manual and reviewing the section entitled "Troubleshooting," you find that service is needed:

- (1) To find the nearest TACP Authorized Service Station, visit TACP's website at www.tacp.toshiba.com/service or contact TACP's Consumer Solution Center toll free at 1-800-631-3811.
- (2) You must present your original bill of sale or other proof of purchase to the TACP Authorized Service Station.

**For additional information, visit TACP's website:
www.tacp.toshiba.com**

ALL WARRANTIES IMPLIED BY THE LAW OF ANY STATE OF THE U.S.A., INCLUDING THE IMPLIED WARRANTIES OF MERCHANTABILITY AND FITNESS FOR A PARTICULAR PURPOSE, ARE EXPRESSLY LIMITED TO THE DURATION OF THE LIMITED WARRANTIES SET FORTH ABOVE. WITH THE EXCEPTION OF ANY WARRANTIES IMPLIED BY THE LAW OF ANY STATE OF THE U.S.A. AS HEREBY LIMITED,

Chapter 9: Appendix

THE FOREGOING WARRANTY IS EXCLUSIVE AND IN LIEU OF ALL OTHER WARRANTIES, GUARANTEES, AGREEMENTS, AND SIMILAR OBLIGATIONS OF TACP WITH RESPECT TO THE REPAIR OR REPLACEMENT OF ANY PARTS. IN NO EVENT SHALL TACP BE LIABLE FOR CONSEQUENTIAL OR INCIDENTAL DAMAGES (INCLUDING, BUT NOT LIMITED TO, LOST PROFITS, BUSINESS INTERRUPTION, OR MODIFICATION OR ERASURE OF RECORDED DATA CAUSED BY USE, MISUSE OR INABILITY TO USE THIS LCD TELEVISION).

No person, agent, distributor, dealer, or company is authorized to change, modify, or extend the terms of these warranties in any manner whatsoever. The time within which an action must be commenced to enforce any obligation of TACP arising under the warranty or under any statute or law of the United States or any state thereof is hereby limited to ninety (90) days from the date you discover, or should have discovered, the defect. This limitation does not apply to implied warranties arising under the law of any state of the U.S.A.

THIS WARRANTY GIVES YOU SPECIFIC LEGAL RIGHTS AND YOU MAY ALSO HAVE OTHER RIGHTS WHICH MAY VARY FROM STATE TO STATE IN THE U.S.A. SOME STATES OF THE U.S.A. DO NOT ALLOW LIMITATIONS ON THE DURATION OF AN IMPLIED WARRANTY, WHEN AN ACTION MAY BE BROUGHT, OR THE EXCLUSION OR LIMITATION OF INCIDENTAL OR CONSEQUENTIAL DAMAGES. THEREFORE, THE ABOVE PROVISIONS MAY NOT APPLY TO YOU UNDER SUCH CIRCUMSTANCES.

Limited Canadian Warranty for Toshiba Brand Flat Panel Televisions

Toshiba of Canada Limited ("TCL") makes the following limited warranties to original consumers in Canada. THESE LIMITED WARRANTIES EXTEND TO THE ORIGINAL CONSUMER PURCHASER OR ANY PERSON RECEIVING THIS TOSHIBA BRAND FLAT PANEL TELEVISION (the "TELEVISION(S)" or "Television(s)") AS A GIFT FROM THE ORIGINAL CONSUMER PURCHASER AND TO NO OTHER PURCHASER OR TRANSFEREE.

TELEVISIONS PURCHASED IN CANADA, AND USED ANYWHERE OUTSIDE OF CANADA INCLUDING, WITHOUT LIMITATION, THE UNITED STATES AND MEXICO, ARE NOT COVERED BY THESE WARRANTIES.

TELEVISIONS PURCHASED ANYWHERE OUTSIDE OF CANADA, INCLUDING, WITHOUT LIMITATION, THE UNITED STATES AND MEXICO, AND USED IN CANADA, ARE NOT COVERED BY THESE WARRANTIES.

Limited One (1) Year Warranty on Parts and Labour

Subject to the more limited warranty if the Television is used for any commercial or business purposes as set out below,

TCL warrants the Television and its parts against material defects in materials or workmanship that result in the Television failing for a period of one (1) year after the date of original retail purchase. DURING THIS PERIOD, TCL WILL, AT TCL'S OPTION, REPAIR OR REPLACE A DEFECTIVE PART WITH A NEW OR REFURBISHED PART WITHOUT CHARGE TO YOU FOR PARTS OR LABOUR.

- (a) FOR TELEVISIONS 32 INCHES OR LESS: YOU MUST DELIVER THE ENTIRE TELEVISION TO A TCL TELEVISION AUTHORIZED SERVICE PROVIDER ("ASP"). YOU MUST PAY FOR ALL TRANSPORTATION AND INSURANCE CHARGES FOR THE TELEVISION TO AND FROM THE ASP.
- (b) FOR TELEVISIONS OVER 32 INCHES: During this period, ASP personnel will come to your home when warranty service is required. Depending on the type of repair required, the service will either be performed in your home or the Television will be taken to an ASP for repair and returned to your home at no cost to you. IN-HOME SERVICE ONLY APPLIES WITHIN 100 KILOMETERS OF AN ASP. IF YOU ARE NOT WITHIN 100 KILOMETERS OF AN ASP, YOU MUST DELIVER THE ENTIRE TELEVISION TO AN ASP. YOU MUST PAY FOR ALL TRANSPORTATION AND INSURANCE CHARGES FOR THE TELEVISION TO AND FROM THE ASP.

Limited Warranty for Commercial Units

TCL warrants Televisions that are used for any commercial or business purposes as follows: all parts are warranted against material defects in materials or workmanship that result in the Television failing for a period of one (1) year after the date of original retail purchase. DURING THIS PERIOD, TCL WILL, AT TCL'S OPTION, REPAIR OR REPLACE THE DEFECTIVE PART WITH A NEW OR REFURBISHED PART WITHOUT CHARGE TO YOU.

- (c) FOR TELEVISIONS 32 INCHES OR LESS: YOU MUST DELIVER THE ENTIRE TELEVISION TO AN ASP. YOU MUST PAY FOR ALL TRANSPORTATION AND INSURANCE CHARGES FOR THE TELEVISION TO AND FROM THE ASP.
- (d) FOR TELEVISIONS OVER 32 INCHES: During this period, ASP personnel will come on-site when warranty service is required. Depending on the type of repair required, the service will either be performed on-site or the Television will be taken to an ASP for repair and returned at no cost to you. ON-SITE SERVICE ONLY APPLIES WITHIN 100 KILOMETERS OF AN ASP. IF YOU ARE NOT WITHIN 100 KILOMETERS OF AN ASP, YOU MUST DELIVER THE ENTIRE TELEVISION TO AN ASP. YOU MUST PAY FOR ALL TRANSPORTATION AND INSURANCE CHARGES FOR THE TELEVISION TO AND FROM THE ASP.

Chapter 9: Appendix

Rental Units

The warranty for Television rental units begins with the date of first rental or thirty (30) days from the date of shipment to the rental firm, whichever comes first.

Your Responsibility

THE ABOVE WARRANTIES ARE SUBJECT TO THE FOLLOWING CONDITIONS:

- (1) You must provide your bill of sale or other proof of purchase.
- (2) All warranty servicing of this Television must be performed by an ASP.
- (3) The warranties from TCL are effective only if the Television is (i) purchased as new and unopened from TCL or from TCL's authorized distributors, dealers or resellers ("ADR's") and (ii) located/operated in Canada.
- (4) Labour charges for set installation, setup, adjustment of customer controls, and installation or repair of antenna systems are not covered by these warranties. Reception problems caused by inadequate antenna systems are your responsibility.
- (5) Warranties extend only to material defects in materials or workmanship as limited above, and do not extend to:
 - a. Service, repairs or replacement made necessary by accident, misuse, abuse, moisture, liquids, dust, dirt, neglect, accident, damage, 24/7 applications, improper installation, improper operation, improper cleaning, improper maintenance, normal wear and tear, screen burn or image retention caused by prolonged display of static images and/or phosphor aging, or any other external cause or event, act or omission outside the control of TCL, including fire, theft, acts of God, alteration, power failures, power surges or power shortages, lightning, other electrical faults, or repairs, modifications or replacements by persons other than those authorized by TCL to service the Television;
 - b. Replacement of missing, discarded or lost parts, the provision of retrofits, or preventive maintenance;
 - c. Repair of damage that is cosmetic only or does not affect the Television functionality, such as wear and tear, scratches and dents;
 - d. Service on Toshiba-branded accessory items (such as accessory items may be covered by their own warranty);
 - e. Service on third party products or service made necessary by use of incompatible third party products;
 - f. Service made necessary by the simultaneous use of this Television and connected equipment;
 - g. Modifications to the Television not approved in writing by TCL, and service made necessary by the use or installation of non-Toshiba modifications to the Television;
 - h. Service of a Television on which the TOSHIBA label or logo, rating label or serial number have been defaced or removed;
 - i. On-site service and repair of the Television; and

- j. Damage to the Television caused by failure to follow the specifications, User manuals or guides as to usage and/or storage.

Disclaimer and Limitation of Remedy

TO THE EXTENT NOT PRECLUDED BY LAW, ALL OTHER EXPRESS AND IMPLIED WARRANTIES, CONDITIONS AND REPRESENTATIONS FOR THIS TELEVISION, INCLUDING THE IMPLIED WARRANTIES, CONDITIONS AND REPRESENTATIONS OF MERCHANTABILITY AND FITNESS FOR A PARTICULAR PURPOSE, ARE HEREBY DISCLAIMED AND EXCLUDED. IF THE APPLICABLE LAW, STATUTORY OR OTHERWISE, PRECLUDES THE EXCLUSION OF ANY IMPLIED WARRANTIES, CONDITIONS AND REPRESENTATIONS THEN SUCH IMPLIED WARRANTIES, CONDITIONS AND REPRESENTATIONS ARE OTHERWISE LIMITED IN DURATION TO THE TERM OF THIS EXPRESS WRITTEN LIMITED WARRANTY. TO THE EXTENT NOT PRECLUDED BY LAW, STATUTORY OR OTHERWISE, THIS WRITTEN WARRANTY SUPERCEDES AND SPECIFICALLY DISCLAIMS ANY OTHER WARRANTY, CONDITION OR REPRESENTATION NOT STATED IN THIS WARRANTY, WHETHER MADE BY TCL, TOSHIBA CORPORATION, THEIR AFFILIATES, ADRs AND ASPs AND WHETHER MADE ORALLY OR IN WRITING (INCLUDING ANY STATEMENT IN ANY BROCHURE, PRESS RELEASE, ANNOUNCEMENT, ADVERTISEMENT, POINT OF SALE DISPLAY, ETC.).

YOU MUST READ AND FOLLOW ALL SET-UP AND USAGE INSTRUCTIONS IN THE APPLICABLE USER GUIDES AND/OR MANUALS. IF YOU FAIL TO DO SO, THIS TELEVISION MAY NOT FUNCTION PROPERLY AND YOU MAY SUFFER DAMAGE. THIS WARRANTY WILL NOT COVER ANY SERVICE THAT IS REQUIRED, IN PART OR IN WHOLE, AS A RESULT OF ANY FAILURE TO FOLLOW THE SET-UP AND USAGE INSTRUCTIONS. THIS WARRANTY DOES NOT APPLY AND SHALL BE VOID AND UNENFORCEABLE IF THE TELEVISION IS OPENED, SERVICED, OR REPAIRED BY PERSONS OTHER THAN THOSE AUTHORIZED BY TCL TO SERVICE OR REPAIR THE TELEVISION.

IF THE TELEVISION FAILS TO WORK AS WARRANTED ABOVE, YOUR SOLE AND EXCLUSIVE REMEDY SHALL BE REPAIR OR REPLACEMENT OF THE DEFECTIVE PART. IN NO EVENT WILL TCL, TOSHIBA CORPORATION, THEIR AFFILIATES, ADRs OR ASPs (THE "RELATED PARTIES") BE LIABLE TO YOU OR ANY THIRD PARTY FOR ANY DAMAGES, MONEY, REIMBURSEMENT, COSTS OR EXPENSES. THIS LIMITATION APPLIES TO DAMAGES, MONEY, REIMBURSEMENT, COSTS OR EXPENSES OF ANY KIND WHATSOEVER INCLUDING ANY DIRECT OR INDIRECT DAMAGES, DAMAGE TO PROPERTY OR PERSON, LOST PROFITS, LOST SAVINGS, INCONVENIENCE OR OTHER SPECIAL, INCIDENTAL, EXEMPLARY OR CONSEQUENTIAL DAMAGES, WHETHER FOR BREACH OF WARRANTY, BREACH OF CONTRACT, TORT (INCLUDING NEGLIGENCE), UNDER A STATUTE OR UNDER ANY OTHER LAW OR FORM OR ACTION, OR WHETHER ARISING OUT OF THE USE OF OR INABILITY TO

Chapter 9: Appendix

USE THE TELEVISION, EVEN IF ANY OF THE RELATED PARTIES HAS BEEN ADVISED OF THE POSSIBILITY OF SUCH DAMAGES OR OF ANY CLAIM BY ANY OTHER PARTY.

No person, agent, distributor, dealer or company is authorized to change, modify or extend the terms of these warranties in any manner whatsoever.

Arbitration and Dispute Resolution

To the extent not precluded by law, any claim, dispute, controversy or disagreement (whether for breach of warranty, breach of contract, tort (including negligence and negligent and/or fraudulent misrepresentation), under a statute or under any other law or form of action) against any of the Related Parties arising out of, or otherwise relating to: (i) this warranty; (ii) the Television; (iii) any oral or written representations, statements, brochures, press releases, advertising, announcement, point of sale display, or promotional material relating to the Television; (iv) the relationships that result from this warranty, (the foregoing claims, disputes controversies and disagreements are collectively referred to as the "Dispute"), shall be referred to and resolved by final and binding arbitration (to the exclusion of the courts). To the extent not precluded by law, you agree to waive any right that you may have to commence or participate in any representative or class proceeding against the Related Parties relating to any Dispute. If and where applicable and to the extent not precluded by law, you further agree to opt out of any such representative or class proceedings. Arbitration of any Dispute will be conducted in the forum and in the manner as agreed to between you and TCL. Failing such agreement, the arbitration will be conducted by one arbitrator pursuant to the laws and rules relating to arbitration generally in force in the jurisdiction in which you reside at the time that the Dispute arises. To the extent not precluded by law, no claim, dispute, controversy or disagreement of any other person may be joined or combined with any Dispute by you, without the prior written consent of TCL.

Critical Applications

The Television you have purchased is not designed for any "critical applications." "Critical applications" means life support systems, medical applications, connections to implanted medical devices, commercial transportation, nuclear facilities or systems or any other applications where Television failure could lead to injury to persons or loss of life or catastrophic property damage.

IF THE CUSTOMER USES THE TELEVISION IN ANY CRITICAL APPLICATION, THE CUSTOMER - AND NOT TCL, ITS AFFILIATES, ADRs OR ASPs - ASSUME SOLE AND FULL RESPONSIBILITY FOR SUCH USE. TCL RESERVES THE RIGHT TO REFUSE TO SERVICE ANY TELEVISION USED IN A CRITICAL APPLICATION. TCL, ITS AFFILIATES, ADRs AND ASPs HEREBY DISCLAIM ANY AND ALL LIABILITY, DAMAGES AND CONSEQUENCES ARISING OUT OF THE SERVICE OR REFUSAL TO SERVICE SUCH TELEVISION

AND FURTHER DISCLAIM ANY AND ALL LIABILITY, CONSEQUENCES AND DAMAGES THAT MAY ARISE OR RESULT FROM THE USE OF THE TELEVISION IN ANY CRITICAL APPLICATIONS.

General Provisions

If and to the extent that any provision of this limited warranty should generally be found to be unenforceable, the unenforceable provision shall be severed from the warranty and deemed not to form part of the warranty. The remaining provisions of this warranty shall be and remain valid and enforceable. If and to the extent that any provision of this limited warranty as it relates to any of the Related Parties is found to be invalid or unenforceable in respect of that party (the "Excluded Party"), the Excluded Party shall be deemed to be severed or excluded from the provision, and the provision shall remain valid, enforceable and applicable in respect of the other or remaining Related Parties.

To the extent permitted by law, this limited warranty shall be governed and construed in accordance with the laws of Ontario.

If there is any inconsistency between this limited warranty, on the one hand, and any statement in the packaging of the Television or in any other document enclosed with, or used in the context of the promotion or sale of, the Television, on the other hand, the provisions of this limited warranty shall prevail.

How to Obtain Warranty Services

If, after following all of the operating instructions in this manual and checking the "Troubleshooting" section, you find that service is needed:

- (1) To find the nearest ASP, visit TCL's web site at www.toshiba.ca, or call toll free 1-800-268-3404
- (2) Present your bill of sale or other proof of purchase to the ASP.

For additional information, visit TCL's website at www.toshiba.ca

A copy of the GPL source code in this product may be obtained by contacting Toshiba Consumer Solutions at (800)631-3811. There will be a charge to cover the costs of providing the source code.

A copy of the LGPL source code in this product may be obtained by contacting Toshiba Consumer Solutions at (800)631-3811. There will be a charge to cover the costs of providing the source code.

Portions of this software are copyright © <2007> The FreeType Project (www.freetype.org). All rights reserved.

This software is based in part on the work of the Independent JPEG Group.

Index

A

Antenna input configuration	28
Audio quality adjustments	42
Audio system connection	17
Auto Aspect	38
Auto Brightness Sensor	55
Auto power off	52
Auto Tuning	28
AutoView™	39

B

Backlight	39
Backlight Adjustment Pro	55
Base Color Adjustment	55
Blue Screen	30

C

CH ▲▼ buttons	35
CH RTN button	35
Channel Browser™	33
Channel lock	46
Channel Number buttons	35
Channel Tuning Mode	35
ClearFrame™	54
Closed captions	40
Color Temperature	56
ColorMaster™	55
ColorStream®	14
Component video	14

D

Deep Color	51
Digital Audio Out	17
Digital audio selector	42
Digital CC Settings	41
DNR	54
Dolby® Digital	17
Dolby® Volume	43
Dynamic Range Control	43
DVD player connection	14
DVI connection	15
DynaLight™	53
Dynamic Bass Boost	56
Dynamic Contrast	53

E

Expert Mode	54
-------------------	----

F

Film Stabilization	53
FREEZE	38

G

GameTimer®	46
------------------	----

H

HDMI audio mode	51
HDMI settings	51
Deep Color	51
Lip Sync	51
INSTAPORT™	51
RGB Range	51
HDMI™ connection	15

I

INFO button	52
INPUT button	32
Input Lock	46
Input label	29
INSTAPORT™	51
Integrated digital tuning	9

J

JPEG	58
------------	----

L

Language selection	27
Last mode memory feature	52
LED indications	61
Location	30
Lip Sync	51

M

Manual Tuning	28
Media Player	57
MODE SELECT	20, 21, 23
MPEG NR	54
MTS	42
MUTE	42

O

On Timer	48
Optical audio output format	43

P

Panel Lock	46
PC Audio	47
PC connection	18
PC settings	47
Picture mode	39
Picture quality	39
Picture scroll	38
Picture size selection	36
PIN code	43
POWER button	20, 21
Power-On Mode	30

R

RECALL button	52
REGZA-LINK® connection	16
REGZA-LINK® feature	49
Remote control	
Battery installation	19
Device code table	24
Functional key chart	22
Programming	23
Reset Factory Defaults	31
Resolution+™	53
RGB Range	51

S

SAP sound	42
Satellite receiver connection	14
Sleep Timer	48
Static Gamma	53
Stereo Extension	56
Stereo sound	42
SurfLock™	35
Surround	56
System status	31

T

TheaterLock™ feature	40
TheaterWide® picture size	36
Time Zone	30
TOSHIBA Illumination	30
Transparency	30
TV status information	52

V

V-Chip blocking	44
VCR connection	13
Voice Enhancement	56

TOSHIBA AMERICA CONSUMER PRODUCTS, L.L.C.

Corporate Headquarters: 82 TOTOWA ROAD, WAYNE, NJ 07470, U.S.A.
NATIONAL SERVICE DIVISION: 1420-B TOSHIBA DRIVE, LEBANON, TN 37087, U.S.A.

TOSHIBA OF CANADA LTD.

HEAD OFFICE: 191 McNABB STREET, MARKHAM, ONTARIO, L3R 8H2, CANADA – TEL: (905) 470-5400
SERVICE CENTERS:
TORONTO: 191 McNABB STREET, MARKHAM, ONTARIO L3R 8H2, CANADA – TEL: (905) 470-5400

MANUFACTURED BY

TOSHIBA ELECTROMEX, S.A. DE C.V.

Cinema Series, ColorStream, GameTimer and TheaterWide are registered trademarks of Toshiba America Consumer Products, L.L.C.
AutoView, Channel Browser, ClearFrame, DynaLight, ColorMaster, SurfLock, and TheaterLock are trademarks of Toshiba America Consumer Products, L.L.C.
REGZA and REGZA-LINK are registered trademarks of Toshiba Corporation.
Resolution+ is a trademark of Toshiba Corporation.

PRINTED IN MEXICO
(09-07)

TOSHIBA