



# Maintenance & Service Guide

HP Compaq Pro 4300 All-in-One Business PC

© Copyright 2012 Hewlett-Packard Development Company, L.P. The information contained herein is subject to change without notice.

Microsoft and Windows are trademarks of Microsoft Corporation in the U.S. and other countries.

The only warranties for HP products and services are set forth in the express warranty statements accompanying such products and services. Nothing herein should be construed as constituting an additional warranty. HP shall not be liable for technical or editorial errors or omissions contained herein.

This document contains proprietary information that is protected by copyright. No part of this document may be photocopied, reproduced, or translated to another language without the prior written consent of Hewlett-Packard Company.

#### **Maintenance & Service Guide**

HP Compaq Pro 4300 All-in-One Business PC

First Edition (June 2012)

Document Part Number: 700155-001

## About This Book

---

 **WARNING!** Text set off in this manner indicates that failure to follow directions could result in bodily harm or loss of life.

 **CAUTION:** Text set off in this manner indicates that failure to follow directions could result in damage to equipment or loss of information.

 **NOTE:** Text set off in this manner provides important supplemental information.

---



---

# Table of contents

<b>1 Product Features</b> .....	<b>1</b>
Overview .....	1
Front Components .....	3
Side Components .....	4
Rear Components .....	5
Adjusting Tilt .....	6
<b>2 Installing and Customizing the Software</b> .....	<b>7</b>
Installing the Operating System .....	7
Downloading Microsoft Windows Updates .....	7
Installing or Upgrading Device Drivers (Windows systems) .....	8
Accessing Disk Image (ISO) Files .....	8
Protecting the Software .....	8
<b>3 Computer Setup (F10) Utility</b> .....	<b>9</b>
Computer Setup (F10) Utilities .....	9
Using Computer Setup (F10) Utilities .....	10
Computer Setup—File .....	11
Computer Setup—Storage .....	12
Computer Setup—Security .....	13
Computer Setup—Power .....	15
Computer Setup—Advanced .....	16
<b>4 Serial ATA (SATA) Drive Guidelines and Features</b> .....	<b>17</b>
SATA Hard Drives .....	17
SATA Hard Drive Cables .....	17
SATA Data Cable .....	17
SMART ATA Drives .....	18
Hard Drive Capacities .....	18

<b>5 Routine Care and Disassembly Preparation .....</b>	<b>19</b>
Electrostatic Discharge Information .....	20
Generating Static .....	20
Preventing Electrostatic Damage to Equipment .....	20
Personal Grounding Methods and Equipment .....	21
Grounding the Work Area .....	21
Recommended Materials and Equipment .....	21
Operating Guidelines .....	22
Routine Care .....	23
General Cleaning Safety Precautions .....	23
Cleaning the Computer Case .....	23
Cleaning the Keyboard .....	23
Cleaning the Monitor .....	24
Cleaning the Mouse .....	24
Service Considerations .....	24
Tools and Software Requirements .....	24
Screws .....	24
Cables and Connectors .....	25
Hard Drives .....	25
Lithium Coin Cell Battery .....	25
<b>6 Removal and Replacement Procedures All-in One (AIO) Chassis .....</b>	<b>26</b>
Preparing to Disassemble the Computer .....	26
Hinge Cover Panel .....	27
Memory Access Panel .....	29
Drive Access Panel .....	31
Optical Drive .....	33
Hard Drive .....	35
Memory .....	38
Replacing the Battery .....	42
Heat Sink Cover .....	45
Heat Sink (Thermal Module) .....	47
Processor .....	49
Top Panel .....	51
Webcam Module .....	52
Stand .....	54
Rear Cover .....	55
Fan .....	56
Converter Board .....	58
Sidekey Board .....	60
System Board Shield .....	62

WLAN Module .....	64
Speakers .....	66
Stand bracket .....	68
System Board .....	70
Hard Drive and Optical Drive Cables and Connectors .....	73
Display Cable .....	75
Front Bezel .....	77
Display Panel .....	78
Power Switch Assembly .....	82
<b>7 Troubleshooting Without Diagnostics .....</b>	<b>84</b>
Safety and Comfort .....	84
Solving General Problems .....	85
Solving Power Problems .....	88
Solving Hard Drive Problems .....	88
Solving Media Card Reader Problems .....	92
Solving Display Problems .....	93
Solving Audio Problems .....	96
Solving Printer Problems .....	98
Solving Keyboard and Mouse Problems .....	99
Solving Hardware Installation Problems .....	101
Solving Network Problems .....	102
Solving Memory Problems .....	105
Solving Processor Problems .....	106
Solving CD-ROM and DVD Problems .....	107
Solving USB Flash Drive Problems .....	109
Solving Internet Access Problems .....	110
Solving Software Problems .....	112
<b>8 POST Error Messages .....</b>	<b>113</b>
POST Numeric Codes and Text Messages .....	114
Interpreting POST Diagnostic Front Panel LEDs .....	115
<b>9 Password Security and Resetting CMOS .....</b>	<b>116</b>
Establishing a Setup or Power-on Password .....	117
Resetting the Setup and Power-on Password .....	118
Resetting CMOS .....	119
<b>Appendix A Power Cord Set Requirements .....</b>	<b>120</b>
General Requirements .....	120

Japanese Power Cord Requirements .....	120
Country-Specific Requirements .....	121
<b>Appendix B Specifications .....</b>	<b>122</b>
All-in One Models .....	122
<b>Index .....</b>	<b>124</b>



---

# 1 Product Features

## Overview

**Figure 1-1** HP Compaq Pro 4300 All-in-One Business PC



The HP Compaq Pro 4300 All-in-One Business PC offers the following features:

- Integrated All-in-One form factor
- 20-inch diagonal widescreen 1600 x 900 WLED anti-glare display
- Adjustable tilt
- Removable panels on the back of the chassis allow users or technicians to easily and efficiently service the PC
- Optional integrated 1.3 MP webcam & single non-array microphone
- Integrated stereo speakers

- Choice of wired or wireless keyboard and mouse
- Windows® 7 Professional 32-bit or 64-bit operating system
- 6-in-1 media card reader
- 6 USB 2.0 ports
- Tray-load HP SuperMulti DVD+/-RW SATA Drive
- Up to 1 TB hard drive
- 2nd and 3rd generation Intel® Core™ processors
- Intel H61 Express Chipset
- Integrated Intel HD Graphics
- Integrated Gigabit network connection (Realtek RTL 8111 F Gigabit Ethernet)
- Up to 16 GB of DDR3 SDRAM memory
- Optional wireless LAN (802.11 a/g/n, 802.11 a/g/n with Bluetooth®)
- Face Recognition for HP ProtectTools software with auto-login capabilities (only with the optional webcam)
- ENERGY STAR® qualified, EPEAT® Silver registered, and offers 89-percent energy-efficient power

# Front Components

Figure 1-2 Front Components



Table 1-1 Front Components

Component	Component
1 Webcam	4 Power button and LED
2 Single microphone	5 High-performance stereo speakers
3 20-inch diagonal 16:9 widescreen LED-backlit LCD display	

# Side Components

Figure 1-3 Side Components



Table 1-2 Side Components

Component		Component	
1	HP USB Media Card Reader	6	Optical disc drive activity LED
2	(2) USB 2.0 ports	7	Tray-load optical disc drive
3	Microphone jack	8	Brightness increase button
4	Headphone jack	9	Brightness decrease button
5	Optical disc drive eject button	10	Hard drive activity LED

# Rear Components

Figure 1-4 Rear Components

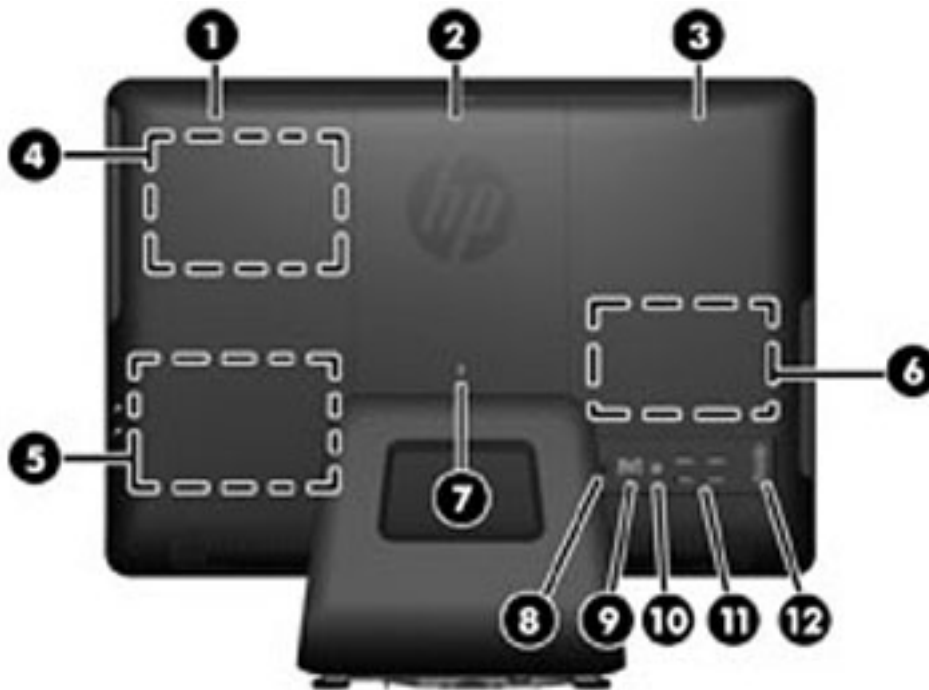

Table 1-3 Rear Components

Component	Component
1 Drive access panel	7 Security lock slot
2 Center access panel	8 Power connector with LED indicator
3 Memory access panel	9 RJ-45 Gigabit Ethernet port
4 Optical disc drive location	10 Stereo audio line out
5 Hard drive location	11 (4) USB 2.0 ports
6 Memory and battery location	12 Serial port

## Adjusting Tilt

Tilt the computer forward up to -5 degrees or backward up to +25 degrees to set it to a comfortable eye level.

**Figure 1-5** Adjusting Tilt





---

## 2 Installing and Customizing the Software

If your computer was not shipped with a Microsoft operating system, some portions of this documentation do not apply. Additional information is available in online help after you install the operating system.

 **NOTE:** If the computer was shipped with Windows 7 loaded, you will be prompted to register the computer with HP Total Care before installing the operating system. You will see a brief movie followed by an online registration form. Fill out the form, click the **Begin** button, and follow the instructions on the screen.

 **CAUTION:** Do not add optional hardware or third-party devices to the computer until the operating system is successfully installed. Doing so may cause errors and prevent the operating system from installing properly.

 **NOTE:** Be sure there is a 10.2-cm (4-inch) clearance at the back of the unit and above the monitor to permit the required airflow.

---

### Installing the Operating System

The first time you turn on the computer, the operating system is installed automatically. This process takes about 5 to 10 minutes, depending on which operating system is being installed. Carefully read and follow the instructions on the screen to complete the installation.

 **CAUTION:** Once the automatic installation has begun, **DO NOT TURN OFF THE COMPUTER UNTIL THE PROCESS IS COMPLETE.** Turning off the computer during the installation process may damage the software that runs the computer or prevent its proper installation.

 **NOTE:** If the computer shipped with more than one operating system language on the hard drive, the installation process could take up to 60 minutes.

---

If your computer was not shipped with a Microsoft operating system, some portions of this documentation do not apply. Additional information is available in online help after you install the operating system.

### Downloading Microsoft Windows Updates

1. To set up your Internet connection, click **Start > Internet Explorer** and follow the instructions on the screen.
2. Once an Internet connection has been established, click the **Start** button.

3. Select the **All Programs** menu.
4. Click on the **Windows Update** link.

In Windows 7, the **Windows Update** screen appears. Click **view available updates** and make sure all critical updates are selected. Click the **Install** button and follow the instructions on the screen.

It is recommended that you install all of the critical updates and service packs.

5. After the updates have been installed, Windows will prompt you to reboot the machine. Be sure to save any files or documents that you may have open before rebooting. Then select **Yes** to reboot the machine.

## Installing or Upgrading Device Drivers (Windows systems)

When installing optional hardware devices after the operating system installation is complete, you must also install the drivers for each of the devices.

If prompted for the i386 directory, replace the path specification with `C:\i386`, or use the **Browse** button in the dialog box to locate the i386 folder. This action points the operating system to the appropriate drivers.

Obtain the latest support software, including support software for the operating system from <http://www.hp.com/support>. Select your country and language, select **Download drivers and software (and firmware)**, enter the model number of the computer, and press **Enter**.

## Accessing Disk Image (ISO) Files

There are disk image files (ISO files) included on your PC that contain the installation software for additional software. These CD image files are located in the folder `C:\SWSetup\ISOs`. Each .iso file can be burned to CD media to create an installation CD. It is recommended that these disks be created and the software installed in order to get the most from your PC. The software and image file names are:

- Corel WinDVD SD and BD – installation software for WinDVD – used to play DVD movies
- HP Insight Diagnostics OR Vision Diagnostics – software to perform diagnostic activities on your PC

## Protecting the Software

To protect the software from loss or damage, keep a backup copy of all system software, applications, and related files stored on the hard drive. Refer to the operating system or backup utility documentation for instructions on making backup copies of your data files.



---

## 3 Computer Setup (F10) Utility

### Computer Setup (F10) Utilities

Use Computer Setup (F10) Utility to do the following:

- Change factory default settings.
- Set the system date and time.
- Set, view, change, or verify the system configuration, including settings for processor, memory, audio, storage, communications, and input devices.
- Modify the boot order of bootable devices such as hard drives, optical drives, or USB flash media devices.
- Select Post Messages Enabled or Disabled to change the display status of Power-On Self-Test (POST) messages. Post Messages Disabled suppresses most POST messages, such as memory count, product name, and other non-error text messages. If a POST error occurs, the error is displayed regardless of the mode selected. To manually switch to Post Messages Enabled during POST, press any key (except [F1](#) through [F12](#)).
- Establish an Ownership Tag, the text of which is displayed each time the system is turned on or restarted.
- Enter the Asset Tag or property identification number assigned by the company to this computer.
- Enable the power-on password prompt during system restarts (warm boots) as well as during power-on.
- Establish a setup password that controls access to the Computer Setup (F10) Utility and the settings described in this section.
- Secure integrated I/O functionality, including USB, audio, or embedded NIC, so that they cannot be used until they are unsecured.
- Solve system configuration errors detected but not automatically fixed during the Power-On Self-Test (POST).
- Execute self-tests on a specified ATA hard drive (when supported by drive).

## Using Computer Setup (F10) Utilities

Computer Setup can be accessed only by turning the computer on or restarting the system. To access the Computer Setup Utilities menu, complete the following steps:

1. Turn on or restart the computer.
2. Press **Esc** while the “Press the ESC key for Startup Menu” message is displayed at the bottom of the screen.



**NOTE:** If you do not press **Esc** at the appropriate time, you must restart the computer and again press **Esc** when the monitor light turns green to access the utility.

---

3. Press **F10** to enter Computer Setup.
4. A choice of five headings appears in the Computer Setup Utilities menu: File, Storage, Security, Power, and Advanced.
5. Use the arrow (left and right) keys to select the appropriate heading. Use the arrow (up and down) keys to select the option you want, then press **Enter**. To return to the Computer Setup Utilities menu, press **Esc**.
6. To apply and save changes, select **File > Save Changes and Exit**.
  - If you have made changes that you do not want applied, select **Ignore Changes and Exit**.
  - To reset to factory settings, select **Apply Defaults and Exit**. This option will restore the original factory system defaults.



**CAUTION:** Do NOT turn the computer power OFF while the BIOS is saving the Computer Setup (F10) changes because the CMOS could become corrupted. It is safe to turn off the computer only after exiting the F10 Setup screen.

---

## Computer Setup—File



**NOTE:** Support for specific Computer Setup options may vary depending on the hardware configuration.

**Table 3-1 Computer Setup—File**

Option	Description
<b>System Information</b>	Lists: <ul style="list-style-type: none"><li>• Product name</li><li>• SKU number (some models)</li><li>• Processor type/speed/stepping</li><li>• Cache size (L1/L2/L3)</li><li>• Installed memory size/speed, number of channels (single or dual) (if applicable)</li><li>• Integrated MAC address for embedded, enabled NIC (if applicable)</li><li>• System BIOS (includes family name and version)</li><li>• Chassis serial number</li><li>• Asset tag</li></ul>
<b>About</b>	Displays copyright notice.
<b>Set Time and Date</b>	Allows you to set system time and date.
<b>Apply Defaults and Exit</b>	Applies the currently selected default settings and clears any established passwords.
<b>Ignore Changes and Exit</b>	Exits Computer Setup without applying or saving any changes.
<b>Save Changes and Exit</b>	Saves changes to system configuration or default settings and exits Computer Setup.

## Computer Setup—Storage



**NOTE:** Support for specific Computer Setup options may vary depending on the hardware configuration.

**Table 3-2 Computer Setup—Storage**

Option	Description
<b>Device Configuration</b>	<p>Lists all installed BIOS-controlled storage devices.</p> <p>When a device is selected, detailed information and options are displayed. The following options may be presented:</p> <p><b>Hard Disk:</b> Size, model, firmware, and serial number.</p> <p><b>CD-ROM:</b> Model, firmware, and serial number.</p> <p><b>Diskette:</b> Model. Only displays when a USB diskette drive is connected to the computer.</p>
<b>Storage Options</b>	<p><b>SATA Emulation</b></p> <p>Allows you to choose how the SATA controller and devices are accessed by the operating system. There are two supported options: AHCI and IDE.</p> <p>AHCI (default option) - Allows operating systems with AHCI device drivers loaded to take advantage of more advanced features of the SATA controller.</p> <p>IDE - This is the most backwards-compatible setting of the two options. Operating systems usually do not require additional driver support in IDE mode.</p> <p><b>NOTE:</b> The AHCI device driver must be installed prior to attempting to boot from an AHCI volume. If you attempt to boot from an AHCI volume without the required device driver installed, the system will crash (blue screen).</p>
<b>DPS Self-Test</b>	<p>Allows you to execute self-tests on ATA hard drives capable of performing the Drive Protection System (DPS) self-tests.</p> <p><b>NOTE:</b> This selection will only appear when at least one drive capable of performing the DPS self-tests is attached to the system.</p>
<b>Boot Order</b>	<p>Allows you to:</p> <ul style="list-style-type: none"><li>Specify the order in which UEFI boot sources and legacy boot sources (such as a USB flash media device, hard drive, optical drive, or network interface card) are checked for a bootable operating system image. Each device on the list may be individually excluded from or included for consideration as a bootable operating system source.</li><li>Specify the order of attached hard drives. The first hard drive in the order will have priority in the boot sequence and will be recognized as drive C (if any devices are attached).</li></ul> <p>Press <b>F5</b> to disable a device. Press <b>Enter</b> to select a device. Press the arrow keys to drag a selected device.</p> <p><b>NOTE:</b> MS-DOS drive lettering assignments may not apply after a non-MS-DOS operating system has started.</p> <p><b>Shortcut to Temporarily Override Boot Order</b></p> <p>To boot <b>one time</b> from a device other than the default device specified in Boot Order, restart the computer and press <b>F9</b> before the computer boots to the operating system. After POST is completed, a list of bootable devices is displayed. Use the arrow keys to select the preferred bootable device and press <b>Enter</b>. The computer then boots from the selected non-default device for this one time.</p>

## Computer Setup—Security



**NOTE:** Support for specific Computer Setup options may vary depending on the hardware configuration.

**Table 3-3 Computer Setup—Security**

Option	Description
<b>Setup Password</b>	Allows you to set and enable a setup (administrator) password.  <b>NOTE:</b> If the setup password is set, it is required to change Computer Setup options, flash the ROM, and make changes to certain plug and play settings under Windows.
<b>Power-On Password</b>	Allows you to set and enable a power-on password. The power-on password prompt appears after a power cycle or reboot. If the user does not enter the correct power-on password, the unit will not boot.
<b>Device Security</b>	Allows you to set Device Available/Device Hidden for: <ul style="list-style-type: none"><li>• System Audio</li><li>• Network Controller (some models)</li><li>• SATA0</li><li>• SATA1</li></ul>
<b>USB Security</b>	Allows you to enable or disable groups of USB ports or individual USB ports. Default is device available. <ul style="list-style-type: none"><li>• Front USB Ports<ul style="list-style-type: none"><li>◦ USB Port 9</li><li>◦ USB Port 10</li></ul></li><li>• Rear USB Ports<ul style="list-style-type: none"><li>◦ USB Port 2</li><li>◦ USB Port 3</li><li>◦ USB Port 4</li><li>◦ USB Port 5</li></ul></li><li>• internal USB Ports<ul style="list-style-type: none"><li>◦ USB Port 0</li><li>◦ USB Port 11</li></ul></li></ul>
<b>Slot Security</b>	Allows you to disable or enable the Mini Card slot. Default is enable.
<b>Network Boot</b>	Enables/disables the computer's ability to boot from an operating system installed on a network server. (Feature available on NIC models only; the network controller must be either a PCI Express expansion card or embedded on the system board.) Default is enable.

**Table 3-3 Computer Setup—Security (continued)**

---

<b>System IDs</b>	Displays the following: <ul style="list-style-type: none"><li>• Product name</li><li>• Serial number</li><li>• Universal Unique Identifier (UUID) number. The UUID can only be updated if the current chassis serial number is invalid. (These ID numbers are normally set in the factory and are used to uniquely identify the system.)</li><li>• SKU number</li><li>• Family name</li><li>• Asset tag (18-byte identifier), a property identification number assigned by the company to the computer.</li><li>• Feature byte</li><li>• Build ID</li><li>• Keyboard locale setting (for example, English or German)</li></ul>
<b>System Security</b> (some models: these options are hardware dependent)	Data Execution Prevention (some models) (enable/disable) - Helps prevent operating system security breaches. Default is enabled.  Virtualization Technology (VTx/VTd) (some models) (enable/disable) - Controls the virtualization features of the processor and virtualization DMA remapping features of the chipset. Changing this setting requires turning the computer off and then back on. Default is disabled.

---

## Computer Setup—Power

 **NOTE:** Support for specific Computer Setup options may vary depending on the hardware configuration.

**Table 3-4 Computer Setup—Power**

Option	Description
<b>Hardware Power Management</b>	<ul style="list-style-type: none"><li>• SATA Power Management—Enables or disables the SATA bus and/or device power management. Default is enabled.</li><li>• S4/S5 Wake On LAN—Wake on LAN (WOL) is normally used to turn on and shutdown systems remotely. This option wakes the system from S4 (hibernate)/S5 (off) power state when a Wake on LAN packet is received and follows normal boot order. Default is disabled.</li></ul>
<b>Thermal</b>	Displays the system fan speed (RPMs).

## Computer Setup—Advanced



**NOTE:** Support for specific Computer Setup options may vary depending on the hardware configuration.

**Table 3-5 Computer Setup—Advanced**

Option	Heading
<b>Power-On Options</b>	<p>Allows you to set:</p> <ul style="list-style-type: none"><li>• POST messages (enable/disable). Suppresses most POST messages, such as memory count, product name, and other non-error text messages. If a POST error occurs, the error is displayed regardless of the mode selected.</li><li>• After Power Loss (off/on/previous state): Setting this option to:<ul style="list-style-type: none"><li>◦ Off—causes the computer to remain powered off when power is restored.</li><li>◦ On—causes the computer to power on automatically as soon as power is restored.</li><li>◦ Previous state—causes the computer to power on automatically as soon as power is restored, if it was on when power was lost.</li></ul></li></ul> <p><b>NOTE:</b> If you turn off power to the computer using the switch on a power strip, you will not be able to use the suspend/sleep feature or the Remote Management features.</p> <ul style="list-style-type: none"><li>• POST Delay (None, 5, 10 15, 20, or 60 seconds). Enabling this feature will add a user-specified delay to the POST process. This delay is sometimes needed for hard disks on some PCI cards that spin up very slowly, so slowly that they are not ready to boot by the time POST is finished. The POST delay also gives you more time to select <b>F10</b> to enter Computer (F10) Setup.</li></ul>
<b>BIOS Power-On</b>	Allows you to set the computer to turn on automatically at a time you specify.
<b>Onboard Devices</b>	Allows you to set resources for or disable Legacy devices.
<b>Bus Options</b>	<p>On some models, allows you to enable or disable:</p> <ul style="list-style-type: none"><li>• PCI SERR# Generation. Default is enable.</li><li>• PCI VGA Palette Snooping, which sets the VGA palette snooping bit in PCI configuration space; only needed when more than one graphics controller is installed. Default is disable.</li></ul>
<b>Device Options</b>	<p>Allows you to set:</p> <ul style="list-style-type: none"><li>• Num Lock State at Power-On (off/on). Default is on.</li><li>• Multi-Processor (enable/disable). Use this option to disable multi-processor support under the OS. Default is enabled.</li><li>• Hyper-threading (Enable/disable). Provides processor parallelization such that the operating system treats one processor as two. Default is enable.</li><li>• NIC Option ROM Download (enable/disable). The BIOS contains an embedded NIC option ROM to allow the unit to boot through the network to a PXE server. This is typically used to download a corporate image to a hard drive. The NIC option ROM takes up memory space below 1 MB commonly referred to as DOS Compatibility Hole (DCH) space. This space is limited. This F10 option will allow users to disable the downloading of this embedded NIC option ROM thus giving more DCH space for additional PCI cards which may need option ROM space. Default is-enable.</li><li>• Processor Frequency Multiplier. Accessible using <b>CTRL+A</b>. The frequency multiplier adapts the external frequency of the computer to the internal frequency of the processor. This setting lets you overclock your computer.</li></ul>



---

# 4 Serial ATA (SATA) Drive Guidelines and Features

 **NOTE:** HP only supports the use of SATA hard drives on these models of computer. No Parallel ATA (PATA) drives are supported.

---

## SATA Hard Drives

Serial ATA Hard Drive Characteristics	
Number of pins/conductors in data cable	7/7
Number of pins in power cable	15
Maximum data cable length	39.37 in (100 cm)
Data interface voltage differential	400-700 mV
Drive voltages	3.3 V, 5 V, 12 V
Jumpers for configuring drive	N/A
Data transfer rate	3.0 Gb/s

## SATA Hard Drive Cables

### SATA Data Cable

Always use an HP approved SATA 3.0 Gb/s cable as it is fully backwards compatible with the SATA 1.5 Gb/s drives.

Current HP desktop products ship with SATA 3.0 Gb/s hard drives.

SATA data cables are susceptible to damage if overflexed. Never crease a SATA data cable and never bend it tighter than a 30 mm (1.18 in) radius.

The SATA data cable is a thin, 7-pin cable designed to transmit data for only a single drive.

## SMART ATA Drives

The Self Monitoring Analysis and Recording Technology (SMART) ATA drives for the HP Personal Computers have built-in drive failure prediction that warns the user or network administrator of an impending failure or crash of the hard drive. The SMART drive tracks fault prediction and failure indication parameters such as reallocated sector count, spin retry count, and calibration retry count. If the drive determines that a failure is imminent, it generates a fault alert.

## Hard Drive Capacities

The combination of the file system and the operating system used in the computer determines the maximum usable size of a drive partition. A drive partition is the largest segment of a drive that may be properly accessed by the operating system. A single hard drive may therefore be subdivided into a number of unique drive partitions in order to make use of all of its space.

Because of the differences in the way that drive sizes are calculated, the size reported by the operating system may differ from that marked on the hard drive or listed in the computer specification. Drive size calculations by drive manufacturers are bytes to the base 10 while calculations by Microsoft are bytes to the base 2.

Drive/Partition Capacity Limits				
			Maximum Size	
File System	Controller Type	Operating System	Partition	Drive
FAT 32	ATA	Windows 7	32 GB	2 TB
NTFS	ATA	Windows 7	2 TB	2 TB

---

## 5 Routine Care and Disassembly Preparation

This chapter provides general service information for the computer. Adherence to the procedures and precautions described in this chapter is essential for proper service.

 **CAUTION:** When the computer is plugged into an AC power source, voltage is always applied to the system board. You must disconnect the power cord from the power source before opening the computer to prevent system board or component damage.

---

# Electrostatic Discharge Information

A sudden discharge of static electricity from your finger or other conductor can destroy static-sensitive devices or microcircuitry. Often the spark is neither felt nor heard, but damage occurs. An electronic device exposed to electrostatic discharge (ESD) may not appear to be affected at all and can work perfectly throughout a normal cycle. The device may function normally for a while, but it has been degraded in the internal layers, reducing its life expectancy.

Networks built into many integrated circuits provide some protection, but in many cases, the discharge contains enough power to alter device parameters or melt silicon junctions.

## Generating Static

The following table shows that:

- Different activities generate different amounts of static electricity.
- Static electricity increases as humidity decreases.

Event	Relative Humidity		
	55%	40%	10%
Walking across carpet	7,500 V	15,000 V	35,000 V
Walking across vinyl floor	3,000 V	5,000 V	12,000 V
Motions of bench worker	400 V	800 V	6,000 V
Removing DIPs* from plastic tube	400 V	700 V	2,000 V
Removing DIPs* from vinyl tray	2,000 V	4,000 V	11,500 V
Removing DIPs* from Styrofoam	3,500 V	5,000 V	14,500 V
Removing bubble pack from PCB	7,000 V	20,000 V	26,500 V
Packing PCBs in foam-lined box	5,000 V	11,000 V	21,000 V

\*These are then multi-packaged inside plastic tubes, trays, or Styrofoam.

 **NOTE:** 700 volts can degrade a product.

## Preventing Electrostatic Damage to Equipment

Many electronic components are sensitive to ESD. Circuitry design and structure determine the degree of sensitivity. The following packaging and grounding precautions are necessary to prevent damage to electric components and accessories.

- To avoid hand contact, transport products in static-safe containers such as tubes, bags, or boxes.
- Protect all electrostatic parts and assemblies with conductive or approved containers or packaging.
- Keep electrostatic sensitive parts in their containers until they arrive at static-free stations.
- Place items on a grounded surface before removing them from their container.

- Always be properly grounded when touching a sensitive component or assembly.
- Avoid contact with pins, leads, or circuitry.
- Place reusable electrostatic-sensitive parts from assemblies in protective packaging or conductive foam.

## Personal Grounding Methods and Equipment

Use the following equipment to prevent static electricity damage to equipment:

- **Wrist straps** are flexible straps with a maximum of one-megohm  $\pm$  10% resistance in the ground cords. To provide proper ground, a strap must be worn snug against bare skin. The ground cord must be connected and fit snugly into the banana plug connector on the grounding mat or workstation.
- **Heel straps/Toe straps/Boot straps** can be used at standing workstations and are compatible with most types of shoes or boots. On conductive floors or dissipative floor mats, use them on both feet with a maximum of one-megohm  $\pm$  10% resistance between the operator and ground.

Static Shielding Protection Levels	
Method	Voltage
Antistatic plastic	1,500
Carbon-loaded plastic	7,500
Metallized laminate	15,000

## Grounding the Work Area

To prevent static damage at the work area, use the following precautions:

- Cover the work surface with approved static-dissipative material. Provide a wrist strap connected to the work surface and properly grounded tools and equipment.
- Use static-dissipative mats, foot straps, or air ionizers to give added protection.
- Handle electrostatic sensitive components, parts, and assemblies by the case or PCB laminate. Handle them only at static-free work areas.
- Turn off power and input signals before inserting and removing connectors or test equipment.
- Use fixtures made of static-safe materials when fixtures must directly contact dissipative surfaces.
- Keep work area free of nonconductive materials such as ordinary plastic assembly aids and Styrofoam.
- Use field service tools, such as cutters, screwdrivers, and vacuums, that are conductive.

## Recommended Materials and Equipment

Materials and equipment that are recommended for use in preventing static electricity include:

- Antistatic tape
- Antistatic smocks, aprons, or sleeve protectors

- Conductive bins and other assembly or soldering aids
- Conductive foam
- Conductive tabletop workstations with ground cord of one-megohm +/- 10% resistance
- Static-dissipative table or floor mats with hard tie to ground
- Field service kits
- Static awareness labels
- Wrist straps and footwear straps providing one-megohm +/- 10% resistance
- Material handling packages
- Conductive plastic bags
- Conductive plastic tubes
- Conductive tote boxes
- Opaque shielding bags
- Transparent metallized shielding bags
- Transparent shielding tubes

## Operating Guidelines

To prevent overheating and to help prolong the life of the computer:

- Keep the computer away from excessive moisture, direct sunlight, and extremes of heat and cold.
- Operate the computer on a sturdy, level surface. Leave a 10.2-cm (4-inch) clearance on all vented sides of the computer and above the monitor to permit the required airflow.
- Never restrict the airflow into the computer by blocking any vents or air intakes. Do not place the keyboard, with the keyboard feet down, directly against the front of the desktop unit as this also restricts airflow.
- Occasionally clean the air vents on all vented sides of the computer. Lint, dust, and other foreign matter can block the vents and limit the airflow. Be sure to unplug the computer before cleaning the air vents.
- Never operate the computer with the cover removed.
- Do not place computers so near each other that they are subject to each other's re-circulated or preheated air.
- Keep liquids away from the computer and keyboard.
- Never cover the ventilation slots on the monitor with any type of material.
- Install or enable power management functions of the operating system or other software, including sleep states.

# Routine Care

## General Cleaning Safety Precautions

1. Never use solvents or flammable solutions to clean the computer.
2. Never immerse any parts in water or cleaning solutions; apply any liquids to a clean cloth and then use the cloth on the component.
3. Always unplug the computer when cleaning with liquids or damp cloths.
4. Always unplug the computer before cleaning the keyboard, mouse, or air vents.
5. Disconnect the keyboard before cleaning it.
6. Wear safety glasses equipped with side shields when cleaning the keyboard.

## Cleaning the Computer Case

Follow all safety precautions in [General Cleaning Safety Precautions on page 23](#) before cleaning the computer.

To clean the computer case, follow the procedures described below:

- To remove light stains or dirt, use plain water with a clean, lint-free cloth or swab.
- For stronger stains, use a mild dishwashing liquid diluted with water. Rinse well by wiping it with a cloth or swab dampened with clear water.
- For stubborn stains, use isopropyl (rubbing) alcohol. No rinsing is needed as the alcohol will evaporate quickly and not leave a residue.
- After cleaning, always wipe the unit with a clean, lint-free cloth.
- Occasionally clean the air vents on the computer. Lint and other foreign matter can block the vents and limit the airflow.

## Cleaning the Keyboard

Follow all safety precautions in [General Cleaning Safety Precautions on page 23](#) before cleaning the keyboard.

To clean the tops of the keys or the keyboard body, follow the procedures described in [Cleaning the Computer Case on page 23](#).

When cleaning debris from under the keys, review all rules in [General Cleaning Safety Precautions on page 23](#) before following these procedures:

---

 **CAUTION:** Use safety glasses equipped with side shields before attempting to clean debris from under the keys.

---

- Visible debris underneath or between the keys may be removed by vacuuming or shaking.
- Canned, pressurized air may be used to clean debris from under the keys. Caution should be used as too much air pressure can dislodge lubricants applied under the wide keys.

- If you remove a key, use a specially designed key puller to prevent damage to the keys. This tool is available through many electronic supply outlets.

---

**⚠ CAUTION:** Never remove a wide leveled key (like the space bar) from the keyboard. If these keys are improperly removed or installed, the keyboard may not function properly.

---

- Cleaning under a key may be done with a swab moistened with isopropyl alcohol and squeezed out. Be careful not to wipe away lubricants necessary for proper key functions. Use tweezers to remove any fibers or dirt in confined areas. Allow the parts to air dry before reassembly.

## Cleaning the Monitor

- Wipe the monitor screen with a clean cloth moistened with water or with a towelette designed for cleaning monitors. Do not use sprays or aerosols directly on the screen; the liquid may seep into the housing and damage a component. Never use solvents or flammable liquids on the monitor.
- To clean the monitor body follow the procedures in [Cleaning the Computer Case on page 23](#).

## Cleaning the Mouse

Before cleaning the mouse, ensure that the power to the computer is turned off.

- Clean the mouse ball by first removing the retaining plate and the ball from the housing. Pull out any debris from the ball socket and wipe the ball with a clean, dry cloth before reassembly.
- To clean the mouse body, follow the procedures in [Cleaning the Computer Case on page 23](#).

## Service Considerations

Listed below are some of the considerations that you should keep in mind during the disassembly and assembly of the computer.

## Tools and Software Requirements

To service the computer, you need the following:

- Torx T-15 screwdriver (HP screwdriver with bits, PN 161946-001)
- Flat-bladed screwdriver (may sometimes be used in place of the Torx screwdriver)
- Phillips #2 screwdriver
- Diagnostics software
- HP tamper-resistant T-15 wrench (Smart Cover FailSafe Key, PN 166527-001) or HP tamper-resistant bits (Smart Cover FailSafe Key, PN 166527-002)

## Screws

The screws used in the computer are not interchangeable. They may have standard or metric threads and may be of different lengths. If an incorrect screw is used during the reassembly process, it can damage the unit. HP strongly recommends that all screws removed during disassembly be kept with the part that was removed, then returned to their proper locations.

---

**⚠ CAUTION:** As each subassembly is removed from the computer, it should be placed away from the work area to prevent damage.

---



## Cables and Connectors

Most cables used throughout the unit are flat, flexible cables. These cables must be handled with care to avoid damage. Apply only the tension required to seat or unseat the cables during insertion or removal from the connector. Handle cables by the connector whenever possible. In all cases, avoid bending or twisting the cables, and ensure that the cables are routed in such a way that they cannot be caught or snagged by parts being removed or replaced.

---

 **CAUTION:** When servicing this computer, ensure that cables are placed in their proper location during the reassembly process. Improper cable placement can damage the computer.

---

## Hard Drives

Handle hard drives as delicate, precision components, avoiding all physical shock and vibration. This applies to failed drives as well as replacement spares.

- If a drive must be mailed, place the drive in a bubble-pack mailer or other suitable protective packaging and label the package “Fragile: Handle With Care.”
- Do not remove hard drives from the shipping package for storage. Keep hard drives in their protective packaging until they are actually mounted in the CPU.
- Avoid dropping drives from any height onto any surface.
- If you are inserting or removing a hard drive, turn off the computer. Do not remove a hard drive while the computer is on or in standby mode.
- Before handling a drive, ensure that you are discharged of static electricity. While handling a drive, avoid touching the connector. For more information about preventing electrostatic damage, refer to [Electrostatic Discharge Information on page 20](#)
- Do not use excessive force when inserting a drive.
- Avoid exposing a hard drive to liquids, temperature extremes, or products that have magnetic fields such as monitors or speakers.

## Lithium Coin Cell Battery

The battery that comes with the computer provides power to the real-time clock and has a minimum lifetime of about three years.

See the appropriate removal and replacement chapter for the chassis you are working on in this guide for instructions on the replacement procedures.

---

 **WARNING!** This computer contains a lithium battery. There is a risk of fire and chemical burn if the battery is handled improperly. Do not disassemble, crush, puncture, short external contacts, dispose in water or fire, or expose it to temperatures higher than 140°F (60°C). Do not attempt to recharge the battery.

 **NOTE:** Batteries, battery packs, and accumulators should not be disposed of together with the general household waste. In order to forward them to recycling or proper disposal, please use the public collection system or return them to HP, their authorized partners, or their agents.

---

---

# 6 Removal and Replacement Procedures All-in One (AIO) Chassis

The following sections provide information about disassembling various components of the computer.

## Preparing to Disassemble the Computer

To avoid injury and equipment damage, always complete the following steps in order, when opening the HP Pro All-in-One.

1. Remove all media (CD, DVD, etc.) from the computer.
2. Shut down the computer.
3. After the system has completely shut down, disconnect the power adapter from the back of the computer.
4. Disconnect all other attached cables from the back of the computer.
5. Place the computer face down on a soft flat surface. HP recommends that you set down a blanket, towel, or other soft cloth to protect the screen surface from scratches or other damage.

---

 **WARNING!** Beware of sharp edges inside the chassis.

---

## Hinge Cover Panel

The hinge cover panel is located above the stand. You must remove it to remove the drive access panel and memory access panel.

**Figure 6-1** Hinge cover panel location



To remove the hinge cover panel:

1. Prepare the computer for disassembly (see [Preparing to Disassemble the Computer on page 26](#)).

2. Remove the hinge cover panel by pulling outward on the panel at the slot on the top edge of the panel.

**Figure 6-2** Removing the hinge cover panel



To replace the hinge cover panel, reverse the removal procedures.

## Memory Access Panel

The memory access panel is located on the rear, right side of the computer (viewed from behind). You must remove it to access the memory modules and RTC battery.

**Figure 6-3** Memory access panel location



To remove the memory access panel:

1. Prepare the computer for disassembly (see [Preparing to Disassemble the Computer on page 26](#)).
2. Remove the center access panel (see [Hinge Cover Panel on page 27](#)).

3. Open the latch securing the memory access panel.

**Figure 6-4** Opening the memory access panel latch

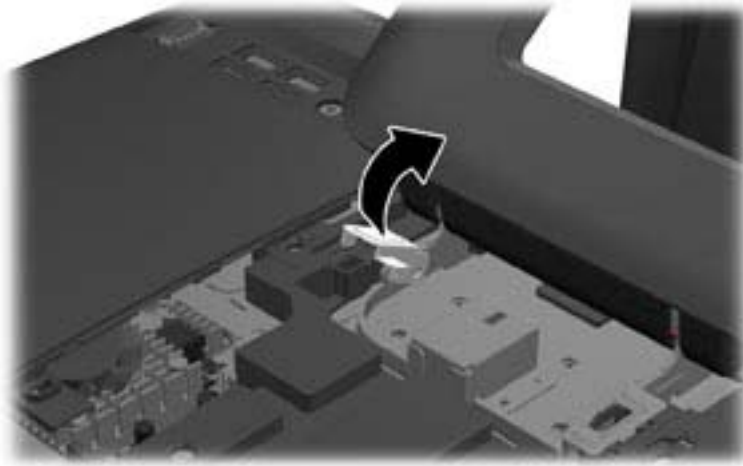

4. To remove the memory access panel, press down on the tab on the inside edge of the panel (1) and slide the panel off the computer (2).

**Figure 6-5** Removing the memory access panel

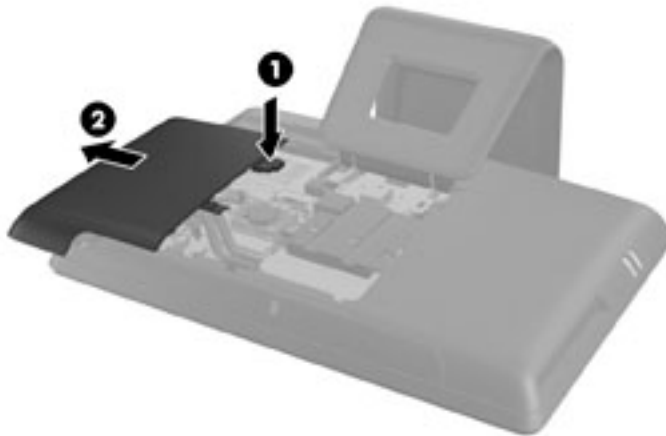

To replace the memory access panel, reverse the removal procedures.

## Drive Access Panel

The drive access panel is located on the rear, left side of the computer (viewed from behind). You must remove it to access the hard drive and optical drive.

**Figure 6-6** Drive access panel location



To remove the drive access panel:

1. Prepare the computer for disassembly (see [Preparing to Disassemble the Computer on page 26](#)).
2. Remove the center access panel (see [Hinge Cover Panel on page 27](#)).

3. Open the latch securing the drive access panel.

**Figure 6-7** Opening the drive access panel latch

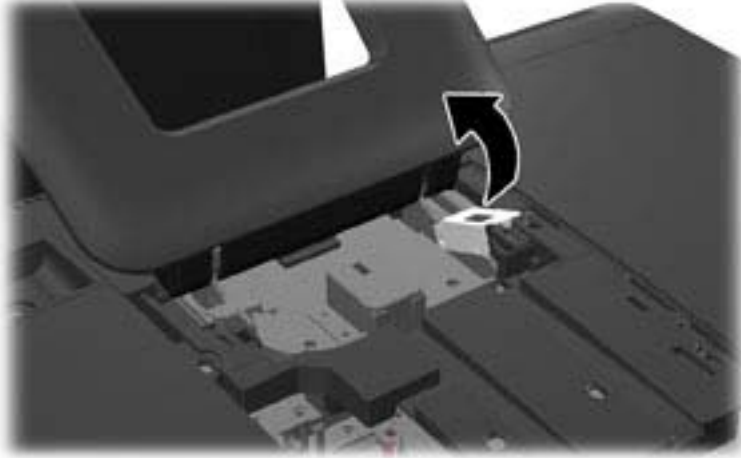

4. To remove the drive access panel, push downward on the tab on the inside edge of the panel (1) and slide the panel off the computer (2).

**Figure 6-8** Removing the drive access panel

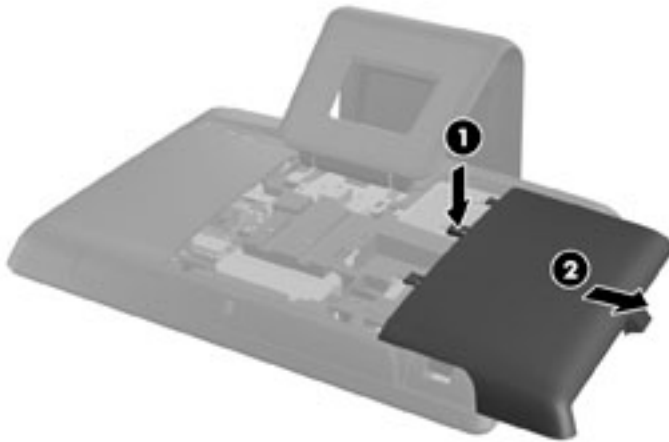

To replace the drive access panel, reverse the removal procedures.



# Optical Drive

The optical drive is located under the drive access panel on the left side of the computer (viewed from behind). It is secured with one Torx screw.

**Figure 6-9** Optical drive location

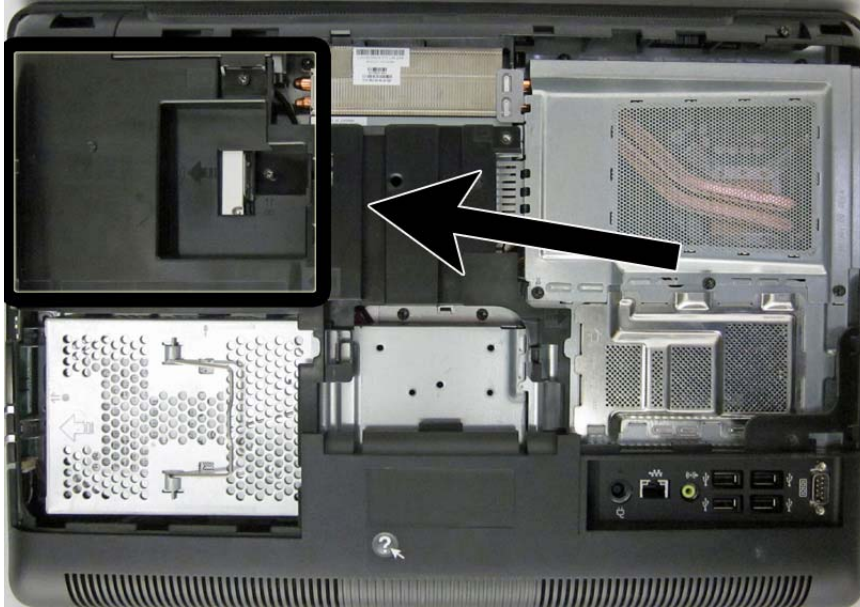

To remove the optical drive:

1. Prepare the computer for disassembly (see [Preparing to Disassemble the Computer on page 26](#)).
2. Remove the center access panel (see [Hinge Cover Panel on page 27](#)).
3. Remove the drive access panel (see [Drive Access Panel on page 31](#)).
4. Remove the screw through the tab on the end of the drive that secures the drive to the computer.

**Figure 6-10** Removing the optical disc drive security screw



- Using your fingers, press the visible edge of the optical disc drive toward the side of the computer to push the drive partially out of the computer. Grasp the front end of the drive and pull the drive out of the computer.

**Figure 6-11** Removing the optical disc drive



- If you need to remove the drive bracket from the drive, remove the two screws (1) that secure the bracket to the drive, and then remove the bracket from the drive (2).

 **NOTE:** Optical drive spare part kits do not include replacement brackets.

**Figure 6-12** Removing the optical drive bracket



To install an optical drive, reverse the removal procedures.

# Hard Drive

The hard drive is located under the drive access panel on the left side of the computer (viewed from behind). The drive is secured with one captive Torx screw and is housed in a removable cage.

**Figure 6-13** Hard drive location

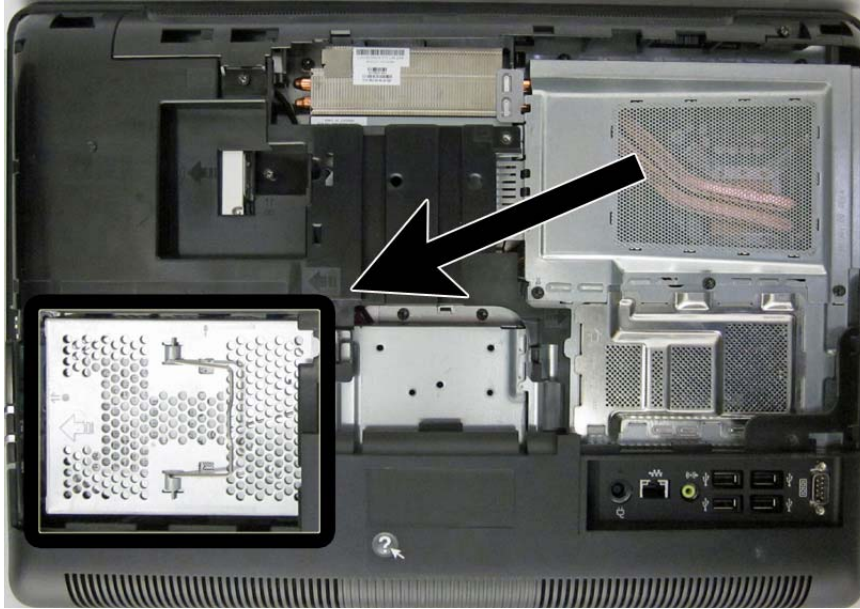

1. Prepare the computer for disassembly (see [Preparing to Disassemble the Computer on page 26](#)).
2. Remove the center access panel (see [Hinge Cover Panel on page 27](#)).
3. Remove the drive access panel (see [Drive Access Panel on page 31](#)).
4. Loosen the captive screw next to the front of the drive that secures the drive to the computer.

**Figure 6-14** Loosening the hard drive security screw

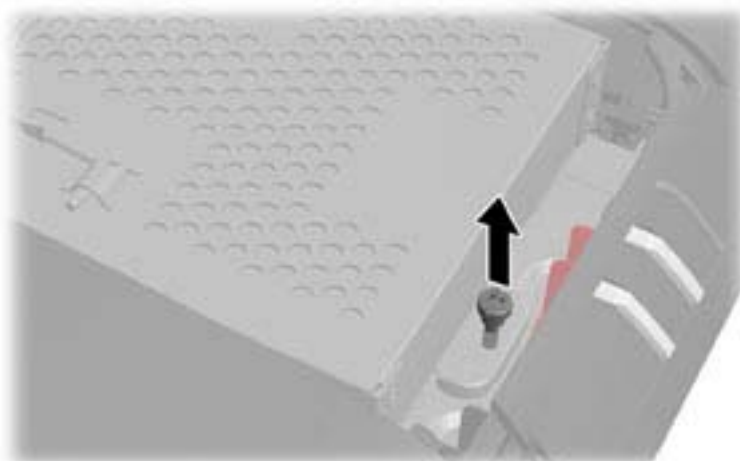

5. Grasp the handle on top of the hard drive cage (1) and slide the cage toward the outer edge of the computer, then lift the cage out of the computer (2).

**Figure 6-15** Removing the hard drive cage

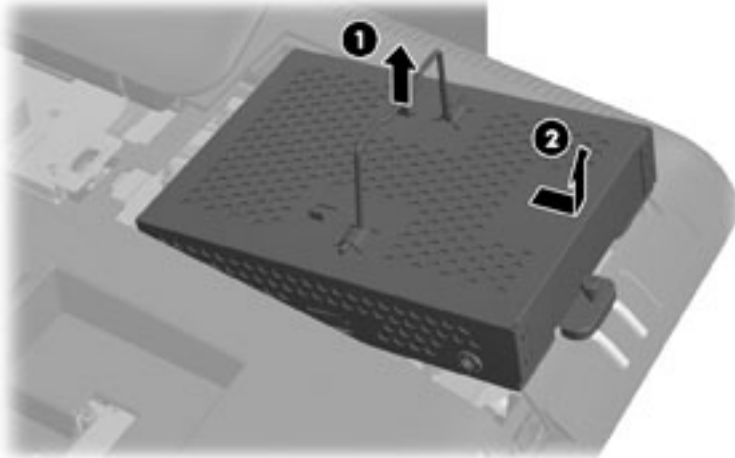

6. Remove the four mounting screws that secure the drive to the cage. Do not remove the blue rubber grommets behind each screw. They must stay attached to the cage when installing a new hard drive.

**Figure 6-16** Removing the hard drive mounting screws

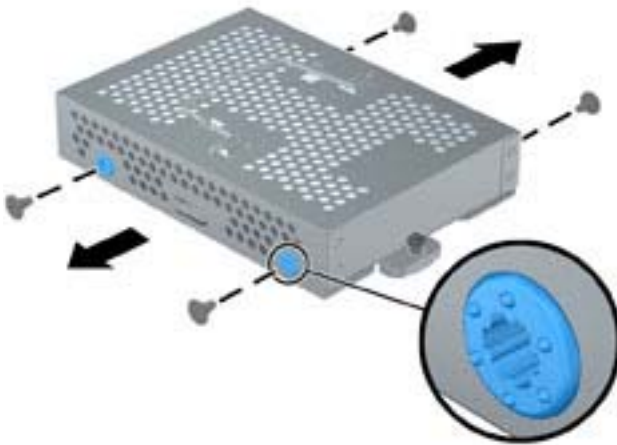

7. Slide the hard drive out of the cage.

**Figure 6-17** Removing the hard drive from the cage



To replace the hard drive, reverse the removal procedures.

---

 **NOTE:** If you choose to install an optional 2.5-inch solid state drive (SSD) or self-encrypting drive (SED), you must mount that drive in a drive adapter, and then install the assembly in the hard drive cage as you would a 3.5-inch hard drive.

---

# Memory

Memory modules are located on the right side of the computer (viewed from behind) under the memory access panel. The computer has two memory slots.

**Figure 6-18** Memory module location



The computer comes with double data rate 3 synchronous dynamic random access memory (DDR3-SDRAM) small outline dual inline memory modules (SODIMMs).

The memory sockets on the system board can be populated with up to two industry-standard SODIMMs. These memory sockets are populated with at least one preinstalled SODIMM. To achieve the maximum memory support, you can populate the system board with up to 16 GB of memory.

For proper system operation, the SODIMMs must be:

- industry-standard 204-pin
- unbuffered non-ECC PC3-10600 DDR3-1600 MHz-compliant
- 1.5 volt DDR3-SDRAM SODIMMs

The DDR3-SDRAM SODIMMs must also:

- support CAS latency 9 DDR3 1600 MHz (9-9-9 timing)
- contain the mandatory Joint Electronic Device Engineering Council (JEDEC) specification

In addition, the computer supports:

- 512-Mbit, 1-Gbit, and 2-Gbit non-ECC memory technologies
- single-sided and double-sided SODIMMS
- SODIMMs constructed with x8 and x16 devices; SODIMMs constructed with x4 SDRAM are not supported



**NOTE:** The system will not operate properly if you install unsupported SODIMMs.

The system will automatically operate in single channel mode, dual channel mode, or flex mode, depending on how the SODIMMs are installed. Refer to the following table to identify the SODIMM channel locations.

**Table 6-1 Identifying SODIMM locations**

Location	System Board Label	Channel
Lower Socket	DIMM0	Channel B
Upper Socket	DIMM0	Channel A

- The system will operate in single channel mode if the SODIMM sockets are populated in one channel only.
- The system will operate in a higher-performing dual channel mode if the memory capacity of the SODIMM in Channel A is equal to the memory capacity of the SODIMM in Channel B.
- The system will operate in flex mode if the memory capacity of the SODIMM in Channel A is not equal to the memory capacity of the SODIMM in Channel B. In flex mode, the channel populated with the least amount of memory describes the total amount of memory assigned to dual channel and the remainder is assigned to single channel. If one channel will have more memory than the other, the larger amount should be assigned to channel A.
- In any mode, the maximum operational speed is determined by the slowest SODIMM in the system.

There are two memory sockets on the system board located behind the memory access panel. To remove or install memory modules:

To remove a memory module:

1. Prepare the computer for disassembly (see [Preparing to Disassemble the Computer on page 26](#)).
2. Place the computer face down on a soft flat surface. HP recommends that you set down a blanket, towel, or other soft cloth to protect the screen surface from scratches or other damage.
3. Remove the center access panel (see [Hinge Cover Panel on page 27](#)).
4. Remove the memory access panel (see [Memory Access Panel on page 29](#)).

5. Pull upward on the raised tab on the memory cover and lift the cover off the computer.

**Figure 6-19** Removing the memory cover



6. To remove a memory module, press outward on the two latches on each side of the SODIMM (1), then pull the SODIMM out of the socket (2).

**Figure 6-20** Removing a memory module

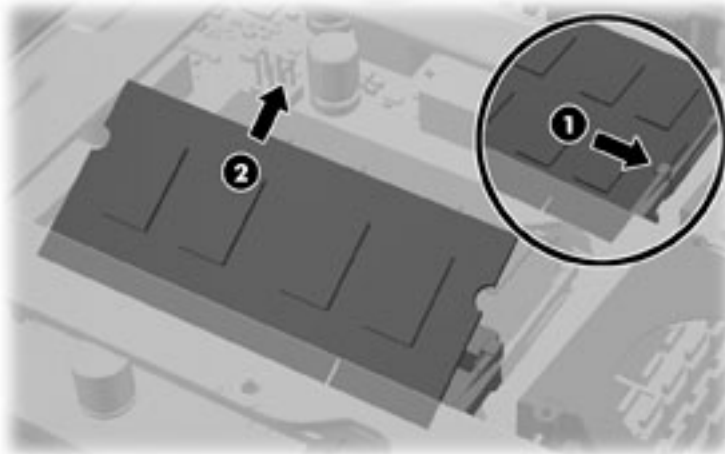



7. To install a memory module, slide the SODIMM into the socket at approximately a 30° angle (1), then press the SODIMM down (2) so that the latches lock it in place (3).

**Figure 6-21** Installing a memory module

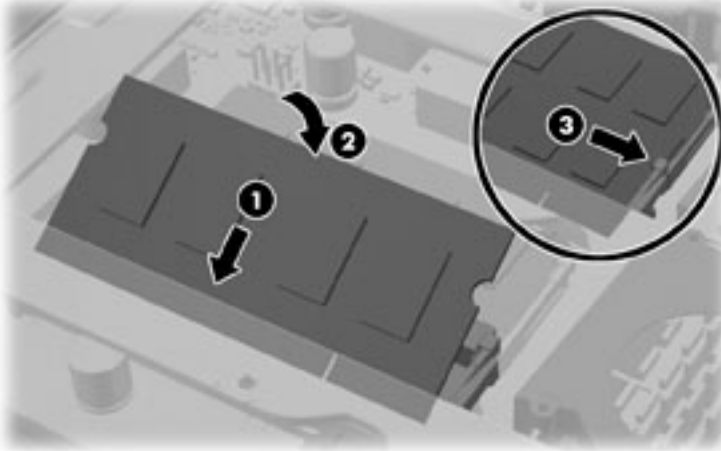

 **NOTE:** A memory module can be installed in only one way. Match the notch on the module with the tab on the memory socket.

8. Press the memory cover back in place. Insert the bottom edge of the memory cover into the sheet metal shielding first, then press the top edge of memory cover down. Ensure that all the tabs on the memory cover are pressed firmly against the sheet metal shielding.

**Figure 6-22** Replacing the memory cover

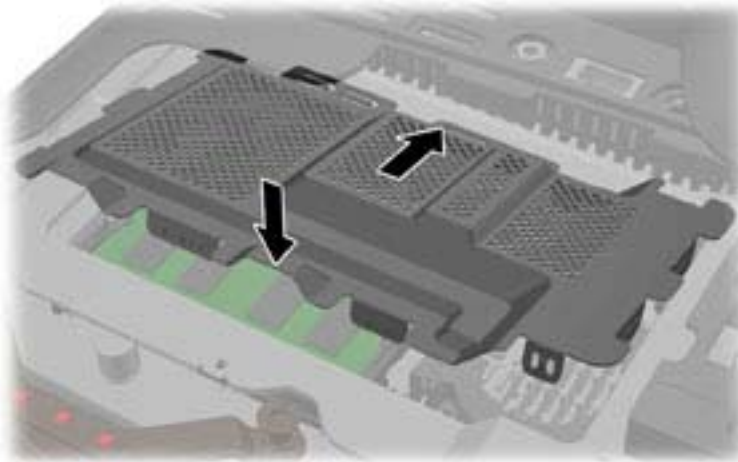

The computer automatically recognizes the additional memory when you turn on the computer.

## Replacing the Battery

The RTC battery is located near the memory modules under the memory access panel.

**Figure 6-23** Battery location

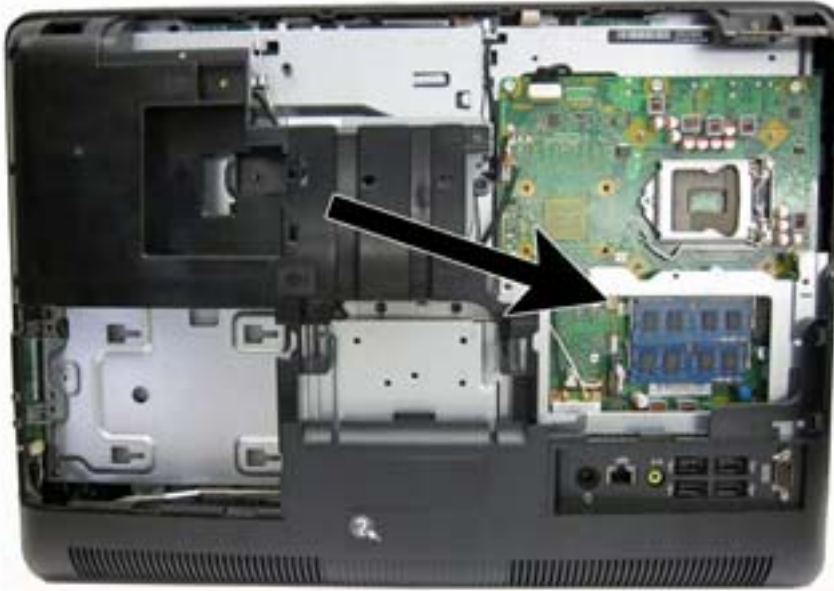

The battery is located in the memory compartment. The battery that comes with the computer provides power to the real-time clock. When replacing the battery, use a battery equivalent to the battery originally installed in the computer. The computer comes with a 3-volt lithium coin cell battery.

**WARNING!** The computer contains an internal lithium manganese dioxide battery. There is a risk of fire and burns if the battery is not handled properly. To reduce the risk of personal injury:

Do not attempt to recharge the battery.

Do not expose to temperatures higher than 60° C (140° F).

Do not disassemble, crush, puncture, short external contacts, or dispose of in fire or water.

Replace the battery only with the HP spare designated for this product.

**CAUTION:** Before replacing the battery, it is important to back up the computer CMOS settings. When the battery is removed or replaced, the CMOS settings will be cleared.

Static electricity can damage the electronic components of the computer or optional equipment. Before beginning these procedures, ensure that you are discharged of static electricity by briefly touching a grounded metal object.

 **NOTE:** The lifetime of the lithium battery can be extended by plugging the computer into a live AC wall socket. The lithium battery is only used when the computer is NOT connected to AC power.

HP encourages customers to recycle used electronic hardware, HP original print cartridges, and rechargeable batteries. For more information about recycling programs, go to <http://www.hp.com/recycle>.

---

1. Prepare the computer for disassembly (see [Preparing to Disassemble the Computer on page 26](#)).
2. Remove the center access panel (see [Hinge Cover Panel on page 27](#)).
3. Remove the memory access panel (see [Memory Access Panel on page 29](#)).
4. Pull upward on the raised tab on the memory cover and lift the cover off the computer.

**Figure 6-24** Removing the memory cover



5. Depending on the type of battery holder on the system board, complete the following instructions to replace the battery.

**Type 1**

- a. Lift the battery out of its holder.

**Figure 6-25** Removing a coin cell battery (Type 1)

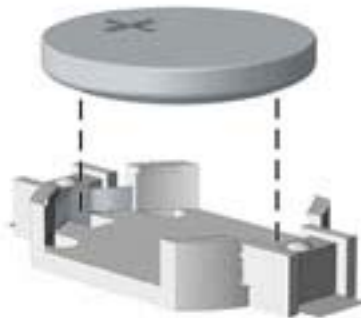

- b. Slide the replacement battery into position, positive side up. The battery holder automatically secures the battery in the proper position.

### Type 2

- a. To release the battery from its holder, squeeze the metal clamp that extends above one edge of the battery. When the battery pops up, lift it out (1).
- b. To insert the new battery, slide one edge of the replacement battery under the holder's lip with the positive side up. Push the other edge down until the clamp snaps over the other edge of the battery (2).

**Figure 6-26** Removing and replacing a coin cell battery (Type 2)



### Type 3

- a. Pull back on the clip (1) that is holding the battery in place, and remove the battery (2).
- b. Insert the new battery and position the clip back into place.

**Figure 6-27** Removing a coin cell battery (Type 3)

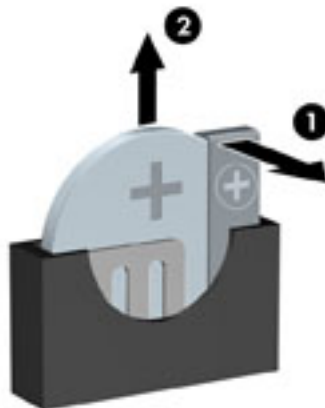

# Heat Sink Cover

The heat sink cover protects the heat sink and system board. It is secured with five Torx screws.

**Figure 6-28** Heat sink cover location

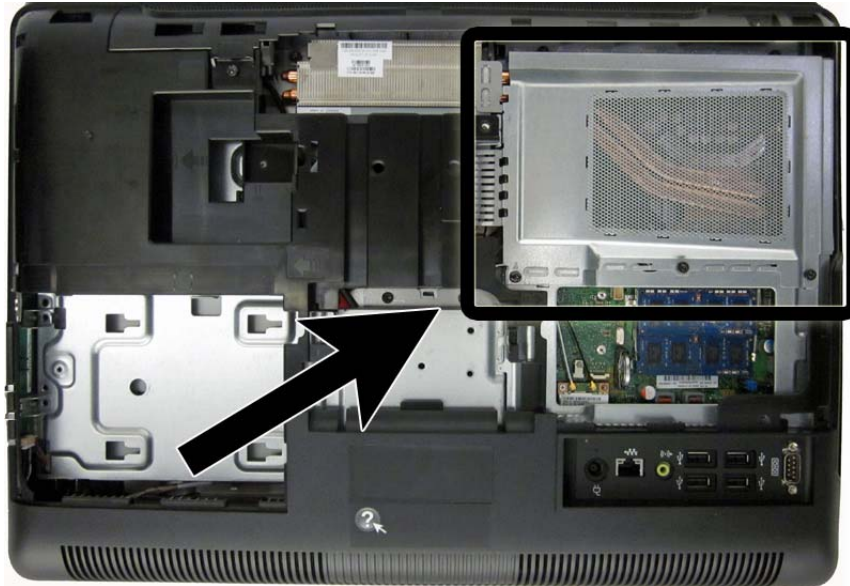

To remove the heat sink cover:

1. Prepare the computer for disassembly (see [Preparing to Disassemble the Computer on page 26](#)).
2. Remove the center access panel (see [Hinge Cover Panel on page 27](#)).
3. Remove the memory access panel (see [Memory Access Panel on page 29](#)).
4. Remove the five black Torx screws that secure the cover to the computer.

**Figure 6-29** Heat sink cover screws



5. Lift the cover from the computer.

**Figure 6-30** Removing the heat sink cover



To install the heat sink cover, reverse the removal procedures.

When installing the cover, be sure to insert the tabs from the cover into the slots in the computer.

**Figure 6-31** installing the heat sink cover



## Heat Sink (Thermal Module)

The heat sink is secured with five Torx screws – four captured, one not captured.

**Figure 6-32** Heat sink location

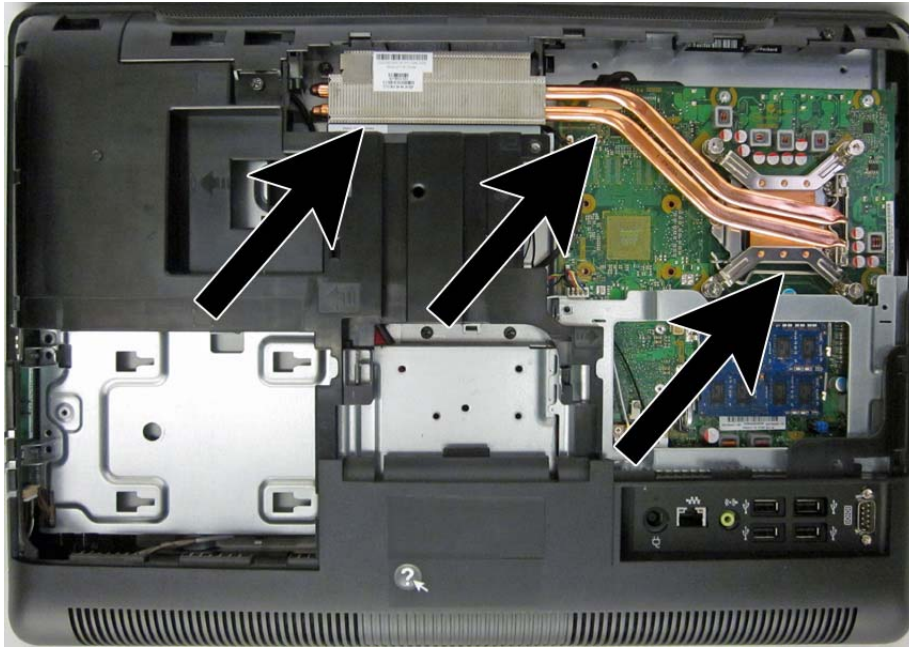

To remove the heat sink:

1. Prepare the computer for disassembly (see [Preparing to Disassemble the Computer on page 26](#)).
2. Remove the center access panel (see [Hinge Cover Panel on page 27](#)).
3. Remove the memory access panel (see [Memory Access Panel on page 29](#)).
4. Remove the drive access panel (see [Drive Access Panel on page 31](#)).
5. Remove the stand (see [Stand on page 54](#)).
6. Remove the heat sink cover (see [Heat Sink Cover on page 45](#)).
7. Loosen the four silver captive Torx screws on the heat sink **(1)**.

**⚠ CAUTION:** Remove heat sink retaining screws in diagonally opposite pairs (as in an X) to even the downward forces on the processor. This is especially important as the pins on the socket are very fragile and any damage to them may require replacing the system board.

8. Remove the black Torx screw from the top of the heat sink (2).

**Figure 6-33** Loosening and removing the heat sink screws

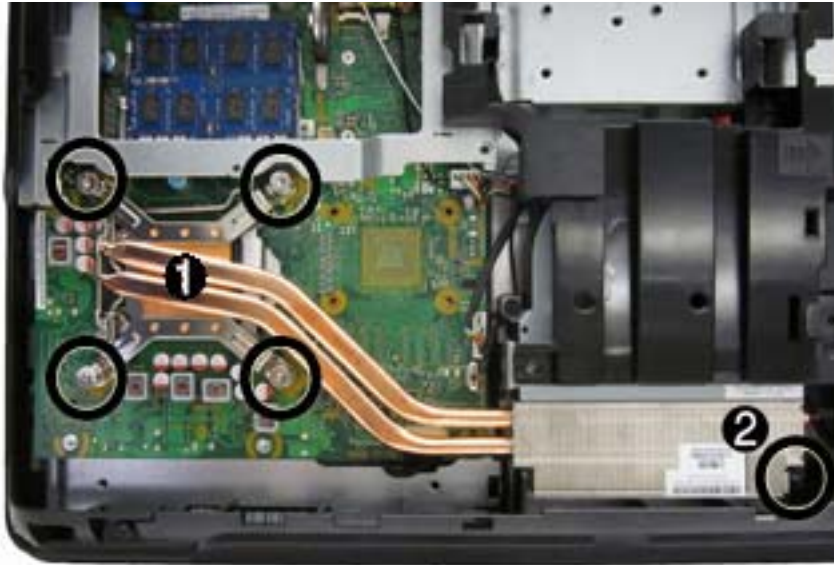

9. Lift the heat sink from the computer.

**Figure 6-34** Removing the heat sink



**CAUTION:** To reduce a degradation in thermal performance, be sure not to touch the thermal grease on the surface of the processor or the heat sink.

To replace the heat sink, reverse the removal procedures.



# Processor

1. Prepare the computer for disassembly (see [Preparing to Disassemble the Computer on page 26](#)).
2. Remove the center access panel (see [Hinge Cover Panel on page 27](#)).
3. Remove the memory access panel (see [Memory Access Panel on page 29](#)).
4. Remove the drive access panel (see [Drive Access Panel on page 31](#)).
5. Remove the heat sink cover (see [Heat Sink Cover on page 45](#)).
6. Remove the heat sink (see [Heat Sink \(Thermal Module\) on page 47](#)).
7. Rotate the locking lever to its full open position **(1)**.
8. Raise and rotate the microprocessor retainer to its fully open position **(2)**.
9. Carefully lift the processor from the socket **(3)**.

**⚠ CAUTION:** Do NOT handle the pins in the processor socket. These pins are very fragile and handling them could cause irreparable damage. Once pins are damaged it may be necessary to replace the system board.

The heat sink must be installed within 24 hours of installing the processor to prevent damage to the processor's solder connections.

**Figure 6-35** Removing the processor

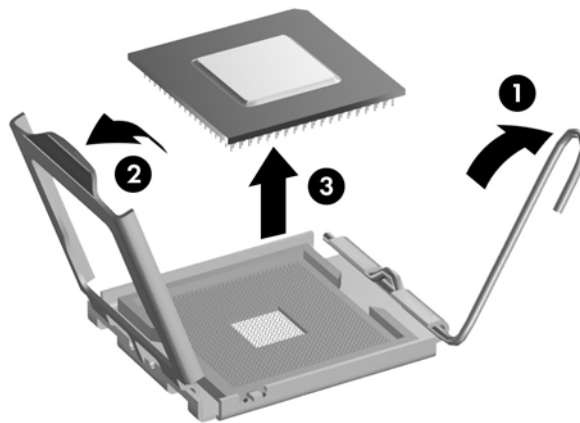

To install a new processor:

1. Place the processor in its socket and close the retainer. Make sure the slot in the processor fits into the post on the socket.
2. Secure the locking lever. If reusing the existing heat sink, go to step 3. If using a new heat sink, go to step 6.

3. If reusing the existing fan sink, clean the bottom of the fan sink with the alcohol pad provided in the spares kit.

---

 **CAUTION:** Before reinstalling the fan sink you must clean the top of the processor and the bottom of the fan sink with an alcohol pad supplied in the spares kit. After the alcohol has evaporated, apply thermal grease to the top of the processor from the syringe supplied in the spares kit.

---

4. Apply the thermal grease provided in the spares kit to the top of the processor and install the fan sink atop the processor.
5. Go to step 7.
6. If using a new fan sink, remove the protective covering from the bottom of the fan sink and place it in position atop the processor.
7. Secure the fan sink to the system board and system board tray.

---

 **CAUTION:** Fan sink retaining screws should be tightened in diagonally opposite pairs (as in an X) to evenly seat the fan sink on the processor. This is especially important as the pins on the socket are very fragile and any damage to them may require replacing the system board.

---

 **NOTE:** After installing a new processor onto the system board, always update the system ROM to ensure that the latest version of the BIOS is being used on the computer. The latest system BIOS can be found on the Web at: <http://h18000.www1.hp.com/support/files>.

---

## Top Panel

The top panel is secured with two Torx screws. Removing it allows access to the webcam and allows you to remove the main rear cover.

**Figure 6-36** Top panel location

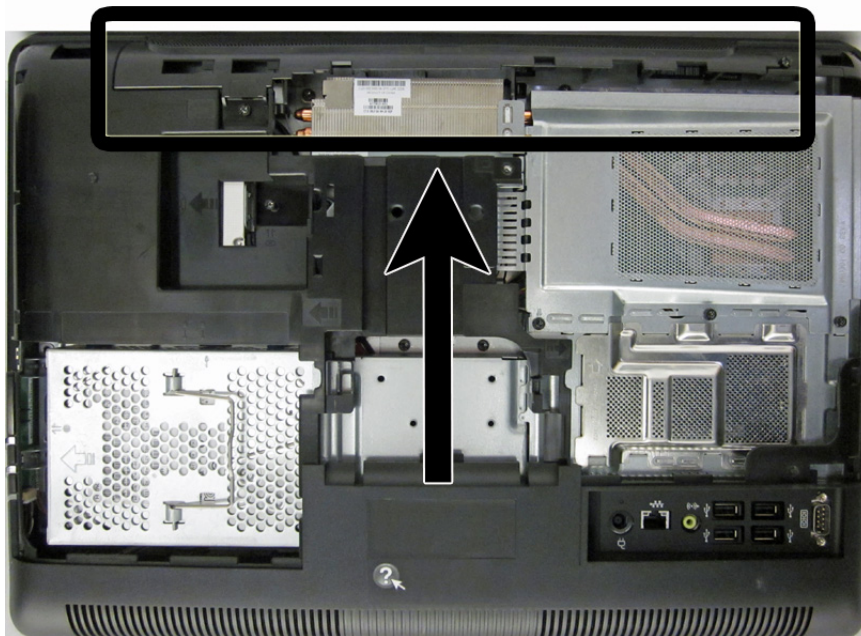

To remove the top panel:

1. Prepare the computer for disassembly (see [Preparing to Disassemble the Computer on page 26](#)).
2. Remove the center access panel (see [Hinge Cover Panel on page 27](#)).
3. Remove the memory access panel (see [Memory Access Panel on page 29](#)).
4. Remove the drive access panel (see [Drive Access Panel on page 31](#)).
5. On the top of the computer, remove the two black Torx screws (1) that secure the top panel to the computer.
6. Rotate the top of the panel outward (2), and then lift the panel off the computer.

**Figure 6-37** Removing the top panel



To replace the top panel, reverse the removal procedures.

## Webcam Module

The webcam module is located at the top of the computer beneath the top panel. It is secured with two silver Phillips screws and has one connector.

**Figure 6-38** Webcam module location

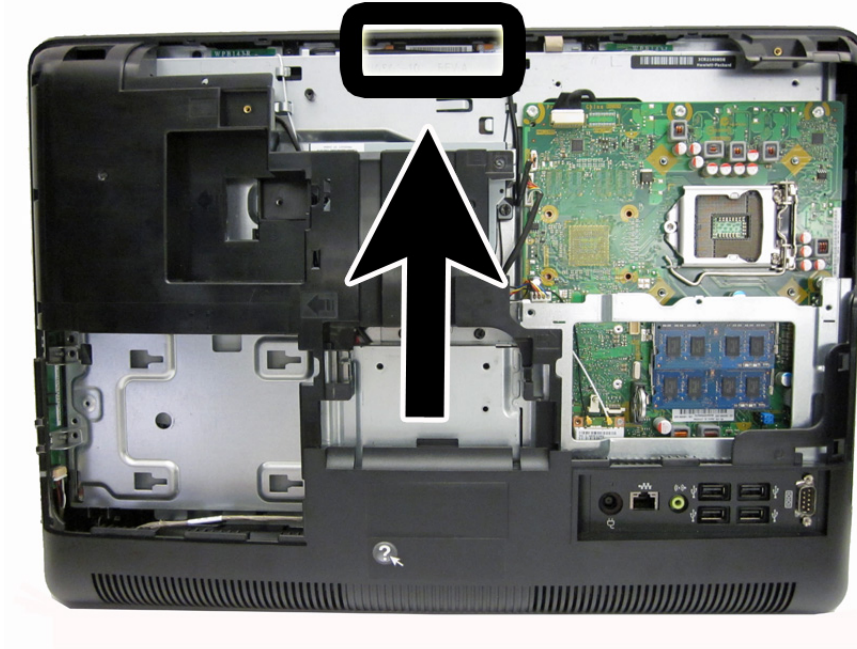

To remove the webcam module:

1. Prepare the computer for disassembly (see [Preparing to Disassemble the Computer on page 26](#)).
2. Remove the center access panel (see [Hinge Cover Panel on page 27](#)).
3. Remove the memory access panel (see [Memory Access Panel on page 29](#)).
4. Remove the drive access panel (see [Drive Access Panel on page 31](#)).
5. Remove the top panel (see [Top Panel on page 51](#)).

6. Remove the two silver Phillips screws that secure the webcam module to the computer.

**Figure 6-39** Webcam module screws



7. As far as the cable allows, remove the webcam module from the computer, and then disconnect the cable from the module.

**Figure 6-40** Disconnecting the webcam module



To install a webcam module, reverse the removal procedures.

## Stand

The stand is secured with three Torx screws. You must remove the center access panel to remove the stand.

To remove the stand:

1. Prepare the computer for disassembly (see [Preparing to Disassemble the Computer on page 26](#)).
2. Remove the center access panel (see [Hinge Cover Panel on page 27](#)).
3. Remove the three silver Torx screws (1) that secure the stand to the computer.
4. Lift the memory and drive access panel latches (2).
5. Slide the stand toward the top of the computer slightly (3), and then lift the stand off the computer (4).

**Figure 6-41** Removing the stand

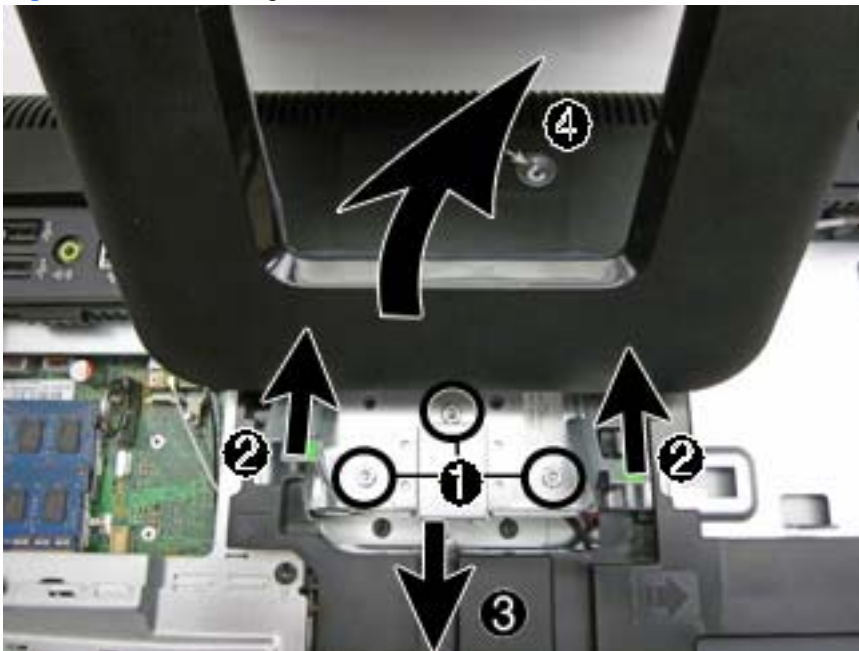

To replace the stand, reverse the removal procedures.

## Rear Cover

The rear cover is secured with four Torx screws. The optical drive security screw also secures the rear cover. After removing the screws, you must pry it off at the seams around the edges of the computer.

To remove the rear cover:

1. Prepare the computer for disassembly (see [Preparing to Disassemble the Computer on page 26](#)).
2. Remove the center access panel (see [Hinge Cover Panel on page 27](#)).
3. Remove the memory access panel (see [Memory Access Panel on page 29](#)).
4. Remove the drive access panel (see [Drive Access Panel on page 31](#)).
5. Remove the stand (see [Stand on page 54](#)).
6. Remove the optical drive (see [Optical Drive on page 33](#)).
7. Remove the top panel (see [Top Panel on page 51](#)).
8. Remove the five black Torx screws that secure the rear panel to the computer (1).
9. Pry the cover off the computer by pulling the top edge (2) loose, then prying the side loose near the memory modules (3), bottom side (4), and left side (5).

---

 **NOTE:** The cover may be very tight and difficult to remove.

---

**Figure 6-42** Removing the rear cover

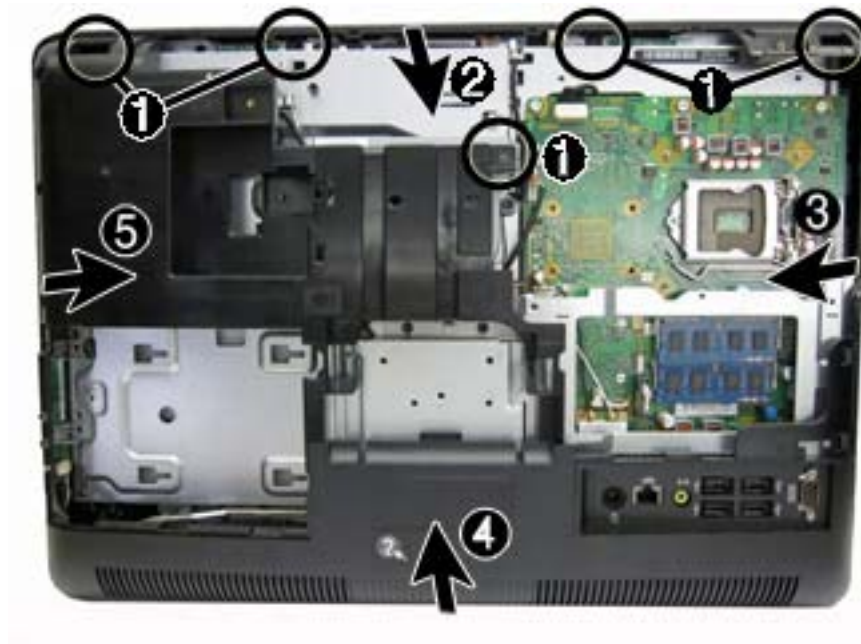

10. Remove the rear cover from the computer.

To replace the rear cover, reverse the removal procedures.

# Fan

The fan is located near the middle of the computer under the main rear cover. The fan is secured with three Torx screws. You do not have to remove the heat sink to remove the fan.

**Figure 6-43** Fan assembly location

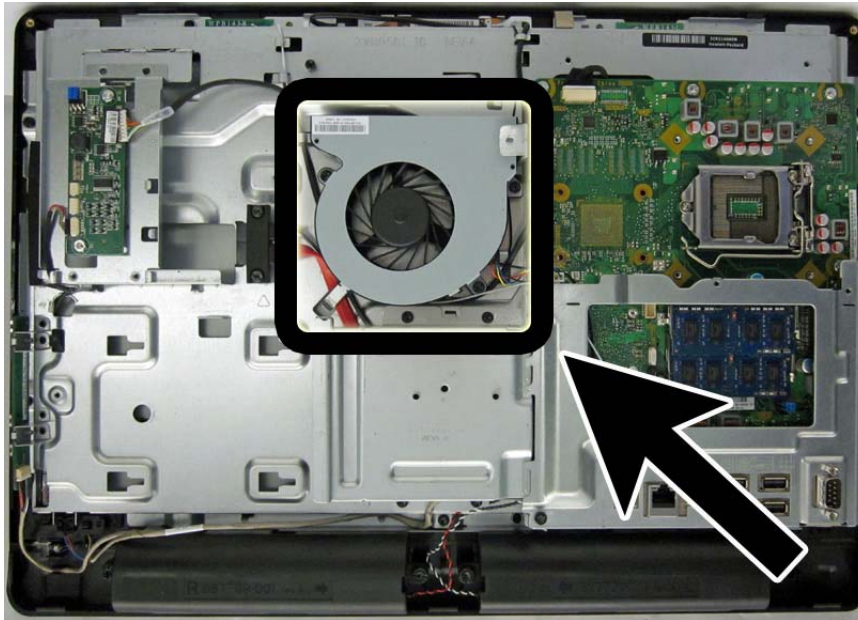

To remove the fan assembly:

1. Prepare the computer for disassembly (see [Preparing to Disassemble the Computer on page 26](#)).
2. Remove the center access panel (see [Hinge Cover Panel on page 27](#)).
3. Remove the memory access panel (see [Memory Access Panel on page 29](#)).
4. Remove the drive access panel (see [Drive Access Panel on page 31](#)).
5. Remove the stand (see [Stand on page 54](#)).
6. Remove the optical drive (see [Optical Drive on page 33](#)).
7. Remove the heat sink cover (see [Heat Sink Cover on page 45](#)).
8. Remove the top panel (see [Top Panel on page 51](#)).
9. Remove the rear cover (see [Rear Cover on page 55](#)).



10. Remove the three black Torx screws that secure the fan to the computer, and then disconnect the fan cable from the system board connector labeled CHASSIS\_FAN1.

**Figure 6-44** Fan screws



11. Slide the fan toward the right to remove it from underneath the metal bracket, and then lift the fan from the computer.

**Figure 6-45** Removing the fan



To install the fan assembly, reverse the removal procedures.

## Converter Board

The converter board is located on the left side of the computer (viewed from behind) under the main rear cover. It is secured with two Torx screws and has two connectors.

**Figure 6-46** Converter board location

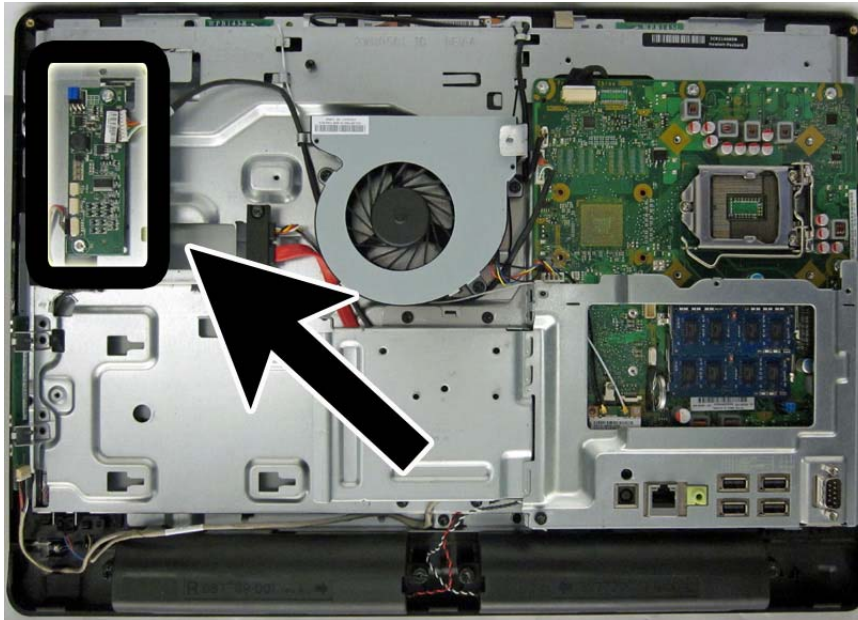

To remove the converter board:

1. Prepare the computer for disassembly (see [Preparing to Disassemble the Computer on page 26](#)).
2. Remove the center access panel (see [Hinge Cover Panel on page 27](#)).
3. Remove the memory access panel (see [Memory Access Panel on page 29](#)).
4. Remove the drive access panel (see [Drive Access Panel on page 31](#)).
5. Remove the stand (see [Stand on page 54](#)).
6. Remove the optical drive (see [Optical Drive on page 33](#)).
7. Remove the top panel (see [Top Panel on page 51](#)).
8. Remove the rear cover (see [Rear Cover on page 55](#)).
9. Disconnect the two cables from the board **(1)**.

 **NOTE:** Be careful not to damage the cables when disconnecting them from the board. Do not pull on the wires.

10. Remove the two silver Torx screws **(2)** that secure the board to the computer.

11. Lift the converter board from the computer.

**Figure 6-47** Removing the converter board

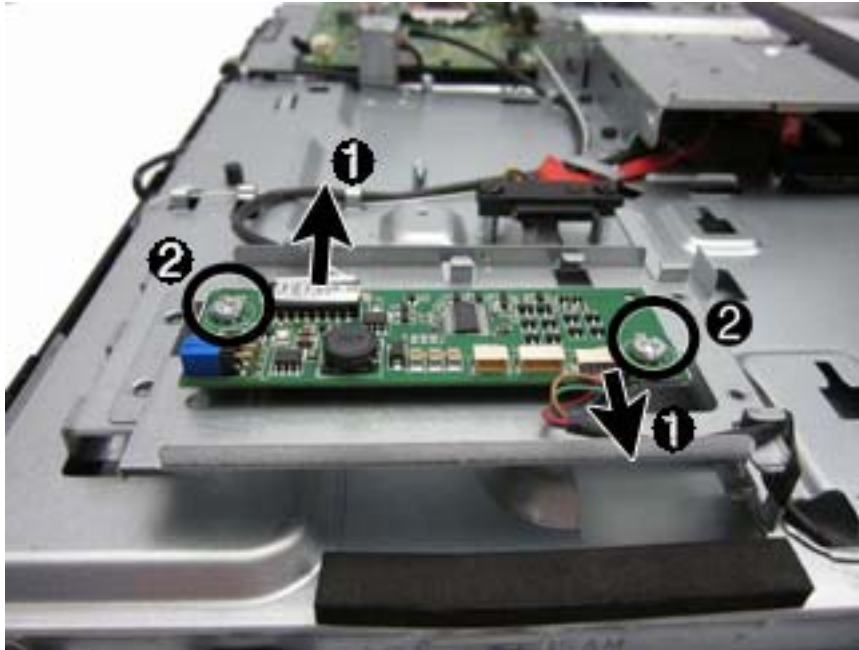

Be sure to correctly position the jumpers on the converter board for the installed display panel, as follows:

**⚠ CAUTION:** Incorrect jumper placement can result in damage to the converter board.

- LG panel: pins (1)(2) & (3)(4)
- Samsung panel: pins (3)(4) & (5)(6)
- CMI panel: pins (1)(2) & (5)(6)

**LG**

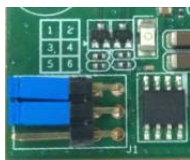

**Samsung**



**CMI**

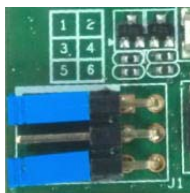

To install the converter board, reverse the removal procedures.

## Sidekey Board

The sidekey board is located on the bottom left side of the computer (viewed from behind) under the main rear cover. It is secured with two Torx screws and has one connector.

The associated cable connects to the front power switch assembly. To remove this cable, you must remove the stand bracket, disassembly of which is shown later in this document at [Stand bracket on page 68](#).

**Figure 6-48** Sidekey board location

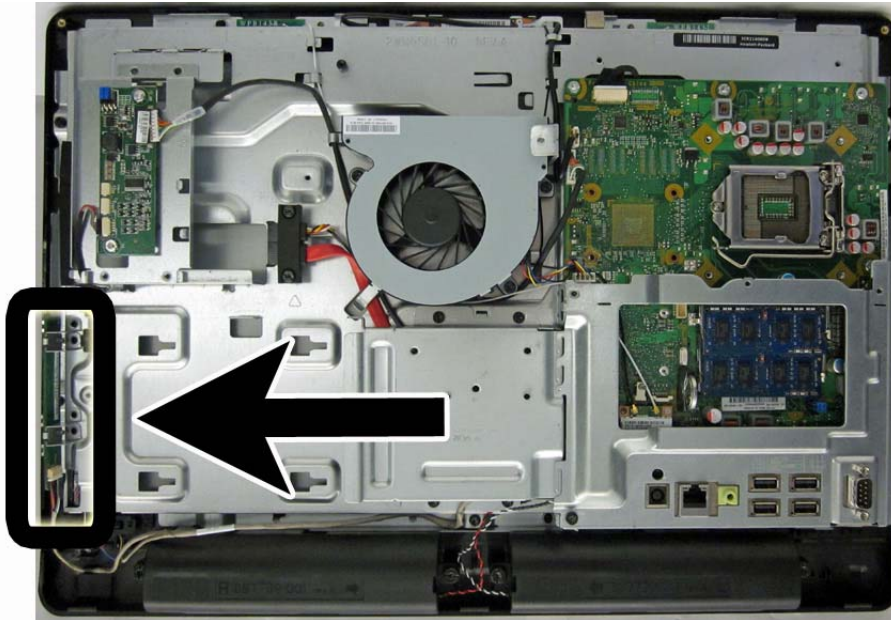

To remove the sidekey board:

1. Prepare the computer for disassembly (see [Preparing to Disassemble the Computer on page 26](#)).
2. Remove the center access panel (see [Hinge Cover Panel on page 27](#)).
3. Remove the memory access panel (see [Memory Access Panel on page 29](#)).
4. Remove the drive access panel (see [Drive Access Panel on page 31](#)).
5. Remove the stand (see [Stand on page 54](#)).
6. Remove the optical drive (see [Optical Drive on page 33](#)).
7. Remove the top panel (see [Top Panel on page 51](#)).
8. Remove the rear cover (see [Rear Cover on page 55](#)).

9. Disconnect the cable from the sidekey board.

 **NOTE:** Be careful not to damage the cable when disconnecting it from the board. Do not pull on the wires.

**Figure 6-49** Disconnecting the sidekey board cable



10. Remove the two silver Torx screws that secure the board to the computer.

**Figure 6-50** Sidekey board screws



11. Rotate the bottom of the board upward, and then remove the board from the computer.

**Figure 6-51** Removing the sidekey board



To install the sidekey board, reverse the removal procedures.

## System Board Shield

The system board shield covers the bottom of the system board. It is secured with two Torx screws and two hex screws around the serial port.

**Figure 6-52** System board shield location

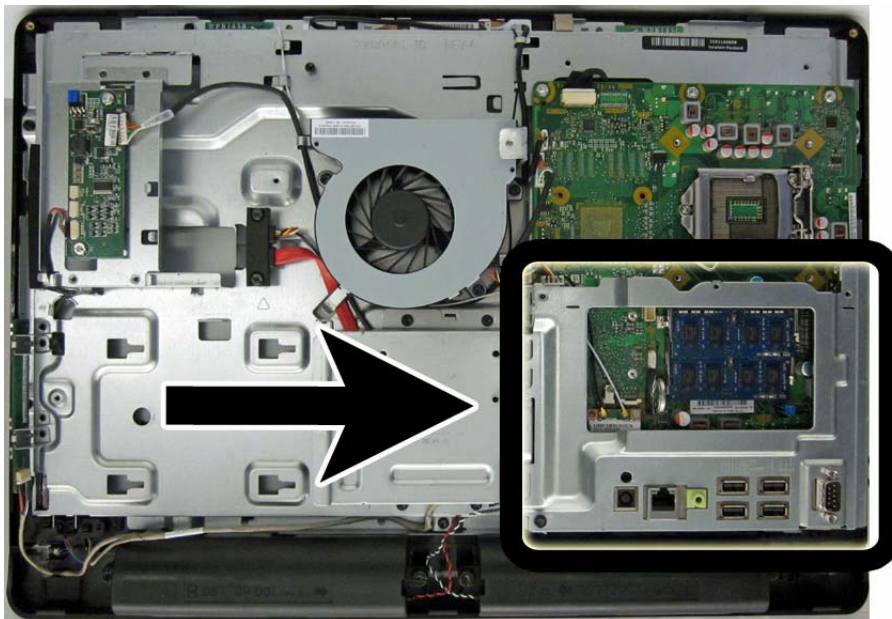

To remove the system board shield:

1. Prepare the computer for disassembly (see [Preparing to Disassemble the Computer on page 26](#)).
2. Remove the center access panel (see [Hinge Cover Panel on page 27](#)).
3. Remove the memory access panel (see [Memory Access Panel on page 29](#)).
4. Remove the drive access panel (see [Drive Access Panel on page 31](#)).
5. Remove the stand (see [Stand on page 54](#)).
6. Remove the optical drive (see [Optical Drive on page 33](#)).
7. Remove the top panel (see [Top Panel on page 51](#)).
8. Remove the heat sink cover (see [Heat Sink Cover on page 45](#)).
9. Remove the rear cover (see [Rear Cover on page 55](#)).
10. Remove the two black Torx screws (1) that secure the shield to the computer.



**NOTE:** The Torx screw in the lower left also secures the stand bracket.

11. Remove the two silver hex screws around the serial port (2).
12. Lift the shield from the computer.

**Figure 6-53** Removing the system board shield

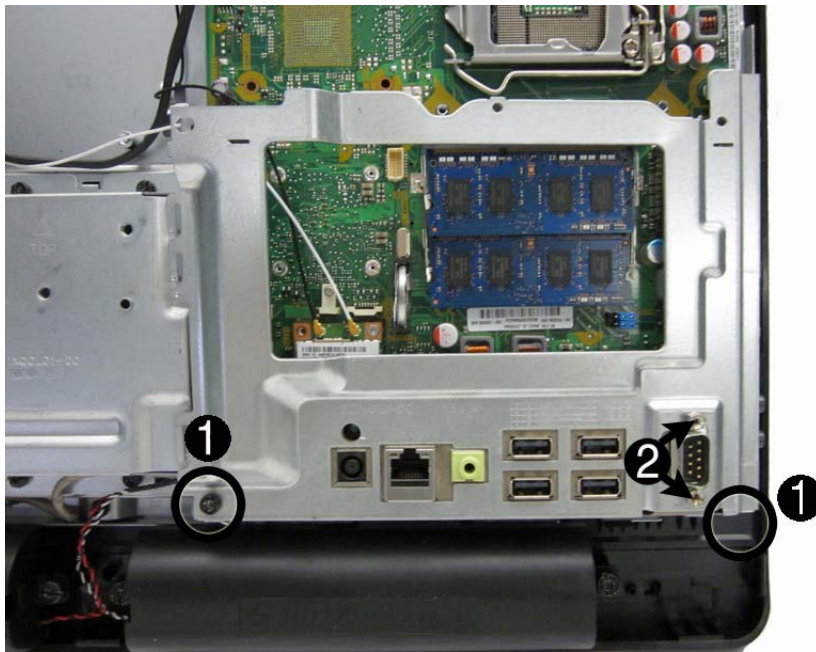

To install the system board shield, reverse the removal procedures.

## WLAN Module

The WLAN module is located on the bottom left of the system board. The module is secured with one Phillips screw and has two connected antennas.

**Figure 6-54** WLAN module location

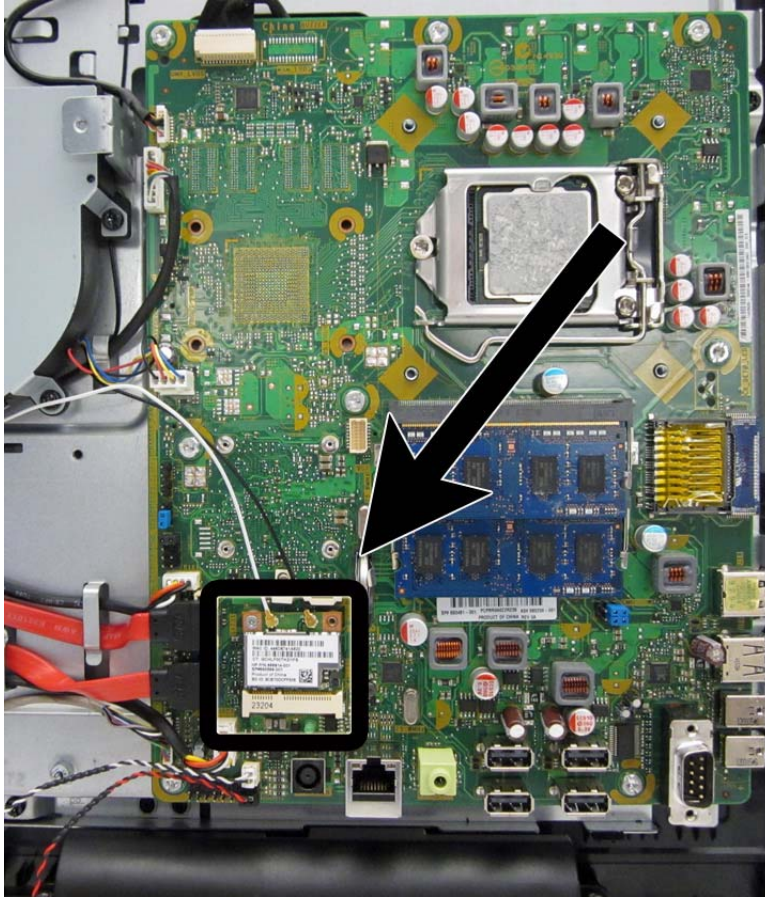

To remove the WLAN module:

1. Prepare the computer for disassembly (see [Preparing to Disassemble the Computer on page 26](#)).
2. Remove the center access panel (see [Hinge Cover Panel on page 27](#)).
3. Remove the memory access panel (see [Memory Access Panel on page 29](#)).
4. Remove the drive access panel (see [Drive Access Panel on page 31](#)).
5. Remove the stand (see [Stand on page 54](#)).
6. Remove the optical drive (see [Optical Drive on page 33](#)).
7. Remove the top panel (see [Top Panel on page 51](#)).
8. Remove the rear cover (see [Rear Cover on page 55](#)).
9. Remove the heat sink cover (see [Heat Sink Cover on page 45](#)).
10. Remove the system board shield (see [System Board Shield on page 62](#)).



11. Disconnect the antenna cables from the module (1).
12. Remove the Phillips screw (2) that secures the module to the computer.

**Figure 6-55** Removing the WLAN module screw and antennas

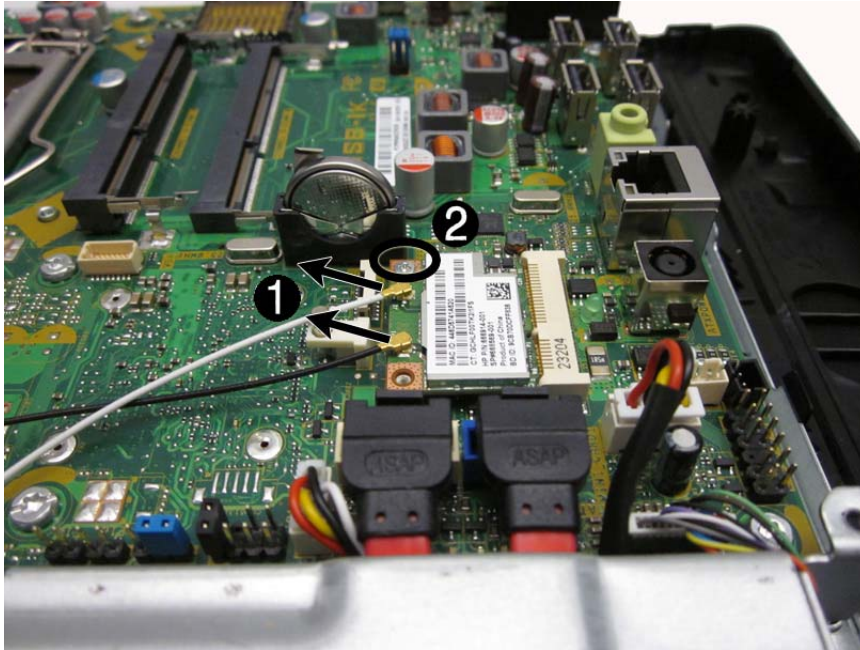

13. Lift the module to a 45-degree angle, and then pull it away to remove it from the socket.

**Figure 6-56** Removing the WLAN module



To install the WLAN module, reverse the removal procedures.

 **NOTE:** WLAN modules are designed with a notch to prevent incorrect insertion.

# Speakers

The speakers are located at the bottom of the computer. Two separate speakers are each secured by two Torx screws and have separate cables and system board connectors.

**Figure 6-57** Speaker location

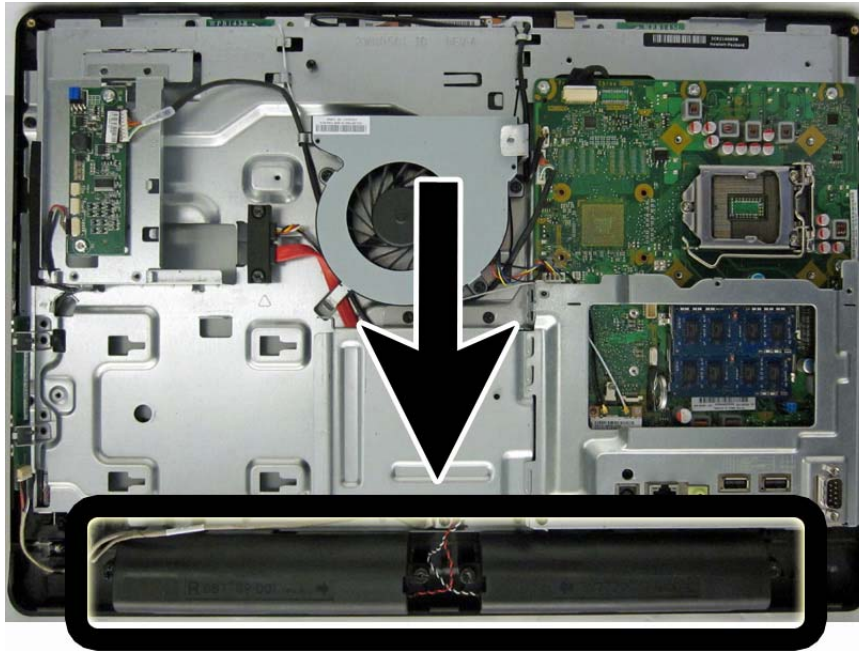

To remove the speakers:

1. Prepare the computer for disassembly (see [Preparing to Disassemble the Computer on page 26](#)).
2. Remove the center access panel (see [Hinge Cover Panel on page 27](#)).
3. Remove the memory access panel (see [Memory Access Panel on page 29](#)).
4. Remove the drive access panel (see [Drive Access Panel on page 31](#)).
5. Remove the stand (see [Stand on page 54](#)).
6. Remove the optical drive (see [Optical Drive on page 33](#)).
7. Remove the heat sink cover (see [Heat Sink Cover on page 45](#)).
8. Remove the top panel (see [Top Panel on page 51](#)).
9. Remove the rear cover (see [Rear Cover on page 55](#)).
10. Remove the system board shield (see [System Board Shield on page 62](#)).
11. Remove two Torx screws that secure each speaker to the computer.
12. Disconnect the speaker cables from the system board connectors. The left speaker connects to the white connector labeled LFT\_SPKR. The right speaker connects to the black connector labeled RT\_SPKR.

13. Remove the speakers from the computer.

**Figure 6-58** Removing the speakers



To install the speakers, reverse the removal procedures.

## Stand bracket

The stand bracket is located near the middle of the computer, below the fan. Remove the bracket to gain access to the drive cables and sidekey board cable assembly. The bracket is secured with four Torx screws.

**Figure 6-59** Stand bracket location

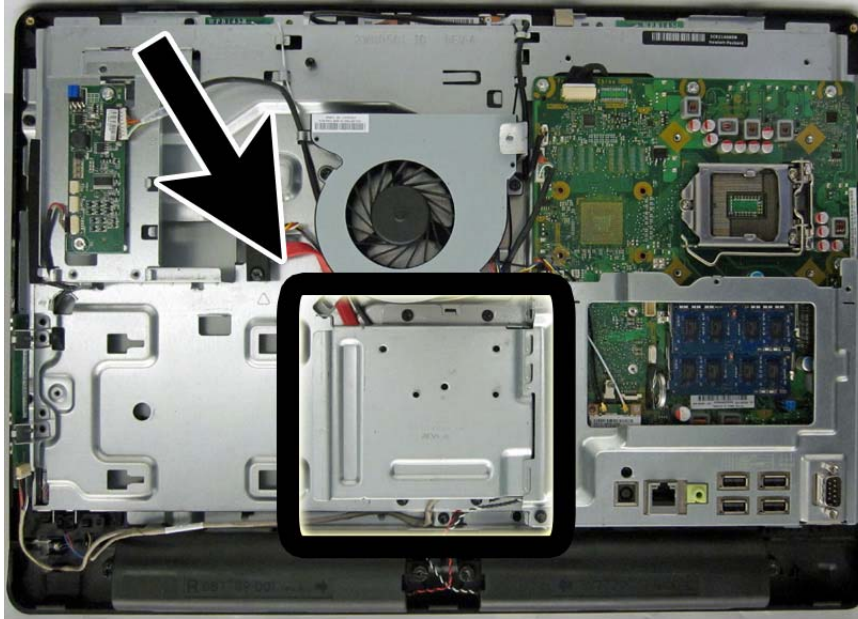

To remove the stand bracket:

1. Prepare the computer for disassembly (see [Preparing to Disassemble the Computer on page 26](#)).
2. Remove the center access panel (see [Hinge Cover Panel on page 27](#)).
3. Remove the memory access panel (see [Memory Access Panel on page 29](#)).
4. Remove the drive access panel (see [Drive Access Panel on page 31](#)).
5. Remove the stand (see [Stand on page 54](#)).
6. Remove the optical drive (see [Optical Drive on page 33](#)).
7. Remove the top panel (see [Top Panel on page 51](#)).
8. Remove the rear cover (see [Rear Cover on page 55](#)).

9. Remove the four black Torx screws that secure the stand bracket to the computer.

 **NOTE:** The bottom right corner of the stand bracket shares a screw with the system board cover. If you have not removed the system board cover prior to removing the stand bracket, you will need to remove this screw to remove the stand bracket.

**Figure 6-60** Stand bracket screw locations



10. Lift the bracket from the computer.

**Figure 6-61** Removing the stand bracket

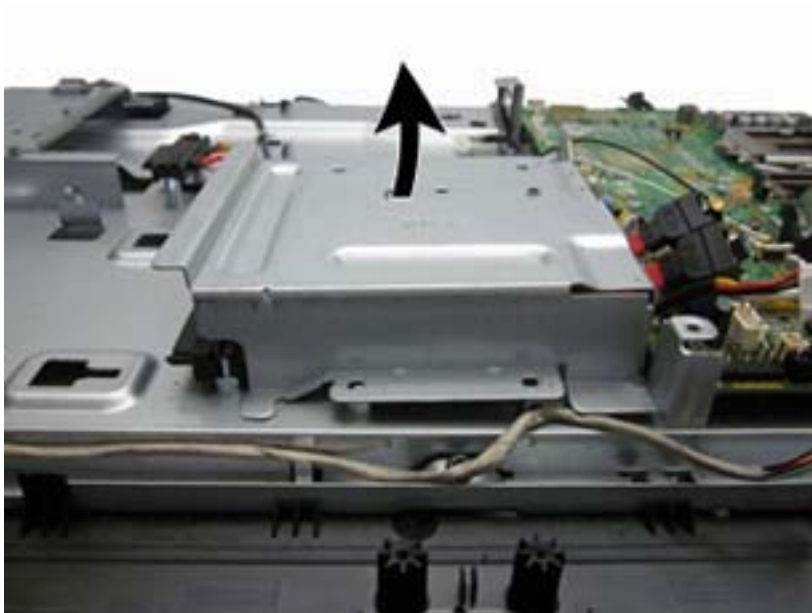

To install the stand bracket, reverse the removal procedures.

 **NOTE:** When reinstalling the stand bracket, be sure to insert the right side of the bracket *underneath* the system board cover.

# System Board

The system board is located on the right side of the computer (viewed from the rear) under the heat sink and system board covers. It is secured with eight Torx screws.

**Figure 6-62** System board location

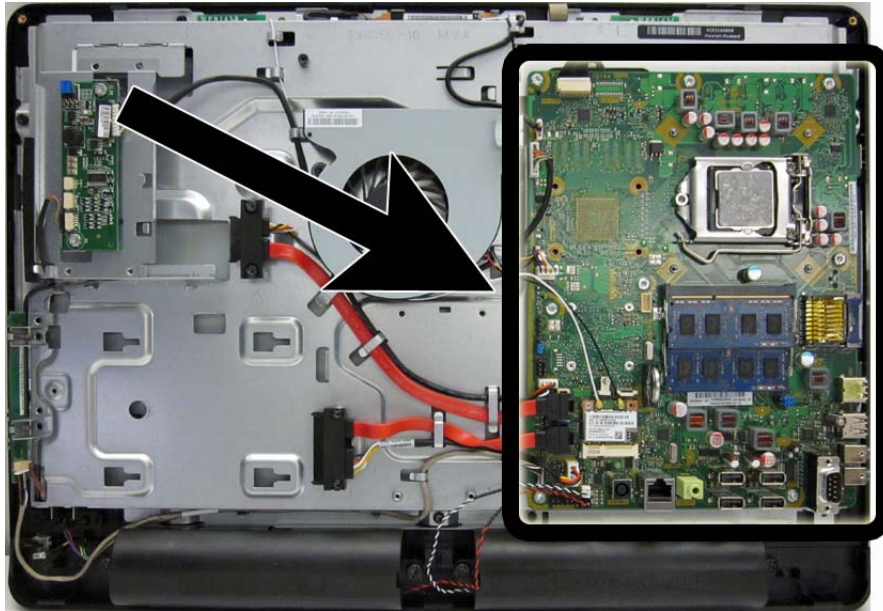

To remove the system board:

1. Prepare the computer for disassembly (see [Preparing to Disassemble the Computer on page 26](#)).
2. Remove the center access panel (see [Hinge Cover Panel on page 27](#)).
3. Remove the memory access panel (see [Memory Access Panel on page 29](#)).
4. Remove the memory modules (see [Memory on page 38](#)).
5. Remove the drive access panel (see [Drive Access Panel on page 31](#)).
6. Remove the stand (see [Stand on page 54](#)).
7. Remove the optical drive (see [Optical Drive on page 33](#)).
8. Remove the heat sink cover (see [Heat Sink Cover on page 45](#)).
9. Remove the thermal module/heat sink (see [Heat Sink \(Thermal Module\) on page 47](#)).
10. Remove the top panel (see [Top Panel on page 51](#)).
11. Remove the rear cover (see [Rear Cover on page 55](#)).
12. Remove the system board cover (see [System Board Shield on page 62](#)).
13. Remove the WLAN module (see [WLAN Module on page 64](#)).
14. Remove the processor (see [Processor on page 49](#)).
15. Disconnect all cables from the system board, noting their location for reinstallation.

16. Remove the eight silver Torx screws (circled in image) that secure the system board to the computer.

**Figure 6-63** System board screw locations



17. Lift the system board straight up and out of the computer.

---

 **NOTE:** The thermal material on the bottom of the system board may cause it to stick to the computer.

---

 **NOTE:** Before returning the defective system board, remove the CPU cover from the replacement system board and install it on the defective system board.

---

To install the system board, reverse the removal procedures.

### Updating SMBIOS Information

When replacing the system board, you must reprogram the SMBIOS information on the affected computer. Failure to reprogram the board will result in eventual failure, such as an activation failure (need to reactivate the system) or a system recovery failure.

To update SMBIOS information in Computer Setup:

1. Turn on or restart the computer.
2. Press **Esc** while the “Press the ESC key for Startup Menu” message is displayed at the bottom of the screen.

---

 **NOTE:** If you do not press **Esc** at the appropriate time, you must restart the computer and again press **Esc** when the monitor light turns green to access the utility.

---

3. Press **F10** to enter Computer Setup.
4. Go to **Security > System ID's**.
5. If necessary, press **Ctrl+A** to initiate edit mode.
6. Edit the fields listed. If the feature byte has data or is not editable, then it was not cleared and cannot be edited.

### System ID Setup Page

Setup Field Name	Comment	Label
Product Name	Enter the Model name/number or marketing name.	Flexbuild
Serial Number	Enter the Serial Number of Unit.	Support
SKU Number	Enter the SKU or Product Number including Localization Code.	Support
Asset Tag	Enter the 18-byte identifier assigned to the computer.	Support
Feature Byte	<p>Enter the Feature Byte string. The feature byte string is case dependent.</p> <p>The label includes spaces after every four characters. You can enter or ignore these spaces – their only purpose is to help with data entry. There is a character limitation of 40 bytes per line. When you reach this limit, go to the next line to continue data entry. BIOS ignores the spaces and lines.</p> <p>If you make an error during data entry, the data will not validate, and the computer asks you to correct your data input.</p>	Flexbuild
Build ID	The Build ID of the unit.	Flexbuild



# Hard Drive and Optical Drive Cables and Connectors

The hard drive and optical drive connectors are located near the middle of the computer, partially under the bracket that secures the stand. Each connector is secured with two Torx screws and has two cables that connect to the system board.

The optical drive connector cables are longer than the hard drive connector cables.

**Figure 6-64** Hard drive cable and optical drive cable location

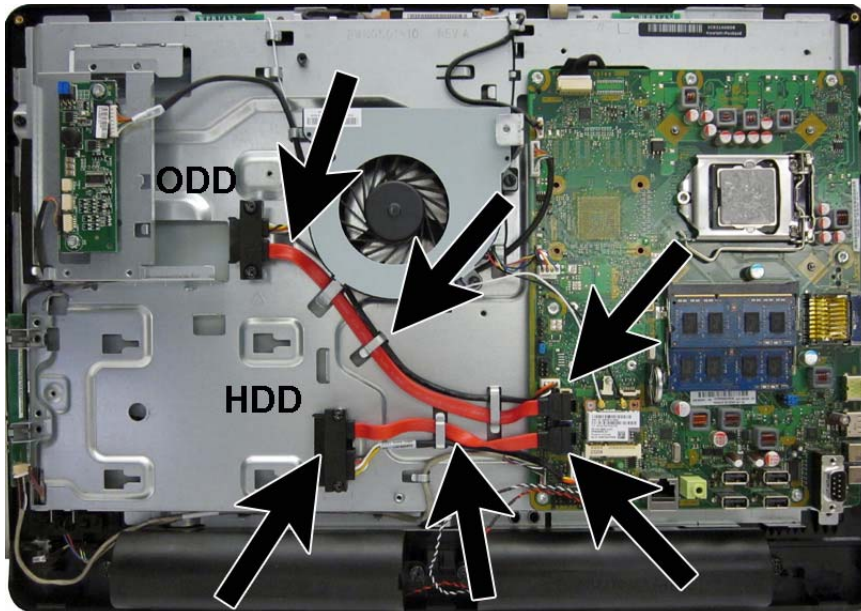

To remove the hard drive or optical drive connector:

1. Prepare the computer for disassembly (see [Preparing to Disassemble the Computer on page 26](#)).
2. Remove the center access panel (see [Hinge Cover Panel on page 27](#)).
3. Remove the memory access panel (see [Memory Access Panel on page 29](#)).
4. Remove the drive access panel (see [Drive Access Panel on page 31](#)).
5. Remove the stand (see [Stand on page 54](#)).
6. Remove the hard drive (see [Hard Drive on page 35](#)).
7. Remove the optical drive (see [Optical Drive on page 33](#)).
8. Remove the top panel (see [Top Panel on page 51](#)).
9. Remove the rear cover (see [Rear Cover on page 55](#)).
10. Remove the system board cover (see [Heat Sink Cover on page 45](#)).
11. Remove the stand bracket (see [Stand bracket on page 68](#)).
12. Remove two Torx screws that secure the hard drive connector **(1)** or the optical drive connector **(2)** to the computer.
13. Remove the cables from the metal clips **(3)** built into the computer.

14. Disconnect the hard drive cables (4) or the optical drive cables (5) from the system board.



**NOTE:** Be careful not to damage the cable when disconnecting it from the board. Do not pull on the wires.

15. Remove the connector from the computer.

**Figure 6-65** Removing the hard drive or optical drive connectors

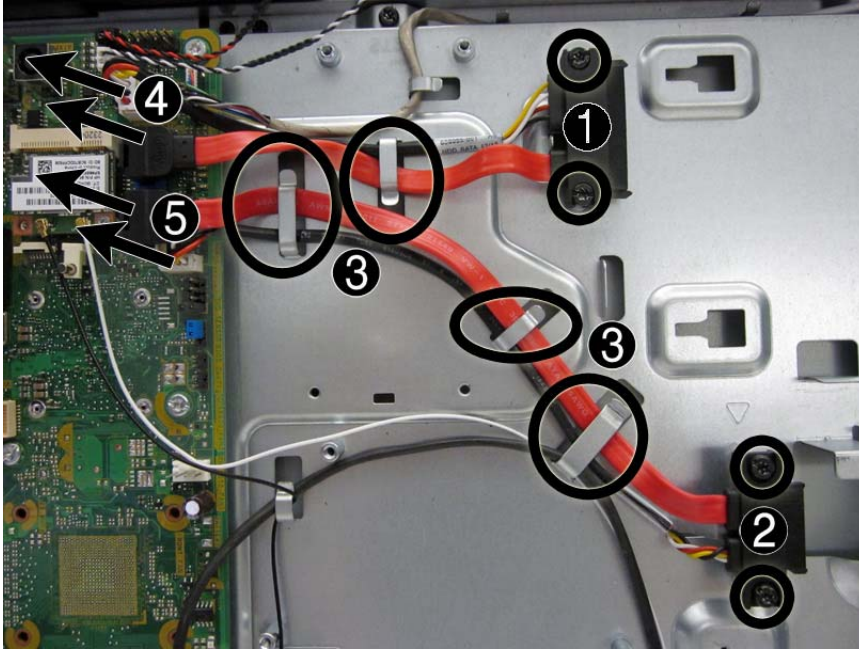

To install the hard drive or optical drive connector, reverse the removal procedures.

# Display Cable

The main display cable connector is located behind the system board. You must remove the system board to remove the display cable.

**Figure 6-66** Display cable location

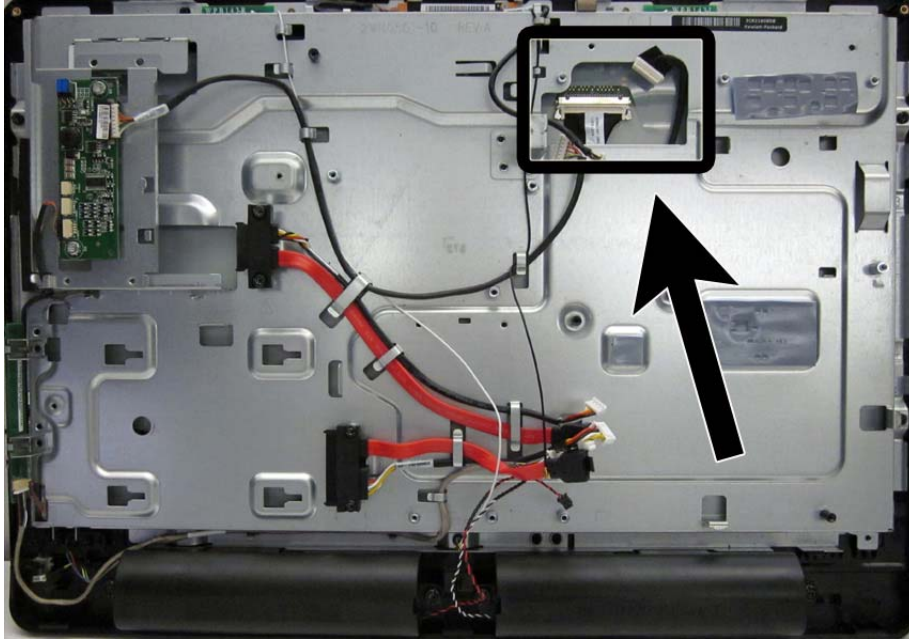

To remove the display cable:

1. Prepare the computer for disassembly (see [Preparing to Disassemble the Computer on page 26](#)).
2. Remove the center access panel (see [Hinge Cover Panel on page 27](#)).
3. Remove the memory access panel (see [Memory Access Panel on page 29](#)).
4. Remove the drive access panel (see [Drive Access Panel on page 31](#)).
5. Remove the stand (see [Stand on page 54](#)).
6. Remove the optical drive (see [Optical Drive on page 33](#)).
7. Remove the heat sink cover (see [Heat Sink Cover on page 45](#)).
8. Remove the heat sink (see [Heat Sink \(Thermal Module\) on page 47](#)).
9. Remove the top panel (see [Top Panel on page 51](#)).
10. Remove the rear cover (see [Rear Cover on page 55](#)).
11. Remove the system board shield (see [System Board Shield on page 62](#)).
12. Remove the system board (see [System Board on page 70](#)).

13. Disconnect the cable from the display panel by pressing in the latches on the side of the cable (1) and pulling it from the connector (2).

**Figure 6-67** Removing the display cable

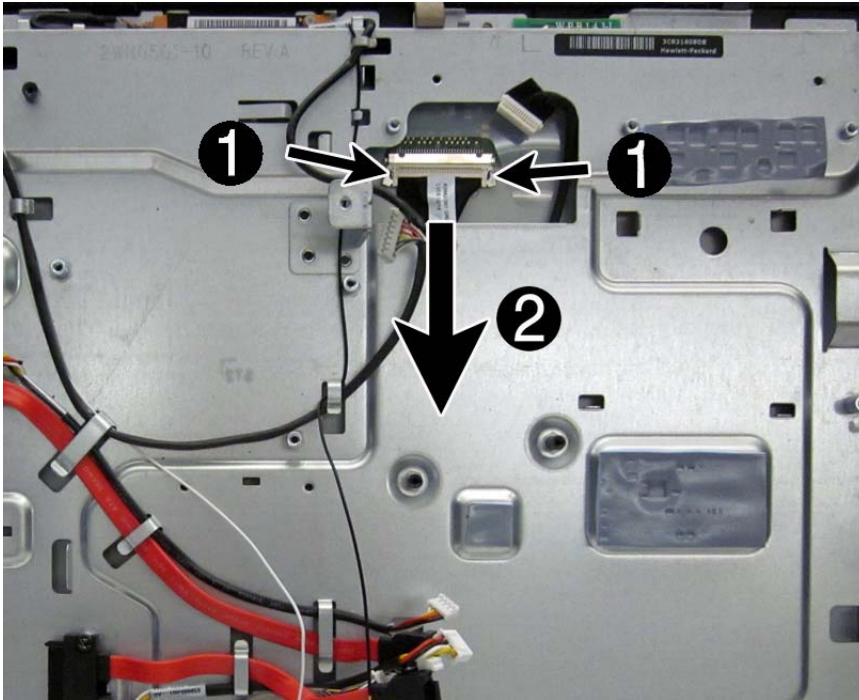

To install the display cable, reverse the removal procedures.

# Front Bezel

The front bezel is located on the front of the computer and is secured to the main system bracket with five Torx screws and nine tabs.

You can remove the front bezel without disassembling many of the computer's components. Most components can remain attached to the base pan. The following procedure demonstrates removing the bezel while removing the smallest number of components possible.

To remove the front bezel:

1. Prepare the computer for disassembly (see [Preparing to Disassemble the Computer on page 26](#)).
2. Remove the center access panel (see [Hinge Cover Panel on page 27](#)).
3. Remove the memory access panel (see [Memory Access Panel on page 29](#)).
4. Remove the drive access panel (see [Drive Access Panel on page 31](#)).
5. Remove the top panel (see [Top Panel on page 51](#)).
6. Remove the rear cover (see [Rear Cover on page 55](#)).
7. Remove the speakers (see [Speakers on page 66](#)).
8. Remove the power switch assembly cable from the front bezel. You do not have to remove the remaining cables.
9. Remove the five black Torx screws that secure the bezel to the main system bracket assembly.
10. Lift the nine tabs (see arrows in image) that secure the bezel to the main system bracket assembly. Be sure to slide the bracket free from the tabs as you lift each one.

11. Lift the main system bracket assembly off the front bezel.

**Figure 6-68** Removing the front bezel assembly from the computer

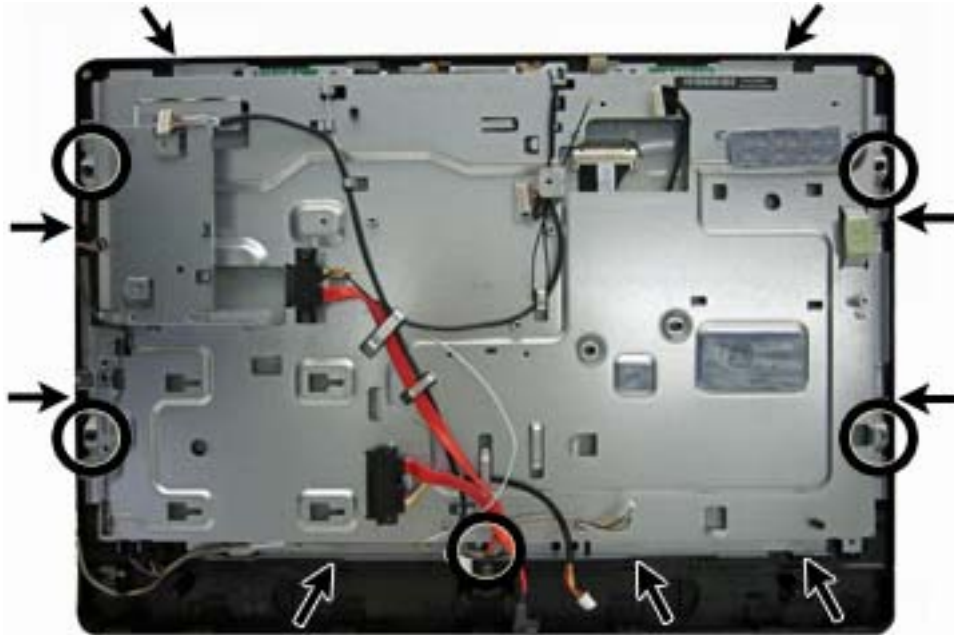

12. Lift the main display panel assembly from the front bezel.

To install the front bezel, reverse the removal procedures.

## Display Panel

If you disconnect the display cable from the display panel, you do not have to remove the system board to replace the display panel.

Three different display panels are available – LG, Samsung, and CMI.

Display panels require a backlight cable specific to the manufacturer. Make sure you use the backlight cable packaged with the display panel.

The display panel is secured to the base pan with four Torx screws, as follows:

- CMI - two screws on top, two screws on the bottom
- LG and Samsung - two screws on each side but in different locations

To remove the display panel:

1. Prepare the computer for disassembly (see [Preparing to Disassemble the Computer on page 26](#)).
2. Remove the center access panel (see [Hinge Cover Panel on page 27](#)).
3. Remove the memory access panel (see [Memory Access Panel on page 29](#)).
4. Remove the drive access panel (see [Drive Access Panel on page 31](#)).
5. Remove the stand (see [Stand on page 54](#)).

6. Remove the top panel (see [Top Panel on page 51](#)).
7. Remove the rear cover (see [Rear Cover on page 55](#)).
8. Remove the power switch assembly from the front bezel (see [Power Switch Assembly on page 82](#)).

 **NOTE:** After you remove the power switch assembly with LED and cable from the front bezel, you do not have to remove the side key cable.

9. Remove the front bezel (see [Front Bezel on page 77](#)).
10. Disconnect the display cable from the display panel (1).

 **NOTE:** Replace the backlight cable (2) with the new backlight cable that comes with the new display panel kit.

Remove the backlight cable from the defective panel before sending the panel back to the supplier.

**Figure 6-69** Removing the display cable from the display panel

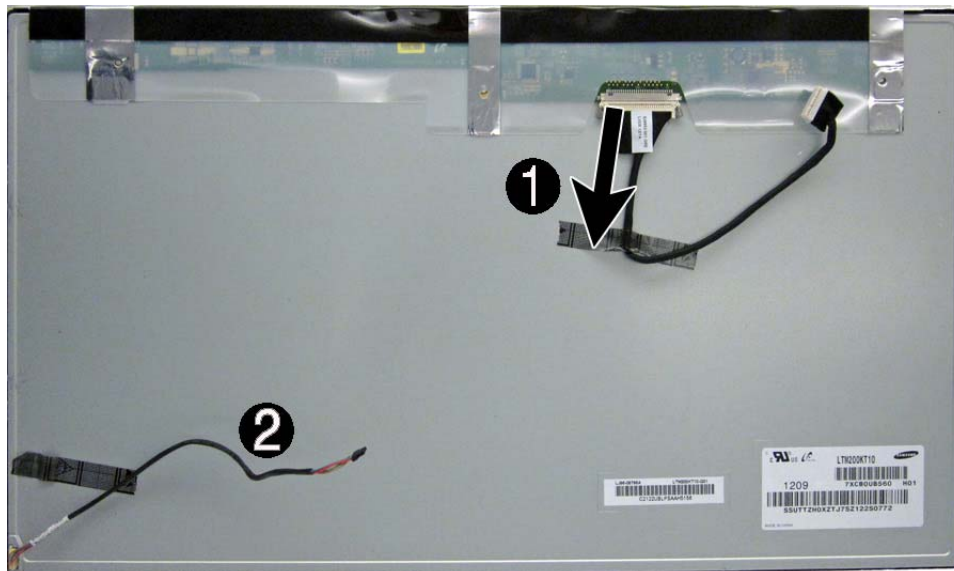

11. Remove the four silver Torx screws that secure the display panel to the frame. The screw locations for each manufacturer are stamped into the metal.

The LG (1) and Samsung (2) panels are secured with two screws on each side (left and right).

**Figure 6-70** Display panel screw locations – LG or Samsung panels

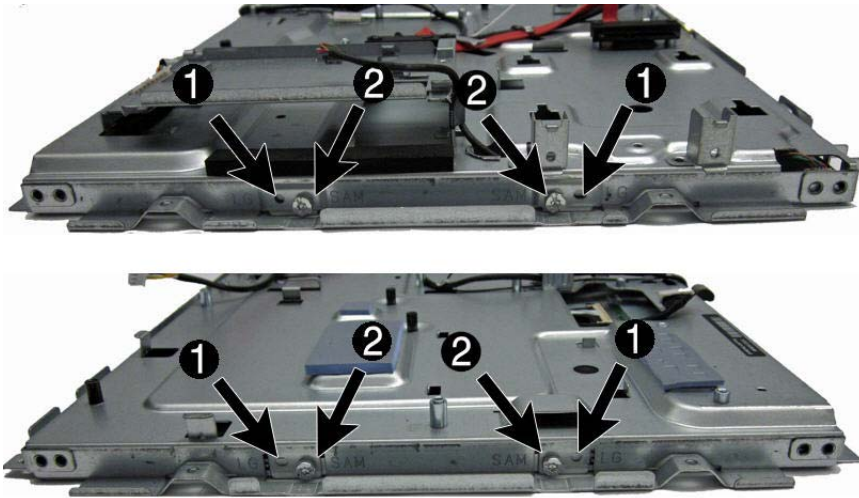

The CMI panel is secured with two screws on top, two screws on the bottom.

**Figure 6-71** Display panel screw locations – CMI panel

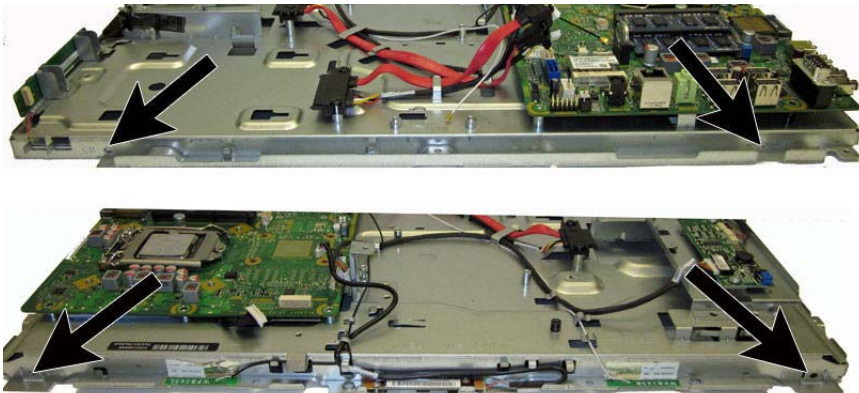

12. Lift the display panel from the frame.
13. Be sure to correctly position the jumpers on the converter board for the installed display panel, as follows:

**CAUTION:** Incorrect jumper placement can result in damage to the converter board and LCD panel.

- LG panel: pins (1)(2) & (3)(4)
- Samsung panel: pins (3)(4) & (5)(6)
- CMI panel: pins (1)(2) & (5)(6)



---

**LG**

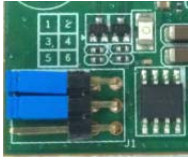

---

**Samsung**

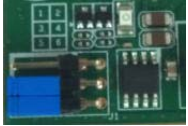

---

**CMI**

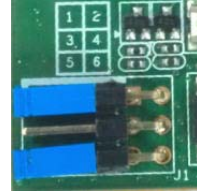

---

To install a display panel, reverse the removal procedures.

## Power Switch Assembly

The power switch assembly is located on the bottom corner of the inside of the front bezel. You must remove the front bezel from the computer to remove the power switch assembly from the bezel.

**Figure 6-72** Power switch assembly location

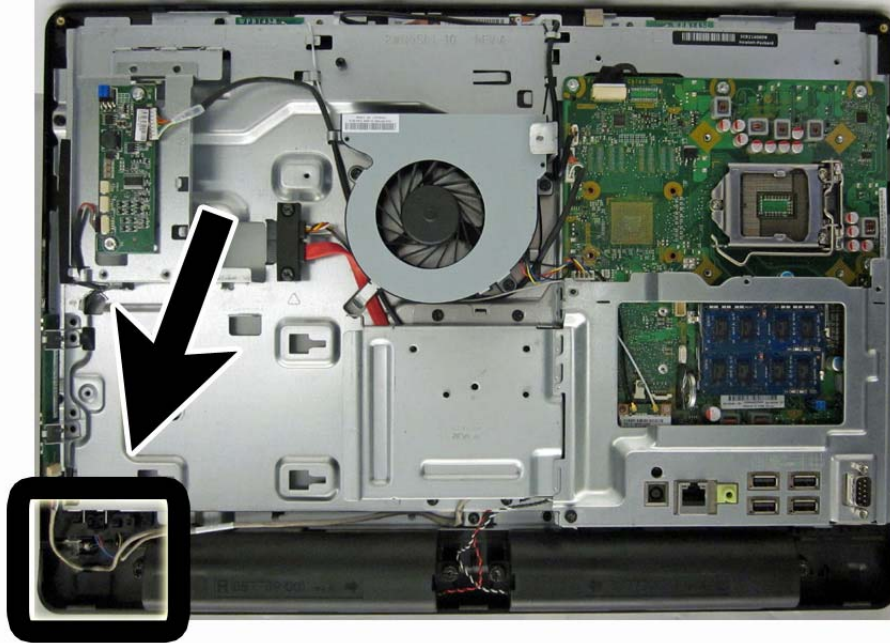

To remove the power switch assembly:

1. Prepare the computer for disassembly (see [Preparing to Disassemble the Computer on page 26](#)).
2. Remove the center access panel (see [Hinge Cover Panel on page 27](#)).
3. Remove the memory access panel (see [Memory Access Panel on page 29](#)).
4. Remove the drive access panel (see [Drive Access Panel on page 31](#)).
5. Remove the stand (see [Stand on page 54](#)).
6. Remove the optical drive (see [Optical Drive on page 33](#)).
7. Remove the top panel (see [Top Panel on page 51](#)).
8. Remove the rear cover (see [Rear Cover on page 55](#)).
9. Remove the front bezel (see [Front Bezel on page 77](#)).
10. Pull the two tabs **(1)** toward the bottom of the bezel, and then rotate the assembly up and off the bezel **(2)**.
11. Pull the light pipe out of its slot **(3)**.

12. Remove the cable from the clip built into the bezel (4), and then remove the power switch assembly from the front bezel.

**Figure 6-73** Removing the power switch assembly



To install the power switch assembly, reverse the removal procedures.

---

# 7 Troubleshooting Without Diagnostics

This chapter provides information on how to identify and correct minor problems, such as diskette drive, hard drive, optical drive, graphics, audio, memory, and software problems. If you encounter problems with the computer, refer to the tables in this chapter for probable causes and recommended solutions.

---

 **NOTE:** For information on specific error messages that may appear on the screen during Power-On Self-Test (POST) at startup, refer to Appendix A, [POST Error Messages on page 113](#).

---

## Safety and Comfort

 **WARNING!** Misuse of the computer or failure to establish a safe and comfortable work environment may result in discomfort or serious injury. Refer to the *Safety & Comfort Guide* at <http://www.hp.com/ergo> for more information on choosing a workspace and creating a safe and comfortable work environment. For more information, refer to the *Safety & Regulatory Information* guide.

---

# Solving General Problems

You may be able to easily resolve the general problems described in this section. If a problem persists and you are unable to resolve it yourself or if you feel uncomfortable about performing the operation, contact an authorized dealer or reseller.

**⚠ WARNING!** When the computer is plugged into an AC power source, voltage is always applied to the system board. To reduce the risk of personal injury from electrical shock and/or hot surfaces, be sure to disconnect the power cord from the wall outlet and allow the internal system components to cool before touching.

**Table 7-1 Solving General Problems**

Cause	Solution
<b>Computer appears locked up and will not turn off when the power button is pressed.</b>	
Software control of the power switch is not functional.	<ol style="list-style-type: none"><li>1. Press and hold the power button for at least four seconds until the computer turns off.</li><li>2. Disconnect the power cord from the electrical outlet.</li></ol>
<b>Computer will not respond to USB keyboard or mouse.</b>	
Computer is in <b>standby</b> mode.	To resume from <b>standby</b> mode, press the power button or press any key.  <b>CAUTION:</b> When attempting to resume from <b>standby</b> mode, do not hold down the power button for more than four seconds. Otherwise, the computer will shut down and you will lose any unsaved data.
System has locked up.	Restart computer.
<b>Computer date and time display is incorrect.</b>	
RTC (real-time clock) battery may need to be replaced.  <b>NOTE:</b> Connecting the computer to a live AC outlet prolongs the life of the RTC battery.	First, reset the date and time under <b>Control Panel</b> (Computer Setup can also be used to update the RTC date and time). If the problem persists, replace the RTC battery. See the Removal and Replacement section for instructions on installing a new battery, or contact an authorized dealer or reseller for RTC battery replacement.
<b>Cursor will not move using the <b>arrow</b> keys on the keypad.</b>	
The <b>Num Lock</b> key may be on.	Press the <b>Num Lock</b> key. The Num Lock light should not be on if you want to use the <b>arrow</b> keys. The <b>Num Lock</b> key can be disabled (or enabled) in Computer Setup.

**There is no sound or sound volume is too low.**

<b>Cause</b>	<b>Solution</b>
System volume may be set low or muted.	<ol style="list-style-type: none"><li>1. Check the F10 BIOS settings to make sure the internal system speaker is not muted (this setting does not affect the external speakers).</li><li>2. Make sure the external speakers are properly connected and powered on and that the speakers' volume control is set correctly.</li><li>3. Use the system volume control available in the operating system to make sure the speakers are not muted or to increase the volume.</li></ol>

**Poor performance is experienced.**

<b>Cause</b>	<b>Solution</b>
Processor is hot.	<ol style="list-style-type: none"><li>1. Make sure airflow to the computer is not blocked. Leave a 10.2-cm (4-inch) clearance on all vented sides of the computer and above the monitor to permit the required airflow.</li><li>2. Make sure fans are connected and working properly (some fans only operate when needed).</li><li>3. Make sure the processor heat sink is installed properly.</li></ol>
Hard drive is full.	Transfer data from the hard drive to create more space on the hard drive.
Low on memory.	Add more memory.
Hard drive fragmented.	Defragment hard drive.
Program previously accessed did not release reserved memory back to the system.	Restart the computer.
Virus resident on the hard drive.	Run virus protection program.
Too many applications running.	<ol style="list-style-type: none"><li>1. Close unnecessary applications to free up memory.</li><li>2. Add more memory. Some applications run in the background and can be closed by right-clicking on their corresponding icons in the task tray. To prevent these applications from launching at startup, go to <b>Start &gt; All Programs &gt; Accessories &gt; Run</b> and type <code>msconfig</code>. On the <b>Startup</b> tab of the System Configuration Utility, clear applications that you do not want to launch automatically.</li></ol>
Some software applications, especially games, are stressful on the graphics subsystem	<ol style="list-style-type: none"><li>1. Lower the display resolution for the current application or consult the documentation that came with the application for suggestions on how to improve performance by adjusting parameters in the application.</li><li>2. Add more memory.</li><li>3. Upgrade the graphics solution.</li></ol>
Cause unknown.	Restart the computer.

**Computer powered off automatically and the Power LED flashes Red two times, once every second, followed by a two second pause, and the computer beeps two times. (Beeps stop after fifth iteration but LEDs continue flashing).**

Cause	Solution
Processor thermal protection activated: A fan may be blocked or not turning. OR The heat sink is not properly attached to the processor.	<ol style="list-style-type: none"><li>1. Ensure that the computer air vents are not blocked and the processor cooling fan is running.</li><li>2. Open hood, press power button, and see if the processor fan spins. If the processor fan is not spinning, make sure the fan's cable is plugged onto the system board header.</li><li>3. If fan is plugged in, but is not spinning, then replace the heat sink/fan assembly.</li></ol>

**System does not power on and the LEDs on the front of the computer are not flashing.**

Cause	Solution
System unable to power on.	<p>Press and hold the power button for less than 4 seconds. If the hard drive LED turns green, then:</p> <ol style="list-style-type: none"><li>1. Check that the voltage selector, located on the rear of the power supply on some models, is set to the appropriate voltage. Proper voltage setting depends on your region.</li><li>2. Replace the system board.</li></ol> <p>OR</p> <p>Press and hold the power button for less than 4 seconds. If the hard drive LED does not turn on green then:</p> <ol style="list-style-type: none"><li>1. Check that the unit is plugged into a working AC outlet.</li><li>2. Open computer and check that the power button board cable is properly connected to the system board.</li><li>3. Check that power supply cables are properly connected to the system board.</li><li>4. Check to see if the 5V_aux light on the system board is turned on. If it is turned on, then replace the power button board.</li><li>5. If the 5V_aux light on the system board is off, then replace the power supply.</li><li>6. Replace the system board.</li></ol>

# Solving Power Problems

Common causes and solutions for power problems are listed in the following table.

**Table 7-2 Solving Power Problems**

**Computer powered off automatically and the Power LED flashes red two times, once every second, followed by a two second pause, and the computer beeps two times. (Beeps stop after fifth iteration but LEDs continue flashing.)**

Cause	Solution
Processor thermal protection activated: A fan may be blocked or not turning. OR The heat sink is not properly attached to the processor.	<ol style="list-style-type: none"><li>1. Ensure that the computer air vents are not blocked and the processor cooling fan is running.</li><li>2. Open hood, press power button, and see if the processor fan spins. If the processor fan is not spinning, make sure the fan's cable is plugged onto the system board header.</li><li>3. If fan is plugged in, but is not spinning, then replace the heat sink/fan assembly.</li></ol>

**Power LED flashes red four times, once every second, followed by a two second pause, and the computer beeps four times. (Beeps stop after fifth iteration but LEDs continue flashing.)**

Cause	Solution
Power failure (power supply is overloaded).	<ol style="list-style-type: none"><li>1. Check if a device is causing the problem by removing ALL attached devices (such as hard, diskette, or optical drives, and expansion cards). Power on the system. If the system enters the POST, then power off and replace one device at a time and repeat this procedure until failure occurs. Replace the device that is causing the failure. Continue adding devices one at a time to ensure all devices are functioning properly.</li><li>2. Replace the power supply.</li><li>3. Replace the system board.</li></ol>

# Solving Hard Drive Problems

**Table 7-3 Solving Hard Drive Problems**

**Hard drive error occurs.**

Cause	Solution
Hard disk has bad sectors or has failed.	<ol style="list-style-type: none"><li>1. Right-click <b>Start</b>, click <b>Explore</b>, and right-click on a drive. Select <b>Properties</b> then select the <b>Tools</b> tab. Under <b>Error-checking</b> click <b>Check Now</b>.</li><li>2. Use a utility to locate and block usage of bad sectors. If necessary, reformat the hard disk.</li></ol>



### Disk transaction problem.

Cause	Solution
Either the directory structure is bad or there is a problem with a file.	Right-click <b>Start</b> , click <b>Explore</b> , and right-click on a drive. Select <b>Properties</b> then select the <b>Tools</b> tab. Under <b>Error-checking</b> click <b>Check Now</b> .

### Drive not found (identified).

Cause	Solution
Cable could be loose.	Check cable connections.
The system may not have automatically recognized a newly installed device.	See reconfiguration directions in the <a href="#">Solving Hardware Installation Problems on page 101</a> section. If the system still does not recognize the new device, check to see if the device is listed within Computer Setup. If it is listed, the probable cause is a driver problem. If it is not listed, the probable cause is a hardware problem.  If this is a newly installed drive, run the Computer Setup utility and try adding a POST delay under <b>Advanced &gt; Power-On</b> .
The device is attached to a SATA port that has been hidden in Computer Setup.	Run the Computer Setup utility and ensure <b>Device Available</b> is selected for the device's SATA port in <b>Security &gt; Device Security</b> .
Drive responds slowly immediately after power-up.	Run Computer Setup and increase the POST Delay in <b>Advanced &gt; Power-On Options</b> .

### Nonsystem disk/NTLDR missing message.

Cause	Solution
The system is trying to start from a diskette that is not bootable.	Remove the diskette from the diskette drive.
The system is trying to start from the hard drive but the hard drive may have been damaged.	<ol style="list-style-type: none"><li>1. Insert a bootable diskette into the diskette drive and restart the computer.</li><li>2. Check the hard drive format using fdisk: If NTFS formatting, use a third party reader to evaluate the drive. If FAT32 formatting, the hard drive cannot be accessed.</li></ol>
System files missing or not properly installed.	<ol style="list-style-type: none"><li>1. Insert a bootable diskette into the diskette drive and restart the computer.</li><li>2. Check the hard drive format using Fdisk: If NTFFS formatting, use a third party reader to evaluate the drive. If FAT32 formatting, the hard drive cannot be accessed.</li><li>3. Install system files for the appropriate operating system.</li></ol>
Hard drive boot has been disabled in Computer Setup.	Run the Computer Setup utility and enable the hard drive entry in the <b>Storage &gt; Boot Order</b> list.

**Table 7-3 Solving Hard Drive Problems (continued)**

**Nonsystem disk/NTLDR missing message.**

<b>Cause</b>	<b>Solution</b>
Bootable hard drive is not attached as first in a multi-hard drive configuration.	If attempting to boot from a hard drive, ensure it is attached to the system board dark blue SATA connector.
Bootable hard drive's controller is not listed first in the Boot Order.	Run the Computer Setup utility and select <b>Storage &gt; Boot Order</b> and ensure the bootable hard drive's controller is listed immediately under the <b>Hard Drive</b> entry.

**Computer will not boot from hard drive.**

<b>Cause</b>	<b>Solution</b>
The device is attached to a SATA port that has been hidden in Computer Setup.	Run the Computer Setup utility and ensure <b>Device Available</b> is selected for the device's SATA port in <b>Security &gt; Device Security</b> .
Boot order is not correct.	Run the Computer Setup utility and change boot sequence in <b>Storage &gt; Boot Order</b> .
Hard Drive's "Emulation Type" is set to "None."	Run the Computer Setup utility and change the "Emulation Type" to "Hard Disk" in the device's details under <b>Storage &gt; Device Configuration</b> .
Hard drive is damaged.	Observe if the front panel Power LED is blinking RED and if any beeps are heard. See Appendix A, <a href="#">POST Error Messages on page 113</a> to determine possible causes for the blinking red and beep codes.  See the Worldwide Limited Warranty for terms and conditions.

**Computer seems to be locked up.**

<b>Cause</b>	<b>Solution</b>
Program in use has stopped responding to commands.	Attempt the normal Windows "Shut Down" procedure. If this fails, press the power button for four or more seconds to turn off the power. To restart the computer, press the power button again.

**The removable hard drive is not recognized by the computer.**

<b>Cause</b>	<b>Solution</b>
The removable hard drive carrier is not fully seated in the enclosure frame or the hard drive is not fully seated in the carrier.	Push the carrier into the enclosure frame so that the connector on the rear of the frame is properly seated. If this does not solve the problem, turn off the computer, remove the carrier, and check to see if the connector on the hard drive is properly seated in the carrier.

**The removable hard drive enclosure is beeping and the green LED is flashing.**

<b>Cause</b>	<b>Solution</b>
Fan failure alarm on the removable hard drive enclosure has been activated.	Shut down the computer and contact HP for a replacement enclosure.

# Solving Media Card Reader Problems

**Table 7-4 Solving Media Card Reader Problems**

**A write-protected or locked error occurs when attempting to write to the media card.**

Cause	Solution
Media card is locked. Locking the media card is a safety feature that prevents writing to and deleting from an SD/Memory Stick/PRO card.	If using an SD card, make sure that the lock tab located on the right of the SD card is not in the locked position. If using a Memory Stick/PRO card, make sure that the lock tab located on the bottom of the Memory Stick/PRO card is not in the locked position.

**Can not write to the media card.**

Cause	Solution
The media card is a read-only memory (ROM) card.	Check the manufacturer's documentation included with your card to see if it writable. Refer to the previous section for a list of compatible cards.
Media card is locked. Locking the media card is a safety feature that prevents writing to and deleting from an SD/Memory Stick/PRO card.	If using an SD card, make sure that the lock tab located on the right of the SD card is not in the locked position. If using a Memory Stick/PRO card, make sure that the lock tab located on the bottom of the Memory Stick/PRO card is not in the locked position.

**Unable to access data on the media card after inserting it into a slot.**

Cause	Solution
The media card is not inserted properly, is inserted in the wrong slot, or is not supported.	Ensure that the card is inserted properly with the gold contact on the correct side. The green LED will light if inserted properly.

**Do not know how to remove a media card correctly.**

Cause	Solution
The computer's software is used to safely eject the card.	Open <b>Computer</b> , right-click on the corresponding drive icon, and select <b>Eject</b> . Then pull the card out of the slot.  <b>NOTE:</b> Never remove the card when the green LED is flashing

**After installing the media card reader and booting to Windows, the reader and the inserted cards are not recognized by the computer.**

Cause	Solution
The operating system needs time to recognize the device if the reader was just installed into the computer and you are turning the PC on for the first time.	Wait a few seconds so that the operating system can recognize the reader and the available ports, and then recognize whatever media is inserted in the reader.

After inserting a media card in the reader, the computer attempts to boot from the media card.

Cause	Solution
The inserted media card has boot capability.	If you do not want to boot from the media card, remove it during boot or do not select the option to boot from the inserted media card during the boot process.

## Solving Display Problems

If you encounter display problems, see the documentation that came with the monitor and to the common causes and solutions listed in the following table.

**Table 7-5 Solving Display Problems**

**Blank screen (no video).**

Cause	Solution
You may have a screen blanking utility installed or energy saver features are enabled.	Press any key or click the mouse button and, if set, type your password.
System ROM is corrupted; system is running in Boot Block Emergency Recovery Mode (indicated by eight beeps).	Reflash the system ROM with the latest BIOS image.
Computer is in <b>standby</b> mode.	Press the power button to resume from <b>standby</b> mode.  <b>CAUTION:</b> When attempting to resume from <b>standby</b> mode, do not hold down the power button for more than four seconds. Otherwise, the computer will shut down and you will lose any unsaved data.

**Blank screen and the power LED flashes red five times, once every second, followed by a two second pause, and the computer beeps five times. (Beeps stop after fifth iteration but LEDs continue flashing.)**

Cause	Solution
Pre-video memory error.	<ol style="list-style-type: none"><li>1. Reseat DIMMs. Power on the system.</li><li>2. Replace DIMMs one at a time to isolate the faulty module.</li><li>3. Replace third-party memory with HP memory.</li><li>4. Replace the system board.</li></ol>

**Blank screen and the power LED flashes red six times, once every second, followed by a two second pause, and the computer beeps six times. (Beeps stop after fifth iteration but LEDs continue flashing.)**

Cause	Solution
Pre-video graphics error.	For systems with a graphics card: <ol style="list-style-type: none"><li>1. Reseat the graphics card. Power on the system.</li><li>2. Replace the graphics card.</li><li>3. Replace the system board.</li></ol> For systems with integrated graphics, replace the system board.

**Blank screen and the power LED flashes red seven times, once every second, followed by a two second pause, and the computer beeps seven times. (Beeps stop after fifth iteration but LEDs continue flashing.)**

Cause	Solution
System board failure (ROM detected failure prior to video).	Replace the system board.

**Monitor does not function properly when used with energy saver features.**

Cause	Solution
Monitor without energy saver capabilities is being used with energy saver features enabled.	Disable monitor energy saver feature.

**Dim characters.**

Cause	Solution
The brightness and contrast controls are not set properly.	Adjust the monitor brightness and contrast controls.
Cables are not properly connected.	Check that the graphics cable is securely connected to the graphics card and the monitor.

**Blurry video or requested resolution cannot be set.**

Cause	Solution
If the graphics controller was upgraded, the correct graphics drivers may not be loaded.	Install the video drivers included in the upgrade kit.
Monitor is not capable of displaying requested resolution.	Change requested resolution.
Graphics card is bad.	Replace the graphics card.

**The picture is broken up, rolls, jitters, or flashes.**

<b>Cause</b>	<b>Solution</b>
The monitor connections may be incomplete or the monitor may be incorrectly adjusted.	<ol style="list-style-type: none"><li>1. In a two-monitor system or if another monitor is in close proximity, be sure the monitors are not interfering with each other's electromagnetic field by moving them apart.</li><li>2. Fluorescent lights or fans may be too close to the monitor.</li></ol>
Monitor needs to be degaussed.	Degauss the monitor. Refer to the documentation that came with the monitor for instructions.

**Image is not centered.**

<b>Cause</b>	<b>Solution</b>
Position may need adjustment.	Press the monitor's Menu button to access the OSD menu. Select <b>ImageControl/ Horizontal Position</b> or <b>Vertical Position</b> to adjust the horizontal or vertical position of the image.

**"Out of Range" displays on screen.**

<b>Cause</b>	<b>Solution</b>
Video resolution and refresh rate are set higher than what the monitor supports.	Restart the computer and enter Safe Mode. Change the settings to a supported setting then restart the computer so that the new settings take effect.

**High pitched noise coming from inside monitor.**

<b>Cause</b>	<b>Solution</b>
Brightness and/or contrast settings are too high.	Lower brightness and/or contrast settings.

**Fuzzy focus; streaking, ghosting, or shadowing effects; horizontal scrolling lines; faint vertical bars; or unable to center the picture on the screen (flat panel monitors using an analog VGA input connection only).**

<b>Cause</b>	<b>Solution</b>
Monitor's internal digital conversion circuits may be unable to correctly interpret the output synchronization of the graphics card.	<ol style="list-style-type: none"><li>1. Select the monitor's Auto-Adjustment option in the monitor's on-screen display menu.</li><li>2. Manually synchronize the Clock and Clock Phase on-screen display functions. To download a SoftPaq that will assist you with the synchronization, go to the following Web site, select the appropriate monitor, and download either SP32347 or SP32202: <a href="http://www.hp.com/support">http://www.hp.com/support</a></li></ol>
Graphics card is not seated properly or is bad.	<ol style="list-style-type: none"><li>1. Reseat the graphics card.</li><li>2. Replace the graphics card.</li></ol>

Certain typed symbols do not appear correct.

Cause	Solution
The font you are using does not support that particular symbol.	Use the Character Map to locate and select the appropriate symbol. Click <b>Start &gt; All Programs &gt; Accessories &gt; System Tools &gt; Character Map</b> . You can copy the symbol from the Character Map into a document.

## Solving Audio Problems

If the computer has audio features and you encounter audio problems, see the common causes and solutions listed in the following table.

**Table 7-6 Solving Audio Problems**

**Sound cuts in and out.**

Cause	Solution
Processor resources are being used by other open applications.	Shut down all open processor-intensive applications.

**Sound does not come out of the speaker or headphones.**

Cause	Solution
Software volume control is turned down or muted.	Double-click the <b>Speaker</b> icon on the taskbar, then make sure that <b>Mute</b> is not selected and use the volume slider to adjust the volume.
Audio is hidden in Computer Setup.	Enable the audio in Computer Setup: <b>Security &gt; Device Security &gt; System Audio</b> .
The external speakers are not turned on.	Turn on the external speakers.
The audio device may be connected to the wrong jack.	Ensure that the device is connected to the correct jack on the computer. The speakers should be plugged into the rear line-out jack and the headphones should be plugged into the front headphone jack.
External speakers plugged into the wrong audio jack on a recently installed sound card.	See the sound card documentation for proper speaker connection.
Digital CD audio is not enabled.	Enable digital CD audio. In the Device Manager, right-click on the CD/DVD device and select <b>Properties</b> . Make sure <b>Enable digital CD audio for this CD-ROM device</b> is checked.
Headphones or devices connected to the line-out connector mute the internal speaker.	Turn on and use headphones or external speakers, if connected, or disconnect headphones or external speakers.
Computer is in <b>standby</b> mode.	Press the power button to resume from <b>standby</b> mode.  <b>CAUTION:</b> When attempting to resume from <b>standby</b> mode, do not hold down the power button for more than four seconds. Otherwise, the computer will shut down and you will lose any unsaved data.



**Table 7-6 Solving Audio Problems (continued)**

**Sound does not come out of the speaker or headphones.**

<b>Cause</b>	<b>Solution</b>
Internal speaker is disabled in Computer Setup.	Enable the internal speaker in Computer Setup. Select <b>Advanced &gt; Device Options &gt; Internal Speaker</b> .
The application is set to use a different audio device than speakers.	Some graphics cards support audio over the DisplayPort connection, so multiple audio devices may be listed in Device Manager. Make sure the correct device is being used.
Some applications can select which audio output device is used.	Make sure the application has selected the correct audio device.
The operating system controls may be set to use a different audio device as the default output device than what is expected.	Set the operating system to use the correct audio device.

**Sound from headphones is not clear or muffled.**

<b>Cause</b>	<b>Solution</b>
Headphones are plugged into the rear audio output connector. The rear audio output connector is for powered audio devices and is not designed for headphone use.	Plug the headphones into the headphone connector on the front of the computer.

**Computer appears to be locked up while recording audio.**

<b>Cause</b>	<b>Solution</b>
The hard disk may be full.	Before recording, make sure there is enough free space on the hard disk. You can also try recording the audio file in a compressed format.

**Line-in jack is not functioning properly.**

<b>Cause</b>	<b>Solution</b>
Jack has been reconfigured in the audio driver or application software.	In the audio driver or application software, reconfigure the jack or set the jack to its default value.

**There is no sound or sound volume is too low.**

<b>Cause</b>	<b>Solution</b>
The application is set to use a different audio device than speakers.	Some graphics cards support audio over the DisplayPort connection, so multiple audio devices may be listed in Device Manager. Make sure the correct device is being used.

**Table 7-6 Solving Audio Problems (continued)****There is no sound or sound volume is too low.**

Cause	Solution
Some applications can select which audio output device is used.	Make sure the application has selected the correct audio device.
The operating system controls may be set to use a different audio device as the default output device than what is expected.	Set the operating system to use the correct audio device.

## Solving Printer Problems

If you encounter printer problems, see the documentation that came with the printer and to the common causes and solutions listed in the following table.

**Table 7-7 Solving Printer Problems****Printer will not print.**

Cause	Solution
Printer is not turned on and online.	Turn the printer on and make sure it is online.
The correct printer drivers for the application are not installed.	<ol style="list-style-type: none"> <li>1. Install the correct printer driver for the application.</li> <li>2. Try printing using the MS-DOS command:   <code>DIR C:\ &gt; [printer port]</code>             where [printer port] is the address of the printer being used. If the printer works, reload the printer driver.</li> </ol>
If you are on a network, you may not have made the connection to the printer.	Make the proper network connections to the printer.
Printer may have failed.	Run printer self-test.

**Printer will not turn on.**

Cause	Solution
The cables may not be connected properly.	Reconnect all cables and check the power cord and electrical outlet.

**Printer prints garbled information.**

Cause	Solution
The correct printer driver for the application is not installed.	Install the correct printer driver for the application.
The cables may not be connected properly.	Reconnect all cables.
Printer memory may be overloaded.	Reset the printer by turning it off for one minute, then turn it back on.

**Printer is offline.**

Cause	Solution
The printer may be out of paper.	Check the paper tray and refill it if it is empty. Select online.

## Solving Keyboard and Mouse Problems

If you encounter keyboard or mouse problems, see the documentation that came with the equipment and to the common causes and solutions listed in the following table.

**Table 7-8 Solving Keyboard Problems**

**Keyboard commands and typing are not recognized by the computer.**

Cause	Solution
Keyboard connector is not properly connected.	<ol style="list-style-type: none"><li>1. Click <b>Start</b>, click the arrow on the lower right corner of the Start menu, then select <b>Shut Down</b>.</li><li>2. After the shutdown is complete, reconnect the keyboard to the back of the computer and restart the computer.</li></ol>
Program in use has stopped responding to commands.	Shut down your computer using the mouse and then restart the computer.
Keyboard needs repairs.	See the Worldwide Limited Warranty for terms and conditions.
Computer is in <b>standby</b> mode.	Press the power button to resume from <b>standby</b> mode.  <b>CAUTION:</b> When attempting to resume from <b>standby</b> mode, do not hold down the power button for more than four seconds. Otherwise, the computer will shut down and you will lose any unsaved data.

**Cursor will not move using the **arrow** keys on the keypad.**

Cause	Solution
The <b>Num Lock</b> key may be on.	Press the <b>Num Lock</b> key. The Num Lock light should not be on if you want to use the <b>arrow</b> keys. The <b>Num Lock</b> key can be disabled (or enabled) in Computer Setup.

**Table 7-9 Solving Mouse Problems**

**Mouse does not respond to movement or is too slow.**

<b>Cause</b>	<b>Solution</b>
Mouse connector is not properly plugged into the back of the computer.	Shut down the computer using the keyboard. <ol style="list-style-type: none"><li>1. Press the <b>Ctrl</b> and <b>Esc</b> keys at the same time (or press the <b>Windows logo</b> key) to display the <b>Start</b> menu.</li><li>2. Use the <b>arrow</b> keys to select <b>Shut Down</b> and then press the <b>Enter</b> key.</li><li>3. After the shutdown is complete, plug the mouse connector into the back of the computer (or the keyboard) and restart.</li></ol>
Program in use has stopped responding to commands.	Shut down the computer using the keyboard then restart the computer.
Mouse may need cleaning.	Remove the roller ball cover on the mouse and clean the internal components.
Mouse may need repair.	See the Worldwide Limited Warranty for terms and conditions.
Computer is in <b>standby</b> mode.	Press the power button to resume from <b>standby</b> mode. <b>CAUTION:</b> When attempting to resume from <b>standby</b> mode, do not hold down the power button for more than four seconds. Otherwise, the computer will shut down and you will lose any unsaved data.

**Mouse will only move vertically, horizontally, or movement is jerky.**

<b>Cause</b>	<b>Solution</b>
Mouse roller ball or the rotating encoder shafts that make contact with the ball are dirty.	Remove roller ball cover from the bottom of the mouse and clean the internal components with a mouse cleaning kit available from most computer stores.

**A wireless keyboard/mouse is not working correctly. Symptoms include lagging mouse movement, jumpy mouse/keyboard, or no function of mouse/keyboard and external drive.**

<b>Cause</b>	<b>Solution</b>
If your computer is equipped with USB 3.0 ports, connected USB 3.0 devices can interfere with the wireless keyboard USB receiver.	Connect the wireless keyboard USB receiver to a USB 2.0 port that is separated from ports with USB 3.0 devices. If you still experience interference, you may have to place the connectors farther apart using an external USB hub.

# Solving Hardware Installation Problems

You may need to reconfigure the computer when you add or remove hardware, such as an additional drive or expansion card. If you install a plug and play device, Windows automatically recognizes the device and configures the computer. If you install a non–plug and play device, you must reconfigure the computer after completing installation of the new hardware. In Windows, use the **Add Hardware Wizard** and follow the instructions that appear on the screen.

**⚠ WARNING!** When the computer is plugged into an AC power source, voltage is always applied to the system board. To reduce the risk of personal injury from electrical shock and/or hot surfaces, be sure to disconnect the power cord from the wall outlet and allow the internal system components to cool before touching.

**Table 7-10 Solving Hardware Installation Problems**

<b>A new device is not recognized as part of the system.</b>	
<b>Cause</b>	<b>Solution</b>
Device is not seated or connected properly.	Ensure that the device is properly and securely connected and that pins in the connector are not bent down.
Cable(s) of new external device are loose or power cables are unplugged.	Ensure that all cables are properly and securely connected and that pins in the cable or connector are not bent down.
Power switch of new external device is not turned on.	Turn off the computer, turn on the external device, then turn on the computer to integrate the device with the computer system.
When the system advised you of changes to the configuration, you did not accept them.	Reboot the computer and follow the instructions for accepting the changes.
A plug and play board may not automatically configure when added if the default configuration conflicts with other devices.	Use Windows Device Manager to deselect the automatic settings for the board and choose a basic configuration that does not cause a resource conflict. You can also use Computer Setup to reconfigure or disable devices to resolve the resource conflict.
USB ports on the computer are disabled in Computer Setup.	Run the Computer Setup utility and ensure that <b>Device available</b> is selected for appropriate USB ports under <b>Security &gt; USB Security</b> .

<b>Computer will not start.</b>	
<b>Cause</b>	<b>Solution</b>
Wrong memory modules were used in the upgrade or memory modules were installed in the wrong location.	<ol style="list-style-type: none"><li>1. Review the documentation that came with the system to determine if you are using the correct memory modules and to verify the proper installation.  <b>NOTE:</b> DIMM1 or XMM1 must always be installed. DIMM1 must be installed before DIMM2, and DIMM3 must be installed before DIMM4.</li><li>2. Observe the beeps and LED lights on the front of the computer. Beeps and flashing LEDs are codes for specific problems.</li><li>3. If you still cannot resolve the issue, contact Customer Support.</li></ol>

**Power LED flashes red five times, once every second, followed by a two second pause, and the computer beeps five times. (Beeps stop after fifth iteration but LEDs continue flashing.)**

Cause	Solution
Memory is installed incorrectly or is bad.	<p><b>CAUTION:</b> To avoid damage to the DIMMs or the system board, you must unplug the computer power cord before attempting to reseat, install, or remove a DIMM module.</p> <ol style="list-style-type: none"><li>1. Reseat DIMMs. Power on the system.</li><li>2. Replace DIMMs one at a time to isolate the faulty module.</li></ol> <p><b>NOTE:</b> DIMM1 or XMM1 must always be installed. DIMM1 must be installed before DIMM2, and DIMM3 must be installed before DIMM4</p> <ol style="list-style-type: none"><li>3. Replace third-party memory with HP memory.</li><li>4. Replace the system board.</li></ol>

**Power LED flashes red six times, once every second, followed by a two second pause, and the computer beeps six times. (Beeps stop after fifth iteration but LEDs continue flashing.)**

Cause	Solution
Graphics card is not seated properly or is bad, or system board is bad.	<p>For systems with a graphics card:</p> <ol style="list-style-type: none"><li>1. Reseat the graphics card. Power on the system.</li><li>2. Replace the graphics card.</li><li>3. Replace the system board.</li></ol> <p>For systems with integrated graphics, replace the system board.</p>

**Power LED flashes red ten times, once every second, followed by a two second pause, and the computer beeps ten times. (Beeps stop after fifth iteration but LEDs continue flashing.)**

Cause	Solution
Bad option card.	<ol style="list-style-type: none"><li>1. Check each option card by removing the cards one at time (if multiple cards), then power on the system to see if fault goes away.</li><li>2. Once bad card is identified, remove and replace bad option card.</li><li>3. Replace the system board.</li></ol>

## Solving Network Problems

Some common causes and solutions for network problems are listed in the following table. These guidelines do not discuss the process of debugging the network cabling.

**Table 7-11 Solving Network Problems**

**Wake-on-LAN feature is not functioning.**

Cause	Solution
S5 Maximum Power Saving feature is enabled.	Disable the S5 Maximum Power Saving option in Computer Setup. Select <b>Power &gt; Hardware Power Management &gt; S5 Maximum Power Saving</b> .
S5 Wake on LAN is disabled.	: Enable the S5 Wake on LAN option in Computer Setup. Select <b>Advanced &gt; Device Options &gt; S5 Wake on LAN</b> .
Wake-on-LAN is not enabled.	<ol style="list-style-type: none"><li>1. Select <b>Start &gt; Control Panel</b>.</li><li>2. Under <b>Network and Internet</b>, select <b>View network status and tasks</b>.</li><li>3. Click <b>Local Area Connection</b>.</li><li>4. Click the <b>Properties</b> button.</li><li>5. Click the <b>Configure</b> button.</li><li>6. Click the <b>Power Management</b> tab, then select the check box to <b>Allow this device to wake the computer</b>.</li></ol>

**Network driver does not detect network controller.**

Cause	Solution
Network controller is disabled.	<ol style="list-style-type: none"><li>1. Run Computer Setup and enable network controller.</li><li>2. Enable the network controller in the operating system via Device Manager.</li></ol>
Incorrect network driver.	Check the network controller documentation for the correct driver or obtain the latest driver from the manufacturer's Web site.

**Network status link light never flashes.**

**NOTE:** The network status light is supposed to flash when there is network activity.

Cause	Solution
No active network is detected.	Check cabling and network equipment for proper connection.
Network controller is not set up properly.	Check for the device status within Windows, such as Device Manager for driver load and the Network Connections applet within Windows for link status.
Network controller is disabled.	<ol style="list-style-type: none"><li>1. Run Computer Setup and enable network controller.</li><li>2. Enable the network controller in the operating system via Device Manager.</li></ol>
Network driver is not properly loaded.	Reinstall network drivers.
System cannot autosense the network.	Disable auto-sensing capabilities and force the system into the correct operating mode.

**Diagnostics reports a failure.**

<b>Cause</b>	<b>Solution</b>
The cable is not securely connected.	Ensure that the cable is securely attached to the network connector and that the other end of the cable is securely attached to the correct device.
The cable is attached to the incorrect connector.	Ensure that the cable is attached to the correct connector.
There is a problem with the cable or a device at the other end of the cable.	Ensure that the cable and device at the other end are operating correctly.
Network controller interrupt is shared with an expansion board.	Under the Computer Setup <b>Advanced</b> menu, change the resource settings for the board.
The network controller is defective.	Contact an authorized service provider.

**Diagnostics passes, but the computer does not communicate with the network.**

<b>Cause</b>	<b>Solution</b>
Network drivers are not loaded, or driver parameters do not match current configuration.	Make sure the network drivers are loaded and that the driver parameters match the configuration of the network controller.  Make sure the correct network client and protocol is installed.
The network controller is not configured for this computer.	Select the <b>Network</b> icon in the <b>Control Panel</b> and configure the network controller.

**Network controller stopped working when an expansion board was added to the computer.**

<b>Cause</b>	<b>Solution</b>
Network controller interrupt is shared with an expansion board.	Under the Computer Setup <b>Advanced</b> menu, change the resource settings for the board.
The network controller requires drivers.	Verify that the drivers were not accidentally deleted when the drivers for a new expansion board were installed.
The expansion board installed is a network card (NIC) and conflicts with the embedded NIC.	Under the Computer Setup <b>Advanced</b> menu, change the resource settings for the board.

**Network controller stops working without apparent cause.**

<b>Cause</b>	<b>Solution</b>
The files containing the network drivers are corrupted.	Reinstall the network drivers, using the Recovery Disc Set created from the hard drive's Recovery Partition.
The cable is not securely connected.	Ensure that the cable is securely attached to the network connector and that the other end of the cable is securely attached to the correct device.
The network controller is defective.	Contact an authorized service provider.



**New network card will not boot.**

Cause	Solution
New network card may be defective or may not meet industry-standard specifications.	Install a working, industry-standard NIC, or change the boot sequence to boot from another source.

**Cannot connect to network server when attempting Remote System Installation.**

Cause	Solution
The network controller is not configured properly.	Verify Network Connectivity, that a DHCP Server is present, and that the Remote System Installation Server contains the NIC drivers for your NIC.

**System setup utility reports unprogrammed EEPROM.**

Cause	Solution
Unprogrammed EEPROM.	Contact an authorized service provider.

## Solving Memory Problems

If you encounter memory problems, some common causes and solutions are listed in the following table.

**CAUTION:** Power may still be supplied to the DIMMs when the computer is turned off (depending on the Management Engine (ME) settings). To avoid damage to the DIMMs or the system board, you must unplug the computer power cord before attempting to reseat, install, or remove a DIMM module.

For those systems that support ECC memory, HP does not support mixing ECC and non-ECC memory. Otherwise, the computer will not boot the operating system.

**Table 7-12 Solving Memory Problems**

**System will not boot or does not function properly after installing additional memory modules.**

Cause	Solution
A memory module is not installed in the DIMM1 or XMM1 socket.	Ensure that a memory module is installed in the DIMM1 or XMM1 socket on the system board. This socket must be populated with a memory module.
Memory module is not the correct type or speed grade for the system or the new memory module is not seated properly.	Replace module with the correct industry-standard device for the computer. On some models, ECC and non-ECC memory modules cannot be mixed.

**Out of memory error.**

Cause	Solution
Memory configuration may not be set up correctly.	Use the Device Manager to check memory configuration.
You have run out of memory to run the application.	Check the application documentation to determine the memory requirements.

**Memory count during POST is wrong.**

Cause	Solution
The memory modules may not be installed correctly.	Check that the memory modules have been installed correctly and that proper modules are used.
Integrated graphics may use system memory.	No action required.

**Insufficient memory error during operation.**

Cause	Solution
Too many Terminate and Stay Resident programs (TSRs) are installed.	Delete any TSRs that you do not need.
You have run out of memory for the application.	Check the memory requirements for the application or add more memory to the computer.

**Power LED flashes red five times, once every second, followed by a two second pause, and the computer beeps five times. (Beeps stop after fifth iteration but LEDs continue flashing.)**

Cause	Solution
Memory is installed incorrectly or is bad.	<ol style="list-style-type: none"><li>1. Reseat DIMMs. Power on the system.</li><li>2. Replace DIMMs one at a time to isolate the faulty module.</li><li>3. Replace third-party memory with HP memory.</li><li>4. Replace the system board.</li></ol>

## Solving Processor Problems

If you encounter processor problems, common causes and solutions are listed in the following table.

**Table 7-13 Solving Processor Problems**

<b>Poor performance is experienced.</b>	
<b>Cause</b>	<b>Solution</b>
Processor is hot.	<ol style="list-style-type: none"><li>1. Make sure the airflow to the computer is not blocked.</li><li>2. Make sure the fans are connected and working properly (some fans only operate when needed).</li><li>3. Make sure the processor heat sink is installed properly.</li></ol>

<b>Power LED flashes red three times, once every second, followed by a two second pause.</b>	
<b>Cause</b>	<b>Solution</b>
Processor is not seated properly or not installed.	<ol style="list-style-type: none"><li>1. Check to see that the processor is present.</li><li>2. Reseat the processor.</li></ol>

<b>Power LED flashes red eleven times, once every second, followed by a two second pause.</b>	
<b>Cause</b>	<b>Solution</b>
The current processor does not support a feature previously enabled on this system.	<ol style="list-style-type: none"><li>1. Install a TXT capable processor.</li><li>2. Disable TXT in the Computer Setup (F10) utility.</li><li>3. Reinstall the original processor.</li></ol>

## Solving CD-ROM and DVD Problems

If you encounter CD-ROM or DVD problems, see the common causes and solutions listed in the following table or to the documentation that came with the optional device.

**Table 7-14 Solving CD-ROM and DVD Problems**

<b>System will not boot from CD-ROM or DVD drive.</b>	
<b>Cause</b>	<b>Solution</b>
The device is attached to a SATA port that has been hidden in the Computer Setup utility.	Run the Computer Setup utility and ensure <b>Device Available</b> is selected for the device's SATA port in <b>Security &gt; Device Security</b> .
Removable Media Boot is disabled in the Computer Setup utility.	Run the Computer Setup utility and enable booting to removable media in <b>Storage &gt; Storage Options</b> . Ensure CD-ROM is enabled in <b>Storage &gt; Boot Order</b> .
Network Server Mode is enabled in Computer Setup.	Run the Computer Setup utility and disable Network Server Mode in <b>Security &gt; Password Options</b> .
Non-bootable CD in drive.	Try a bootable CD in the drive.
Boot order not correct.	Run the Computer Setup utility and change boot sequence in <b>Storage &gt; Boot Order</b> .

**Drive not found (identified).**

<b>Cause</b>	<b>Solution</b>
Cable could be loose.	Check cable connections.
The system may not have automatically recognized a newly installed device.	See reconfiguration directions in the <a href="#">Solving Hardware Installation Problems on page 101</a> section. If the system still does not recognize the new device, check to see if the device is listed within Computer Setup. If it is listed, the probable cause is a driver problem. If it is not listed, the probable cause is a hardware problem.  If this is a newly installed drive, run the Computer Setup utility and try adding a POST delay under <b>Advanced &gt; Power-On Options</b> .
The device is attached to a SATA port that has been hidden in Computer Setup.	Run the Computer Setup utility and ensure <b>Device Available</b> is selected for the device's SATA port in <b>Security &gt; Device Security</b> .
Drive responds slowly immediately after power-up.	Run Computer Setup and increase the POST Delay in <b>Advanced &gt; Power-On Options</b> .

**CD-ROM or DVD devices are not detected or driver is not loaded.**

<b>Cause</b>	<b>Solution</b>
Drive is not connected properly or not properly configured.	See the documentation that came with the optional device.

**Movie will not play in the DVD drive.**

<b>Cause</b>	<b>Solution</b>
Movie may be regionalized for a different country.	See the documentation that came with the DVD drive.
Decoder software is not installed.	Install decoder software.
Damaged media.	Replace media.
Movie rating locked out by parental lock.	Use DVD software to remove parental lock.
Media installed upside down.	Reinstall media.

**Cannot eject compact disc (tray-load unit).**

<b>Cause</b>	<b>Solution</b>
Disc not properly seated in the drive.	Turn off the computer and insert a thin metal rod into the emergency eject hole and push firmly. Slowly pull the tray out from the drive until the tray is fully extended, then remove the disc.

**CD-ROM, CD-RW, DVD-ROM, or DVD-R/RW drive cannot read a disc or takes too long to start.**

Cause	Solution
Media has been inserted upside down.	Re-insert the media with the label facing up.
The DVD-ROM drive takes longer to start because it has to determine the type of media played, such as audio or video.	Wait at least 30 seconds to let the DVD-ROM drive determine the type of media being played. If the disc still does not start, read the other solutions listed for this topic.
CD or DVD disc is dirty.	Clean CD or DVD with a CD cleaning kit, available from most computer stores.
Windows does not detect the CD-ROM or DVD-ROM drive.	<ol style="list-style-type: none"><li>1. Use Device Manager to remove or uninstall the device.</li><li>2. Restart the computer and let Windows detect the CD or DVD driver.</li></ol>

**Recording or copying CDs is difficult or impossible.**

Cause	Solution
Wrong or poor quality media type.	<ol style="list-style-type: none"><li>1. Try using a slower speed when recording.</li><li>2. Verify that you are using the correct media for the drive.</li><li>3. Try a different brand of media. Quality varies widely between manufacturers.</li></ol>

## Solving USB Flash Drive Problems

If you encounter USB flash drive problems, common causes and solutions are listed in the following table.

**Table 7-15 Solving USB Flash Drive Problems**

**USB flash drive is not seen as a drive letter in Windows.**

Cause	Solution
The drive letter after the last physical drive is not available.	Change the default drive letter for the flash drive in Windows.

**USB flash drive not found (identified).**

Cause	Solution
The device is attached to a USB port that has been hidden in Computer Setup.	Run the Computer Setup utility and ensure that "Device available" is selected for "Front USB Ports" and "Rear USB Ports" under <b>Security &gt; Device Security</b> .
The device was not properly seated before power-up.	Ensure the device is fully inserted into the USB port before applying power to the system

**System will not boot from USB flash drive.**

<b>Cause</b>	<b>Solution</b>
Boot order is not correct.	Run the Computer Setup utility and change boot sequence in <b>Storage &gt; Boot Order</b> .
Removable Media Boot is disabled in the Computer Setup utility.	Run the Computer Setup utility and enable booting to removable media in <b>Storage &gt; Storage Options</b> . Ensure USB is enabled in <b>Storage &gt; Boot Order</b> .

**The computer boots to DOS after making a bootable flash drive.**

<b>Cause</b>	<b>Solution</b>
Flash drive is bootable.	Install the flash drive only after the operating system boots.

## Solving Internet Access Problems

If you encounter Internet access problems, consult your Internet Service Provider (ISP) or refer to the common causes and solutions listed in the following table.

**Table 7-16 Solving Internet Access Problems**

**Unable to connect to the Internet.**

<b>Cause</b>	<b>Solution</b>
Internet Service Provider (ISP) account is not set up properly.	Verify Internet settings or contact your ISP for assistance.
Modem is not set up properly.	Reconnect the modem. Verify the connections are correct using the quick setup documentation.
Web browser is not set up properly.	Verify that the Web browser is installed and set up to work with your ISP.
Cable/DSL modem is not plugged in.	Plug in cable/DSL modem. You should see a "power" LED light on the front of the cable/DSL modem.
Cable/DSL service is not available or has been interrupted due to bad weather.	Try connecting to the Internet at a later time or contact your ISP. (If the cable/DSL service is connected, the "cable" LED light on the front of the cable/DSL modem will be on.)
The CAT5 UTP cable is disconnected.	Connect the CAT5 UTP cable between the cable modem and the computers's RJ-45 connector. (If the connection is good, the "PC" LED light on the front of the cable/DSL modem will be on.)

**Table 7-16 Solving Internet Access Problems (continued)**

<b>Unable to connect to the Internet.</b>	
<b>Cause</b>	<b>Solution</b>
IP address is not configured properly.	Contact your ISP for the correct IP address.
Cookies are corrupted. (A “cookie” is a small piece of information that a Web server can store temporarily with the Web browser. This is useful for having the browser remember some specific information that the Web server can later retrieve.)	<ol style="list-style-type: none"><li>1. Select <b>Start &gt; Control Panel</b>.</li><li>2. Click <b>Network and Internet</b>.</li><li>3. Click <b>Internet Options</b>.</li><li>4. In the <b>Browsing history</b> section on the <b>General</b> tab, click the <b>Delete</b> button.</li><li>5. Select the <b>Cookies</b> check box and click the <b>Delete</b> button.</li></ol>
<b>Cannot automatically launch Internet programs.</b>	
<b>Cause</b>	<b>Solution</b>
You must log on to your ISP before some programs will start.	Log on to your ISP and launch the desired program.
<b>Internet takes too long to download Web sites.</b>	
<b>Cause</b>	<b>Solution</b>
Modem is not set up properly.	Verify that the modem is connected and communicating properly. <ol style="list-style-type: none"><li>1. Select <b>Start &gt; Control Panel</b>.</li><li>2. Click on <b>Hardware and Sound</b>.</li><li>3. Click on <b>Device Manager</b>.</li><li>4. Double-click <b>Modems</b>.</li><li>5. Double-click <b>Agere Systems PCI-SV92PP Soft Modem</b>.</li><li>6. On the <b>General</b> tab, click <b>Diagnostics</b>.</li><li>7. Click <b>Query Modem</b>. A “Success” response indicates the modem is connected and working properly.</li></ol>

# Solving Software Problems

Most software problems occur as a result of the following:

- The application was not installed or configured correctly.
- There is insufficient memory available to run the application.
- There is a conflict between applications.
- Be sure that all the needed device drivers have been installed.
- If you have installed an operating system other than the factory-installed operating system, check to be sure it is supported on the system.

If you encounter software problems, see the applicable solutions listed in the following table.

**Table 7-17 Solving Software Problems**

**Computer will not continue and no HP logo screen has appeared.**

Cause	Solution
POST error has occurred.	Observe the beeps and LED lights on the front of the computer. See Appendix A, <a href="#">POST Error Messages on page 113</a> to determine possible causes.  See the Restore Kit or the Worldwide Limited Warranty for terms and conditions.

**Computer will not continue after HP logo screen has appeared.**

Cause	Solution
System files may be damaged.	Use recovery diskette to scan hard drive for errors.

**“Illegal Operation has Occurred” error message is displayed.**

Cause	Solution
Software being used is not Microsoft-certified for your version of Windows.	Verify that the software is certified by Microsoft for your version of Windows (see program packaging for this information).
Configuration files are corrupt.	If possible, save all data, close all programs, and restart the computer.



---

## 8 POST Error Messages

This appendix lists the error codes, error messages, and the various indicator light and audible sequences that you may encounter during Power-On Self-Test (POST) or computer restart, the probable source of the problem, and steps you can take to resolve the error condition.

POST Message Disabled suppresses most system messages during POST, such as memory count and non-error text messages. If a POST error occurs, the screen will display the error message. To manually switch to the POST Messages Enabled mode during POST, press any key (except **F10**, **F11**, or **F12**). The default mode is POST Message Disabled.

The speed at which the computer loads the operating system and the extent to which it is tested are determined by the POST mode selection.

Full Boot may also be enabled to run every 1 to 30 days on a regularly scheduled basis. To establish the schedule, reconfigure the computer to the Full Boot Every x Days mode, using Computer Setup.

# POST Numeric Codes and Text Messages

This section covers those POST errors that have numeric codes associated with them. The section also includes some text messages that may be encountered during POST.



**NOTE:** The computer will beep once after a POST text message is displayed on the screen.

**Table 8-1** Numeric Codes and Text Messages

Control panel message	Description	Recommended action
ERROR: No boot disk has been detected or the disk has failed.	The computer cannot read the boot sector of the boot disk.	<ol style="list-style-type: none"><li>1. Check drive data and power cables.</li><li>2. Use F10 Setup to make sure the first boot device is set to drive C or the primary hard drive.</li><li>3. The drive has failed due to mechanical or virus corruption. Replace the drive.</li></ol>
Keyboard Error	Keyboard failure.	<ol style="list-style-type: none"><li>1. Reconnect keyboard with computer turned off.</li><li>2. Check connector for bent or missing pins.</li><li>3. Ensure that none of the keys are depressed.</li><li>4. Replace keyboard.</li><li>5. Replace the system board.</li></ol>
511-CPU Fan not Detected	CPU fan is not connected or may have malfunctioned.	<ol style="list-style-type: none"><li>1. Reseat CPU fan.</li><li>2. Reseat fan cable.</li><li>3. Replace CPU fan.</li></ol>
1720-SMART Hard Drive Detects Imminent Failure	Hard drive is about to fail. (Some hard drives have a hard drive firmware patch that will fix an erroneous error message.)	<ol style="list-style-type: none"><li>1. Determine if hard drive is giving correct error message. Enter Computer Setup and run the Drive Protection System test under <b>Storage &gt; DPS Self-test</b>.</li><li>2. Apply hard drive firmware patch if applicable. (Available at <a href="http://www.hp.com/support">http://www.hp.com/support</a>.)</li><li>3. Back up contents and replace hard drive.</li></ol>
Unsupported CPU	Recently installed processor is not supported by the system.	Install a processor supported by your system.
Time & Date Not Set	Invalid time or date in configuration memory.  RTC (real-time clock) battery may need to be replaced.  CMOS jumper may not be properly installed.	Reset the date and time under Control Panel (Computer Setup can also be used). If the problem persists, replace the RTC battery.  Check for proper placement of the CMOS jumper if applicable.

# Interpreting POST Diagnostic Front Panel LEDs

This section covers the front panel LED codes as well as the audible codes that may occur before or during POST that do not necessarily have an error code or text message associated with them.

**⚠ WARNING!** When the computer is plugged into an AC power source, voltage is always applied to the system board. To reduce the risk of personal injury from electrical shock and/or hot surfaces, be sure to disconnect the power cord from the wall outlet and allow the internal system components to cool before touching.

**📝 NOTE:** If you see flashing LEDs on a PS/2 keyboard, look for flashing LEDs on the front panel of the computer and refer to the following table to determine the front panel LED codes.

Recommended actions in the following table are listed in the order in which they should be performed.

Not all diagnostic lights and audible codes are available on all models.

**Table 8-2 Diagnostic Front Panel LEDs and Audible Codes**

Activity	Blinks	Possible Cause	Recommended Action
White Power LED flashes five times, once every second, followed by a two second pause. Beeps stop after fifth iteration but LEDs continue until problem is solved.	5	Pre-video memory error.	<b>CAUTION:</b> To avoid damage to the DIMMs or the system board, you must unplug the computer power cord before attempting to reseat, install, or remove a DIMM module. <ol style="list-style-type: none"><li>1. Reseat DIMMs.</li><li>2. Replace DIMMs one at a time to isolate the faulty module.</li><li>3. Replace third-party memory with HP memory.</li><li>4. Replace the system board.</li></ol>
White Power LED flashes six times, once every second, followed by a two second pause. Beeps stop after fifth iteration but LEDs continue until problem is solved.	6	Pre-video graphics error.	For systems with a graphics card: <ol style="list-style-type: none"><li>1. Reseat the graphics card.</li><li>2. Replace the graphics card.</li><li>3. Replace the system board.</li></ol> For systems with integrated graphics, replace the system board.
White Power LED flashes seven times, once every second, followed by a two second pause. Beeps stop after fifth iteration but LEDs continue until problem is solved.	7	System board failure (ROM detected failure prior to video).	Replace the system board.
White Power LED flashes eight times, once every second, followed by a two second pause. Beeps stop after fifth iteration but LEDs continue until problem is solved.	8	Invalid ROM based on bad checksum.	<ol style="list-style-type: none"><li>1. Reflash the system ROM with the latest BIOS image.</li><li>2. Replace the system board.</li></ol>

---

# 9 Password Security and Resetting CMOS

This computer supports security password features, which can be established through the Computer Setup Utilities menu.

This computer supports two security password features that are established through the Computer Setup Utilities menu: setup password and power-on password. When you establish only a setup password, any user can access all the information on the computer except Computer Setup. When you establish only a power-on password, the power-on password is required to access Computer Setup and any other information on the computer. When you establish both passwords, only the setup password will give you access to Computer Setup.

When both passwords are set, the setup password can also be used in place of the power-on password as an override to log in to the computer. This is a useful feature for a network administrator.

If you forget the password for the computer, you can clear that password so you can gain access to the information on the computer by resetting the password jumper.

---

 **CAUTION:** Pushing the CMOS button will reset CMOS values to factory defaults. It is important to back up the computer CMOS settings before resetting them in case they are needed later. Back up is easily done through Computer Setup. See [Computer Setup \(F10\) Utility on page 9](#) for information.

---

## Establishing a Setup or Power-on Password

To establish the power-on or setup password features, complete the following steps:

1. Turn on or restart the computer.
2. As soon as the computer turns on, press the **Esc** key while “Press the ESC key for Startup Menu” message is displayed at the bottom of the screen.
3. Press the **F10** key to enter Computer Setup.
4. To establish Setup password, select **Security > Setup Password** and follow the instructions.

– or –

To establish a Power-On password, select **Security > Power-On Password** and follow the instructions on the screen

5. Before exiting, click **File > Save Changes and Exit**.

## Resetting the Setup and Power-on Password

To disable the power-on or setup password features, or to clear the power-on or setup passwords, complete the following steps:

1. Shut down the operating system properly, then turn off the computer and any external devices, and disconnect the power cord from the power outlet.
2. With the power cord disconnected, press the power button again to drain the system of any residual power.

---

 **WARNING!** To reduce the risk of personal injury from electrical shock and/or hot surfaces, be sure to disconnect the power cord from the wall outlet, and allow the internal system components to cool before touching.

 **CAUTION:** When the computer is plugged in, the power supply always has voltage applied to the system board even when the unit is turned off. Failure to disconnect the power cord can result in damage to the system.

Static electricity can damage the electronic components of the computer or optional equipment. Before beginning these procedures, ensure that you are discharged of static electricity by briefly touching a grounded metal object. See the *Regulatory, Safety and Environmental Notices* guide for more information.

---

3. Remove the access panel.
4. Locate the header and jumper labeled PW.

 **NOTE:** The password jumper is blue so that it can be easily identified. For assistance locating the password jumper and other system board components, see the Illustrated Parts & Service Map (IPSM). The IPSM can be downloaded from <http://www.hp.com/support>.

---

5. Remove the jumper.
6. Replace the jumper.
7. Replace the access panel.
8. Reconnect the external equipment.
9. Plug in the computer and turn on power. Allow the operating system to start. This clears the current passwords and disables the password features.
10. Establish the new passwords in Computer Setup. See [Computer Setup \(F10\) Utility on page 9](#) for information.

# Resetting CMOS

The computer's configuration memory (CMOS) stores information about the computer's configuration.

 **CAUTION:** Removing and replacing the CMOS jumper will reset CMOS values to factory defaults. It is important to back up the computer CMOS settings before resetting them in case they are needed later. Back up is easily done through Computer Setup. See [Computer Setup \(F10\) Utility on page 9](#) for information.

---

To reset CMOS, complete the following steps:

1. Shut down the operating system properly, then turn off the computer and any external devices, and disconnect the power cord from the power outlet.
2. With the power cord disconnected, press the power button again to drain the system of any residual power.

 **WARNING!** To reduce the risk of personal injury from electrical shock and/or hot surfaces, be sure to disconnect the power cord from the wall outlet, and allow the internal system components to cool before touching.

 **CAUTION:** When the computer is plugged in, the power supply always has voltage applied to the system board even when the unit is turned off. Failure to disconnect the power cord can result in damage to the system.

Static electricity can damage the electronic components of the computer or optional equipment. Before beginning these procedures, ensure that you are discharged of static electricity by briefly touching a grounded metal object. See the *Regulatory, Safety and Environmental Notices* guide for more information.

---

3. Remove the access panel.
4. Locate the header and jumper labeled CMOS.

 **NOTE:** The password jumper is blue so that it can be easily identified. For assistance locating the password jumper and other system board components, see the Illustrated Parts & Service Map (IPSM). The IPSM can be downloaded from <http://www.hp.com/support>.

---

5. Remove the jumper and place it on pins 1 and 2.
6. Wait for three seconds, and then replace the jumper to its original position (pins 2 and 3).
7. Replace the access panel.
8. Reconnect the external equipment.
9. Plug in the computer and turn on power. Allow the operating system to start.

 **NOTE:** You will receive POST error messages after clearing CMOS and rebooting advising you that configuration changes have occurred. Use Computer Setup to reset any special system setups along with the date and time.

---

---

# A Power Cord Set Requirements

The power supplies on some computers have external power switches. The voltage select switch feature on the computer permits it to operate from any line voltage between 100-120 or 220-240 volts AC. Power supplies on those computers that do not have external power switches are equipped with internal switches that sense the incoming voltage and automatically switch to the proper voltage.

The power cord set received with the computer meets the requirements for use in the country where you purchased the equipment.

Power cord sets for use in other countries must meet the requirements of the country where you use the computer.

## General Requirements

The requirements listed below are applicable to all countries:

1. The power cord must be approved by an acceptable accredited agency responsible for evaluation in the country where the power cord set will be installed.
2. The power cord set must have a minimum current capacity of 10A (7A Japan only) and a nominal voltage rating of 125 or 250 volts AC, as required by each country's power system.
3. The diameter of the wire must be a minimum of 0.75 mm<sub>2</sub> or 18AWG, and the length of the cord must be between 1.8 m (6 feet) and 3.6 m (12 feet).

The power cord should be routed so that it is not likely to be walked on or pinched by items placed upon it or against it. Particular attention should be paid to the plug, electrical outlet, and the point where the cord exits from the product.

---

 **WARNING!** Do not operate this product with a damaged power cord set. If the power cord set is damaged in any manner, replace it immediately.

---

## Japanese Power Cord Requirements

For use in Japan, use only the power cord received with this product.

---

 **CAUTION:** Do not use the power cord received with this product on any other products.

---



## Country-Specific Requirements

Additional requirements specific to a country are shown in parentheses and explained below.

Country	Accrediting Agency	Country	Accrediting Agency
Australia (1)	EANSW	Italy (1)	IMQ
Austria (1)	OVE	Japan (3)	METI
Belgium (1)	CEBC	Norway (1)	NEMKO
Canada (2)	CSA	Sweden (1)	SEMKO
Denmark (1)	DEMKO	Switzerland (1)	SEV
Finland (1)	SETI	United Kingdom (1)	BSI
France (1)	UTE	United States (2)	UL
Germany (1)	VDE		

1. The flexible cord must be Type HO5VV-F, 3-conductor, 0.75mm<sup>2</sup> conductor size. Power cord set fittings (appliance coupler and wall plug) must bear the certification mark of the agency responsible for evaluation in the country where it will be used.
2. The flexible cord must be Type SVT or equivalent, No. 18 AWG, 3-conductor. The wall plug must be a two-pole grounding type with a NEMA 5-15P (15A, 125V) or NEMA 6-15P (15A, 250V) configuration.
3. Appliance coupler, flexible cord, and wall plug must bear a "T" mark and registration number in accordance with the Japanese Dentori Law. Flexible cord must be Type VCT or VCTF, 3-conductor, 0.75 mm<sup>2</sup> conductor size. Wall plug must be a two-pole grounding type with a Japanese Industrial Standard C8303 (7A, 125V) configuration.

# B Specifications

## All-in One Models

**Table B-1 Specifications**

<b>Desktop Dimensions</b>		
Height	16.00 in	40.6 cm
Width	20.00 in	50.7 cm
Depth	8.66 in	22.0 cm
<b>Approximate Weight</b>		
With stand	15.36 lb	6.97 kg
Without stand	12.63 lb	5.73 kg
<b>Display</b>		
Type	TN (Twisted Nematic) LED Backlit LCD	
Viewable image area	442.8(H) x 249.075(V) [mm]	
Resolution	1600x900	
Contrast ratio	1000:1 (typical)	
Image brightness	250 nits (typical)	
Viewing angle (typical)	85°/85°/80°/80° (L/R/U/D)	
Pixel pitch	0.27675(H) x 0.27675(W) [mm]	
Backlight lamp life (to half brightness)	30,000 hours minimum	
Color gamut (typical)	72%	
Anti-glare	Yes	
<b>Temperature Range</b>		
Operating	41° to 95°F	5° to 35°C
Nonoperating	-22° to 149°F	-30° to 65°C
<b>Relative Humidity (noncondensing)</b>		
Operating	15-80% at 79°F	15-80% at 26°C

**Table B-1 Specifications (continued)**

<b>Maximum Altitude (unpressurized)</b>		
Operating	0 - 6,500 ft	0 - 2000 m
Nonoperating	0 - 15,000 ft	4,572 m
<b>Power Supply</b>		
Rated Voltage Range		100-240 V
Rated Line Frequency		50-60 Hz
<b>Max Operating Power</b>		150 W

---

# Index

- A**
  - audible codes 115
  - audio problems 96
- B**
  - battery
    - disposal 25
  - battery replacement 42
  - booting options
    - Full Boot 113
- C**
  - cable pinouts
    - SATA data 17
  - cautions
    - AC power 19
    - cables 25
    - electrostatic discharge 20
    - keyboard cleaning 23
    - keyboard keys 24
  - CD-ROM or DVD problems 107
  - cleaning
    - computer 23
    - mouse 24
    - safety precautions 23
  - CMOS
    - backing up 116
  - components
    - front 3
    - rear 5
    - side 4
  - computer cleaning 23
  - converter board
    - removing 58
  - country power cord set requirements 121
- D**
  - display cable
    - removing 75
  - display panel
    - removing 78
  - drive access panel
    - removing 31
- E**
  - electrostatic discharge (ESD) 20
    - preventing damage 20
  - error
    - codes 113, 115
    - messages 114
- F**
  - fan
    - removing 56
  - features
    - overview 1
  - flash drive problems 109
  - flashing LEDs 115
  - front bezel
    - removing 77
  - front components 3
- G**
  - general problems 85
  - grounding methods 21
- H**
  - hard drive
    - proper handling 25
    - removing 35
    - SATA characteristics 17
  - hard drive connector
    - removing 73
  - hard drive problems 88
  - hardware installation problems 101
  - heat sink
    - removing 47
  - heat sink cover
    - removing 45
  - hinge cover panel
    - removing 27
- I**
  - installing
    - battery 42
  - Internet access problems 110
- K**
  - keyboard
    - cleaning 23
  - keyboard problems 99
- L**
  - LEDs
    - blinking power 115
    - blinking PS/2 keyboard 115
- M**
  - Media Card Reader problems 92
  - memory access panel
    - removing 29
  - memory module
    - removing 38
  - memory problems 105
  - monitor problems 93
  - mouse
    - cleaning 24
  - mouse problems 99
- N**
  - network problems 102
  - numeric error codes 114

## O

- opening the computer 26
- operating guidelines 22
- optical drive
  - removing 33
- optical drive connector
  - removing 73
- optical drive problems 107
- overheating, prevention 22

## P

- password
  - clearing 116
  - power-on 116
  - setup 116
- POST error messages 113
- power cord set requirements
  - country specific 121
- power problems 88
- power supply 123
- power switch assembly
  - removing 82
- power-on password 116
- printer problems 98
- problems
  - audio 96
  - CD-ROM or DVD 107
  - flash drive 109
  - general 85
  - hard drive 88
  - hardware installation 101
  - Internet access 110
  - keyboard 99
  - Media Card Reader 92
  - memory 105
  - monitor 93
  - mouse 99
  - network 102
  - power 88
  - printer 98
  - processor 106
  - software 112
- processor problems 106

## R

- rear components 5
- rear cover
  - removing 55

- removal and replacement procedures

- All-in One chassis 26
- converter board 58
- display cable 75
- display panel 78
- drive access panel 31
- fan 56
- front bezel 77
- hard drive 35
- hard drive connector 73
- heat sink 47
- heat sink cover 45
- hinge cover panel 27
- memory 38
- memory access panel 29
- optical drive 33
- optical drive connector 73
- power switch assembly 82
- preparing to disassemble the computer 26
- rear cover 55
- sidekey board 60
- speakers 66
- stand 54
- stand bracket 68
- system board 70
- system board shield 62
- thermal module 47
- top panel 51
- webcam module 52
- WLAN module 64
- removing battery 42
- resetting
  - CMOS 116
  - password jumper 116

## S

- safety and comfort 84
- safety precautions
  - cleaning 23
- SATA
  - connectors on system board 17
  - data cable pinouts 17
  - hard drive characteristics 17
- screws, correct size 24
- service considerations 24
- setup password 116
- side components 4

- software

- problems 112
- servicing computer 24
- spare part number
  - tamper-resistant wrench 24
  - Torx T-15 screwdriver 24
- speakers
  - removing 66
- specifications
  - computer 122
- stand
  - removing 54
- static electricity 20
- system board
  - removing 70
  - SATA connectors 17
- system board shield
  - removing 62

## T

- tamper-proof screws
  - tool 24
- temperature control 22
- thermal module
  - removing 47
- tilt adjustment 6
- tools, servicing 24
- top panel
  - removing 51
- Torx T15 screwdriver 24

## V

- ventilation, proper 22
- volume button board
  - removing 60

## W

- Wake-on-LAN feature 103
- webcam module
  - removing 52
- WLAN module
  - removing 64