

MX-H835

MINI-Compact System
MP3-CD/WMA-CD/CD-R/RW Playback
user manual

imagine the possibilities



Thank you for purchasing this Samsung product.
To receive more complete service,
please register your product at
www.samsung.com/register



Safety Warnings

TO REDUCE THE RISK OF ELECTRIC SHOCK, DO NOT REMOVE THE COVER (OR BACK). NO USER-SERVICEABLE PARTS ARE INSIDE. REFER SERVICING TO QUALIFIED SERVICE PERSONNEL.

CAUTION
RISK OF ELECTRIC SHOCK DO NOT OPEN
CAUTION: TO PREVENT ELECTRIC SHOCK, MATCH WIDE BLADE OF PLUG TO WIDE SLOT, FULLY INSERT.

	This symbol indicates "dangerous voltage" inside the product that presents a risk of electric shock or personal injury.
	This symbol indicates important instructions accompanying the product.

WARNING

- To reduce the risk of fire or electric shock, do not expose this appliance to rain or moisture.

CLASS 1 LASER PRODUCT

This Compact Disc player is classified as a CLASS 1 LASER product. Use of controls, adjustments or performance of procedures other than those specified herein may result in hazardous radiation exposure.

Complies with 21CFR 1040.10 except for deviations pursuant to Laser Notice No. 50, dated June 24, 2007.

DANGER :

- VISIBLE AND INVISIBLE LASER RADIATION WHEN OPEN. AVOID DIRECT EXPOSURE TO BEAM. (FDA 21 CFR)

CAUTION :

- CLASS 3B VISIBLE AND INVISIBLE LASER RADIATION WHEN OPEN. AVOID EXPOSURE TO THE BEAM. (IEC 60825-1)
- THIS product UTILIZES A LASER. USE OF CONTROLS OR ADJUSTMENTS OR PERFORMANCE OF PROCEDURES OTHER THAN THOSE SPECIFIED HEREIN MAY RESULT IN HAZARDOUS RADIATION EXPOSURE. DO NOT OPEN THE COVER AND DO NOT REPAIR YOURSELF. REFER SERVICING TO QUALIFIED PERSONNEL.

CLASS 1	LASER PRODUCT
KLASSE 1	LASER PRODUKT
LUOKAN 1	LASER LAITE
KLASS 1	LASER APPARAT
PRODUCTO	LASER CLASE 1

WARNING

- TO PREVENT THE SPREAD OF FIRE, KEEP CANDLES AND OTHER ITEMS WITH OPEN FLAMES AWAY FROM THIS PRODUCT AT ALL TIMES.



- This product contains chemicals known to the State of California to cause cancer and reproductive toxicity.

FCC NOTES (for U.S.A)

This equipment has been tested and found to comply with the limits for a Class B digital device, pursuant to Part 15 of the FCC rules. These limits are designed to provide reasonable protection against harmful interference in a residential installation. This equipment generates, uses and can radiate radio frequency energy and, if not installed and used in accordance with the instructions, may cause harmful interference to radio or television reception, which can be determined by turning the equipment off and on.

If interference is present, the user is encouraged to try to correct the interference by one or more of the following measures:

- Reorient or relocate the receiving antenna.
- Increase the separation between the equipment and receiver.
- Connect this equipment to an outlet that is on a circuit that is different than the circuit the receiver is connected to.
- Consult the dealer or an experienced radio/TV technician for help.

This class B digital product meets all requirements of the Canadian Interference - Causing Equipment Regulations.

Important Safety Instructions

Read these operating instructions carefully before using the unit. Follow all the safety instructions listed below. Keep these operating instructions handy for future reference.



1. Read these instructions.
2. Keep these Instructions.
3. Heed all warnings.
4. Follow all instructions.
5. Do not use this apparatus near water.
6. Clean only with dry cloth.
7. Do not block any ventilation openings. Install in accordance with the manufacturer's instructions.
8. Do not install near any heat sources such as radiators, heat registers, stoves, or other apparatus (including amplifiers) that produce heat.
9. Do not defeat the safety purpose of the polarized or grounding-type plug. A polarized plug has two blades with one wider than the other. A grounding type plug has two blades and a third grounding prong. The wide blade or the third prong are provided for your safety. If the provided plug does not fit into your outlet, consult an electrician for replacement of the obsolete outlet.
10. Protect the power cord from being walked on or pinched particularly at plugs, near wall outlets, and the point where they exit from the apparatus.
11. Only use attachments and accessories specified by the manufacturer.
12. Use only with the cart, stand, tripod, bracket, or table specified by the manufacturer, or sold with the apparatus. When a cart is used, use caution when moving the cart/apparatus combination to avoid injury from tip-over.
13. Unplug this apparatus during lightning storms or when unused for long periods of time.
14. Refer all servicing to qualified service personnel. Servicing is required when the apparatus has been damaged in any way, such as when the power-supply cord or plug is damaged, liquid has been spilled or objects have fallen into the apparatus, the apparatus has been exposed to rain or moisture, does not operate normally, or has been dropped.



Precautions

- Ensure that the AC power in your house matches the requirements listed on the identification sticker located on the back of your product.
- Install your product horizontally, on a suitable base (furniture), with enough space around it for ventilation (3 - 4 inches/7.5 - 10 cm).
- Do not place the product on amplifiers or other equipment which may become hot. Make sure the ventilation slots are not covered.
- Do not stack anything on top of the product.
- Before moving the product, ensure the Disc Insert Slot is empty.
- To turn off the product completely, disconnect the AC plug from the wall outlet. Disconnect the AC plug from the wall outlet if you will leave the device unused for a long period of time.
- During thunderstorms, disconnect the AC plug from the wall outlet. Voltage peaks due to lightning could damage the product.
- Do not expose the product to direct sunlight or other heat sources. This could cause the product to overheat and malfunction.
- Protect the product from moisture and excess heat and equipment creating strong magnetic or electric fields (i.e. speakers.).
- Disconnect the power cable from the AC wall outlet if the product malfunctions.
- This product is for personal use only. It is not intended for industrial use.
- Condensation may occur if your product or a disc has been stored in cold temperatures. If transporting the product during the winter, wait approximately 2 hours until the product has reached room temperature before using.
- The batteries used with this product contain chemicals that are harmful to the environment. Do not dispose of batteries in the general household trash.
- Place the loudspeakers at a reasonable distance on either side of the system to ensure good stereo sound.
- Direct the loudspeakers towards the listening area.
- Do not expose this apparatus to dripping or splashing. Do not place objects filled with liquids, such as vases, on the apparatus.
- To turn this apparatus off completely, you must disconnect it from the wall outlet. Consequently, the wall outlet and power plug must be readily accessible at all times.
- Use only a properly grounded plug and receptacle.
 - An improper ground may cause electric shock or equipment damage. (Class I Equipment only.)

Disc Storage & Management

- Holding Discs
 - Fingerprints or scratches on a disc may reduce sound and picture quality or cause skipping. 
 - Avoid touching the surface of a disc where data has been recorded.
 - Hold the disc by the edges so that fingerprints will not get on the surface.
 - Do not stick paper or tape on the disc.
- Cleaning Discs
 - If you get fingerprints or dirt on a disc, clean it with a mild detergent diluted in water and wipe with a soft cloth. 
 - When cleaning, wipe gently from the inside to the outside of the disc.
- Disc Storage
 - Do not keep in direct sunlight.
 - Keep in a cool ventilated area.
 - Keep in a clean, protective jacket and store vertically.
- Condensation may form if warm air comes into contact with cold parts inside the product. When condensation forms inside the product, it may not operate correctly. If this occurs, remove the disc and let the product stand for 1 or 2 hours with the power on.

Disc and Format Compatibility

This product does not support Secure (DRM) Media files.

CD-R Discs

- Some CD-R discs may not be playable depending on the disc recording device (CD-Recorder or PC) and the condition of the disc.
- Use 650MB/74 minute CD-R discs. Do not use CD-R discs over 700MB/80 minutes as they may not be played back.
- Some CD-RW (Rewritable) media may not be playable.
- Only CD-Rs that are properly "closed" can be fully played. If the session is closed, but the disc is left open, you may not be able to fully play the disc.

MP3-CD Discs

- Only CD-R discs with MP3 files in ISO 9660 or Joliet format can be played.
- MP3 file names should contain no blank spaces or special characters (for example, . / = +).
- Use discs recorded with a compression/decompression data rate greater than 128Kbps.
- Only a consecutively written multisession disc can be played. If there is a blank segment in the Multisession disc, the disc can be played only up to the blank segment.
- If the disc is not closed, it will take longer to begin playback and not all of the recorded files may play.
- For files encoded in the Variable Bit Rate (VBR) format, (i.e. files encoded in both low bit rate and high bit rate - 32Kbps ~ 320Kbps), the sound may skip during playback.
- A maximum of 999 files can be played per CD.

Supported Audio Formats

File Extension	Audio Codec	Sampling Rate	Bit Rate
*.mp3	MPEG 1 Layer3	16KHz ~ 48KHz	80Kbps ~ 320Kbps
	MPEG 2 Layer3	16KHz ~ 48KHz	80Kbps ~ 320Kbps
	MPEG 2.5 Layer3	16KHz ~ 48KHz	80Kbps ~ 320Kbps
*.wma	Wave_Format_MSAudio1	16KHz ~ 48KHz	56Kbps ~ 128Kbps
	Wave_Format_MSAudio1	16KHz ~ 48KHz	56Kbps ~ 128Kbps

- Does not support WMA Professional codec.
- The above table shows supported sampling rates and bit rates. Files of not supported formats may not be played properly.

Contents

Thank you for buying this SAMSUNG mini-compact system.
Please take time to read these instructions.
They will allow you how to operate your system and take full advantage of its features.

Safety Warnings.....	2	Playing a USB Device.....	11
Important Safety Instructions	3	To Select a Track from	
Precautions.....	3	a USB Device	11
Disc Storage & Management	4	To Search a Folder Quickly.....	11
Disc and Format Compatibility.....	4	To Repeat	11
Supported Audio Formats	4	To Use High Speed Search.....	11
Contents.....	5	To Delete a File	11
Accessories	5	To Skip 10 Tracks	11
Description	6	Using Bluetooth.....	12
Front Panel	6	Setting the Clock	13
Rear Panel	7	Timer Function.....	13
Remote Control.....	8	Cancelling the Timer	14
Attaching the toroidal ferrite core to		Listening to Radio.....	14
the Power cable.....	8	Selecting a Stored Station	14
Display Function	8	Recording Function.....	15
CD/MP3/WMA-CD Playback.....	9	Recording Speed	15
Selecting a Track.....	9	GIGA SOUND Function.....	16
Searching for a Specific Music		Selecting EQ Mode	16
Passage on a CD	9	Selecting USER EQ Mode.....	16
Repeat One or All Tracks on a		Selecting LOCAL EQ Mode	16
Compact Disc	9	Using the FOOTBALL MODE	16
10 Skip Function.....	10	Party Function	16
CD Programming.....	10	Connecting a Microphone	17
Checking or Editing the		Troubleshooting	17
Programmed Tracks.....	10	Specifications.....	18
Auto Change Function.....	10		

Accessories

Check for the supplied accessories below.

			
FM Antenna (AH42-00021A)	User's Manual (AH68-02688D)	Remote Control/Batteries (AH59-02613B/4301-000116)	Toroidal Ferrite core (1 EA) (3301-000144)(For Power cable)

- Figures and illustrations in this User Manual are provided for reference only and may differ from actual product appearance.

Symbols

Important 

Note 

Front Panel

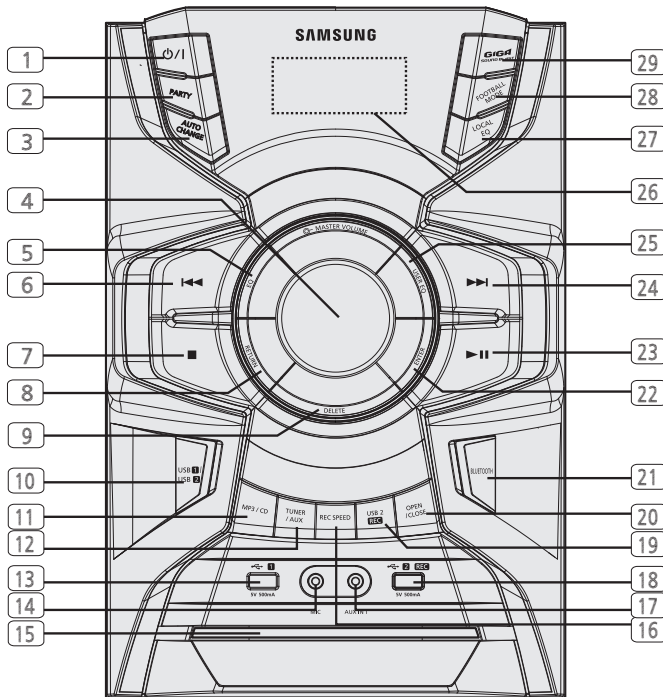

- | | |
|--|---|
| <ol style="list-style-type: none"> 1. POWER button <ul style="list-style-type: none"> • Press this button to switch your mini-compact system. 2. PARTY button 3. AUTO CHANGE button 4. MASTER VOLUME button 5. EQ button 6. Search/Skip button 7. STOP/Tuning Mode button 8. RETURN button 9. DELETE button 10. USB 1/USB 2 button 11. MP3/CD button 12. TUNER/AUX button 13. USB 1 jack 14. MIC jack 15. Disc Tray | <ol style="list-style-type: none"> 17. AUX IN 1 jack <ul style="list-style-type: none"> Connecting an External Component such as an MP3 player. <ul style="list-style-type: none"> • Connect AUX IN 1 on the front panel of the MINI COMPACT to the Audio Out of the external component/MP3 player. • Press the TUNER/AUX button to select the AUX 1 input. 18. USB 2 REC jack 19. USB 2 REC button 20. OPEN/CLOSE button 21. BLUETOOTH button 22. ENTER button 23. PLAY/PAUSE button 24. Search/Skip button 25. USER EQ button 26. Window display 27. LOCAL EQ button 28. FOOTBALL MODE button 29. GIGA SOUND BLAST button |
|--|---|

Rear Panel

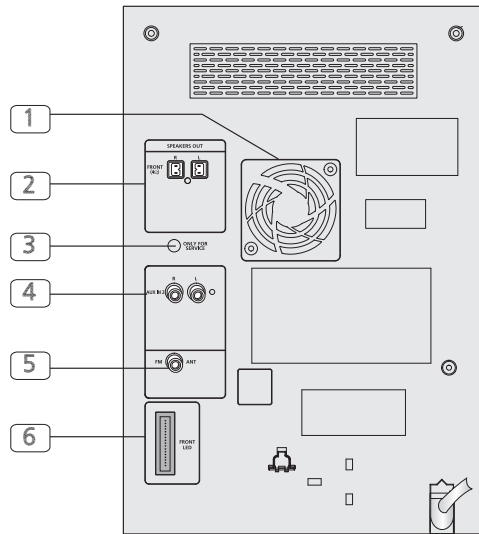

1. Cooling Fan

- The fan always turns when the power is on. Provide a minimum of 6 inches (15 cm) of clear space on all sides of the fan when you install the product.

2. 2.0 CH Speaker Connector Terminals

The speaker connector terminals are located on the rear of the system.

1. To achieve the correct sound quality, insert the speaker connector cables identified below into the correct speaker terminals on the back of the system.

- Left speaker (marked L).
- Right speaker (marked R).

3. ONLY FOR SERVICE

- This jack is for service only. Please do not use.

4. AUX IN 2 Terminals

1. Use an Audio Cable (not supplied) to connect AUX IN 2 on the product to Audio Out on an external analog component.

- Be sure to match connector colors.

- If the external analog component has only one Audio Out jack, connect to either the left or right terminal.
- Press the **TUNER/AUX** button to select the AUX 2 input.
- When the unit is in AUX mode, if none of the buttons are pushed for more than 8 hours, the power will automatically turn off.

5. FM Antenna Connector Terminal

1. Connect the FM antenna (supplied) to the FM Antenna jack.
2. Slowly move the antenna wire until you find a location where reception is good, then fasten it to a wall or other rigid surface.
3. If reception is poor, you may need to install an outdoor antenna. To do so, connect an outdoor FM antenna to FM antenna jack on the rear of the system using a 75Ω coaxial cable (not supplied).

6. LED Terminals for the Front Speakers

To enjoy the special light effect of the speakers, connect the LED cables of the Front Speakers to the LED terminals of the system.

Remote Control

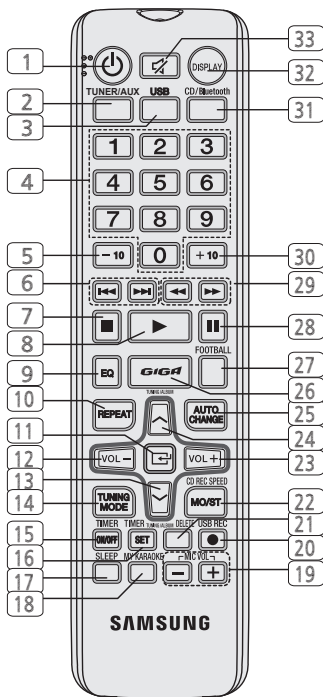

- | | | |
|--|---------------------|---|
| 1. POWER | 11. ENTER | 22. CD REC SPEED, MO/ST |
| 2. TUNER/AUX | 12. VOLUME - | 23. VOLUME + |
| 3. USB | 13. TUNING/ALBUM V | 24. TUNING/ALBUM ^ |
| 4. Number(0~9) button | 14. TUNING MODE | 25. AUTO CHANGE |
| • During playback, press the desired track number. The selected track is played. | 15. TIMER ON/OFF | 26. GIGA |
| 5. -10 | 16. TIMER SET | 27. FOOTBALL |
| 6. Skip | 17. SLEEP | • Set a sleep time to shut off the product. |
| 7. STOP | 18. MY KARAOKE | 28. PAUSE |
| 8. PLAY | 19. MIC VOLUME -, + | 29. SEARCH |
| 9. EQ | 20. USB REC | 30. +10 |
| 10. REPEAT | 21. DELETE | 31. CD/Bluetooth |
| | | 32. DISPLAY |
| | | 33. MUTE |
| | | • Turn off the sound temporarily. |

Installing batteries in the Remote Control

- Place batteries in the remote control so that the polarities (+, -) match the the diagram in the battery compartment.
- Do not dispose of batteries in a fire.
- Do not short circuit, disassemble, or overheat the batteries.
- You could cause an explosion if you replace the battery with the wrong type of battery. Replace the battery only with the same or equivalent type.
- The remote control can be used up to approximately 23 feet (7 meters) in a straight line from the unit.

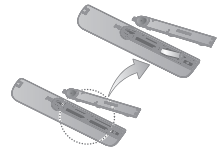

* Battery size: AAA

Attaching the toroidal ferrite core to the Power cable

If you attach a Toroidal ferrite core to the Power cable, it will help to prevent RF interference from radio signals.

1. Pull the fixing tab of the Toroidal ferrite core to open it.
2. Attach the Toroidal ferrite core to the Power cable as shown and press it until it clicks.

Installing Toroidal ferrite to Power cable

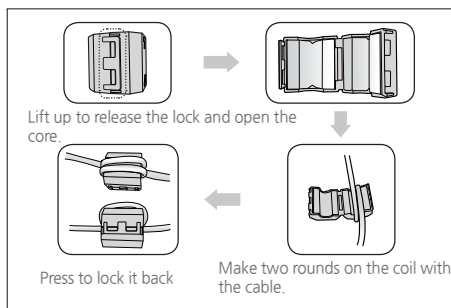

Display Function

Lets you view all functions available on the display and adjust the brightness of the display/LED.

Each time you press the **DISPLAY** button on the remote control, the display mode will change as follows:

- **The Demo function**
All functions available on the system appear on the front panel display.
- **The Dimmer function**
The Dimmer function is selected and the display darkens.
- **LED OFF**
The LEDs are turned off. However, the dimmer function continues to work.
- **Clock ON**
The Clock is displayed.
- **LED/Display ON**
The Display and all LEDs are turned on.

CD/MP3/WMA-CD Playback

Lets you play 5 inch compact discs without an adapter.

This product is designed to play audio CDs, CDs, CD-Rs, CD-RWs, or MP3/WMA-CDs.

- Gently open or close the CD tray. Do not apply excessive force.
- Do not apply force to or place a heavy object on the product.
- Do not insert an out-of-spec, shaped CD such as a heart or octangle shaped CD. You can damage the product.
- For the best sound, maintain your compact discs carefully and correctly.

1. Press the **OPEN/CLOSE** button to open the disc tray.
2. Place a disc gently into the tray with the disc's label facing up.
3. Press the **OPEN/CLOSE** button to close the disc tray. The disc will be played automatically.
 - For MP3/WMA-CD audio, it may take several minutes to finish scanning the disc tracks.
 - If you play a file with an English name or a MP3/WMA-CD medium with an English title, the song title will be shown in the display. (Other languages besides English may not be displayed.)
 - An English-titled track containing a special character will not display.

<CD/MP3/WMA-CD Playback Display>

Track Indicator — | 01:19 — Playtime Indicator

4. Adjust the volume by:
 - Tuning the **VOLUME** knob on the unit or pressing the **Vol +** or **-** button of the remote control. The volume level can be adjusted in 31 steps (**VOLUME MIN**, **VOLUME 01 - VOLUME 29**, and **VOLUME MAX**).
5. Main Unit

To pause playback temporarily, press the **▶||** button. Press **▶||** again to continue playing the disc.

Remote control

To pause playback temporarily, press the **PAUSE(II)** button. Press the **PLAY(▶)** button to continue playing the disc.
6. To end playing, press the **STOP (■)** button.

- If there is no CD inserted in the DISC tray, the unit displays "NO DISC".
- The quality of MP3/WMA-CD playback may vary depending on the condition of the disc containing the music files or the condition of the recorder with which the disc was created.
- If different types of files or unnecessary folders are on the same disc, you will have problems with playback.
- Keep the tray closed whenever you are not using it to prevent dust from entering.
- You can load or unload a compact disc when the radio, USB or auxiliary source function is selected. Also, when you press the **OPEN/CLOSE** button, the product will automatically change to the MP3/CD mode.
- If no buttons are pressed on the product or remote control for more than 3 minutes when the product is in Pause mode, the product will change to Stop mode.
- If no buttons are pressed on the product or remote control for more than 25 minutes when the product is in Stop mode or no Disc mode, the power will automatically turn off.

Selecting a Track

You can select a desired track while a disc is being played.

To play the previous track

Press the **◀◀** button within 3 seconds after the current track starts playing. Press the **◀◀** button twice, 3 seconds or more after the current track starts playing.

To play the next track

Press the **▶▶** button.

To play the current track from the beginning

Press the **◀◀** button once, 3 seconds after the current track starts playing.

To play the track of your choice

Press the **◀◀** or **▶▶** button to move to a desired track.

- You can also use the Number (0~9) buttons on the remote control to select a track.

Searching for a Specific Music Passage on a CD

When listening to a compact disc, you can quickly search for a specific music passage on a track.

To search	Press ...
Forwards	▶▶
Backwards	◀◀

You can also press and hold the **◀◀** or **▶▶** button on the main unit to automatically scan for a track.

Repeat One or All Tracks on a Compact Disc

You can play a CD, a group of tracks in a folder (MP3 only), or a single track repeatedly:

1. Press the **REPEAT** button.

Each time you press the **REPEAT** button, the repeat mode will change as follows:

MP3: OFF → TRACK → DIR → ALL → RANDOM
CD: OFF → TRACK → ALL → RANDOM

2. When you want to stop the Repeat function, press the **REPEAT** button until "OFF" is displayed.

- **OFF:** Cancels Repeat Playback.
- **TRACK:** Repeatedly plays the selected track.
- **DIR:** Repeatedly plays all tracks in the selected folder.
- **ALL:** Repeatedly plays the entire disc.
- **RANDOM:** Plays tracks in random order.

10 Skip Function

Press the **+10** or **-10** button while in playback mode.

The unit will skip as many as 10 tracks forward or 10 tracks back from the current track.

CD Programming

This function is not available during playback of an MP3/WMA-CD.

- You can program the playback order of up to 24 tracks of your choice.
- However, you must stop playing the CD before selecting tracks.

1. While in CD playback mode, press the **STOP** (■) button to stop playing the CD.
2. Press the **ENTER** (☐) button to display the message below:

PD 1 --
3. Use the **◀** or **▶** button to move to a desired track.

(01= program number, --= track number)

- Press **◀** to move to the previous track.
- Press **▶** to move to the next track.
4. Press the **ENTER** (☐) button to confirm your selection. The selection is stored and *PD 2 --* is displayed.
5. To select additional tracks, follow Steps 3 to 4 above.
6. Press the **PLAY** (▶) button to play the programmed tracks.
7. Press the **STOP** (■) button to stop playing the programmed tracks, Press the **STOP** (■) button again to cancel playing the programmed tracks.
 - If you open the disc tray or turn off the product, your programming will be canceled.

➤ In CD Program mode, if you press the **USB REC** or the **AUTO CHANGE** buttons, these functions will not work, and the unit will display "PROG".

Checking or Editing the Programmed Tracks

You can check a list of programmed tracks and edit them as you want.

1. If a programmed track is being played, press the **STOP** (■) button once.
2. Press the **ENTER** (☐) button twice to display the message below:

CD 1 02
(C=Check, 01= program number)
 - If a total of 24 tracks are already programmed, "C" will be displayed rather than "P" in the display.
3. Press the **ENTER** (☐) button repeatedly until the desired track is displayed.
4. Press the **◀** or **▶** button to select a different track.
5. Press the **ENTER** (☐) button to confirm your selection.
6. To play the programmed tracks, press the **PLAY** (▶) button.

Auto Change Function

You can play a disc followed by a USB continuously.

1. Press the **AUTO CHANGE** button.
Each time you press this button, the mode will switch as follows:

AUTO CHANGE ON → AUTO CHANGE OFF

- When the auto change mode is "ON", the unit will play the Disc → USB 1 → USB 2 continuously.
- When the auto change mode is "ON", if you press the **POWER** button, **FUNCTION** button, or the **OPEN/CLOSE** button, the auto change function automatically switches to "OFF" mode.
- When the USB is playing, if you disconnected the USB, the auto change function automatically switches to "OFF" mode.
- When the auto change mode is "ON", the unit cannot record.
- When the auto change mode is "ON", the **REPEAT** and **SLEEP** functions automatically change to OFF.
- When the auto change mode is "ON", the **CD REC SPEED**, **USB 2 REC**, **REPEAT**, **PROGRAM**, **DELETE** and **SLEEP** functions do not work, and the unit displays "AUTO CHANGE ON".
- When **DISC** play ends, if there's no **USB 1**, the unit will play music from **USB 2**.
- When **DISC** play ends, if there's no **USB 1** and **USB 2**, the unit will continue to play the disc.
- When **USB 2** play ends, if there's no **DISC**, the unit will play music from **USB 1**.

Playing a USB Device

Connect an external storage device such as a USB flash memory or external HDD (Hard Disk Drive) to the product. You can play files in MP3/WMA format.

Before you begin!

- Connect the external USB storage device to your product.
- Select the USB mode by pressing the **USB 1** or **USB 2** button on the main unit or select **USB 1** or **USB 2** by pressing the **USB** button on the remote control.
- The first track of the first directory plays automatically, in the following order:

If you select USB 1, USB 1 → STOP.

If you select USB 2, USB 2 → STOP.

➤ To stop playing

Press the **STOP** (■) button to stop playing.

➤ To remove the USB device

If you press the **STOP** (■) button once again, you can remove the USB device safely.

- ☹ Do not connect a USB recharger to the USB port of this product. You can damage the product.

To Select a Track from a USB Device

You can select an MP3 file during play.

- If you want to move to the previous/next track, press the **◀▶** buttons briefly.
 - The unit moves to the previous/next file within the directory.
 - If you press the **◀▶** buttons more times than the number of the files in the directory, the unit moves to the next directory.

To Search a Folder Quickly

1. Press the **TUNING/ALBUM** button on the remote control to move to the previous/next folder.
2. When the search is done, you will see the previous/next folder name. The track will start playing.

To Repeat

1. Press the **REPEAT** button.
Each time you press the **REPEAT** button, the repeat mode will change as follows:
OFF → **TRACK** → **DIR** → **ALL** → **RANDOM**
2. When you want to stop the Repeat function, press the **REPEAT** button until "**OFF**" is displayed.
 - **OFF**: Cancels Repeat Playback.
 - **TRACK**: Repeatedly plays the selected track.
 - **DIR**: Repeatedly plays all tracks in the selected folder.
 - **ALL**: Repeatedly plays all tracks.
 - **RANDOM**: Plays tracks in random order.

To Use High Speed Search

You can search the desired section quickly during play.

- Press the **◀▶** button.
 - Each time you press the button, you will move backward/forward fast.

- ☹ Sound does not output in fast playback mode.

To Delete a File

You can delete a file on your USB device.

1. Play a file you want to delete.
2. Press the **DELETE** button.
3. Press **◀▶** or **▶▶** to select YES.
 - To cancel the selection, press the **RETURN** button on the main unit.
4. Press the **ENTER** button.
The selected file will be deleted.

- ☹ The NTFS file system is not supported.

To Skip 10 Tracks

Press the **+10** or **-10** button while in playback mode.

The unit will skip as many as 10 tracks forward or 10 tracks back from the current track.

Read through the instructions below before using a USB device with this unit.

- Some USB devices may not work properly with this product.
- This product only supports external HDD's that are formatted in the FAT file system.
- USB 2.0 HDD's should be connected to a separate power source. Otherwise, the USB 2.0 HDD's will not work.
- If a USB external storage device is connected to multiple devices, only the MP3 files in the first HDD will be played.
- DRM-applied files are not supported. Digital Right Management restricts unauthorized access to a DRM file so that the copyright of the file is protected from piracy.
- Even if the extension of the file is .mp3, the file cannot be played if it is formatted in MPEG layer 1 or 2.
- Do not use a USB hub. USB hubs are not supported.
- The unit displays only the first 15 characters of an MP3/WMA file name.
- This device is designed to support removable HDDs with less than 160GB. Depending on the device, a removable HDD with 160GB or more may or may not be supported.
- It can take several minutes for the product to recognize the files on a USB device.
- USB devices (particularly, USB HDDs) may cause a delay when moving to the next track.
- With USB devices supporting only USB VER. 1.1, the unit may access files slowly or may not recognize file properties.
- In Stop mode, the product will turn off automatically if there is no USB device connected to the USB jack for 25 minutes.

Using Bluetooth

You can use a Bluetooth device to enjoy music with high quality stereo sound, all without wires!

What is Bluetooth?

Bluetooth technology lets Bluetooth-compliant devices interconnect easily with each other using a short, wireless connection.

- A Bluetooth device may cause noise or malfunction, depending on usage, when:
 - A part of your body comes into contact with the receiving/transmitting system of the Bluetooth device or the product.
 - It is subject to electrical variation from obstructions caused by a wall, corner, or by office partitioning.
 - It is exposed to electrical interference from same frequency-band devices including medical equipment, microwave ovens, and wireless LANs.
- Keep the Mini-compact system and the Bluetooth device close together when pairing. The greater the distance between the system and Bluetooth device, the worse the quality.
- If the distance exceeds the Bluetooth operational range, the connection is lost.
- In poor reception-sensitivity areas, the Bluetooth connection may not work properly.
- The Mini-compact system has an effective reception range of up to 33 feet (10 meters) in all directions if there are no obstacles. The connection will be automatically cut off if the Bluetooth device moves out of this range. Even within range, the sound quality may be degraded by obstacles such as walls or doors.
- This wireless device may cause electric interference during its operation.

To connect the product to a Bluetooth device

Before you begin, confirm that your Bluetooth device supports the Bluetooth-compliant stereo headset function.

1. Press the **BLUETOOTH** button on the main unit or the **CD/Bluetooth** button on the remote control to display the "BT" message.
 - You will see "BT READY" on the display.
2. Select the Bluetooth menu on the Bluetooth device you want to connect. (Refer to the Bluetooth device's user's manual.)
3. Select the Stereo headset menu on the Bluetooth device.
 - You will see a list of scanned devices.
4. Select "[Samsung] MINI xxxxxx" from the searched list.
 - When the product is connected to the Bluetooth device, the product will display "device name" → "BT" on the front display.
 - If the Bluetooth device has failed to pair with the MINI, please delete the previous "[Samsung] MINI XXXXXX" found by the Bluetooth device and have it search for the MINI again.
5. Play music on the connected device.

- You can listen to the music playing on the connected Bluetooth device over the product.
- In BLUETOOTH mode, some model's Play/Pause/Repeat/Stop/Next/Back functions are not available.
- The product only supports Middle Quality SBC data (up to 237kbps@48kHz), and does not support High Quality SBC data (328kbps@44.1kHz).
- Only one Bluetooth device can be paired at a time.
- The Mini-compact system may not search or connect properly in the following cases:
 - If there is a strong electrical field around the Mini-compact system.
 - If several Bluetooth devices are simultaneously paired with the Mini-compact system.
 - If the Bluetooth device is turned off, not in place, or malfunctions
- Note that such devices as microwave ovens, wireless LAN adaptors, fluorescent lights, and gas stoves use the same frequency range as the Bluetooth device, which can cause electric interference.

To disconnect the Bluetooth device from the Product

You can disconnect the product from the Bluetooth device. (Refer to the Bluetooth device's user's manual.)

- The product will be disconnected.
- When the product is disconnected from the Bluetooth device, the product will display "BT DISCONNECTED" → "BT READY" on the front display.

To disconnect the Product from the Bluetooth device

1. Press the **CD/Bluetooth** button on the remote control to display the "BT" message.
 - Except when you disconnect by changing functions, the connected Bluetooth device will wait a certain amount of time for a response from the product before terminating the connection. (Disconnection time may differ, depending on the Bluetooth device.)
 - The currently connected device will be disconnected.
- In Bluetooth connection mode, the Bluetooth connection will be lost if the distance between the product and the Bluetooth device exceeds the limit (33 ft./10 meters).
 - If the Bluetooth device comes back into the effective range, you can restart the product to restore the pairing with the Bluetooth device.
 - With some Bluetooth devices, some functions may not work properly.
 - In Bluetooth mode, the product will turn off automatically if there is no Bluetooth device connected to the product for 25 minutes.

Using Bluetooth Power On

When the product is turned off, you can connect your smart device to the product via Bluetooth to turn it on.

- Press and hold the CD/Bluetooth button on the remote control to use the Bluetooth Power On function.
 - Each time you press this button, the Bluetooth Power mode will change as follows: **BLUETOOTH POWER ON → BLUETOOTH POWER OFF**.
 - Set the Bluetooth Power mode to **BLUETOOTH POWER ON** by pressing this button.
- Pair your smart device with the product via Bluetooth. (For information on Bluetooth connections, refer to your smart device's manual.)
- When the product is off, and you initiate a Bluetooth connection with your smart device, the product will turn itself on automatically in Bluetooth mode.
 - Select the desired music to play from your smart device.
 - This function is available when the Bluetooth Power function is set to **BLUETOOTH POWER ON**.
 - In Bluetooth Power On or Off mode, when the CD, radio, USB or auxiliary source function is selected, if you connect your smart device to the product via Bluetooth, the product will automatically change to the Bluetooth mode.
 - The Bluetooth Power mode setting is retained after you turn the Mini off.

Setting the Clock

During each step, you have a few seconds to set the required options. If you exceed this time, you must start again.

- Switch the system on by pressing the **POWER** (⏻/⏻) button.
- Press the **TIMER SET** button and then press the **ENTER** (⏻) button, "CLOCK" is displayed.
- Press the **ENTER** (⏻) button. The hour flashes.
 - To increase the hours, press: **▲**
 - To decrease the hours, press: **▼**
- When the correct hour is displayed, press the **ENTER** (⏻) button. The minutes flash.
 - To increase the minutes, press: **▲**
 - To decrease the minutes, press: **▼**
- When the correct minute is displayed, press the **ENTER** (⏻) button. "⏻ TIME" appears in the display.
 - The current time is now set.
 - You can display the time, even when you are using another function, by pressing the **TIMER SET** button once.
 - You can also use the **▶▶** or **◀◀** on the front panel instead of the **TUNING/ALBUM ▲** or **▼** button in Steps 3 and 4.

Timer Function

The timer enables you to switch the system on or off at specific times automatically.

- Before setting the timer, confirm that the current time is correct.
- During each step, you have a few seconds to set the required options. If you exceed this time, you must start again.
- If you no longer want the system to be switched on or off automatically, you must cancel the timer by pressing the **TIMER ON/OFF** button.

Example: You want to wake up to music every morning.

- Switch the system on by pressing the **POWER** (⏻/⏻) button.
- Press the **TIMER SET** button until **⏻ TIME** is displayed.
- Press the **ENTER** (⏻) button.

Result: **ON** is displayed for a few seconds. You can set the timer switch-on time.
- Set the timer switch-on time.
 - Press the **TUNING/ALBUM ▲** or **▼** button to set the hours.
 - Press the **ENTER** (⏻) button.

Result: The minutes flash.
 - Press the **TUNING/ALBUM ▲** or **▼** button to set the minutes.
 - Press the **ENTER** (⏻) button.

Result: **OFF** is displayed for a few seconds. You can now set the timer switch-off time.
- Set the timer switch-off time.
 - Press the **TUNING/ALBUM ▲** or **▼** button to set the hours.
 - Press the **ENTER** (⏻) button.

Result: The minutes flash.
 - Press the **TUNING/ALBUM ▲** or **▼** button to set the minutes.
 - Press the **ENTER** (⏻) button.



Result: **VOL XX** is displayed, where **XX** corresponds to the volume already set.
- Press the **TUNING/ALBUM ▲** or **▼** button to adjust the volume level, and then press the **ENTER** (⏻) button.



Result: The source to be selected is displayed.
- Press the **TUNING/ALBUM ▲** or **▼** button to select the desired source to be played when the system switches on.





If you select...	You must also...
FM (radio)	<ol style="list-style-type: none"> Press the ENTER (⏻) button. Select a preset station by pressing the TUNING/ALBUM ▲ or ▼ button.
CD/MP3 (compact disc)	Load one compact disc.
USB	Connect the USB device.

- Press the **ENTER** (⏻) button.

Result: **CHKREC** (Do you want to record?) is displayed.



9. Press the **ENTER** () button.
Result: **REC N** is displayed. You can press the **TUNING/ALBUM**  or  button to select **REC Y** or **REC N**, and then press **ENTER** () button.

1. If you select **REC N**, the Mini will not record when it turns on. If you have already set a tuner timer recording, selecting **REC N** cancels it. Note that the Mini will still turn on and off at the times you set earlier in this procedure.
2. If you select the **REC Y**, you can set the Mini to record when it turns on. The recording switch on and switch off times can be different from the timer switch on and off times you set earlier in this procedure.
 - a. Press the **ENTER** () button.
Result: **ON** is displayed for a few seconds. You can set the tuner timer recording switch-on time.
 - b. Press the **ENTER** () button.
Result: **OFF** is displayed for a few seconds. You can set the tuner timer recording switch-off time.

- The maximum tuner timer recording time is 5 hours.
- If the timer switch on and off times are identical, the word **ERROR** is displayed.
- When there is no disc in or USB connected to the Mini, if you select the "CD" or "USB", the Mini automatically selects "TUNER".
- You may use the  ,  buttons on the main unit instead of the **TUNING/ALBUM**  or  button to adjust settings in Steps 4 through 9.
- If the switch-on or -off time is the same as the timer recording time, only the switch-on or -off time is effective, and the timer recording time is not applied.
- If the auto timer is turned on, the MP3/CD or USB function may require an additional step to be activated depending on the disc (or device). It is better for you to select the tuner function instead.

Canceling the Timer

After you have set the timer, the unit will start automatically at the time shown by the **TIMER** indication on the display. If you no longer want to use the timer, you must cancel it.

To	Press the TIMER ON/OFF button....
Cancel the timer	Once. Result:  is no longer displayed.
Restart the timer	Twice. Result:  is displayed again.

- When you select the **TIMER OFF** mode, the **TIMER RECORDING** and **TIMER** function are not available.





Listening to Radio

You can store up to:
15 FM stations.





1. Select **FM** by pressing the **TUNER/AUX** button.

2.

To search for a station	Press the TUNING MODE button
Preset	One or more times until PRESET is displayed. You can search the stored frequencies in the Preset mode.
Manually	One or more times until MANUAL is displayed. You can search the frequencies one by one in the Manual mode.





3. Select the station to be stored by:
 - Pressing the **TUNING/ALBUM**  or  button on the remote control to select the preset station.
 - Press and hold the **TUNING/ALBUM**  or  button on the remote control to automatically search for active broadcasting stations.
4. Press the **MO/ST** button to switch between stereo and mono.
 - In a poor reception area, select **MONO** for a clear, interference-free broadcast.
 - This applies only when listening to an FM station.
5. If you do not want to store the radio station found, return to Step 3 and search for another station.
Otherwise:
 - a. Press the **ENTER** button.
 - b. Or, press the **TUNING/ALBUM** button on the remote control to select a program number.
 - c. Press the **ENTER** button to save the preset.
6. To store additional radio frequencies, repeat Steps 3 through 5.

➤ In **Tuner mode**

- In the Manual mode, you can use the  or  button on the main unit to manually search for a radio station.
- In the Preset mode, you can use the  or  button on the main unit to search for a stored radio station.

Selecting a Stored Station

You can listen to a stored radio station.



1. Select **FM** by pressing the **TUNER/AUX** button.
2. Press the **TUNING MODE** button on the remote control until "PRESET" is displayed.
3. Press the  or  button on the main unit or the **TUNING/ALBUM**  or  on the remote control to select a desired preset number.

Recording Function

You can record from a CD, radio broadcast, or an external source to a USB storage device.

1. Connect an external USB storage device to the USB 2 ( **REC**) jack on your product.
2. Play a disc, tune to a station, or connect an external source to your product.

CD

- Press the **MP3/CD** button on the main unit to select the CD function.
- Press the **OPEN/CLOSE** button to open the disc tray.
- Insert a CD and press the **OPEN/CLOSE** button to close the disc tray.
- Use the CD selection buttons ( or ) to select the desired song.

Tuner

- Select TUNER by pressing the **TUNER/AUX** button.
- Tune to a station you want to record.

External Source

- Connect an External Component/MP3 player to your product.
- Press the **TUNER/AUX** button to select <AUX> input.
- Play a song from the external device.

USB 1

- Connect a USB device to the USB 1 jack of your product
- Press the **USB 1** button to select USB 1.
- Play a song from USB 1.

3. Press the **USB REC** button on the remote control or the **USB 2 REC** button on the main unit to start recording.

CD

- "TRACK RECORDING" is displayed and CD recording starts.
- Press and hold the **USB REC** button on the remote control or press and hold the **USB 2 REC** button on the main unit to start recording all tracks on the disc. "FULL CD RECORDING" is displayed.

MP3-CD, USB 1

- Press the **USB REC** button. The currently playing file is copied onto the USB device.
- Press and hold the **USB REC** button. All the files in the current folder are copied onto the USB device.
- If you connect a microphone and press the **USB REC** button, the currently playing file and the sound from the microphone is recorded onto the USB device.
MP3 RECORDING: "MP3 RECORDING" → "RECORD"
CD COPY: "CHECK" → "START" → "COPY XX" → "COPY END" is displayed. When the recording is done, "STOP" will be displayed.
- If there is a duplicate file name, "FILE EXIST" is displayed, and the function is canceled.

Tuner /External Source

- RECORD is displayed.

4. To stop recording, press the **STOP** () button. The unit automatically creates and saves recorded files in .MP3 format (SAM-XXXX.MP3).

5. To remove the USB device safely, press the **STOP** () button once again. After recording, a directory named "RECORDING(DISCxxxx)" (FULL CD RECORDING), "RECORDING"(TRACK RECORDING), "CD COPY"(MP3 CD/USB), "MP3 RECORDING"(MP3 CD), "TUNER RECORDING" or "AUX RECORDING" is created on your USB device.

- Do not disconnect the USB device or the AC Cord during recording as this may cause damage to the file.
- WMA/MP2 files can be copied but not recorded.
- If you disconnect the USB device during a recording, the unfinished recording file may get damaged and cannot be deleted. If this occurs, please connect the USB device to a PC and backup the data stored in the USB first, and then format it.
- When the USB memory has insufficient free space, the system will display "NOT ENOUGH MEMORY".
- The USB device or HDD you are recording to must be formatted in the FAT file system. The NTFS file system is not supported.
- When you use the CD high speed search function, CD recording is not available.
- The recording time may be longer with some USB devices.
- In the program mode, you can't use the CD recording function.
- The equalizer is set to "OFF" automatically and is not available during a CD recording.
- The GIGA SOUND function is set to "OFF" automatically and is not available during a CD recording.
- The REPEAT function is set to "OFF" automatically and is not available during a CD recording.
- If you use the MIC function during a CD recording, the sound from the microphone will be recorded.
- Note that setting the input level too loud when recording music from an external device through the AUX or USB channel may cause noise in the recording. If this occurs, lower the external device's volume level.
- The maximum TUNER/AUX recording time is 5 hours.

Recording Speed

You can select the recording speed before recording.

Each time you press the **CD REC SPEED** button on the remote control or the **REC SPEED** button on the main unit, the recording speed will change as follows:

RECORD SPD X 1 → RECORD SPD X 4

- When you record from the tuner or an external source, you cannot change the recording speed.
- If you select RECORD SPD X 4, sound is not produced during the recording.
- If you connected the microphone, you have one recording speed mode available: RECORD SPD X 1.
- During recording, if you disconnect the microphone, the recording will stop. If you reconnect the microphone, the recording will not restart.

GIGA SOUND Function

The GIGA SOUND function amplifies the bass sound and provides twice the bass for powerful, realistic sound.

1. Press the **GIGA SOUND BLAST** button on the main unit or the **GIGA** button on the remote control. Each time you press this button, the sound changes as follows:
OFF → GIGA SOUND BLAST
2. To cancel this function, press the **GIGA SOUND BLAST** button until "OFF" is displayed.

Selecting EQ Mode

Your mini-compact system provides predefined equalizer settings that are optimized for particular music genre. You can also adjust the bass, middle and treble levels manually.

1. Press the **EQ** button.
Each time you press this button, the sound mode changes as follows:
OFF→FLAT→RANCHERA→CUMBIA→REGGAE
→MERENGUE→SALSA→REGGATON→FOLKLORE
→PARTY→POP→HIP HOP→ROCK→JAZZ
→CLASSIC→ELECTRONIC→MP3 ENHANCER
→VIRTUAL SOUND→U B O
 2. To set the BASS, MIDDLE, TREBLE level manually:
Press the **ENTER** button when you select U B O.
Result: The BASS level flashes.
Press the **TUNING/ALBUM** ▲ or ▼ button to select a level from -06 to 06.
Press the **ENTER** button.
Result: The MIDDLE level flashes.
Press the **TUNING/ALBUM** ▲ or ▼ button to select a level from -06 to 06.
Press the **ENTER** button.
Result: The TREBLE level flashes.
Press the **TUNING/ALBUM** ▲ or ▼ button to select a level from -06 to 06.
Press the **ENTER** button.
Result: Setting is complete.
- The equalizer is set to "OFF" automatically and is not available during a CD recording.

Selecting USER EQ Mode

You can directly select the user EQ mode by pressing the **USER EQ** button.

1. Press the **USER EQ** button on the main unit until the required option is selected.
Each time you press this button, the sound mode changes as follows: **OFF → U B O**
 2. Refer to Step 2 above to set the BASS, MIDDLE, and TREBLE levels.
- The equalizer is set to "OFF" automatically and is not available during a CD recording.
- If no buttons are pressed within 4 seconds, your settings will automatically be cancelled and the previous settings will be saved.

Selecting LOCAL EQ Mode

You can select the **LOCAL EQ** mode directly by pressing the **LOCAL EQ** button.

1. Press the **LOCAL EQ** button on the main unit until the required option is selected.
Each time you press this button, the sound mode changes as follows:
OFF→FLAT→RANCHERA→CUMBIA→REGGAE
→MERENGUE→SALSA→REGGATON→FOLKLORE
- The Local equalizer is set to "OFF" automatically and is not available during a CD recording.

Using the FOOTBALL MODE

The football mode brightens the audio you are listening to and brings greater realism to sports broadcasts.

1. Press the **FOOTBALL MODE** button.
Each time you press this button, the sound mode changes as follows:
OFF → ANNOUNCER → STADIUM
2. To cancel this function, press the **FOOTBALL MODE** button until "OFF" is displayed.

Party Function

You can choose a desired party mode.

1. Press the **PARTY** button. Each time you press the button, the party mode changes as following:
PARTY 1 → PARTY 2 → PARTY 3 → OFF

Connecting a Microphone

You can insert a microphone to sing along with your favorite CDs.

1. Connect a mono microphone (3.5ø) to the MIC jack on the front of the product.
2. Press the **MIC VOL-**, **+** button to adjust the volume of the microphone.
3. Press the **MY KARAOKE** button to turn My Karaoke on and off. Each time the button is pressed, the selection changes as follows: ON → OFF.
 - If you hear strange noises (squealing or howling) while using the Karaoke feature, move the microphone away from the speakers. Turning down the microphone's volume or the speaker volume is also effective.
 - The microphone does not operate in the AUX or TUNER modes.
 - If you connect a microphone, GIGA SOUND will automatically turn off. When you remove the microphone, it will remain off. You must turn it on again manually.
 - When My Karaoke is on, EQ/LOCAL EQ/USER EQ/FOOTBALL MODE/GIGA SOUND do not work.
 - The system does not retain the My Karaoke setting after you turn My Karaoke off.
 - Use a mono microphone. If you connect a stereo microphone to the unit, the microphone might not work properly.
 - The MY KARAOKE function is available only when you have connected a Microphone to the unit.

Troubleshooting

Refer to the chart below when this unit does not function properly. If the problem you are experiencing is not listed below or if the instructions below do not help, turn off the unit, disconnect the power cord, and contact the nearest authorized dealer or Samsung Electronics Service Center.

Symptom	Check/Remedy
I cannot eject the disc.	<ul style="list-style-type: none"> • Is the power cord plugged securely into the outlet? • Turn off the power and then turn it back on.
Playback does not start immediately when the Play/Pause button is pressed.	<ul style="list-style-type: none"> • Are you using a deformed disc or a disc with scratches on the surface? • Wipe the disc clean.
No sound.	<ul style="list-style-type: none"> • The unit does not produce sound during fast playback and slow playback. • Are the speakers connected properly? • Is the disc severely damaged?
The remote control does not work.	<ul style="list-style-type: none"> • Is the remote control being operated within its operational angle and distance range? • Are the batteries drained?
<ul style="list-style-type: none"> • The product is not working. (Example: The power goes out or the front panel key doesn't work or you hear a strange noise.) • The product is not working normally. 	<ul style="list-style-type: none"> • Reset the unit: With no disc inserted and the "NO DISC" message on the display of the product, press and hold the STOP (■) button on the main unit for longer than 5 seconds. <p>Using the RESET function will erase all stored settings. Do not use this unless necessary.</p>
Can't receive radio broadcast.	<ul style="list-style-type: none"> • Is the antenna connected properly? • If the antenna's input signal is weak, install an external FM antenna in an area with good reception.

Specifications

General	Power Requirements	AC 120V~60Hz
	Power Consumption	140 W
	Weight	8.60 lbs (3.9 Kg)
	Dimensions	9.17 (W) x 13.82 (H) x 11.81 (D) inches (233 (W) x 351 (H) x 300 (D) mm)
	Operating Temperature Range	+41°F~+95°F (+5°C~+35°C)
FM Tuner	Operating Humidity Range	10 % to 75 %
	Signal/noise ratio	55 dB
	Usable sensitivity	12 dB
CD Disc	Total harmonic distortion	0.6 %
	CD : 5 inches (COMPACT DISC)	Reading Speed : 4.8 ~ 5.6 m/sec. Maximum Play Time : 74 min.
Amplifier		MX-H835- 1200 Watts (MAX)
	Front speaker output	600 W/CH (4 Ω/100 Hz)
	Frequency range	20 Hz~20 KHz
	S/N Ratio	75 dB
	Channel separation	50 dB
	Input sensitivity	(AUX 1) 1200 mV (AUX 2) 2000 mV

*: Nominal specification

- Samsung Electronics Co., Ltd reserves the right to change the specifications without notice.
- Weight and dimensions are approximate.
- Design and specifications are subject to change without prior notice.
- For information on the power supply and power consumption, refer to the label attached to the product.

Important Note About Service

- An administration fee may be charged if either:
 - a. An engineer is called out at your request and there is no defect in the product.
 - b. You bring the unit to a repair center and there is no defect in the product.
- You will be advised of the amount of the administration fee before any work is done or a home visit is made.
- If you have a problem with this product, we strongly recommend you read the appropriate section of this manual, review the Troubleshooting section on page 16, visit the Support page for your product at www.samsung.com, and call Samsung Product Support (1-800-726-7864) to find an answer before you contact a service center for a repair.

LIMITED WARRANTY TO ORIGINAL PURCHASER

This SAMSUNG brand product, as supplied and distributed by SAMSUNG and delivered new, in the original carton to the original consumer purchaser, is warranted by SAMSUNG against manufacturing defects in materials and workmanship for a limited warranty period of:

One (1) Year Parts and Labor* (*90 Days Parts and Labor for Commercial Use)

This limited warranty begins on the original date of purchase, and is valid only on products purchased and used in the United States. To receive warranty service, the purchaser must contact SAMSUNG for problem determination and service procedures. Warranty service can only be performed by a SAMSUNG authorized service center. The original dated bill of sale must be presented upon request as proof of purchase to SAMSUNG or SAMSUNG's authorized service center. Transportation of the product to and from the service center is the responsibility of the purchaser.

SAMSUNG will repair or replace this product, at our option and at no charge as stipulated herein, with new or reconditioned parts or products if found to be defective during the limited warranty period specified above. All replaced parts and products become the property of SAMSUNG and must be returned to SAMSUNG. Replacement parts and products assume the remaining original warranty, or ninety (90) days, whichever is longer.

SAMSUNG's obligations with respect to software products distributed by SAMSUNG under the SAMSUNG brand name are set forth in the applicable end user license agreement. Non-SAMSUNG hardware and software products, if provided, are on an "AS IS" basis. Non-SAMSUNG manufacturers, suppliers, publishers, and service providers may provide their own warranties.

This limited warranty covers manufacturing defects in materials and workmanship encountered in normal, and except to the extent otherwise expressly provided for in this statement, noncommercial use of this product, and shall not apply to the following, including, but not limited to: damage which occurs in shipment; delivery and installation; applications and uses for which this product was not intended; altered product or serial numbers; cosmetic damage or exterior finish; accidents, abuse, neglect, fire, water, lightning or other acts of nature; use of products, equipment, systems, utilities, services, parts, supplies, accessories, applications, installations, repairs, external wiring or connectors not supplied and authorized by SAMSUNG, or which damage this product or result in service problems; incorrect electrical line voltage, fluctuations and surges; customer adjustments and failure to follow operating instructions, cleaning, maintenance and environmental instructions that are covered and prescribed in the instruction book; product removal or reinstallation; reception problems and distortion related to noise, echo, interference or other signal transmission and delivery problems. SAMSUNG does not warrant uninterrupted or error-free operation of the product.

THERE ARE NO EXPRESS WARRANTIES OTHER THAN THOSE LISTED AND DESCRIBED ABOVE, AND NO WARRANTIES WHETHER EXPRESS OR IMPLIED, INCLUDING, BUT NOT LIMITED TO, ANY IMPLIED WARRANTIES OF MERCHANTABILITY OR FITNESS FOR A PARTICULAR PURPOSE, SHALL APPLY AFTER THE EXPRESS WARRANTY PERIODS STATED ABOVE, AND NO OTHER EXPRESS WARRANTY OR GUARANTY GIVEN BY ANY PERSON, FIRM OR CORPORATION WITH RESPECT TO THIS PRODUCT SHALL BE BINDING ON SAMSUNG. SAMSUNG SHALL NOT BE LIABLE FOR LOSS OF REVENUE OR PROFITS, FAILURE TO REALIZE SAVINGS OR OTHER BENEFITS, OR ANY OTHER SPECIAL, INCIDENTAL OR CONSEQUENTIAL DAMAGES CAUSED BY THE USE, MISUSE OR INABILITY TO USE THIS PRODUCT, REGARDLESS OF THE LEGAL THEORY ON WHICH THE CLAIM IS BASED, AND EVEN IF SAMSUNG HAS BEEN ADVISED OF THE POSSIBILITY OF SUCH DAMAGES. NOR SHALL RECOVERY OF ANY KIND AGAINST SAMSUNG BE GREATER IN AMOUNT THAN THE PURCHASE PRICE OF THE PRODUCT SOLD BY SAMSUNG AND CAUSING THE ALLEGED DAMAGE. WITHOUT LIMITING THE FOREGOING, PURCHASER ASSUMES ALL RISK AND LIABILITY FOR LOSS, DAMAGE OR INJURY TO PURCHASER AND PURCHASER'S PROPERTY AND TO OTHERS AND THEIR PROPERTY ARISING OUT OF THE USE, MISUSE OR INABILITY TO USE THIS PRODUCT SOLD BY SAMSUNG NOT CAUSED DIRECTLY BY THE NEGLIGENCE OF SAMSUNG. THIS LIMITED WARRANTY SHALL NOT EXTEND TO ANYONE OTHER THAN THE ORIGINAL PURCHASER OF THIS PRODUCT, IS NONTRANSFERABLE AND STATES YOUR EXCLUSIVE REMEDY.

Some states do not allow limitations on how long an implied warranty lasts, or the exclusion or limitation of incidental or consequential damages, so the above limitations or exclusions may not apply to you. This warranty gives you specific legal rights, and you may also have other rights which vary from state to state.

To obtain warranty service, please contact SAMSUNG customer care center.



QUESTIONS OR COMMENTS?

Area	CALL	OR VISIT US ONLINE AT	WRITE
IN THE US	1-800-SAMSUNG (726-7864)	www.samsung.com/us/ support	Samsung Electronics America, Inc. 85 Challenger Road Ridgefield Park, NJ 07660