

## HOME AUDIO SYSTEM

### Operating Instructions

---

Getting Started

---

Disc/USB Playback

---

USB Transfer

---

Tuner

---

*Bluetooth*

---

Sound Adjustment

---

Other Operations

---

Additional Information

---

## WARNING

### To reduce the risk of fire or electric shock, do not expose this apparatus to rain or moisture.

To reduce the risk of fire, do not cover the ventilation opening of the appliance with newspapers, tablecloths, curtains, etc. Do not expose the appliance to naked flame sources (for example, lighted candles). To reduce the risk of fire or electric shock, do not expose this appliance to dripping or splashing, and do not place objects filled with liquids, such as vases, on the appliance. As the main plug is used to disconnect the unit from the mains, connect the unit to an easily accessible AC outlet. Should you notice an abnormality in the unit, disconnect the main plug from the AC outlet immediately.

Do not install the appliance in a confined space, such as a bookcase or built-in cabinet. Do not expose batteries or appliances with battery-installed to excessive heat, such as sunshine and fire.

The unit is not disconnected from the mains as long as it is connected to the AC outlet, even if the unit itself has been turned off. This equipment has been tested and found to comply with the limits set out in the EMC Directive using a connection cable shorter than 3 meters.

## CAUTION

The use of optical instruments with this product will increase eye hazard.



This appliance is classified as a CLASS 1 LASER product. This marking is located on the rear exterior.

When unpacking or handling a big and/or heavy speaker, be sure to handle the unit with two or more persons. Dropping the unit may cause personal injury and/or property damage.

## FOR UNITED STATES CUSTOMERS. NOT APPLICABLE IN CANADA, INCLUDING IN THE PROVINCE OF QUEBEC.

## POUR LES CONSOMMATEURS AUX ÉTATS-UNIS. NON APPLICABLE AU CANADA, Y COMPRIS LA PROVINCE DE QUÉBEC.

## For the customers in the USA

### Owner's Record

The model and serial numbers are located on the rear of the unit. Record these numbers in the space provided below. Refer to them whenever you call upon your Sony dealer regarding this product.

Model No. \_\_\_\_\_

Serial No. \_\_\_\_\_



This symbol is intended to alert the user to the presence of uninsulated “dangerous voltage” within the product’s enclosure that may be of sufficient magnitude to constitute a risk of electric shock to persons.



This symbol is intended to alert the user to the presence of important operating and maintenance (servicing) instructions in the literature accompanying the appliance.

## Important Safety Instructions

- 1) Read these instructions.
- 2) Keep these instructions.
- 3) Heed all warnings.
- 4) Follow all instructions.
- 5) Do not use this apparatus near water.
- 6) Clean only with dry cloth.
- 7) Do not block any ventilation openings. Install in accordance with the manufacturer's instructions.
- 8) Do not install near any heat sources such as radiators, heat registers, stoves, or other apparatus (including amplifiers) that produce heat.
- 9) Do not defeat the safety purpose of the polarized or grounding-type plug. A polarized plug has two blades with one wider than the other. A grounding type plug has two blades and a third grounding prong. The wide blade or the third prong are provided for your safety. If the provided plug does not fit into your outlet, consult an electrician for replacement of the obsolete outlet.
- 10) Protect the power cord from being walked on or pinched particularly at plugs, convenience receptacles, and the point where they exit from the apparatus.
- 11) Only use attachments/accessories specified by the manufacturer.

- 12) Use only with the cart, stand, tripod, bracket, or table specified by the manufacturer, or sold with the apparatus. When a cart is used, use caution when moving the cart/apparatus combination to avoid injury from tip-over.



- 13) Unplug this apparatus during lightning storms or when unused for long periods of time.
- 14) Refer all servicing to qualified service personnel. Servicing is required when the apparatus has been damaged in any way, such as power-supply cord or plug is damaged, liquid has been spilled or objects have fallen into the apparatus, the apparatus has been exposed to rain or moisture, does not operate normally, or has been dropped.

### NOTE:

This equipment has been tested and found to comply with the limits for a Class B digital device, pursuant to Part 15 of the FCC Rules. These limits are designed to provide reasonable protection against harmful interference in a residential installation. This equipment generates, uses and can radiate radio frequency energy and, if not installed and used in accordance with the instructions, may cause harmful interference to radio communications. However, there is no guarantee that interference will not occur in a particular installation. If this equipment does cause harmful interference to radio or television reception, which can be determined by turning the equipment off and on, the user is encouraged to try to correct the interference by one or more of the following measures:

- Reorient or relocate the receiving antenna.

- Increase the separation between the equipment and receiver.
- Connect the equipment into an outlet on a circuit different from that to which the receiver is connected.
- Consult the dealer or an experienced radio/TV technician for help.

## CAUTION

You are cautioned that any changes or modifications not expressly approved in this manual could void your authority to operate this equipment.

Properly shielded and grounded cables and connectors must be used for connection to host computers and/or peripherals in order to meet FCC emission limits.

## Compact Disc Receiver (HCD-GPX888/HCD-GPX555)

This equipment must not be co-located or operated in conjunction with any other antenna or transmitter.

This equipment complies with FCC radiation exposure limits set forth for an uncontrolled environment and meets the FCC radio frequency (RF) Exposure Guidelines in Supplement C to OET65. This equipment has very low levels of RF energy that it deemed to comply without maximum permissive exposure evaluation (MPE). But it is desirable that it should be installed and operated keeping the radiator at least 20 cm or more away from person's body (excluding extremities: hands, wrists, feet and ankles).

## For customers in Australia



**Disposal of Old Electrical & Electronic Equipment (Applicable in the European Union and other European countries with separate collection systems)**

## License and Trademark Notice

- “WALKMAN” and “WALKMAN” logo are registered trademarks of Sony Corporation.
- MPEG Layer-3 audio coding technology and patents licensed from Fraunhofer IIS and Thomson.
- Windows Media is either a registered trademark or trademark of Microsoft Corporation in the United States and/or other countries.
- This product is protected by certain intellectual property rights of Microsoft Corporation. Use or distribution of such technology outside of this product is prohibited without a license from Microsoft or an authorized Microsoft subsidiary.
- The *Bluetooth*<sup>®</sup> word mark and logos are registered trademarks owned by Bluetooth SIG, Inc. and any use of such marks by Sony Corporation is under license. Other trademarks and trade names are those of their respective owners.
- The N Mark is a trademark or registered trademark of NFC Forum, Inc. in the United States and in other countries.
- Android<sup>™</sup> is a trademark of Google Inc.
- Google Play<sup>™</sup> is a trademark of Google Inc.

- iPhone and iPod touch are trademarks of Apple Inc., registered in the U.S. and other countries. App Store is a service mark of Apple Inc.
- “Made for iPod” and “Made for iPhone” mean that an electronic accessory has been designed to connect specifically to iPod or iPhone, respectively, and has been certified by the developer to meet Apple performance standards. Apple is not responsible for the operation of this device or its compliance with safety and regulatory standards. Please note that the use of this accessory with iPod or iPhone may affect wireless performance.
- All other trademarks and registered trademarks are of their respective holders. In this manual, ™ and ® marks are not specified.

---

## About this manual

The instructions in this manual are for models MHC-GPX888, LBT-GPX555 and MHC-GPX555.

In this manual, the MHC-GPX888 is used for illustration purpose unless stated otherwise.

### **The MHC-GPX888 consists of:**

- Unit HCD-GPX888 (1)
- Speaker system
  - Front speaker SS-GPX888 (2)
  - Subwoofer SS-WGP888 (2)

### **The LBT-GPX555/MHC-GPX555 consists of:**

- Unit HCD-GPX555 (1)
- Speaker system
  - Front speaker SS-GPX555 (2)
  - Subwoofer SS-WGP555 (1)

---

# Table of Contents

About this manual .....	5
Guide to parts and controls.....	8

---

## Getting Started

Hooking up the system securely .....	11
Positioning the speakers .....	13
Setting the clock .....	15
Changing the display mode .....	15

---

## Disc/USB Playback

Playing a disc.....	16
Before using a USB device with this system .....	16
Playing a USB device.....	17
Searching for a track or audio file (Track Search).....	17
Using play mode.....	18

---

## USB Transfer

Transferring music.....	19
-------------------------	----

---

## Tuner

Listening to the radio.....	22
-----------------------------	----

---

## Bluetooth

About the <i>Bluetooth</i> wireless technology .....	23
Setting the <i>Bluetooth</i> audio codecs .....	24
Connecting a smartphone with one touch (NFC).....	24
Listening to music wirelessly on a <i>Bluetooth</i> device .....	25
Setting the <i>Bluetooth</i> standby mode .....	27
Setting the <i>Bluetooth</i> signal.....	27
Using “SongPal” via <i>Bluetooth</i> .....	28

---

## Sound Adjustment

Adjusting the sound .....	28
Selecting the Virtual Football mode .....	29
Creating your own sound effect .....	29
Creating a party atmosphere (DJ EFFECT).....	30

---

## Other Operations

Using the Party Chain function .....	30
Singing along .....	32
Changing the spectrum pattern of the display panel .....	33
Viewing information in the display panel .....	33
Changing the illumination pattern and color .....	33
Using the timers .....	33
Using optional equipment .....	34
Deactivating the buttons on the unit (Child Lock).....	35
Setting the automatic standby function .....	35

---

## Additional Information

Playable discs .....	36
Websites for compatible devices.....	36
Troubleshooting .....	37
Messages .....	42
Precautions .....	43
Specifications .....	44

# Guide to parts and controls

This manual mainly explains operations using the remote control, but the same operations can also be performed using the buttons on the unit having the same or similar names.

## Unit

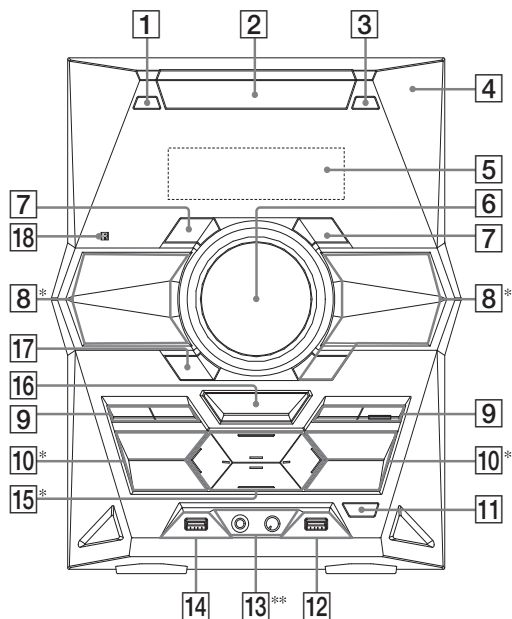

\* When pressing the buttons on the unit, press on the printings of the buttons.

\*\* MHC-GPX888 only.

## Remote control RM-AMU199

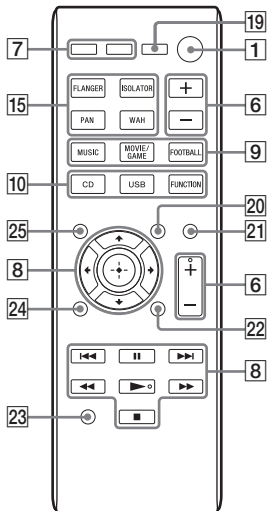

- 1 **I/O (on/standby)**  
Turn on the system, or set it to standby mode.
- 2 **Disc tray**
- 3 **▲ OPEN/CLOSE**  
Insert or eject a disc.
- 4 **N (N-Mark) (page 24)**  
Near Field Communication (NFC) touchpoint indication.
- 5 **Display panel**
- 6 **Unit: VOLUME / DJ CONTROL**  
Adjust the volume.  
Adjust the DJ EFFECT level (page 30).  
You cannot use this knob to adjust the volume when the DJ EFFECT is activated.  
**Remote control: DJ CONTROL +/-**  
Adjust the DJ EFFECT level.

**Remote control: VOLUME +/-\***  
Adjust the volume.

- 7 **LED COLOR (page 33)**  
Change the illumination color on the speakers and the unit.

**LED PATTERN (page 33)**  
Change the illumination pattern on the speakers and the unit.

- 8 **↕/↔/↔/↕**  
Select the menu items.

**Remote control: PRESET +/-**  
Select a preset station during TUNER function.

**📁 +/- (select folder)**  
Select a folder on an MP3 disc or a USB device.  
Unit only: Select a preset station during TUNER function.

**◀◀/▶▶ (rewind/fast forward)**  
Hold down to find a point in a track or file during playback.

**◀◀/▶▶ (go back/go forward)**  
Select a track or file.

**TUNING +/-**  
Tune to the station you want during TUNER function.

**■ (stop)**  
Stop playback.  
Press twice to cancel resume playback of the USB device.

**Unit: ENTER**  
**Remote control: ⊕**  
Enter the settings.

**Unit: ▶▶ || (play/pause)**  
**Remote control: ▶▶ (play)\*, || (pause)**  
Start or pause playback.  
To resume playback, press ▶▶ || or ▶▶.

**9 MUSIC, MOVIE/GAME**

Select the preset sound effect (page 28).

**FOOTBALL**

Select the Virtual Football mode (page 29).

**Unit: PARTY CHAIN (page 30)**

Hold down to activate or deactivate the Party Chain function.

**Unit: BASS BAZUCA (page 28)**

Press to select the BASS BAZUCA effect.  
Hold down to select the BASS CUT effect.

**10 CD**

Select the CD function.

**Unit: USB/USB SELECT**

**Remote control: USB**

Select the USB function.  
Select the USB device connected to the  $\psi$  A or  $\psi$  B port during USB function.

**Unit: TUNER/BAND**

Select the TUNER function.  
Select the FM or AM band during TUNER function.

**Unit: AUDIO IN**

Select the AUDIO IN 1 or AUDIO IN 2 function.

**Remote control: FUNCTION**

Select a function.

**11 REC TO USB B**

Transfer music to the optional USB device which is connected to the  $\psi$  B port.

**12  $\psi$  (USB) B (REC/PLAY) port**

Connect and transfer to an optional USB device.

**13 MIC jack**

Connect a microphone.

**MIC LEVEL (MIN/MAX)**

Adjust the microphone volume.

**14  $\psi$  (USB) A (PLAY) port**

Connect an optional USB device.

**15 FLANGER, ISOLATOR, PAN, WAH (page 30)**

Select the DJ EFFECT type.

**16 BLUETOOTH (page 25, 26)**

Press to select *Bluetooth* function.  
Hold down to activate *Bluetooth* pairing during *Bluetooth* function.

**17 OPTIONS**

Enter or exit options menu.

**18 Remote control sensor**

**19 SLEEP (page 33)**

Set the Sleep Timer.

**20 REPEAT/FM MODE**

Listen to a disc, a USB device, a single track or file repeatedly (page 19).  
Select the FM reception mode (monaural or stereo) (page 22).

**21 DISPLAY**

Change the information on the display panel.

**22 SEARCH/MEMORY**

Enter or exit search mode.  
Preset the radio station (page 23).

**23 CLEAR**

Delete the last step from the program list.

**24 TIMER MENU (page 15, 34)**

Set the clock and the timers.

**25 PLAY MODE**

Select the play mode of an AUDIO CD, MP3 disc or a USB device (page 18).

\* The VOLUME + and ► buttons have a tactile dot. Use the tactile dot as a reference when operating the system.

## Hooking up the system securely

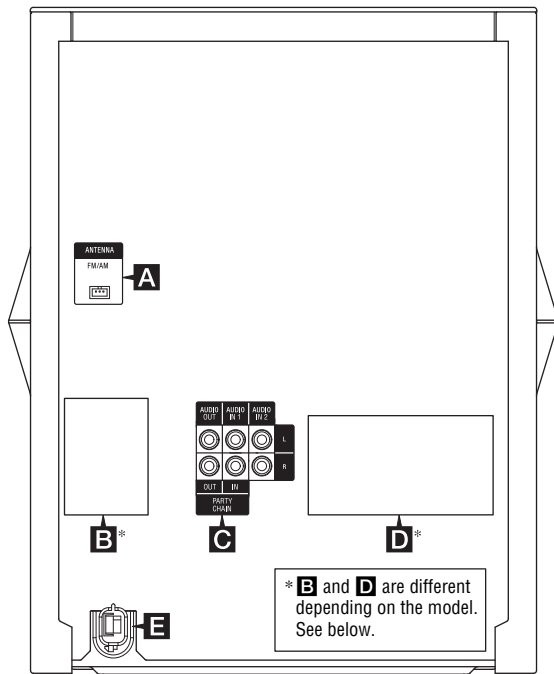

**B**

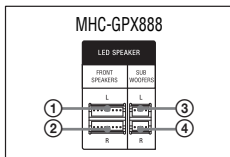

**D**

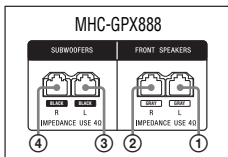

- ① To front speaker (left)
- ② To front speaker (right)
- ③ To subwoofer (left)
- ④ To subwoofer (right)
- ⑤ To subwoofer

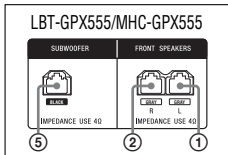
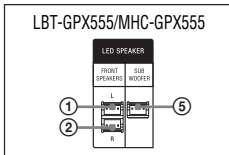

## A Antennas

Find a location and an orientation that provide good reception when you set up the antennas.

Keep the antennas away from the speaker cords, the power cord and the USB cable to avoid picking up noise.

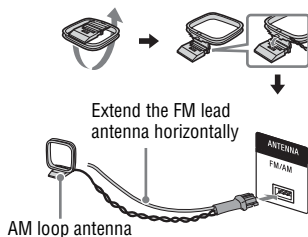

## B LED SPEAKER terminals

Connect the LED SPEAKER connector of the speaker to this terminal.

The lighting on the speakers will react according to the music source. You can select the illumination pattern and color according to your preference (page 33).

**Example:**

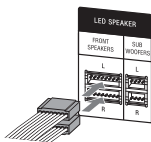

## C Audio

Use an audio cord (not supplied) to make either connection as follows:

### – AUDIO OUT/PARTY CHAIN OUT L/R jacks

- Connect to the audio input jacks of an optional equipment.
- Connect to another audio system to enjoy the Party Chain function (page 30).

### – AUDIO IN 1/PARTY CHAIN IN L/R jacks

- Connect to the audio output jacks of a TV or an audio/video equipment. The sound is output through this system.
- Connect to another audio system to enjoy the Party Chain function (page 30).

### – AUDIO IN 2 L/R jacks

Connect to the audio output jacks of a computer or gaming device. The sound is output through this system.

## D FRONT SPEAKERS and SUBWOOFER(S) terminals

Connect the speaker connectors to match the color of the speaker terminals of the unit.

**Example:**

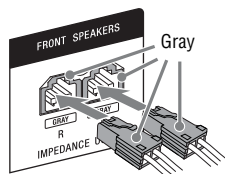

### Notes

- Be sure to use only the supplied speakers.
- When connecting speaker cords, insert the connector straight into the terminals.

## E Power

Plug the power cord into a wall socket. The demonstration appears in the display panel. Press I/⏻ to turn on the system and the demonstration automatically ends. If the supplied adaptor on the plug does not fit your wall outlet, detach it from the plug (only for models equipped with an adaptor).

## Inserting batteries

Insert the two supplied R6 (size AA) batteries, matching the polarities as shown below.

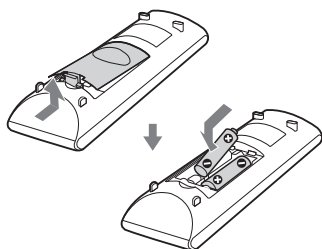

### Notes

- Do not mix an old battery with a new one or mix different types of batteries.
- If you do not use the remote control for a long period of time, remove the batteries to avoid damage from battery leakage and corrosion.

## Attaching the speaker pads

### (MHC-GPX888 only)

The speaker pads are pre-installed in vertical position to stabilize the speakers and to prevent them from slipping. If you want to place the speakers in horizontal positioning (page 14), attach the supplied speaker pads to the bottom of the speakers as shown below.

#### – Front speaker

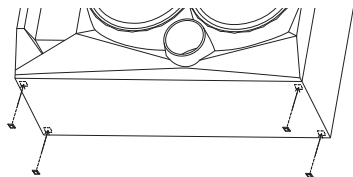

#### – Subwoofer

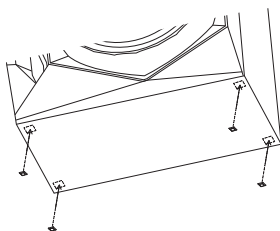

## Positioning the speakers

To obtain optimum performance from the system, we recommend you to place the speakers as shown below.

- Ⓐ Unit
- Ⓑ Front speaker (left)
- Ⓒ Front speaker (right)
- Ⓓ Subwoofer (left)
- Ⓔ Subwoofer (right)
- Ⓕ Subwoofer
- Ⓖ Spacer

### MHC-GPX888 only

#### – Vertical positioning

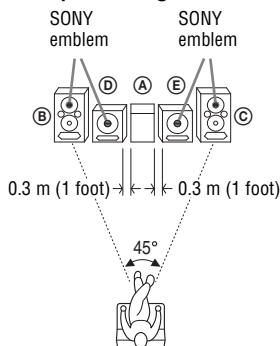

### – Horizontal positioning

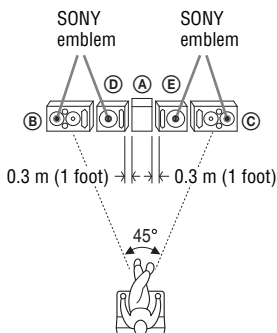

### LBT-GPX555/MHC-GPX555 only

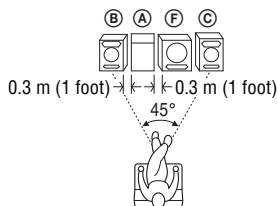

### Line Array Speaker System (MHC-GPX888 only)

To create a party environment, we recommend you to install your speakers using Line Array Speaker System. It provides a wide sound space for a large room like a hall.

### – Positioning

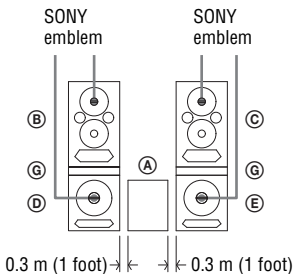

### – Installing

- 1 Insert the pins of the spacer (supplied) to the catcher holes on top of the subwoofer.

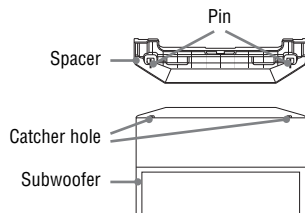

- 2 Stack the front right speaker on top of the subwoofer. Make sure the pins of the spacer are inserted into catcher holes on the front right speaker.

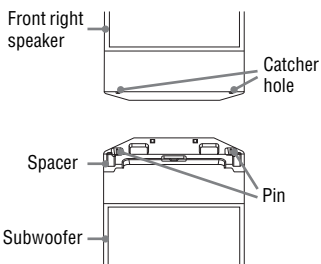

- 3 Repeat steps 1 and 2 to install another subwoofer and front left speaker.

## Turning the SONY emblem (MHC-GPX888 only)

### – Horizontal positioning

After positioning the speakers, turn the SONY emblem on the front speakers and subwoofers to horizontal position.

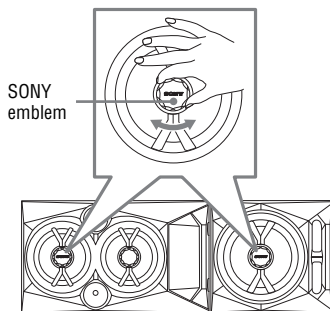

## Setting the clock

You cannot set the clock in Power Saving Mode.

**1** Press I/⏻ to turn on the system.

**2** Press TIMER MENU.

If “PLAY SET” appears in the display panel, press ⏮/⏭ repeatedly to select “CLOCK SET”, then press ⊕.

**3** Press ⏮/⏭ repeatedly to set the hour, then press ⊕.

**4** Press ⏮/⏭ repeatedly to set the minutes, then press ⊕.

## Changing the display mode

The demonstration appears in the display panel once you plug the power cord into a wall socket.

**Press DISPLAY repeatedly while the system is turned off.**

### Demonstration

The display changes and the indicator flashes even when the system is turned off.

### No display (Power Saving Mode)

The display is turned off to conserve power. The timer and clock continue to work internally.

### Clock

The clock display automatically turns to Power Saving Mode after a few seconds.

### Playing a disc

- 1 Press CD.**
- 2 Press  $\blacktriangle$  OPEN/CLOSE on the unit.**
- 3 Load a disc with the label side facing up on the disc tray.**

When you play back an 8 cm disc such as a CD single, place it on the inner circle of the tray

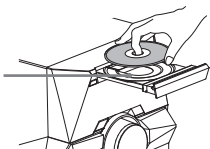

- 4 Press  $\blacktriangle$  OPEN/CLOSE on the unit to close the disc tray.**  
Do not forcibly push the disc tray to close it as this may cause a malfunction.
- 5 Press  $\blacktriangleright$  to start playback.**

### Before using a USB device with this system

Check the information on the website about compatible USB devices (page 36).

#### To select the playback source or transfer destination (USB Memory Select)

If the USB device has more than one memory (for example, an internal memory and a memory card), you can select which memory to use as a playback source or transfer destination.

Use the buttons on the unit to perform this operation.

#### Note

You cannot select a memory during playback or transfer. Make sure to select a memory before starting playback or transfer.

- 1 Press USB/USB SELECT repeatedly until "USB A" or "USB B" lights up in the display panel.**
- 2 Connect a USB device to the  $\Psi$  A or  $\Psi$  B port according to your selection in step 1.**
- 3 Press OPTIONS when playback is stopped.**
- 4 Press  $\blackuparrow$ / $\blackdownarrow$  to select "USB MEM SEL", then press ENTER.**
- 5 Press  $\blackuparrow$ / $\blackdownarrow$  to select the memory you want, then press ENTER.**

To exit the options menu, press OPTIONS on the unit.

## Playing a USB device

The audio formats that can be played back by this system are as follows:

- MP3: file extension “.mp3”
- WMA: file extension “.wma”
- AAC: file extension “.m4a”, “.mp4” or “.3gp”

If the audio files have the above file extension but are not the respective formats, the system may produce noise or may malfunction.

**1 Press USB repeatedly until “USB A” or “USB B” lights up in the display panel.**

**2 Connect a USB device to the USB A or USB B port according to your selection in step 1.**

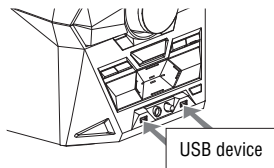

### Note

You can use your iPhone/iPod with this system via *Bluetooth* connection only.

**3 Press ▶ to start playback.**

The audio files are played back in different orders depending on the play mode (page 18).

## Searching for a track or audio file

(Track Search)

**1 Press SEARCH.**

“SEARCH” lights up in the display panel.

**2 (Audio files only)**

**Press ↑/↓ to select the folder you want, then press ⊕ or ▶.**

To search in other folders, press ◀ to exit, then select the folder you want.

**3 Press ↑/↓ to select the track or audio file you want, then press ⊕ or ▶.**

The selected track or audio file starts playback.

### Notes on disc

- (For AUDIO CD) This system can recognize up to 99 tracks.
- (For MP3 disc) This system can recognize up to
  - 999 folders (including root and empty folders).
  - 999 MP3 files.
  - 250 MP3 files in a folder.
  - 8 folders levels (tree structure of files).
- CD-TEXT information is not supported.

### Notes on USB device

- This system can recognize up to
  - 1,000 folders in a USB device (including root and empty folders).
  - 3,000 audio files in a USB device.
  - 250 audio files in a folder.

## Using play mode

### Playing in original order (Normal Play)

Press PLAY MODE repeatedly when playback is stopped.

#### When playing a disc

- (blank): play a disc
- FLDR\*: play all audio files in the specified folder on the disc
- \* When playing an AUDIO CD, "FLDR" performs the same operation as "(blank)" play mode.

#### When playing a USB device

- ALL USB: play all USB devices
- 1 USB: play a USB device
- FLDR: play all audio files in the specified folder on the USB device

### Playing in random order (Shuffle Play)

Press PLAY MODE repeatedly when playback is stopped.

#### When playing a disc

- SHUF: shuffle all audio files on a disc
- FLDR SHUF\*: shuffle all audio files in the specified folder on the disc
- \* When playing an AUDIO CD, "FLDR SHUF" performs the same operation as "SHUF" play mode.

#### When playing a USB device

- ALL USB SHUF: shuffle all audio files on all USB devices
- 1 USB SHUF: shuffle all audio files on a USB device
- FLDR SHUF: shuffle all audio files in the specified folder on the USB device

#### Note

When you turn off the system, the selected Shuffle Play is cleared and the play mode returns to Normal Play.

## Creating your own program (Program Play)

You can make a program of up to 25 steps in the order you want them to be played back.

### 1 For CD function:

Press CD to select CD function.

### For USB function:

Press USB repeatedly to select the USB device you want.

### 2 When playback is stopped, press PLAY MODE repeatedly until "PGM" lights up in the display panel.

### 3 (Audio files only)

Press  $\square$  +/- repeatedly to select a folder.

If you want to program all files in the folder, press  $\oplus$ .

### 4 Press $\lll$ / $\ggg$ repeatedly to select the track or audio file you want, then press $\oplus$ .

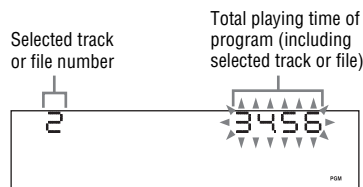

"--.--" appears when the total playing time exceeds 100 minutes for an AUDIO CD or when you program an audio file.

### 5 Repeat steps 3 to 4 to program additional tracks or audio files.

### 6 Press $\blacktriangleright$ to start Program Play.

## To delete the last step from the program list

Press CLEAR when playback is stopped.

## To cancel Program Play



When playback is stopped, press PLAY MODE repeatedly until "PGM" disappears from the display panel.

### Notes

- (CD function only) The program list is cleared when you open the disc tray.
- (USB function only) The program list is cleared when you:
  - perform the erase operation.
  - remove the USB device.
  - change the selected USB memory.

## Playing repeatedly (Repeat Play)

Press REPEAT repeatedly.

-  : repeat all tracks or audio files on a folder/disc/USB device/program
-  1 : repeat a track or audio file

### Notes on the USB device

- The playback order for the system may differ from the playback order of the connected digital music player.
- You cannot erase audio files and folders in Shuffle Play or Program Play.

## USB Transfer

## Transferring music

You can transfer music from a sound source to a USB device connected to the  $\Psi$  B port.

The audio format of files transferred by this system is MP3. However, you can also transfer WMA and AAC files from USB A.

### Notes

- Do not remove the USB device during transfer or erase operations. Doing so may corrupt the data on the USB device or damage the USB device itself.
- MP3/WMA/AAC files are transferred with the same bit rate as the original files.
- When transferring from an AUDIO CD, TUNER, AUDIO IN 1 or AUDIO IN 2 function, you may select the bit rate before transferring.
- USB transfer and erase operations are disabled while the disc tray is open.

## Note on copyright-protected content

The transferred music is limited to private use only. Use of the music beyond this limit requires permission of the copyright holders.

## To select the playback source or transfer destination (USB Memory Select)

See page 16.

## To select the bit rate

You can select a higher bit rate to transfer music with better quality. Use the buttons on the unit to perform this operation.

- 1 Press OPTIONS.

- 2 Press  $\uparrow/\downarrow$  repeatedly to select "REC BIT RATE", then press ENTER.
- 3 Press  $\uparrow/\downarrow$  repeatedly to select the bit rate you want, then press ENTER.
  - 128 KBPS: encoded MP3 tracks have smaller file size and lower audio quality.
  - 256 KBPS: encoded MP3 tracks have bigger file size but higher audio quality.To exit the options menu, press OPTIONS on the unit.

## Transferring music from a disc or USB device

You can easily transfer all the music on a disc or USB A to USB B (Synchronized Transfer). You can also transfer a single track or audio file during playback (REC1 Transfer).

Use the buttons on the unit to perform this operation.

- 1 Connect a transferable USB device to the  $\Psi$  B port as shown below.

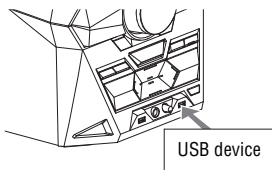

- 2 **For disc:**  
Press CD, then load the disc.

### For USB:

Press USB/USB SELECT repeatedly until "USB A" lights up in the display panel, then connect the USB device containing audio files you want to transfer to  $\Psi$  A port.

- 3 **For Synchronized Transfer:**

When playback is stopped, press PLAY MODE on the remote control repeatedly to select the play mode you want.

### Notes

- If you start transferring in Shuffle Play ("FLDR SHUF"), the selected play mode changes to "FLDR" automatically.
- If you start transferring in Shuffle Play (except "FLDR SHUF"), Repeat Play or Program Play with no steps, the selected play mode changes to Normal Play automatically.

### For REC1 Transfer:

Select the track or audio file you want to transfer, then start playback.

- 4 Press REC TO USB B.

"PUSH ENTER" appears in the display panel.

- 5 Press ENTER.

The transfer starts when "DON'T REMOVE" appears in the display panel.

### For Synchronized Transfer:

When the transfer is completed, the transfer source and the USB device stop automatically.

### For REC1 Transfer:

When the transfer is completed, the disc or the USB device continues to play.

## Transferring analog audio (Analog Transfer)

You can transfer sound from an analog audio source (other than CD, USB or *Bluetooth* function) to a USB device. Use the buttons on the unit to perform this operation.

- 1 Connect a transferable USB device to the  $\Psi$  B port (page 20).
- 2 Press TUNER/BAND or AUDIO IN repeatedly to select the source you want to transfer.
- 3 Press REC TO USB B.  
“PUSH ENTER” appears in the display panel.
- 4 Press ENTER.  
The transfer starts when “DON’T REMOVE” appears in the display panel.
- 5 Start playing the source.

### To stop transfer

Press ■.

### To create a new MP3 file

Press REC TO USB B during Analog Transfer.  
“NEW TRACK” appears in the display panel.  
A new MP3 is also created automatically after approximately 1 hour of transfer.

### Notes

- When a new MP3 file is created, transfer is disabled for the time being.
- If you press REC TO USB B again after a few seconds, a new MP3 file can be created.

## Erasing audio files or folders from a USB device

Use the buttons on the unit to perform this operation.

- 1 Press USB/USB SELECT repeatedly until “USB A” or “USB B” lights up in the display panel when playback is stopped.
- 2 Press  $\lll$ / $\ggg$  or  $\square$  +/- repeatedly to select the audio file or folder.
- 3 Press OPTIONS.
- 4 Press  $\uparrow$ / $\downarrow$  to select “USB ERASE”, then press ENTER.  
“FOLDER ERASE” or “TRACK ERASE” appears in the display panel.
- 5 Press ENTER.  
“COMPLETE” appears in the display panel.  
To exit the options menu, press OPTIONS on the unit.

## Folder and file generation rules

When transferring to a USB device, a “MUSIC” folder is created directly below “ROOT”. Folders and files are generated within this “MUSIC” folder according to the transfer method and source as follows:

### Synchronized Transfer

Source	Folder name	File name
Audio files	Same as the source	
AUDIO CD	“CDDA0001”*	“TRACK001”*

## REC1 Transfer

Source	Folder name	File name
Audio files	"REC1-MP3"	Same as the source
AUDIO CD	"REC1-CD"	"TRACK001"*

## Analog Transfer

Source	Folder name	File name
FM	"TUFM0001"*	"TRACK001"*
AM	"TUAM0001"*	
AUDIO IN 1/ AUDIO IN 2	"EXAU0001"*	

\* Folder and file numbers are assigned serially thereafter.

### Notes on transfer

- While transferring (except analog transfer), no sound is output.
- CD-TEXT information is not transferred to the created MP3 files.
- The transfer stops automatically if:
  - the USB device runs out of space during transfer.
  - the number of audio files or folders on the USB device reaches the limit that the system can recognize (page 17).
- If a folder or file that you are trying to transfer already exists on the USB device with the same name, a sequential number is added after the name without overwriting the original folder or file.
- You cannot perform the following operations during transfer:
  - Eject the disc.
  - Select another track or file.
  - Pause playback or find a point in the track or file.
  - Change the function or tuner band.
- When transferring music to a Walkman® using "Media Manager for WALKMAN", be sure to transfer in MP3 format.
- When connecting a Walkman® to the system, be sure to connect after the display "Creating Library" or "Creating Database" on the Walkman® has disappeared.

## Tuner

# Listening to the radio

**1** Press **FUNCTION** repeatedly to select FM or AM band.

**2** For automatic scanning:

Hold down TUNING+/- until the frequency indication changes and then release.

Scanning stops automatically when a station is tuned in. "TUNED" and "ST" (for FM stereo programs only) light up in the display panel.

If "TUNED" does not light up and scanning does not stop, press **■** to stop scanning. Then, perform manual tuning (below).

### For manual tuning:

Press TUNING+/- repeatedly to tune to the station you want.

### Note

When you tune to an FM station that provides RDS services, information such as the service name or station name is provided by broadcasts. You can check the RDS information by pressing DISPLAY repeatedly.

### Tip

To reduce static noise on a weak FM stereo station, press FM MODE repeatedly until "MONO" lights up in the display panel.

## To change the AM tuning interval

The default setting for AM tuning interval is 9 kHz (or 10 kHz for some areas). You cannot change the AM tuning interval in Power Saving Mode.

Use the buttons on the unit to perform this operation.

- 1 Press TUNER/BAND repeatedly to select AM band.
- 2 Press I/⏻ to turn off the system.
- 3 While holding down TUNER/BAND, press I/⏻.  
“AM 9K STEP” or “AM 10K STEP” appears in the display panel.  
When you change the interval, all the AM preset stations are erased.

## Presetting radio stations

You can store up to 20 FM and 10 AM stations as your favorite stations.

- 1 Tune to the station you want.
- 2 Press MEMORY.

Preset number



- 3 Press TUNING+/- repeatedly to select the preset number you want, then press ⊕.

“COMPLETE” appears in the display panel. The station is stored.

## To tune to a preset station

Press PRESET+/- (or +/- on the unit) repeatedly to select the preset number you want.

## Bluetooth

### About the *Bluetooth* wireless technology

*Bluetooth* wireless technology is a short-range wireless technology that enables wireless data communication between digital devices. *Bluetooth* wireless technology operates within a range of about 10 meters (33 feet).

#### Supported *Bluetooth* version, profiles and codecs

Supported *Bluetooth* version:

- *Bluetooth* Standard version 3.1

Supported *Bluetooth* profiles:

- A2DP (Advanced Audio Distribution Profile)
- AVRCP 1.3 (Audio Video Remote Control Profile)
- SPP (Serial Port Profile)

Supported *Bluetooth* codecs:

- SBC (Sub Band Codec)
- AAC (Advanced Audio Coding)

#### About the BLUETOOTH indicator

The BLUETOOTH indicator lights up or flashes in blue to show the *Bluetooth* status.

System status	Indicator status
<i>Bluetooth</i> standby	Flashes slowly
<i>Bluetooth</i> pairing	Flashes quickly
<i>Bluetooth</i> connection is established	Lights up

---

## Setting the *Bluetooth* audio codecs

You can receive data in AAC codec format from a *Bluetooth* device.

- 1 Press BLUETOOTH on the unit to select *Bluetooth* function.**  
“BLUETOOTH” appears in the display panel.
- 2 Press OPTIONS on the unit.**
- 3 Press  $\uparrow/\downarrow$  repeatedly to select “BT AAC”, then press  $\oplus$ .**
- 4 Press  $\uparrow/\downarrow$  repeatedly to select “BT AAC ON” or “BT AAC OFF”.**
  - BT AAC ON: Enable reception in AAC codec format.
  - BT AAC OFF: Receive in SBC codec format.To exit the options menu, press OPTIONS on the unit.

### Notes

- You can enjoy high quality sound if the AAC is selected. In case you cannot listen to AAC sound from your device, select “BT AAC OFF”.
- If you change this setting while the system is connected to a *Bluetooth* device, the *Bluetooth* device will be disconnected. To connect to the *Bluetooth* device, perform the *Bluetooth* connection again.

---

## Connecting a smartphone with one touch (NFC)

### What is “NFC”?

NFC (Near Field Communication) is a technology enabling short-range wireless communication between various devices, such as smartphones and IC tags. Thanks to the NFC function, data communication can be achieved easily just by touching the designated touchpoint on the NFC-compatible devices.

When you touch the system with an NFC-compatible smartphone, the system automatically:

- turns on in *Bluetooth* function.
- completes pairing.
- completes the *Bluetooth* connection.

### 1 Download and install the “NFC Easy Connect” app.

Download the free Android app from Google Play by searching for “NFC Easy Connect” or access it by using the two-dimensional code below. Data communication fees may be charged.

### Two-dimensional code\* for direct access

\* Use a two-dimensional code reader app.



## Notes

- The app may not be available in some countries/regions.
- Depending on your smartphone, you can use the NFC function without installing the app. In this case, the operations and specifications may differ. For details, refer to the operating instructions of your smartphone.

### Compatible smartphones

Smartphones with a built-in NFC function (OS: Android 2.3.3 or later, excluding Android 3.x)

## 2 Start the “NFC Easy Connect” app on the smartphone.

Make sure that the application screen is displayed.

## 3 Touch the smartphone to the N-Mark on the system until the smartphone vibrates.

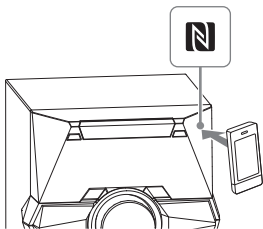

Complete the connection by following the instructions displayed on the smartphone.

When the *Bluetooth* connection is established, the BLUETOOTH indicator stops flashing and remains light up. *Bluetooth* device name appears in the display panel. You can switch the sound source from the smartphone to another NFC-compatible *Bluetooth* device. For details, refer to the operating instructions of your *Bluetooth* device.

## Tip

If pairing and the *Bluetooth* connection fail, do the following.

- Relaunch “NFC Easy Connect” and move the smartphone slowly over the N-Mark.
- Remove the case from the smartphone if using a commercially available smartphone case.

## To play music from the smartphone

Start playing of an audio source on the smartphone. For details on playback, refer to the operating instructions of your smartphone.

## To disconnect the smartphone

Touch the smartphone to the N-Mark on the system again.

## Listening to music wirelessly on a *Bluetooth* device

You can listen to music from your *Bluetooth* device over a wireless connection.

Check the information on the website about compatible *Bluetooth* devices (page 36).

### Pairing this system with a *Bluetooth* device

Pairing is an operation where *Bluetooth* devices register with each other beforehand. Once a pairing operation is performed, it does not need to be performed again. If your device is an NFC-compatible smartphone, the manual pairing procedure is not necessary.

## 1 Place the *Bluetooth* device within 1 meter (3 feet) from the system.

## 2 Press **BLUETOOTH** on the unit to select *Bluetooth* function.

“BLUETOOTH” appears in the display panel.

### Note

If the system is connected to a *Bluetooth* device, press **BLUETOOTH** to disconnect the *Bluetooth* device.

## 3 Hold down **BLUETOOTH** on the unit for 2 seconds or more.

“PAIRING” flashes in the display panel.

## 4 Perform the pairing procedure on the *Bluetooth* device.

For details, refer to the operating instructions of your *Bluetooth* device.

## 5 Select the model number of the unit on the display of the *Bluetooth* device.

For example, select “SONY:MHC-GPX888” (or LBT-GPX555/MHC-GPX555).

If passkey is required on the *Bluetooth* device, enter “0000”.

## 6 Perform the *Bluetooth* connection on the *Bluetooth* device.

When pairing is completed and the *Bluetooth* connection is established, *Bluetooth* device name appears in the display panel.

Depending on the *Bluetooth* device, connection may start automatically after pairing is completed.

You can check the *Bluetooth* device address by pressing **DISPLAY** repeatedly.

### Notes

- You can pair up to 9 *Bluetooth* devices. If the 10th *Bluetooth* device is paired, the oldest paired device will be deleted.
- “Passkey” may be called “Passcode”, “PIN code”, “PIN number” or “Password”, etc., depending on the device.

- The pairing standby status of the system is canceled after about 5 minutes. If pairing is not successful, repeat from step 1.
- While connected to a *Bluetooth* device, this system cannot be detected and connection cannot be established from another *Bluetooth* device which is never paired before.
- If you want to pair with another *Bluetooth* device, repeat steps 1 to 6.

## To cancel the pairing operation

Hold down **BLUETOOTH** on the unit for 2 seconds or more until “BLUETOOTH” appears in the display panel.

## Playing music from a *Bluetooth* device

You can operate a *Bluetooth* device by connecting the system and the *Bluetooth* device using AVRCP.

Check the following before playing music:

- The *Bluetooth* function of the *Bluetooth* device is turned on.
- Pairing has been completed.

## 1 Press **BLUETOOTH** on the unit to select *Bluetooth* function.

“BLUETOOTH” appears in the display panel.

## 2 Establish connection with the *Bluetooth* device.

The last connected *Bluetooth* device will be connected automatically. Perform the *Bluetooth* connection from the *Bluetooth* device if the device is not connected.

Once the connection is established, the *Bluetooth* device name appears in the display panel.

## 3 Press **▶** to start playback.

Depending on the *Bluetooth* device,  
– you may need to press **▶** twice.  
– you may need to start playing an audio source on the *Bluetooth* device.

**Notes**

- When the system is not connected to any *Bluetooth* device, the system will connect and play back from the last connected *Bluetooth* device automatically when you press **▶**.
- If you try to connect another *Bluetooth* device to the system, the current connected *Bluetooth* device will be disconnected.

**To disconnect the *Bluetooth* device**

Press **BLUETOOTH** on the unit. “BLUETOOTH” appears in the display panel.

Depending on the *Bluetooth* device, the *Bluetooth* connection may be canceled automatically when you stop playback.

### Erasing all the pairing registration information

Use the buttons on the unit to perform this operation.

#### **1** Press **BLUETOOTH** to select *Bluetooth* function.

“BLUETOOTH” appears in the display panel.

If the system is connected to a *Bluetooth* device, the *Bluetooth* device name appears in the display panel.

Press **BLUETOOTH** to disconnect the *Bluetooth* device.

#### **2** Hold down **■** and **WAH** for about **3 seconds**.

“PAIR HISTORY” and “CLEAR” appear in the display panel and all the pairing information is erased.

## Setting the *Bluetooth* standby mode

The *Bluetooth* standby mode enables the system to turn on automatically when you establish the *Bluetooth* connection from a *Bluetooth* device.

- 1** Press **OPTIONS** on the unit.
- 2** Press **▲/▼** repeatedly to select “BT STANDBY”, then press **⊕**.
- 3** Press **▲/▼** repeatedly to select “STANDBY ON” or “STANDBY OFF”.
- 4** Press **I/⏻** to turn off the system.

When the *Bluetooth* standby mode is set to on, the system waits for a *Bluetooth* connection even when the system has been turned off. When a *Bluetooth* connection is established, the system turns on automatically.

## Setting the *Bluetooth* signal

You can connect to the system from a paired *Bluetooth* device in all functions when *Bluetooth* signal is set to on. The *Bluetooth* signal is turned on by default. Use the buttons on the unit to perform this operation.

#### **Hold down **MOVIE/GAME** and **LED COLOR** for about 3 seconds.**

“BT ON” or “BT OFF” appears in the display panel.

## Notes

- You cannot perform the following operations when *Bluetooth* signal is set to off:
  - Pairing with *Bluetooth* device
  - Erasing the pairing information
  - Using “SongPal” via *Bluetooth*
- When the *Bluetooth* signal is set to off, this system cannot be detected and connection cannot be established from *Bluetooth* device.
- If you set the *Bluetooth* standby mode to on, the *Bluetooth* signals will set to on automatically.

---

## Using “SongPal” via *Bluetooth*

### About App

A dedicated app for this model is available on both Google Play and App Store. Search for “SongPal” and download the free app to find out more about the convenient features.

*Bluetooth* technology works with iPhone 5s, iPhone 5c, iPhone 5, iPhone 4s, iPhone 4, iPhone 3GS, iPod touch (5th generation), iPod touch (4th generation).

## Sound Adjustment

### Adjusting the sound

To	Do this
Reinforce the bass and create a more powerful sound	Press BASS BAZUCA on the unit.
Reduce the bass sound (BASS CUT)	Hold down BASS BAZUCA on the unit for 2 seconds or more. To cancel the BASS CUT effect, press BASS BAZUCA again.
	<b>Notes</b> <ul style="list-style-type: none"><li>• When BASS CUT effect is turned on, BASS BAZUCA indicator flashes and “BASS CUT” appears in the display panel every 10 seconds.</li><li>• The BASS CUT effect is turned off automatically when you turn off the system.</li></ul>
Select a preset sound effect	Press MUSIC or MOVIE/ GAME. To cancel preset sound effect, press MUSIC repeatedly to select “FLAT”.

### To adjust the subwoofer level

- 1 Press OPTIONS on the unit.
- 2 Press  $\uparrow/\downarrow$  repeatedly to select “SUBWOOFER”, then press  $\oplus$ .
- 3 Press  $\uparrow/\downarrow$  repeatedly to select the subwoofer level, then press  $\oplus$ .  
To exit the options menu, press OPTIONS on the unit.

## Selecting the Virtual Football mode

You can experience a feeling of presence in the stadium when watching the football match broadcast.

Press **FOOTBALL** repeatedly while watching a football match broadcast.

- **NARRATION ON:** You can enjoy an immersive feeling of being in a football stadium through enhanced stadium cheers.
- **NARRATION OFF:** You can enjoy a more immersive feeling of being in a football stadium by minimizing the volume level of narration in addition to the enhancement of cheers.

### To cancel the Virtual Football mode

Press **MUSIC** repeatedly to select “FLAT”.

#### Notes

- We recommend you to select the football mode when watching a football match broadcast.
- If you hear unnatural sound in the content when “NARRATION OFF” is selected, “NARRATION ON” is recommended.
- This feature does not support monaural sound.
- You can only select the Virtual Football mode during AUDIO IN 1 or AUDIO IN 2 function.

## Creating your own sound effect

You can raise or lower the levels of specific frequency bands, then store the setting in the memory as “CUSTOM EQ”.

- 1 Press **OPTIONS** on the unit.
- 2 Press **↑/↓** repeatedly to select “EQ EDIT”, then press **⊕**.
- 3 Press **↑/↓** repeatedly to adjust the equalizer level, then press **⊕**.

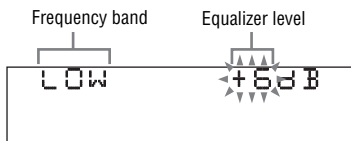

- 4 Repeat step 3 to adjust the level of other frequency bands and surround effect.

To exit the options menu, press **OPTIONS** on the unit.

### To select the custom equalizer setting

Press **MUSIC** repeatedly to select “CUSTOM EQ”.

---

## Creating a party atmosphere

(DJ EFFECT)

### 1 Press the following button to select the effect type.

The selected button lights up and the effect is activated.

- **FLANGER:** Create a deep flanging effect that is similar to the roar of a jet plane.
- **ISOLATOR:** Isolate a specific frequency band by adjusting the other frequency bands. For example, when you want to focus on vocals.
- **PAN:** Create a feeling that the sound is moving around the speakers between left and right channels.
- **WAH:** Create a special effect of “Wah-wah” sound by moving the frequency of a filter up and down automatically.

### 2 Press DJ CONTROL +/- to adjust the effect level.

#### To turn off the effect

Press the selected effect button again.

#### Notes

- The DJ EFFECT is automatically turned off when you turn off the system or change the function or tuner band.
- If you activate the DJ EFFECT during transfer, the sound effect will not be transferred to the USB device.
- You cannot use VOLUME/DJ CONTROL on the unit to adjust the volume when the DJ EFFECT is activated. Press VOLUME +/- on the remote control to adjust the volume.

## Other Operations

### Using the Party Chain function

You can connect multiple audio systems in a chain to create a more interesting party environment and to produce higher sound output.

Activate a system in the chain to be the “Party Host” and share the music. Other systems will become “Party Guest” and play the same music as the “Party Host”.

#### Setting up the Party Chain

You can set up a Party Chain by connecting all the systems using audio cords (not supplied).

Before connecting cords, be sure to disconnect the power cord.

## A If all the systems are equipped with Party Chain function

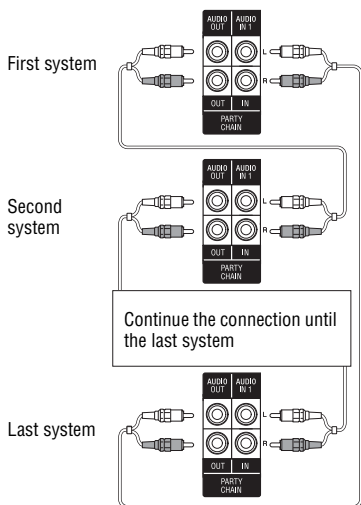

### When you make connection A

- Any system can become a Party Host in this connection.
- You can select a new Party Host when Party Chain function is activated. For details, see “To select a new Party Host” (page 32).
- In this connection, the last system must be connected to the first system.

## B If one of the system is not equipped with Party Chain function

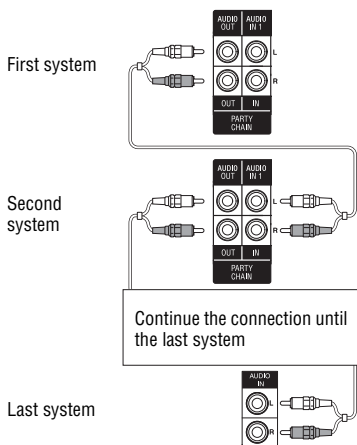

### When you make connection B

- You can connect the system which is not equipped with Party Chain function at the last system. Be sure to select the function which corresponds to the “AUDIO IN” jacks on the last system.
- You must select the first system as Party Host so that all systems are playing the same music when Party Chain function is activated.
- In this connection, the last system is not connected to the first system.

## Enjoying the Party Chain

Perform the following procedure to activate the Party Chain function.

- 1** Plug in the power cord and turn on all the systems.
- 2** Adjust the volume on each system.

### **3 Activate the Party Chain function on the system which you want it to be the Party Host.**

Press FUNCTION repeatedly to select the function (except AUDIO IN 1) you want, then start playback.

Hold down MUSIC/PARTY CHAIN on the unit for 2 seconds.

“PARTY CHAIN” appears in the display panel. The system starts the party as Party Host and other systems will become Party Guest automatically. All systems play the same music as the Party Host.

#### **Notes**

- Depending on the total unit of systems you have connected, Party Guest may take some time to start playing the music.
- Changing the volume level and sound effect on the Party Host will not affect the output on the Party Guest.
- The Party Guest continues playing the music source as Party Host even when you change the function on Party Guest. However, you can adjust the volume and change the sound effect on Party Guest.
- (MHC-GPX888 only) When you use the microphone on Party Host, the sound will not be output from Party Guest.
- The system which is not equipped with Party Chain function cannot become a Party Host.
- When Party Chain function is activated while one of the system in the connection is performing USB transfer, the Party Chain function will not be activated on that system and the systems connected after it. Party Chain function will only be activated after that system completed or stopped the USB transfer.
- For details on the operations of other systems, refer to the operating instructions of the systems.

### **To select a new Party Host**

When you make connection **A**, you can select another system as the new Party Host.

Repeat step 3 of “Enjoying the Party Chain” on the system which you want it to be a new Party Host.

The current Party Host will become Party Guest automatically. All systems play the same music as the new Party Host.

### **To deactivate the Party Chain**

On the Party Host, hold down MUSIC/PARTY CHAIN on the unit for 2 seconds.

---

## **Singing along**

(MHC-GPX888 only)

You can sing along with any audio source that is playing on this system.

**1 Turn MIC LEVEL to MIN to reduce the microphone volume level.**

**2 Connect a microphone to the MIC jack on the unit.**

**3 Start playing the music and adjusting the volume.**

**4 Turn MIC LEVEL to adjust the microphone volume.**

If acoustic feedback (howling) occurs, reduce the volume, move the microphone away from the speakers, or change the direction of the microphone.

After you have finished, disconnect the microphone.

#### **Note**

The sound from the microphone will not be transferred to the USB device during USB transfer.

---

## Changing the spectrum pattern of the display panel

- 1 Press **OPTIONS** on the unit.
- 2 Press **↕/↔** repeatedly to select “**SPECTRUM**”, then press **⊕**.
- 3 Press **↕/↔** repeatedly to select the spectrum pattern you want, then press **⊕**.

To exit the options menu, press **OPTIONS** on the unit.

---

## Viewing information in the display panel

Press **DISPLAY** repeatedly when the system is turned on.

You can view the information as follows:

- For **AUDIO CD**:
  - The elapsed playing time and remaining playing time during playback.
  - The total playing time when playback is stopped.
- For audio files:
  - The elapsed playing time, file name and folder name.
  - The title, artist and album information.

### Note

The elapsed playing time of an audio file encoded using a **VBR** (variable bit rate) is not displayed correctly.

---

## Changing the illumination pattern and color

Press **LED PATTERN** or **LED COLOR** to show the current setting. Press repeatedly to select the illumination pattern or color on the unit and the speakers.

To turn off the illumination, press **LED PATTERN** repeatedly to select “**PATTERN OFF**”.

### Note

If the illumination brightness is glaring, switch on the room lights or turn off the illumination.

---

## Using the timers

The system offers three timer functions. You cannot activate both the Play Timer and the Recording Timer at the same time. If you use either with the Sleep Timer, the Sleep Timer has priority.

### Sleep Timer

You can fall asleep while listening to music. The system turns off after the preset time.

Press **SLEEP** repeatedly.

To cancel Sleep Timer, press **SLEEP** repeatedly to select “**SLEEP OFF**”.

### Tip

To check the remaining time before the system turns off, press **SLEEP**.

## Play Timer/Recording Timer

Make sure you have set the clock.

### Play Timer:

You can wake up to disc, tuner or USB device at a preset time.

### Recording Timer:

You can transfer music from a preset radio station to a USB device at a specified time.

#### 1 For Play Timer:

Prepare the sound source, then press VOLUME +/- to adjust the volume. To start from a specific track or file, create your own program (page 18).

#### For Recording Timer:

Tune to the preset radio station (page 23).

#### 2 Press TIMER MENU.

#### 3 Press $\uparrow/\downarrow$ repeatedly to select "PLAY SET" or "REC SET", then press $\oplus$ .

#### 4 Set the time to start playback or transfer.

Press  $\uparrow/\downarrow$  repeatedly to set the hour/minute, then press  $\oplus$ .

#### 5 Use the same procedure as in step 4 to set the time to stop playback or transfer.

#### 6 Press $\uparrow/\downarrow$ repeatedly to select the sound source you want, then press $\oplus$ .

#### For Recording Timer:

Connect a transferable USB device to the  $\psi$  B port.

#### 7 Press I/ $\circ$ to turn off the system.

#### Note

If the system remains on, the timers will not take effect.

## To check the timer setting or activate the timer again

#### 1 Press TIMER MENU.

"TIMER SELECT" flashes in the display panel.

#### 2 Press $\oplus$ .

#### 3 Press $\uparrow/\downarrow$ repeatedly to select "PLAY SELECT" or "REC SELECT", then press $\oplus$ .

## To cancel the timer

Repeat the same procedure as above and select "TIMER OFF" in step 3, then press  $\oplus$ .

### Notes

- The system turns on before the preset time. If the system is turned on at the preset time or if "STANDBY" flashes in the display panel, the Play Timer and the Recording Timer will not play or transfer.
- Do not operate the system from the time the system turns on until the playback or transfer starts.

---

## Using optional equipment

#### 1 Press VOLUME – repeatedly until "VOLUME MIN" appears in the display panel.

#### 2 Connect an optional equipment (page 11).

#### 3 Press FUNCTION repeatedly to select the function which corresponds to the connected equipment.

#### 4 Start playing the connected equipment.

#### 5 Press VOLUME + repeatedly to adjust the volume.

## Note

The system may enter standby mode automatically if the volume level of the connected equipment is too low. Adjust the volume level of the equipment. To turn off automatic standby function, see “Setting the automatic standby function” (page 35).

---

## Deactivating the buttons on the unit

(Child Lock)

You can deactivate the buttons on the unit (except **I/⏻**) to prevent misoperation, such as child mischief.

**Hold down **■** on the unit for more than 5 seconds.**

“CHILD LOCK” and “ON” appear in the display panel.

You can only operate the system using the buttons on the remote control.

To cancel, hold down **■** on the unit for more than 5 seconds until “CHILD LOCK” and “OFF” appear in the display panel.

## Note

Child Lock function will be canceled when you disconnect the power cord.

---

## Setting the automatic standby function

This system is equipped with an automatic standby function. With this function, the system enters standby mode automatically in about 15 minutes when there is no operation or audio signal output.

By default, the automatic standby function is turned on.

- 1 Press **OPTIONS** on the unit.**
- 2 Press **↕/↕** repeatedly to select “AUTO STANDBY”, then press **⊕**.**
- 3 Press **↕/↕** repeatedly to select “ON” or “OFF”.**

To exit the options menu, press **OPTIONS** on the unit.

## Notes

- The message “AUTO STANDBY” flashes in the display about 2 minutes before entering standby mode.
- The automatic standby function does not work during tuner function.
- The system may not enter standby mode automatically in the following cases:
  - when an audio signal is detected.
  - during playback of audio files.
  - while the preset Play Timer, Recording Timer or Sleep Timer is in process.

## Additional Information

### Playable discs

- AUDIO CD
- CD-R/CD-RW
  - audio data
  - MP3 files that conform to ISO9660 Level 1/Level 2, or Joliet (expansion format).

#### Notes

- MP3 (MPEG 1 Audio Layer-3) is a standard format defined by ISO (International Organization for Standardization) which compresses audio data. MP3 files must be in MPEG 1 Audio Layer-3 format.
- The system can only play back MP3 files that have a file extension of “.mp3”.

### Discs that cannot be played back

- CD-ROM
- CD-R/CD-RW which has the following conditions:
  - Recorded in MP3 PRO format
  - Recorded in multisession that was not ended by “closing the session”
  - Recorded with an incompatible recording device
  - Poor recording quality
  - Scratched or dirty
  - Finalized incorrectly
- Discs of non-standard shape (e.g., heart, square, star, etc.)
- Discs that have adhesive tape, paper, or sticker attached to them
- Rental or used discs with attached seals where the glue extends beyond the seal
- Discs that have labels printed using ink that feels tacky when touched

### Note on DualDiscs

A DualDisc is a two sided disc product which mates DVD recorded material on one side with digital audio material on the other side. However, since the audio material side does not conform to the Compact Disc (CD) standard, playback on this product is not guaranteed.

### Music discs encoded with copyright protection technologies

This product is designed to play back discs that conform to the Compact Disc (CD) standard. Recently, various music discs encoded with copyright protection technologies are marketed by some record companies. Please be aware that among those discs, there are some that do not conform to the CD standard and may not be playable by this product.

### Notes on playing multisession discs

- This system can play back multisession discs when an MP3 file is contained in the first session. Any subsequent MP3 files recorded in later sessions can also be played back (If later sessions contain AUDIO CD format, the system cannot play back this multisession discs).
- If the first session is recorded in AUDIO CD format, only the first session will be played back.

## Websites for compatible devices

Check the websites below for the latest information about compatible USB devices and *Bluetooth* devices.

For customers in Latin America:

<<http://esupport.sony.com/LA>>

For customers in the United States:

<<http://esupport.sony.com/>>

For customers in other countries/regions:

<<http://www.sony-asia.com/support>>

# Troubleshooting

Should you encounter a problem with your system, find your problem in the troubleshooting checklist below and take the corrective action.

If the problem persists, consult your nearest Sony dealer.

Note that if the service personnel changes some parts during repair, these parts may be retained.

## If “PROTECT EXX” (X is a number) appears in the display panel

Immediately unplug the power cord, and check the following items.

- Are you using only the supplied speakers?
- Is anything blocking the ventilation holes of the unit?

After checking the above items and fixing any problems, plug in the power cord again and turn on the system. If the issue persists, consult your nearest Sony dealer.

## General

### The system has entered standby mode.

- This is not a malfunction. The system enters standby mode automatically in about 15 minutes when there is no operation or audio signal output (page 35).

### The clock or timer setting is canceled.

- The power cord is disconnected or a power failure occurred. Set the clock (page 15) and timer (page 33) again.

### There is no sound.

- Adjust the volume.
- Check the speaker connections (page 11).
- Check the connection of the optional equipment, if any (page 11).

- Turn on the connected equipment.
- There is no audio output during Recording Timer.

### There is no microphone sound.

(MHC-GPX888 only)

- Adjust the microphone volume.
- Make sure the microphone is connected to the MIC jack correctly.
- Make sure the microphone is turned on.

### There is severe hum or noise.

- Move the system away from sources of noise.
- Connect the system to a different wall outlet.
- Install a noise filter (commercially available) to the power cord.
- Turn off surrounding electrical equipment.

### The timer does not function.

- Check the timer setting and set the correct time (page 33).
- Cancel the Sleep Timer function (page 33).

### The remote control does not function.

- Remove the obstacles between the remote control and the unit.
- Move the remote control closer to the unit.
- Point the remote control at the unit's sensor.
- Replace the batteries (R6/size AA).
- Move the unit away from the fluorescent light.

### There is acoustic feedback.

- Reduce the volume.
- (MHC-GPX888 only) Move the microphone away from the speakers or change the direction of the microphone.

### “CHILD LOCK” appears when you press any button on the unit.

- Set the Child Lock function to off (page 35).

## Speakers

---

### Sound comes from only one channel or the left and right volume is unbalanced.

- Place the speakers as symmetrically as possible.
- Check that the speakers are connected securely and correctly.
- The source being played back is monaural.

### There is no sound from a specific speaker.

- Check that the speaker is connected securely and correctly.
- Set the subwoofer level to the appropriate level (page 28).

## Disc player

---



### The disc tray does not open and “LOCKED” appears in the display panel.

- Consult your nearest Sony dealer or local authorized Sony service facility.

### The disc tray does not close.

- Load the disc correctly.

### The disc does not eject.

- You cannot eject the disc during CD-USB Synchronized Transfer or REC1 Transfer. Press  to cancel the transfer, then press  OPEN/CLOSE on the unit to eject the disc.
- Consult your nearest Sony dealer.

### Playback does not start.

- Wipe the disc clean (page 42).
- Reload the disc.
- Load a disc that this system can play back (page 36).
- Remove the disc and wipe away the moisture on the disc, then leave the system turned on for a few hours until the moisture evaporates.

### The sound skips.

- Wipe the disc clean (page 42).
- Reload the disc.
- Move the unit to a place with no vibration (e.g., on top of a stable stand).
- Move the speakers away from the unit, or place them on separate stands. When you listen to a track with bass sounds at high volume, the speaker vibration may cause the sound to skip.

### Playback does not start from the first track.

- Set the play mode to Normal Play (page 18).

### The folder name, track name, file name and ID3 tag characters do not appear properly.

- The ID3 tag is not Version 1(1.0/1.1) or Version 2(2.2/2.3).
- The character codes that can be displayed by this system are as follows:
  - Upper cases (A to Z)
  - Numbers (0 to 9)
  - Symbols (< > \* +, [ ] \ \_)Other characters appear as “\_”.

## USB device

---

### Transferring results in an error.

- You are using an unsupported USB device. Check the information on the website about compatible USB devices (page 36).
- The USB device is not formatted correctly. Refer to the operating instructions of the USB device on how to format.
- Turn off the system and remove the USB device. If the USB device has a power switch, turn the USB device off and on again after removing it from the system. Then, perform the transfer again.

- If the transfer and erase operations are repeated multiple times, the file structure within the USB device becomes fragmented. Refer to the operating instructions supplied with the USB device on how to deal with this problem.
- The USB device was disconnected or the power was turned off during transfer. Delete the partially-transferred file, and perform the transfer again. If this does not fix the problem, the USB device may be broken. Refer to the operating instructions of the USB device on how to deal with this problem.

#### **Audio files or folders on the USB device cannot be erased.**

- Check if the USB device is write-protected.
- The USB device was disconnected or the power was turned off during the erase operation. Delete the partially-erased file. If this does not fix the problem, the USB device may be broken. Refer to the operating instructions of the USB device on how to deal with this problem.

#### **There is no sound.**

- The USB device is not connected correctly. Turn off the system and reconnect the USB device, then turn on the system and check if “USB A” or “USB B” lights up in the display panel.

#### **There is noise, skipping, or distorted sound.**

- You are using an unsupported USB device. Check the information on the website about compatible USB devices (page 36).
- Turn off the system and reconnect the USB device, then turn on the system.
- The music data itself contains noise, or the sound is distorted. Noise may have entered during the transfer process. Delete the file, and try transfer again.
- The bit rate used when encoding audio files was low. Send audio files with higher bit rate to the USB device.

#### **“READING” is displayed for an extended time, or it takes a long time before playback starts.**

- The reading process can take a long time in the following cases.
  - There are many folders or files on the USB device (page 17).
  - The file structure is extremely complex.
  - The memory capacity is excessive.
  - The internal memory is fragmented.

#### **“OVER CURRENT” appears.**

- A problem has been detected with the level of electrical current from the  $\psi$  A port or  $\psi$  B port. Turn off the system and remove the USB device from the port. Make sure there is no problem with the USB device. If this display pattern persists, contact your nearest Sony dealer.

#### **Erroneous display.**

- The data stored in the USB device may have been corrupted, perform the transfer again.
- The character codes that can be displayed by this system are as follows:
  - Upper cases (A to Z)
  - Numbers (0 to 9)
  - Symbols (< > \* +, [ ] \ \_)
 Other characters appear as “\_”.

#### **The USB device is not recognized.**

- Turn off the system and reconnect the USB device, then turn on the system.
- Check the information on the website about compatible USB devices (page 36).
- The USB device does not work properly. Refer to the operating instructions of the USB device on how to deal with this problem.

#### **Playback does not start.**

- Turn off the system and reconnect the USB device, then turn on the system.
- Check the information on the website about compatible USB devices (page 36).

### **Playback does not start from the first file.**

- Set the play mode to Normal Play (page 18).

### **Audio file cannot be played back.**

- USB devices formatted with file systems other than FAT16 or FAT32 are unsupported.\*
- A WMA audio file that is the WMA DRM, WMA Lossless, or WMA PRO format cannot be played back.
- An AAC audio file that is the AAC DRM or AAC Lossless format cannot be played back.
- AAC audio files encoded at 96 kHz cannot be played back.
- If multiple partitions exist on a USB device that is being used, files may not be played back.
- The system can play back to a depth of 8 folders only.
- Files that are encrypted or protected by passwords cannot be played back.
- Files with DRM (Digital Rights Management) copyright protection cannot be played back by this system.
- The MP3 PRO audio file can be played back as MP3 audio file.

\* This system supports FAT16 and FAT32, but some USB devices may not support all of these FAT. For details, refer to the operating instructions of each USB device or contact the manufacturer.

## **Tuner**

---

### **There is severe hum or noise, or stations cannot be received. (“TUNED” or “ST” flashes in the display panel.)**

- Connect the antenna properly.
- Change the antenna location and its orientation to obtain good reception.
- Connect a commercially available external antenna.

- Consult your nearest Sony dealer if the supplied AM antenna has come off from the plastic stand.
- Turn off surrounding electrical equipment.

## **Bluetooth device**

---

### **Pairing cannot be performed.**

- Move the *Bluetooth* device closer to the system.
- Pairing may not be possible if other *Bluetooth* devices are present around the system. In this case, turn off the other *Bluetooth* devices.
- Make sure the correct passkey was entered at the *Bluetooth* device.

### **The *Bluetooth* device cannot detect this unit, or “BT OFF” appears in the display panel.**

- Set the *Bluetooth* signal to “BT ON” (page 27).

### **Connection is not possible.**

- The *Bluetooth* device you attempted to connect does not support the A2DP profile, and cannot be connected with the system.
- Enable the *Bluetooth* function of the *Bluetooth* device.
- Establish a connection from the *Bluetooth* device.
- The pairing registration information has been erased. Perform the pairing operation again.
- While connected to a *Bluetooth* device, this system cannot be detected and a connection cannot be established from another *Bluetooth* device which is never paired before.
- Erase the pairing registration information of the *Bluetooth* device (page 27) and perform the pairing operation again (page 25).

**The sound skips or fluctuates, or the connection is lost.**

- The system and the *Bluetooth* device are too far apart.
- If there are obstacles between the system and your *Bluetooth* device, remove or avoid the obstacles.
- If there is equipment that generates electromagnetic radiation, such as a wireless LAN, other *Bluetooth* device, or a microwave oven nearby, move them away.

**The sound of your *Bluetooth* device cannot be heard on this system.**

- Increase the volume on your *Bluetooth* device first, then adjust the volume using VOLUME +/-.

**There is severe hum, noise or distorted sound.**

- If there are obstacles between the system and your *Bluetooth* device, remove or avoid the obstacles.
- If there is equipment that generates electromagnetic radiation, such as a wireless LAN, other *Bluetooth* device, or a microwave oven nearby, move them away.
- Turn down the volume of the connected *Bluetooth* device.

**Party Chain****Party Chain function cannot be activated.**

- Check the connections (page 30).
- Make sure the audio cords are connected correctly.

**“PARTY CHAIN” is flashing in the display panel.**

- AUDIO IN 1 function is selected during Party Chain function. Press FUNCTION repeatedly to select other function.
- Restart the system.

**To reset the system**

If the system still does not operate properly, reset the system to factory default settings.

Use the buttons on the unit to perform this operation.

- 1 Unplug and plug the power cord back in.
- 2 Press **I/⏻** to turn on the system.
- 3 Hold down **■** and MOVIE/GAME for about 3 seconds.  
“RESET” appears in the display panel. All user-configured settings, such as preset radio stations, timers, and the clock are reset to factory default setting.

**Messages**

One of the following messages may appear or flash in the display panel during operation.

**CANNOT PLAY**

A disc that cannot be played back was inserted.

**DEVICE ERROR**

The USB device could not be recognized or an unknown device is connected.

**DEVICE FULL**

The memory of the USB device is full.

**FATAL ERROR**

The USB device was removed during transfer or erase operation, and may have been damaged.

**FOLDER FULL**

You cannot transfer onto the USB device because the number of folder has reached its maximum.

**NO DEVICE**

No USB device is connected.

**NO DISC**

There is no disc on the disc tray.

## **NO MEMORY**

The memory selected for playback or transfer has no memory media inserted in the USB device.

## **NO STEP**

All of the programmed steps have been erased.

## **NO TRACK**

No playable file is loaded in the system.

## **NOT IN USE**

You tried to perform a specific operation under conditions where that operation is prohibited.

## **NOT SUPPORTED**

An unsupported USB device is connected, or the USB device is connected through a USB hub.

## **OFF TIME NG**

The on time and off time of Play Timer or Recording Timer is the same.

## **PARTY GUEST**

The system becomes a Party Guest when Party Chain function is activated.

## **PARTY HOST**

The system becomes a Party Host when Party Chain function is activated.

## **PROTECTED**

The USB device is write-protected.

## **PUSH STOP**

You tried to perform an operation that can be performed only when the playback is stopped.

## **READING**

The system is reading information of the disc or USB device. Some operations are not available.

## **REC ERROR**

The transfer did not start, stopped partway, or otherwise could not be performed.

## **STEP FULL**

You tried to program more than 25 steps.

## **TRACK FULL**

You cannot transfer onto the USB device because the number of file has reached its maximum.

---

# **Precautions**

## **When carrying the unit**

Perform the following procedure to protect the disc mechanism.

Use the buttons on the unit to perform this operation.

**1** Press **I/⏻** to turn on the system.

**2** Press **CD**.

**3** Remove the disc.

Press **▲ OPEN/CLOSE** to open and close the disc tray.

Wait until "NO DISC" appears in the display panel.

**4** Unplug the power cord.

## **Notes on discs**

- Before playing, wipe the disc with a cleaning cloth from the center outward to the edge.
- Do not clean discs with solvents, such as benzene, thinner, or commercially available cleaners or anti-static spray intended for vinyl LPs.
- Do not expose discs to direct sunlight or heat sources such as hot air ducts, nor leave it in a car parked in direct sunlight.

## **On safety**

- Completely disconnect the power cord (mains lead) from the wall outlet (mains) if it is not going to be used for an extended period of time. When unplugging the unit, always grip the plug. Never pull the cord itself.
- Should any solid object or liquid get into the system, unplug the system, and have it checked by qualified personnel before operating it again.
- (USA model only)  
One blade of the plug is wider than other for the purpose of safety and will fit to the wall outlet only one way. If you are unable to insert the plug fully into the outlet, contact your dealer.

- AC power cord must be changed only at the qualified service shop.

### On placement

- Do not place the system in an inclined position or in locations that are extremely hot, cold, dusty, dirty, or humid or lacking adequate ventilation, or subject to vibration, direct sunlight or a bright light.
- Be careful when placing the unit or speakers on surfaces that have been specially treated (for example, wax, oil, polish) as staining or discoloration of the surface may result.
- If the system is brought directly from a cold to a warm location or is placed in a very damp room, moisture may condense on the lens inside the unit, and cause the system to malfunction. In this situation, remove the disc, and leave the system turned on for about an hour until the moisture evaporates.

### On heat buildup

- Heat buildup on the unit during operation is normal and is not a cause for alarm.
- Do not touch the cabinet if it has been used continuously at a high volume because the cabinet may have become hot.
- Do not obstruct the ventilation holes.

### On the speaker system

This speaker system is not magnetically shielded, and the picture on nearby TV sets may become magnetically distorted. In this situation, turn off the TV, wait 15 to 30 minutes, and turn it back on. If there is no improvement, move the speakers far away from the TV.

### Cleaning the cabinet

Clean this system with a soft cloth slightly moistened with a mild detergent solution. Do not use any type of abrasive pad, scouring powder, or solvent, such as thinner, benzene, or alcohol.

### On Bluetooth Communication

- *Bluetooth* devices should be used within approximately 10 meters (33 feet) (unobstructed distance) of each other. The effective communication range may become shorter under the following conditions.
  - When a person, metal object, wall or other obstruction is between the devices with a *Bluetooth* connection
  - Locations where a wireless LAN is installed
  - Around microwave ovens that are in use
  - Locations where other electromagnetic waves occur
- *Bluetooth* devices and wireless LAN (IEEE 802.11b/g) use the same frequency band (2.4 GHz). When using your *Bluetooth* device near a device with wireless LAN capability, electromagnetic interference may occur. This could result in lower data transfer rates, noise, or inability to connect. If this happens, try the following remedies:
  - Try connecting this system and *Bluetooth* device when you are at least 10 meters (33 feet) away from the wireless LAN equipment.
  - Turn off the power to the wireless LAN equipment when using your *Bluetooth* device within 10 meters (33 feet).
- The radio waves broadcast by this system may interfere with the operation of some medical devices. Since this interference may result in malfunction, always turn off the power on this system and *Bluetooth* device in the following locations:
  - In hospitals, on trains, in airplanes, at gas stations, and any place where flammable gases may be present
  - Near automatic doors or fire alarms
- This system supports security functions that comply with the *Bluetooth* specification as a means of ensuring security during communication using *Bluetooth* technology. However, this security may be insufficient depending on the setting contents and other factors, so always be careful when performing communication using *Bluetooth* technology.
- Sony cannot be held liable in any way for damages or other loss resulting from information leaks during communication using *Bluetooth* technology.
- *Bluetooth* communication is not necessarily guaranteed with all *Bluetooth* devices that have the same profile as this system.
- *Bluetooth* devices connected with this system must comply with the *Bluetooth* specification prescribed by the Bluetooth SIG, Inc., and must be certified to comply. However, even when a device complies with the *Bluetooth* specification, there may be cases where the characteristics or specifications of the *Bluetooth* device make it impossible to connect, or may result in different control methods, display or operation.
- Noise may occur or the audio may cut off depending on the *Bluetooth* device connected with this system, the communications environment, or surrounding conditions.

---

# Specifications

## AUDIO POWER SPECIFICATIONS

### POWER OUTPUT AND TOTAL HARMONIC DISTORTION: (USA model only)

With 4 ohm loads, both channels driven, from 120 – 10,000 Hz; rated 180 watts per channel minimum RMS power, with no more than 0.7% total harmonic distortion from 250 milliwatts to rated output.

### Amplifier section

The following are measured at USA model:

AC 120 V, 60 Hz

Mexican model:

AC 120 V – 240 V, 60 Hz

Chilean and Bolivian models:

AC 220 V – 240 V, 50 Hz

Other models:

AC 120 V – 240 V, 50/60 Hz

### MHC-GPX888

Front speaker

Power Output (rated):

350 W + 350 W (at 4 ohms, 1 kHz, 1% THD)

RMS output power (reference):

600 W + 600 W (per channel at 4 ohms, 1 kHz)

Subwoofer

RMS output power (reference):

600 W + 600 W (per channel at 4 ohms, 100 Hz)

### LBT-GPX555/MHC-GPX555

Front speaker

Power Output (rated):

350 W + 350 W (at 4 ohms, 1 kHz, 1% THD)

RMS output power (reference):

600 W + 600 W (per channel at 4 ohms, 1 kHz)

Subwoofer

RMS output power (reference):

600 W (4 ohms, 100 Hz)

### Inputs

AUDIO IN 1/PARTY CHAIN IN L/R

Voltage 2 V, impedance 47 kilohms

AUDIO IN 2 L/R

Voltage 2 V, impedance 47 kilohms

MIC (MHC-GPX888 only)

Sensitivity 1 mV, impedance 10 kilohms

ψ (USB) A, ψ (USB) B port

Type A

### Outputs

AUDIO OUT/PARTY CHAIN OUT L/R

Voltage 2 V, impedance 1 kilohm

### USB section

Supported bit rate

WMA:

48 kbps – 192 kbps, VBR, CBR

AAC:

48 kbps – 320 kbps, VBR, CBR

Sampling frequencies

WMA: 44.1 kHz

AAC: 44.1 kHz

Supported USB device

Mass Storage Class

Maximum current

500 mA

### Disc/USB section

Supported bit rate

MPEG1 Layer-3:

32 kbps – 320 kbps, VBR

MPEG2 Layer-3:

8 kbps – 160 kbps, VBR

MPEG1 Layer-2:

32 kbps – 384 kbps, VBR

Sampling frequencies

MPEG1 Layer-3:

32 kHz/44.1 kHz/48 kHz

MPEG2 Layer-3:

16 kHz/22.05 kHz/24 kHz

MPEG1 Layer-2:

32 kHz/44.1 kHz/48 kHz

**Disc player section**

## System

Compact disc and digital audio system

## Laser Diode Properties

Emission Duration: Continuous

Laser Output\*: Less than 44.6  $\mu$ W

\* This output is the value measurement at a distance of 200 mm from the objective lens surface on the Optical Pick-up Block with 7 mm aperture.

## Frequency response

20 Hz – 20 kHz

## Signal-to-noise ratio

More than 90 dB

## Dynamic range

More than 88 dB

**Tuner section**

FM stereo, FM/AM superheterodyne tuner

## Antenna:

FM lead antenna

AM loop antenna

**FM tuner section**

## Tuning range

USA model:

87.5 MHz – 108.0 MHz (100 kHz step)

Other models:

87.5 MHz – 108.0 MHz (50 kHz step)

**AM tuner section**

## Tuning range

Pan American and Australian models:

531 kHz – 1,710 kHz (9 kHz step)

530 kHz – 1,710 kHz (10 kHz step)

Other models:

531 kHz – 1,602 kHz (9 kHz step)

530 kHz – 1,610 kHz (10 kHz step)

**Bluetooth section**

## Communication system

*Bluetooth* Standard version 3.1

## Output

*Bluetooth* Standard Power Class 2

## Maximum communication range

Line of sight approx. 10 m<sup>1)</sup>

## Frequency band

2.4 GHz band (2.4000 GHz – 2.4835 GHz)

## Modulation method

FHSS (Freq Hopping Spread Spectrum)

Compatible *Bluetooth* profiles<sup>2)</sup>

A2DP (Advanced Audio Distribution Profile)

AVRCP 1.3 (Audio Video Remote Control Profile)

SPP (Serial Port Profile)

## Supported codecs

SBC (Sub Band Codec)

AAC (Advanced Audio Coding)

<sup>1)</sup>The actual range will vary depending on factors such as obstacles between devices, magnetic fields around a microwave oven, static electricity, reception sensitivity, antenna's performance, operating system, software application, etc.

<sup>2)</sup>*Bluetooth* standard profiles indicate the purpose of *Bluetooth* communication between devices.

**Speakers****Front speaker**

**SS-GPX888 for MHC-GPX888**

**SS-GPX555 for LBT-GPX555/  
MHC-GPX555**

## Speaker system

2-way, Bass reflex

## Speaker unit

Woofers: 200 mm (7 7/8 in), cone type

Tweeter: 20 mm (13/16 in), horn type

## Rated impedance

4 ohms

Dimensions (w/h/d) (Approx.)

SS-GPX888: 360 mm × 605 mm ×  
320 mm (14 1/4 in × 23 7/8 in ×  
12 5/8 in)

SS-GPX555: 290 mm × 415 mm ×  
320 mm (11 1/2 in × 16 3/8 in ×  
12 5/8 in)

Mass (Approx.)

SS-GPX888: 13.8 kg (30 lb 7 oz)

SS-GPX555: 8.5 kg (18 lb 12 oz)

Quantity: 2 pieces

### **Subwoofer**

**SS-WGP888 for MHC-GPX888**

**SS-WGP555 for LBT-GPX555/**

**MHC-GPX555**

Subwoofer system

1-way, Bass reflex

Speaker unit

Subwoofer: 250 mm (9 7/8 in), cone  
type

Rated impedance

4 ohms

Dimensions (w/h/d) (Approx.)

360 mm × 395 mm × 320 mm  
(14 1/4 in × 15 5/8 in × 12 5/8 in)

Mass (Approx.)

SS-WGP888: 8.3 kg (18 lb 5 oz)

SS-WGP555: 8.7 kg (19 lb 3 oz)

Quantity:

MHC-GPX888: 2 pieces

LBT-GPX555/MHC-GPX555: 1 piece

### **General**

Power requirements

USA model:

AC 120 V, 60 Hz

Mexican model:

AC 120 V – 240 V, 60 Hz

Chilean and Bolivian models:

AC 220 V – 240 V, 50 Hz

Other models:

AC 120 V – 240 V, 50/60 Hz

Power consumption

MHC-GPX888: 360 W

LBT-GPX555/MHC-GPX555: 280 W

Dimensions (w/h/d) (excl. speakers)  
(Approx.)

MHC-GPX888:

294 mm × 361 mm × 331 mm  
(11 5/8 in × 14 1/4 in × 13 1/8 in)

LBT-GPX555/MHC-GPX555:

294 mm × 361 mm × 325 mm  
(11 5/8 in × 14 1/4 in × 12 7/8 in)

Mass (excl. speakers) (Approx.)

5.4 kg (11 lb 15 oz)

Supplied accessories

Remote control (1)

R6 (Size AA) batteries (2)

FM lead/AM loop antenna (1)

Spacer (2) (MHC-GPX888 only)

Speaker pads (16) (MHC-GPX888  
only)

Design and specifications are subject to  
change without notice.



<http://www.sony.net/>



**COMPACT**  
**disc**  
**DIGITAL AUDIO**



©2014 Sony Corporation Printed in Malaysia

\* 4 4 8 5 7 4 6 1 1 \* (1)