



# HP EliteBook 9470m Notebook PC

Maintenance and Service Guide

© Copyright 2012 Hewlett-Packard  
Development Company, L.P.

Bluetooth is a trademark owned by its proprietor and used by Hewlett-Packard Company under license. Intel and Core are U.S. registered trademarks of Intel Corporation. Microsoft, Windows, and Windows Vista are U.S. registered trademarks of Microsoft Corporation. SD Logo is a trademark of its proprietor.

The information contained herein is subject to change without notice. The only warranties for HP products and services are set forth in the express warranty statements accompanying such products and services. Nothing herein should be construed as constituting an additional warranty. HP shall not be liable for technical or editorial errors or omissions contained herein.

First Edition: October 2012

Document Part Number: 709798-001

## Safety warning notice

---

 **WARNING!** To reduce the possibility of heat-related injuries or of overheating the device, do not place the device directly on your lap or obstruct the device air vents. Use the device only on a hard, flat surface. Do not allow another hard surface, such as an adjoining optional printer, or a soft surface, such as pillows or rugs or clothing, to block airflow. Also, do not allow the AC adapter to contact the skin or a soft surface, such as pillows or rugs or clothing, during operation. The device and the AC adapter comply with the user-accessible surface temperature limits defined by the International Standard for Safety of Information Technology Equipment (IEC 60950).

---



---

# Table of contents

<b>1 Product description .....</b>	<b>1</b>
<b>2 External component identification .....</b>	<b>8</b>
Display .....	8
Top .....	9
TouchPad .....	9
Lights .....	10
Buttons and fingerprint reader (select models only) .....	11
Keys – Windows models .....	13
Keys – SUSE Linux models .....	14
Front .....	15
Left .....	16
Right .....	17
Bottom .....	18
<b>3 Illustrated parts catalog .....</b>	<b>20</b>
Service tag and PCID label .....	20
Service tag .....	20
PCID label .....	21
Computer major components .....	22
Display assembly subcomponents .....	26
Mass storage devices .....	28
Miscellaneous parts .....	29
Sequential part number listing .....	30
<b>4 Removal and replacement procedures .....</b>	<b>35</b>
Preliminary replacement requirements .....	35
Tools required .....	35
Service considerations .....	35
Plastic parts .....	35
Cables and connectors .....	35

Drive handling .....	36
Grounding guidelines .....	36
Electrostatic discharge damage .....	36
Packaging and transporting guidelines .....	38
Component replacement procedures .....	40
Battery .....	40
SIM .....	41
Display assembly components (panel, bezel, webcam, microphone) .....	42
Hard drive cover .....	45
Hard drive/SSD drive .....	46
mSATA drive .....	48
RTC battery .....	50
Service cover .....	51
Memory module .....	52
WWAN module .....	54
WLAN module .....	56
Keyboard .....	58
Base enclosure .....	61
Touchpad .....	63
Power connector .....	64
Fan .....	66
System board .....	67
Heat sink .....	70
Speaker assembly .....	72
Smart card board .....	73
Fingerprint reader board .....	75
Display assembly .....	76
<b>5 Computer Setup (BIOS) and Advanced System Diagnostics .....</b>	<b>83</b>
Windows 7 – Computer Setup (BIOS) and Advanced System Diagnostics .....	83
Using Computer Setup .....	83
Starting Computer Setup .....	83
Navigating and selecting in Computer Setup .....	83
Restoring factory settings in Computer Setup .....	84
Updating the BIOS .....	85
Determining the BIOS version .....	85
Downloading a BIOS update .....	85
Using Advanced System Diagnostics .....	86
Windows 8 – Computer Setup (BIOS) and Advanced System Diagnostics .....	87
Using Computer Setup .....	87
Starting Computer Setup .....	87

Navigating and selecting in Computer Setup .....	87
Restoring factory settings in Computer Setup .....	88
Updating the BIOS .....	89
Determining the BIOS version .....	89
Downloading a BIOS update .....	89
Using Advanced System Diagnostics .....	90
SUSE Linux – Computer Setup (BIOS) and Advanced System Diagnostics .....	91
Starting Computer Setup .....	91
Using Computer Setup .....	91
Navigating and selecting in Computer Setup .....	91
Restoring factory settings in Computer Setup .....	92
Updating the BIOS .....	92
Determining the BIOS version .....	93
Downloading a BIOS update .....	93
Using Advanced System Diagnostics .....	94
<b>6 Specifications .....</b>	<b>95</b>
Computer specifications .....	95
35.6-cm (14.0-in) display specifications .....	96
Hard drive specifications .....	97
Solid-state drive specifications .....	98
mSATA drive specifications .....	99
<b>7 Backup and recovery .....</b>	<b>100</b>
Windows 7 – Backup and recovery .....	100
Creating recovery media with HP Recovery Disc Creator .....	100
Creating recovery media .....	101
Backing up your information .....	101
Performing a system recovery .....	102
Using the Windows recovery tools .....	102
Using f11 recovery tools .....	103
Using a Windows 7 operating system DVD (purchased separately) .....	103
Windows 8 – Backup and recovery .....	104
Backing up your information .....	104
Performing a system recovery .....	105
Using the Windows recovery tools .....	105
Using f11 recovery tools .....	106
Using Windows 8 operating system media (purchased separately) .....	106
Using Windows Refresh for quick and easy recovery .....	107
Remove everything and reinstall Windows .....	107
Using HP Software Setup .....	108

SUSE Linux – Backup and recovery .....	109
Creating backups .....	109
Backing up your information .....	109
Performing a system recovery .....	110
USB Recovery option .....	110
Remove everything and reinstall SLED .....	112
<b>8 Power cord set requirements .....</b>	<b>113</b>
Requirements for all countries .....	113
Requirements for specific countries and regions .....	114
<b>9 Recycling .....</b>	<b>115</b>
Battery .....	115
Display .....	115
<b>Index .....</b>	<b>121</b>



# 1 Product description

Category	Description
<b>Product Name</b>	HP EliteBook 9470m Notebook PC
<b>Processors</b>	Intel® Core® processors: <ul style="list-style-type: none"><li>• i3-3217U 1.8-GHz, 3-MB L3 Cache, 17W</li><li>• i5-3317U 1.7-GHz (max turbo frequency 2.6-GHz), 3-MB L3 Cache, 17W</li><li>• i5-3427U 1.7-GHz (max turbo frequency 2.7-GHz), 3-MB L3 Cache, 17W</li><li>• i7-3667U 1.8-GHz (max turbo frequency 2.9-GHz), 4-MB L3 Cache, 17W</li></ul>
<b>Chipset</b>	Mobile Intel QM77
<b>Graphics</b>	Intel UMA Graphics with shared video memory: Intel HD Graphics 4000
<b>Panels</b>	<p>35.6-cm (14.0-in), 3.0-mm, flat/thin backlit, light-emitting diode (LED), high-definition+ (HD+), AntiGlare (AG), SVA (1600×900) display with and without webcam</p> <p>35.6-cm (14.0-in), 3.0-mm, flat/thin backlit, LED, HD, AG, SVA (1366×768) display with and without webcam</p> <p>All display assemblies include two wireless local area network (WLAN) antenna cables and two wireless wide area network (WWAN) antenna cables</p> <p>Supports low voltage differential signalling (LVDS)</p> <p>Supports 16:9 aspect ratio</p> <p>Supports privacy filter</p>
<b>Memory</b>	<p>Two customer-accessible/upgradable memory module slots</p> <p>DDR3 PC3-1600-MHz dual channel support</p> <p>Supports 16384-MB of system RAM in the following configurations:</p> <ul style="list-style-type: none"><li>• 16384-MB (8192-MB×2)</li><li>• 8192-MB (8192-MB×1 or 4096×2)</li><li>• 6144-MB (4096-MB+2048-MB)</li><li>• 4096-MB (4096-MB×1 or 2048-MB×2)</li><li>• 2048-MB (2048×1)</li></ul>

Category	Description
<b>Flash cache</b>	<p>Samsung 32-GB MLC mSATA module, not available on computer models equipped with SSD, SED, or 256 mSATA.</p> <p>Supports no Flash cache module configuration.</p>
<b>Hard drive</b>	<p>Supports 7.0-mm (.28-in), 6.35-cm (2.5-in) hard drives and solid-state drives</p> <p>Customer-accessible</p> <p>Serial ATA</p> <p>Supports the following hard drives:</p> <ul style="list-style-type: none"> <li>• 500-GB, 7200-rpm, self-encrypting drive (SED)</li> <li>• 500-GB, 7200-rpm</li> <li>• 320-GB, 7200-rpm</li> </ul>
<b>Solid-state drive</b>	<p>Solid-state drive (SSD) mounts in the same bracket as the hard drive</p> <p>Customer-accessible</p> <p>Serial ATA III</p> <p>Supports the following SSDs:</p> <ul style="list-style-type: none"> <li>• 256-GB SED</li> <li>• 180-GB</li> </ul>
<b>mSATA module</b>	<p>Supports 256-GB mSATA module</p> <p>No available with flash cache module</p>
<b>Audio and video</b>	<p>Two stereo speakers</p> <p>HD audio with SRS PRO audio</p> <p>Integrated 720p HD webcam (supports no camera option)</p> <p>Integrated dual-array microphone</p>
<b>Ethernet</b>	<p>Intel 82579LM 10/100/1000 Ethernet network interface card (NIC) with iAMT Intel 82579LM Gigabit Network Connection</p> <p>NIC Power Down technology</p> <p>S3/S4/S5 wake on LAN</p> <p>Ethernet cable not included</p>

Category	Description
<b>Wireless</b>	<p>Integrated wireless local area network (WLAN) options by way of wireless module</p> <p>Three WLAN antennas built into display assembly</p> <p>Support for the following WLAN formats:</p> <ul style="list-style-type: none"> <li>• QC/Atheros AR9462 802.11a/b/g/n 2x2 BT4.0 combo</li> <li>• Broadcom 4313GN 802.11b/g/n 1x1 WiFi and 20702 Bluetooth 4.0 Combo Adapter</li> <li>• Intel Centrino Advanced-N 6235</li> <li>• Intel Centrino Advanced-N 6205 WLAN module</li> </ul> <p>Supports no WLAN option</p>
	<p>Integrated wireless wide area network (WWAN) options by way of wireless module</p> <p>Two world-wide/5-band WWAN antennas built into display assembly</p> <p>Secured by subscriber identity module (SIM, user-accessible behind battery)</p> <p>Support for the following WWAN formats:</p> <ul style="list-style-type: none"> <li>• HP It2523 LTE/HSPA+ Mobile Broadband Module</li> <li>• HP It2522 LTE/EV-DO Mobile Broadband Module</li> <li>• HP un2430 EV-DO/HSPA Mobile Broadband Module</li> <li>• HP hs2350 HSPA+ Mobile Broadband Module</li> </ul> <p>Supports no WWAN option</p> <p>Supports WWAN after market option</p>
<b>External media cards</b>	<p>Integrated 54-mm ExpressCard</p> <p>Secure Digital (SD) flash media slot with push-push technology, supporting the following digital card formats:</p> <ul style="list-style-type: none"> <li>• MultiMediaCard (MMC)</li> <li>• MMC+</li> <li>• Secure Digital (SD) Memory Card</li> <li>• SDHC</li> <li>• SDXC</li> </ul>

Category	Description
<b>Ports</b>	Audio-in (mono microphone)
	Audio-out (stereo headphone)
	Battery connector
	DisplayPort 1.1a
	Docking connector
	HP Smart AC adapter
	RJ-45 (Ethernet)
	USB 3.0 ports (2)
	USB 3.0 charging/powered port (1)
	VGA (Dsub 15 pin) supporting: 1920×1200 external resolution @ 75 Hz, hot plug and unplug and autodetection for correct output to wide-aspect vs. standard aspect video
<b>Keyboard/pointing devices</b>	Full chiclet keyboard, backlit, dual-point, spill-resistant with durakeys
	Gesture support: MultiTouch gestures enabled, two-finger scrolling, and pinch-zoom as default
	Taps enabled by default
	Touchpad on/off button
	Touchpad supports 2-way scroll with legend
<b>Power requirements</b>	Supports the following HP Smart AC adapters:
	45-W HP Smart AC adapter (3-wire plug with ground pin)
	Supports the following batteries:
	<ul style="list-style-type: none"> <li>• Primary: 4-cell, 52-Wh, 3.55-Ah battery</li> <li>• Secondary: 6-cell, 60-Wh, 2.7-Ah battery</li> </ul>
<b>Security</b>	Supports security cable lock
	Supports fingerprint reader and no fingerprint reader option
	Supports Trusted Platform Module (TPM) 1.2 (Infineon, soldered down) and TPM Enhanced Drive Lock (not supported the People's Republic of China)
	Integrated Smart Card reader (active)
	Full volume encryption
	HP ProtectTools

---

Category	Description
Operating system	<b>Preinstalled:</b> <ul style="list-style-type: none"><li data-bbox="719 275 1417 325">• Windows® 7 Home Premium 64- and 32-bit with Microsoft Basics (in Canada, Japan, and the United States)</li><li data-bbox="719 352 1461 403">• Windows 7 Professional 64- and 32-bit with Microsoft Basics (in Canada, Japan, and the United States)</li><li data-bbox="719 430 1461 480">• Windows 8 Professional 64 with Windows 7 Professional 32 or 64 image and with Microsoft Basics (in Canada, Japan, and the United States)</li><li data-bbox="719 508 1461 558">• Windows 8 Professional 64 with Microsoft Basics (in Canada, Japan, and the United States)</li><li data-bbox="719 585 1374 636">• Windows 8 64 with Microsoft Basics (in Canada, Japan, and the United States)</li><li data-bbox="719 663 1445 693">• Windows 8 64 with Microsoft Basics (in the People's Republic of China)</li><li data-bbox="719 720 858 749">• FreeDOS</li><li data-bbox="719 777 1098 806">• SUSE Linux SLED (for China only)</li></ul>

---

Category	Description
	<p><b>Preinstalled with Microsoft Office</b></p> <p>Windows 7:</p> <ul style="list-style-type: none"> <li>• Windows 7 Home Basic 32-bit with Office Transition (emerging markets only, not available in Japan)</li> <li>• Windows 7 Home Premium 64- and 32-bit with Office Transition (not available in Japan)</li> <li>• Windows 7 Home Premium 64-bit with Office 2010 Personal (only in Japan)</li> <li>• Windows 7 Home Premium 64-bit with Office 2010 Home and Business (only in Japan)</li> <li>• Windows 7 Home Premium 64-bit with Office 2010 Professional (only in Japan)</li> <li>• Windows 7 Professional 64- and 32-bit with Office 2010 Transition (not available in Japan)</li> <li>• Windows 7 Professional 64- and 32-bit with Office 2010 Home and Business (only in Japan)</li> <li>• Windows 7 Professional 64- and 32-bit with Office 2010 Personal (only in Japan)</li> <li>• Windows 7 Professional 64- and 32-bit with Office 2010 Professional (only in Japan)</li> </ul> <p>Windows 8</p> <ul style="list-style-type: none"> <li>• Windows 8 Professional 64 with Windows 7 Professional 64- and 32 Image with Office 2010 Transition (not available in Japan)</li> <li>• Windows 8 Professional 64 with Windows 7 Professional 64- and 32 Image with Office 2010 Personal (only in Japan)</li> <li>• Windows 8 Professional 64 with Windows 7 Professional 64- and 32 Image with Office 2010 Home and Business (only in Japan)</li> <li>• Windows 8 Professional 64 with Windows 7 Professional 64- and 32 Image with Office 2010 Professional (only in Japan)</li> <li>• Windows 8 Professional 64 Office 2010 Transition (not available in Japan)</li> <li>• Windows 8 Professional 64 Office 2010 Personal (only in Japan)</li> <li>• Windows 8 Professional 64 Office 2010 Home and Business (only in Japan)</li> <li>• Windows 8 Professional 64 Office 2010 Professional (only in Japan)</li> <li>• Windows 8 64 Office 2010 Transition (not available in Japan)</li> <li>• Windows 8 64 Office 2010 Personal (only in Japan)</li> <li>• Windows 8 64 Office 2010 Home and Business (only in Japan)</li> <li>• Windows 8 64 Office 2010 Professional (only in Japan)</li> <li>• Windows 8 64 Office 2010 Transition (emerging markets only, not available in Japan)</li> </ul>

Category	Description
	<p data-bbox="719 222 970 247"><b>Restore media–DR-DVD:</b></p> <ul data-bbox="719 275 1090 401" style="list-style-type: none"> <li data-bbox="719 275 1090 300">• Windows 7 without Windows DVD</li> <li data-bbox="719 323 1062 348">• Windows 7 with Windows DVD</li> <li data-bbox="719 371 874 396">• Windows 8</li> </ul>
	<p data-bbox="719 422 970 447"><b>Restore media–OS-DVD:</b></p> <ul data-bbox="719 474 1166 600" style="list-style-type: none"> <li data-bbox="719 474 1054 499">• Windows 7 Home Basic 32-bit</li> <li data-bbox="719 522 1166 548">• Windows 7 Home Premium 64- and 32-bit</li> <li data-bbox="719 571 1137 596">• Windows 7 Professional 64- and 32-bit</li> </ul>
	<p data-bbox="719 621 815 646"><b>Certified:</b></p> <ul data-bbox="719 674 1090 699" style="list-style-type: none"> <li data-bbox="719 674 1090 699">• SuSE Linux 64-bit Service Pack 2</li> </ul>
	<p data-bbox="719 726 911 751"><b>Web-only support:</b></p> <ul data-bbox="719 779 1118 957" style="list-style-type: none"> <li data-bbox="719 779 991 804">• Windows XP Pro 32-bit</li> <li data-bbox="719 827 1054 852">• Windows 7 Home Basic 64-bit</li> <li data-bbox="719 875 1118 900">• Windows 7 Enterprise 64- and 32-bit</li> <li data-bbox="719 924 1098 949">• Windows 7 Ultimate 64- and 32-bit</li> </ul>
<b>Serviceability</b>	<p data-bbox="719 978 983 1003">End user replaceable parts:</p> <ul data-bbox="719 1031 959 1455" style="list-style-type: none"> <li data-bbox="719 1031 879 1056">• AC adapter</li> <li data-bbox="719 1079 836 1104">• Battery</li> <li data-bbox="719 1127 868 1152">• Hard drive</li> <li data-bbox="719 1176 922 1201">• Solid-state drive</li> <li data-bbox="719 1224 863 1249">• Keyboard</li> <li data-bbox="719 1272 922 1297">• Memory module</li> <li data-bbox="719 1320 959 1346">• mSATA flash cache</li> <li data-bbox="719 1369 906 1394">• WLAN module</li> <li data-bbox="719 1417 916 1442">• WWAN module</li> </ul>

---

## 2 External component identification

### Display



Component	Description
(1) WLAN antennas (2)*	Send and receive wireless signals to communicate with wireless local area networks (WLAN).
(2) WWAN antennas (2)* (select models only)	Send and receive wireless signals to communicate with wireless wide area networks (WWAN).
(3) Internal microphones (2)	Record sound.
(4) Webcam light (select models only)	On: The webcam is in use.
(5) Webcam (select models only)	Records video and captures still photographs.  To use the webcam in Windows 7, select <b>Start &gt; All Programs &gt; HP &gt; HP Webcam</b> .  For information on using the webcam in Windows 8, access Help and Support. From the Start screen, type <code>help</code> , and then select <b>Help and Support</b> from the list of apps.  For information on using the webcam, access Help and Support. From the Start screen, type <code>help</code> , and then select <b>Help and Support</b> from the list of apps.

---



Component	Description
(6) Internal display switch	Turns off the display or initiates Sleep if the display is closed while the power is on.

**NOTE:** The display switch is not visible from the outside of the computer.

\*The antennas are not visible from the outside of the computer. For optimal transmission, keep the areas immediately around the antennas free from obstructions. To see wireless regulatory notices, refer to the section of the *Regulatory, Safety, and Environmental Notices* that applies to your country or region. In Windows 7, these notices are located in Help and Support. In Windows 8, to access this guide, select the **HP Support Assistant** app from the Start screen, select **My computer**, and then select **User guides**.

## Top

### TouchPad

 **NOTE:** Windows 8 keyboard shown.





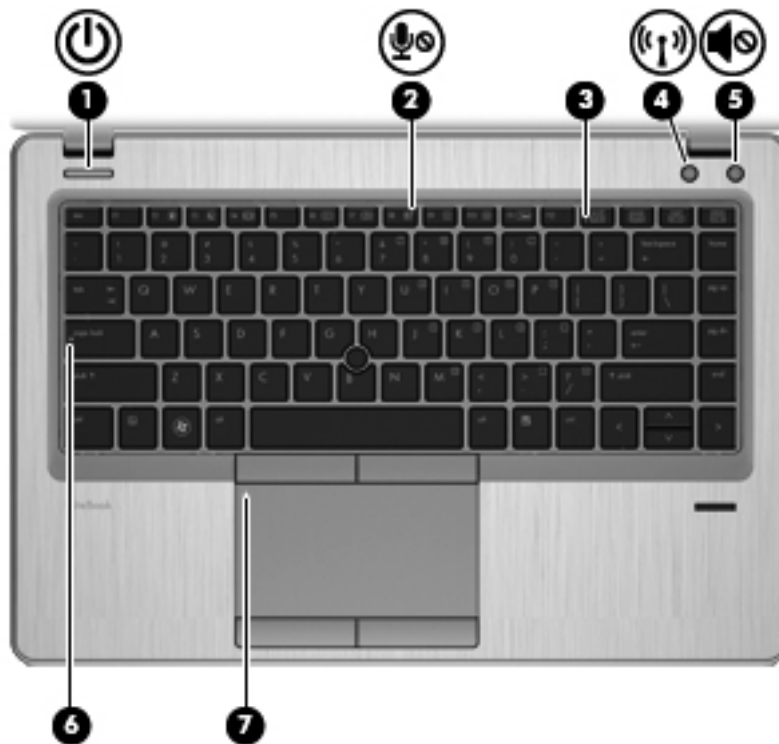

Component	Description
(1) Pointing stick	Moves the pointer and selects or activates items on the screen.
(2) Left pointing stick button	Functions like the left button on an external mouse.
(3) TouchPad on/off button	Turns the TouchPad on and off.
(4) TouchPad zone	Moves the pointer and selects or activates items on the screen.
(5) Left TouchPad button	Functions like the left button on an external mouse.
(6) Right pointing stick button	Functions like the right button on an external mouse.
(7) Right TouchPad button	Functions like the right button on an external mouse.

## Lights



 **NOTE:** Windows 7 keyboard shown.



Component	Description
(1)  Power light	<ul style="list-style-type: none"> <li>On: The computer is on.</li> <li>Blinking: The computer is in the Sleep state.</li> <li>Off: The computer is off or in Hibernation.</li> </ul>
(2)  Microphone mute light	<ul style="list-style-type: none"> <li>On: Microphone is off.</li> <li>Amber: Microphone is on.</li> </ul>
(3) Num lock light	On: Num lock is on.
(4)  Wireless light	<ul style="list-style-type: none"> <li>White: An integrated wireless device, such as a wireless local area network (WLAN) device and/or a Bluetooth® device, is on.</li> <li>Amber: All wireless devices are off.</li> </ul>
(5)  Mute light	<ul style="list-style-type: none"> <li>Amber: Computer sound is off.</li> <li>Off: Computer sound is on.</li> </ul>
(6) Caps lock light	On: Caps lock is on.
(7) TouchPad light	<ul style="list-style-type: none"> <li>Amber: The TouchPad is off.</li> <li>Off: The TouchPad is on.</li> </ul>

## Buttons and fingerprint reader (select models only)

 **NOTE:** Windows 8 keyboard shown.

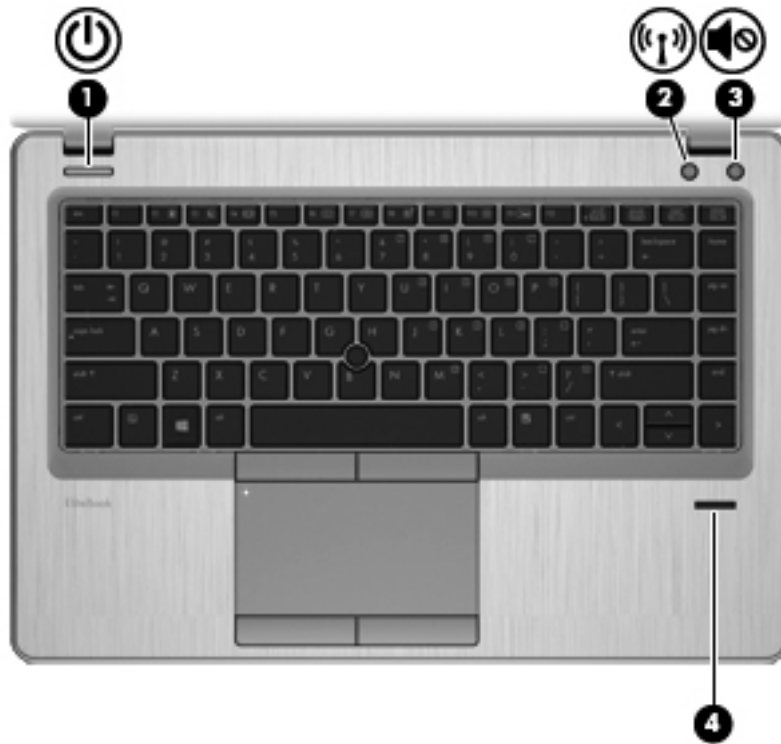



---

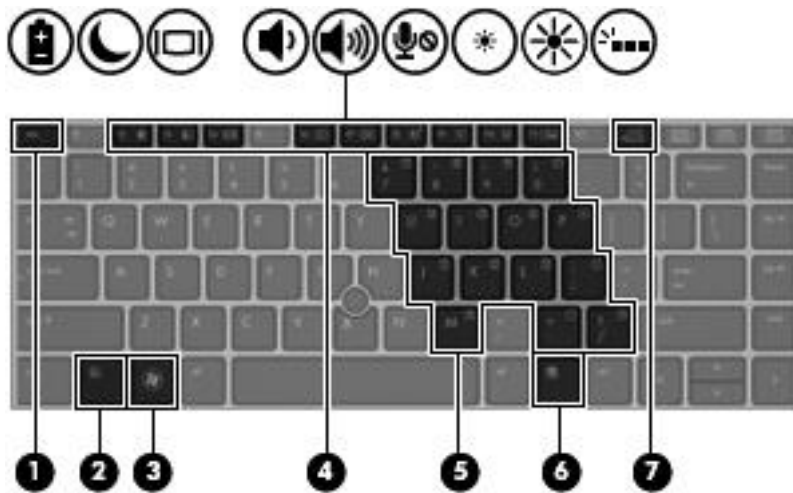

Component	Description
(1)  Power button	<ul style="list-style-type: none"> <li>• When the computer is off, press the button to turn on the computer.</li> <li>• When the computer is on, press the button briefly to initiate Sleep/Suspend.</li> <li>• When the computer is in the Sleep/Suspend state, press the button briefly to exit Sleep/Suspend.</li> <li>• When the computer is in Hibernation, press the button briefly to exit Hibernation.</li> </ul> <p>If the computer has stopped responding and operating system shutdown procedures are ineffective, press and hold the power button for at least 5 seconds to turn off the computer.</p> <p>To learn more about your power settings:</p> <p>In Windows 7:</p> <ul style="list-style-type: none"> <li>• Select <b>Start &gt; Control Panel &gt; System and Security &gt; Power Options</b>.</li> </ul> <p>In Windows 8:</p> <ul style="list-style-type: none"> <li>• See your power options. From the Start screen, type <code>power</code>, select <b>Settings</b>, and then select <b>Power Options</b>.</li> </ul> <p>In SUSE Linux:</p> <ol style="list-style-type: none"> <li>1. Select <b>Computer &gt; Control Center</b>.</li> <li>2. In the left pane, click <b>System</b>, and then click <b>Power Management</b> in the right pane.</li> </ol>
(2)  Wireless button	Turns the wireless feature on or off but does not establish a wireless connection.
(3)  Volume mute button	Mutes and restores speaker sound.
(4) Fingerprint reader (select models only)	Allows a fingerprint logon to Windows, instead of a password logon.

## Keys – Windows models



Component	Description
(1) <a href="#">esc</a> key	Displays system information when pressed in combination with the <a href="#">fn</a> key.
(2) <a href="#">fn</a> key	Executes frequently used system functions when pressed in combination with a function key, the <a href="#">num lk</a> key, or the <a href="#">esc</a> key.
(3)  Windows 7 logo key	Windows 7: Displays the Windows Start menu.
 Windows 8 logo key	Windows 8: Returns you to the Start screen from an open app or the Desktop. <b>NOTE:</b> Pressing the Windows logo key again will return you to the previous screen.
(4) Function keys	Execute frequently used system functions when pressed in combination with the <a href="#">fn</a> key.
(5) Embedded numeric keypad	When the keypad is turned on, it can be used like an external numeric keypad.  Each key on the keypad performs the function indicated by the icon in the upper-right corner of the key.
(6)  Windows 7 applications key	Windows 7: Displays a shortcut menu for items beneath the cursor.
 Windows 8 applications key	Windows 8: Displays options for a selected object.
(7) <a href="#">num lk</a> key	Turns the embedded numeric keypad on and off when pressed in combination with the <a href="#">fn</a> key.



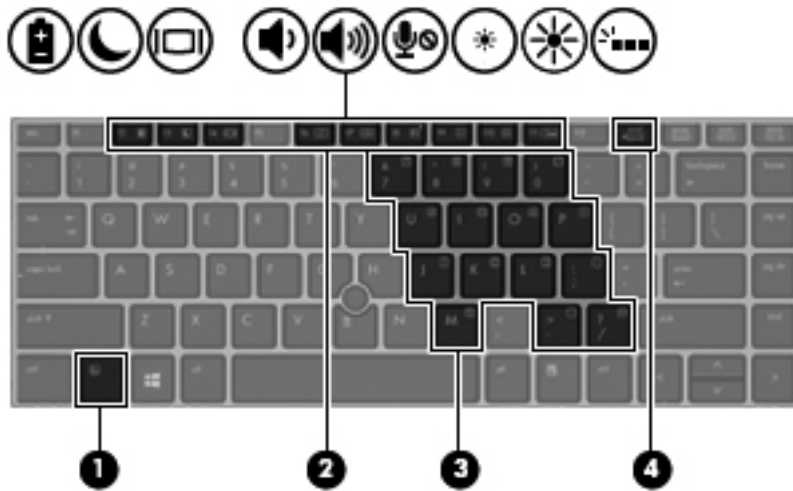

## Keys – SUSE Linux models



Component	Description
(1) <code>fn</code> key	Executes frequently used system functions when pressed in combination with a function key.
(2) Function keys	Execute frequently used system functions when pressed in combination with the <code>fn</code> key. Each key on the keypad performs the function indicated by the icon in the upper-right corner of the key.
(3) Embedded numeric keypad	When the keypad is turned on, it can be used like an external numeric keypad.
(4) <code>num lk</code> key	Turns the embedded numeric keypad on and off when pressed in combination with the <code>fn</code> key.





# Front

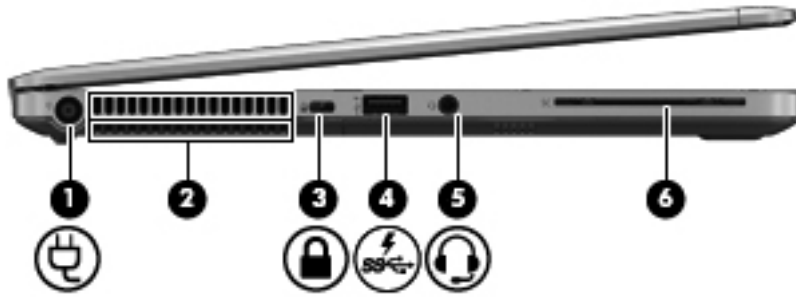

Component	Description
(1)  Wireless light	<ul style="list-style-type: none"> <li>• White: An integrated wireless device, such as a wireless local area network (WLAN) device and/or a Bluetooth® device, is on.</li> <li>• Amber: All wireless devices are off.</li> </ul>
(2)  Power light	<ul style="list-style-type: none"> <li>• On: The computer is on.</li> <li>• Blinking: The computer is in the Sleep/Suspend state.</li> <li>• Off: The computer is off or in Hibernation.</li> </ul>
(3)  Battery light	<ul style="list-style-type: none"> <li>• Amber: The computer is connected to external power and the battery is charged from 0 to 90 percent.</li> <li>• White: The computer is connected to external power and the battery is charged from 90 to 99 percent.</li> <li>• Blinking amber: A battery that is the only available power source has reached a low battery level. When the battery reaches a critical battery level, the battery light begins blinking rapidly.</li> <li>• Off: The battery is fully charged.</li> </ul>
(4)  Hard drive light	<ul style="list-style-type: none"> <li>• Blinking white: The hard drive is being accessed.</li> <li>• Amber: HP 3D DriveGuard has temporarily parked the hard drive.</li> </ul>

# Left







Component	Description
(1)  Power connector	Connects an AC adapter.
(2) Vent	Enables airflow to cool internal components.  <b>NOTE:</b> The computer fan starts up automatically to cool internal components and prevent overheating. It is normal for the internal fan to cycle on and off during routine operation.
(3)  Security cable slot	Attaches an optional security cable to the computer.  <b>NOTE:</b> The security cable is designed to act as a deterrent, but it may not prevent the computer from being mishandled or stolen.
(4)  USB 3.0/USB charging port	Connects an optional USB device. The USB charging port can also charge select models of cell phones and MP3 players, even when the computer is off.
(5)  Audio-out (headphone) jack/Audio-in (microphone) jack	Produces sound when connected to optional powered stereo speakers, headphones, earbuds, a headset, or television audio. Also connects an optional headset microphone.  <b>WARNING!</b> To reduce the risk of personal injury, adjust the volume before putting on headphones, earbuds, or a headset. For additional safety information, refer to the <i>Regulatory, Safety, and Environmental Notices</i> . To access this guide in Windows 8, select the <b>HP Support Assistant</b> app from the Start screen, select <b>My computer</b> , and then select <b>User guides</b> .  <b>NOTE:</b> When a device is connected to the jack, the computer speakers are disabled.  <b>NOTE:</b> Be sure that the device cable has a 4-conductor connector that supports both audio-out (headphone) and audio-in (microphone).
(6) Smart card reader	Supports optional Smart cards.

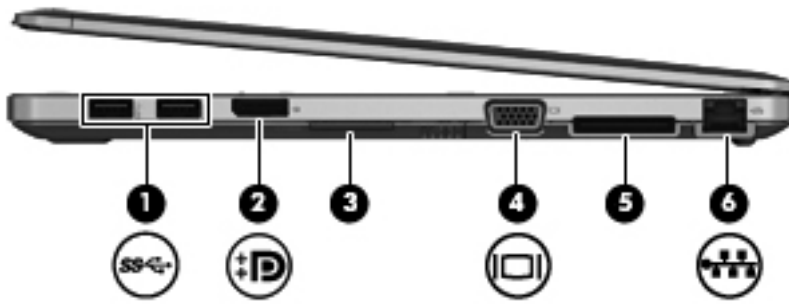

## Right



Component	Description
(1)  USB 3.0 ports (2)	Connect optional USB devices.
(2)  DisplayPort	Connects an optional digital display device, such as a high-performance monitor or projector.
(3) Media Card Reader	Supports the following digital card formats: <ul style="list-style-type: none"><li>• MultiMediaCard (MMC)</li><li>• MultiMediaCardplus (MMC+)</li><li>• Secure Digital (SD) Card</li><li>• Secure Digital High Capacity (SDHC) Card</li><li>• Secure Digital Extra Capacity (SDXC) Card</li></ul>
(4)  External monitor port	Connects an external VGA monitor or projector.
(5) Docking connector	Connects an optional docking device
(6)  RJ-45 (network) jack	Connects a network cable.

# Bottom

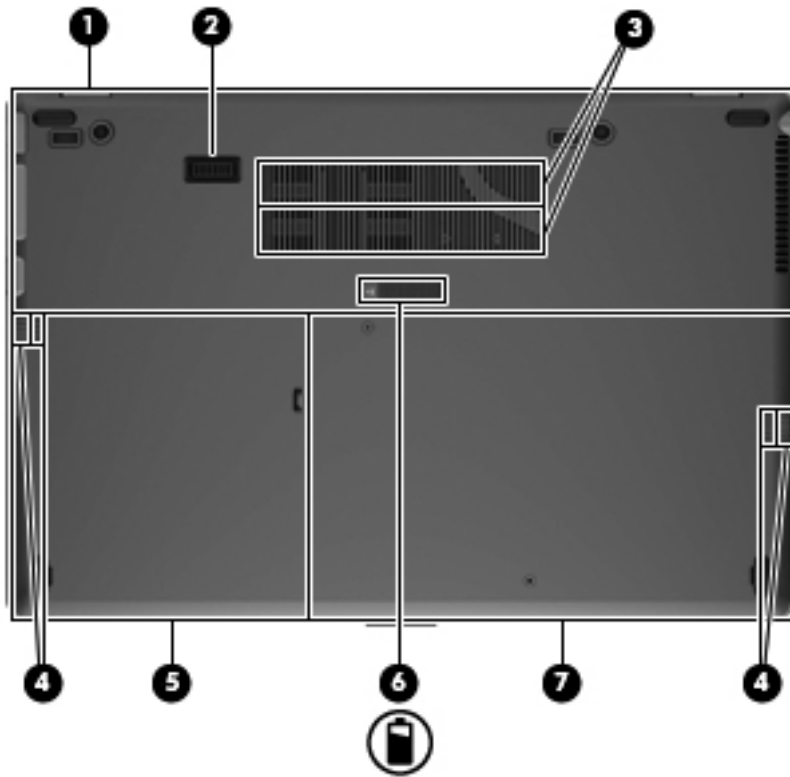

Component	Description
(1) Wireless and memory module compartment	Contains the wireless and memory modules.  <b>CAUTION:</b> To prevent an unresponsive system, replace the wireless module only with a wireless module authorized for use in the computer by the governmental agency that regulates wireless devices in your country or region. If you replace the module and then receive a warning message, remove the module to restore computer functionality, and then contact support through Help and Support. In Windows 8, from the Start screen, type <code>help</code> , and then select <b>Help and Support</b> .
(2) Travel battery connector	Connects an optional travel battery.
(3) Vents (2)	Enable airflow to cool internal components.  <b>NOTE:</b> The computer fan starts up automatically to cool internal components and prevent overheating. It is normal for the internal fan to cycle on and off during routine operation.
(4) Speakers (2)	Produce sound.  <b>NOTE:</b> In Windows 8, to use the SRS Premium Sound software, from the Start screen, type <b>SRS</b> , and then select <b>SRS Premium Sound</b> from the list of apps.
(5) Hard drive bay	Contains the hard drive.

Component	Description
(6) 	Battery release latch Releases the battery from the battery bay.
(7)	Battery bay and SIM slot Contains the battery. Supports a wireless subscriber identity module (SIM). The SIM slot is located inside the battery bay on the right side. <b>NOTE:</b> SIM slot on select models only.

---

## 3 Illustrated parts catalog

### Service tag and PCID label

#### Service tag

When ordering parts or requesting information, provide the computer serial number and model description provided on the service tag.

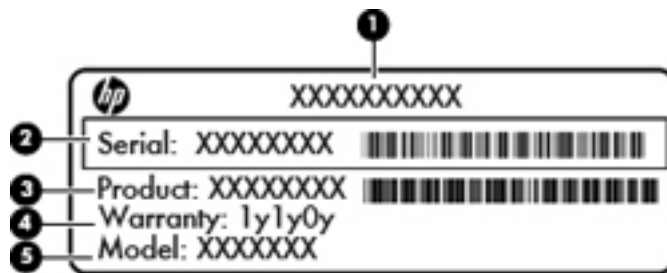

- Product name **(1)**. This is the product name affixed to the front of the computer.
- Serial number (s/n) **(2)**. This is an alphanumeric identifier that is unique to each product.
- Part number/Product number (p/n) **(3)**. This number provides specific information about the product's hardware components. The part number helps a service technician to determine what components and parts are needed.
- Warranty period **(4)**. This number describes the duration (in years) of the warranty period for the computer.
- Model description (select models only) **(5)**. This is the alphanumeric identifier used to locate documents, drivers, and support for the computer.

## PCID label

The PCID label provides the information required to properly reset the notebook firmware (BIOS) back to factory shipped specifications when replacing the system board. The label may have a different number of characters depending on the operating system on the computer.

### Windows 8 models



### Non-Windows 8 models

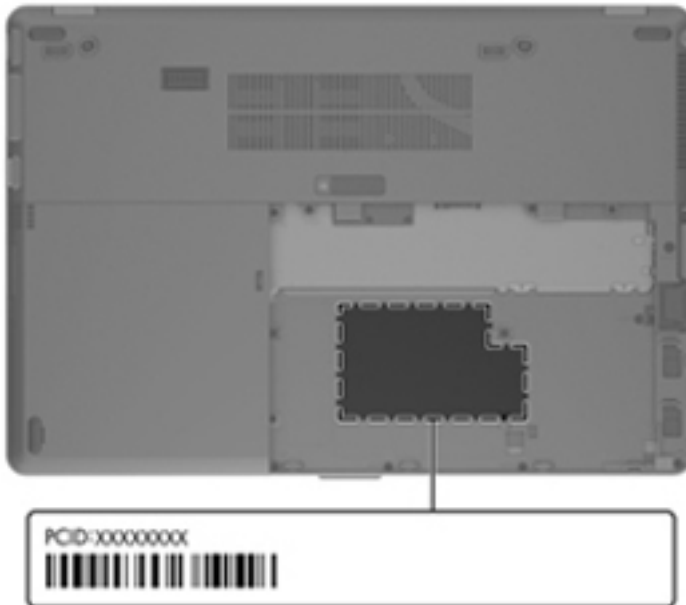

# Computer major components

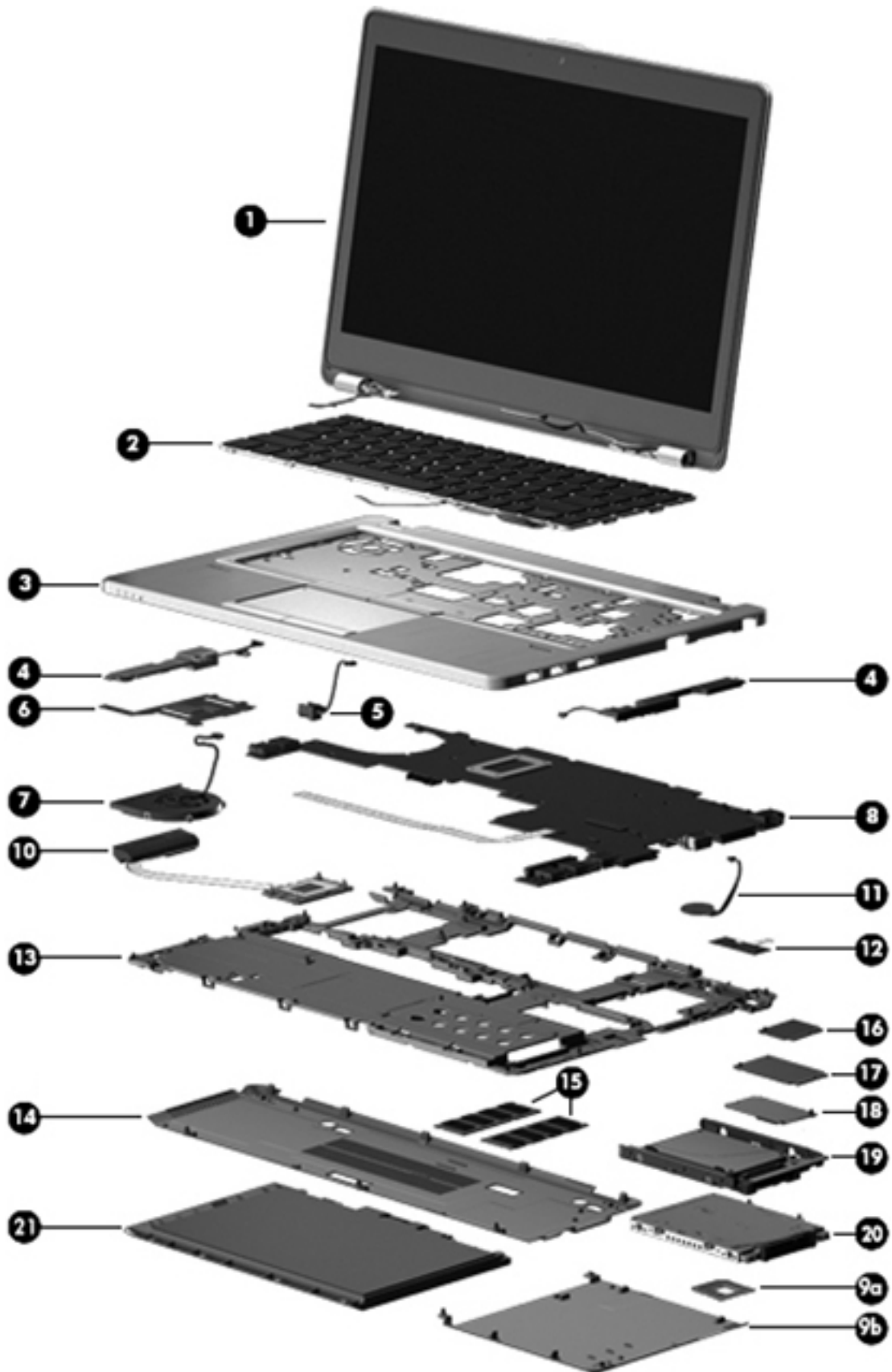

Item	Component	Spare part number
(1)	<b>Display assembly:</b> The display assembly is spared at the subcomponent level only. For more display assembly spare part information, see <a href="#">Display assembly subcomponents on page 26</a> .	
(2)	<b>Keyboard</b> (backlit; includes keyboard cable and pointing stick cable):  <b>NOTE:</b> For a detailed list of available keyboards, see <a href="#">Sequential part number listing on page 30</a> .	702843-xx1
(3)	<b>Top cover</b>	
	With fingerprint reader board	702851-001
	Without fingerprint reader board	702852-001
	With touchpad	702856-001
(4)	<b>Speakers</b> (right and left; include cables)	702869-001
(5)	<b>AC power connector</b>	702875-001
(6)	<b>Smart Card reader</b> (includes cable)	702844-001
(7)	<b>Fan</b> (includes cable)	702859-001
(8)	<b>System board</b> (includes processor and replacement thermal material):	
	For use in models without Windows 8:	
	<ul style="list-style-type: none"> <li>Intel Core i7-3667U processor (2.00 GHz [3.2-GHz max turbo frequency], 4-MB cache)</li> </ul>	702848-001
	<ul style="list-style-type: none"> <li>Intel Core i5-3427U processor (1.80 GHz [2.8-GHz max turbo frequency], 3-MB cache)</li> </ul>	702849-001
	<ul style="list-style-type: none"> <li>Intel Core i5-3317U processor (1.70 GHz [2.6-GHz max turbo frequency], 3-MB cache)</li> </ul>	704439-001
	<ul style="list-style-type: none"> <li>Intel Core i3-3217U processor (1.80 GHz, 3-MB cache)</li> </ul>	702847-001
	For use in Windows 8 models:	
	<ul style="list-style-type: none"> <li>Intel Core i7-3667U processor (2.00 GHz [3.2-GHz max turbo frequency], 4-MB cache) for use in models with Windows 8 Standard</li> </ul>	702848-501
	<ul style="list-style-type: none"> <li>Intel Core i7-3667U processor (2.00 GHz [3.2-GHz max turbo frequency], 4-MB cache) for use in models with Windows 8 Professional</li> </ul>	702848-601
	<ul style="list-style-type: none"> <li>Intel Core i5-3427U processor (1.80 GHz [2.8-GHz max turbo frequency], 3-MB cache) for use in models with Windows 8 Standard</li> </ul>	702849-501
	<ul style="list-style-type: none"> <li>Intel Core i5-3427U processor (1.80 GHz [2.8-GHz max turbo frequency], 3-MB cache) for use in models with Windows 8 Professional</li> </ul>	702849-601
	<ul style="list-style-type: none"> <li>Intel Core i5-3317U processor (1.70 GHz [2.6-GHz max turbo frequency], 3-MB cache) for use in models with Windows 8 Standard</li> </ul>	704439-501
	<ul style="list-style-type: none"> <li>Intel Core i5-3317U processor (1.70 GHz [2.6-GHz max turbo frequency], 3-MB cache) for use in models with Windows 8 Professional</li> </ul>	704439-601
	<ul style="list-style-type: none"> <li>Intel Core i3-3217U processor (1.80 GHz, 3-MB cache) for use in models with Windows 8 Standard</li> </ul>	702847-501
	<ul style="list-style-type: none"> <li>Intel Core i3-3217U processor (1.80 GHz, 3-MB cache) for use in models with Windows 8 Professional</li> </ul>	702847-601
	<b>Plastics Kit</b> , includes:	702877-001

Item	Component	Spare part number
(9a)	SD card insert	
(9b)	Hard drive cover	
(10)	<b>Heat sink</b> (includes replacement thermal material):	707907-001
(11)	<b>RTC battery</b>	702853-001
(12)	<b>Fingerprint reader board</b> (includes cable)	702845-001
(13)	<b>Base enclosure</b>	702863-001
(14)	<b>Service cover</b>	704441-001
(15)	<b>Memory modules</b> (PC3-12800, 1666-MHz, DDR3):	
	8-GB	634091-001
	4-GB	641369-001
	2-GB	652972-001
(16)	<b>WLAN module:</b>	
	Broadcom 4313GN 802.11b/g/n 1x1 WiFi and 20702 Bluetooth 4.0 Combo Adapter	657325-001
	Intel Centrino Advanced-N 6235	670292-001
	Intel Centrino Advanced-N 6205	631954-001
	QC/Atheros AR9462 802.11a/b/g/n 2x2 BT4.0 combo	676786-001
(17)	<b>WWAN module:</b>	
	HP It2523 LTE/HSPA+ Mobile Broadband Module	675793-001
	HP It2522 LTE/EV-DO Mobile Broadband Module	675791-001
	HP un2430 EV-DO/HSPA Mobile Broadband Module	634400-001
	HP hs2350 HSPA+ Mobile Broadband Module	668969-001
	HP un2430 EV-DO/HSPA Mini Card	702080-001
	HP hs2350 hspa+ Mobile Broadband Module	710788-001
	HP It2522 LTE/EV-DO Mobile Broadband Module	710789-001
	HP It2523 LTE/HSPA+ Mobile Broadband Module	710790-001
(18)	<b>mSATA drive:</b>	
	256-GB mSATA drive	702866-001
	32-GB mSATA drive	702867-001
	24-GB mSATA drive	702868-001
	<b>Hard Drive Hardware Kit</b> (not illustrated, includes hard drive bracket, connector, and screws)	702870-001
(19)	<b>Solid-state drive</b> (includes bracket, connector, and screws):	
	256-GB, SATA III, self-encrypting drive (SED)	702865-001
	180-GB, SATA III	702864-001
(20)	<b>Hard drive</b> (does not include hard drive bracket, connector, or screws):	



<b>Item</b>	<b>Component</b>	<b>Spare part number</b>
	500-GB, 7200-rpm, 7-mm self-encrypting drive	703268-001
	500-GB, 7200-rpm, 7-mm	703267-001
	320-GB, 7200-rpm, 2.5-inch	603783-001
<b>(21)</b>	<b>Battery (Li ion):</b>	
	4-cell, 52-Wh, 3.55-Ah	687945-001
	6-cell, 60-Wh, 2.7-Ah (travel battery; not illustrated)	696621-001

## Display assembly subcomponents

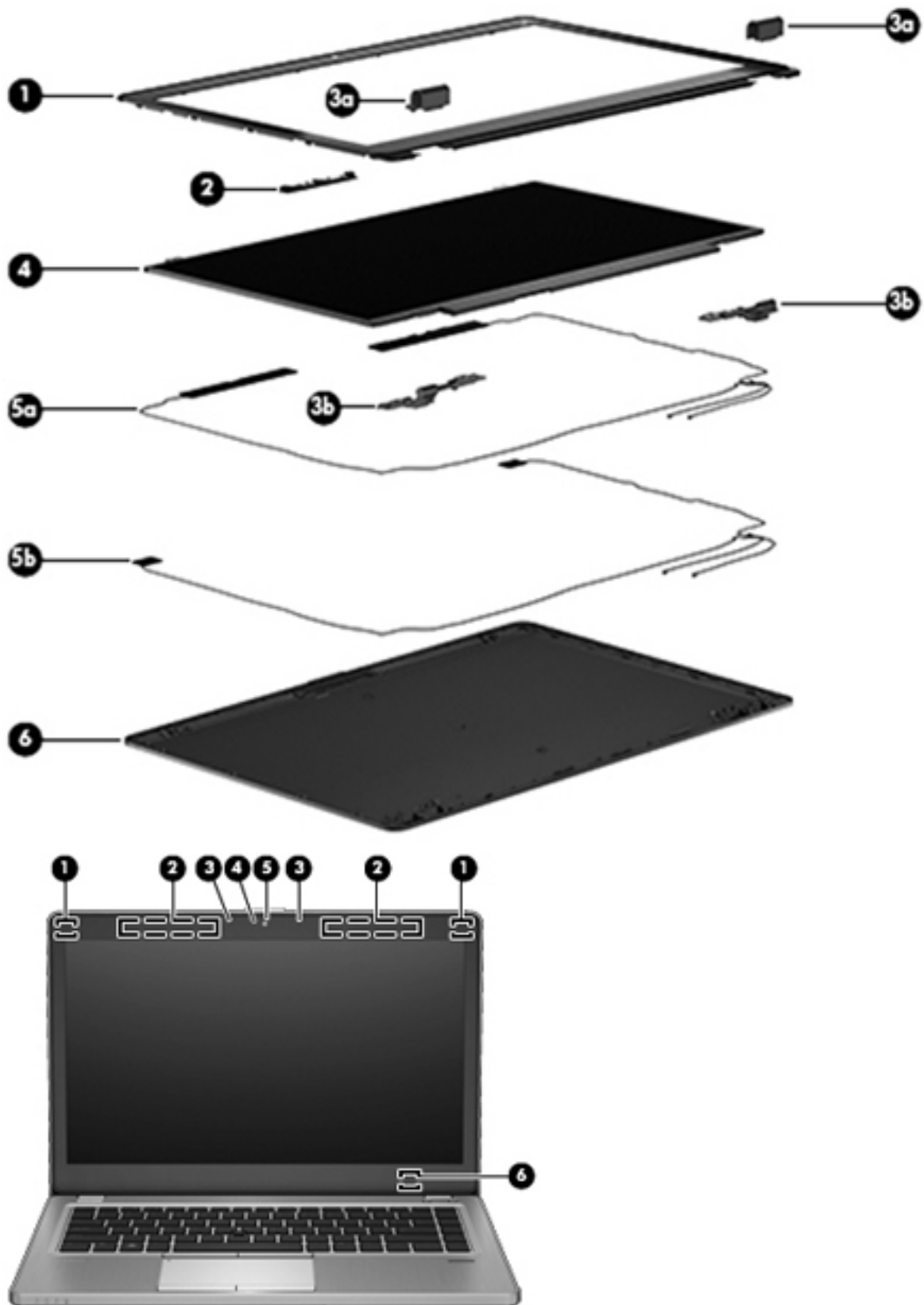

<b>Item</b>	<b>Component</b>	<b>Spare part number</b>
<b>(1)</b>	<b>Display bezel:</b>	
	For use on models with a webcam	702860-001
	For use on models without a webcam	702861-001
<b>(2)</b>	<b>Webcam/microphone module</b>	702854-001
	<b>Microphone module</b>	702873-001
	<b>Display Hinge Kit</b> (includes left and right display hinges and left and right hinge covers)	702857-001
<b>(3a)</b>	Display hinge covers (2)	
<b>(3b)</b>	Display hinges	
<b>(4)</b>	<b>35.6-cm (14.0-in), LED, AntiGlare display panel:</b>	
	HD+	708771-001
	HD	702871-001
	<b>Antenna Kit</b> , includes:	702876-001
<b>(5a)</b>	WWAN antenna cables and transceivers	
<b>(5b)</b>	WLAN antenna cables and transceivers	
<b>(6)</b>	<b>Display enclosure</b>	702858-001
	<b>Display Panel Support Kit</b> (includes WLAN antenna cables and transceivers, WWAN antenna cables and transceivers, and display enclosure)	702842-001

## Mass storage devices

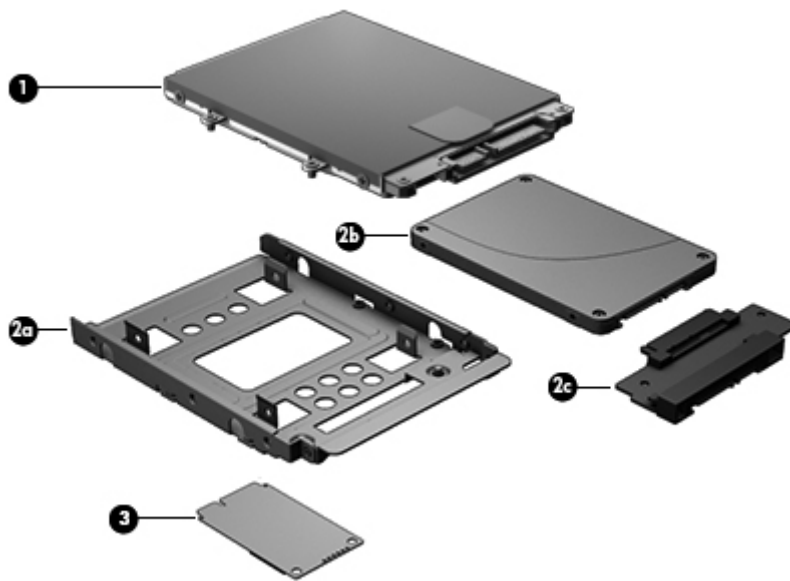

Item	Description	Spare part number
(1)	<b>Hard drive</b> (does not include hard drive bracket or screws):	
	500-GB, 7200-rpm, 7-mm SED	703268-001
	500-GB, 7200-rpm, 7-mm	703267-001
	320-GB, 7200-rpm, 9.5-mm	603783-001
	<b>Solid-State Drive</b> (includes drive bracket, connector, and screws):	
	256-GB, SATA III, self-encrypting drive (SED)	702865-001
	180-GB, SATA III	702864-001
(2a)	Solid-state drive bracket	
(2b)	Solid-state drive	
(2c)	Drive connector	
(3)	<b>mSATA drive:</b>	
	256-GB mSATA drive	702866-001
	32-GB mSATA drive	702867-001
	24-GB mSATA drive	702868-001
	<b>Hard Drive Hardware Kit</b> (not illustrated), includes:	702870-001
	Hard drive connector	
	Hard drive bracket	
	Hard drive bracket screws	

## Miscellaneous parts

<b>Component</b>	<b>Spare part number</b>
<b>AC adapter:</b>	
45-W HP Smart AC adapter (non-PFC)	696694-001
65-W HP Smart AC adapter	609939-001
<b>Optical mouse:</b>	
HP USB optical travel mouse	434594-001
Wireless, 2.4-GHz	656840-001
<b>Power cord (3-pin, black, 1.83-m):</b>	
For use in Argentina	490371-D01
For use in Australia	490371-011
For use in Brazil	490371-202
For use in Europe	490371-021
For use in India	490371-D61
For use in Israel	490371-BB1
For use in Japan	490371-291
For use in North America	490371-001
For use in the People's Republic of China	490371-AA1
For use in South Africa	490371-AR1
For use in South Korea	490371-AD1
For use in Switzerland	490371-111
For use in Taiwan	490371-AB1
For use in Thailand	490371-201
<b>Screw Kit</b>	702846-001
<b>Docking station</b>	702878-001
<b>Cable lock docking station</b>	575921-001
<b>Business Slim Top Load Case</b>	688850-001

## Sequential part number listing

CSR flag designations:

A = Mandatory

B = Optional

C = Service technician recommended

N = Non-user replaceable

Spare part number	CSR flag	Description
434594-001	A	HP USB optical travel mouse
490371-001	A	Power cord for use in North America (3-pin, black, 1.83-m)
490371-011	A	Power cord for use in Australia (3-pin, black, 1.83-m)
490371-021	A	Power cord for use in Europe (3-pin, black, 1.83-m)
490371-111	A	Power cord for use in Switzerland (3-pin, black, 1.83-m)
490371-201	A	Power cord for use in Thailand (3-pin, black, 1.83-m)
490371-202	A	Power cord for use in Brazil (3-pin, black, 1.83-m)
490371-291	A	Power cord for use in Japan (3-pin, black, 1.83-m)
490371-AA1	A	Power cord for use in the People's Republic of China (3-pin, black, 1.83-m)
490371-AB1	A	Power cord for use in Taiwan (3-pin, black, 1.83-m)
490371-AD1	A	Power cord for use in South Korea (3-pin, black, 1.83-m)
490371-AR1	A	Power cord for use in South Africa (3-pin, black, 1.83-m)
490371-BB1	A	Power cord for use in Israel (3-pin, black, 1.83-m)
490371-D01	A	Power cord for use in Argentina (3-pin, black, 1.83-m)
490371-D61	A	Power cord for use in India (3-pin, black, 1.83-m)
575921-001	A	Cable lock docking station
603783-001	A	320-GB, 7200-rpm, 7-mm hard drive (does not include hard drive bracket, connector, or screws)  <b>NOTE:</b> The hard drive bracket, connectors, and screws are included in the Hard Drive Hardware Kit, spare part number 702870-001.
609939-001	A	65-W HP Smart AC adapter
631954-001	A	Intel Centrino Advanced-N 6205 WLAN module
634091-001	A	8-GB memory module (PC3, 12800, 1600-MHz)
634400-001	A	HP un2430 EV-DO/HSPA Mobile Broadband Module
641369-001	A	4-GB memory module (PC3, 12800, 1600-MHz)
652972-001	A	2-GB memory module (PC3, 12800, 1600-MHz)
656840-001	A	Wireless, 2.4-GHz mouse
657325-001	A	Broadcom 4313GN 802.11b/g/n 1x1 WiFi and 20702 Bluetooth 4.0 Combo Adapter

<b>Spare part number</b>	<b>CSR flag</b>	<b>Description</b>
676786-001	A	QC/Atheros AR9462 802.11a/b/g/n 2x2 BT4.0 combo
668969-001	A	HP hs2350 HSPA+ Mobile Broadband Module
670292-001	A	Intel Centrino Advanced-N 6235
675791-001	A	HP It2522 LTE/EV-DO Mobile Broadband Module
675793-001	A	HP It2523 LTE/HSPA+ Mobile Broadband Module
687945-001	A	4-cell, 52-Wh, 3.55-Ah, Li-ion battery
688850-001	A	Business Slim Top Load Case
696621-001	A	6-cell, 51-Wh, 2.55-Ah, Li-ion travel battery
696694-001	A	45-W HP Smart AC adapter (non-PFC)
702080-001	A	HP un2430 EV-DO/HSPA Mini Card
702842-001	N	Display Panel Support Kit (includes display enclosure, WLAN antenna cables and transceivers, and WWAN antenna cables and transceivers)
702843-001	B	Keyboard with pointing stick for use in the United States (includes keyboard cable and pointing stick cable)
702843-031	B	Keyboard with pointing stick for use in the United Kingdom and Singapore (includes keyboard cable and pointing stick cable)
702843-041	B	Keyboard with pointing stick for use in Germany (includes keyboard cable and pointing stick cable)
702843-051	B	Keyboard with pointing stick for use in France (includes keyboard cable and pointing stick cable)
702843-061	B	Keyboard with pointing stick for use in Italy (includes keyboard cable and pointing stick cable)
702843-071	B	Keyboard with pointing stick for use in Spain (includes keyboard cable and pointing stick cable)
702843-081	B	Keyboard with pointing stick for use in Denmark (includes keyboard cable and pointing stick cable)
702843-091	B	Keyboard with pointing stick for use in Norway (includes keyboard cable and pointing stick cable)
702843-131	B	Keyboard with pointing stick for use in Portugal (includes keyboard cable and pointing stick cable)
702843-141	B	Keyboard with pointing stick for use in Turkey (includes keyboard cable and pointing stick cable)
702843-151	B	Keyboard for use in Greece (includes keyboard cable and pointing stick cable)
702843-161	B	Keyboard with pointing stick for use in Latin America (includes keyboard cable and pointing stick cable)
702843-171	B	Keyboard with pointing stick for use in Saudi Arabia (includes keyboard cable and pointing stick cable)
702843-201	B	Keyboard with pointing stick for use in Brazil (includes keyboard cable and pointing stick cable)
702843-211	B	Keyboard with pointing stick for use in Hungary (includes keyboard cable and pointing stick cable)
702843-251	B	Keyboard with pointing stick for use in Russia (includes keyboard cable and pointing stick cable)
702843-261	B	Keyboard with pointing stick for use in Bulgaria (includes keyboard cable and pointing stick cable)
702843-271	B	Keyboard with pointing stick for use in Romania (includes keyboard cable and pointing stick cable)
702843-281	B	Keyboard with pointing stick for use in Thailand (includes keyboard cable and pointing stick cable)
702843-291	B	Keyboard with pointing stick for use in Japan (includes keyboard cable and pointing stick cable)

Spare part number	CSR flag	Description
702843-A41	B	Keyboard with pointing stick for use in Belgium (includes keyboard cable and pointing stick cable)
702843-AB1	B	Keyboard with pointing stick for use in Taiwan (includes keyboard cable and pointing stick cable)
702843-AD1	B	Keyboard with pointing stick for use in South Korea (includes keyboard cable and pointing stick cable)
702843-B31	B	Keyboard with pointing stick for use in the Netherlands (includes keyboard cable and pointing stick cable)
702843-B71	B	Keyboard with pointing stick for use in Sweden and Finland (includes keyboard cable and pointing stick cable)
702843-BA1	B	Keyboard with pointing stick for use in Slovenia (includes keyboard cable and pointing stick cable)
702843-BB1	B	Keyboard with pointing stick for use in Israel (includes keyboard cable and pointing stick cable)
702843-BG1	B	Keyboard with pointing stick for use in Switzerland (includes keyboard cable and pointing stick cable)
702843-D61	B	Keyboard with pointing stick for use in India (includes keyboard cable and pointing stick cable)
702843-DB1	B	Keyboard with pointing stick for use in Canada (includes keyboard cable and pointing stick cable)
702843-DD1	B	Keyboard with pointing stick for use in Iceland (includes keyboard cable and pointing stick cable)
702843-FL1	B	Keyboard with pointing stick for use in the Czech Republic and Slovakia (includes keyboard cable and pointing stick cable)
702843-FP1	B	Keyboard with pointing stick for use in northwest Africa (includes keyboard cable and pointing stick cable)
702844-001	N	Smart Card reader (includes cable)
702845-001	N	Fingerprint reader board (includes cable)
702846-001	N	Screw Kit
702847-001	N	System board with Intel Core i3-3217U processor (1.80 GHz, 3-MB cache) for use in models without Windows 8
702847-501	N	System board with Intel Core i3-3217U processor (1.80 GHz, 3-MB cache) for use in models with Windows 8 Standard
702847-601	N	System board with Intel Core i3-3217U processor (1.80 GHz, 3-MB cache) for use in models with Windows 8 Professional
702848-001	N	System board with Intel Core i7-3667U processor (2.00 GHz [3.2-GHz max turbo frequency], 4-MB cache) for use in models without Windows 8
702848-501	N	System board with Intel Core i7-3667U processor (2.00 GHz [3.2-GHz max turbo frequency], 4-MB cache) for use in models with Windows 8 Standard
702848-601	N	System board with Intel Core i7-3667U processor (2.00 GHz [3.2-GHz max turbo frequency], 4-MB cache) for use in models with Windows 8 Professional
702849-001	N	System board with Intel Core i5-3427U processor (1.80 GHz [2.8-GHz max turbo frequency], 3-MB cache) for use in models without Windows 8
702849-501	N	System board with Intel Core i5-3427U processor (1.80 GHz [2.8-GHz max turbo frequency], 3-MB cache) for use in models with Windows 8 Standard
702849-601	N	System board with Intel Core i5-3427U processor (1.80 GHz [2.8-GHz max turbo frequency], 3-MB cache) for use in models with Windows 8 Professional
702851-001	N	Top cover with fingerprint reader board
702852-001	N	Top cover without fingerprint reader board



Spare part number	CSR flag	Description
702853-001	B	RTC battery (includes cable and double-sided tape)
702854-001	N	Webcam/microphone module (includes double-sided tape)
702856-001	N	Top cover with Touchpad
702857-001	N	Display Hinge Kit (includes left and right hinges and left and right hinge covers)
702858-001	N	Display enclosure
702859-001	N	Fan (includes cable)
702860-001	N	Display bezel for use on models with a webcam
702861-001	N	Display bezel for use on models without a webcam
702863-001	N	Base enclosure
702864-001	A	Solid-state drive, 180-GB, SATA III (includes bracket, connector, and screws)
702865-001	A	Solid-state drive, 256-GB, SATA III, self-encrypting drive (SED) (includes bracket, connector, and screws)
702866-001	A	256-GB mSATA drive
702867-001	A	32-GB mSATA drive
702868-001	A	24-GB mSATA drive
702869-001	N	Speaker assembly (includes cable)
702870-001	A	Hard Drive Hardware Kit (includes hard drive bracket, connector, and screws)
702871-001	N	35.6-cm (14.0-in), LED, HD, AntiGlare display panel
702873-001	N	Microphone module
702875-001	A	AC power connector
702876-001	N	Antenna Kit (includes left and right WLAN antenna cables and transceivers and left and right WWAN antenna cables and transceivers)
702877-001	N	Plastics Kit (includes SD slot insert and hard drive cover)
702878-001	A	Docking station
703267-001	A	500-GB, 7200-rpm, 7-mm hard drive (does not include hard drive bracket, connector, or screws) <b>NOTE:</b> The hard drive bracket, connector, and screws are included in the Hard Drive Hardware Kit, spare part number 702870-001.
703268-001	A	500-GB, 7200-rpm, 9.5-mm SED hard drive (does not include hard drive bracket, connector, or screws) <b>NOTE:</b> The hard drive bracket, connector, and screws are included in the Hard Drive Hardware Kit, spare part number 702870-001.
704439-001	N	System board with Intel Core i5-3317U processor (1.70 GHz [2.6-GHz max turbo frequency], 3-MB cache) for use in models without Windows 8
704439-501	N	System board with Intel Core i5-3317U processor (1.70 GHz [2.6-GHz max turbo frequency], 3-MB cache) for use in models with Windows 8 Standard
704439-601	N	System board with Intel Core i5-3317U processor (1.70 GHz [2.6-GHz max turbo frequency], 3-MB cache) for use in models with Windows 8 Professional

<b>Spare part number</b>	<b>CSR flag</b>	<b>Description</b>
704441-001	A	Service cover
707907-001	N	Heat sink
708771-001	N	35.6-cm (14.0-in), LED, HD+, AntiGlare display panel
710788-001	A	HP hs2350 hspa+ Mobile Broadband Module
710789-001	A	HP It2522 LTE/EV-DO Mobile Broadband Module
710790-001	A	HP It2523 LTE/HSPA+ Mobile Broadband Module

---

# 4 Removal and replacement procedures

## Preliminary replacement requirements

### Tools required

You will need the following tools to complete the removal and replacement procedures:

- Flat-bladed screw driver
- Magnetic screw driver
- Phillips P0 and P1 screw drivers

### Service considerations

The following sections include some of the considerations that you must keep in mind during disassembly and assembly procedures.

---

 **NOTE:** As you remove each subassembly from the computer, place the subassembly (and all accompanying screws) away from the work area to prevent damage.

---

### Plastic parts

---

 **CAUTION:** Using excessive force during disassembly and reassembly can damage plastic parts. Use care when handling the plastic parts. Apply pressure only at the points designated in the maintenance instructions.

---

### Cables and connectors

---

 **CAUTION:** When servicing the computer, be sure that cables are placed in their proper locations during the reassembly process. Improper cable placement can damage the computer.

---

Cables must be handled with extreme care to avoid damage. Apply only the tension required to unseat or seat the cables during removal and insertion. Handle cables by the connector whenever possible. In all cases, avoid bending, twisting, or tearing cables. Be sure that cables are routed in such a way that they cannot be caught or snagged by parts being removed or replaced. Handle flex cables with extreme care; these cables tear easily.

## Drive handling

---

**⚠ CAUTION:** Drives are fragile components that must be handled with care. To prevent damage to the computer, damage to a drive, or loss of information, observe these precautions:

Before removing or inserting a hard drive, shut down the computer. If you are unsure whether the computer is off or in Hibernation, turn the computer on, and then shut it down through the operating system.

Before handling a drive, be sure that you are discharged of static electricity. While handling a drive, avoid touching the connector.

Before removing a diskette drive or optical drive, be sure that a diskette or disc is not in the drive and be sure that the optical drive tray is closed.

Handle drives on surfaces covered with at least one inch of shock-proof foam.

Avoid dropping drives from any height onto any surface.

After removing a hard drive, an optical drive, or a diskette drive, place it in a static-proof bag.

Avoid exposing an internal hard drive to products that have magnetic fields, such as monitors or speakers.

Avoid exposing a drive to temperature extremes or liquids.

If a drive must be mailed, place the drive in a bubble pack mailer or other suitable form of protective packaging and label the package "FRAGILE."

---

## Grounding guidelines

### Electrostatic discharge damage

Electronic components are sensitive to electrostatic discharge (ESD). Circuitry design and structure determine the degree of sensitivity. Networks built into many integrated circuits provide some protection, but in many cases, ESD contains enough power to alter device parameters or melt silicon junctions.

A discharge of static electricity from a finger or other conductor can destroy static-sensitive devices or microcircuitry. Even if the spark is neither felt nor heard, damage may have occurred.

An electronic device exposed to ESD may not be affected at all and can work perfectly throughout a normal cycle. Or the device may function normally for a while, then degrade in the internal layers, reducing its life expectancy.

---

**⚠ CAUTION:** To prevent damage to the computer when you are removing or installing internal components, observe these precautions:

Keep components in their electrostatic-safe containers until you are ready to install them.

Before touching an electronic component, discharge static electricity by using the guidelines described in this section.

Avoid touching pins, leads, and circuitry. Handle electronic components as little as possible.

If you remove a component, place it in an electrostatic-safe container.

---

The following table shows how humidity affects the electrostatic voltage levels generated by different activities.

 **CAUTION:** A product can be degraded by as little as 700 V.

Typical electrostatic voltage levels			
Event	Relative humidity		
	10%	40%	55%
Walking across carpet	35,000 V	15,000 V	7,500 V
Walking across vinyl floor	12,000 V	5,000 V	3,000 V
Motions of bench worker	6,000 V	800 V	400 V
Removing DIPS from plastic tube	2,000 V	700 V	400 V
Removing DIPS from vinyl tray	11,500 V	4,000 V	2,000 V
Removing DIPS from Styrofoam	14,500 V	5,000 V	3,500 V
Removing bubble pack from PCB	26,500 V	20,000 V	7,000 V
Packing PCBs in foam-lined box	21,000 V	11,000 V	5,000 V

## Packaging and transporting guidelines

Follow these grounding guidelines when packaging and transporting equipment:

- To avoid hand contact, transport products in static-safe tubes, bags, or boxes.
- Protect ESD-sensitive parts and assemblies with conductive or approved containers or packaging.
- Keep ESD-sensitive parts in their containers until the parts arrive at static-free workstations.
- Place items on a grounded surface before removing items from their containers.
- Always be properly grounded when touching a component or assembly.
- Store reusable ESD-sensitive parts from assemblies in protective packaging or nonconductive foam.
- Use transporters and conveyors made of antistatic belts and roller bushings. Be sure that mechanized equipment used for moving materials is wired to ground and that proper materials are selected to avoid static charging. When grounding is not possible, use an ionizer to dissipate electric charges.

## Workstation guidelines

Follow these grounding workstation guidelines:

- Cover the workstation with approved static-shielding material.
- Use a wrist strap connected to a properly grounded work surface and use properly grounded tools and equipment.
- Use conductive field service tools, such as cutters, screw drivers, and vacuums.
- When fixtures must directly contact dissipative surfaces, use fixtures made only of static-safe materials.
- Keep the work area free of nonconductive materials, such as ordinary plastic assembly aids and Styrofoam.
- Handle ESD-sensitive components, parts, and assemblies by the case or PCM laminate. Handle these items only at static-free workstations.
- Avoid contact with pins, leads, or circuitry.
- Turn off power and input signals before inserting or removing connectors or test equipment.

## Equipment guidelines

Grounding equipment must include either a wrist strap or a foot strap at a grounded workstation.

- When seated, wear a wrist strap connected to a grounded system. Wrist straps are flexible straps with a minimum of one megohm  $\pm 10\%$  resistance in the ground cords. To provide proper ground, wear a strap snugly against the skin at all times. On grounded mats with banana-plug connectors, use alligator clips to connect a wrist strap.
- When standing, use foot straps and a grounded floor mat. Foot straps (heel, toe, or boot straps) can be used at standing workstations and are compatible with most types of shoes or boots. On conductive floors or dissipative floor mats, use foot straps on both feet with a minimum of one megohm resistance between the operator and ground. To be effective, the conductive must be worn in contact with the skin.

The following grounding equipment is recommended to prevent electrostatic damage:

- Antistatic tape
- Antistatic smocks, aprons, and sleeve protectors
- Conductive bins and other assembly or soldering aids
- Nonconductive foam
- Conductive tabletop workstations with ground cords of one megohm resistance
- Static-dissipative tables or floor mats with hard ties to the ground
- Field service kits
- Static awareness labels
- Material-handling packages
- Nonconductive plastic bags, tubes, or boxes
- Metal tote boxes
- Electrostatic voltage levels and protective materials

The following table lists the shielding protection provided by antistatic bags and floor mats.

Material	Use	Voltage protection level
Antistatic plastics	Bags	1,500 V
Carbon-loaded plastic	Floor mats	7,500 V
Metallized laminate	Floor mats	5,000 V

# Component replacement procedures

This chapter provides removal and replacement procedures.

Make special note of each screw size and location during removal and replacement.

## Battery

Description	Spare part number
4-cell, 52-Wh, 3.55-Ah, Li ion battery	687945-001
6-cell, 60-Wh, 2.7-Ah, Li ion travel battery	696621-001

Before disassembling the computer, follow these steps:

1. Turn off the computer. If you are unsure whether the computer is off or in Hibernation, turn the computer on, and then shut it down through the operating system.
2. Disconnect the power from the computer by unplugging the power cord from the computer.
3. Disconnect all external devices from the computer.

Remove the battery:

1. Position the computer upside-down on a flat surface.
2. Slide the battery release latch **(1)** to release the battery.
3. Slide the battery outward **(2)**, lift the outer edge of the battery **(3)**, and then remove it from the computer **(3)**.

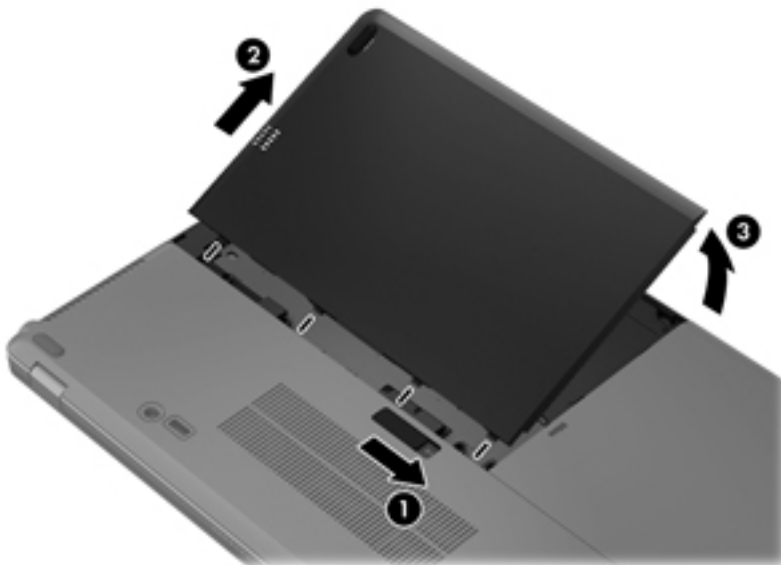



When installing the battery:

1. Insert the battery connector end of the battery into the bay, aligning it to the left edge.
2. Slide the battery into the bay until it drops and the latch snaps, and then slide the latch to the left to lock the battery.

---

 **NOTE:** In the locked position there will be no red color shown in the latch slot.

---

## SIM

---

 **NOTE:** This section applies only to computer models with WWAN capability.

 **NOTE:** If there is a SIM inserted in the SIM slot, it must be removed before disassembling the computer. Be sure that the SIM is reinserted in the SIM slot after reassembling the computer.

The SIM slot is located inside the battery bay on the right side.

---

Before removing the SIM, follow these steps:

1. Turn off the computer. If you are unsure whether the computer is off or in Hibernation, turn the computer on, and then shut it down through the operating system.
2. Disconnect the power from the computer by unplugging the power cord from the computer.
3. Disconnect all external devices from the computer.
4. Remove the battery (see [Battery on page 40](#)).

Remove the SIM:

1. Press in on the SIM **(1)**. (The module is partially ejected from the SIM slot.)
2. Remove the SIM **(2)** from the SIM slot.

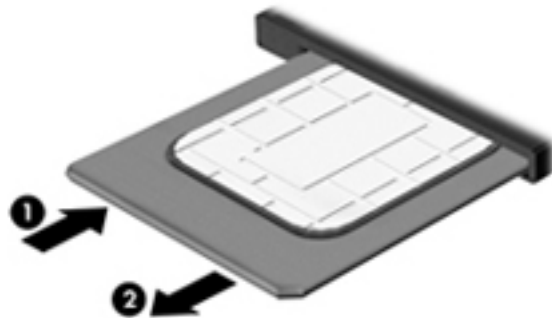

Reverse this procedure to install the SIM.

## Display assembly components (panel, bezel, webcam, microphone)

All display assemblies include WLAN antenna transceivers and cables. WWAN models also include 2 WWAN antenna transceivers and cables.

Full hinge-up displays are not spared.

This section describes removing components that do not require that you entirely remove the display assembly from the computer. You can remove the display bezel, webcam/microphone module, and display panel with the display assembly still attached to the computer.

To remove the remaining display components, including the display brackets, antennas, and enclosure, you must remove the entire display assembly from the computer. See [Display assembly on page 76](#) for more information about removing the remaining components.

Description	Spare part number
<b>Display panels</b>	
35.6-cm (14.0-in), HD+, anti-glare, LED	708771-001
35.6-cm (14.0-in), HD anti-glare, LED	702871-001
<b>Display bezels</b>	
For use with models with a webcam	702860-001
For use with models without a webcam	702861-001
<b>Webcam module with microphone</b>	702854-001
<b>Microphone module</b>	702873-001

Before removing the display panel, follow these steps:

1. Shut down the computer. If you are unsure whether the computer is off or in Hibernation, turn the computer on, and then shut it down through the operating system.
2. Disconnect all external devices connected to the computer.
3. Disconnect the power from the computer by first unplugging the power cord from the AC outlet, and then unplugging the AC adapter from the computer.
4. Remove the battery (see [Battery on page 40](#)).

Remove the display assembly components:

1. Position the computer upright, with the front toward you.
2. Open the computer as far as possible.
3. If it is necessary to replace the display bezel or any of the display assembly subcomponents:
  - a. Flex the inside edges of the bottom edge **(1)**, the left and right sides **(2)**, and the top edge **(3)** of the display bezel until the bezel disengages from the display enclosure.

- b. Remove the display bezel (4). The display bezel is available using spare part number 702860-001 on models with a webcam and 702861-001 on models without a webcam.

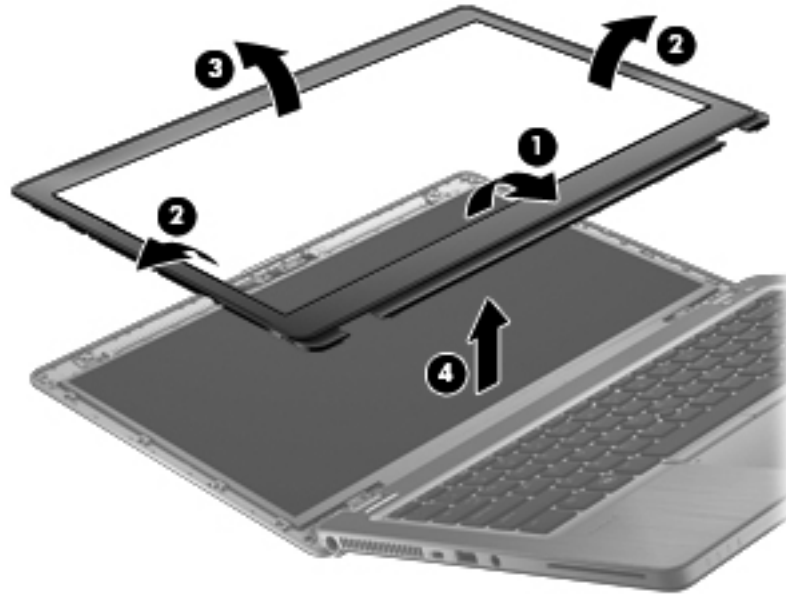

- 4. If it is necessary to replace the webcam/microphone module:
  - a. Detach the webcam/microphone module (1) from the display enclosure. (The webcam/microphone module is attached to the display enclosure with double-sided tape.)
  - b. Disconnect the cable (2) from the webcam/microphone module.

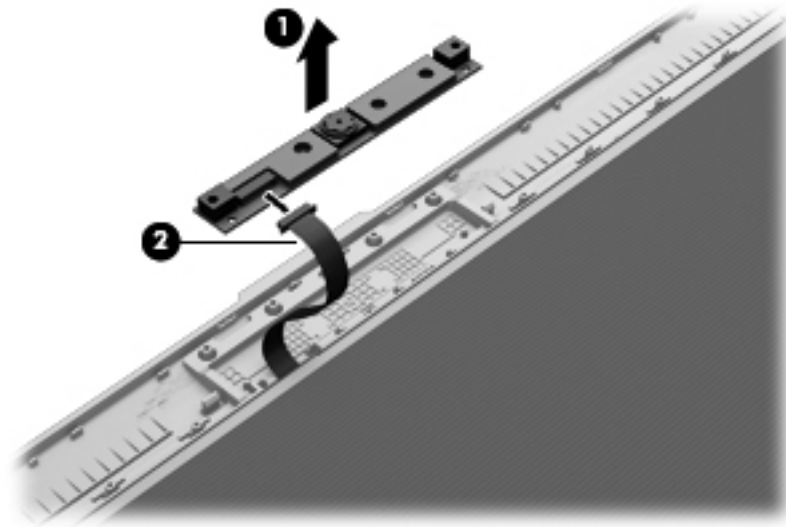

- c. Remove webcam/microphone module. The webcam module is available using spare part number 702854-001. The microphone module is available using spare part number 702873-001.

5. If it is necessary to replace the display panel:
- a. Remove the four Phillips PM2.0×3.0 screws that secure the display panel to the display enclosure.
    - 702871-001 — 35.6-cm (14.0-in), LED, HD, AntiGlare display panel
    - 708771-001 — 35.6-cm (14.0-in), LED, HD+, AntiGlare display panel

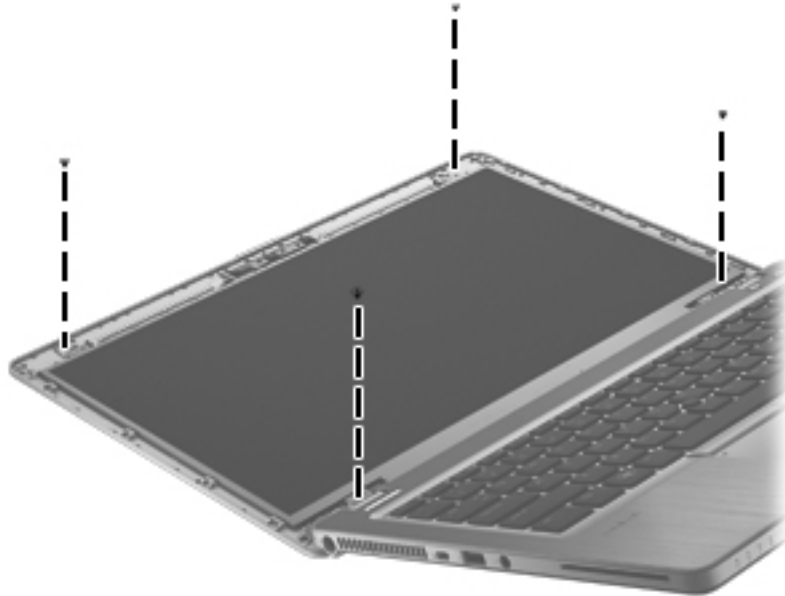

- b. Rotate the top of the display panel downward (1).
- c. Lift the tape that secure the display cable connector on the panel (2), and then disconnect the cable (3) from the connector (4).



Reverse this procedure to reassemble and install the display assembly components.

## Hard drive cover



**NOTE:** The hard drive cover is available in the Plastics kit, spare part number 702877-001.

Description	Spare part number
Plastics kit	702877-001

Before removing the hard drive cover, follow these steps:

1. Turn off the computer. If you are unsure whether the computer is off or in Hibernation, turn the computer on, and then shut it down through the operating system.
2. Disconnect the power from the computer by unplugging the power cord from the computer.
3. Disconnect all external devices from the computer.
4. Remove the battery (see [Battery on page 40](#)).

Remove the hard drive cover:

1. Loosen the 2 captive hard drive cover screws (1).
2. Slide the hard drive cover away from the computer (2), and then lift the cover off the computer (3).

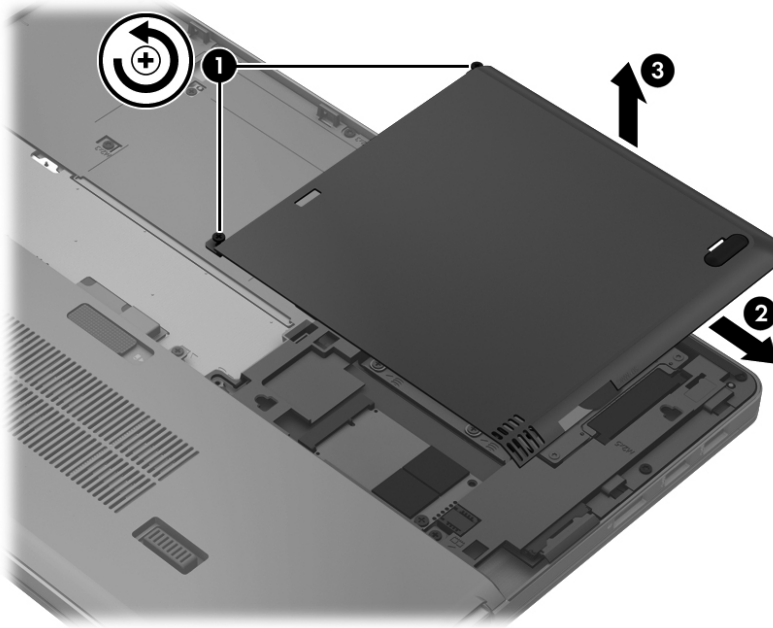

Reverse the removal procedures to install the hard drive cover.

## Hard drive/SSD drive



**NOTE:** The hard drive spare part kit does not include the hard drive bracket, connector, or screws.

The solid-state drive spare part kit includes the Hard Drive Hardware Kit, which includes the bracket, connector, and screws..

Description	Spare part number
<b>Hard drive</b> (does not include hard drive bracket or screws):	
500-GB, 7200-rpm, 7-mm SED	703268-001
500-GB, 7200-rpm, 7-mm	703267-001
320-GB, 7200-rpm, 9.5-mm	603783-001
<b>Solid-state drive</b> (includes bracket, connector, and screws):	
256-GB, SATA III, self-encrypting drive (SED)	702865-001
180-GB, SATA III	702864-001
<b>mSATA SSD:</b>	
256-GB mSATA	702866-001
32-GB mSATA	702867-001
24-GB mSATA	702868-001
Hard Drive Hardware Kit (includes hard drive bracket, connector, and screws)	702870-001

Before removing the hard drive, follow these steps:

1. Turn off the computer. If you are unsure whether the computer is off or in Hibernation, turn the computer on, and then shut it down through the operating system.
2. Disconnect the power from the computer by unplugging the power cord from the computer.
3. Disconnect all external devices from the computer.
4. Remove the battery (see [Battery on page 40](#)).
5. Remove the hard drive cover (see [Hard drive cover on page 45](#)).

Remove the hard drive:

1. Loosen the 4 captive hard drive screws **(1)** that secure the drive to the computer.
2. Pull the hard drive tab **(2)** upward to disconnect the hard drive.

3. Lift the hard drive, and then pull the hard drive out of the hard drive bay.

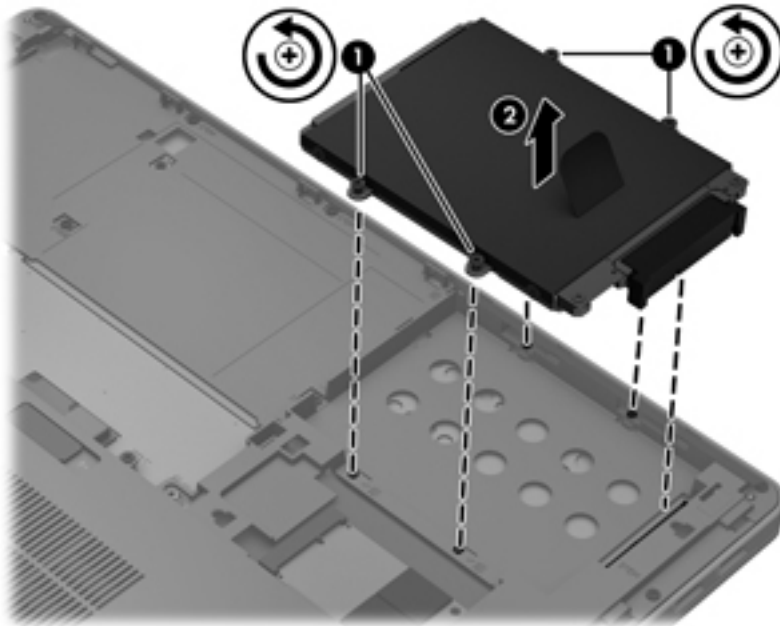

4. If it is necessary to disassemble the hard drive, perform the following steps:
  - a. Remove the connector from the hard drive (1).
  - b. Remove the four Phillips PM3.0×4.0 screws (2) that secure the hard drive bracket to the hard drive.
  - c. Remove the hard drive bracket (3) from the hard drive. The hard drive bracket, connector, and screws are available in the Hard Drive Hardware Kit, spare part number 702870-001.

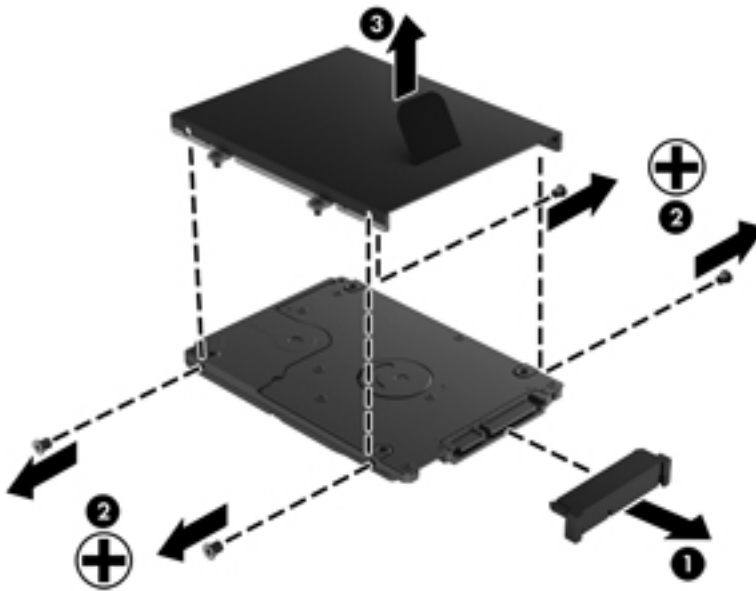

Reverse this procedure to reassemble and install the hard drive.

## mSATA drive

Description	Spare part number
256-GB mSATA drive	702866-001
32-GB mSATA drive	702867-001
24-GB mSATA drive	702868-001

Before removing the mSATA drive follow these steps:

1. Turn off the computer. If you are unsure whether the computer is off or in Hibernation, turn the computer on, and then shut it down through the operating system.
2. Disconnect the power from the computer by unplugging the power cord from the computer.
3. Disconnect all external devices from the computer.
4. Remove the battery (see [Battery on page 40](#)).
5. Remove the hard drive cover (see [Hard drive cover on page 45](#)).

Remove the mSATA drive:

1. Remove the two Phillips PM2.0×3.0 screws (1) that secure the drive to the system board. (The drive tilts up.)

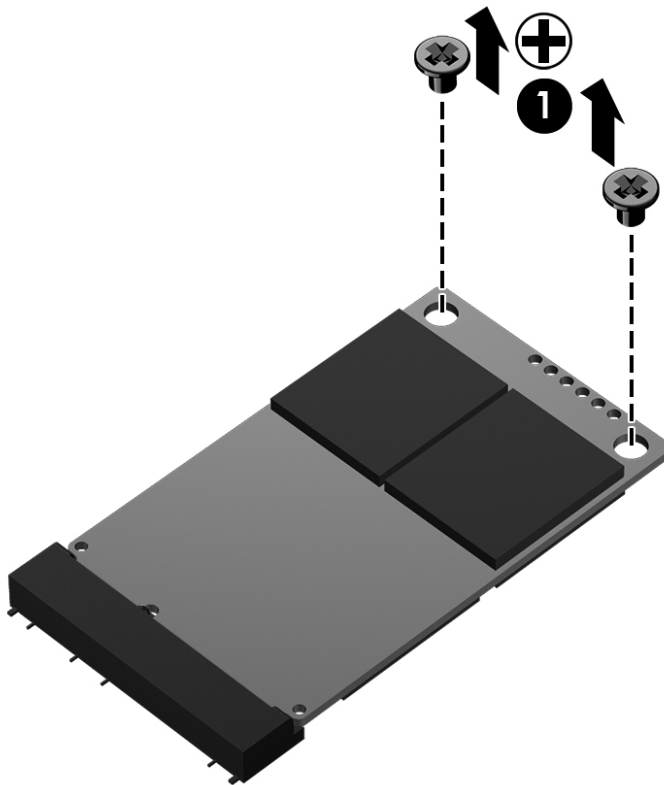



2. Remove the drive **(2)** by pulling it away from the slot at an angle.

---

 **NOTE:** mSATA drives are designed with a notch to prevent incorrect insertion.

---

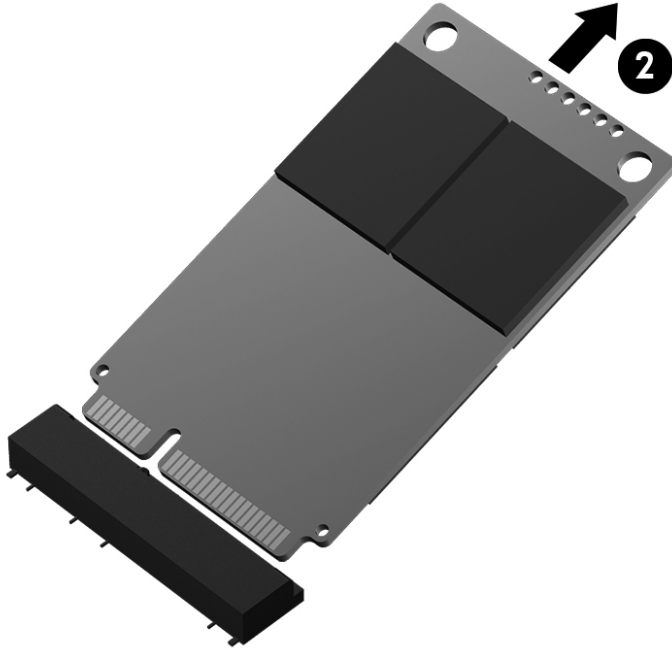

Reverse this procedure to install the mSATA drive.

## RTC battery

Description	Spare part number
RTC battery (includes cable and double-sided tape)	702853-001

Before removing the RTC battery, follow these steps:

1. Turn off the computer. If you are unsure whether the computer is off or in Hibernation, turn the computer on, and then shut it down through the operating system.
2. Disconnect the power from the computer by unplugging the power cord from the computer.
3. Disconnect all external devices from the computer.
4. Remove the battery (see [Battery on page 40](#)).
5. Remove the hard drive cover (see [Hard drive cover on page 45](#)).

Remove the RTC battery:

1. Disconnect the RTC battery cable **(1)** from the system board.
2. Detach the RTC battery **(2)** from the computer.

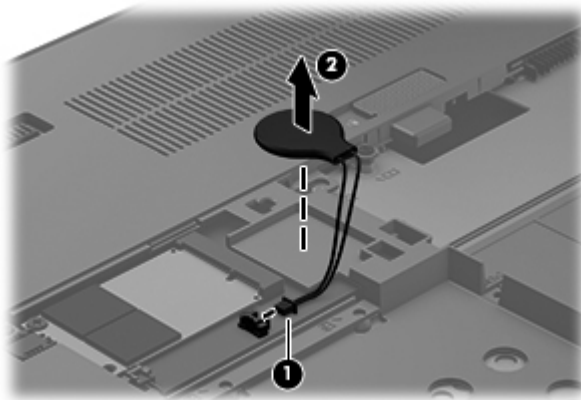

3. Remove the RTC battery.

Reverse this procedure to install the RTC battery.

## Service cover

Description	Spare part number
Service cover	704441001

Before removing the service cover, follow these steps:

1. Turn off the computer. If you are unsure whether the computer is off or in Hibernation, turn the computer on, and then shut it down through the operating system.
2. Disconnect the power from the computer by unplugging the power cord from the computer.
3. Disconnect all external devices from the computer.
4. Remove the battery (see [Battery on page 40](#)).
5. Remove the hard drive cover (see [Hard drive cover on page 45](#)).

Remove the service cover:

1. Loosen the 5 captive Phillips screws (1) that secure the cover to the computer.
2. Tilt the door up from the computer slightly (2), and then lift the cover up and off the computer (3).

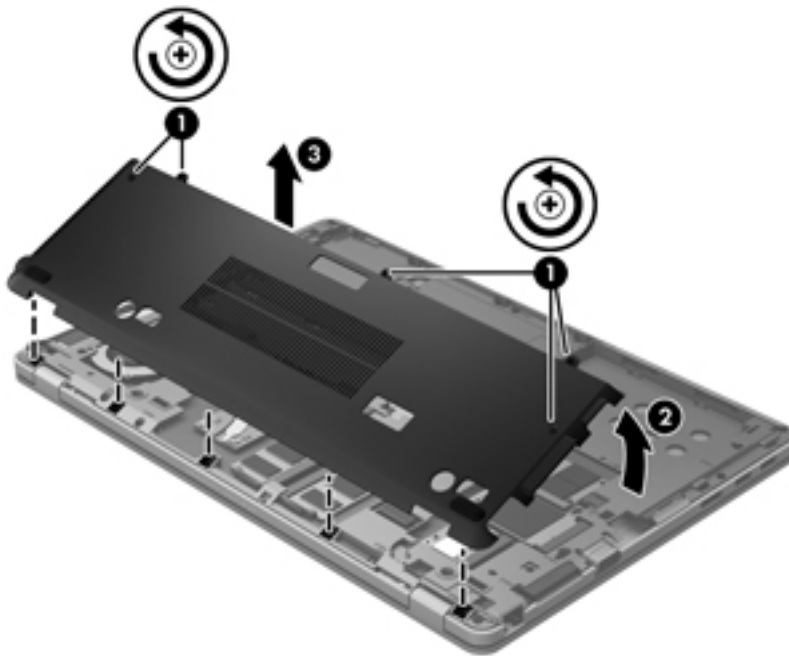

Reverse the removal procedures to install the service cover.

## Memory module



**NOTE:** Primary and expansion memory is installed in a stacked configuration in the bottom of the computer.

Description	Spare part number
8-GB memory module (PC3, 12800, 1600-MHz)	634091-001
4-GB memory module (PC3, 12800, 1600-MHz)	641369-001
2-GB memory module (PC3, 12800, 1600-MHz)	652972-001

### Update BIOS before adding memory modules

Before adding new memory, make sure you update the computer to the latest BIOS.



**CAUTION:** Failure to update the computer to the latest BIOS prior to installing new memory may result in various system problems.

To update BIOS:

1. Navigate to [www.hp.com](http://www.hp.com).
2. Click **Support & Drivers > Drivers & Software**.
3. In the **Enter a product name/number box**, type the computer model information, and then click **Search**.
4. Click the link for the computer model.
5. Select the operating system, and then click **Next**.
6. Under **Step 2: Select a Download**, click the **BIOS** link.
7. Click the link for the most recent BIOS.
8. Click the **Download** button, and then follow the on-screen instructions.

Before removing a memory module, follow these steps:

1. Turn off the computer. If you are unsure whether the computer is off or in Hibernation, turn the computer on, and then shut it down through the operating system.
2. Disconnect the power from the computer by unplugging the power cord from the computer.
3. Disconnect all external devices from the computer.
4. Remove the battery (see [Battery on page 40](#)).
5. Remove the hard drive cover (see [Hard drive cover on page 45](#)).
6. Remove the service cover [Service cover on page 51](#)).

Remove the memory module:

1. Spread the retaining tabs **(1)** on each side of the memory module slot to release the memory module. (The edge of the module opposite the slot rises away from the computer.)

2. Remove the memory module (2) by pulling the module away from the slot at an angle.

 **NOTE:** Memory modules are designed with a notch to prevent incorrect insertion into the memory module slot.

 **NOTE:** The computer uses two memory slots. The top slot houses the expansion memory module and the bottom slot houses the primary memory module.

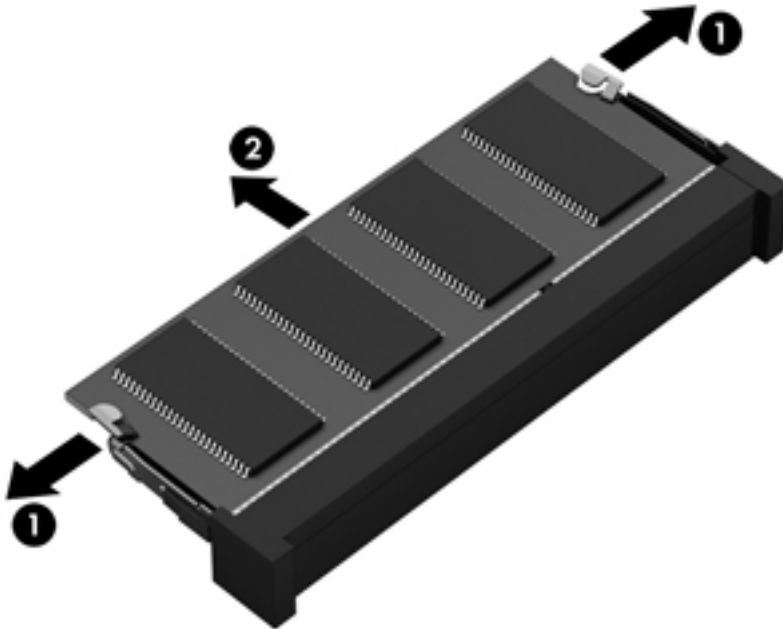

Reverse this procedure to install a memory module.

## WWAN module



**NOTE:** The WWAN module and the WLAN module are not interchangeable.

Description	Spare part number
HP It2523 LTE/HSPA+ Mobile Broadband Module	675793-001
HP It2522 LTE/EV-DO Mobile Broadband Module	675791-001
HP un2430 EV-DO/HSPA Mobile Broadband Module	634400-001
HP hs2350 HSPA+ Mobile Broadband Module	668969-001
HP un2430 EV-DO/HSPA Mini Card	702080-001
HP hs2350 hspa+ Mobile Broadband Module	710788-001
HP It2522 LTE/EV-DO Mobile Broadband Module	710789-001
HP It2523 LTE/HSPA+ Mobile Broadband Module	710790-001

Before removing the WWAN module, follow these steps:

1. Turn off the computer. If you are unsure whether the computer is off or in Hibernation, turn the computer on, and then shut it down through the operating system.
2. Disconnect the power from the computer by unplugging the power cord from the computer.
3. Disconnect all external devices from the computer.
4. Remove the battery (see [Battery on page 40](#)).
5. Remove the hard drive cover (see [Hard drive cover on page 45](#)).
6. Remove the service cover (see [Service cover on page 51](#)).

Remove the WWAN module:

1. Disconnect the WWAN antenna cables **(1)** from the terminals on the WWAN module.





**NOTE:** The red WWAN antenna cable is connected to the WWAN module “Main” terminal. The blue WWAN antenna cable is connected to the WWAN module “Aux” terminal.

2. Remove the two Phillips PM2.0×3.0 screws **(2)** that secure the WWAN module to the system board. (The WWAN module tilts up.)

3. Remove the WWAN module (3) by pulling the module away from the slot at an angle.

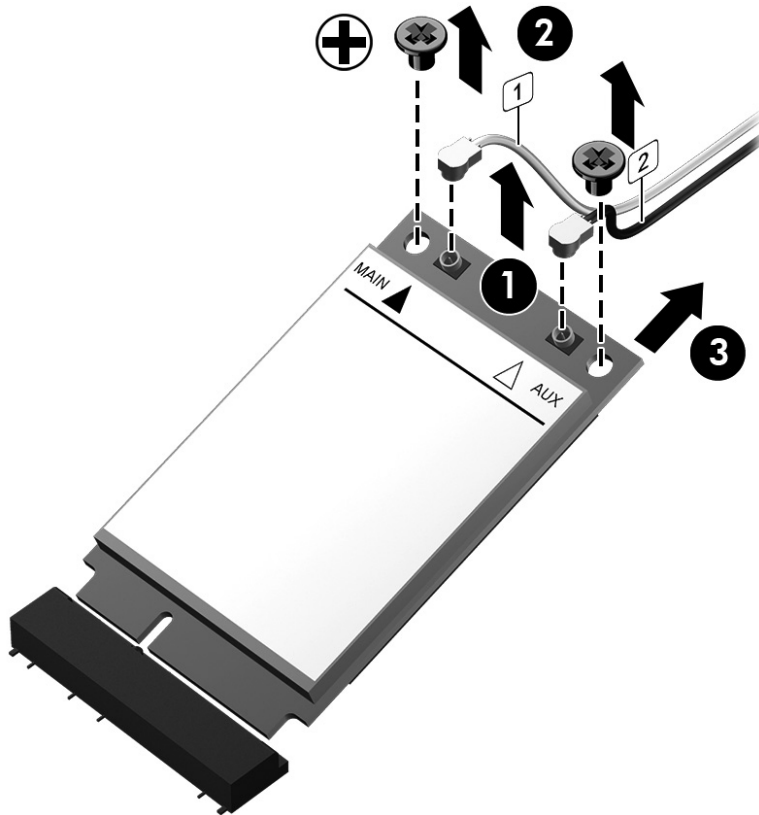
 **NOTE:** WWAN modules are designed with a notch to prevent incorrect insertion.



 **NOTE:** If the WWAN antennas are not connected to the terminals on the WWAN module, the protective sleeves must be installed on the antenna connectors, as shown in the following illustration.

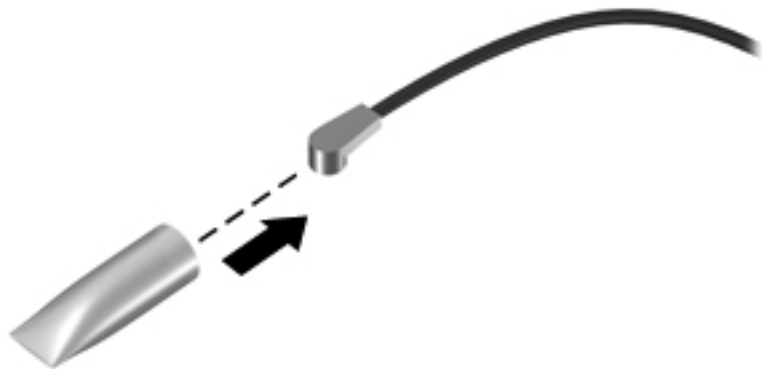

Reverse this procedure to install the WWAN module.

## WLAN module

Description	Spare part number
Broadcom 4313GN 802.11b/g/n 1x1 WiFi and 20702 Bluetooth 4.0 Combo Adapter	657325-001
Intel Centrino Advanced-N 6235	670292-001
Intel Centrino Advanced-N 6205 WLAN module	631954-001
QC/Atheros AR9462 802.11a/b/g/n 2x2 BT4.0 combo	676786-001

 **CAUTION:** To prevent an unresponsive system, replace the wireless module only with a wireless module authorized for use in the computer by the governmental agency that regulates wireless devices in your country or region. If you replace the module and then receive a warning message, remove the module to restore device functionality, and then contact technical support.

Before removing the WLAN module, follow these steps:

1. Turn off the computer. If you are unsure whether the computer is off or in Hibernation, turn the computer on, and then shut it down through the operating system.
2. Disconnect the power from the computer by unplugging the power cord from the computer.
3. Disconnect all external devices from the computer.
4. Remove the battery (see [Battery on page 40](#)).
5. Remove the hard drive cover (see [Hard drive cover on page 45](#)).
6. Remove the service cover (see [Service cover on page 51](#)).

Remove the WLAN module:

1. Disconnect the WLAN antenna cables **(1)** from the terminals on the WLAN module.

 **NOTE:** The WLAN antenna cable labeled “1” connects to the WLAN module “Main” terminal labeled “1”. The WLAN antenna cable labeled “2” connects to the WLAN module “Aux” terminal labeled “2”. If the computer is equipped with an 802.11a/b/g/n WLAN module, the yellow WLAN antenna cable connects to the middle terminal on the WLAN module.

2. Remove the Phillips PM2.0×3.0 screw **(2)** that secures the WLAN module to the system board. (The WLAN module tilts up.)



3. Remove the WLAN module (3) by pulling the module away from the slot at an angle.

 **NOTE:** WLAN modules are designed with a notch to prevent incorrect insertion.

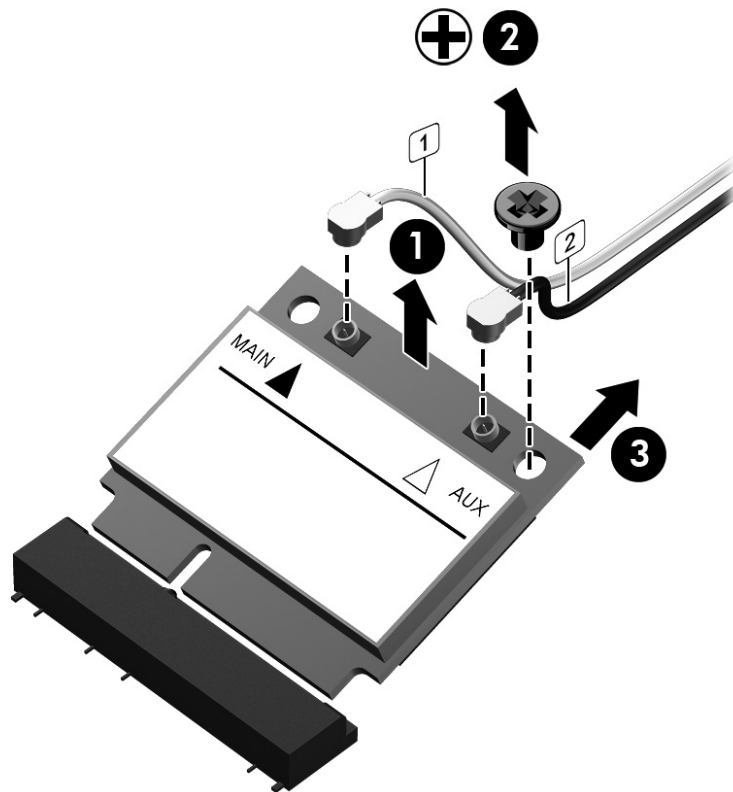

 **NOTE:** If the WLAN antennas are not connected to the terminals on the WLAN module, the protective sleeves must be installed on the antenna connectors, as shown in the following illustration.

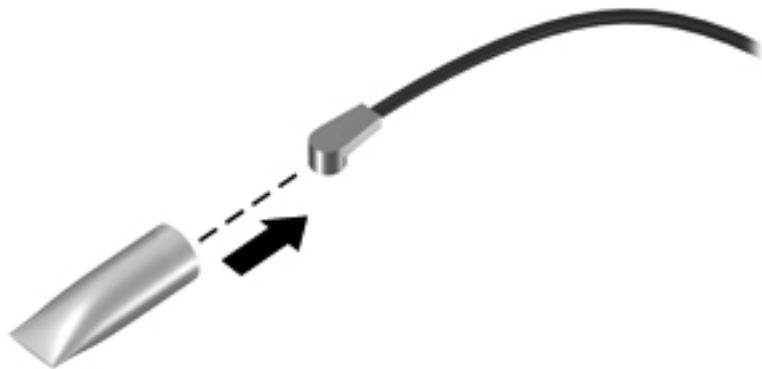

Reverse this procedure to install the WLAN module.

## Keyboard

Description	Spare part number
Keyboard	684252-xx1

Before removing the keyboard, follow these steps:

1. Turn off the computer. If you are unsure whether the computer is off or in Hibernation, turn the computer on, and then shut it down through the operating system.
2. Disconnect the power from the computer by unplugging the power cord from the computer.
3. Disconnect all external devices from the computer.
4. Remove the battery (see [Battery on page 40](#)).
5. Remove the hard drive cover (see [Hard drive cover on page 45](#)).
6. Remove the service cover (see [Service cover on page 51](#)).

Remove the keyboard:

1. Loosen the 4 captive Phillips screws that secure the keyboard to the computer.

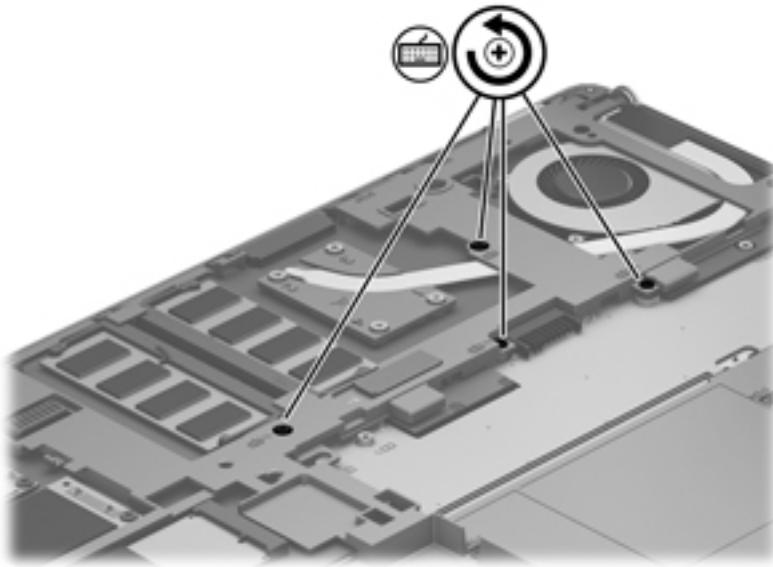

2. Rest and secure the computer on its right side.
3. Partially open the computer.

4. Insert a screw driver or similar thin tool into the keyboard release opening near the fan, and then press on the back of the keyboard until the keyboard disengages from the computer.

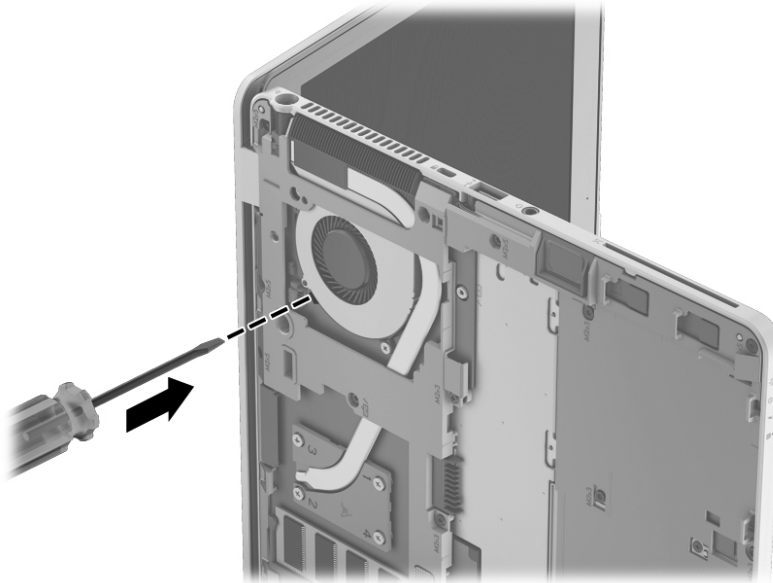

5. Turn the computer right-side up with the front toward you.
6. Lift the rear edge of the keyboard (1), and then swing the keyboard up and forward (2) until it rests upside down on the palm rest (3).

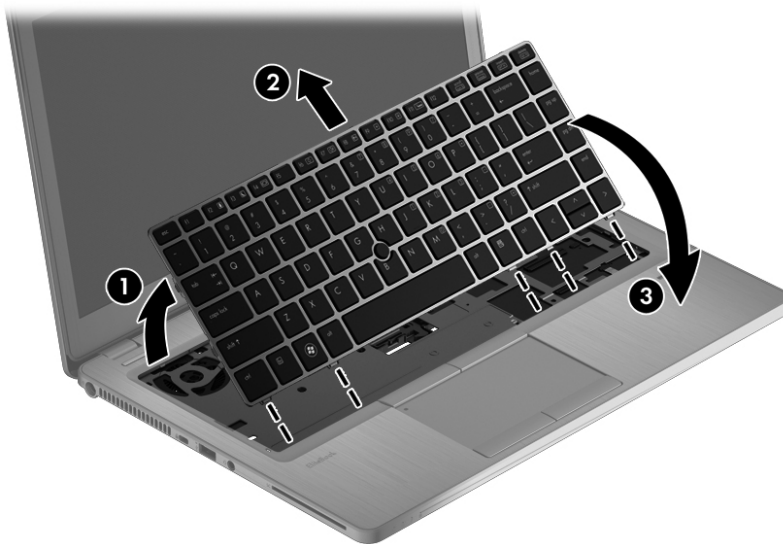

7. Release and disconnect the following connectors and cables:
  - Release the pointing stick connector (1) and remove the cable (2).
  - Release the large keyboard connector (3) and remove the cable (4).
  - Release the small keyboard connector (5) and remove the cable (6).

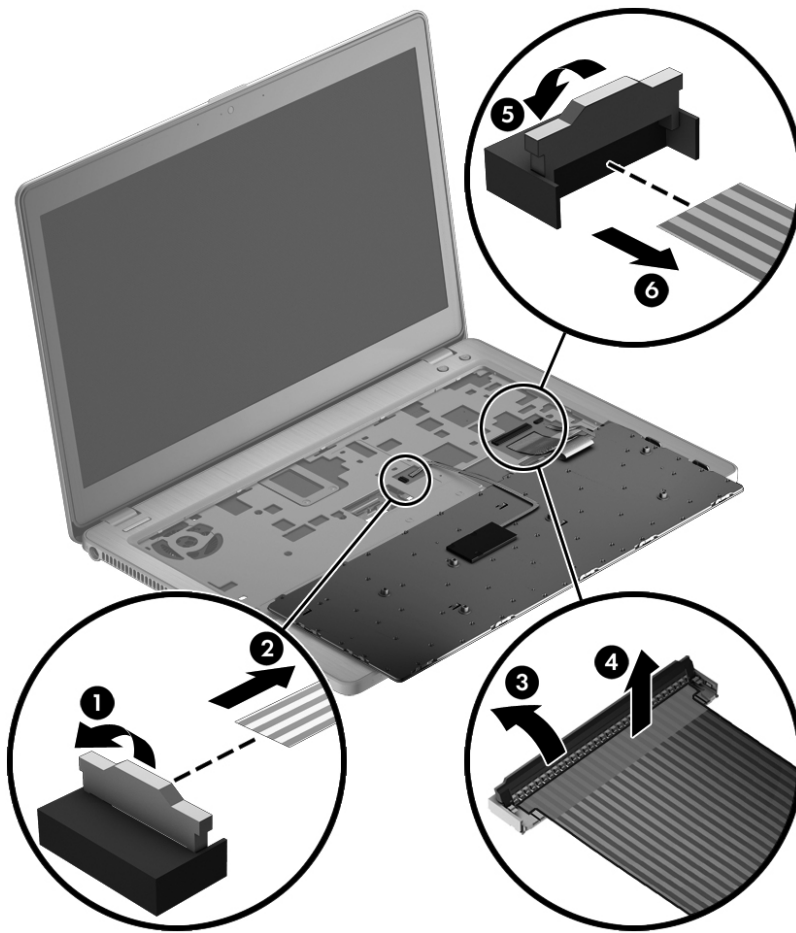

8. Remove the keyboard.

Reverse this procedure to install the keyboard.

## Base enclosure

Description	Spare part number
Base enclosure	702863-001

Before removing the base enclosure, follow these steps:

1. Turn off the computer. If you are unsure whether the computer is off or in Hibernation, turn the computer on, and then shut it down through the operating system.
2. Disconnect the power from the computer by unplugging the power cord from the computer.
3. Disconnect all external devices from the computer.
4. Remove the battery (see [Battery on page 40](#)), and then remove the following components:
  - a. Hard drive cover (see [Hard drive cover on page 45](#))
  - b. Hard drive (see [Hard drive/SSD drive on page 46](#))
  - c. Service cover (see [Service cover on page 51](#))
  - d. Keyboard (see [Keyboard on page 58](#))

Remove the base enclosure:

1. Close the computer and position it upside down.
2. Remove the WLAN (1) and WWAN (2) antennas from the routing path (3) in the base enclosure.

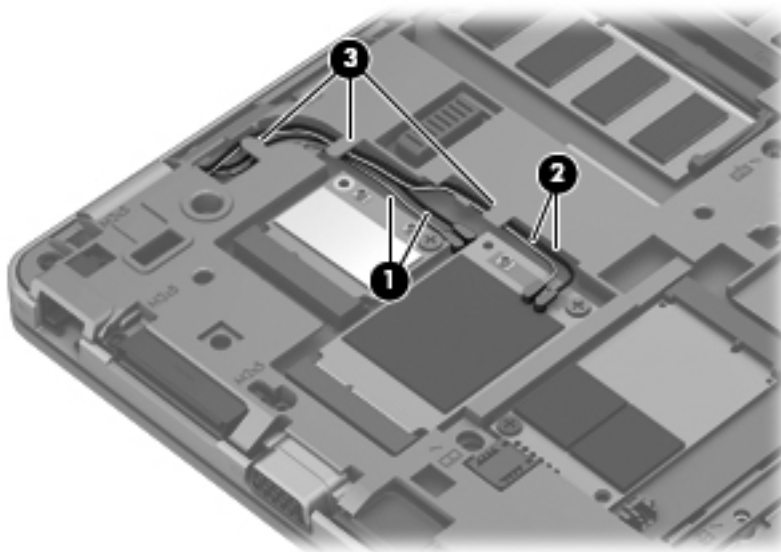

3. Remove the 13 Torx PM2.0×5.0 screws that secure the base enclosure to the computer.

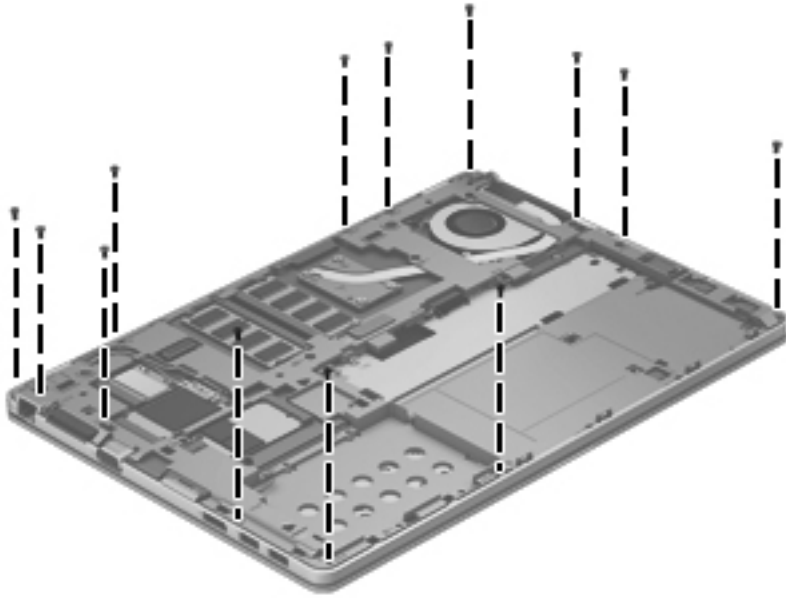

4. Remove the 7 Torx PM2.0×3.0 screws from the battery bay that secure the base enclosure to the computer.

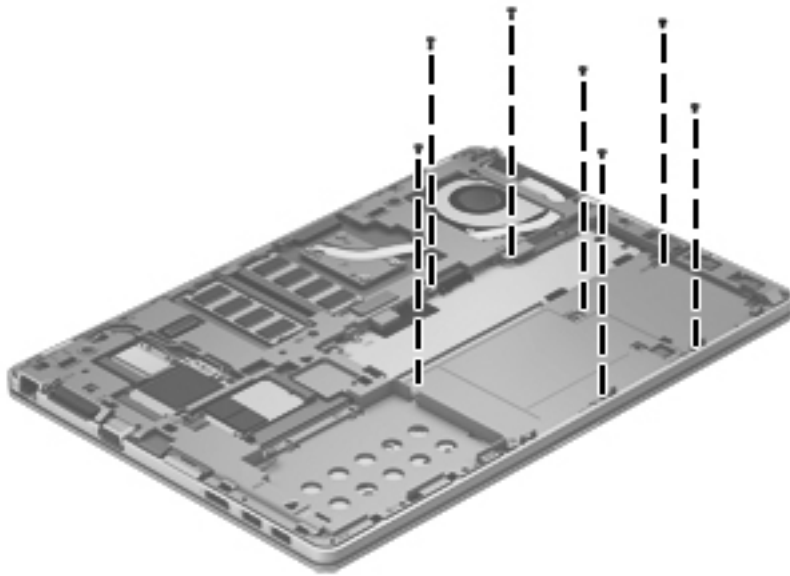

5. Lift the base enclosure (1) off the computer while threading the antenna cables through the hole in the base enclosure (2).

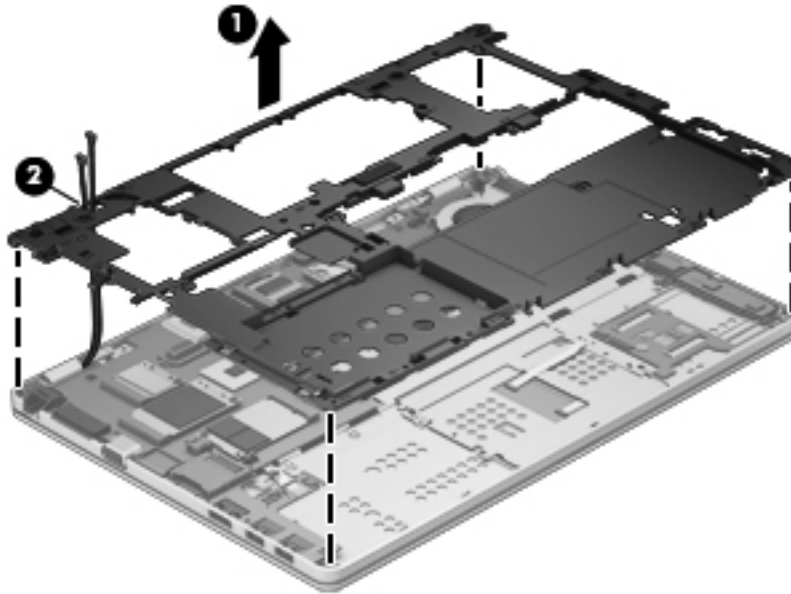

Reverse this procedure to install the base enclosure.

## Touchpad

Before removing the touchpad, follow these steps:

1. Turn off the computer. If you are unsure whether the computer is off or in Hibernation, turn the computer on, and then shut it down through the operating system.
2. Disconnect the power from the computer by unplugging the power cord from the computer.
3. Disconnect all external devices from the computer.
4. Remove the battery (see [Battery on page 40](#)), and then remove the following components:
  - a. Hard drive cover (see [Hard drive cover on page 45](#))
  - b. Hard drive (see [Hard drive/SSD drive on page 46](#))
  - c. Service cover (see [Service cover on page 51](#))
  - d. Keyboard (see [Keyboard on page 58](#))
  - e. Base enclosure (see [Base enclosure on page 61](#))

Remove the touchpad:

1. Remove the 2 Phillips PM2.0×3.0 screws (1) that secure the touchpad to the computer.

2. Lift the touchpad from the computer (2).

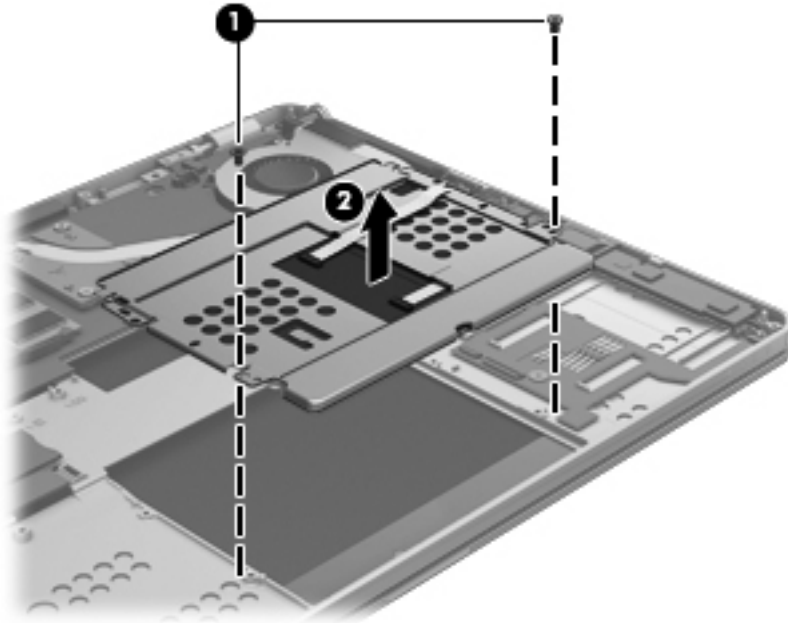

3. Remove the touchpad.

Reverse this procedure to install the touchpad.



**NOTE:** When replacing the touchpad, make sure to install the screws into holes closer to the edge of computer.

## Power connector

Description	Spare part number
Power connector	702875-001

Before removing the power connector, follow these steps:

1. Turn off the computer. If you are unsure whether the computer is off or in Hibernation, turn the computer on, and then shut it down through the operating system.
2. Disconnect the power from the computer by unplugging the power cord from the computer.
3. Disconnect all external devices from the computer.
4. Remove the battery (see [Battery on page 40](#)), and then remove the following components:
  - a. Hard drive cover (see [Hard drive cover on page 45](#))
  - b. Hard drive (see [Hard drive/SSD drive on page 46](#))
  - c. Service cover (see [Service cover on page 51](#))
  - d. Keyboard (see [Keyboard on page 58](#))
  - e. Base enclosure (see [Base enclosure on page 61](#))



Remove the power connector:

1. Position the base enclosure with the front toward you.
2. Disconnect the power connector cable from the system board (1).
3. Lift the power connector from the computer (2).

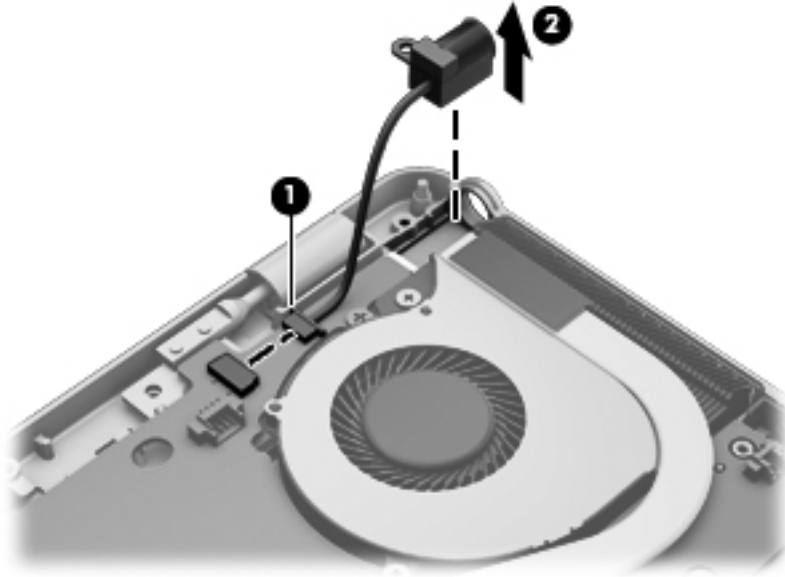

4. Remove the power connector.

Reverse this procedure to install the power connector.

## Fan

Description	Spare part number
Fan (includes cable)	702859-001

Before removing the fan, follow these steps:

1. Turn off the computer. If you are unsure whether the computer is off or in Hibernation, turn the computer on, and then shut it down through the operating system.
2. Disconnect the power from the computer by unplugging the power cord from the computer.
3. Disconnect all external devices from the computer.
4. Remove the battery (see [Battery on page 40](#)).
  - a. Hard drive cover (see [Hard drive cover on page 45](#))
  - b. Hard drive (see [Hard drive/SSD drive on page 46](#))
  - c. Service cover (see [Service cover on page 51](#))
  - d. Keyboard (see [Keyboard on page 58](#))
  - e. Base enclosure (see [Base enclosure on page 61](#))

Remove the fan:

1. Disconnect the fan cable (1) from the system board.
2. Loosen the 2 captive Phillips screws (2) that secure the fan to the top cover.
3. Remove the fan (3).

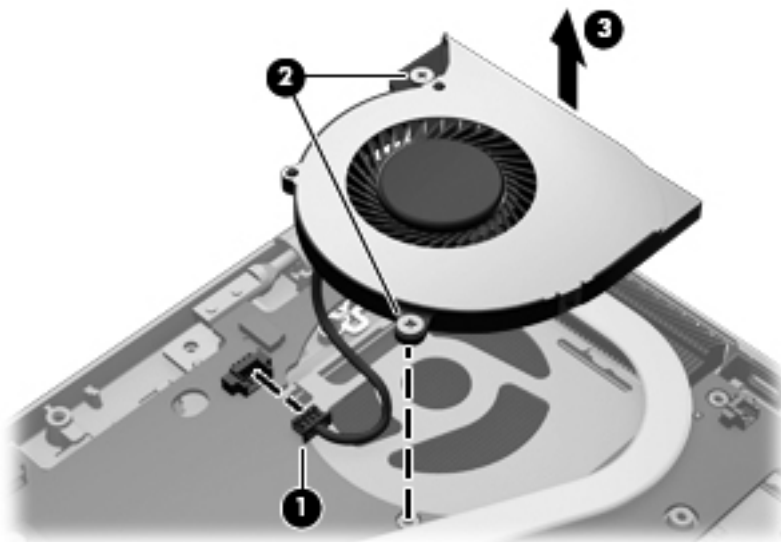

Reverse this procedure to install the fan.

## System board



**NOTE:** The system board spare part kit includes replacement thermal material.

Description	Spare part number
<b>System boards for use in models without Windows 8:</b>	
Intel Core i7-3667U processor (2.00 GHz [3.2-GHz max turbo frequency], 4-MB cache)	702848-001
Intel Core i5-3427U processor (1.80 GHz [2.8-GHz max turbo frequency], 3-MB cache)	702849-001
Intel Core i5-3317U processor (1.70 GHz [2.6-GHz max turbo frequency], 3-MB cache)	704439-001
Intel Core i3-3217U processor (1.80 GHz, 3-MB cache)	702847-001
<b>System boards for use in Windows 8 models:</b>	
Intel Core i7-3667U processor (2.00 GHz [3.2-GHz max turbo frequency], 4-MB cache) for use in models with Windows 8 Standard	702848-501
Intel Core i7-3667U processor (2.00 GHz [3.2-GHz max turbo frequency], 4-MB cache) for use in models with Windows 8 Professional	702848-601
Intel Core i5-3427U processor (1.80 GHz [2.8-GHz max turbo frequency], 3-MB cache) for use in models with Windows 8 Standard	702849-501
Intel Core i5-3427U processor (1.80 GHz [2.8-GHz max turbo frequency], 3-MB cache) for use in models with Windows 8 Professional	702849-601
Intel Core i5-3317U processor (1.70 GHz [2.6-GHz max turbo frequency], 3-MB cache) for use in models with Windows 8 Standard	704439-501
Intel Core i5-3317U processor (1.70 GHz [2.6-GHz max turbo frequency], 3-MB cache) for use in models with Windows 8 Professional	704439-601
Intel Core i3-3217U processor (1.80 GHz, 3-MB cache) for use in models with Windows 8 Standard	702847-501
Intel Core i3-3217U processor (1.80 GHz, 3-MB cache) for use in models with Windows 8 Professional	702847-601

Before removing the system board, follow these steps:

1. Turn off the computer. If you are unsure whether the computer is off or in Hibernation, turn the computer on, and then shut it down through the operating system.
2. Disconnect the power from the computer by unplugging the power cord from the computer.
3. Disconnect all external devices from the computer.
4. Remove the battery (see [Battery on page 40](#)), and then remove the following components:
  - a. Hard drive cover (see [Hard drive cover on page 45](#))
  - b. Hard drive (see [Hard drive/SSD drive on page 46](#))
  - c. Service cover (see [Service cover on page 51](#))
  - d. Fan (see [Fan on page 66](#))

- e. Keyboard (see [Keyboard on page 58](#))
- f. Base enclosure (see [Base enclosure on page 61](#))



**NOTE:** When replacing the system board, be sure that the following components are removed from the defective system board and installed on the replacement system board:

- SIM (see [SIM on page 41](#), if applicable)
- Memory module (see [Memory module on page 52](#))
- WWAN module (see [WWAN module on page 54](#))
- WLAN module (see [WLAN module on page 56](#))
- Heat sink (see [Heat sink on page 70](#))

Remove the system board:

1. Disconnect the following cables:
  - (1): Right speaker cable
  - (2): Display panel
  - (3): Left speaker cable
  - (4): Touchpad
  - (5): Smart card reader

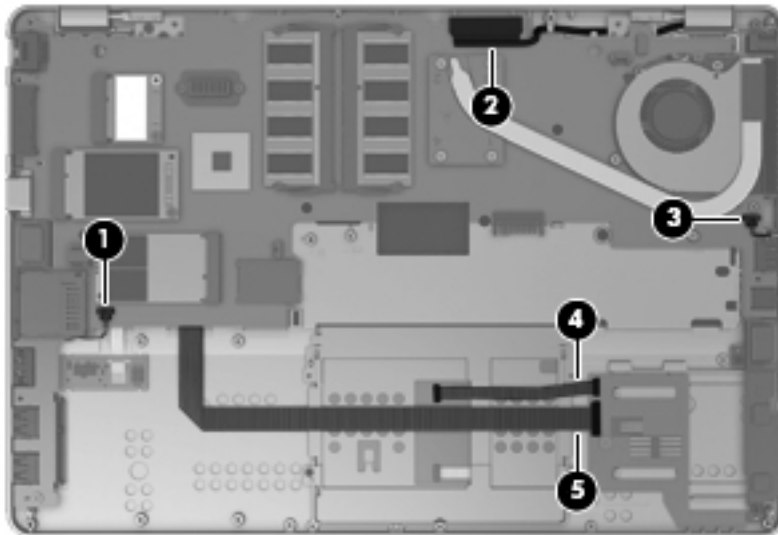

2. Remove the 2 Phillips PM2.0×4.0 screws that secure the system board to the computer.

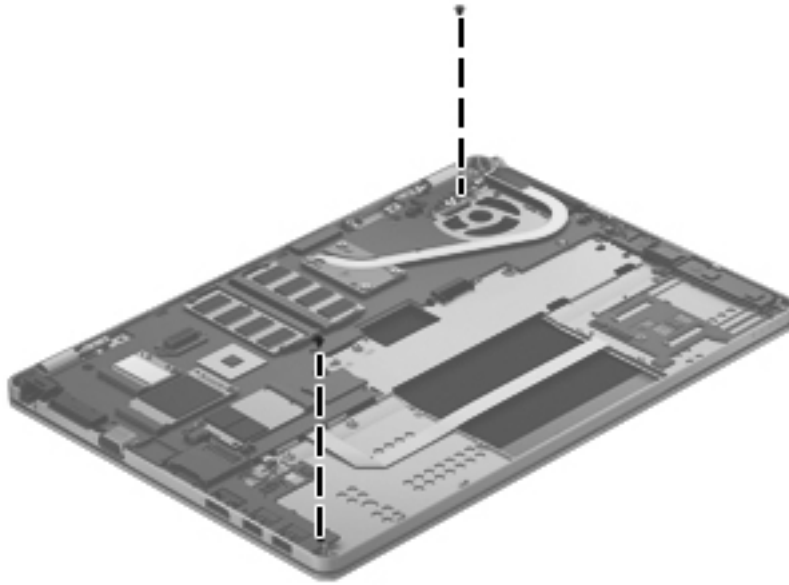

3. Lift the left side of the system board up at an angle (1).
4. Pull the system board away from and out of the computer (2), making sure the connectors on the right side of the board (3) are clear of the computer.

 **NOTE:** To avoid breaking the board, support the right side of the system board near the heat sink (3) as you lift it up and out of the computer.

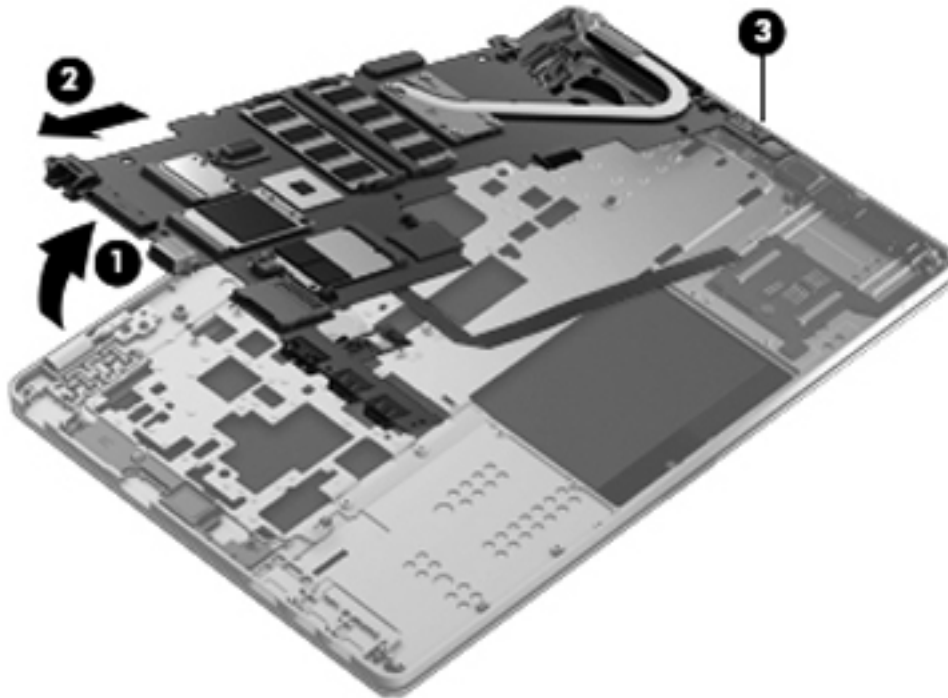

Reverse this procedure to install the system board.

## Heat sink



**NOTE:** The heat sink spare part kit includes replacement thermal material.

Description	Spare part number
Heat sink	707907-001

Before removing the heat sink, follow these steps:

1. Turn off the computer. If you are unsure whether the computer is off or in Hibernation, turn the computer on, and then shut it down through the operating system.
2. Disconnect the power from the computer by unplugging the power cord from the computer.
3. Disconnect all external devices from the computer.
4. Remove the battery (see [Battery on page 40](#)), and then remove the following components:
  - a. Hard drive cover (see [Hard drive cover on page 45](#))
  - b. Hard drive (see [Hard drive/SSD drive on page 46](#))
  - c. Service cover (see [Service cover on page 51](#))
  - d. WLAN module (see [WLAN module on page 56](#))
  - e. WWAN module (see [WWAN module on page 54](#))
  - f. Fan (see [Fan on page 66](#))
  - g. Keyboard (see [Keyboard on page 58](#))
  - h. Base enclosure (see [Base enclosure on page 61](#))
  - i. System board (see [System board on page 67](#))

Remove the heat sink:

1. Following the 1, 2, 3, 4 sequence stamped into the heat sink, loosen the four captive Phillips screws (**1**) that secure the heat sink to the system board.

2. Remove the heat sink (2).

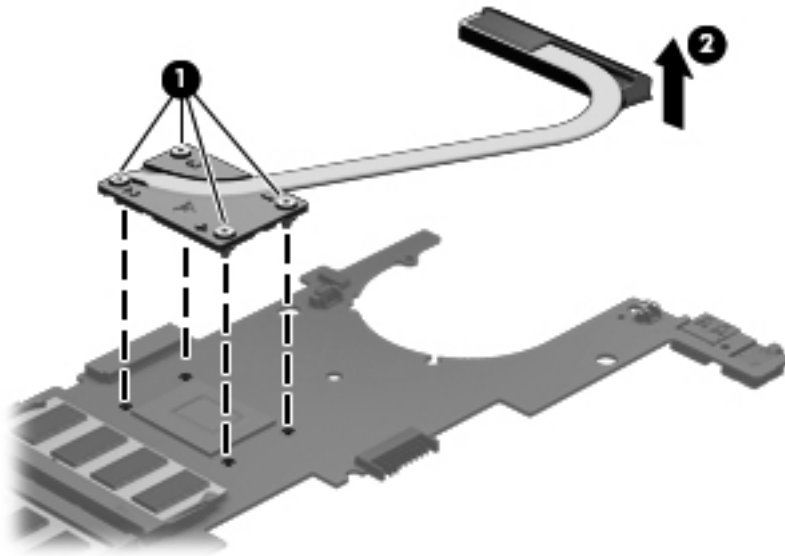

**NOTE:** The thermal material must be thoroughly cleaned from the surfaces of the heat sink and the system board components each time the heat sink is removed. Replacement thermal material is included with the heat sink, processor, and system board spare part kits.

The following illustration shows the replacement thermal material locations. Thermal paste is used on the heat sink (1) and the processor (2).

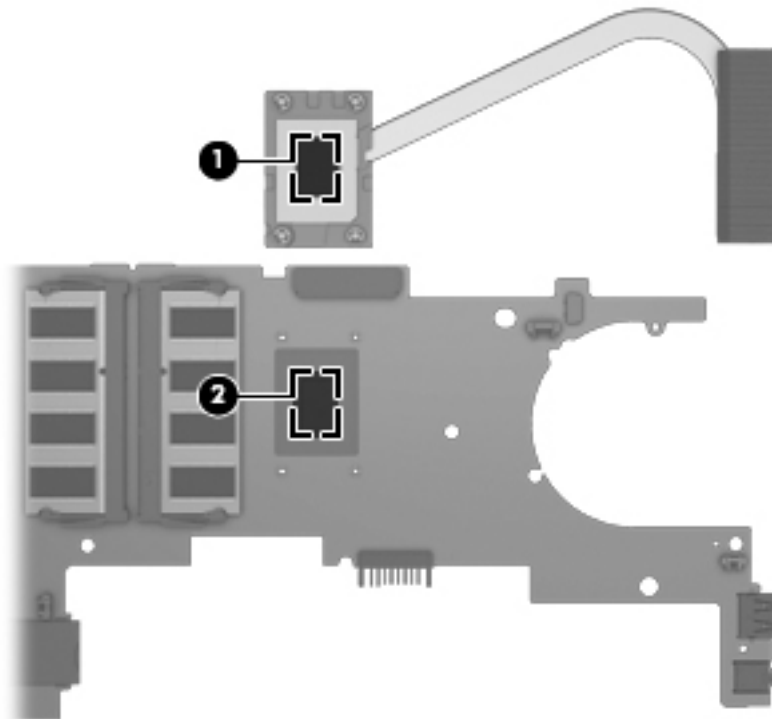

Reverse this procedure to install the heat sink.

## Speaker assembly

Description	Spare part number
Speaker assembly (includes cable)	702869-001

Before removing the speaker assembly, follow these steps:

1. Turn off the computer. If you are unsure whether the computer is off or in Hibernation, turn the computer on, and then shut it down through the operating system.
2. Disconnect the power from the computer by unplugging the power cord from the computer.
3. Disconnect all external devices from the computer.
4. Remove the battery (see [Battery on page 40](#)), and then remove the following components:
  - a. Hard drive cover (see [Hard drive cover on page 45](#))
  - b. Hard drive (see [Hard drive/SSD drive on page 46](#))
  - c. Service cover (see [Service cover on page 51](#))
  - d. Keyboard (see [Keyboard on page 58](#))
  - e. Base enclosure (see [Base enclosure on page 61](#))
  - f. Fan (see [Fan on page 66](#))
  - g. System board (see [System board on page 67](#))

Remove the speaker assembly:

1. Remove the 2 Phillips PM2.0×3.0 screws (1) that secure each speaker to the computer.
2. Remove the speakers (2) from the computer.

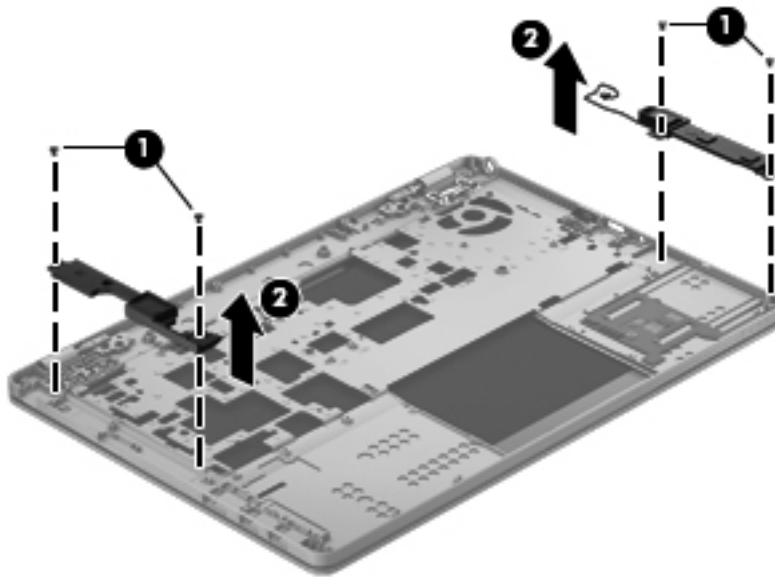



Reverse this procedure to install the speakers.

## Smart card board

Description	Spare part number
Smart card board (includes cable)	702844-001

Before removing the smart card reader, follow these steps:

1. Turn off the computer. If you are unsure whether the computer is off or in Hibernation, turn the computer on, and then shut it down through the operating system.
2. Disconnect the power from the computer by unplugging the power cord from the computer.
3. Disconnect all external devices from the computer.
4. Remove the battery (see [Battery on page 40](#)).
  - a. Hard drive cover (see [Hard drive cover on page 45](#))
  - b. Hard drive (see [Hard drive/SSD drive on page 46](#))
  - c. Service cover (see [Service cover on page 51](#))
  - d. Keyboard (see [Keyboard on page 58](#))
  - e. Base enclosure (see [Base enclosure on page 61](#))
  - f. Fan (see [Fan on page 66](#))
  - g. System board (see [System board on page 67](#))

Remove the smart card board:

1. Remove the Phillips PM2.0×2.5 broadhead screw **(1)** that secures the board to the computer.

2. Rotate the board upward (2) at an angle, and then remove it from the computer (3).

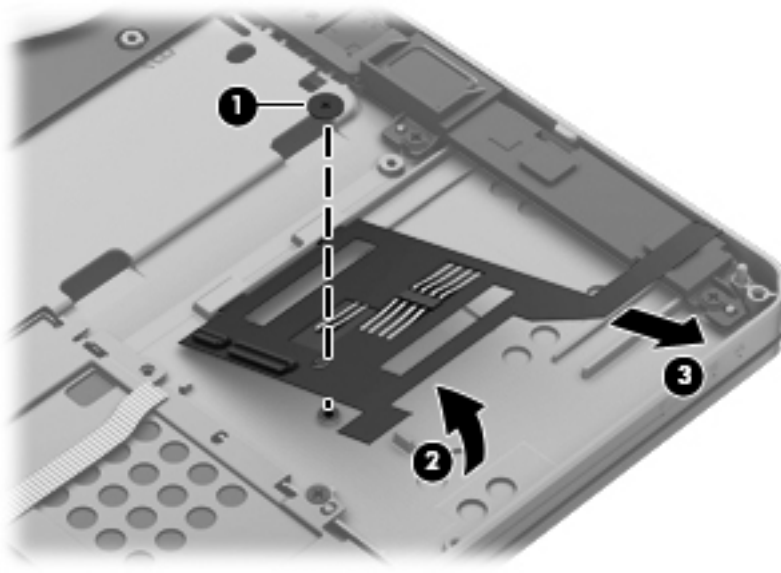

Reverse the removal procedures to install the smart card board.

## Fingerprint reader board

Description	Spare part number
Fingerprint reader board (includes cable)	702845-001

Before removing the fingerprint reader board, follow these steps:

1. Turn off the computer. If you are unsure whether the computer is off or in Hibernation, turn the computer on, and then shut it down through the operating system.
2. Disconnect the power from the computer by unplugging the power cord from the computer.
3. Disconnect all external devices from the computer.
4. Remove the battery (see [Battery on page 40](#)), and then remove the following components:
  - a. Hard drive cover (see [Hard drive cover on page 45](#))
  - b. Hard drive (see [Hard drive/SSD drive on page 46](#))
  - c. Service cover (see [Service cover on page 51](#))
  - d. Keyboard (see [Keyboard on page 58](#))
  - e. Base enclosure (see [Base enclosure on page 61](#))
  - f. Fan (see [Fan on page 66](#))
  - g. System board (see [System board on page 67](#))

Remove the fingerprint reader board:

1. Position the system board upside down.
2. Disconnect the fingerprint reader board cable from the system board connector, and then remove the assembly.

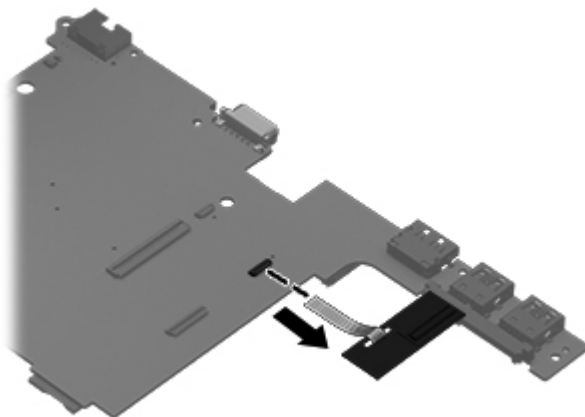

3. Remove the fingerprint reader board and cable.

Reverse this procedure to install the fingerprint reader board.

## Display assembly

This section describes removing components that require you to completely remove the display panel. For more information about removing display components that do not require that you remove the assembly from the computer, see [Display assembly components \(panel, bezel, webcam, microphone\) on page 42](#).



---

**NOTE:** The display assembly is spared at the subcomponent level only.

---

Before removing the display assembly, follow these steps:

1. Turn off the computer. If you are unsure whether the computer is off or in Hibernation, turn the computer on, and then shut it down through the operating system.
2. Disconnect the power from the computer by unplugging the power cord from the computer.
3. Disconnect all external devices from the computer.
4. Remove the battery (see [Battery on page 40](#)), and then remove the following components:
  - a. Hard drive cover (see [Hard drive cover on page 45](#))
  - b. Hard drive (see [Hard drive/SSD drive on page 46](#))
  - c. Service cover (see [Service cover on page 51](#))
  - d. WLAN module (see [WLAN module on page 56](#))
  - e. WWAN module (see [WWAN module on page 54](#))
  - f. Fan (see [Fan on page 66](#))
  - g. Keyboard (see [Keyboard on page 58](#))
  - h. Base enclosure (see [Base enclosure on page 61](#))

Remove the display assembly:

1. Disconnect the display panel cable **(1)** from the system board.

2. Release the display panel cable from the routing channel (2).

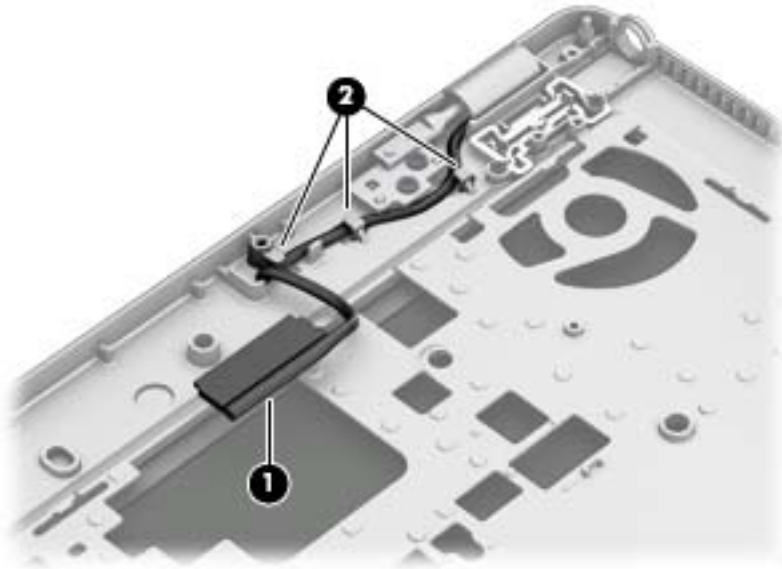

3. Open the computer and position it with the base enclosure on a table and the display hanging down.

 **NOTE:** Be sure to support the display when removing the screws.

4. Remove the four Phillips PM2.5×4.0 screws (1) that secure the display assembly to the computer.
5. Remove the display assembly from the top cover (2).

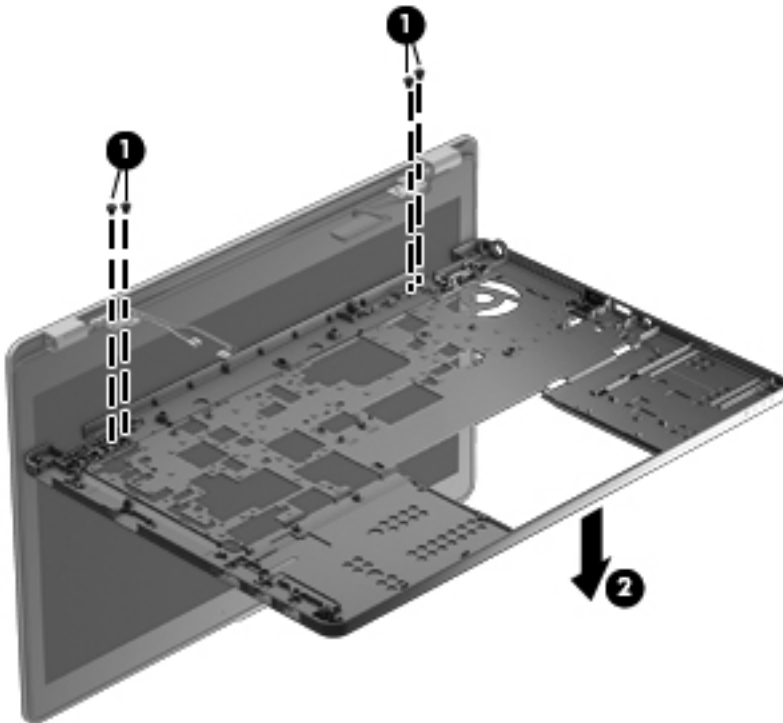

6. To remove the display bezel:
  - a. Flex the inside edges of the bottom edge (1), the left and right sides (2), and the top edge (3) of the display bezel until the bezel disengages from the display enclosure.
  - b. Remove the display bezel (4). The display bezel is available using spare part number 702860-001 on models with a webcam and 702861-001 on models without a webcam.

 **NOTE:** For this procedure the display will not be connected to the computer as shown in the following image.

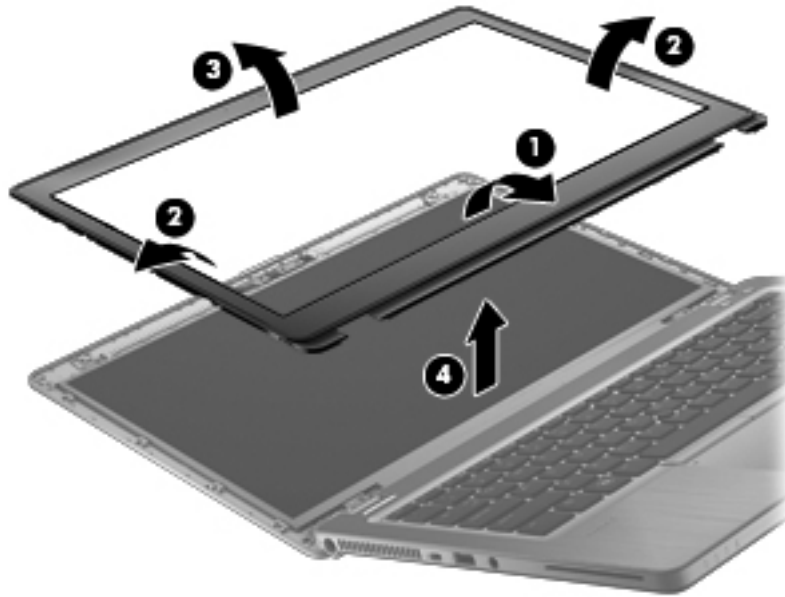

7. To remove the display panel:

 **NOTE:** For this procedure the display will not be connected to the computer as shown in the following images.

- a. Remove the four Phillips PM2.0×3.0 screws that secure the display panel to the display enclosure.

Display panels are available using the following spare part numbers:

- 702871-001 — 35.6-cm (14.0-in), LED, HD, AntiGlare display panel
- 708771-001 — 35.6-cm (14.0-in), LED, HD+, AntiGlare display panel

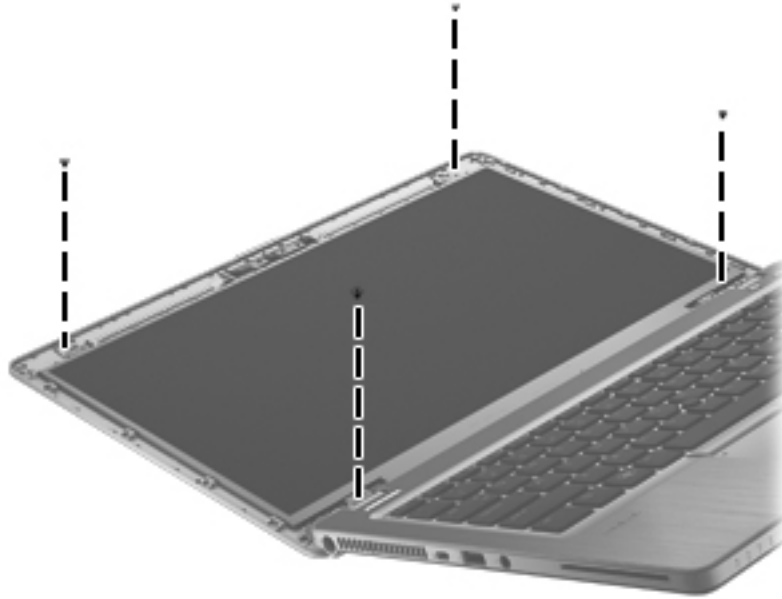

- b. Rotate the top of the display panel downward (1).
- c. Lift the tape that secure the display cable connector on the panel (2), and then disconnect the cable (3) from the connector (4).

 **NOTE:** For this procedure the display will not be connected to the computer as shown in the following image.



8. If it is necessary to replace the display hinges:

Display hinge covers and hinges are available in the Display Hinge Kit, spare part number 702857-001.

- a. Remove the Phillips broadhead PM2.0×2.5 screw (1) that secures each hinge cover to the display enclosure.
- b. Remove the display hinge covers (2) from atop the hinges.

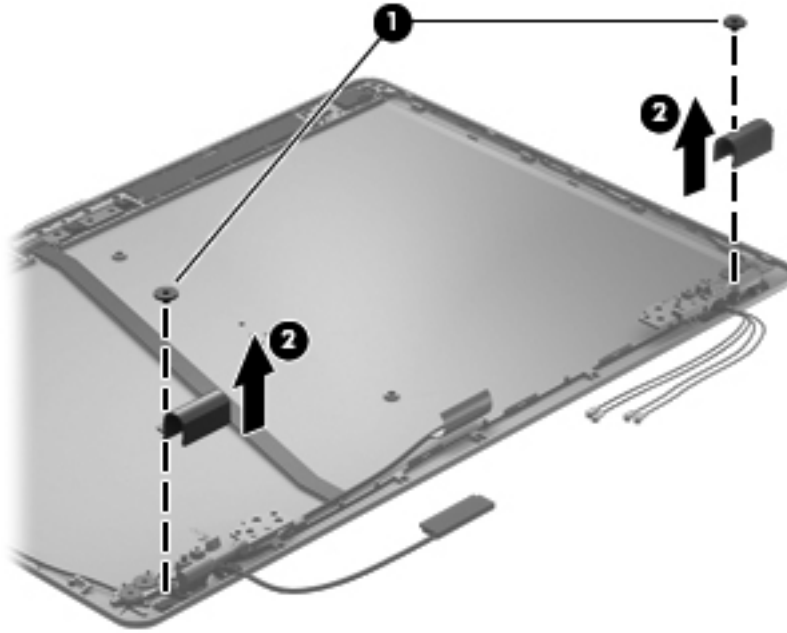

- c. Remove the 2 broadhead Phillips PM2.0×2.5 screws (1) that secure each display hinge to the display enclosure.



- d. Lift the display hinges off the display enclosure (2).

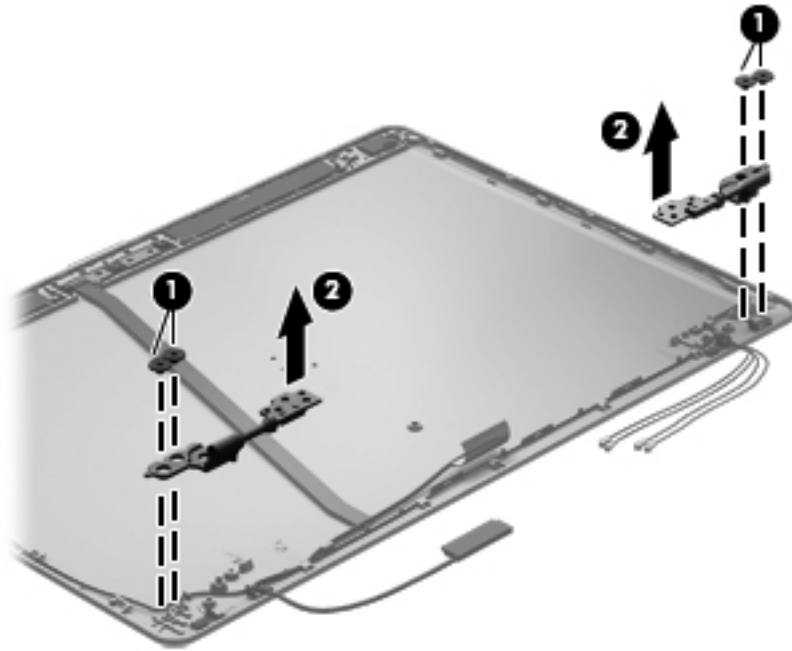

9. If it is necessary to replace the WLAN antenna cables and transceivers:

WLAN and WWAN antennas are available in the Antenna Kit, spare part number 702876-001.

- a. Release the WLAN antenna transceivers (1) from the clips built into the display enclosure. (The WLAN antenna transceivers are attached to the display enclosure with double-sided tape.)
- b. Detach the WLAN antenna cables from the routing channels (2) built into the display enclosure.
- c. Remove the WLAN antenna cables and transceivers. The WLAN antenna cables and transceivers are included in the Antenna Kit, spare part number 702876-001.

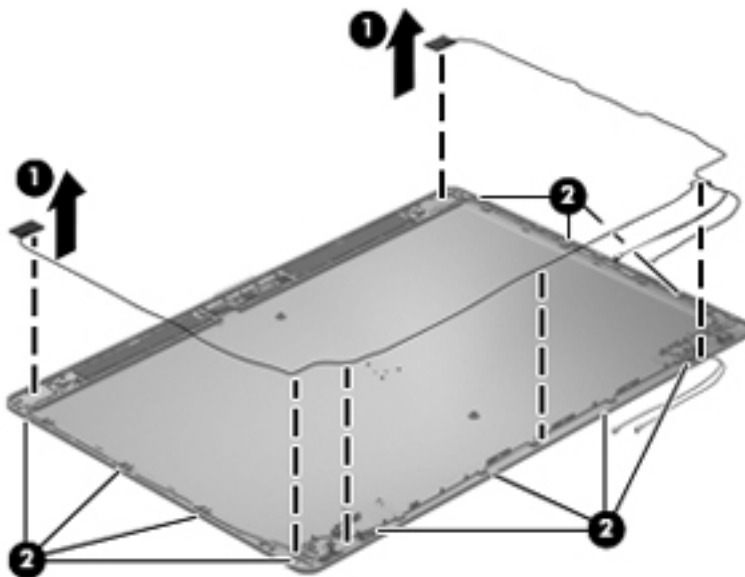

10. If it is necessary to replace the WWAN antenna cables and transceivers:

WLAN and WWAN antennas are available in the Antenna Kit, spare part number 702876-001.

- a. Release the WWAN antenna transceivers (**1**) from the clips built into the display enclosure. (The WWAN antenna transceivers are attached to the display enclosure with double-sided tape.)
- b. Detach the WWAN antenna cables from the routing channels (**2**) built into the display enclosure.
- c. Remove the WWAN antenna cables and transceivers. The WWAN antenna cables and transceivers are included in the Antenna Kit, spare part number 702876-001.

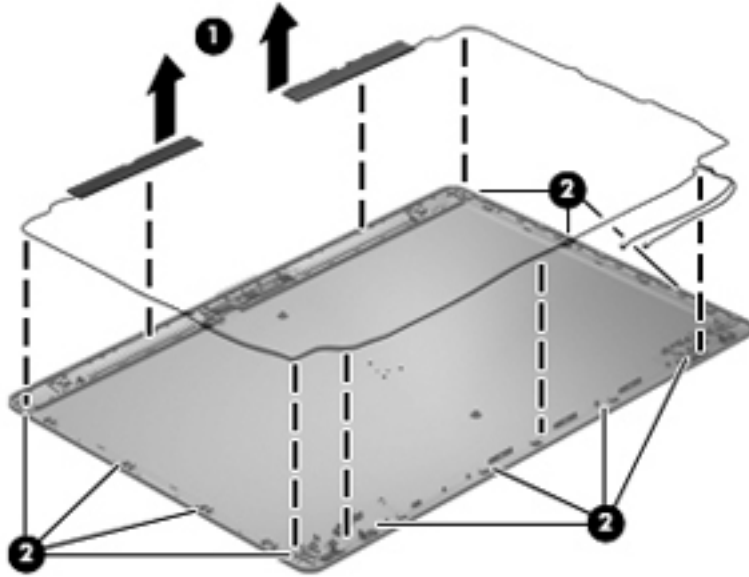

Reverse this procedure to reassemble and install the display assembly.

---

# 5 Computer Setup (BIOS) and Advanced System Diagnostics

## Windows 7 – Computer Setup (BIOS) and Advanced System Diagnostics

### Using Computer Setup

Computer Setup, or Basic Input/Output System (BIOS), controls communication between all the input and output devices on the system (such as disk drives, display, keyboard, mouse, and printer). Computer Setup includes settings for the types of devices installed, the startup sequence of the computer, and the amount of system and extended memory.

---

 **NOTE:** Use extreme care when making changes in Computer Setup. Errors can prevent the computer from operating properly.

---

### Starting Computer Setup

---

 **NOTE:** An external keyboard or mouse connected to a USB port can be used with Computer Setup only if USB legacy support is enabled.

---

To start Computer Setup, follow these steps:

1. Turn on or restart the computer, and then press **esc** while the “Press the ESC key for Startup Menu” message is displayed at the bottom of the screen.
2. Press **f10** to enter Computer Setup.

### Navigating and selecting in Computer Setup

To navigate and select in Computer Setup, follow these steps:

1. Turn on or restart the computer, and then press **esc** while the “Press the ESC key for Startup Menu” message is displayed at the bottom of the screen.
  - To select a menu or a menu item, use the **tab** key and the keyboard arrow keys and then press **enter**, or use a pointing device to click the item.
  - To scroll up and down, click the up arrow or the down arrow in the upper-right corner of the screen, or use the up arrow key or the down arrow key.
  - To close open dialog boxes and return to the main Computer Setup screen, press **esc**, and then follow the on-screen instructions.

---

 **NOTE:** You can use either a pointing device (TouchPad, pointing stick, or USB mouse) or the keyboard to navigate and make selections in Computer Setup.

---

2. Press **f10** to enter Computer Setup.

To exit Computer Setup menus, choose one of the following methods:

- To exit Computer Setup menus without saving your changes:

Click the **Exit** icon in the lower-left corner of the screen, and then follow the on-screen instructions.

– or –

Use the **tab** key and the arrow keys to select **File > Ignore Changes and Exit**, and then press **enter**.

- To save your changes and exit Computer Setup menus:

Click the **Save** icon in the lower-left corner of the screen, and then follow the on-screen instructions.

– or –

Use the **tab** key and the arrow keys to select **File > Save Changes and Exit**, and then press **enter**.

Your changes go into effect when the computer restarts.

## Restoring factory settings in Computer Setup

---

 **NOTE:** Restoring defaults will not change the hard drive mode.

---

To return all settings in Computer Setup to the values that were set at the factory, follow these steps:

1. Turn on or restart the computer, and then press **esc** while the “Press the ESC key for Startup Menu” message is displayed at the bottom of the screen.
2. Press **f10** to enter Computer Setup.
3. Use a pointing device or the arrow keys to select **File > Restore Defaults**.
4. Follow the on-screen instructions.
5. To save your changes and exit, click the **Save** icon in the lower-left corner of the screen, and then follow the on-screen instructions.

– or –

Use the arrow keys to select **File > Save Changes and Exit**, and then press **enter**.

Your changes go into effect when the computer restarts.

---

 **NOTE:** Your password settings and security settings are not changed when you restore the factory settings.

---

## Updating the BIOS

Updated versions of the BIOS may be available on the HP website.

Most BIOS updates on the HP website are packaged in compressed files called *SoftPaqs*.

Some download packages contain a file named *Readme.txt*, which contains information regarding installing and troubleshooting the file.

### Determining the BIOS version

To determine whether available BIOS updates contain later BIOS versions than those currently installed on the computer, you need to know the version of the system BIOS currently installed.

BIOS version information (also known as *ROM date* and *System BIOS*) can be displayed by pressing **fn+esc** (if you are already in Windows) or by using Computer Setup.

1. Start Computer Setup.
2. Use a pointing device or the arrow keys to select **File > System Information**.
3. To exit Computer Setup without saving your changes, click the **Exit** icon in the lower-left corner of the screen, and then follow the on-screen instructions.

– or –

Use the **tab** key and the arrow keys to select **File > Ignore Changes and Exit**, and then press **enter**.

### Downloading a BIOS update

 **CAUTION:** To reduce the risk of damage to the computer or an unsuccessful installation, download and install a BIOS update only when the computer is connected to reliable external power using the AC adapter. Do not download or install a BIOS update while the computer is running on battery power, docked in an optional docking device, or connected to an optional power source. During the download and installation, follow these instructions:

Do not disconnect power on the computer by unplugging the power cord from the AC outlet.

Do not shut down the computer or initiate sleep.

Do not insert, remove, connect, or disconnect any device, cable, or cord.

1. From the Start screen, type `help` and then select **Help and Support**.
2. In the **Help and Support** search box, type `maintain`, and then follow the on-screen instructions to identify your computer and access the BIOS update you want to download.
3. At the download area, follow these steps:
  - a. Identify the BIOS update that is later than the BIOS version currently installed on your computer. Make a note of the date, name, or other identifier. You may need this information to locate the update later, after it has been downloaded to your hard drive.
  - b. Follow the on-screen instructions to download your selection to the hard drive.

Make a note of the path to the location on your hard drive where the BIOS update is downloaded. You will need to access this path when you are ready to install the update.



---

**NOTE:** If you connect your computer to a network, consult the network administrator before installing any software updates, especially system BIOS updates.

---

BIOS installation procedures vary. Follow any instructions that are displayed on the screen after the download is complete. If no instructions are displayed, follow these steps:

1. From the Start screen, type `explorer`, and then select **File Explorer**.
2. Double-click your hard drive designation. The hard drive designation is typically Local Disk (C:).
3. Using the hard drive path you recorded earlier, open the folder on your hard drive that contains the update.
4. Double-click the file that has an `.exe` extension (for example, `filename.exe`).

The BIOS installation begins.

5. Complete the installation by following the on-screen instructions.



---

**NOTE:** After a message on the screen reports a successful installation, you can delete the downloaded file from your hard drive.

---

## Using Advanced System Diagnostics

Advanced System Diagnostics allows you to run diagnostic tests to determine if the computer hardware is functioning properly. The following diagnostic tests are available in Advanced System Diagnostics:

- **System Tune-Up**—This group of additional tests checks your computer to make sure that the main components are functioning correctly. System Tune-Up runs longer and more comprehensive tests on memory modules, hard drive SMART attributes, the hard drive surface, the battery (and battery calibration), video memory, and the WLAN module status.
- **Start-up test**—This test analyzes the main computer components that are required to start the computer.
- **Run-in test**—This test repeats the start-up test and checks for intermittent problems that the start-up test does not detect.
- **Hard disk test**—This test analyzes the physical condition of the hard drive, and then checks all data in every sector of the hard drive. If the test detects a damaged sector, it attempts to move the data to a good sector.
- **Memory test**—This test analyzes the physical condition of the memory modules. If it reports an error, replace the memory modules immediately.
- **Battery test**—This test analyzes the condition of the battery and calibrates the battery if necessary. If the battery fails the test, contact HP support to report the issue and purchase a replacement battery.
- **BIOS Management**—You can update or rollback the version of the BIOS on the system. Do not shut down or remove external power during the process. You will be given a confirmation screen before your BIOS is modified. Select **BIOS update**, **BIOS Rollback**, or **Back to main menu**.

You can view system information and error logs or select languages in the Advanced System Diagnostics window.

To start Advanced System Diagnostics:

1. Turn on or restart the computer. While the “Press the ESC key for Startup Menu” message is displayed in the lower-left corner of the screen, press **esc**. When the Startup Menu is displayed, press **f2**.
2. Click the diagnostic test you want to run, and then follow the on-screen instructions.

---

 **NOTE:** If you need to stop a diagnostics test while it is running, press **esc**.

---

## Windows 8 – Computer Setup (BIOS) and Advanced System Diagnostics

### Using Computer Setup

Computer Setup, or Basic Input/Output System (BIOS), controls communication between all the input and output devices on the system (such as disk drives, display, keyboard, mouse, and printer). Computer Setup includes settings for the types of devices installed, the startup sequence of the computer, and the amount of system and extended memory.

---

 **NOTE:** Use extreme care when making changes in Computer Setup. Errors can prevent the computer from operating properly.

---

### Starting Computer Setup

---

 **NOTE:** An external keyboard or mouse connected to a USB port can be used with Computer Setup only if USB legacy support is enabled.

---

To start Computer Setup, follow these steps:

1. Turn on or restart the computer, and then press **esc** while the “Press the ESC key for Startup Menu” message is displayed at the bottom of the screen.
2. Press **f10** to enter Computer Setup.

### Navigating and selecting in Computer Setup

To navigate and select in Computer Setup, follow these steps:

1. Turn on or restart the computer, and then press **esc** while the “Press the ESC key for Startup Menu” message is displayed at the bottom of the screen.
  - To select a menu or a menu item, use the **tab** key and the keyboard arrow keys and then press **enter**, or use a pointing device to click the item.
  - To scroll up and down, click the up arrow or the down arrow in the upper-right corner of the screen, or use the up arrow key or the down arrow key.
  - To close open dialog boxes and return to the main Computer Setup screen, press **esc**, and then follow the on-screen instructions.

---

 **NOTE:** You can use either a pointing device (TouchPad, pointing stick, or USB mouse) or the keyboard to navigate and make selections in Computer Setup.

---

2. Press **f10** to enter Computer Setup.

To exit Computer Setup menus, choose one of the following methods:

- To exit Computer Setup menus without saving your changes:

Click the **Exit** icon in the lower-left corner of the screen, and then follow the on-screen instructions.

– or –

Use the **tab** key and the arrow keys to select **File > Ignore Changes and Exit**, and then press **enter**.

- To save your changes and exit Computer Setup menus:

Click the **Save** icon in the lower-left corner of the screen, and then follow the on-screen instructions.

– or –

Use the **tab** key and the arrow keys to select **File > Save Changes and Exit**, and then press **enter**.

Your changes go into effect when the computer restarts.

## Restoring factory settings in Computer Setup



---

**NOTE:** Restoring defaults will not change the hard drive mode.

---

To return all settings in Computer Setup to the values that were set at the factory, follow these steps:

1. Turn on or restart the computer, and then press **esc** while the “Press the ESC key for Startup Menu” message is displayed at the bottom of the screen.
2. Press **f10** to enter Computer Setup.
3. Use a pointing device or the arrow keys to select **File > Restore Defaults**.
4. Follow the on-screen instructions.
5. To save your changes and exit, click the **Save** icon in the lower-left corner of the screen, and then follow the on-screen instructions.

– or –

Use the arrow keys to select **File > Save Changes and Exit**, and then press **enter**.

Your changes go into effect when the computer restarts.



---

**NOTE:** Your password settings and security settings are not changed when you restore the factory settings.

---



## Updating the BIOS

Updated versions of the BIOS may be available on the HP website.

Most BIOS updates on the HP website are packaged in compressed files called *SoftPaqs*.

Some download packages contain a file named *Readme.txt*, which contains information regarding installing and troubleshooting the file.

### Determining the BIOS version

To determine whether available BIOS updates contain later BIOS versions than those currently installed on the computer, you need to know the version of the system BIOS currently installed.

BIOS version information (also known as *ROM date* and *System BIOS*) can be displayed by pressing **fn+esc** (if you are already in Windows) or by using Computer Setup.

1. Start Computer Setup.
2. Use a pointing device or the arrow keys to select **File > System Information**.
3. To exit Computer Setup without saving your changes, click the **Exit** icon in the lower-left corner of the screen, and then follow the on-screen instructions.

– or –

Use the **tab** key and the arrow keys to select **File > Ignore Changes and Exit**, and then press **enter**.

### Downloading a BIOS update

 **CAUTION:** To reduce the risk of damage to the computer or an unsuccessful installation, download and install a BIOS update only when the computer is connected to reliable external power using the AC adapter. Do not download or install a BIOS update while the computer is running on battery power, docked in an optional docking device, or connected to an optional power source. During the download and installation, follow these instructions:

Do not disconnect power on the computer by unplugging the power cord from the AC outlet.

Do not shut down the computer or initiate sleep.

Do not insert, remove, connect, or disconnect any device, cable, or cord.

1. From the Start screen, type `help` and then select **Help and Support**.
2. In the **Help and Support** search box, type `maintain`, and then follow the on-screen instructions to identify your computer and access the BIOS update you want to download.
3. At the download area, follow these steps:
  - a. Identify the BIOS update that is later than the BIOS version currently installed on your computer. Make a note of the date, name, or other identifier. You may need this information to locate the update later, after it has been downloaded to your hard drive.
  - b. Follow the on-screen instructions to download your selection to the hard drive.

Make a note of the path to the location on your hard drive where the BIOS update is downloaded. You will need to access this path when you are ready to install the update.



---

**NOTE:** If you connect your computer to a network, consult the network administrator before installing any software updates, especially system BIOS updates.

---

BIOS installation procedures vary. Follow any instructions that are displayed on the screen after the download is complete. If no instructions are displayed, follow these steps:

1. From the Start screen, type `explorer`, and then select **File Explorer**.
2. Double-click your hard drive designation. The hard drive designation is typically Local Disk (C:).
3. Using the hard drive path you recorded earlier, open the folder on your hard drive that contains the update.
4. Double-click the file that has an `.exe` extension (for example, `filename.exe`).

The BIOS installation begins.

5. Complete the installation by following the on-screen instructions.



---

**NOTE:** After a message on the screen reports a successful installation, you can delete the downloaded file from your hard drive.

---

## Using Advanced System Diagnostics

Advanced System Diagnostics allows you to run diagnostic tests to determine if the computer hardware is functioning properly. The following diagnostic tests are available in Advanced System Diagnostics:

- **System Tune-Up**—This group of additional tests checks your computer to make sure that the main components are functioning correctly. System Tune-Up runs longer and more comprehensive tests on memory modules, hard drive SMART attributes, the hard drive surface, the battery (and battery calibration), video memory, and the WLAN module status.
- **Start-up test**—This test analyzes the main computer components that are required to start the computer.
- **Run-in test**—This test repeats the start-up test and checks for intermittent problems that the start-up test does not detect.
- **Hard disk test**—This test analyzes the physical condition of the hard drive, and then checks all data in every sector of the hard drive. If the test detects a damaged sector, it attempts to move the data to a good sector.
- **Memory test**—This test analyzes the physical condition of the memory modules. If it reports an error, replace the memory modules immediately.
- **Battery test**—This test analyzes the condition of the battery and calibrates the battery if necessary. If the battery fails the test, contact HP support to report the issue and purchase a replacement battery.
- **BIOS Management**—You can update or rollback the version of the BIOS on the system. Do not shut down or remove external power during the process. You will be given a confirmation screen before your BIOS is modified. Select **BIOS update**, **BIOS Rollback**, or **Back to main menu**.

You can view system information and error logs or select languages in the Advanced System Diagnostics window.

To start Advanced System Diagnostics:

1. Turn on or restart the computer. While the “Press the ESC key for Startup Menu” message is displayed in the lower-left corner of the screen, press **esc**. When the Startup Menu is displayed, press **f2**.
2. Click the diagnostic test you want to run, and then follow the on-screen instructions.

---

 **NOTE:** If you need to stop a diagnostics test while it is running, press **esc**.

---

## SUSE Linux – Computer Setup (BIOS) and Advanced System Diagnostics

Computer Setup, or Basic Input/Output System (BIOS), controls communication between all the input and output devices on the system (such as disk drives, display, keyboard, mouse, and printer). Computer Setup includes settings for the types of peripherals installed, the startup sequence of the computer, and the amount of system and extended memory.

---

 **NOTE:** Use extreme care when making changes in Computer Setup. Errors can prevent the computer from operating properly.

---

### Starting Computer Setup

---

 **NOTE:** An external keyboard or mouse connected to a USB port can be used with Computer Setup only if USB legacy support is enabled.

---

To start Computer Setup, follow these steps:

1. Turn on or restart the computer, and then press **esc** while the “Press the ESC key for Startup Menu” message is displayed at the bottom of the screen.
2. Press **f10** to enter Computer Setup.

### Using Computer Setup

#### Navigating and selecting in Computer Setup

To navigate and select in Computer Setup, follow these steps:

1. Turn on or restart the computer, and then press **esc** while the “Press the ESC key for Startup Menu” message is displayed at the bottom of the screen.
  - To select a menu or a menu item, use the **tab** key and the keyboard arrow keys and then press **enter**, or use a pointing device to click the item.
  - To scroll up and down, click the up arrow or the down arrow in the upper-right corner of the screen, or use the up arrow key or the down arrow key.
  - To close open dialog boxes and return to the main Computer Setup screen, press **esc**, and then follow the on-screen instructions.

---

 **NOTE:** You can use either a pointing device (TouchPad, pointing stick, or USB mouse) or the keyboard to navigate and make selections in Computer Setup.

---

2. Press **f10** to enter Computer Setup.

To exit Computer Setup menus, choose one of the following methods:

- To exit Computer Setup menus without saving your changes, click the **Exit** icon in the lower-left corner of the screen, and then follow the on-screen instructions.

– or –

Use the **tab** key and the arrow keys to select **File > Ignore Changes and Exit**, and then press **enter**.

– or –

- To save your changes and exit Computer Setup menus, click the **Save** icon in the lower-left corner of the screen, and then follow the on-screen instructions.

– or –

Use the **tab** key and the arrow keys to select **File > Save Changes and Exit**, and then press **enter**.

Your changes go into effect when the computer restarts.

## Restoring factory settings in Computer Setup



---

**NOTE:** Restoring defaults will not change the hard drive mode.

---

To return all settings in Computer Setup to the values that were set at the factory, follow these steps:

1. Turn on or restart the computer, and then press **esc** while the “Press the ESC key for Startup Menu” message is displayed at the bottom of the screen.
2. Press **f10** to enter Computer Setup.
3. Use a pointing device or the arrow keys to select **File > Restore Defaults**.
4. Follow the on-screen instructions.
5. To save your changes and exit, click the **Save** icon in the lower-left corner of the screen, and then follow the on-screen instructions.

– or –

Use the arrow keys to select **File > Save Changes and Exit**, and then press **enter**.

Your changes go into effect when the computer restarts.



---

**NOTE:** Your password settings and security settings are not changed when you restore the factory settings.

---

## Updating the BIOS

Updated versions of the BIOS may be available on the HP Web site.

Most BIOS updates on the HP Web site are packaged in compressed files called *SoftPaqs*.

Some download packages contain a file named *Readme.txt*, which contains information regarding installing and troubleshooting the file.

## Determining the BIOS version

To determine whether available BIOS updates contain later BIOS versions than those currently installed on the computer, you need to know the version of the system BIOS currently installed.

BIOS version information (also known as *ROM date* and *System BIOS*) can be displayed as follows:

1. Start Computer Setup.
2. Use a pointing device or the arrow keys to select **File > System Information**.
3. To exit Computer Setup without saving your changes, click the **Exit** icon in the lower-left corner of the screen, and then follow the on-screen instructions.

– or –

Use the **tab** key and the arrow keys to select **File > Ignore Changes and Exit**, and then press **enter**.

---

 **NOTE:** You can also determine the BIOS version by turning on or restarting the computer, pressing the **esc** key while the “Press the ESC key for Startup Menu” message is displayed at the bottom of the screen, and then pressing the **f1** key. Follow the on-screen instructions to exit this screen.

---

## Downloading a BIOS update

 **CAUTION:** To reduce the risk of damage to the computer or an unsuccessful installation, download and install a BIOS update only when the computer is connected to reliable external power using the AC adapter. Do not download or install a BIOS update while the computer is running on battery power, docked in an optional docking device, or connected to an optional power source. During the download and installation, follow these instructions:

Do not disconnect power from the computer by unplugging the power cord from the AC outlet.

Do not shut down the computer or initiate Suspend or Hibernation.

Do not insert, remove, connect, or disconnect any device, cable, or cord.

---

1. Open your web browser. For U.S. support, go to <http://www.hp.com/go/contactHP>. For worldwide support, go to [http://welcome.hp.com/country/us/en/wwcontact\\_us.html](http://welcome.hp.com/country/us/en/wwcontact_us.html).
2. Follow the on-screen instructions to identify your computer and access the BIOS update you want to download.
3. Click the option for software and driver downloads, type your computer model number in the product box, and then press **enter**. Follow the on-screen instructions to identify your computer and access the BIOS update you want to download.
4. Click your specific product from the models listed.
5. Click the appropriate operating system.
6. Go to the BIOS section and download the BIOS software package.
7. Follow the installation instructions as provided with the downloaded BIOS software package.

---

 **NOTE:** After a message on the screen reports a successful installation, you can delete the downloaded file from your hard drive.

---

## Using Advanced System Diagnostics

Advanced System Diagnostics allows you to run diagnostic tests to determine if the computer hardware is functioning properly. The following diagnostic tests are available in Advanced System Diagnostics:

- **Start-up test**—This test analyzes the main computer components that are required to start the computer.
- **Run-in test**—This test repeats the start-up test and checks for intermittent problems that the start-up test does not detect.
- **Hard disk test**—This test analyzes the physical condition of the hard drive, and then checks all data in every sector of the hard drive. If the test detects a damaged sector, it attempts to move the data to a good sector.
- **Memory test**—This test analyzes the physical condition of the memory modules. If it reports an error, replace the memory modules immediately.
- **Battery test**—This test analyzes the condition of the battery and calibrates the battery if necessary. If the battery fails the test, contact support to report the issue and purchase a replacement battery.
- **System Tune-Up**—This group of additional tests checks your computer to make sure that the main components are functioning correctly. System Tune-Up runs longer and more comprehensive tests on memory modules, hard drive SMART attributes, the hard drive surface, the battery (and battery calibration), video memory, and the WLAN module status.

You can view system information and error logs in the Advanced System Diagnostics window.

To start Advanced System Diagnostics:

1. Turn on or restart the computer. While the “Press the ESC key for Startup Menu” message is displayed in the lower-left corner of the screen, press **esc**. When the Startup Menu is displayed, press **f2**.
2. Click the diagnostic test you want to run, and then follow the on-screen instructions.



---

**NOTE:** If you need to stop a diagnostics test while it is running, press **esc**.

---

# 6 Specifications

## Computer specifications

	Metric	U.S.
<b>Dimensions</b>		
Width	33.80 cm	13.3 in
Depth	23.13 cm	9.09 in
Height (front to back)	1.95 cm	0.77 in
<b>Weight</b>		
Equipped with one memory module, WLAN module, and mSATA drive	1.63 kg	3.6 lbs
<b>Input power</b>		
Operating voltage and current	18.5 V dc @ 3.5 A - 65 W – or – 19.0 V dc @ 4.74 A - 90 W	
<b>Temperature</b>		
Operating	5°C to 35°C	41°F to 95°F
Nonoperating	-20°C to 60°C	-4°F to 140°F
<b>Relative humidity (noncondensing)</b>		
Operating	10% to 90%	
Nonoperating	5% to 95%	
<b>Maximum altitude (unpressurized)</b>		
Operating	-15 m to 3,048 m	-50 ft to 10,000 ft
Nonoperating	-15 m to 12,192 m	-50 ft to 40,000 ft
<b>NOTE:</b> Applicable product safety standards specify thermal limits for plastic surfaces. The device operates well within this range of temperatures.		

## 35.6-cm (14.0-in) display specifications

	<b>Metric</b>	<b>U.S.</b>
<b>Dimensions</b>		
Height	<b>17.6 cm</b>	6.93 in
Width	<b>31.2 cm</b>	12.28 in
Diagonal	<b>35.7 cm</b>	14.06 in
<b>Number of colors</b>	up to 16.8 million	
<b>Contrast ratio</b>	200:1 (typical)	
<b>Brightness</b>	200 nits (typical)	
<b>Pixel resolution</b>		
Pitch	<b>0.197 × 0.197 mm</b>	
Format	HD, SVA (1366 x 768)	
Configuration	RGB vertical stripe	
<b>Backlight</b>	LED	
<b>Character display</b>	80 × 25	
<b>Total power consumption</b>	3.46 W	
<b>Viewing angle</b>	±65° horizontal, ±50° vertical (typical)	



## Hard drive specifications

	500-GB*	320-GB*
<b>Dimensions</b>		
Height	7 mm	7 mm
Length	100.4 mm	100.4 mm
Width	69.9 mm	69.9 mm
Weight	110 g	110 g
<b>Interface type</b>	SATA	SATA
<b>Transfer rate</b>		
Synchronous (maximum)	1.1 GB/sec	1.1 GB/sec
Security	ATA security or SED	ATA security
<b>Seek times</b> (typical read, including setting)		
Single track	1.5 ms	1.5 ms
Average (read/write)	11/13 ms	11/13 ms
Maximum	22 ms	22 ms
<b>Logical blocks</b>	976,773,168	628,142,448
<b>Disk rotational speed</b>	7200 rpm	7200 rpm
<b>Operating temperature</b>		
*1 GB = 1 billion bytes when referring to hard drive storage capacity. Actual accessible capacity is less.		
<b>NOTE:</b> Certain restrictions and exclusions apply. Contact technical support for details.		

## Solid-state drive specifications

	180-GB*	256-GB*
<b>Dimensions</b>		
Height	7 mm	7 mm
Length	100.5 mm	100.5 mm
Width	69.9 mm	69.9 mm
Weight	78 g	78 g
<b>Interface type</b>		
	ATA-7	ATA-7
<b>Transfer rate</b>		
Sequential Read	Up to 550 MB/s	Up to 460 MB/s
Random Read	Up to 50K IOPS	Up to 46K IOPS
Sequential Write	Up to 520 MB/s	Up to 260 MB/s
Random Write	Up to 80K IOPS	Up to 56K IOPS
<b>Ready time, Maximum (to not busy)</b>		
	2.0 s	4.0 s
<b>Access times</b>		
Logical	0.1 ms	0.1
<b>Total logical sectors</b>		
	351,651,888	500,118,192
<b>Operating temperature</b>		
Operating	0° to 70°C (32°F to 158°F)	0° to 70°C (32°F to 158°F)
Non-operating	-55° to 95°C (-67°F to 203°F)	-40° to 80°C (-40°F to 176°F)
*1 GB = 1 billion bytes when referring to hard drive storage capacity. Actual accessible capacity is less.		
<b>NOTE:</b> Certain restrictions and exclusions apply. Contact technical support for details.		

## mSATA drive specifications

	24-GB*	32-GB*	256-GB*
<b>Dimensions</b>			
Height	1 mm	1 mm	1 mm
Length	50.8 mm	50.8 mm	50.8 mm
Width	28.9 mm	28.9 mm	28.9 mm
Weight	< 10 g	< 10 g	< 10 g
<b>Interface type</b>	ATA-7	ATA-7	ATA-7
<b>Transfer rate</b>			
Sequential Read	Up to 160 MB/s	Up to 380 MB/s	Up to 490 MB/s
Random Read	Up to 128 MB/s	Up to 180 MB/s	Up to 480 MB/s
Sequential Write	Up to 115 MB/s	Up to 80 MB/s	Up to 250 MB/s
Random Write	Up to 16 MB/s	Up to 40 MB/s	Up to 100 MB/s
<b>Ready time, Maximum (to not busy)</b>	2.0 s	4.0 s	4.0 s
<b>Access times</b>			
Logical	0.1 ms	0.1 ms	0.1
<b>Total logical sectors</b>	46,905,264	62,533,296	500,118,192
<b>Operating temperature</b>			
Operating	0° to 70°C (32°F to 158°F)	0° to 70°C (32°F to 158°F)	0° to 70°C (32°F to 158°F)
Non-operating	-55° to 95°C (-67°F to 203°F)	-40° to 80°C (-40°F to 176°F)	-40° to 80°C (-40°F to 176°F)
*1 GB = 1 billion bytes when referring to hard drive storage capacity. Actual accessible capacity is less.			
<b>NOTE:</b> Certain restrictions and exclusions apply. Contact technical support for details.			

---

# 7 Backup and recovery

## Windows 7 – Backup and recovery

To protect your information, use Windows Backup and Restore to back up individual files and folders, back up your entire hard drive (select models only), create system repair discs (select models only) with an optional external optical drive, or create system restore points. In case of system failure, you can use the backup files to restore the contents of your computer.

Windows Backup and Restore provides the following options:

- Creating a system repair disc (select models only) by using an optional external optical drive
- Backing up your information
- Creating a system image (select models only)
- Scheduling automatic backups (select models only)
- Creating system restore points
- Recovering individual files
- Restoring the computer to a previous state
- Recovering information using recovery tools

---

 **NOTE:** For detailed instructions, perform a search for these topics in Help and Support.

In case of system instability, HP recommends that you print the recovery procedures and save them for later use.

 **NOTE:** Windows includes the User Account Control feature to improve the security of your computer. You may be prompted for your permission or password for tasks such as installing software, running utilities, or changing Windows settings. See [Help and Support for more information.](#)

## Creating recovery media with HP Recovery Disc Creator

HP Recovery Disc Creator is a software program that offers an alternative way to create recovery media. After you successfully set up the computer, you can create recovery media using HP Recovery Disc Creator. This recovery media performs a system recovery if the hard drive becomes corrupted. A system recovery reinstalls the original operating system and the software programs installed at the factory, and then configures the settings for the programs.

HP Recovery Disc Creator can create two kinds of recovery DVDs as follows:

- Windows DVD—Installs the operating system without additional drivers or applications. Choosing this selection creates a DVD that restores the original operating system and the software programs installed at the factory.
- Driver DVD—Installs specific drivers and applications only, in the same way that the HP Software Setup utility installs drivers and applications.

## Creating recovery media

 **NOTE:** Operating system recovery media can be created only once. Thereafter, the option to create that media will not be available.

1. Select **Start > All Programs > Security and Protection > HP Recovery Disc Creator**.
2. Select **Driver DVD** or **Windows DVD**.
3. From the drop-down menu, select the drive for burning the recovery media.
4. Click the **Burn** button to start the burning process.

## Backing up your information

Recovery after a system failure is as good as your most recent backup. Immediately after software setup, you should create system repair discs (select models only) using HP Recovery Disc Creator using the installed optical drive (select models only) or an optional external optical drive and back up your system. As you add new software and data files, you should continue to back up your system on a regular basis to maintain a reasonably current backup. The system repair discs (select models only) are used to start up (boot) the computer and repair the operating system in case of system instability or failure. Your initial and subsequent backups allow you to restore your data and settings if a failure occurs.

You can back up your information to an optional external hard drive, a network drive, or discs.

Note the following when backing up:

- Store personal files in the Documents library, and back it up regularly.
- Back up templates that are stored in their associated programs.
- Save customized settings that appear in a window, toolbar, or menu bar by taking a screen shot of your settings. The screen shot can be a time-saver if you have to reset your preferences.
- When backing up to discs, use any of the following types of discs (purchased separately): CD-R, CD-RW, DVD+R, DVD+R DL, DVD-R, DVD-R DL, or DVD±RW. The discs you use will depend on the type of optical drive you are using.

 **NOTE:** DVDs and DVDs with double-layer (DL) support store more information than CDs, so using them for backup reduces the number of recovery discs required.

- When backing up to discs, number each disc before inserting it into the external drive.

To create a backup using Backup and Restore:

 **NOTE:** Be sure that the computer is connected to AC power before you start the backup process.

 **NOTE:** The backup process may take over an hour, depending on file size and the speed of the computer.

---

1. Select **Start > All Programs > Maintenance > Backup and Restore**.
2. Follow the on-screen instructions to set up your backup, create a system image (select models only), or create a system repair disc (select models only).

## Performing a system recovery

In case of system failure or instability, the computer provides the following tools to recover your files:

- Windows recovery tools: You can use Windows Backup and Restore to recover information you have previously backed up. You can also use Windows Startup Repair to fix problems that might prevent Windows from starting correctly.
- **f11** recovery tools: You can use the **f11** recovery tools to recover your original hard drive image. The image includes the Windows operating system and software programs installed at the factory.

 **NOTE:** If you are unable to boot (start up) your computer and you cannot use the system repair discs you previously created (select models only), you must purchase a Windows 7 operating system DVD to reboot the computer and repair the operating system. For additional information, see [Using a Windows 7 operating system DVD \(purchased separately\) on page 103](#).

---

## Using the Windows recovery tools

To recover information you previously backed up:

1. Select **Start > All Programs > Maintenance > Backup and Restore**.
2. Follow the on-screen instructions to recover your system settings, your computer (select models only), or your files.

To recover your information using Startup Repair, follow these steps:

 **CAUTION:** Using Startup Repair completely erases hard drive contents and reformats the hard drive. All files you have created and any software installed on the computer are permanently removed. When reformatting is complete, the recovery process restores the operating system, as well as the drivers, software, and utilities from the backup used for recovery.

---

1. If possible, back up all personal files.
2. If possible, check for the presence of the Windows partition and the HP Recovery partition.

To check for the Windows partition, select **Start > Computer**.

To check for the HP Recovery partition, click **Start**, right-click **Computer**, click **Manage**, and then click **Disk Management**.

 **NOTE:** If the HP Recovery partition has been deleted, the **f11** restore option will not function. You must recover your operating system and programs using the Windows 7 operating system DVD and the *Driver Recovery* disc (both purchased separately) if the Windows partition and the HP Recovery partition are not listed. For additional information, see [Using a Windows 7 operating system DVD \(purchased separately\) on page 103](#).

---

3. If the Windows partition and the HP Recovery partition are listed, restart the computer, and then press **f8** before the Windows operating system loads.

4. Select **Startup Repair**.
5. Follow the on-screen instructions.

---

 **NOTE:** For additional information on recovering information using the Windows tools, perform a search for these topics in Help and Support.

---

## Using f11 recovery tools

 **CAUTION:** Using **f11** recovery tools completely erases hard drive contents and reformats the hard drive. All files you have created and any software installed on the computer are permanently removed. The **f11** recovery tool reinstalls the operating system and HP programs and drivers that were installed at the factory. Software not installed at the factory must be reinstalled.

---

To recover the original hard drive image using **f11**:

1. If possible, back up all personal files.
2. If possible, check for the presence of the HP Recovery partition: click **Start**, right-click **Computer**, click **Manage**, and then click **Disk Management**.

 **NOTE:** If the HP Recovery partition is not listed, you must recover your operating system and programs using the Windows 7 operating system DVD and the *Driver Recovery* disc (both purchased separately). For additional information, see [Using a Windows 7 operating system DVD \(purchased separately\) on page 103](#).

---

3. If the HP Recovery partition is listed, restart the computer, and then press **esc** while the “Press the ESC key for Startup Menu” message is displayed at the bottom of the screen.
4. Press **f11** while the “Press <F11> for recovery” message is displayed on the screen.
5. Follow the on-screen instructions.

## Using a Windows 7 operating system DVD (purchased separately)

To order a Windows 7 operating system DVD, go to the HP website. For U.S. support, go to <http://www.hp.com/go/contactHP>. For worldwide support, go to [http://welcome.hp.com/country/us/en/wwcontact\\_us.html](http://welcome.hp.com/country/us/en/wwcontact_us.html). You can also order the DVD by calling support. For contact information, see the *Worldwide Telephone Numbers* booklet included with the computer.

 **CAUTION:** Using a Windows 7 operating system DVD completely erases hard drive contents and reformats the hard drive. All files you have created and any software installed on the computer are permanently removed. When reformatting is complete, the recovery process helps you restore the operating system, as well as drivers, software, and utilities.

---

To initiate recovery using a Windows 7 operating system DVD:

 **NOTE:** This process takes several minutes.

---

1. If possible, back up all personal files.
2. Restart the computer, and then insert the Windows 7 operating system DVD into the optical drive before the Windows operating system loads.
3. When prompted, press any keyboard key.
4. Follow the on-screen instructions.

5. Click **Next**.
6. Select **Repair your computer**.
7. Follow the on-screen instructions.

After the repair is completed:

1. Eject the Windows 7 operating system DVD, and then insert the *Driver Recovery* disc.
2. Install the Hardware Enabling Drivers first, and then install Recommended Applications.

## Windows 8 – Backup and recovery

To protect your information, use Windows Backup and Restore to back up individual files and folders, back up your entire hard drive, create system repair media (select models only) by using an optional external optical drive, or create system restore points. In case of system failure, you can use the backup files to restore the contents of your computer.

From the Start screen, type `restore`, click **Settings**, and then select from the list of displayed options.

---

 **NOTE:** For detailed instructions on various backup and restore options, perform a search for these topics in Help and Support. From the Start screen, type `help`, and then select **Help and Support**.

In case of system instability, HP recommends that you print the recovery procedures and save them for later use.

 **NOTE:** Windows includes the User Account Control feature to improve the security of your computer. You may be prompted for your permission or password for tasks such as installing software, running utilities, or changing Windows settings. Refer to Help and Support for more information. From the Start screen, type `help`, and then select **Help and Support**.

---

### Backing up your information

Recovery after a system failure is as good as your most recent backup. You should create system repair media and your initial backup immediately after initial system setup. As you add new software and data files, you should continue to back up your system on a regular basis to maintain a reasonably current backup. As you add new software and data files, you should continue to back up your system on a regular basis to maintain a reasonably current backup. The system repair media (select models only) are used to start up (boot) the computer and repair the operating system in case of system instability or failure. Your initial and subsequent backups allow you to restore your data and settings if a failure occurs.

On Start screen, type `backup`, select **Settings**, and then select **Save backup copies of your files with File History**.

You can back up your information to an optional external hard drive or a network drive.

Note the following when backing up:

- Store personal files in the Documents library, and back it up regularly.
- Back up templates that are stored in their associated programs.
- Save customized settings that appear in a window, toolbar, or menu bar by taking a screen shot of your settings. The screen shot can be a time-saver if you have to reset your preferences.



To create a backup using Backup and Restore:

---

 **NOTE:** Be sure that the computer is connected to AC power before you start the backup process.

 **NOTE:** The backup process may take over an hour, depending on file size and the speed of the computer.

---

1. From the Start screen, type `backup`, select **Settings**, and then select from the list of displayed options.
2. Follow the on-screen instructions to set up your backup, create a system image (select models only), or create system repair media (select models only).

## Performing a system recovery

In case of system failure or instability, the computer provides the following tools to recover your files:

- Windows recovery tools: You can use Windows Backup and Restore to recover information you have previously backed up. You can also use Windows Startup Repair to fix problems that might prevent Windows from starting correctly.
- **f11** recovery tools: You can use the **f11** recovery tools to recover your original hard drive image. The image includes the Windows operating system and software programs installed at the factory.

---

 **NOTE:** If you are unable to boot (start up) your computer and you cannot use the system repair media you previously created (select models only), you must purchase Windows 8 operating system media to reboot the computer and repair the operating system.

---

## Using the Windows recovery tools

To recover information you previously backed up:

- ▲ From the Start screen, type `help`, and then select **Help and Support**.

To recover your information using Automatic Repair, follow these steps:

 **CAUTION:** Some Automatic Repair options will completely erase and reformat the hard drive. All files you have created and any software installed on the computer are permanently removed. When reformatting is complete, the recovery process restores the operating system, as well as the drivers, software, and utilities from the backup used for recovery.

---

1. If possible, back up all personal files.
2. If possible, check for the presence of the HP Recovery partition and the Windows partition.

From the Start screen, type `explorer`, and then select **File Explorer**.

– or –

From the Start screen, type `computer`, and then select **Computer**.

---

 **NOTE:** If the Windows partition and the HP Recovery partition are not listed, you must recover your operating system and programs using the Windows 8 operating system DVD and the *Driver Recovery* media (both purchased separately).

---

3. If the Windows partition and the HP Recovery partition are listed, restart the computer. After Windows has loaded, press and hold the **shift** key while clicking **Restart**.

4. Select **Troubleshoot**, select **Advanced Options**, and then select **Automatic Repair**.
5. Follow the on-screen instructions.

 **NOTE:** For additional information on recovering information using the Windows tools, perform a search for these topics in Help and Support. From the Start screen, type `help`, and then select **Help and Support**.

## Using f11 recovery tools

 **CAUTION:** Using **f11** completely erases hard drive contents and reformats the hard drive. All files that you have created and any software that you have installed on the computer are permanently removed. The **f11** recovery tool reinstalls the operating system and HP programs and drivers that were installed at the factory. Software not installed at the factory must be reinstalled.

To recover the original hard drive image using **f11**:

1. If possible, back up all personal files.
2. If possible, check for the presence of the HP Recovery partition: From the Start screen, type `computer`, and then select **Computer**.

 **NOTE:** If the HP Recovery partition is not listed, you must recover your operating system and programs using the Windows 8 operating system media and the *Driver Recovery* media (both purchased separately). For additional information, see [Using a Windows 7 operating system DVD \(purchased separately\) on page 103](#).

3. If the HP Recovery partition is listed, restart the computer, and then press `esc` while the “Press the ESC key for Startup Menu” message is displayed at the bottom of the screen.
4. Press **f11** while the “Press <F11> for recovery” message is displayed on the screen.
5. Follow the on-screen instructions.

## Using Windows 8 operating system media (purchased separately)

To order a Windows 8 operating system DVD, go to <http://www.hp.com/support>, select your country or region, and follow the on-screen instructions. You can also order the DVD by calling support. For contact information, see the *Worldwide Telephone Numbers* booklet included with the computer.

 **CAUTION:** Using a Windows 8 operating system media completely erases hard drive contents and reformats the hard drive. All files that you have created and any software that you have installed on the computer are permanently removed. When reformatting is complete, the recovery process helps you restore the operating system, as well as drivers, software, and utilities.

To initiate recovery using a Windows 8 operating system DVD:

 **NOTE:** This process takes several minutes.

1. If possible, back up all personal files.
2. Restart the computer, and then insert the Windows 8 operating system DVD into the optical drive before the Windows operating system loads.
3. When prompted, press any keyboard key.
4. Follow the on-screen instructions.

After the repair is completed:

1. Eject the Windows 8 operating system media and then insert the *Driver Recovery* media.
2. Install the Hardware Enabling Drivers first, and then install Recommended Applications.

## Using Windows Refresh for quick and easy recovery

When your computer is not working properly and you need to regain system stability, the Windows Refresh option allows you to start fresh and keep what is important to you.

---

 **IMPORTANT:** Refresh removes any traditional applications that were not originally installed on the system at the factory.

 **NOTE:** During Refresh, a list of removed traditional applications will be saved so that you have a quick way to see what you might need to reinstall. See Help and Support for instructions on reinstalling traditional applications. From the Start screen, type `help`, and then select **Help and Support**.

 **NOTE:** You may be prompted for your permission or password when using Refresh. See Help and Support for more information. From the Start screen, type `help`, and then select **Help and Support**.

---

To start Refresh:

1. On the Start screen, point to the far-right upper or lower corner of the screen to display the charms.
2. Click **Settings**.
3. Click **Change PC settings** in the bottom-right corner of the screen, and then select **General** from the PC settings screen.
4. Under **Refresh your PC without affecting your files**, select **Get started**, and follow the on-screen instructions.

## Remove everything and reinstall Windows

Sometimes you want to perform detailed reformatting of your computer, or you want to remove personal information before you give away or recycle your computer. The process described in this section provides a speedy, simple way to return the computer to its original state. This option removes all personal data, apps, and settings from your computer, and reinstalls Windows.

---

 **IMPORTANT:** This option does not provide backups of your information. Before using this option, back up any personal information you wish to retain.

---

You can initiate this option by using the `f11` key or from the Start screen.

To use the `f11` key:

1. Press `f11` while the computer boots.  
– or –  
Press and hold `f11` as you press the power button.
2. Select **Troubleshoot** from the boot options menu.
3. Select **Reset your PC**, and follow the on-screen instructions.

To use the Start screen:

1. On the Start screen, point to the far-right upper or lower corner of the screen to display the charms.
2. Click **Settings**.
3. Click **Change PC settings** in the bottom-right corner of the screen, and then select **General** from the PC settings screen.
4. Under **Remove everything and reinstall Windows**, select **Get started**, and follow the on-screen instructions.

## Using HP Software Setup

HP Software Setup can be used to reinstall drivers or select software that has been corrupted or deleted from the system.

1. From the Start screen, type `HP Software Setup`, and select **Apps**.
2. Open HP Software Setup.
3. Follow the on-screen directions to reinstall drivers or select software.

# SUSE Linux – Backup and recovery

Recovery after a system failure is as good as your most recent backup. As you add new software and data files, you should continue to back up your system on a regular basis to maintain a reasonably current backup.

Your computer includes tools provided by HP to help you safeguard your information and retrieve it if ever needed.

## Creating backups

1. Create restore media immediately after you set up the computer. For more information, see [Performing a system recovery on page 110](#).
2. As you add files, routinely create a backup of your system and personal information.

## Backing up your information

You should back up your computer files on a regular schedule to maintain a current backup. You can manually back up your information to an optional external drive, a network drive, or discs. Back up your system at the following times:

- At regularly scheduled times
- Before the computer is repaired or restored
- Before you add or modify hardware or software

To back up your home directory files using **Backup Manager Settings**:

1. Select **Computer > More Applications > Tools > Backup Manager Settings**, and click **Backup my home directory**.
2. Click **Storage Destination Location**, and then select a location to back up your information.
3. Click **Schedule**, and then select a time schedule to perform backups at a regularly scheduled time.

To immediately back up your information, click the **Backup Now** check box.

---

 **NOTE:** Before you back up your information, be sure you have designated a location to save the backup files.

---

4. Click **Save and Backup** to start the backup and to save the backup settings.

To restore backup files:

1. Select **Computer > More Applications > Tools > Backup Manager Restore**.
2. Click **Backup Source**, and then select the location of the backup files.
3. Click **Restore Destination**, and then select the destination to restore the files.
4. To restore all files from the selected location, click **Restore all files**. To restore select files only, click **Restore selected files**, click **Select Files** and then select the files to be restored.

5. Under **Restore Point**, click the time and date of the backup.



---

**NOTE:** If multiple backups have been performed, click **Use the latest version** to restore the latest version.

---

6. Click **Restore** to start restoring the files, or click **Cancel** to cancel the operation.

## Performing a system recovery

Recovery allows you to repair or restore the computer to its original factory state. You can create an HP Factory Image Restore DVD, using an installed or an external DVD±RW optical drive.



**CAUTION:** Using Recovery completely erases hard drive contents and reformats the hard drive. All files you have created and any software installed on the computer are permanently removed. The recovery tool reinstalls the original operating system and HP programs and drivers that were installed at the factory. Software, drivers, and updates not installed by HP must be manually reinstalled. Personal files must be restored from a backup.

---

To restore the computer using the HP Factory Image Restore DVD, you must first create the recovery disc. To create the recovery disc:



---

**NOTE:** HP recommends that you create the HP Factory Image Restore DVD in the event of a system failure.

---

1. Select **Computer > More Applications**.
2. In the left pane, click **Tools**, and then click **Create HP Factory Image Restore DVD** in the right pane.
3. Follow the on-screen instructions to create an image file to burn a recovery disc.

To restore the computer from the recovery disc, follow these steps:

1. If possible, back up all personal files.
2. Insert the HP Factory Image Restore DVD into the optical drive and restart the computer.
3. As the computer is restarting, press **F9** to open the Computer Setup boot option menu.
4. Press the down arrow to select **Restore SLED HP-BNB preload image** from the **Linux boot** menu, and then press **enter**.
5. Using the arrow keys, select **Yes** when prompted: **Do you want to start the System-Restore?**
6. Follow the on-screen instructions.

## USB Recovery option

The USB Recovery Disk On Key (flash drive) option allows you to create a backup image of the SLED operating system installed on select HP Business Notebooks. This Disk On Key may be used to restore the system to the original factory state when the F11 recovery option is not available. This process should be done on first obtaining the computer.



**CAUTION:** The USB recovery option does not preserve data present on the computer's hard drive or on the Disk On Key used for the recovery process. Back up any data on the Disk on Key or the notebook that will be recovered before starting.

 **NOTE:** HP recommends that you create the USB Recovery Disk in the event of a system failure. The Disk On Key used for this process should be 4 GB or larger.

---

#### Creating a USB Recovery Disk On Key

1. Connect the USB Disk On Key to a USB port on the computer.
2. Select **Computer > More applications > Tools > Create Recovery USB**.
3. Enter the root password when prompted.
4. Select **USB Disk On Key** from the list.
5. Click **OK**.
6. A question dialog will remind you that the data on the USB key will be destroyed. To continue, click **OK**. Otherwise, click **Cancel** and back up the contents of the Disk On Key on another computer.
7. The backup process will display a status dialog box while the backup is in progress.

 **NOTE:** A file browser window with the Disk On Key Contents displayed will pop up when the key is mounted. You may close the file browser window if desired. Once the USB Recovery Key has been created, the status dialog will close. The USB Recovery Key is ready for use.

---

#### Recovering from a USB Recovery Disk On Key

 **CAUTION:** Before starting the Recovery process, make sure any data on the system to be recovered has been backed up. The recovery process destroys all data on the system to be recovered.

---

1. Turn off the computer.
2. Connect the USB Disk On Key to a USB port on the computer.
3. Turn on the computer while holding down the **f9** key.
4. Once the system has booted, the **Boot Options** menu should appear.
5. Using the arrow keys, select **USB Disk On Key** and press **enter**.

 **NOTE:** The description may vary from one USB key to another. Any entry other than Optical Disk Drive, Notebook Hard Drive or Notebook Ethernet should be the USB Recovery Disk On Key.

---

6. Once the USB Recovery Disk On Key has been selected, press **enter**. The USB Recovery Disk On Key will boot.
7. Once the USB Recovery Disk On Key has booted, a dialog box will prompt, "Do you want to start the System-Restore?" If data on the computer has not been backed up, use the **tab** key and select **No**. The system will reboot. Back up the system data and repeat the previous steps. If no data should be saved from the computer, use the **tab** key to select **Yes**. Press **enter** to begin the recovery process.
8. After the files are copied to the system, follow the on-screen instructions.

## Remove everything and reinstall SLED

Sometimes you want to perform detailed reformatting of your computer, or you want to remove personal information before you give away or recycle your computer. The process described in this section provides a speedy, simple way to return the computer to its original state. This option removes all personal data, applications, and settings from your computer, and reinstalls the Linux operating system.



---

**IMPORTANT:** This option does not provide backups of your information. Before using this option, back up any personal information you wish to retain.

---

You can initiate this option by using the **f11** key.

To use the **f11** key:

Press **f11** while the computer boots.

– or –

Press and hold **f11** as you press the power button.

The following options are available:

- **Cancel/Reboot**—Reboots the system. No recovery or restore activity is performed.
- **Recover/Repair System**—This option repairs a system that is not working properly and preserves user data.
- **Restore Factory System**—This option restores the system back to the original factory state. User data is not preserved.

Select an option and follow the on-screen instructions.



---

## 8 Power cord set requirements

The wide-range input feature of the computer permits it to operate from any line voltage from 100 to 120 volts AC, or from 220 to 240 volts AC.

The 3-conductor power cord set included with the computer meets the requirements for use in the country or region where the equipment is purchased.

Power cord sets for use in other countries and regions must meet the requirements of the country or region where the computer is used.

### Requirements for all countries

The following requirements are applicable to all countries and regions:

- The length of the power cord set must be at least **1.5 m** (5.0 ft) and no more than **2.0 m** (6.5 ft).
- All power cord sets must be approved by an acceptable accredited agency responsible for evaluation in the country or region where the power cord set will be used.
- The power cord sets must have a minimum current capacity of 10 amps and a nominal voltage rating of 125 or 250 V AC, as required by the power system of each country or region.
- The appliance coupler must meet the mechanical configuration of an EN 60 320/IEC 320 Standard Sheet C13 connector for mating with the appliance inlet on the back of the computer.

## Requirements for specific countries and regions

Country/region	Accredited agency	Applicable note number
Australia	EANSW	1
Austria	OVE	1
Belgium	CEBC	1
Canada	CSA	2
Denmark	DEMKO	1
Finland	FIMKO	1
France	UTE	1
Germany	VDE	1
Italy	IMQ	1
Japan	METI	3
The Netherlands	KEMA	1
Norway	NEMKO	1
The People's Republic of China	COC	5
South Korea	EK	4
Sweden	SEMKO	1
Switzerland	SEV	1
Taiwan	BSMI	4
The United Kingdom	BSI	1
The United States	UL	2

1. The flexible cord must be Type HO5VV-F, 3-conductor, 1.0-mm<sup>2</sup> conductor size. Power cord set fittings (appliance coupler and wall plug) must bear the certification mark of the agency responsible for evaluation in the country or region where it will be used.
2. The flexible cord must be Type SPT-3 or equivalent, No. 18 AWG, 3-conductor. The wall plug must be a two-pole grounding type with a NEMA 5-15P (15 A, 125 V) or NEMA 6-15P (15 A, 250 V) configuration.
3. The appliance coupler, flexible cord, and wall plug must bear a "T" mark and registration number in accordance with the Japanese Dentori Law. The flexible cord must be Type VCT or VCTF, 3-conductor, 1.00-mm<sup>2</sup> conductor size. The wall plug must be a two-pole grounding type with a Japanese Industrial Standard C8303 (7 A, 125 V) configuration.
4. The flexible cord must be Type RVV, 3-conductor, 0.75-mm<sup>2</sup> conductor size. Power cord set fittings (appliance coupler and wall plug) must bear the certification mark of the agency responsible for evaluation in the country or region where it will be used.
5. The flexible cord must be Type VCTF, 3-conductor, 0.75-mm<sup>2</sup> conductor size. Power cord set fittings (appliance coupler and wall plug) must bear the certification mark of the agency responsible for evaluation in the country or region where it will be used.

---

# 9 Recycling

## Battery

When a non-rechargeable or rechargeable battery has reached the end of its useful life, do not dispose of the battery in general household waste. Follow the local laws and regulations in your area for battery disposal.

HP encourages customers to recycle used electronic hardware, HP original print cartridges, and rechargeable batteries. For more information about recycling programs, see the HP Web site at <http://www.hp.com/recycle>.

## Display

---

**⚠ WARNING!** The backlight contains mercury. Exercise caution when removing and handling the backlight to avoid damaging this component and causing exposure to the mercury.

**⚠ CAUTION:** The procedures in this chapter can result in damage to display components. The only components intended for recycling purposes are the LCD panel and the backlight. When you remove these components, handle them carefully.

**📝 NOTE: Materials Disposal.** This HP product contains mercury in the backlight in the display assembly that might require special handling at end-of-life. Disposal of mercury may be regulated because of environmental considerations. For disposal or recycling information, contact your local authorities, or see the Electronic Industries Alliance (EIA) Web site at <http://www.eiae.org>.

---

This section provides disassembly instructions for the display assembly. The display assembly must be disassembled to gain access to the backlight **(1)** and the liquid crystal display (LCD) panel **(2)**.



---

**📝 NOTE:** The procedures provided in this chapter are general disassembly instructions. Specific details, such as screw sizes, quantities, and locations, and component shapes and sizes, can vary from one computer model to another.

---

Perform the following steps to disassemble the display assembly:

1. Remove all screw covers (1) and screws (2) that secure the display bezel to the display assembly.

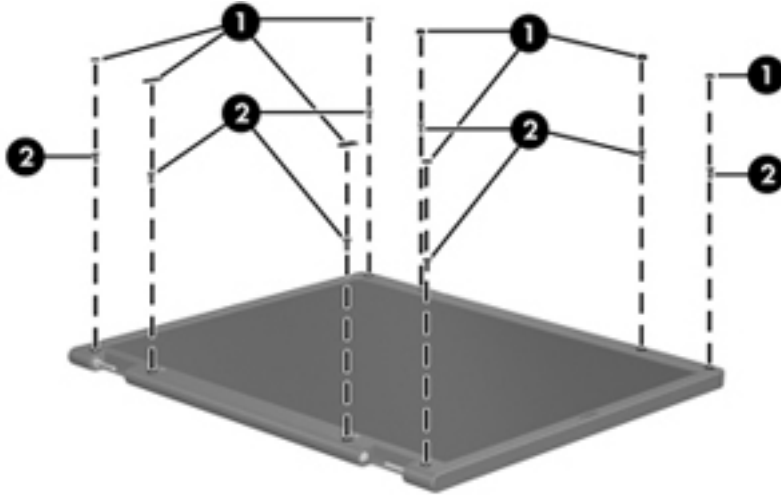

2. Lift up and out on the left and right inside edges (1) and the top and bottom inside edges (2) of the display bezel until the bezel disengages from the display assembly.
3. Remove the display bezel (3).

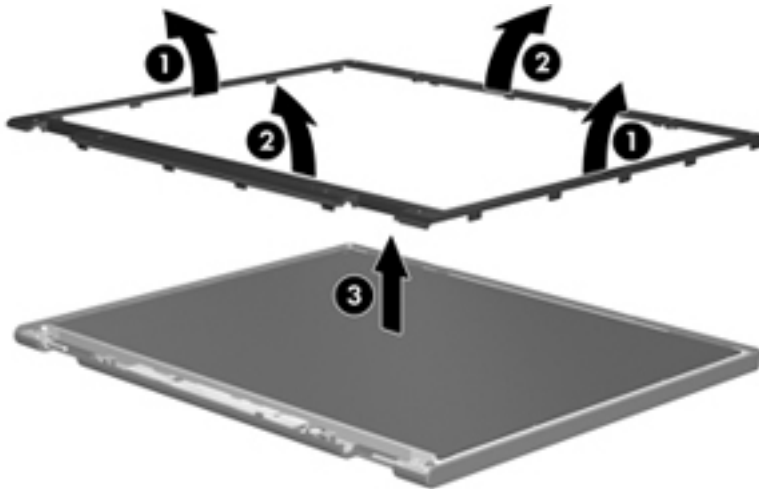

4. Disconnect all display panel cables (1) from the display inverter and remove the inverter (2).

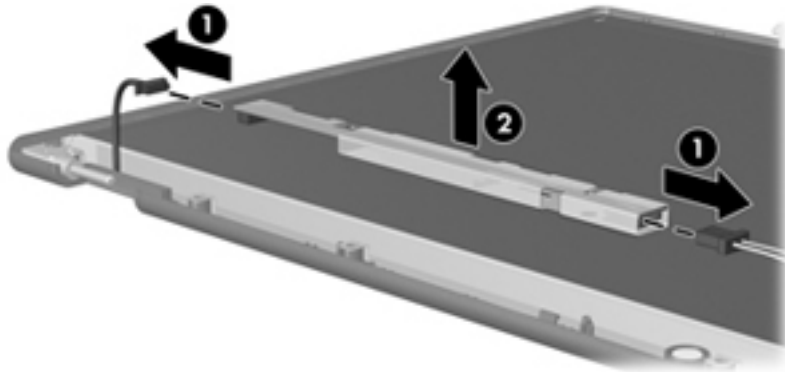

5. Remove all screws (1) that secure the display panel assembly to the display enclosure.
6. Remove the display panel assembly (2) from the display enclosure.

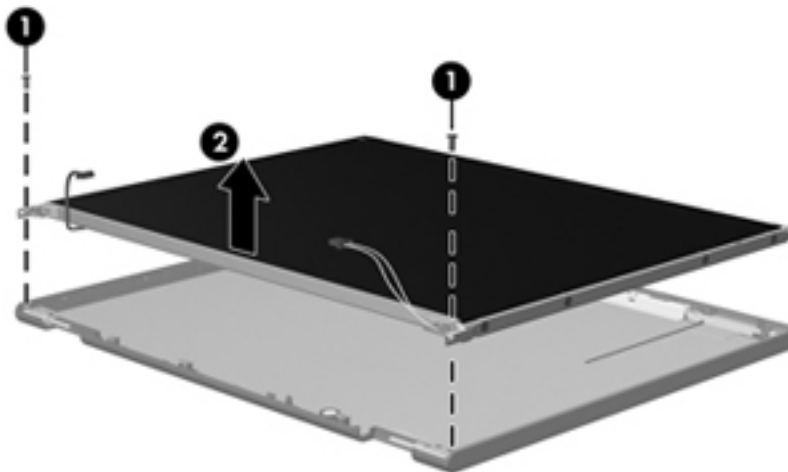

7. Position the display panel assembly upside-down.
8. Remove all screws that secure the display panel frame to the display panel.

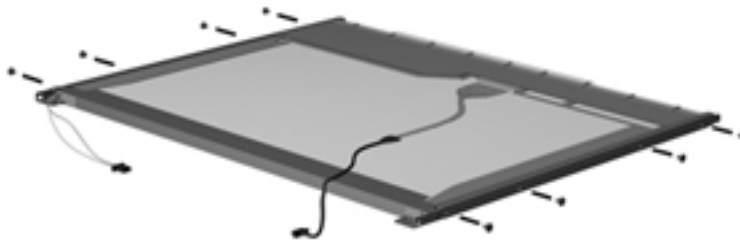

9. Use a sharp-edged tool to cut the tape (1) that secures the sides of the display panel to the display panel frame.

10. Remove the display panel frame (2) from the display panel.

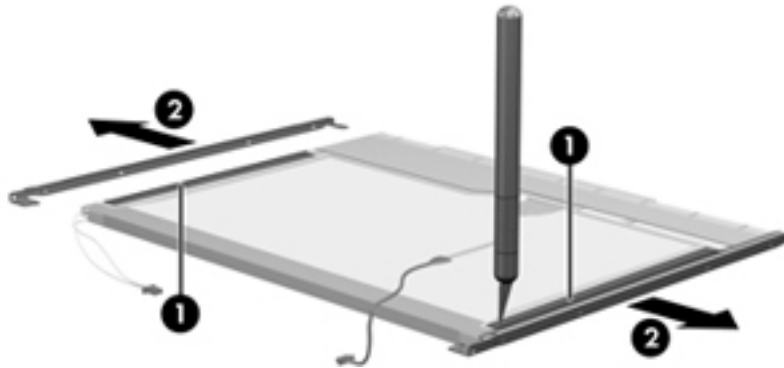

11. Remove the screws (1) that secure the backlight cover to the display panel.
12. Lift the top edge of the backlight cover (2) and swing it outward.

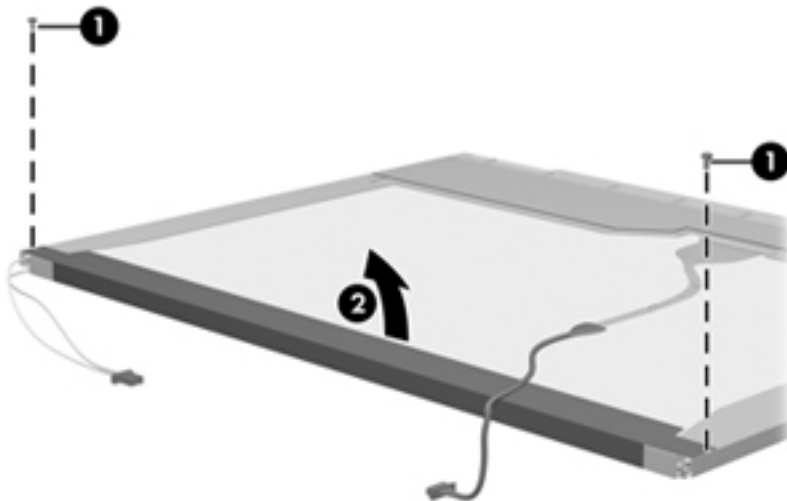

13. Remove the backlight cover.
14. Position the display panel right-side up.

15. Remove the backlight cables (1) from the clip (2) in the display panel.

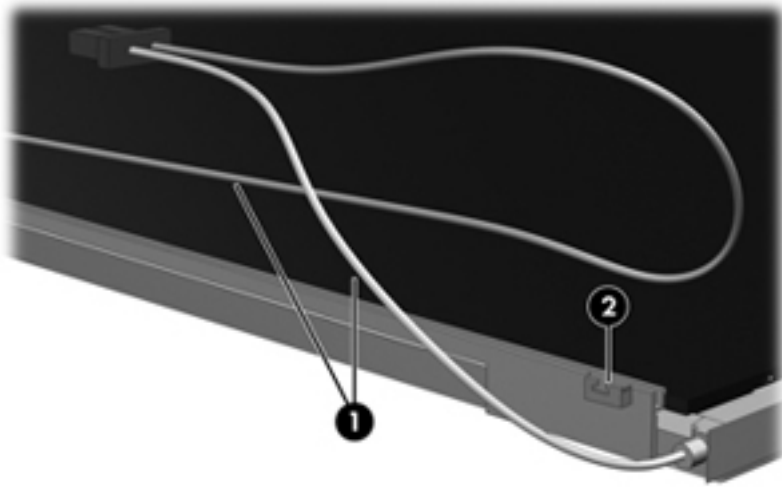

16. Position the display panel upside-down.

**⚠ WARNING!** The backlight contains mercury. Exercise caution when removing and handling the backlight to avoid damaging this component and causing exposure to the mercury.

17. Remove the backlight frame from the display panel.

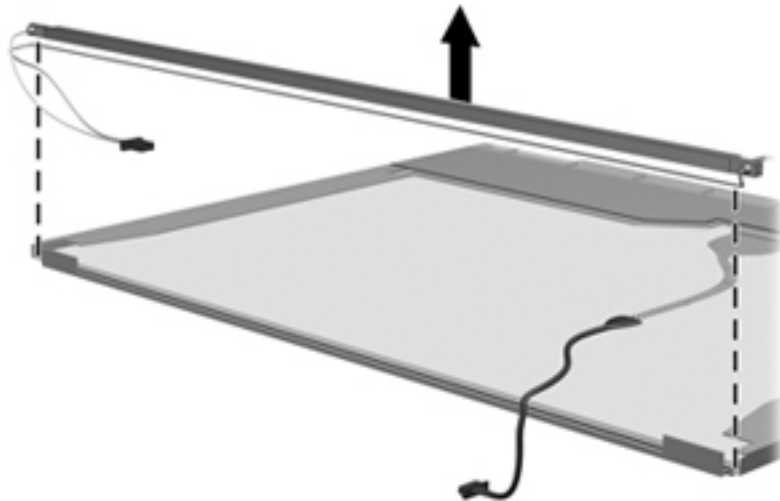

18. Remove the backlight from the backlight frame.

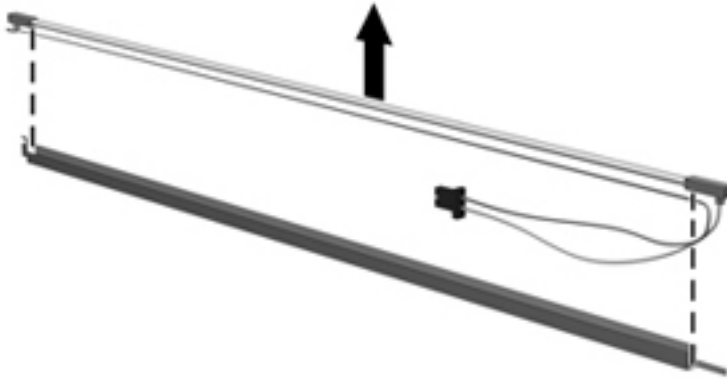

19. Disconnect the display panel cable (1) from the LCD panel.  
20. Remove the screws (2) that secure the LCD panel to the display rear panel.  
21. Release the LCD panel (3) from the display rear panel.  
22. Release the tape (4) that secures the LCD panel to the display rear panel.

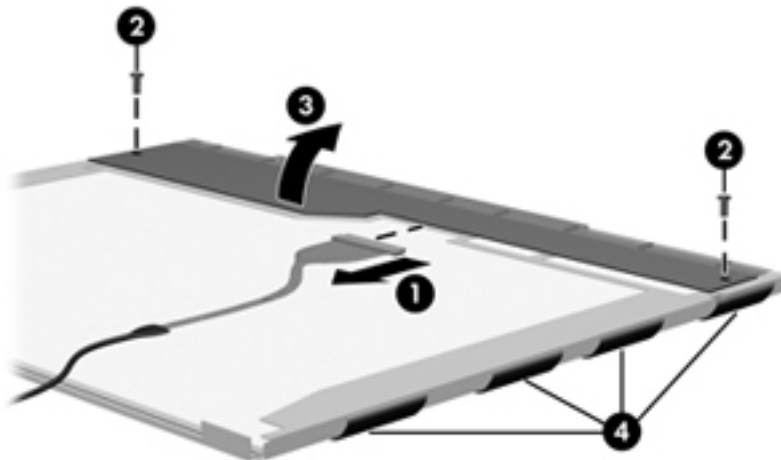

23. Remove the LCD panel.

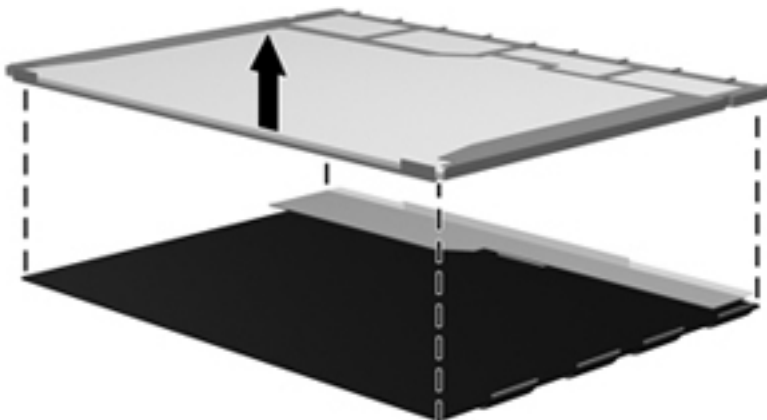

24. Recycle the LCD panel and backlight.



---

# Index

## A

- AC adapter, spare part numbers 29, 31
- advanced system diagnostics 86, 90
- antenna
  - removal 81, 82
  - spare part number 27, 33, 81, 82
- Antenna Kit, spare part number 27, 33
- audio, product description 2
- audio-in (microphone) jack, identifying 16
- audio-out (headphone) jack, identifying 16

## B

- Backup and Restore 101, 105
- base enclosure
  - removal 61
  - spare part number 24, 33, 61
- battery
  - identifying 19
  - removal 40
  - spare part numbers 25, 31, 40
- battery light 15
- battery release latch 19
- BIOS
  - determining version 85, 89, 93
  - downloading an update 85, 89, 93
  - updating 85, 89, 92
- Blu-ray R/RE DVD±RW SuperMulti DL Drive
  - precautions 36

- Blu-ray ROM DVD±RW SuperMulti DL Drive
  - precautions 36
- buttons
  - left pointing stick 9
  - left TouchPad 9
  - power 12
  - right pointing stick 9
  - right TouchPad 9
  - volume mute 12
  - wireless 12

## C

- cables, service considerations 35
- caps lock light, identifying 10
- chipset, product description 1
- components
  - bottom 18
  - display 8
  - front 15
  - left side 16
  - right side 17
  - top 9
- computer major components 22
- computer reset 112
- Computer Setup
  - navigating and selecting 83, 87, 91
  - restoring factory settings 84, 88, 92
- computer setup
  - navigating and selecting 91
  - restoring factory settings 92
- computer specifications 95
- connector, power 16
- connectors, service considerations 35

## D

- display
  - specifications 96
- display assembly
  - removal 76
  - subcomponents 26
- display assembly components
  - removal 42
  - spare part numbers 42
- display bezel
  - removal 42, 78
  - spare part numbers 27, 33, 42, 43, 78
- display component recycling 115
- display enclosure, spare part numbers 27, 33
- display hinge
  - removal 80
  - spare part number 27, 33
- display hinge cover
  - removal 80
- Display Hinge Kit, spare part number 27, 33
- display panel
  - product description 1
  - removal 44, 78
  - spare part number 42
  - spare part numbers 27, 33, 34, 44, 78
- Display Panel Support Kit, spare part numbers 27, 31
- DisplayPort, identifying 17
- docking connector, identifying 17
- drives, preventing damage 36
- DVD-ROM Drive
  - precautions 36
- DVD±RW Double-Layer with SuperMulti Drive
  - precautions 36

- E**
  - electrostatic discharge 36
  - embedded numeric keypad, identifying 13, 14
  - equipment guidelines 39
  - esc key, identifying 13
  - Ethernet, product description 2
  - external monitor port 17
- F**
  - f11 recovery 103, 106
  - fan
    - removal 66
    - spare part number 23, 33, 66
  - fingerprint reader board
    - removal 75
    - spare part number 24, 32, 75
  - fingerprint reader, identifying 12
  - flash cache, product description 2
  - fn key, identifying 13, 14
  - function keys, identifying 13, 14
- G**
  - graphics, product description 1
  - grounding guidelines 36
  - guidelines
    - equipment 39
    - grounding 36
    - packaging 38
    - transporting 38
    - workstation 38
- H**
  - Hard drive
    - spare part numbers 46
  - hard drive
    - precautions 36
    - product description 2
    - removal 46
    - spare part numbers 24, 28, 30, 33, 46
    - specifications 97
  - hard drive bracket
    - removal 47
  - hard drive cover
    - removal 45
    - spare part number 45
  - hard drive cover, illustrated 24
  - Hard Drive Hardware Kit
    - spare part number 24, 28, 33, 46
  - hard drive light 15
  - hard drive recovery 103, 106
  - hard drive, identifying 18
  - headphone (audio-out) jack 16
  - heat sink
    - removal 70
    - spare part numbers 24, 34, 70
- I**
  - integrated webcam light, identifying 8
  - internal display switch 9
  - internal microphones, identifying 8
- J**
  - jacks
    - audio-in (microphone) 16
    - audio-out (headphone) 16
    - network 17
    - RJ-45 (network) 17
- K**
  - keyboard
    - product description 4
    - removal 58
    - spare part numbers 23, 31, 32, 58
  - keypad
    - embedded numeric 13, 14
  - keys
    - esc 13
    - fn 13, 14
    - function 13, 14
    - Windows applications 13
    - Windows logo 13
- L**
  - latch, battery release 19
  - legacy support, USB 83, 87, 91
  - lights
    - battery 15
    - caps lock 10
    - hard drive 15
    - num lock 10
    - power 10, 15
    - TouchPad 10
  - webcam 8
  - wireless 10, 15
- M**
  - mass storage device
    - illustrated 28
    - precautions 36
    - spare part numbers 28
  - Media Card Reader, identifying 17
  - memory module
    - product description 1
    - removal 52
    - spare part numbers 30, 52
  - microphone
    - product description 2
  - microphone (audio-in) jack, identifying 16
  - microphone module
    - removal 43
    - spare part number 27, 33, 42, 43
  - model name 1
  - mouse, spare part numbers 29, 30
  - mSATA drive
    - removal 48
    - spare part numbers 33, 46, 48
    - specifications 99
  - mSATA module
    - product description 2
- N**
  - network jack, identifying 17
  - num lock light 10
- O**
  - operating system, product description 5
  - optical drive
    - precautions 36
- P**
  - packaging guidelines 38
  - PCID label 21
  - plastic parts, service considerations 35
  - Plastics Kit
    - spare part numbers 33
  - pointing device, product description 4

- pointing stick 9
- ports
  - DisplayPort 17
  - external monitor 17
  - product description 4
  - USB charging 16
- power button, identifying 12
- power connector
  - removal 64
  - spare part number 64
- power connector, identifying 16
- power connector, spare part number 64
- power cord
  - set requirements 113
  - spare part numbers 29, 30
- power lights 10, 15
- power requirements, product description 4
- processor
  - product description 1
- product description
  - audio 2
  - chipset 1
  - display panel 1
  - Ethernet 2
  - external media cards 3
  - flash cache 2
  - graphics 1
  - hard drive 2
  - keyboard 4
  - memory module 1
  - microphone 2
  - mSATA module 2
  - operating system 5
  - pointing device 4
  - ports 4
  - power requirements 4
  - processors 1
  - product name 1
  - security 4
  - serviceability 7
  - solid-state drive 2
  - video 2
  - wireless 3
- product name 1
- R**
- recovery partition 103, 106
- recycle
  - computer 112
- reinstall Windows 107
- removal/replacement
  - preliminaries 35
  - procedures 40
- remove everything and reinstall Windows 112
- reset
  - computer 112
  - steps 112
- restoring the hard drive 103, 106
- RJ-45 (network) jack, identifying 17
- RTC battery
  - removal 50
  - spare part number 24, 33, 50
- S**
- Screw Kit, spare part number 29, 32
- SD card insert, illustrated 24
- security cable slot, identifying 16
- security, product description 4
- service considerations
  - cables 35
  - connectors 35
  - plastic parts 35
- service cover
  - removal 51
  - spare part number 24, 34, 51
- service tag 20
- serviceability, product description 7
- setup utility
  - navigating and selecting 83, 87
  - restoring factory settings 84, 88
- SIM slot, identifying 19
- SIM, removal 41
- slots
  - security cable 16
  - SIM 19
  - smart card 16
- smart card board
  - removal 73
  - spare part number 73
- Smart Card reader
  - spare part number 23, 32
- smart card slot 16
- solid-state drive
  - precautions 36
  - product description 2
  - spare part numbers 24, 28, 33, 46
  - specifications 98
- speaker assembly
  - removal 72
  - spare part number 23, 33, 72
- speakers, identifying 18
- specifications
  - computer 95
  - display 96
  - hard drive 97
  - mSATA drive 99
  - solid-state drive 98
- system board
  - removal 67
  - spare part numbers 23, 67
- system repair disc 100
- system restore points 100
- T**
- tools required 35
- top cover, spare part numbers 23, 32, 33
- TouchPad
  - buttons 9
- touchpad
  - removal 63
- TouchPad light, identifying 10
- TouchPad zone
  - identifying 9
- transporting guidelines 38
- travel battery connector, identifying 18
- U**
- USB 3.0 port 16, 17
- USB legacy support 83, 87, 91
- USB ports, identifying 16, 17
- V**
- vents, identifying 16, 18
- video, product description 2
- volume mute button, identifying 12

## W

### webcam

- spare part number 42

webcam light, identifying 8

webcam, identifying 8

### webcam/microphone module

- removal 43

- spare part number 27, 33

### Windows

- reinstall 112

- remove everything and reinstall

  - option 112

- reset 112

### Windows 7 operating system

- DVD 103

### Windows 8 operating system

- DVD 106

### Windows applications key,

- identifying 13

### Windows Backup and Restore

- 100

### Windows logo key, identifying 13

### Windows Refresh, using 107

### wireless and memory module

- compartment

  - identifying 18

### wireless antenna

- removal 81, 82

- spare part number 27, 33, 81, 82

### Wireless Antenna Kit, spare part

- number 81, 82

### wireless antennas, identifying 8

### wireless button, identifying 12

### wireless light 10, 15

### wireless, product description 3

### WLAN antennas, identifying 8

### WLAN module

- removal 56

- spare part numbers 24, 30, 31, 56

### workstation guidelines 38

### WWAN antennas, identifying 8

### WWAN module

- removal 54

- spare part numbers 24, 30, 31, 54