

Panasonic®

OPERATING INSTRUCTIONS

Personal Computer

Model No. **CF-C1** series

Contents

Getting Started

Introduction	2
Read Me First	3
(Precautions)	
Description of Parts	10
First-time Operation	15

Getting Started

Useful Information

On-screen Manual	19
Handling and Maintenance	20
Reinstalling Software	24

Useful Information

Troubleshooting

Troubleshooting (Basic)	26
-------------------------------	----

Troubleshooting

Appendix

LIMITED USE LICENSE AGREEMENT	31
Specifications	33
LIMITED WARRANTY	36

Appendix





For further information about the computer, you can refer to the on-screen manual.

To access the on-screen manual
→ page 19 "On-screen Manual"

Introduction

Thank you for purchasing this Panasonic product. For optimum performance and safety, please read these instructions carefully.

■ Terms and illustrations in these instructions

CAUTION :	Conditions that may result in minor or moderate injury.
NOTE :	Useful and helpful information.
Enter :	Press [Enter] key.
Fn + F5 :	Press and hold [Fn] key, and then press [F5] key.
Windows 7	
 (Start) - [All Programs] :	Click  (Start), and then click [All Programs]. You may need to double-click in some cases.
Windows XP	
[start] - [Run] :	Click [start], and then click [Run]. You may need to double-click in some cases.
 :	Page in these Operating Instructions or in the Reference Manual.
 :	Reference to the on-screen manuals.

- **Windows 7** indicates Genuine Windows® 7 Professional Operating System.
- **Windows XP** indicates Genuine Microsoft® Windows® XP Tablet PC Edition Operating System.
- Some illustrations are simplified to help your understanding and may look different from the actual unit.
- If you do not log on as an administrator, you cannot use some functions or cannot display some screens.
- Refer for the latest information about optional products to the catalogs, etc.
- In these instructions, the names and terms are referred as follows.
 - “Genuine Windows® 7 Professional 32-bit Service Pack 1” and “Genuine Windows® 7 Professional 64-bit Service Pack 1” as “Windows” or “Windows 7”
 - “Genuine Microsoft® Windows® XP Tablet PC Edition Service Pack 3” as “Windows” or “Windows XP”
 - The computer screen supporting touching methods (using digitizer pen / stylus / your fingers) as the “screen”.
 - The Digitizer + Multi Touch Screen (Capacitive) as the “digitizer”, and the Multi Touch Screen (Resistive) as the “touchscreen”.
 - The digitizer pen and the stylus as the “pen (included)”.

■ Disclaimer

Computer specifications and manuals are subject to change without notice. Panasonic Corporation assumes no liability for damage incurred directly or indirectly from errors, omissions or discrepancies between the computer and the manuals.

■ Trademarks

Microsoft®, Windows®, the Windows logo, and IntelliMouse are registered trademarks of Microsoft Corporation of the United States and/or other countries.

Intel, Intel Core are either registered trademarks or trademarks of Intel Corporation.

SDXC Logo is a trademark of SD-3C, LLC.



Adobe, the Adobe logo and Adobe Reader are either registered trademarks or trademarks of Adobe Systems Incorporated in the United States and/or other countries.

Bluetooth™ is a trademark owned by Bluetooth SIG, Inc., U.S.A. and licensed to Panasonic Corporation.

Names of products, brands, etc., appearing in this manual are trademarks or registered trademarks of their respective own companies.

Read Me First

Important Safety Instructions / Importantes Mesures De Securite

<Only for model with modem>

When using your telephone equipment, basic safety precautions should always be followed to reduce the risk of fire, electric shock and injury to persons, including the following:

1. Do not use this product near water, for example, near a bath tub, wash bowl, kitchen sink or laundry tub, in a wet basement or near a swimming pool.
2. Avoid using a telephone (other than a cordless type) during an electrical storm. There may be a remote risk of electric shock from lightning.
3. Do not use the telephone to report a gas leak in the vicinity of the leak.
4. Use only the power cord and batteries indicated in this manual. Do not dispose of batteries in a fire. They may explode. Check with local codes for possible special disposal instructions.

SAVE THESE INSTRUCTIONS

19-E-1

Certaines mesures de sécurité doivent être prises pendant l'utilisation de matériel téléphonique afin de réduire les risques d'incendie, de choc électrique et de blessures. En voici quelquesunes:

1. Ne pas utiliser l'appareil près de l'eau, p.ex., près d'une baignoire, d'un lavabo, d'un évier de cuisine, d'un bac à laver, dans un sous-sol humide ou près d'une piscine.
2. Éviter d'utiliser le téléphone (sauf s'il s'agit d'un appareil sans fil) pendant un orage électrique. Ceci peut présenter un risque de choc électrique causé par la foudre.
3. Ne pas utiliser l'appareil téléphonique pour signaler une fuite de gaz s'il est situé près de la fuite.
4. Utiliser seulement le cordon d'alimentation et le type de piles indiqués dans ce manuel. Ne pas jeter les piles dans le feu: elles peuvent exploser. Se conformer aux règlements pertinents quant à l'élimination des piles.

CONSERVER CES INSTRUCTIONS

19-F-1

Information to the User

<Only for model with wireless LAN/Bluetooth>

This product and your Health

This product, like other radio devices, emits radio frequency electromagnetic energy. The level of energy emitted by this product however is far much less than the electromagnetic energy emitted by wireless devices like for example mobile phones. Because this product operates within the guidelines found in radio frequency safety standards and recommendations, we believe this product is safe for use by consumers.

These standards and recommendations reflect the consensus of the scientific community and result from deliberations of panels and committees of scientists who continually review and interpret the extensive research literature. In some situations or environments, the use of this product may be restricted by the proprietor of the building or responsible representatives of the organization. These situations may for example include:

- Using this product on board of airplanes, or
- In any other environment where the risk of interference to other devices or services is perceived or identified as harmful.

If you are uncertain of the policy that applies on the use of wireless devices in a specific organization or environment (e.g. airports), you are encouraged to ask for authorization to use this product prior to turning on the product.

Regulatory Information

We are not responsible for any radio or television interference caused by unauthorized modification of this product. The correction of interference caused by such unauthorized modification will be the responsibility of the user. We and its authorized resellers or distributors are not liable for damage or violation of government regulations that may arise from failing to comply with these guidelines.

26-M-1

<Uniquement les modèles avec réseau local sans fil et/ou Bluetooth>

Ce produit et votre santé

Ce produit, comme tout autre appareil radio, émet de l'énergie radioélectrique. Toutefois, la quantité d'énergie émise par ce produit est beaucoup moins importante que l'énergie radioélectrique émise par des appareils sans fil tels que les téléphones portables. L'utilisation de ce produit ne comporte aucun risque pour le consommateur du fait que cet appareil opère dans les limites des directives concernant les normes et les recommandations de sécurité sur les fréquences radio. Ces normes et recommandations reflètent le consensus de la communauté scientifique et résultent de délibérations de jurys et comités de scientifiques qui examinent et interprètent continuellement les nouveautés de la vaste littérature sur les recherches effectuées.

Dans certaines situations ou environnements, l'utilisation de ce produit peut être restreinte par le propriétaire du bâtiment ou par les représentants responsables de l'organisation.

Ces situations peuvent être les suivantes par exemple :

- A bord d'un avion, ou
- Dans tout autre environnement où les risques d'interférence sur d'autres appareils ou services sont perçus ou identifiables comme dangereux.

Si vous n'êtes pas sûr de la réglementation applicable à l'utilisation d'appareils sans fil dans une organisation ou un environnement spécifique, (par exemple dans un aéroport) nous vous invitons à demander l'autorisation d'utiliser ce produit avant sa mise en marche.

Informations concernant la réglementation

Nous déclinons toute responsabilité pour toute interférence radio ou télévision causée par des modifications non autorisées apportées à ce produit. La correction d'interférences causées par de telles modifications non autorisées sera la seule responsabilité de son utilisateur. Nous-mêmes, les revendeurs officiels et les distributeurs ne sommes pas responsables de tout dégât ou de toute violation des règlements de l'État pouvant découler du non-respect de ces directives.

26-F-1

Lithium Battery / Pile au lithium

Lithium Battery!

This computer contains a lithium battery to enable the date, time, and other data to be stored. The battery should only be exchanged by authorized service personnel.

Warning! A risk of explosion from incorrect installation or misapplication may possibly occur.

15-E-1

Pile au lithium!

Le micro-ordinateur renferme une pile au lithium qui permet de sauvegarder certaines données, notamment la date et l'heure.

La pile ne doit être remplacée que par un technicien qualifié. Danger ! Risque d'explosion en cas de non respect de cette mise en garde!

15-F-1

Read Me First

Information for Users on Collection and Disposal of Old Equipment and used Batteries



These symbols are only valid in the European Union. If you wish to discard this product, please contact your local authorities or dealer and ask for the correct method of disposal.

53-M-1

Safety Precautions

<Only for model with wireless WAN>

The following safety precautions must be observed during all phases of the operation, usage, service or repair of any Personal Computer or Handheld Computer incorporating wireless WAN modem. Manufacturers of the cellular terminal are advised to convey the following safety information to users and operating personnel and to incorporate these guidelines into all manuals supplied with the product. Failure to comply with these precautions violates safety standards of design, manufacture and intended use of the product. Panasonic assumes no liability for customer failure to comply with these precautions.



When in a hospital or other health care facility, observe the restrictions on the use of mobiles. Switch Personal Computer or Handheld Computer incorporating wireless WAN modem off, if instructed to do so by the guidelines posted in sensitive areas. Medical equipment may be sensitive to RF energy. The operation of cardiac pacemakers, other implanted medical equipment and hearing aids can be affected by interference from Personal Computer or Handheld Computer incorporating wireless WAN modem placed close to the device. If in doubt about potential danger, contact the physician or the manufacturer of the device to verify that the equipment is properly shielded. Pacemaker patients are advised to keep their Personal Computer or Handheld Computer incorporating wireless WAN modem away from the pacemaker, while it is on.



Switch off Personal Computer or Handheld Computer incorporating wireless WAN modem before boarding an aircraft. Make sure it cannot be switched on inadvertently. The operation of wireless appliances in an aircraft is forbidden to prevent interference with communications systems. Failure to observe these instructions may lead to the suspension or denial of cellular services to the offender, legal action, or both. For details on usage of this unit in aircrafts please consult and follow instruction provided by the airline.



Do not operate Personal Computer or Handheld Computer incorporating wireless WAN modem in the presence of flammable gases or fumes. Switch off the cellular terminal when you are near petrol stations, fuel depots, chemical plants or where blasting operations are in progress. Operation of any electrical equipment in potentially explosive atmospheres can constitute a safety hazard.



Your Personal Computer or Handheld Computer incorporating wireless WAN modem receives and transmits radio frequency energy while switched on.

Remember that interference can occur if it is used close to TV sets, radios, computers or inadequately shielded equipment. Follow any special regulations and always switch off Personal Computer or Handheld Computer incorporating wireless WAN modem wherever forbidden, or when you suspect that it may cause interference or danger.



Road safety comes first! Do not use a Personal Computer or Handheld Computer incorporating wireless WAN modem while driving a vehicle. Do not place the computer with wireless WAN modem in an area where it could cause personal injury to the driver or passengers. It is recommended to stow the unit in the boot or secure storage area while driving. Do not place the computer with wireless WAN modem in an area over an air bag or in the vicinity where an air bag may deploy. Air bags inflate with great force and if the computer with wireless WAN modem is placed in the air bag deployment area may be propelled with great force and cause serious injury to occupants of the vehicle.



IMPORTANT!

Personal Computer or Handheld Computer incorporating wireless WAN modem operate using radio signals and cellular networks cannot be guaranteed to connect in all conditions. Therefore, you should never rely solely upon any wireless device for essential communications, for example emergency calls. Remember, in order to make or receive calls, Personal Computer or Handheld Computer incorporating wireless WAN modem must be switched on and in a coverage area with adequate cellular signal strength.

Some networks do not allow for emergency calls if certain network services or phone features are in use (e.g. lock functions, fixed dialing etc.). You may need to deactivate those features before you can make an emergency call.

Some networks require that a valid SIM card be properly inserted in Personal Computer or Handheld Computer incorporating wireless WAN modem.

Models for U.S.A.

Federal Communications Commission Radio Frequency Interference Statement

Note: This equipment has been tested and found to comply with the limits for a Class B digital device, pursuant to Part 15 of the FCC Rules. These limits are designed to provide reasonable protection against harmful interference in a residential installation. This equipment generates, uses and can radiate radio frequency energy and, if not installed and used in accordance with the instructions, may cause harmful interference to radio communications. However, there is no guarantee that interference will not occur in a particular installation. If this equipment does cause harmful interference to radio or television reception, which can be determined by turning the equipment off and on, the user is encouraged to try to correct the interference by one or more of the following measures:

- Reorient or relocate the receiving antenna.
- Increase the separation between the equipment and receiver.
- Connect the equipment into an outlet on a circuit different from that to which the receiver is connected.
- Consult the Panasonic Service Center or an experienced radio/TV technician for help.

Warning

To assure continued compliance, use only shielded interface cables when connecting to a computer or peripheral. Also, any changes or modifications not expressly approved by the party responsible for compliance could void the user's authority to operate this equipment.

This device complies with Part 15 of the FCC Rules.

Operation is subject to the following two conditions:

- (1) This device may not cause harmful interference, and
- (2) This device must accept any interference received, including interference that may cause undesired operation.

FCC RF Exposure Warning:

- This equipment is provided with PC Card slot that could be used with wireless transmitters, which will be specifically recommended when they become available. Other third-party wireless transmitters have not been RF exposure evaluated for use with this computer and may not comply with FCC RF exposure requirements.
- <Only for model with wireless LAN/wireless WAN/Bluetooth>
- This equipment complies with FCC radiation exposure limits set forth for an uncontrolled environment.
 - This equipment has been approved for portable operation, and does not require any minimum spacing be provided between antennas and all person's body.

25-M-8

<Only for model with wireless LAN>

This product is restricted to indoor use due to its operation in the 5.15 to 5.25 GHz frequency range.

FCC requires this product to be used indoors for the frequency range 5.15 to 5.25 GHz to reduce the potential for harmful interference to co-channel Mobile Satellite systems. High power radars are allocated as primary users of the 5.25 to 5.35 GHz and 5.65 to 5.85 GHz bands. These radar stations can cause interference with and/or damage this product.

25-M-W-8

Responsible Party:

Panasonic Corporation of North America
One Panasonic Way
Secaucus, NJ 07094
Tel No:1-800-LAPTOP5 (1-800-527-8675)

6-M-1

<Only for model with modem>

FCC Regulation Notice for modem

This equipment contains a FCC approved modem.

FC Tested To Comply
With FCC Standards
FOR HOME OR OFFICE USE

1. This equipment complies with CFR47 Part 68 rules. On the computer is a label that contains, among other information, the FCC registration number and ringer equivalence number (REN) for this equipment. If required, this information must be provided to the telephone company.
2. An FCC compliant telephone cord and modular plug is provided with this equipment. This equipment is designed to be connected to the telephone network or premises wiring using a compatible modular jack which is Part 68 compliant. See Installation Instructions for details.

3. The REN is used to determine the quantity of devices which may be connected to the telephone line. Excessive RENs on the telephone line may result in the devices not ringing in response to an incoming call. In most, but not all area, the sum of RENs should not exceed five (5.0). To be certain of the number of devices that may be connected to a line, as determined by the total RENs, contact the local telephone company.
4. If your telephone equipment cause harm to the telephone network, the telephone company will notify you in advice that temporary discontinuance of service may be required. But if advice notice isn't practical, the telephone company will notify the customer as soon as possible. Also, you will be advised of your right to file a complaint with the FCC if you believe it is necessary.
5. The telephone company may take changes in its facilities, equipment, operations or procedures that could affect the operation of the equipment. If this happens the telephone company will provide advance notice in order for you to make necessary modifications to maintain uninterrupted service.
6. If trouble is experienced with this equipment, for repair or warranty information, please contact Panasonic Corporation of North America at DIAL TOLL FREE 1-800-LAPTOP5 (1-800-527-8675). If the equipment is causing harm to the telephone network, the telephone company may request that you disconnect the equipment until the problem is resolved.
7. There are no user serviceable parts contained in this equipment.
8. This equipment may not be used on coin service provided by the telephone company. Connection to party lines is subject to state tariffs.
9. The Telephone Consumer Protection Act of 1991 makes it unlawful for any person to use a computer or other electronic device to send any message via a telephone fax machine unless such message clearly contains in a margin at the top or bottom of each transmitted page or on the first page of the transmission, the date and time it is sent and an identification of the business or other entry, or other individual sending the message and the telephone number of the sending machine or such business, other entity, or individual. In order to program this information into your fax software, you should refer to the manual of the Fax software being used.
10. According to the FCC's electrical safety advisory, we recommend that you may install an AC surge arrestor in the AC outlet to which this equipment is connected. Telephone companies report that electrical surges, typically lightning transients, are very destructive to customer terminal equipment connected to AC power sources and that this is a major nationwide problem.

"Caution : To reduce the risk of fire, use only No.26 AWG or larger (e.g., 24 AWG) UL listed or CSA certified telecommunication line cord."

"ATTENTION : Pour réduire le risque d'incendie, utiliser uniquement des conducteurs de télécommunications 26 AWG ou de section supérieure (p. ex. 24 AWG) UL énumérés ou CSA certifié."

16-M-1

USA Only: Disposal may be regulated in your community due to environmental considerations. For disposal or recycling information, please visit Panasonic website: <http://www.panasonic.com/environmental> or call 1-888-769-0149

65-M-2

For U.S.A.-California Only

This product contains a CR Coin Cell Lithium Battery which contains Perchlorate Material – special handling may apply.
See www.dtsc.ca.gov/hazardouswaste/perchlorate/

38-M-1

Models for Canada

<Only for model with modem>

Industry Canada (IC) Notice for modem

This equipment contains an Industry Canada approved modem unit.

The Industry Canada label is affixed on the modem unit.

EQUIPMENT ATTACHEMENT LIMITATIONS

“NOTICE: The Industry Canada label identifies certified equipment. This certification means that the equipment meets telecommunications network protective, operational and safety requirements as prescribed in the appropriate Terminal Equipment Technical Requirements document(s).

The Department does not guarantee the equipment will operate to the user's satisfaction.

Before installing this equipment, users should ensure that it is permissible to be connected to the facilities of the local telecommunications company. The equipment must also be installed using an acceptable method of connection.

The customer should be aware that compliance with the above conditions may not prevent degradation of service in some situations.

Repairs to certified equipment should be coordinated by a representative designated by the supplier. Any repairs or alterations made by the user to this equipment, or equipment malfunctions, may give the telecommunications company cause to request the user to disconnect the equipment.

Users should ensure for their own protection that the electrical ground connections of the power utility, telephone lines and internal metallic water pipe system, if present, are connected together. This precaution may be particularly important in rural areas. Caution: Users should not attempt to make such connections themselves, but should contact the appropriate electric inspection authority, or electrician, as appropriate.”

“NOTICE: The Ringer Equivalence Number (REN) assigned to each terminal device provides an indication of the maximum number of terminals allowed to be connected to a telephone interface.

The termination on an interface may consist of any combination of devices subject only to the requirement that the sum of the Ringer Equivalence Numbers of all the devices does not exceed 5.”

REN: See bottom of the computer

RESTRICTIONS CONCERNANT LE RACCORDEMENT DE MATÉRIEL

“AVIS: L'étiquette d'Industrie Canada identifie le matériel homologué. Cette étiquette certifie que le matériel est conforme aux normes de protection, d'exploitation et de sécurité des réseaux de télécommunications, comme le prescrivent les documents concernant les exigences techniques relatives au matériel terminal. Le Ministère n'assure toutefois pas que le matériel fonctionnera à la satisfaction de l'utilisateur.

Avant d'installer ce matériel, l'utilisateur doit s'assurer qu'il est permis de le raccorder aux installations de l'entreprise locale de télécommunication. Le matériel doit également être installé en suivant une méthode acceptée de raccordement. L'abonné ne doit pas oublier qu'il est possible que la conformité aux conditions énoncées ci-dessus n'empêche pas la dégradation du service dans certaines situations.

Les réparations de matériel homologué doivent être coordonnées par un représentant désigné par le fournisseur.

L'entreprise de télécommunications peut demander à l'utilisateur de débrancher un appareil à la suite de réparations ou de modifications effectuées par l'utilisateur ou à cause de mauvais fonctionnement.

Pour sa propre protection, l'utilisateur doit s'assurer que tous les fils de mise à la terre de la source d'énergie électrique, des lignes téléphoniques et des canalisations d'eau métalliques, s'il y en a, sont raccordés ensemble.

Cette précaution est particulièrement importante dans les régions rurales. Avertissement: L'utilisateur ne doit pas tenter de faire ces raccordements lui-même; il doit avoir recours à un service d'inspection des installations électriques, ou à un électricien, selon le cas.”

“AVIS: L'indice d'équivalence de la sonnerie (IES) assigné à chaque dispositif terminal indique le nombre maximal de terminaux qui peuvent être raccordés à une interface. La terminaison d'une interface téléphonique peut consister en une combinaison de quelques dispositifs, à la seule condition que la somme d'indices d'équivalence de la sonnerie de tous les dispositifs n'excède pas 5.”

IES: Voir sous le fond de l'ordinateur

17-Ca-1

Canadian ICES-003

This Class B digital apparatus complies with Canadian ICES-003.

Cet appareil numérique de la classe B est conforme à la norme NMB-003 du Canada.

7-M-2

<Only for model with wireless LAN/Bluetooth>

Industry Canada

This product complies with RSS-210 Industry Canada.

Operation is subject to the following two conditions;

- (1) this device may not cause interference, and
- (2) this device must accept any interference, including interference that may cause undesired operation of the device.

<Ne s'applique qu'aux modèles avec technologie Bluetooth/LAN sans fil>

Industrie Canada

Cet équipement est conforme à la norme CNR-210 d'Industrie Canada. Son fonctionnement est soumis aux deux conditions suivantes :

- (1) ce dispositif ne peut produire de brouillage, et
- (2) ce dispositif doit accepter le brouillage, y compris le brouillage pouvant entraîner le fonctionnement non désiré de l'appareil.

30-Ca-1-1

<Only for model with wireless LAN>

This product (local network devices) for the band 5150-5250 MHz is only indoor usage to reduce potential for harmful interference to co-channel Mobile Satellite systems.

High power radars are allocated as primary users (meaning they have priority) of 5250-5350 MHz and 5650-5850 MHz and these radars could cause interference and/or damage to LELAN devices.

<Ne s'applique qu'aux modèles avec technologie LAN sans fil>
Cet appareil (pour réseaux locaux radioélectriques) dans les bandes de fréquences 5150-5250 MHz est réservé à une utilisation à l'intérieur afin de réduire le risque d'interférence avec les systèmes satellites mobiles bicanaux.

Les radars forte puissance sont désignés comme étant les premiers utilisateurs (c'est-à-dire qu'ils ont la priorité) des bandes de fréquences 5250-5350 MHz et 5650-5850 MHz. Ces stations radars peuvent provoquer des interférences et/ou des dommages à ce périphérique.

30-Ca-2-1

<Only for model with wireless LAN/wireless WAN/Bluetooth>

- This computer complies with Industry Canada radiation exposure limits set forth for an uncontrolled environment.
- This PC with WLAN and/or Bluetooth transmitters installed, has been approved for portable operation and does not require any minimum spacing be provided between antennas and all person's body.

<Ne s'applique qu'aux modèles avec technologie Bluetooth/LAN sans fil/WAN sans fil>

- Cet équipement est conforme aux limites d'exposition aux rayonnements d'Industrie Canada établies pour un environnement non contrôlé.
- Ce PC avec émetteurs WLAN et/ou Bluetooth a été approuvé à des fins d'opération mobile; aucun espace minimum entre les antennes et le corps de l'utilisateur n'est requis.

FOR USE WITH MODEL NO. : CF-AA6503A
POUR UTILISER AVEC MODÈLE : CF-AA6503A

20-Ca-1

Models for Europe

<Only for model with a "CE" mark on the bottom of the computer>



Declaration of Conformity (DoC)

"Hereby, Panasonic declares that this Personal Computer is in compliance with the essential requirements and other relevant provisions of the Directive 1999/5/EC."

Hint:

If you want to get a copy of the original DoC of our above mentioned products, please contact our web address:

<http://www.doc.panasonic.de>

Authorised Representative:

Panasonic Testing Centre

Panasonic Marketing Europe GmbH

Winsbergring 15, 22525 Hamburg, Germany

Network connection of Wired Modem.

The terminal equipment is intended for connection to the following public network;

In all the countries of European Economical Area and Turkey;

- Public Switched Telephony Networks

Technical Features of Wired Modem.

The terminal equipment includes the following features;

- DTMF dialing

- Maximum bitrate receiving mode: 56 kbit/s

- Maximum bitrate sending mode: 33.6 kbit/s

18-E-1

Precautions

THIS PRODUCT IS NOT INTENDED FOR USE AS, OR AS PART OF, NUCLEAR EQUIPMENT/SYSTEMS, AIR TRAFFIC CONTROL EQUIPMENT/SYSTEMS, AIRCRAFT COCKPIT EQUIPMENT/SYSTEMS^{*1}, MEDICAL DEVICES OR ACCESSORIES^{*2}, LIFE SUPPORT SYSTEMS OR OTHER EQUIPMENTS/DEVICES/SYSTEMS THAT ARE INVOLVED WITH ENSURING HUMAN LIFE OR SAFETY.

PANASONIC WILL NOT BE RESPONSIBLE FOR ANY LIABILITY RESULTING FROM THE USE OF THIS PRODUCT ARISING OUT OF THE FOREGOING USES.

^{*1} AIRCRAFT COCKPIT EQUIPMENT/SYSTEMS include Class2 Electrical Flight Bag (EFB) Systems and Class1 EFB Systems when used during critical phases of flight (e.g., during take-off and landing) and/or mounted on to the aircraft. Class1 EFB Systems and 2 EFB Systems are defined by FAA: AC (Advisory Circular) 120-76A or JAA: JAA TGL (Temporary Guidance Leaflets) No.36.

^{*2} As defined by the European Medical Device Directive (MDD) 93/42/EEC.

Panasonic cannot guarantee any specifications, technologies, reliability, safety (e.g. Flammability/Smoke/Toxicity/Radio Frequency Emission, etc) requirements related to aviation standards and medical equipment standards that differ from the specifications of our COTS (Commercial-Off-The-Shelf) products.

If a Malfunction or Trouble Occurs, Immediately Stop Use

If a Malfunction Occurs, Immediately Unplug the AC Plug and the Battery Pack

- This product is damaged
- Foreign object inside this product
- Smoke emitted
- Unusual smell emitted
- Unusually hot

Continuing to use this product while any of the above conditions are present may result in fire or electric shock.

- If a malfunction or trouble occurs, immediately turn the power off and unplug the AC plug, and then remove the battery pack.

Then contact your technical support office for repair.

Do Not Touch This Product and Cable When It Starts Thundering

Electric shock may result.

Do Not Connect the AC Adaptor to a Power Source Other Than a Standard Household AC Outlet

Otherwise, a fire due to overheating may result. Connecting to a DC/AC converter (inverter) may damage the AC adaptor.

On an airplane, only connect the AC adaptor/charger to an AC outlet specifically approved for such use.

Do Not Do Anything That May Damage the AC Cord, the AC Plug, or the AC Adaptor

Do not damage or modify the cord, place it near hot tools, bend, twist, or pull it forcefully, place heavy objects on it, or bundle it tightly.

Continuing to use a damaged cord may result in fire, short circuit, or electric shock.

- For details on handling the cord of the AC adaptor, see "Handling Cautions" (→page 20).

Do Not Pull or Insert the AC Plug If Your Hands Are Wet

Electric shock may result.

Read Me First

Clean Dust and Other Debris of the AC Plug Regularly

If dust or other debris accumulates on the plug, humidity, etc. may cause a defect in the insulation, which may result in a fire.

- Pull the plug, and wipe it with a dry cloth.
Pull the plug if the computer is not being used for a long period of time.

Insert the AC Plug Completely

If the plug is not inserted completely, fire due to overheating or electric shock may result.

- Do not use a damaged plug or loose AC outlet.

Do Not Place Containers of Liquid or Metal Objects on Top of This Product

If water or other liquid spills, or if paper clips, coins, or foreign matter get inside this product, fire or electric shock may result.

- If water spills in the keyboard, refer to page 23. If other foreign matter has found its way inside, immediately turn the power off and unplug the AC plug and remove the battery pack. Then contact your technical support office.

Do Not Disassemble This Product

The high-voltage areas inside may give you an electric shock, or foreign matter may enter and result in a fire.

Keep SD Memory Cards Away from Infants and Small Children

Accidental swallowing will result in bodily injury.

- In the event of accidental swallowing, see a doctor immediately.

Do Not Place This Product on Unstable Surfaces

If balance is lost, this product may fall over or drop, resulting in an injury.

Avoid Stacking

If balance is lost, this product may fall over or drop, resulting in an injury.

Do Not Keep This Product Wherever There is a Lot of Water, Moisture, Steam, Dust, Oily Vapors, etc.

Otherwise, possibly resulting in a fire.

Do Not Leave This Product in High Temperature Environment for a Long Period of Time

Leaving this product where it will be exposed to extremely high temperatures such as near fire or in direct sunlight may deform the cabinet and/or cause trouble in the internal parts. Continued use in such a resulting condition may lead to short-circuiting or insulation defects, etc. which may in turn lead to a fire or electric shocks.

Do Not Block the Ventilation Hole (Exhaust)

Using this product wrapped in cloth or on top of bedding or a blanket can block the ventilation hole and cause heat to build up inside, possibly resulting in a fire.

Hold the Plug When Unplugging the AC Plug

Pulling on the cord may damage the cord, resulting in a fire or electric shock.

Do Not Move This Product While the AC Plug Is Connected

The AC cord may be damaged, resulting in fire or electric shock.

- If the AC cord is damaged, unplug the AC plug immediately.

Use Only the Specified AC Adaptor With This Product

Using an AC adaptor other than the one supplied (supplied with the unit or one sold separately as an accessory) may result in a fire.

Do Not Subject the AC Adaptor to Any Strong Impact

Using the AC adaptor after a strong impact such as being dropped may result in electric shock, short circuit, or fire.

Take a Break of 10-15 Minutes Every Hour

Using this product for long periods of time may have detrimental health effects on the eyes or hands.

Do Not Turn the Volume Up to Loud When Using Headphones

Listening at high volumes that overstimulate the ear for long periods of time may result in loss of hearing.

Do Not Connect a Telephone Line, or a Network Cable Other Than the One Specified, into the LAN Port

If the LAN port is connected to a network such as the ones listed below, a fire or electric shock may result.

- Networks other than 1000BASE-T, 100BASE-TX or 10BASE-T
- Phone lines (IP phone (Internet Protocol Telephone), Telephone lines, internal phone lines (on-premise switches), digital public phones, etc.)

Do Not Use With Exposing the Skin to This Product For a Long Period of Time

Using this product with exposing the skin to the heat source of this product or AC adaptor for a long period of time can cause a low-temperature burn.

Do Not Expose Yourself to the Hot Wind from the Ventilation Hole (Exhaust) for a Long Period of Time.

Low-temperature burns may result.

Covering the ventilation hole (exhaust) with your hand or other object can cause heat to build up inside, possibly resulting in burns.

<Only for model with modem>

Use the Modem With a Regular Telephone Line

Connection to an internal phone line (on-premise switches) of a company or business office, etc. or to a digital public phone or use in a country or area not supported by the computer may result in a fire or electric shocks.

- Do not place the computer near a television or radio receiver.
- Keep the computer away from magnets. Data stored on the hard disk may be lost.
- This computer is not intended for the display of images for use in medical diagnosis.
- This computer is not intended for a use with connection of medical equipment for the purpose of medical diagnosis.
- Panasonic shall not be liable for loss of data or other incidental or consequential damages resulting from the use of this product.

Precautions (Battery Pack)

Do Not Use With Any Other Product

The battery pack is rechargeable and was intended for the specified product. If it is used with a product other than the one for which it was designed, electrolyte leakage, generation of heat, ignition or rupture may result.

Do Not Charge the Battery Using Methods Other Than Those Specified

If the battery is not charged using one of the specified methods, electrolyte leakage, generation of heat, ignition or rupture may result.

Do Not Throw the Battery Pack into a Fire or Expose It to Excessive Heat

Generation of heat, ignition or rupture may result.

Avoid Extreme Heat (Near the Fire, in Direct Sunlight, for Example)

Electrolyte leakage, generation of heat, ignition or rupture may result.

Do Not Insert Sharp Objects into the Battery Pack, Expose It to Bumps or Shocks, Disassemble, or Modify It

Electrolyte leakage, generation of heat, ignition or rupture may result.

- If this product is subjected to a strong impact, stop using it immediately.

Do Not Short the Positive (+) and Negative (-) Contacts

Generation of heat, ignition or rupture may result.

- Do not place the battery pack together with articles such as necklaces or hairpins when carrying or storing.

Do Not Use This Product With a Battery Pack Other Than the One Specified

Use only the specified battery pack (CF-VZSU66U) with your product. Use of battery packs other than those manufactured and supplied by Panasonic may present a safety hazard (generation of heat, ignition or rupture).

When the Battery Pack Has Deteriorated, Replace It with a New One

Continued use of a damaged battery pack may result in heat generation, ignition or battery rupture.

CAUTION:

Risk of Explosion if Battery is replaced by an Incorrect Type. Dispose of Used Batteries According to the Instructions.

58-E-1

ATTENTION:

Il y a un risque d'explosion si la batterie est remplacée par une batterie de type incorrect.

Mettre au rebut les batteries usagées conformément aux instructions.

58-F-1

- Do not touch the terminals on the battery pack. The battery pack may no longer function properly if the contacts are dirty or damaged.
- Do not expose the battery pack to water, or allow it to become wet.
- If the battery pack will not be used for a long period of time (a month or more), charge or discharge (use) the battery pack until the remaining battery level becomes 30% to 40% and store it in a cool, dry place.
- This computer prevents overcharging of the battery by recharging only when the remaining power is less than approx. 95% (when Economy Mode (ECO) is enabled: 75%) of capacity.
- The battery pack is not charged when the computer is first purchased. Be sure to charge it before using it for the first time. When the AC adaptor is connected to the computer, charging begins automatically.
- Should the battery leak and the fluid get into your eyes, do not rub your eyes. Immediately flush your eyes with clear water and see a doctor for medical treatment as soon as possible.

NOTE

- The battery pack may become warm during recharging or normal use. This is completely normal.
- Recharging will not commence if internal temperature of the battery pack is outside of the allowable temperature range (0 °C to 55 °C {32°F to 131 °F}) (→  *Reference Manual* "Battery Power"). Once the allowable range requirement is satisfied, charging begins automatically. Note that the recharging time varies based on the usage conditions. (Recharging takes longer than usual when the temperature is 10 °C {50 °F} or below.)
- In high-temperature environments, the battery takes longer to fully recharge. In low-temperature environments, the battery takes longer to fully recharge and the operating time is shorter. Only use the computer within the allowable temperature range.
- The battery pack is a consumable item. If the amount of time the computer can be run by using a particular battery pack becomes dramatically shorter and repeated recharging does not restore its performance, the battery pack should be replaced with a new one.
- When transporting a spare battery inside a package, briefcase, etc., it is recommended that it be placed in a plastic bag so that its contacts are protected.
- Always power off the computer when it is not in use. Leaving the computer on when the AC adaptor is not connected will exhaust the remaining battery capacity.



A lithium ion battery that is recyclable powers the product you have purchased. Please call 1-800-8-BATTERY for information on how to recycle this battery.

L'appareil que vous vous êtes procuré est alimenté par une batterie au lithium-ion. Pour des renseignements sur le recyclage de la batterie, veuillez composer le 1-800-8-BATTERY.

48-M-1

Description of Parts

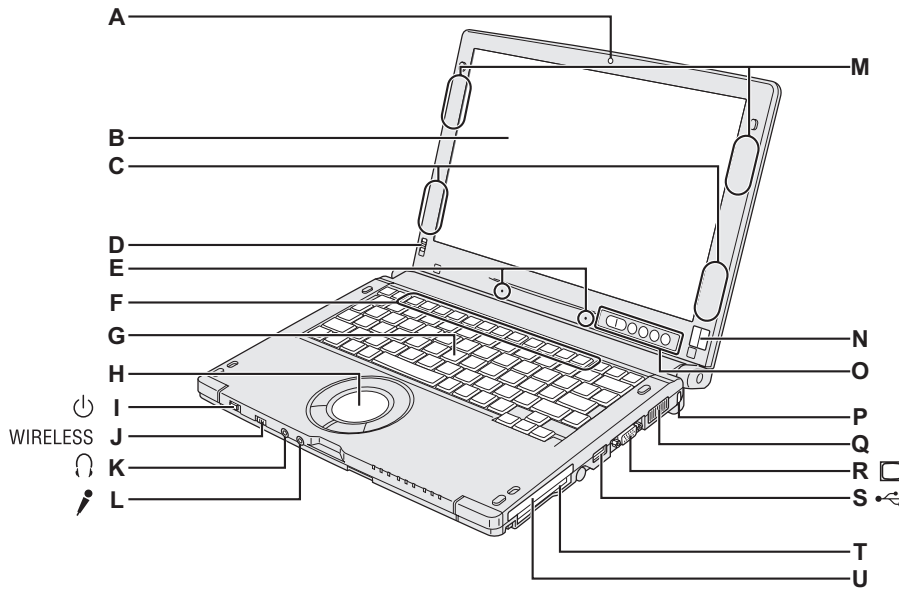

A: Camera

<Only for model with Camera>
 → Reference Manual "Camera"

B: LCD

→ Reference Manual "Screen Input Operation"

C: Wireless LAN Antenna

<Only for model with wireless LAN>
 → Reference Manual "Wireless LAN"

D: Display Rotation Lock

→ page 12 "Rotating the Display"

E: Microphone Arrays

F: Function Key

→ Reference Manual "Key Combinations"

G: Keyboard

H: Touch Pad

→ Reference Manual "Using the Touch Pad"

I: Power Switch

→ page 16

Power Indicator

- Off: Power off/Hibernation
- Green: Power on
- Blinking green: **Windows 7** Sleep
Windows XP Standby

J: Wireless Switch

→ Reference Manual "Disabling / Enabling Wireless Communication"

K: Headphone Jack

You can connect headphones or amplified speakers. When they are connected, audio from the internal speakers is not heard.

L: Microphone Jack

A condenser microphone can be used. If other types of microphones are used, audio input may not be possible, or malfunctions may occur.

- When using a monaural microphone with a 2-terminal plug:

Windows 7

- ① Click (Start) - [Control Panel] - [Hardware and Sound] - [Sound] - [Recording] - [Microphone] - [Properties], and then add a check mark for [Mono Microphone] in [Enhancements].

Windows XP

- ① Click [Start] - [Control Panel] - [Sound, Speech, and Audio Device] - [Sounds and Audio Devices] - [Audio], and click [Volume] in "Sound recording".
- ② Click [Options] and add a check mark for [Advanced Control].
- ③ Click [Advanced] in "Mic Volume" and add a check mark for [2 Mono Mic], then click [Close].

When recording in stereo using a stereo microphone:

Windows 7

- ① Click (Start) - [Control Panel] - [Hardware and Sound] - [Sound] - [Recording] - [Microphone] - [Properties], and then remove a check mark for [Mono Microphone] in [Enhancements].

Windows XP

- ① Click [Start] - [Control Panel] - [Sound, Speech, and Audio Device] - [Sounds and Audio Devices] - [Audio], and click [Volume] in "Sound recording".
- ② Click [Options] and add a check mark for [Advanced Control].

M: Wireless WAN Antenna

<Only for model with wireless WAN>
 → Reference Manual "Wireless WAN"

N: Fingerprint Reader

<Only for model with Fingerprint Reader>
 → Reference Manual "Fingerprint Reader"

O: Tablet Buttons

→ Reference Manual "Tablet Buttons"

P: Security Lock

You can connect a Kensington cable. Refer to the instruction manual of the cable. The security lock and cable is a theft prevention device. Panasonic Corporation will bear no responsibility in the event of theft.

Q: Speaker

R: External Display Port (VGA)

→ Reference Manual "External Display"

S: USB2.0 Port

→ Reference Manual "USB Devices"

T: PC Card Slot

→ Reference Manual "PC Card"

U: Smart Card Slot

<Only for model with Smart Card slot>
 → Reference Manual "Smart Card"

Bottom

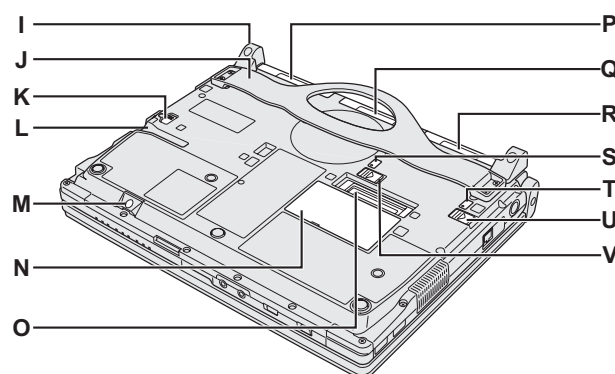
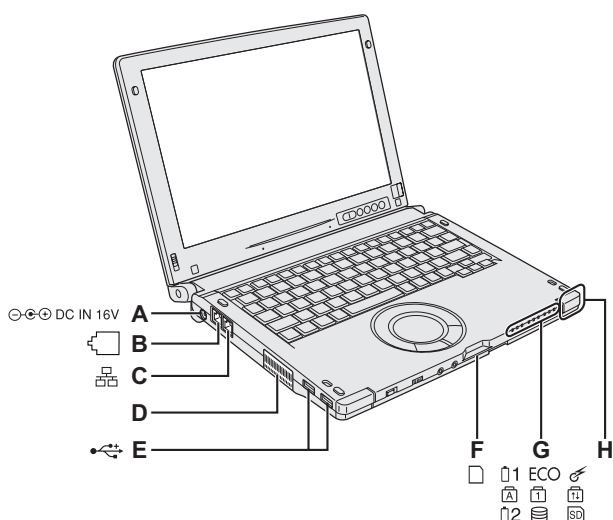

A: DC-IN Jack

B: Modem Port

<Only for model with modem>

→ [Reference Manual "Modem"](#)

C: LAN Port

→ [Reference Manual "LAN"](#)

D: Ventilation Hole (Exhaust)

E: USB2.0 Ports

→ [Reference Manual "USB Devices"](#)

F: SD Memory Card Slot

→ [Reference Manual "SD Memory Card"](#)

G: LED Indicator

☐1 : Battery Status 1

→ [Reference Manual "Battery Power"](#)

ECO : Economy Mode (ECO) Status

→ [Reference Manual "Battery Power"](#)

☑ : Wireless Switch Status

- On: wireless communication is enabled
- Off: wireless communication is disabled
- Blinking: in transition

Ⓐ : Caps Lock

Ⓛ : Numeric Key (NumLk)

Ⓜ : Scroll Lock (ScrLk)

☐2 : Battery Status 2

→ [Reference Manual "Battery Power"](#)

Ⓢ : Hard disk drive status

Ⓜ : SD Memory Card Status

H: Bluetooth Antenna

<Only for model with Bluetooth>

→ [Reference Manual "Bluetooth"](#)

I: Tether Hook

→ page 14

J: Hand Strap

→ page 14 "Using the Hand Strap"

K: Hard Disk Drive Latch

→ [Reference Manual "Hard Disk Drive"](#)

L: Pen Holder

The pen (included) is already attached to the computer at purchase.

M: SIM Card Slot

<Only for model with wireless WAN>

→ [Reference Manual "Wireless WAN"](#)

N: RAM Module Slot

→ [Reference Manual "Expanding Memory"](#)

O: Port Replicator Connector

<Only for model with Port Replicator Connector>

→ [Reference Manual "Port Replicator"](#)

P: Hard Disk Drive

→ [Reference Manual "Hard Disk Drive"](#)

Q: Battery Bay Weight Saver

R: Battery Pack

→ page 15

→ [Reference Manual "Battery Power"](#)

S: Battery 2 Indicator

T: Battery 1 Indicator

→ [Reference Manual "Battery Power"](#)

U: Battery 1 Latch

V: Battery 2 Latch

→ [Reference Manual "Battery Power"](#)

Description of Parts

Rotating the Display

■ Switching to the Tablet Mode

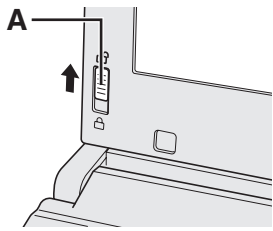

- ① Open the display.
Lift up the display until it stops (approx. 90 degrees).
- ② Slide the Display Rotation Lock (A) to the unlocked position.

NOTE

- Do not press the tablet buttons, and do not rotate the display by holding the upper part of the display.
 - Do not allow your fingers to get caught between the display and the base when rotating the display.
- ③ Hold the bottom left and bottom right of the display, and rotate the display in the direction of the arrow.
The lock will click as it is released.

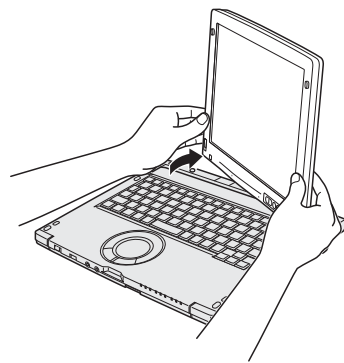

- ④ Rotate the display 180 degrees in the direction of the arrow while holding both sides.
Stop rotation when the display clicks into place.

NOTE

- The display cannot be rotated more than 180 degrees in the direction of the arrow, or in the opposite direction of the arrow. Do not attempt to rotate the display more than 180 degrees or in the opposite direction using force.
- Do not allow the tether for the pen (included) or other cables to get caught between the display and the base when rotating the display.
- If peripheral devices connected to the computer obstruct rotation of the display, disconnect the devices and then rotate the display.

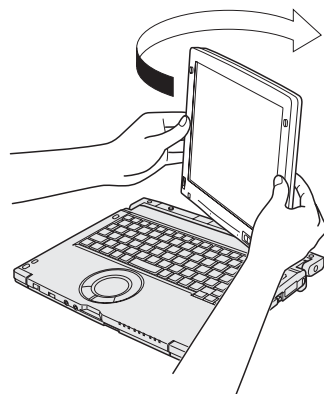

- ⑤ Tilt down the display in the direction of the arrow.

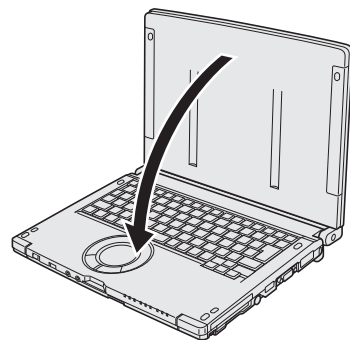

NOTE

- For the normal operation of the Tablet Mode, orient the display as shown in the illustration at the left.

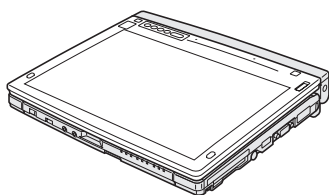

■ Switching to the Laptop Mode

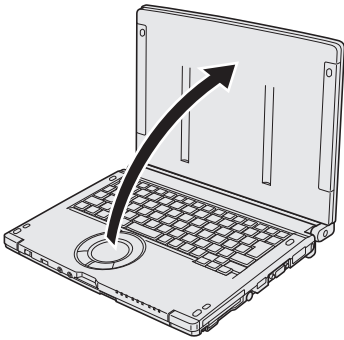

- ① Open the display.
Lift up the display until it stops (approx. 90 degrees).

NOTE

- Do not press the tablet buttons, and do not rotate the display by holding the upper part of the display.
- Do not allow your fingers to get caught between the display and the base when rotating the display.

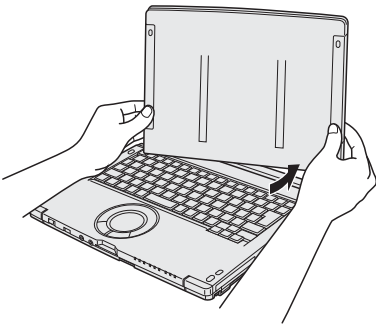

- ② Hold the bottom left and bottom right of the display, and rotate the display in the direction of the arrow.
The lock will click as it is released.

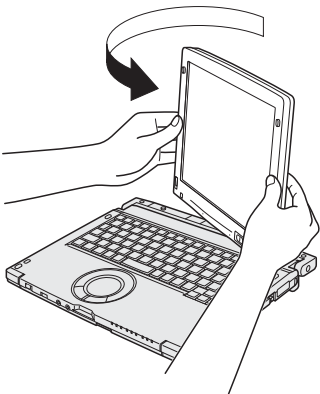

- ③ Rotate the display 180 degrees in the direction of the arrow while holding both sides.
Stop rotation when the display clicks into place.

NOTE

- The display cannot be rotated more than 180 degrees in the direction of the arrow, or in the opposite direction of the arrow. Do not attempt to rotate the display more than 180 degrees or in the opposite direction using force.
- Do not allow the tether for the pen (included) or other cables to get caught between the display and the base when rotating the display.
- If peripheral devices connected to the computer obstruct rotation of the display, disconnect the devices and then rotate the display.

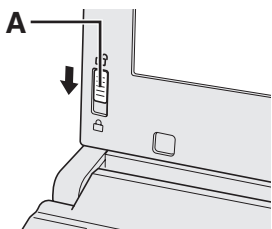

- ④ Slide the Display Rotation Lock (A) to the locked position.

Description of Parts

Before Using the Pen (Included)

The tether prevents the pen (included) from falling accidentally.

Attaching the pen (included) to the computer using the tether

In this section, illustrations of the digitizer pen are used as examples.

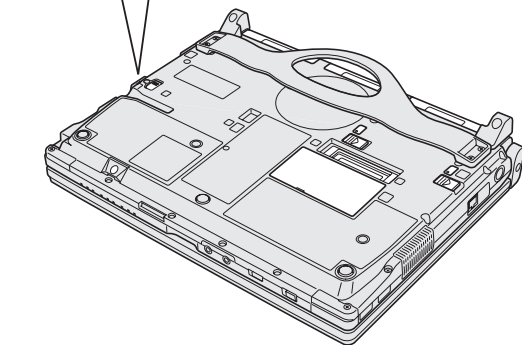
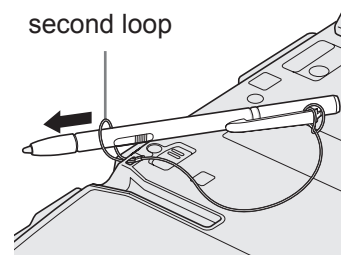
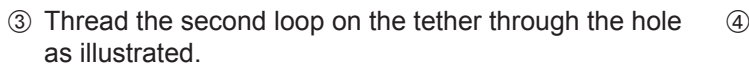
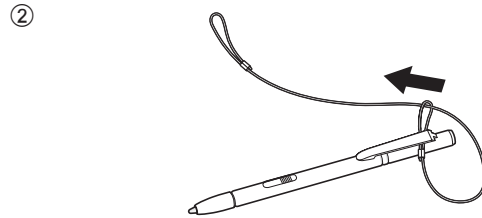
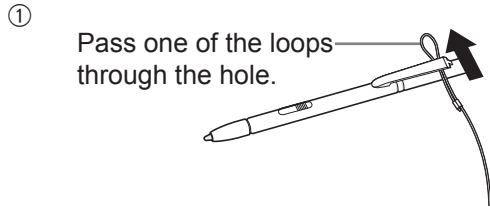

NOTE

- When the pen (included) is not in use, hook the tether as illustrated.

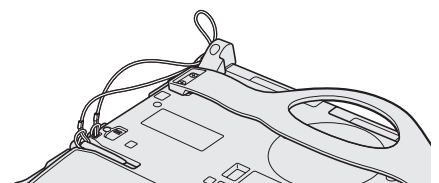

Using the Hand Strap

The hand strap is convenient for computing while standing.

To carry the computer, put your hand between the computer and the hand strap to prevent it from falling, and firmly hold the computer when using it.

NOTE

- Be careful of computer drop resulting from the hand strap damage.

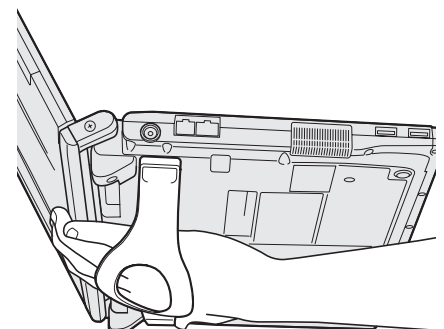

First-time Operation

■ Preparation

① Check and identify the supplied accessories.

If you do not find the described accessories, contact your technical support office.

- AC Adaptor 1
- AC Cord 1
- Battery Pack 1

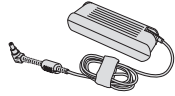

Model No: CF-AA6503A

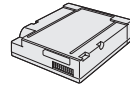

Model No: CF-VZSU66U

- Soft Cloth 1
- Tether 1
- <Only for model with digitizer> • Digitizer Pen 1
- <Only for model with touchscreen> • Stylus 1



(→ Reference Manual
“Screen Input Operation”)



Model No: CF-VNT004AU

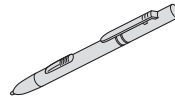

Model No: CF-VNP016AU

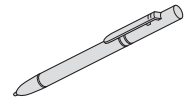

Model No: CF-VNP017AU

Attached in the pen holder at purchase.

(→ Reference Manual “Screen Input Operation”)

- OPERATING INSTRUCTIONS (This book) 1

② Read the LIMITED USE LICENSE AGREEMENT before breaking the seal on the computer’s packaging (→ page 31).

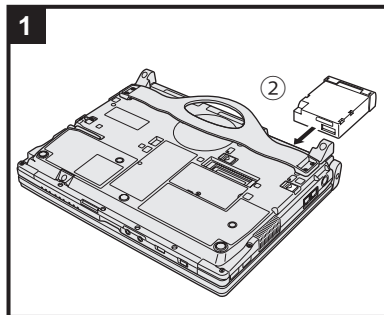

1 Inserting the Battery Pack

- ① Turn over the computer.
 - Make sure no foreign objects are under the computer.
- ② Slide the battery pack in parallel with the arrow direction until it clicks to the secured position.

CAUTION

- Make sure the latch is securely locked. Otherwise the battery pack may fall when you carry the computer.
- Do not touch the terminals of the battery pack and the computer. Doing so can make the terminals dirty or damaged, and may cause malfunction of the battery pack and the computer.

NOTE

- Note that the computer consumes electricity even when the computer power is off. If the battery pack is fully charged, the battery will fully discharged in the following period of time:
 - In **Windows 7** sleep/ **Windows XP** standby:
Approx. 3.5 days (If “Wake Up from wired LAN” is enabled: 2.5 days)^{*1}
 - In hibernation: Approx. 20 days (If “Wake Up from wired LAN” is enabled: 5 days)^{*1}
 - When power is off: Approx. 20 days (If “Power On by wired LAN” is enabled: 5 days)
- ^{*1} If “Wake Up from wired LAN” is disabled, the period of time will become slightly longer.

2 Attaching the Pen (included)

Attach the pen (included) to the computer. To attach the pen, refer to “Before Using the Pen (Included)” (→ page 14).

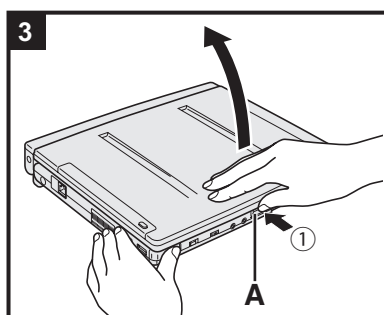

3 Opening the Display

- ① Hold the side of the computer with either of your hands and then hold and lift the (A) part to open the display.

CAUTION

- Do not open the display wider than necessary (130° or more), and do not apply excessive pressure to the LCD. Do not open or close the computer holding the edge of the LCD segment.

First-time Operation

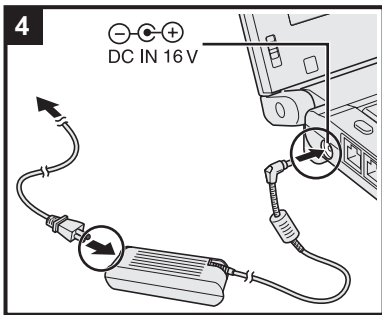

4 Connect your computer to a power outlet.

The battery charging starts automatically.

CAUTION

- Do not disconnect the AC adaptor and do not switch the wireless switch to on until the first-time operation procedure is completed.
- When using the computer for the first time, do not connect any peripheral device except the battery pack and AC adaptor.
- **Handling the AC adaptor**
 - Problems such as sudden voltage drops may arise during periods of thunder and lightning. Since this could adversely affect your computer, an uninterruptible power source (UPS) is highly recommended unless running from the battery pack alone.

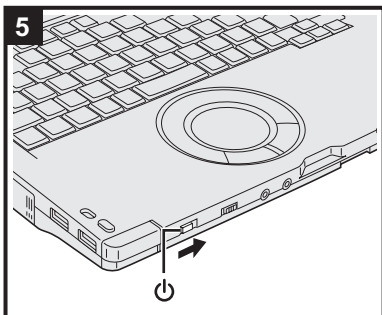

5 Turn on the computer.

① Slide and hold the power switch  until the power indicator  lights.

CAUTION

- Do not slide the power switch repeatedly.
- The computer will forcibly be turned off if you slide and hold the power switch for four seconds or longer.
- Once you turn off the computer, wait for 10 seconds or more before you turn on the computer again.
- Do not perform the following operation until the hard disk drive indicator  turns off.
 - Connecting or disconnecting the AC adaptor
 - Sliding the power switch
 - Touching the keyboard, touch pad, screen, external mouse, or tablet buttons
 - Closing the display
- Any changes from the default setting of the Setup Utility must not be made until the First-time Operation is completed.

6 Setup Windows.

Follow the on-screen instructions.

- The computer restarts several times. Do not touch the keyboard or touch pad, and wait until the hard disk drive indicator  has turned off.

Windows 7

- After the computer is turned on, the screen remains black or unchanged for a while. This is not a malfunction. Wait for a moment until the Windows setup screen appears.
- During setup of Windows, use the touch pad and clicking to move the cursor and to click an item.
- Setup of Windows will take approximately 20 minutes.
Go to the next step, confirming each message on the display.
- “Join a wireless network” screen may not appear.
You can set the Wireless Network after the setup of Windows is complete.

CAUTION

- You can change the user name, password, image and security setting after setup of Windows.
- Remember your password. If you forget the password, you cannot use Windows. Creating a password reset disk beforehand is recommended.

Windows 7

- Do not use the following words for user name: CON, PRN, AUX, CLOCK\$, NUL, COM1 to COM9, LPT1 to LPT9, @. In particular, if you create a user name (account name) that includes the “@” mark, a password will be requested at the log-on screen, even if no password has been set. If you try to log on without entering a password, “The user name or password is incorrect.” may be displayed and you will not be able to log on to Windows (→ page 28).

Windows XP

- The input panel is displayed on “Welcome to the Windows XP Setup Wizard”. Move “Welcome to the Windows XP Setup Wizard” and make sure that the “Welcome to the Windows XP Setup Wizard” and the input panel do not overlap.

- You cannot choose the following words for user name and password: CON, PRN, AUX, CLOCK\$, NUL, COM1 to COM9, LPT1 to LPT9.
- When you set date/time/time zone and click [Next], the screen may not go to the next step for a few minutes. Do not touch the keyboard or touch pad, and wait until the screen changes.
- If “An unexpected error has occurred ...” (or a similar message) is displayed, click [OK]. This is not a malfunction.

7 Perform the screen calibration.

NOTE

- **Windows 7**
Before performing the calibration, close Tablet PC Input Panel.
- Before performing the calibration, rotate the display to primary landscape.

Windows 7

- ① Click  (Start) - [All Programs] - [Panasonic] - [Calibration Utility].
- ② If [User Account Control] is displayed, click [Yes].
- ③ <Only for model with digitizer>
 - (1) Click [Pen input (digitizer)].
 - (2) Using the digitizer pen, touch each of the “+” target marks one by one, and then click [Yes].
 - (3) Click [Touch input].
 - (4) Using your finger, touch each of the “+” target marks one by one, and then click [Yes].
- <Only for model with touchscreen>
 - (1) Click [Start].
 - (2) Using the stylus, touch each of the “+” target marks one by one, and then click [Yes].

Windows XP

- ① Click [start] - [All Programs] - [Panasonic] - [Calibration Utility].
- ② <Only for model with digitizer>
 - (1) Click [Pen input (digitizer)].
 - (2) Using the digitizer pen, touch each of the “+” target marks one by one, and then click [Yes].
 - (3) Click [Touch input].
 - (4) Using your finger, touch each of the “+” target marks one by one, and then click [Yes].
- <Only for model with touchscreen>
 - (1) Click [start].
 - (2) Using the stylus, touch each of the “+” target marks one by one, and then click [Yes].

Windows XP

8 Create a new account.

Click [start] - [Control Panel] - [User Accounts] - [Create a new account].

CAUTION

- Remember your password. If you forget the password, you cannot use the Windows operating system. Creating a password reset disk beforehand is recommended.

NOTE

● PC Information Viewer

This computer periodically records the management information of the hard disk, etc. The maximum data volume for each record is 1024 bytes.

This information is only used for estimating the cause in the case when the hard disk goes down by any possibility. They are never sent to outside via network nor used for any other purpose except for the purpose described the above.

To disable the function, add the check mark for [Disable the automatic save function for management information history] in [Hard Disk Status] of PC Information Viewer, and click [OK]. When you disable the function, information on how to use the hard disk of PC Information Pop-up is not displayed.

(→  Reference Manual “Check the Computer’s Usage Status” “PC Information Pop-up”)

First-time Operation

- To conserve power, the following power saving methods are set at the time of purchase. (When AC adaptor is connected)
 - The screen automatically turns off after **Windows 7** 10 minutes/ **Windows XP** 15 minutes of inactivity.
 - The computer automatically enters **Windows 7** sleep²/ **Windows XP** standby² after 20 minutes of inactivity.² Refer to  *Reference Manual* "Sleep/Standby or Hibernation Functions" about resuming from sleep/standby.
- Even when the AC adaptor is not connected to the computer, power is consumed (Max. 0.2 W) simply by having the AC adaptor plugged into an AC outlet. (When using with 115 V AC)

■ Precaution against Starting Up/Shutting Down

- Do not do the following
 - Connecting or disconnecting the AC adaptor
 - Sliding the power switch
 - Touching the keyboard, touch pad, screen, external mouse, or tablet buttons
 - Closing the display
 - Turn on/off the wireless switch

■ About the battery for this computer

The computer has 2 battery pack compartments; one for the included battery pack, and the other for an optional battery pack. If one of the two battery packs has remaining power, you can replace the other battery pack without turning off the computer (→  *Reference Manual* "Battery Power").

Power is consumed only on either battery pack. Charging is made for the two battery packs at the same time.

With the battery charger (optional: CF-VCBC11U), you can remove the empty battery pack from the computer and charge it while using the computer.

Windows 7

■ To change the partition structure

You can shrink a part of an existing partition to create unallocated disk space, from which you can create a new partition. This computer has a single partition as default setting.

- ① Click  (Start) and right-click [Computer], then click [Manage].
 - A standard user needs to enter an administrator password.
- ② Click [Disk Management].
- ③ Right-click the partition for Windows ("c" drive in the default setting), and click [Shrink Volume].
 - The partition size depends on the computer specifications.
- ④ Input the size in [Enter the amount of space to shrink in MB] and click [Shrink].
 - You cannot input a larger number than the displayed size.
 - To select [Reinstall to the first 2 partitions.] in reinstalling Windows 7 (→ page 24), 30000 MB or more is necessary for [Total size after shrink in MB].
- ⑤ Right-click [Unallocated] (the shrunk space in the step ④) and click [New Simple Volume].
- ⑥ Follow the on-screen instructions to make the settings, and click [Finish].
Wait until formatting is completed.

NOTE

- You can create an additional partition using remaining unallocated space or newly creating unallocated space.
- To delete a partition, right-click the partition and click [Delete Volume] in step ③.

On-screen Manual

You can access the Reference Manual and the Important Tips on the computer screen.

When you access the Reference Manual and the Important Tips for the first time, the License Agreement of the Adobe Reader may be displayed. Read it carefully and select [Accept] to proceed.

■ Reference Manual

The Reference Manual contains the practical information to help you fully enjoy the computer's performance.

To access the Reference Manual:

Windows 7 Double-click  on the desktop.

- Alternatively click  (Start) - [All Programs] - [Panasonic] - [On-Line Manuals] - [Reference Manual].

Windows XP Click [start] - [Reference Manual].

- Alternatively click [start] - [All Programs] - [Panasonic] - [On-Line Manuals] - [Reference Manual].

■ Important Tips

The Important Tips will provide you with the battery information so that you can use the battery pack in the optimum condition to obtain longer operation time.

To access the Important Tips:

Windows 7 Double-click  on the desktop.

- Alternatively click  (Start) - [All Programs] - [Panasonic] - [On-Line Manuals] - [Important Tips].

Windows XP Double-click  on the desktop.

- Alternatively click [start] - [All Programs] - [Panasonic] - [On-Line Manuals] - [Important Tips].

NOTE

- When Adobe Reader update notice is displayed, we recommend you follow the on-screen procedure and update. See <http://www.adobe.com/> for the latest version of Adobe Reader.

Handling and Maintenance

Operation Environment

- Place the computer on a flat stable surface. Do not place the computer upright. If the computer is exposed to an extremely strong impact, it may become inoperable.
 - Temperature: Operation : 5 °C to 35 °C {41 °F to 95 °F}
Storage : -20°C to 60 °C {-4 °F to 140 °F}
 - Humidity: Operation : 30% to 80% RH (No condensation)
Storage : 30% to 90% RH (No condensation)
- Even within the above temperature/humidity ranges, using for a long time in an extreme environment will result in the product deterioration and will shorten the product life.
- Be sure to use the computer in an environment with sufficient heat ventilation.
 - Avoid using the computer on a highly heat retentive surfaces (e.g., rubber pads and blankets). If possible, use the computer on surfaces that can dissipate heat, such as a steel desk.
 - Do not cover the computer with towels, keyboard covers, etc., as this prevents heat dissipation.
- Do not place the computer in the following areas, otherwise the computer may be damaged.
 - Near electronic equipment. Image distortion or noise may occur.
 - In extremely high or low temperature.
 - As the computer can become hot during operation, keep it away from items that are sensitive to heat.

Handling Cautions

■ When using the computer

- Do not block the ventilation hole (exhaust).

■ When carrying the computer

- This computer is designed to minimize shock to parts such as the LCD and the hard disk drive and equipped with a drip-proof keyboard, but no warranty is provided against any trouble caused by shock. Be extremely careful when handling the computer.
- Turn off the computer.
- Remove all external devices, cables, PC Cards and other protruding objects.
- Do not drop or hit the computer against solid objects.
- Do not leave the display open.
- Do not grip the display part and area of tablet buttons.
- When you carry the AC adaptor with the cord rolled up, roll it up as shown in (A).
Do not roll up the cord in the opposite direction or crossed direction as shown in (B).
 - Be sure not to roll up the cord around the AC adaptor in use.
 - Pull out the AC cord. Also, do not roll up the AC cord.
- Do not carry the computer in the tablet mode.
- Do not put anything (e.g., a piece of paper) between the display and keyboard.
- When you board an airplane, take the computer with you and never put it in your checked luggage. When using the computer on airplane, follow the airline's instructions.
- This computer contains a magnet and magnetic products at the locations circled in the illustration at the right. Avoid leaving metallic object or magnetic media in contact with these areas.
- Be careful not to get injured by dropping or getting hit when carrying the computer.
- When carrying a spare battery, put it in a plastic bag to protect its terminals.

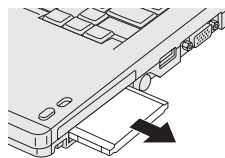

(A)

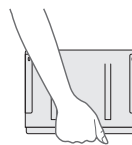

Correct



Incorrect

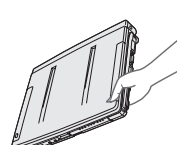

Incorrect

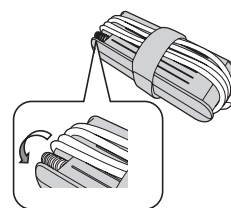

(B)

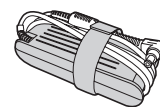

Incorrect

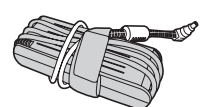

Incorrect

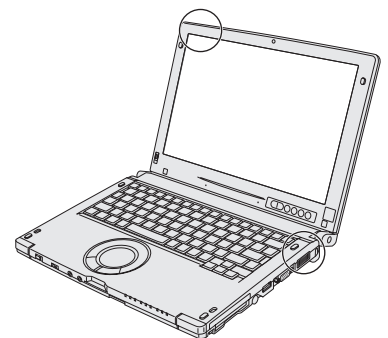

■ When using the digitizer/touchscreen



- Use the pen (included) with the computer. Do not use pencils, implements with sharp tips or hard objects for screen operations. The screen may be damaged as a result.
- Do not place any object on the surface or press down forcefully with sharp-pointed objects (e.g., nails), or hard objects that can leave marks (e.g., pencils and ball point pens).
- Do not apply pressure to the perimeter of the display panel. The cursor may move to the edge of the display.
- Do not operate the computer when such things as dust are on the screen. Do not allow contact with substances that could dirty the screen, such as oil.
- Do not apply too much pressure when operating the screen. Only a light touch is required to operate the screen. Applying too much pressure may damage the surface.
- When the screen becomes dirty, use the Soft Cloth (included) with the computer. (For more information, refer to  *Reference Manual* “Suggestions About Cleaning the LCD Surface”.)
- Do not touch the screen outside of the LCD display area. The screen input area is defined by the LCD display screen. Touching the screen outside of the display area may result malfunctions or damage to the screen.

<Only for model with digitizer>

- The screen uses electromagnetic induction and may not work properly near strong electrical field or magnetic field such as:
 - Near AM radio base station or relay station antennas
 - Near CRT displays that generate strong electromagnetic field noise
Move the screen away from such locations so it will work properly.
- The cursor cannot follow the digitizer pen or finger movement if you move the digitizer pen or finger too quickly.

■ If the computer becomes warm during usage

● Windows 7

When the screen is displayed on the External Display using Intel® Wireless Display Software, click  on the notification area, click  and click [Power saver].

([Power saver] for the power plan restrains performance. Accordingly, using application software or peripheral devices frequently may slow the computer processing speed.)

● Windows 7

When Intel® Wireless Display Software is not used, click  on the notification area and click . Then click [Panasonic Power management (Better Heat Dispersion)].

- When changing to [Panasonic Power management (Better Heat Dispersion)], the following settings will change.
 - Change to [High Speed] from [Standard] in [Fan control mode].
Rotation of the cooling fan speeds fast and the computer can be cooled down. Note that the battery operating time will be shorter.
 - Switch the screen saver to [Prohibited].
- When you do not frequently use CPU or the rotation noise of the fan bothers you, set [Standard] or [Low Speed] in [Fan control mode].

① Click  on the notification area and click .

② Select [Standard] or [Low Speed] in [Fan control mode].

→  *Reference Manual* “Customizing the Power Setting”

● Check the following

- If you are not using a wireless LAN, turn the wireless LAN off.

● Windows XP

If the computer becomes warm while the screen saver is displayed, set the screen saver to [Windows XP].

Screen savers that use 3-D images or other complex images increase the CPU utilization rate.

- Use recommended RAM module products. Non-recommended RAM modules may not operate properly, and may cause damage to your computer.

● Windows XP

Double-click  on the desktop and click [High speed], then click [OK].

- When you set [High speed], rotation of the cooling fan speeds up and the computer can be cooled down. Note that the battery operating time will be shorter.
- When you do not frequently use CPU or the rotation noise of the fan bothers you, set [Standard] or [Low speed] as necessary.

Windows XP

■ When using commercially available USB2.0 Hub

- A commercially available USB2.0 Hub connected to your computer may stop functioning if a USB2.0 printer is disconnected from another port. In this case, restart the computer.

Handling and Maintenance

■ When using peripheral devices

Follow these instructions and the Reference Manual to avoid any damage to the devices. Carefully read the instruction manuals of the peripheral devices.

- Use the peripheral devices conforming to the computer's specifications.
- Connect to the connectors in the correct direction.
- If it is hard to insert, do not try forcibly but check the connector's shape, direction, alignment of pins, etc.
- If screws are included, fasten them securely.
- Remove the cables when you carry the computer. Do not pull the cables forcibly.

■ Preventing your computer from unauthorized use via wireless LAN/Bluetooth/wireless WAN

<Only for model with wireless LAN/Bluetooth/wireless WAN>

- Before using wireless LAN/Bluetooth/wireless WAN, make the appropriate security settings such as data encryption.

■ When the battery indicator does not light on

The AC adaptor's protection function may be working when the battery indicator does not light on even if the AC adaptor and the battery pack are correctly connected with the computer.

- Pull out the AC cord and wait for more than 1 minute to reconnect the AC cord.
- If the problem persists, contact your technical support office.

Maintenance

To clean the LCD panel

Use the Soft Cloth (included) with the computer. (For more information, refer to  *Reference Manual* "Suggestions About Cleaning the LCD Surface".)

Cleaning the display while the power is on may cause the computer to malfunction. Also, dirt on the screen is easier to see when the computer is powered off, and so is easier to clean.

To clean the touch pad

Wipe lightly with a gauze or other dry, soft cloth.

To clean areas other than the LCD panel and touch pad

Wet a soft cloth with water or a diluted kitchen cleanser (neutral), wring the cloth out thoroughly, and wipe the dirty area gently. Using a detergent other than a neutral kitchen cleanser (e.g., a weak alkali cleanser) may adversely affect painted surfaces.

CAUTION

- Do not use benzene, thinner, or rubbing alcohol since it may adversely affect the surface causing discoloration, etc. Do not use commercially-available household cleaners and cosmetics, as they may contain components harmful to the surface.
- Do not apply water or detergent directly to the computer, since liquid may enter inside of the computer and cause malfunction or damage.

When Using the Computer with a Reduced Resolution

When setting the screen resolution to a resolution below the LCD's resolution, the images appearing on the screen will be stretched. As a result, the characters displayed may appear blurred. This is normal, and not indicative of a malfunction.

To display large characters with no blurring

Try the following steps while keeping the LCD in its resolution.

- **Windows 7** Click  (Start) - [Control Panel] - [Appearance and Personalization] - [Display], select except for [Smaller - 100%] and then click [Apply].
(This function will be enabled after logging off the computer.)
- To display enlarged font sizes in applications such as Internet Explorer:
Use the display enlargement function provided by the specific software application.
- To display enlarged desktop icons, title bar and cursor or magnify the specific part of the screen:
Use **Windows XP** "Icon Enlarger" or "Loupe Utility".

If You Spill Water on the Keyboard

Note that repairs resulting from liquids being spilled on the computer are not free of charge, and not covered by warranty.

The keyboard on this computer incorporate a drain system (a moisture protection mechanism) that minimizes the amount of liquid reaching the inside of the computer even if water is spilled on the keyboard.

Any water that comes in contact with the keyboard is drained off through holes in the bottom of the computer, so that virtually no water is left inside the computer. However, this is not a guarantee against damage to the hard disk or other internal parts, or against the loss or deletion of data.

The drain system is incorporated into only the keyboard. It does not apply to any other components.

- If you spill water or any other liquid on the keyboard, even a small amount, be sure to perform the following steps. Failure to perform these steps may result in damage to the computer. The drain system will not provide complete protection against water entering the computer.

- 1 Immediately turn off the computer, and remove the AC adaptor.**
- 2 Wipe any water droplets off of the top of the keyboard using a soft, dry cloth.**



- 3 Slowly lift up the computer, keeping it level, and wipe any water coming out of the holes on the bottom using a soft, dry cloth.**
If the computer is tilted during this step, liquid may seep inside the computer resulting in damage.



- 4 Keeping the computer level, move the computer to a dry place.**
If the computer is placed back on the wet surface, water may seep inside the computer from the bottom.

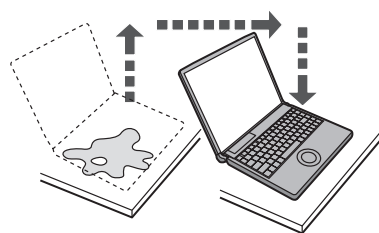

- 5 Remove the battery pack.**
- 6 Be sure to contact your technical support office to have the computer checked for any malfunctions.**

Reinstalling Software

Reinstalling software will return the computer to the default condition. When you reinstall the software, the hard disk data will be erased.

Back up important data to other media or an external hard disk before reinstallation.

CAUTION

- You can reinstall Windows 7 only.
- Do not delete the recovery partitions on the hard disk.
The disk space in the partition is not available to store data.

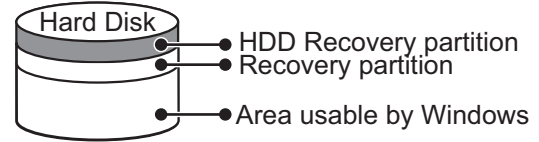

■ Hard Disk Recovery

Preparation

- Remove all peripherals.
- Connect the AC adaptor and do not remove it until reinstallation is complete.

1 Turn on the computer, and press F2 or Del while [Panasonic] boot screen is displayed.
The Setup Utility starts up.

- If the [Panasonic] boot screen is not displayed, turn on the computer while holding down F2 or Del.
- If the password is requested, enter the Supervisor Password.

2 Write down all of the contents of the Setup Utility and press F9.

At the confirmation message, select [Yes] and press Enter.

3 Press F10.

At the confirmation message, select [Yes] and press Enter.
Computer will restart.

4 Press F2 or Del while [Panasonic] boot screen is displayed.

The Setup Utility starts up.

- If the [Panasonic] boot screen is not displayed, turn on the computer while holding down F2 or Del.
- If the password is requested, enter the Supervisor Password.

5 Select the [Exit] menu, then select [Repair Your Computer] and press Enter.

6 Click [Reinstall Windows] and click [Next].

The License Agreement screen appears.

7 Click [Yes, I agree to the provisions above and wish to continue!] and click [Next].

8 Select the settings and click [Next].

- [Reinstall Windows to the whole Hard Disk to factory default.]
Select this option when you want to reinstall Windows to the factory default. After reinstallation, you can create a new partition. For how to create a new partition, refer to "To change the partition structure" (→ page 18)
- [Reinstall to the System and OS partitions.]¹
Select this option when the hard disk has already been divided into several partitions. For how to create a new partition, refer to "To change the partition structure" (→ page 18).
You can keep the partition structure.

¹ This does not appear if Windows cannot be reinstalled to the partition containing boot files and the area usable by Windows.

9 At the confirmation message, click [YES].

10 Select OS (32bit or 64bit) and click [OK].

11 At the confirmation message, click [OK].

Reinstallation starts according to the instructions on the screen. (It will take approximately 15 minutes.)

- Do not interrupt reinstallation, for example by turning off the computer. Otherwise reinstallation may become unavailable as Windows may not start up or the data may be corrupted.

12 When ending screen is displayed, click [OK] to turn off the computer.

13 Turn on the computer.

- If the password is requested, enter the Supervisor Password.

14 Perform the "First-time Operation" (→ page 16).

15 Start the Setup Utility and change the settings as necessary.

16 Perform Windows Update.

■ Using Recovery Disc

Use the Recovery Disc for reinstallation in the following conditions.

- You have forgotten the administrator password.
- Reinstallation is not complete. The recovery partition may be broken.

NOTE

- To change OS from 32-bit to 64-bit, or vice versa, reinstall OS using the recovery partition in the hard disk.

Preparation

- Prepare the Recovery Disc (→  Reference Manual “Recovery Disc Creation Utility”)
 - Prepare CD/DVD drive (optional: Refer to recent catalogs and other sources for information about the products available) or port replicator (optional: CF-VEBC11U)
 - Remove all peripherals (except for the CD/DVD drive and port replicator).
 - Connect the AC adaptor and do not remove it until reinstallation is complete.
- 1 Turn off the computer and connect CD-DVD drive or port replicator to the computer.**
 - 2 Turn on the computer, and press **F2** or **Del** while [Panasonic] boot screen is displayed.**

The Setup Utility starts up.

 - If the [Panasonic] boot screen is not displayed, turn on the computer while holding down **F2** or **Del**.
 - If the password is requested, enter the Supervisor Password.
 - 3 Write down all of the contents of the Setup Utility and press **F9**.**

At the confirmation message, select [Yes] and press **Enter**.
 - 4 Press **F10**.**

At the confirmation message, select [Yes] and press **Enter**.
Computer will restart.
 - 5 Press **F2** or **Del** while [Panasonic] boot screen is displayed.**

The Setup Utility starts up.

 - If the [Panasonic] boot screen is not displayed, turn on the computer while holding down **F2** or **Del**.
 - If the password is requested, enter the Supervisor Password.
 - 6 Set the Recovery Disc into the CD/DVD drive or port replicator.**
 - 7 Select the [Exit] menu.**
 - 8 When using CD/DVD drive:**

Select your CD/DVD drive in [Boot Override] and press **Enter**.

When using port replicator:

Select [P1: TEAC XXXXX] in [Boot Override] and press **Enter**.
The computer will restart.
 - 9 Click [Reinstall Windows] and click [Next].**

The License Agreement screen appears.
 - 10 Click [Yes, I agree to the provisions above and wish to continue!] and click [Next].**
 - 11 Select the settings and click [Next].**
 - [Reinstall Windows to the whole Hard Disk to factory default].
Select this option when you want to reinstall Windows to the factory default. After reinstallation, you can create a new partition. For how to create a new partition, refer to “To change the partition structure” (→ page 18)
 - [Reinstall to the first 3 partitions.]²
Select this option when the hard disk has already been divided into several partitions. For how to create a new partition, refer to “To change the partition structure” (→ page 18).
You can keep the partition structure.
² This does not appear if Windows cannot be reinstalled to the partition containing boot files and the area usable by Windows.
 - 12 At the confirmation message, click [YES].**

Reinstallation starts. (It will take approximately 40 minutes.)
According to the screen, replace the Recovery Disc.

 - Do not interrupt reinstallation, for example by turning off the computer. Otherwise reinstallation may become unavailable as Windows may not start up or the data may be corrupted.
 - 13 When ending screen is displayed, remove the Recovery Disc, and then click [OK] to turn off the computer.**
 - 14 Turn on the computer.**
 - If the password is requested, enter the Supervisor Password.
 - 15 Perform the “First-time Operation” (→ page 16).**
 - 16 Start the Setup Utility and change the settings as necessary.**
 - 17 Perform Windows Update.**

Troubleshooting (Basic)

Follow the instructions below when a problem has occurred. There is also an advanced troubleshooting guide in the "Reference Manual". For a software problem, refer to the software's instruction manual. If the problem persists, contact your technical support office. You can also check the computer's status in the PC Information Viewer (→  *Reference Manual* "Check the Computer's Usage Status").

■ Starting Up and Sleep/Standby and Hibernation Mode

<p>The computer does not power on / The power indicator or battery indicator is not lit.</p>	<ul style="list-style-type: none"> ● Connect the AC adaptor. ● Insert a fully charged battery. ● Remove the battery pack and the AC adaptor, then connect them again. ● If an additional RAM module has been inserted, remove the RAM module and check to see if the RAM module is the recommended one. ● When the CPU temperature is high, the computer may not start up to prevent overheating of the CPU. Wait until the computer cools down, and then turn the power on again. If the computer does not power on even after cooling down, contact your technical support office.
<p>Windows does not start up.</p>	<ul style="list-style-type: none"> ● Remove all peripheral devices (e.g. USB memory). ● If the power indicator is lit, slide the power switch for four seconds or longer to turn off, then turn on again. ● Using the following procedure, start up in Safe Mode, and check the error details. <ol style="list-style-type: none"> ① Turn on the computer, and when the [Panasonic] boot screen disappears (after entering the password^{*1} if one is set) hold down F8. ② Release your finger when [Windows Advanced Options Menu] is displayed, and with ↑ or ↓, select [Safe Mode], then press Enter. <p>Follow the on-screen instructions.</p> <p>^{*1} Supervisor Password or User Password set with the Setup Utility</p> ● Press F9 in the Setup Utility to return the Setup Utility settings (excluding the passwords) to the default values. Start the Setup Utility and make the settings again.
<p>After adding or changing the RAM module, the power is turned on but nothing is displayed on the screen.</p>	<ul style="list-style-type: none"> ● Turn off the computer and remove the RAM module, then confirm whether the RAM module has compliant to specification. When the RAM module has conformed to specification, install it again.
<p>You have forgotten the password.</p>	<ul style="list-style-type: none"> ● Supervisor Password or User Password: Contact your technical support office. ● Administrator password: <ul style="list-style-type: none"> ● Windows 7 <ul style="list-style-type: none"> • If you have another account with Administrator authority, log-on with it, then delete the password for the problem account. • If you have a password reset disk, click [Reset password] displayed after the password input error, then follow the on-screen instructions to set a new password. ● Windows XP <ul style="list-style-type: none"> • If you have a password reset disk, you can reset the administrator password. Set the disk and enter any wrong password, then follow the on-screen instructions and set a new password. <p>If you cannot do either of the above, you will need to reinstall (→ page 24) and setup Windows.</p>
<p>"Remove disks or other media. Press any key to restart" or a similar message appears.</p>	<ul style="list-style-type: none"> ● A floppy disk is in the floppy disk drive and it does not contain system startup information. Remove the floppy disk and press any key. ● This message may appear with some devices connected to the USB port. Remove the device or set [Legacy USB Support] to [Disabled] in the [Advanced] menu of the Setup Utility. ● If the problem persists after removing the disk, it may be a hard disk failure. Perform the reinstallation and return the hard disk to its condition at the time of purchase (→ page 24). If the problem persists even after the reinstallation, contact your technical support office.
<p>The date and time are incorrect.</p>	<ul style="list-style-type: none"> ● Make the correct settings. <ul style="list-style-type: none"> ● Windows 7 Click  (Start) - [Control Panel] - [Clock, Language, and Region] - [Date and Time]. ● Windows XP Click [start] - [Control Panel] - [Date, Time, Language, and Regional Options] - [Date and Time]. ● If the problem persists, the internal clock battery may need to be replaced. Contact your technical support office. ● When the computer is connected to LAN, check the date and time of the server. ● The 2100 A.D. or later year will not be correctly recognized on this computer.

■ Starting Up and Sleep/Standby and Hibernation Mode

[Executing Battery Recalibration] screen appears.	<ul style="list-style-type: none"> ● The Battery Recalibration was canceled before Windows was shut down last time. To start up Windows, turn off the computer by the power switch, and then turn on.
The computer will not automatically enter Windows 7 sleep / Windows XP standby or hibernation.	<ul style="list-style-type: none"> ● If you connect to a network using wireless LAN function, perform access point settings. (→ <i>Reference Manual</i> “Wireless LAN”) ● If you do not use wireless LAN function, turn off wireless LAN function. (→ <i>Reference Manual</i> “Disabling/Enabling Wireless Communication”) ● Make sure that you are not using any software that regularly accesses the hard disk.
[Enter Password] does not appear when resuming from Windows 7 sleep / Windows XP standby or hibernation.	<ul style="list-style-type: none"> ● Select [Enabled] in [Password On Resume] in the [Security] menu of the Setup Utility (→ <i>Reference Manual</i> “Setup Utility”). ● The Windows password can be used instead of the password set in the Setup Utility. <ul style="list-style-type: none"> Windows 7 <ol style="list-style-type: none"> ① Click (Start) - [Control Panel] - [User Accounts and Family Safety] - [Add or remove user accounts] and select the account, and set the password. ② Click (Start) - [Control Panel] - [System and Security] - [Power Options] - [Require a password on wakeup] and a check mark for [Require a password]. Windows XP <ol style="list-style-type: none"> ① Click [start] - [Control Panel] - [User Accounts] and select the account, and set the password. ② Click [start] - [Control Panel] - [Performance and Maintenance] - [Power Option] - [Advanced] and a check mark for [Prompt for password when computer resumes from standby].
When logging on (e.g., resuming the computer), audio is distorted.	<ul style="list-style-type: none"> ● Perform the following steps to change the audio settings to prevent audio output. <ul style="list-style-type: none"> Windows 7 <ol style="list-style-type: none"> ① Right-click the desktop and click [Personalize] - [Sounds]. ② Remove the check mark from [Play Windows Startup sound], and click [OK]. Windows XP <ol style="list-style-type: none"> ① Click [start] - [Control Panel] - [Sounds, Speech, and Audio Devices] - [Sounds and Audio Devices], and click [Sounds]. ② Set [Windows Logon] and [Windows Logoff] to [(None)].
Cannot resume.	<ul style="list-style-type: none"> ● One of the following operations may have been carried out. <ul style="list-style-type: none"> • In Windows 7 sleep/ Windows XP standby mode, the AC adaptor or battery pack was disconnected, or a peripheral was connected or disconnected. • The power switch was slid for four seconds or longer to forcibly turn off the computer. Slide the power switch to turn on the computer. Data not saved will be lost.
Other startup problems.	<ul style="list-style-type: none"> ● Check to see if there was a disk error. <ol style="list-style-type: none"> ① Remove all peripheral devices including an external display. ② Windows 7 Click (Start) - [Computer] and right-click [Local Disk (C:)], and click [Properties]. ③ Windows XP Click [start] - [My Computer] and right-click [Local Disk (C:)], and click [Properties]. ④ Click [Tools] - [Check Now...]. <ul style="list-style-type: none"> • A standard user needs to enter an administrator password. ⑤ Windows 7 Click [Schedule disk check] and restart the computer. ● Start the computer in Safe Mode and check the error details. (→ page 26 “Windows does not start up”.)

■ Shutting Down

Windows does not shut down.	<ul style="list-style-type: none"> ● Remove all peripheral devices. ● Wait one or two minutes. It is not a malfunction.
-----------------------------	---

Troubleshooting (Basic)

■ Password

<p>Even after entering the password, a message appears requesting to type it again.</p>	<ul style="list-style-type: none"> ● If [1] lights up, press NumLk to disable the ten-key mode, and then input. ● If [A] lights up, press Caps Lock to disable the Caps Lock mode, and then input.
<p>Windows 7 Cannot log on to Windows. ("The user name or password is incorrect." is displayed.)</p>	<ul style="list-style-type: none"> ● The user name (account name) includes the "@" mark. If another user account name exists: Log on to Windows using another user account name, and delete the account name that includes "@". Then create a new account name. If no other account name exists: You need to reinstall Windows (→ page 24).





■ Display

<p>The screen becomes black for a moment.</p>	<p>Windows 7</p> <ul style="list-style-type: none"> ● When you set [Display power saving function] of Power Plan Extension Utility to [Enabled], if you do the following operations, the screen becomes black for a moment, but this is not a malfunction. You can use it. <ul style="list-style-type: none"> ● Adjust the brightness of the screen with Fn + F1 / Fn + F2 or tablet button. ● Remove and insert the AC adaptor. <p>While you are using motion video playback software, benchmark software for graphic, if error screen is displayed or application software does not function normally, set [Display power saving function] to [Disabled].</p> <p>Windows XP</p> <ul style="list-style-type: none"> ● When you set [Intel video driver power saving function (Intel(R) Display Power Saving Technology)] of Power Saving Utility to [Enable], if you do the following operations, the screen becomes black for a moment, but this is not a malfunction. You can use it. <ul style="list-style-type: none"> ● Adjust the brightness of the screen with Fn + F1 / Fn + F2 or tablet button. ● Remove and insert the AC adaptor. <p>While you are using motion video playback software, benchmark software for graphic, if error screen is displayed or application software does not function normally, set [Intel video driver power saving function (Intel(R) Display Power Saving Technology)] to [Disable].</p>
<p>No display.</p>	<ul style="list-style-type: none"> ● The external display is selected. Press Fn + F3 (or Windows 7 [F4] + P) to switch the display. Wait until the display has been switched completely before pressing Fn + F3 (or Windows 7 [F4] + P) again. ● The display is turned off by the power-saving function. To resume, do not press the direct selection keys, but press any other key like Ctrl. ● The computer entered Windows 7 sleep/ Windows XP standby or hibernation by the power-saving function. To resume, slide the power switch. ● The screen may become darker. Press Fn + F2 or tablet button to make the screen brighter.
<p>The screen is disordered.</p>	<ul style="list-style-type: none"> ● Changing the number of display colors and resolution may affect the screen. Restart the computer. ● The refresh rate of the internal LCD may be 40 hertz. Change the refresh rate of the internal LCD. <ol style="list-style-type: none"> ① Right-click on the desktop, and click [Graphics Properties]. ② Click [OK]. ③ If [Refresh Rate] of the Notebook is [40 Hz], change to [60 Hz] and click [OK].
<p>The external display does not work normally.</p>	<ul style="list-style-type: none"> ● If the external display does not support the power saving function, it may not work normally when the computer enters the power saving mode. Turn off the external display.

■ Battery

The battery indicator lights red.	<ul style="list-style-type: none"> ● The battery level is very low (the charge is approx. 9% or less). ● Connect the AC adaptor. You can use the computer when the indicator light is orange. If you do not have an AC adaptor, save your data and power off your computer. After replacing the battery pack with a fully charged one, turn your computer on again.
The battery indicator is blinking.	<ul style="list-style-type: none"> ● If blinking red: Quickly save your data and power off your computer. Remove the battery pack and disconnect the AC adaptor, then connect them again. If the problem persists, contact your technical support office. The battery pack or charging circuit may be defective. ● If blinking orange: <ul style="list-style-type: none"> • The battery indicator blinks orange several times also when you slide the battery latch, but this is not a malfunction. • Battery cannot be recharged temporarily because the internal temperature of the battery pack is outside the acceptable temperature range for recharging. Your computer can be used normally in this state. Once the range requirement is satisfied, charging begins automatically. • Software applications and peripheral devices (USB devices, etc.) are consuming too much power. Exit the software applications currently running, and remove all peripherals. Once the range requirement is satisfied, charging begins automatically.
The battery indicator is flashing.	<ul style="list-style-type: none"> ● The battery is recharging. If [Battery Charging Indicator] in the [Main] menu of the Setup Utility is set to [Flashing], the indicator will alternately become lighter and darker.

■ Touch Pad/Screen

The cursor does not work.	<ul style="list-style-type: none"> ● When using the external mouse, connect it correctly. ● Restart the computer by using the keyboard. <ul style="list-style-type: none"> Windows 7 Press  and press  two times, and press  to select [Restart] and press Enter. Windows XP Press , U, and R to select [Restart]. ● If the computer does not respond to keyboard commands, read "No response" (→ page 30).
Cannot input using the touch pad.	<ul style="list-style-type: none"> ● Set [Touch Pad] to [Enable] in the [Main] menu of the Setup Utility. ● The drivers for some mice may disable the touch pad. Check your mouse's operating instructions.
Cannot point the correct position using the pen (included) or finger.	<ul style="list-style-type: none"> ● Perform the screen calibration (→ page 17). ● If external mouse driver is installed, you may not be possible to use the touch input and pen input. Uninstall external mouse driver.
The image on the display does not rotate.	<ul style="list-style-type: none"> ● The application program currently running may not support the image rotation. Quit the program, and then try to rotate the image. ● Install the Wireless Switch Utility, if not installed.

Troubleshooting (Basic)

■ Reference Manual

<p>The Reference Manual is not displayed.</p>	<ul style="list-style-type: none"> ● Install Adobe Reader. <ol style="list-style-type: none"> ① Log on to Windows as an administrator. ② Windows 7 Click  (Start) and input "c:\util\reader\Setup.exe" in [Search programs and files] then press Enter. Windows XP Click [start] - [Run] and input "c:\util\reader\Setup.exe", then click [OK]. ③ Update Adobe Reader to its latest version. If your computer is connected to the internet, start up Adobe Reader and click [Help] - [Check for Updates...].
---	--

■ Others

<p>No response.</p>	<ul style="list-style-type: none"> ● Press Ctrl+Shift+Esc to open Task Manager and close the software application that is not responding. ● An input screen (e.g., password input screen at startup) may be hidden behind another window. Press Alt+Tab to check. ● Slide the power switch for four seconds or longer to shut down the computer, and then slide the power switch to turn it on. If the application program does not work normally, uninstall and reinstall the program. To uninstall, <ul style="list-style-type: none"> Windows 7 click  (Start) - [Control Panel] - [Programs] - [Uninstall a program]. Windows XP click [start] - [Control Panel] - [Add or Remove Programs].
<p><Only for model with Camera> The Camera does not operate.</p>	<ul style="list-style-type: none"> ● When using the Camera after the computer resumes from sleep or hibernation, wait for about 10 seconds before starting up the software.
<p>Windows 7 <Only for model with Camera> The image of the camera flickers.</p>	<ul style="list-style-type: none"> ● The image of the camera might flicker when taking a picture under the fluorescent lamp. Change the setting of the anti flicker according to the following procedure. <ol style="list-style-type: none"> ① Click [Settings] - [Image Control...]. ② Change the setting of [PowerLine Frequency (Anti Flicker)]. (Set it to the power-supply frequency in the region). ③ Click [OK].
<p><Only for model with wireless WAN> The message "To assure compliance with RF exposure requirement, WWAN cannot be used in this direction. Do you want to rotate and disable WWAN?" appears.</p>	<ul style="list-style-type: none"> ● The message appears when you orient the computer so that the wireless WAN antenna is placed close to you and then try to rotate the display. Click [Yes] to turn off the wireless WAN and continue using the computer in the current orientation. If you do not want to turn off the wireless WAN, click [No]. In this case, the display will not rotate to the most suitable orientation.

LIMITED USE LICENSE AGREEMENT

THE SOFTWARE PROGRAM(S) (“PROGRAMS”) FURNISHED WITH THIS PANASONIC PRODUCT (“PRODUCT”) ARE LICENSED ONLY TO THE END-USER (“YOU”), AND MAY BE USED BY YOU ONLY IN ACCORDANCE WITH THE LICENSE TERMS DESCRIBED BELOW. YOUR USE OF THE PROGRAMS SHALL BE CONCLUSIVELY DEEMED TO CONSTITUTE YOUR ACCEPTANCE OF THE TERMS OF THIS LICENSE.

Panasonic Corporation has developed or otherwise obtained the Programs and hereby licenses their use to you. You assume sole responsibility for the selection of the Product (including the associated Programs) to achieve your intended results, and for the installation, use and results obtained therefrom.

LICENSE

- A. Panasonic Corporation hereby grants you a personal, non-transferable and non-exclusive right and license to use the Programs in accordance with the terms and conditions stated in this Agreement. You acknowledge that you are receiving only a LIMITED LICENSE TO USE the Programs and related documentation and that you shall obtain no title, ownership nor any other rights in or to the Programs and related documentation nor in or to the algorithms, concepts, designs and ideas represented by or incorporated in the Programs and related documentation, all of which title, ownership and rights shall remain with Panasonic Corporation or its suppliers.
- B. You may use the Programs only on the single Product which was accompanied by the Programs.
- C. You and your employees and agents are required to protect the confidentiality of the Programs. You may not distribute or otherwise make the Programs or related documentation available to any third party, by time-sharing or otherwise, without the prior written consent of Panasonic Corporation.
- D. You may not copy or reproduce, or permit to be copied or reproduced, the Programs or related documentation for any purpose, except that you may make one (1) copy of the Programs for backup purposes only in support of your use of the Programs on the single Product which was accompanied by the Programs. You shall not modify, or attempt to modify, the Programs.
- E. You may transfer the Programs and license them to another party only in connection with your transfer of the single Product which was accompanied by the Programs to such other party. At the time of such a transfer, you must also transfer all copies, whether in printed or machine readable form, of every Program, and the related documentation, to the same party or destroy any such copies not so transferred.
- F. You may not remove any copyright, trademark or other notice or product identification from the Programs and you must reproduce and include any such notice or product identification on any copy of any Program.

YOU MAY NOT REVERSE ASSEMBLE, REVERSE COMPILE, OR MECHANICALLY OR ELECTRONICALLY TRACE THE PROGRAMS, OR ANY COPY THEREOF, IN WHOLE OR IN PART.

YOU MAY NOT USE, COPY, MODIFY, ALTER, OR TRANSFER THE PROGRAMS OR ANY COPY THEREOF, IN WHOLE OR IN PART, EXCEPT AS EXPRESSLY PROVIDED IN THE LICENSE.

IF YOU TRANSFER POSSESSION OF ANY COPY OF ANY PROGRAM TO ANOTHER PARTY, EXCEPT AS PERMITTED IN PARAGRAPH E ABOVE, YOUR LICENSE IS AUTOMATICALLY TERMINATED.

TERM

This license is effective only for so long as you own or lease the Product, unless earlier terminated. You may terminate this license at any time by destroying, at your expense, the Programs and related documentation together with all copies thereof in any form. This license will also terminate effective immediately upon occurrence of the conditions thereof set forth elsewhere in this Agreement, or if you fail to comply with any term or condition contained herein. Upon any such termination, you agree to destroy, at your expense, the Programs and related documentation together with all copies thereof in any form.

YOU ACKNOWLEDGE THAT YOU HAVE READ THIS AGREEMENT, UNDERSTAND IT AND AGREE TO BE BOUND BY ITS TERMS AND CONDITIONS. YOU FURTHER AGREE THAT IT IS THE COMPLETE AND EXCLUSIVE STATEMENT OF THE AGREEMENT BETWEEN US, WHICH SUPERSEDES ANY PROPOSAL OR PRIOR AGREEMENT, ORAL OR WRITTEN, AND ANY OTHER COMMUNICATIONS BETWEEN US, RELATING TO THE SUBJECT MATTER OF THIS AGREEMENT.

GOVERNMENT RESTRICTED RIGHTS.

The Software is provided with “RESTRICTED RIGHTS.” Use duplication or disclosure by the government is subject to restrictions as set forth in FAR52.227-14 and DFAR252. 227-7013 et seq. or their successors.

Use of the Software by the government constitutes acknowledgement of Intel’s proprietary rights therein.

Contractor or Manufacturer is Intel Corporation, 2200 Mission College Blvd., Santa Clara, CA 95052.

Contrat de licence d'usage limité

Le(s) logiciel(s) (les "Logiciels") fournis avec ce produit Panasonic (le "Produit") sont exclusivement concédés en licence à l'utilisateur ultime ("vous"), et ils ne peuvent être utilisés que conformément aux clauses contractuelles ci-dessous. En utilisant les logiciels, vous vous engagez de manière définitive à respecter les termes, clauses et conditions des présentes.

Panasonic Corporation a mis au point ou obtenu les Logiciels et vous en concède l'utilisation par les présentes. Vous assumez l'entière responsabilité du choix de ce Produit (y compris des Logiciels associés) pour obtenir les résultats escomptés, ainsi que de l'installation, de l'utilisation et des résultats obtenus.

Licence

- A. Panasonic Corporation vous octroie par les présentes le droit et la licence personnels, non cessibles et non exclusifs d'utiliser les Logiciels conformément aux termes, clauses et conditions de ce contrat. Vous reconnaissez ne recevoir qu'un droit limité d'utiliser les Logiciels et la documentation les accompagnant et vous vous engagez à n'obtenir aucun droit de titre, propriété ni aucun autre droit vis-à-vis des Logiciels et de la documentation les accompagnant ni vis-à-vis des algorithmes, concepts, dessins, configurations et idées représentés par ou incorporés dans les Logiciels et la documentation les accompagnant, dont les titres, propriété et droits resteront tous à Panasonic Corporation ou à leurs propriétaires.
- B. Vous ne pouvez utiliser les Logiciels que sur le Produit unique qui est accompagné par les Logiciels.
- C. Vous et vos employés ou agents êtes requis de protéger la confidentialité des Logiciels. Vous ne pouvez ni distribuer ni mettre les Logiciels et la documentation les accompagnant à la disposition d'un tiers, par partage de temps ou de quelque autre manière que ce soit, sans l'autorisation écrite préalable de Panasonic Corporation.
- D. Vous ne pouvez ni copier ni reproduire ni permettre la copie ni la reproduction des Logiciels ni de la documentation les accompagnant pour quelque fin que ce soit, à l'exception d'une (1) copie des Logiciels à des fins de sauvegarde uniquement pour soutenir votre utilisation des Logiciels sur le Produit unique qui est accompagné par les Logiciels. Vous ne pouvez ni modifier ni tenter de modifier les Logiciels.
- E. Vous ne pouvez céder les Logiciels et en octroyer la licence à une autre partie qu'en rapport avec votre cession du Produit unique qui est accompagné par les Logiciels à cette autre partie. Au moment de cette cession, vous devez céder également toutes les copies, que ce soit sous forme imprimée ou lisible par la machine, de tous les Logiciels ainsi que de la documentation les accompagnant, à la même partie ou détruire les copies non cédées.
- F. Vous ne pouvez retirer aucune marque de droits d'auteur, marque de commerce ou autre ni aucune identification de produit des Logiciels et vous devez reproduire et inclure toutes ces notices ou identifications de produit sur toutes les copies des Logiciels.

Vous ne pouvez assembler en sens inverse, compiler en sens inverse ni retracer les Logiciels ni aucune de leurs copies, de façon électronique ou mécanique, en tout ou en partie.

Vous ne pouvez utiliser, copier, modifier, altérer ni céder les Logiciels ni aucune de leurs copies, en tout ou en partie, à l'exception de ce qui est expressément stipulé dans ce contrat.

Si vous cédez la possession de toute copie ou de tout Logiciel à une autre partie, à l'exception de ce qui est autorisé au paragraphe E ci-dessus, votre licence est automatiquement résiliée.

Termes, clauses et conditions

Cette licence n'est effective que pour la durée de possession ou de crédit-bail du Produit, à moins d'une résiliation antérieure. Vous pouvez résilier cette licence à tout moment en détruisant, à vos frais, les Logiciels et la documentation les accompagnant avec toutes leurs copies, sous quelque forme que ce soit. Cette licence sera également résiliée, avec application immédiate, si les conditions de résiliation définies ailleurs dans ce contrat se sont réalisées ou si vous ne respectez pas les termes, clauses et conditions qui y sont contenues. Au moment de la résiliation, vous acceptez de détruire, à vos frais, les Logiciels et la documentation les accompagnant avec toutes leurs copies, sous quelque forme que ce soit.

Vous reconnaissez avoir lu ce contrat, en avoir compris toute la substance et avoir accepté de respecter ses termes, clauses et conditions. Vous reconnaissez en outre qu'ils sont la description complète et exclusive du contrat conclu entre nous, contrat qui remplace et annule toute proposition ou contrat précédent, écrit ou oral, et toute autre communication entre nous, relativement à l'objet du présent contrat.

Specifications

This page provides the specifications for the basic model.
The model number is different according to the unit configuration.

- To check the model number:
Check the bottom of the computer or the box the computer came in at the time of purchase.
- Run the Setup Utility (→  *Reference Manual* "Setup Utility") and select [Information] menu.
[CPU Speed]: CPU speed, [Memory Size]: Memory size, [Hard Disk]: Hard disk drive size

■ Main Specifications

Model No.	CF-C1BDHAZDM	CF-C1BTFAZDM
CPU	Intel® vPro™ Technology ^{*1}	
	Intel® Core™ i5-2520M vPro™ processor (2.50 GHz with Turbo Boost up to 3.20 GHz, Intel® Smart Cache 3 MB ^{*2})	
Chipset	Intel® 6 Series Express Chipsets QM67	
Main Memory ^{*2*3}	4 GB, DDR3 SDRAM (8 GB Max.)	2 GB, DDR3 SDRAM (6 GB Max.)
Video Memory ^{*2*4}	Windows 7 UMA(<32-bit> 1557 MB Max., <64-bit> 1696 MB Max.)	Windows 7 UMA(<32-bit> 773 MB Max., <64-bit> 776 MB Max.) UMA(<32-bit> 1557 MB Max., <64-bit> 1696 MB Max. (When Memory is 4GB or 6GB))
Video Controller	Intel® HD Graphics 3000 (Built-in Chip Set)	
Hard Disk Drive ^{*5}	320 GB Windows 7 Approx. 12 GB (HDD Recovery partition) and Approx. 300 MB (Recovery partition) are as recovery partitions. (Users cannot use these partitions.)	
Display Method	12.1 WXGA type (TFT) (1280 × 800 dots)	
Internal LCD	65,536/16,777,216 colors (1280 x 800 dots) ^{*6}	
External Display ^{*7}	65,536/16,777,216 colors (800 x 600 dots/1024 x 768 dots/1280 x 720 dots/1280 x 768 dots/1280 x 1024 dots/1400 x 1050 dots/1600 x 900 dots/1600 x 1200 dots/1680 x 1050 dots/1920 x 1080 dots/1920 x 1200 dots)	
Simultaneous Display on LCD + External Display ^{*7}	65,536/16,777,216 colors (800 x 600 dots/1024 x 768 dots/1280 x 720 dots/1280 x 768 dots/1280 x 800 dots) ^{*6}	
Wireless LAN ^{*8}	Intel® Centrino® Advanced-N 6205 (→ page 34)	
Bluetooth ^{*9}	→ page 35	
Wireless WAN ^{*10}	Sierra™ Wireless High-speed module	
LAN ^{*11}	IEEE 802.3 10BASE-T, IEEE 802.3u 100BASE-TX, IEEE 802.3ab 1000BASE-T	
Modem ^{*12}	Data: 56 kbps (V.92) FAX: 14.4 kbps	
Fingerprint Reader ^{*13}	Array Size: 192 x 4 pixels, Image Size: 192 x 512 pixels, Image Resolution: 508 DPI	
Camera ^{*14}	1280 x 1024 dots (Max.), 7.5 fps	
Sound	WAVE and MIDI playback, Intel® High Definition Audio subsystem support, Monaural Speaker (built-in), Microphone arrays (built-in)	
Security Chip	TPM (TCG V1.2 compliant) ^{*15}	
Card Slots	PC Card Slot	x 1, Type I or Type II, Allowable current 3.3 V: 400 mA, 5 V: 400 mA
	SD Memory Card Slot ^{*16}	x 1
	Contact Smart Card Slot ^{*17}	x 1
RAM Module Slot	x 1, DDR3 SDRAM, 204-pin, 1.5 V, SO-DIMM, PC3-10600 Compliant	
Interface	USB port x 3 (USB 2.0 x 3) ^{*18} / Modem Port (RJ-11) ^{*12} / LAN Port (RJ-45) ^{*11} / External Display Port: Mini Dsub 15-pin female / Microphone Jack ^{*19} : Miniature jack, 3.5 DIA / Headphone Jack: Miniature jack, 3.5 DIA / Port Replicator Connector ^{*20} : Dedicated 84-pin male	
Keyboard / Pointing Device	83 keys/Touch Pad/Digitizer + Multi touch (Capacitive)	83 keys/Touch Pad/Multi touch (Resistive)
Power Supply	AC adaptor or Battery pack	
AC Adaptor ^{*21}	Input: 100 V - 240 V AC, 50 Hz/60 Hz Output: 16 V DC, 5.0 A	

Specifications

Model No.	CF-C1BDHAZDM		CF-C1BTFAZDM
Battery Pack	Li-ion 7.4 V, 6.0 Ah (Typ.), 5.7 Ah (Min.)		
Operating Time ^{*22}	Approx. 6 hours (When using 2 battery packs: approx. 12 hours) (Economy Mode (ECO) – Disable)		
	Charging Time ^{*23}		
Power Consumption ^{*24}	Approx. 25 W ^{*25} / Approx. 80 W (maximum when recharging in the ON state)		
Physical Dimensions (W × D × H)	299.2 mm × 226.5 mm × 30.6 mm (at the front)/44.3 mm (at the rear) {11.8 " × 8.9 " × 1.2 "/1.7 "}		
Weight ^{*26}	Approx. 1.49 kg {3.28 lb} (When using 2 battery packs: Approx. 1.69 kg {3.73 lb})		
Environment	Operation	Temperature	5 °C to 35 °C
		Humidity	30 % to 80 % RH (No condensation)
	Storage	Temperature	-20 °C to 60 °C
		Humidity	30 % to 90 % RH (No condensation)

■ Software

Base OS	Genuine Windows® 7 Professional
Installed OS ^{*27}	<p>Windows 7 Genuine Windows® 7 Professional 32-bit Service Pack 1 / Genuine Windows® 7 Professional 64-bit Service Pack 1</p> <p>Windows XP Genuine Windows® XP Tablet PC Edition Service Pack 3^{*36}</p>
OS ^{*27}	<p>Windows 7 Genuine Windows® 7 Professional 32-bit Service Pack 1 / Genuine Windows® 7 Professional 64-bit Service Pack 1</p> <p>Windows XP Genuine Microsoft® Windows® XP Tablet PC Edition Service Pack 3^{*28}</p>
Pre-installed Software ^{*27}	<p>Adobe Reader / Loupe Utility / Touch Pad Utility / PC Information Viewer / PC Information Popup / Display Rotation Tool / Hotkey Settings / Wireless Switch Utility / Intel® Rapid Storage Technology / Bluetooth™ Stack for Windows by TOSHIBA¹⁹ / Battery Recalibration Utility / Intel® PROSet/Wireless Software / Wireless Connection Disable Utility^{*29} / Protector Suite^{*13 *29} / Dashboard for Panasonic PC / Hand Writing Utility / Software Keyboard / Camera Utility^{*14} / Infineon TPM Professional Package^{*30} / Calibration Utility / Wireless Manager Mobile Edition 5.5f^{*31} / Intel® Identity Protection Technology</p> <p>Windows 7 Microsoft® Internet Explorer 9.0 / DirectX 11^{*32} / Microsoft® Windows® Media Player 12 / Microsoft® .NET Framework 3.5.1 / Power Plan Extension Utility / Windows XP Mode / Intel® Wireless Display Software / Quick Boot Manager / Recovery Disc Creation Utility</p> <p>Windows XP Microsoft® Internet Explorer 6 Service Pack 3 / DirectX 9.0c / Microsoft® Windows® Media Player 10 / Microsoft® Windows® Movie Maker 2.1 / Microsoft® .NET Framework 3.5 SP1 / Icon Enlarger / Power Saving Utility / FAN Control Utility / Economy Mode (ECO) Setting Utility</p> <p>Aptio Setup Utility / Hard Disk Data Erase Utility^{*33} / PC-Diagnostic Utility</p>

■ Wireless LAN <Only for model with wireless LAN>

Data Transfer Rates	<p>IEEE802.11a : 54/48/36/24/18/12/9/6 Mbps (automatically switched)^{*34}</p> <p>IEEE802.11b : 11/5.5/2/1 Mbps (automatically switched)^{*34}</p> <p>IEEE802.11g : 54/48/36/24/18/12/9/6 Mbps (automatically switched)^{*34}</p> <p>IEEE802.11n : (HT20) GI = 400ns: 150/130/115/86/72/65/57/43/39/28/21/14/7 Mbps (automatically switched)^{*34}</p> <p>GI = 800ns: 130/117/104/78/65/58/52/39/26/19/13/6 Mbps</p> <p>(HT40) GI = 400ns: 300/270/240/180/150/135/120/90/60/45/30/15 Mbps (automatically switched)^{*34}</p> <p>GI = 800ns: 270/243/216/162/135/121/108/81/54/40/27/13 Mbps</p>
Standards Supported	IEEE802.11a / IEEE802.11b / IEEE802.11g / IEEE802.11n
Transmission method	OFDM system, DS SS system
Wireless Channels Used	<p>IEEE802.11a : Channels 36/40/44/48/52/56/60/64/100/104/108/112/116/132/136/140/149/153/157/161/165</p> <p>IEEE802.11b/IEEE802.11g : Channels 1 to 11</p> <p>IEEE802.11n : Channels 1-11/36/40/44/48/52/56/60/64/100/104/108/112/116/132/136/140/149/153/157/161/165</p>

RF Frequency Band	IEEE802.11a : 5.18 GHz - 5.32 GHz, 5.5 GHz - 5.7 GHz, 5.745 GHz - 5.825 GHz IEEE802.11b/IEEE802.11g : 2.412 GHz - 2.462 GHz IEEE802.11n : 2.412 GHz - 2.462 GHz, 5.18 GHz - 5.32 GHz, 5.5 GHz - 5.7 GHz, 5.745 GHz - 5.825 GHz
-------------------	---

■ **Bluetooth™ <Only for model with Bluetooth>**

Bluetooth Version	2.1 + EDR
Transmission method	FHSS system
Wireless Channels Used	79 channels
RF Frequency Band	2.402 GHz - 2.480 GHz

*1 The Intel® Active Management Technology (Intel® AMT) function must be set before use. To use Intel® Anti-Theft Technology and Intel® Identity Protection Technology (Intel® IPT), a dedicated solution provided by a service provider is required.

*2 1 MB = 1,048,576 bytes / 1 GB = 1,073,741,824 bytes

*3 For 32-bit OS, the usable memory available will be less depending on the specifications (3.4 GB ~ 3.5 GB).

*4 A segment of the main memory is allotted automatically depending on the computer's operating status. The size of the Video Memory cannot be set by the user.

The size of Video memory is allotted depending on the operating system.

*5 1 MB = 1,000,000 bytes. 1 GB = 1,000,000,000 bytes. Your operating system or some application software will report as fewer MB/GB.

*6 A 16,777,216 color display is achieved by using the dithering function.

*7 Display may be impossible using some connected external displays.

*8 Only for model with wireless LAN.

*9 Only for model with Bluetooth. Continua Certified, compliant design guideline version 1, with Blood Pressure Monitor, Cardiovascular and Weighing Scale device only by Bluetooth.

*10 Only for model with wireless WAN.

*11 Some devices cannot be used depending on the port type.

*12 Only for model with modem.

*13 Only for model with fingerprint reader.

*14 Only for model with Camera.

*15 Only for model that supports TPM.

Windows 7 For information on TPM, click  (Start) and input "c:\util\drivers\tpm\README.pdf" in [Search programs and files] and press **Enter**, and refer to the "Installation Manual Trusted Platform Module (TPM)".

Windows XP For information on TPM, click [start] - [Run] and input "c:\util\drivers\tpm\README.pdf" and click [OK], and refer to the "Installation Manual Trusted Platform Module (TPM)".

*16 Operation has been tested and confirmed using Panasonic SD Memory Card with a capacity of up to 2 GB, Panasonic SDHC Memory Card with a capacity of up to 32 GB, and **Windows 7** Panasonic SDXC Memory Card with a capacity of up to 64 GB. Operation on other SD equipment is not guaranteed.

*17 Only for model with Smart Card Slot.

*18 Does not guarantee operation of all USB-compatible peripherals.

*19 Use a condenser-stereo microphone.

*20 Only for model with port replicator connector.

*21 <Only for North America>

The AC adaptor is compatible with power sources up to 240 V AC adaptor. This computer is supplied with a 125 V AC compatible AC cord.

20-M-1

*22 Measured using MobileMark™ 2007 (LCD brightness : 60 cd/m²).

Varies depending on the usage conditions, or when an optional device is attached.

When Economy Mode (ECO) is enabled, the operating time becomes approximately 20 % shorter than when it is disabled.

*23 When Economy Mode (ECO) is enabled, the charging time becomes approx. 5.0 hours (Power on/off). Varies depending on the usage conditions, CPU speed, etc.

It may take a long time to charge a fully discharged battery.

*24 Approx. 0.9 W when the battery pack is fully charged (or not being charged) and the computer is off.

<When using with 115 V AC>

Even when the AC adaptor is not connected to the computer, power is consumed (Max. 0.2 W) simply by having the AC adaptor plugged into an AC outlet.

*25 Rated power consumption.

23-E-1

*26 Average value. May differ depending on models.

*27 When reinstalling Windows using the data of the recovery area on the hard disk, you can select the OS to be installed (either Windows 7 (32-bit) or Windows 7 (64-bit)). An OS that has been installed at the time of purchase or an OS that has been installed using the hard disk recovery function or the recovery disc can be supported.

*28 The downgrade service is available only for corporate users who fulfill certain conditions.

*29 Must be installed before use.

*30 Only for model that supports TPM. Must be installed before use.

*31 For information on Wireless Manager, refer to the "Supplementary Instructions for Wireless Manager mobile edition 5.5" by the following procedure.

Windows 7 Click  (Start) and input "c:\util\w\prjct\Supplementary Instructions.pdf" in [Search programs and files] and press **Enter**.

Windows XP Click [start] - [Run] and input "c:\util\w\prjct\Supplementary Instructions.pdf" and click [OK].

*32 The graphics accelerator of this computer supports up to DirectX 10.1.

*33 Perform on the recovery partition. (If this software can not be performed on the recovery partition, perform from the recovery disc)

*34 These are speeds specified in IEEE802.11a+b+g+n standards. Actual speeds may differ.

LIMITED WARRANTY

For U.S.A.

Panasonic Solutions Company - Worldwide Product Warranties

Section 1: Limited Warranty - Hardware

Panasonic Solutions Company (referred to as "Panasonic") will repair the products listed below with new or rebuilt parts, free of charge in the U.S.A. or other Panasonic approved location for the period specified below from the date of original purchase in the event of a defect in materials or workmanship. These warranties are extended solely to the original purchaser. A purchase receipt or other proof of date of original purchase will be required before warranty performance is rendered.

- Laptop Computers – 3 Years
- PDRC - LCD and Keyboard Assemblies – 3 Years
- MDWD – Mobile Computer and Wireless Display Assemblies (CF-07/CF-08) - 3 Years
- Ultra-Mobile PC (CF-U1/CF-H1) – 3 Years
- Hand-held Computers (P1/P2) – 1 Year
- Arbitrator Video Camera – 1 Year
- Arbitrator Recorder Unit – 1 Year
- Arbitrator Remote Control Panel – 1 Year
- Arbitrator Wireless Receiver Unit – 1 Year
- Arbitrator P2 Card(s) (All Sizes) – 1 Year
- Arbitrator Wireless Microphone(s) / Transmitter – 90 Days
- Arbitrator System Component Interconnect Cables – 90 Days

Battery Warranty

The battery supplied with the product is covered under the warranty for one (1) year from date of purchase, except as excluded in Section 3. Batteries purchased separately are covered under the warranty for one (1) year from the date of purchase. A battery furnished under the warranty is covered for the remaining period of the one year warranty on the original or purchased battery.

Wireless Module Warranty

Panasonic approved wireless modems installed in Panasonic brand computers and integrated by Panasonic or an Authorized Panasonic Wireless Integrator are covered under the warranty for the remaining warranty period of the computer in which the modem is installed. For computers with less than three (3) months remaining on the unit warranty, the wireless modem will be covered for a period of three (3) months from the date of installation of the modem, covering only modem replacement or modem installation related issues.

All modems must be approved by the wireless carrier prior to use. Any use or attempted use of a wireless modem not approved and activated by the carrier for use on their network is strictly prohibited and is not sanctioned or warranted by Panasonic and may result in legal action. In addition, all modems must be approved by Panasonic as compatible with the computer hardware before installation or use.

Panasonic's sole responsibility for the warranty or technical support of the software required to install or operate the modem is defined in Section 2 (Limited Software Warranty). Any attempted software installation by anyone other than a Panasonic Authorized Wireless Integrator is not covered under warranty and may result in service charges to re-image or replace the hard drive.

Installation or attempted installation by any party other than Panasonic or an Authorized Panasonic Wireless Integrator is strictly not covered under the warranty and may void the computer warranty if damage results.

Options and Accessories warranties

The below listed Panasonic brand or supplied options and accessories are covered under this limited warranty for the period specified from the date of purchase or as specifically stated:

- AC Adaptor / Power Cord – 3 Years
- Memory Card (Panasonic Brand) – 3 Years
- Car Mount Docking Station PCB or Complete Vehicle Docking Station – 3 Years
- Port Replicator / I-O Box / Device Cradle (like CF-08) – 3 Years
- Antenna Pass-through Cable – 3 Years
- Backlit or Full-sized keyboard - 3 Years or assumes warranty of the unit in which it is installed
- Integrated Panasonic supplied options and kits including, but not limited to Wireless WAN, Media Bay Drives (Floppy, CD/DVD, Combo), Camera, GPS, Bluetooth, Smartcard Reader, Magnetic Card Reader, Barcode Scanner and Fingerprint readers – 3 Years or assumes warranty period of the unit in which it is installed provided the integration was performed by Panasonic or an Authorized Options Integrator.
- Hard Drive (separately purchased) – 1 Year
- External USB Drives (CD / DVD / Floppy / Hard Drive) – 1 Year
- Optional Battery – 1 Year
- Battery Charger / Multi-Bay Battery Charger – 1 Year
- Digitizer pen or stylus – 90 Days (physical damage excluded)

Section 2 - Limited Warranty - Software

Panasonic Solutions Company (referred to as "Panasonic") warrants to you only that the disk(s) or other media on which the Programs are furnished will be free from defects in material and workmanship under normal use for a period of sixty (60) days from the date of delivery thereof to you, as evidenced by your purchase receipt.

This is the only warranty Panasonic makes to you. Panasonic does not warrant that the functions contained in the Programs will meet your requirements or that the operation of the Programs will be uninterrupted or error free. Panasonic shall have no obligation for any defects in the disk(s) or other media on which the Programs are furnished resulting from your storage thereof, or for defects that have been caused by operation of the disk(s) or other media

Panasonic's entire liability and your exclusive remedy under this warranty shall be limited to the replacement, in the United States or other Panasonic designated location, of any defective disk or other media which is returned to Panasonic's Authorized Service Center, together with a copy of the purchase receipt, within the aforesaid warranty period. The customer is responsible for ensuring that all data is backed up and made secure during normal use and before sending a unit for service.

Section 3 - Limited Warranty Exclusions

Specifically excluded from the warranty are:

- All consumable items; such as screen protection films, logo badges, labels, cleaning cloths, carry cases, manuals, cables, straps, belts, holsters, tethers, and harnesses and any other options and accessories not listed above or covered under a separate warranty.
- Failures related to the product operating system, hard drive image, software setup, software program, virus, other program(s) or file(s) on the hard drive or in any computer memory location.
- Failures due to BIOS settings or changes, as well as any cosmetic or physical damage to the unit.
- Any unit or device with a missing or altered model number or serial number label
- Damage which occurs in shipment
- Failures which are caused by products not supplied by Panasonic
- Failures which result from alteration, accident, misuse, introduction of liquid or other foreign matter into the unit, abuse, neglect, installation, maladjustment of consumer controls, improper maintenance or modification, use not in accordance with product use instructions
- Failures due to service by anyone other than a Panasonic Authorized Service Provider
- Failures caused by improper integration by any company other than Panasonic or a Panasonic Authorized Integrator.
- Damage, failure, or loss due to the unit being stolen, lost, misplaced, or used by anyone other than the original purchaser
- Damage that is attributable to acts of God

This warranty only covers failures due to defects in materials or workmanship which occur during normal use.

THIS PRODUCT IS NOT INTENDED FOR USE AS, OR AS PART OF, NUCLEAR EQUIPMENT/SYSTEMS, AIR TRAFFIC CONTROL EQUIPMENT/SYSTEMS, OR AIRCRAFT COCKPIT EQUIPMENT/SYSTEMS¹. PANASONIC WILL NOT BE RESPONSIBLE FOR ANY LIABILITY RESULTING FROM THE USE OF THIS PRODUCT ARISING OUT OF THE FOREGOING USES.

¹ AIRCRAFT COCKPIT EQUIPMENT/SYSTEMS include Class2 Electrical Flight Bag (EFB) Systems and Class1 EFB Systems when used during critical phases of flight (e.g., during take-off and landing) and/or mounted on to the aircraft. Class1 EFB Systems and 2 EFB Systems are defined by FAA: AC (Advisory Circular) 120-76A or JAA: JAA TGL (Temporary Guidance Leaflets) No.36

Other Limits and Exclusions: There are no other express warranties except as listed above.

PANASONIC SHALL NOT BE LIABLE FOR LOSS OF DATA OR OTHER INCIDENTAL OR CONSEQUENTIAL DAMAGES RESULTING FROM THE USE OF THIS PRODUCT, OR ARISING OUT OF ANY BREACH OF THIS WARRANTY. ALL EXPRESS AND IMPLIED WARRANTIES, INCLUDING THE WARRANTIES OF MERCHANTABILITY AND FITNESS FOR A PARTICULAR PURPOSE ARE LIMITED TO THE APPLICABLE WARRANTY PERIOD SET FORTH ABOVE. Some states do not allow the exclusion or limitation of incidental or consequential damages, or limitations on how long an implied warranty lasts, so the above limitations or exclusions may not apply to you.

This limited warranty gives you specific legal rights, and you may also have other rights which vary from state to state.

For technical support or to arrange for service on your Panasonic computer product, call our toll-free hotline at 1-800-LAPTOP5.

DIAL TOLL FREE: 1-800-LAPTOP5 (1-800-527-8675)
Web Site : www.panasonic.com/toughbook

LIMITED WARRANTY

For Canada

PANASONIC COMPUTER AND PERIPHERALS LIMITED WARRANTY

Coverage – Panasonic Canada Inc. (“PCI”) warrants to you, the first end user customer, this computer product (excluding software media), when purchased from PCI or from a PCI authorized reseller, to be free from defects in materials and workmanship under normal use, subject to the terms set forth below, during the period of warranty coverage specified.

Scope of Coverage	Period of Coverage	Type of Failure Coverage
<ul style="list-style-type: none"> Laptop Computers (except Battery) and AC Adaptor Factory/PCI installed options including Wireless WAN, GPS, Bluetooth, Finger print reader, Backlit keyboard, Memory Card and Media Bay Drives (Floppy, CD/DVD) Ultra-Mobile PC (CF-U1/CF-H1) Mobile Wireless Display PDRC – LCD and Keyboard Assemblies Port Replicator 	Three (3) Years from Date of Original End User Customer Purchase	Defective Materials or Workmanship
<ul style="list-style-type: none"> Hand-held Computers Battery Battery charger Auto Adaptor External USB Drives 	One (1) Year from Date of Original End User Customer Purchase	Defective Materials or Workmanship
<ul style="list-style-type: none"> Digitizer pen or stylus 	Ninety (90) Days from Date of Original End User Customer Purchase	Defective Materials or Workmanship
<ul style="list-style-type: none"> All consumable items including protection film, cleaning cloth, carry case, tether and harness 	No Coverage	

Remedy – In the event of a warranty claim, contact PCI’s representatives within the applicable warranty period, identifying the nature of the defect claimed, at 1-800-668-8386 between 9:00 A.M. and 5:00 P.M., Eastern Time Zone, Mon. – Fri. (excluding holidays) for instructions on how to obtain service. A purchase receipt or other proof of date of original purchase is required before warranty service is performed. Defective parts covered by this Limited Warranty will be repaired or replaced with new or comparable rebuilt parts on an exchange basis. Warranty replacement or repair is subject to the terms of this Limited Warranty for the balance of the original period of warranty coverage.

No Coverage – This Limited Warranty does not cover products purchased outside Canada. Neither does it cover damage to, failure of, or defects in a product or accessory through mishandling, improper installation, abnormal use, misuse, neglect, accident, introduction of liquid or other foreign matter into the product, alteration or servicing by anyone not authorized by PCI, or act of God. THIS PRODUCT IS NOT INTENDED FOR USE AS, OR AS PART OF, NUCLEAR EQUIPMENT/SYSTEMS, AIR TRAFFIC CONTROL EQUIPMENT/SYSTEMS, OR AIRCRAFT COCKPIT EQUIPMENT/SYSTEMS². PANASONIC WILL NOT BE RESPONSIBLE FOR ANY LIABILITY RESULTING FROM THE USE OF THIS PRODUCT ARISING OUT OF THE FOREGOING USES.

² AIRCRAFT COCKPIT EQUIPMENT/SYSTEMS include Class2 Electrical Flight Bag (EFB) Systems and Class1 EFB Systems when used during critical phases of flight (e.g., during take-off and landing) and/or mounted on to the aircraft. Class1 EFB Systems and 2 EFB Systems are defined by FAA: AC (Advisory Circular) 120-76A or JAA: JAA TGL (Temporary Guidance Leaflets) No.36

IF YOU SHIP THE PRODUCT FOR WARRANTY SERVICE

Carefully pack the product, preferably in the original carton. Include details of defect claimed and proof of date of original purchase. No liability is assumed for loss or damage to the product while in transit, if you chose your own transportation carrier.

SOFTWARE MEDIA LIMITED WARRANTY

Coverage – PCI warrants to you, the first end user customer, that the disk(s) or other media on which software program(s) is/are supplied will be free from defects in materials and workmanship under normal use in Canada for a period of sixty (60) days from date of receipt as evidenced by your purchase receipt for your Panasonic Computer product.

THIS IS THE ONLY WARRANTY THAT PCI MAKES RESPECTING THE SOFTWARE MEDIA. PCI does not warrant the software. Please refer to the software licensor’s written warranty (accompanying the copy of the software) for any software warranty claim.

Claim Procedure – In the event of a defect in material or workmanship in the media during the sixty (60) days warranty period, and you return it, transportation costs prepaid, to Panasonic Canada Inc., Computer Products Marketing, 5770 Ambler Drive, Mississauga, Ontario L4W 2T3, within the warranty period, together with a copy of your purchase receipt, and an explanation of the suspected defect, PCI will replace in Canada the defective disk(s) or other media.

Remedy – PCI’s entire liability, and your only remedy for any breach of this software media warranty is limited to replacement of the media only. It does not cover any other damages, including, but not limited to, loss of use or profit loss, or special, indirect or consequential damages, or other claims, whether or not of similar character.

No Coverage – This limited warranty does not apply if the disk(s) or other media has been used in other than a Panasonic product, or in environmental conditions other than those specified by PCI or the manufacturer, or if subjected to misuse, neglect, mishandling, modification or attempted modification of the program, or if damaged by accident or act of God. PCI is not responsible for damage to or loss of any program, data or removable storage media.

GENERAL

NO OTHER WARRANTIES – PCI DISCLAIMS ALL OTHER WARRANTIES, EITHER EXPRESS OR IMPLIED, INCLUDING, BUT NOT LIMITED TO, IMPLIED WARRANTIES OF MERCHANTABILITY AND FITNESS FOR A PARTICULAR PURPOSE, WITH RESPECT TO THE SOFTWARE, SOFTWARE MEDIA, COMPUTER PRODUCT, OPTIONS AND ACCESSORIES.

NO LIABILITY FOR CONSEQUENTIAL DAMAGES – IN NO EVENT SHALL PCI BE LIABLE FOR ANY SPECIAL, INDIRECT OR CONSEQUENTIAL DAMAGES ARISING FROM ANY BREACH OF THE LIMITED WARRANTIES SET OUT IN THIS DOCUMENT, OR FROM THE USE OF THE COMPUTER PRODUCT, INCLUDING, WITHOUT LIMITATION, LOSS OF DATA, BUSINESS, PROFIT OR GOODWILL.

IN ANY EVENT, PCI’S MAXIMUM LIABILITY FOR ANY BREACH SHALL NOT EXCEED THE AMOUNT ACTUALLY PAID BY YOU FOR THE COMPUTER PRODUCT.

NO ACTION, REGARDLESS OF ITS BASIS, MAY BE BEGUN AGAINST PCI MORE THAN TWO (2) YEARS AFTER THE CAUSE OF ACTION AROSE.

Statutory Warranties – Some jurisdictions do not allow these limitations or exclusions, so they may not apply to you.

GARANTIE LIMITÉE

Pour le Canada

GARANTIE LIMITÉE – ORDINATEURS ET PÉRIPHÉRIQUES PANASONIC

Couverture – Panasonic Canada Inc. (« PCI ») garantit à l'acheteur original que ce produit informatique (à l'exclusion des supports des logiciels) est, au moment de sa vente par PCI ou d'un revendeur agréé par PCI, exempt de défauts de pièces et de fabrication dans les conditions normales d'utilisation, et ce, pendant la période de couverture de la garantie, sous réserve des modalités décrites ci-dessous.

Éléments couverts	Durée de couverture	Type de couverture
<ul style="list-style-type: none">• Ordinateurs blocs-notes (sauf batteries) et adaptateur secteur• Options installées en usine/par PCI incluant : WAN sans fil, GPS, Bluetooth, lecteur d'empreintes digitales, clavier rétroéclairé, carte mémoire et lecteurs (disquettes, CD/DVD)• Ordinateurs personnels ultra-portables (CF-U1/CF-H1)• Écran mobile sans fil• Ensembles PDRC – ACL et clavier• Duplicateur de port	Trois (3) ans à partir de la date d'achat original.	Défauts de pièces et de fabrication
<ul style="list-style-type: none">• Ordinateurs de poche• Batterie• Chargeur de batterie• Adaptateur pour voiture• Périphériques USB	Un (1) an à partir de la date d'achat original.	Défauts de pièces et de fabrication
<ul style="list-style-type: none">• Stylo pointeur standard ou pour numériseur graphique	Quatre-vingt-dix (90) jours à partir de la date d'achat original.	Défauts de pièces et de fabrication
<ul style="list-style-type: none">• Tous les articles consommables incluant les pellicules protectrices, chiffons de nettoyage, étuis de transport, longues et sangles	Aucune couverture	

Recours – Pour obtenir des informations sur la marche à suivre dans le cas où une réclamation en vertu de la garantie deviendrait nécessaire, communiquez par téléphone avec un représentant de PCI au 1-800-668-8386, entre 9h00 et 17h00 (heure de l'Est) du lundi au vendredi (sauf les jours fériés), avant l'échéance de la garantie applicable, en prenant soin d'identifier la nature de la défaillance. Un reçu ou toute autre pièce justificative de la date d'achat original sera exigé avant toute réparation. Toute pièce défectueuse couverte par la présente garantie limitée sera réparée ou remplacée par une pièce neuve ou remise à neuf. Le remplacement ou la réparation sera fait conformément aux modalités de la présente garantie limitée pendant la durée restante de la période originale de la garantie.

Produits non couverts – La présente garantie limitée ne couvre pas les produits achetés à l'extérieur du Canada. Elle ne couvre pas non plus les dommages, la défaillance ou les défauts attribuables à une manutention inadéquate, une mauvaise installation, une utilisation anormale ou abusive, de la négligence, un accident, un déversement ou la pénétration d'un objet étranger, une modification, un cas fortuit ou une réparation effectuée par une personne non agréée par PCI.

CE PRODUIT N'EST PAS DESTINÉ À ÊTRE UTILISÉ, EN TOUT OU EN PARTIE, COMME SYSTÈME/ÉQUIPEMENT NUCLÉAIRE, SYSTÈME/ÉQUIPEMENT DE CONTRÔLE DU TRAFFIC AÉRIEN OU SYSTÈME/ÉQUIPEMENT DE POSTE DE PILOTAGE D'AVION³. PANASONIC DÉCLINE TOUTE RESPONSABILITÉ CONCERNANT L'UTILISATION DE CE PRODUIT DANS LES CAS SUSMENTIONNÉS.

³ Les SYSTÈMES/ÉQUIPEMENTS DE POSTE DE PILOTAGE D'AVION sont dotés de systèmes OEPP (organiseur électronique de poste de pilotage) de classe 2 et de classe 1 utilisés pendant des phases critiques de vol (par exemple, pendant le décollage et l'atterrissage) et/ou montés sur l'avion. Les systèmes OEPP de classe 1 et de classe 2 sont définis par le circulaire d'information FAA: AC (Advisory Circular) 120-76A ou le feuillet n° 36 JAA: JAA TGL (Temporary Guidance Leaflets) No 36.

EXPÉDITION DU PRODUIT POUR SERVICE SOUS GARANTIE

Emballer soigneusement le produit, de préférence dans son emballage d'origine. Joignez une description de la défaillance de même qu'une pièce justificative de la date d'achat. Panasonic Canada Inc. ne peut être tenue responsable pour tout dommage ou perte subi pendant le transport si vous avez choisi le transporteur.

GARANTIE LIMITÉE – SUPPORTS DES LOGICIELS

Couverture – Panasonic Canada Inc. (« PCI ») garantit à l'acheteur original que la ou les disquettes ou tout autre support sur lequel le ou les programmes sont fournis sont exempts de défauts de pièces et de fabrication dans des conditions normales d'utilisation au Canada, et ce, pour une période de soixante (60) jours suivant la date de réception indiquée sur la preuve d'achat.

LA PRÉSENTE GARANTIE EST LA SEULE OFFERTE PAR PCI COUVRANT LES SUPPORTS DE LOGICIELS. PCI ne garantit pas les logiciels. Reportez-vous à la garantie écrite du concédant de licence d'utilisation du logiciel (qui accompagne la copie du logiciel) pour toute réclamation en vertu de la garantie.

Réclamation – marche à suivre – Panasonic Canada Inc. remplacera toute disquette ou support défectueux si l'article en question est retourné, port payé, à son service de Marketing – produits informatiques, 5770 Ambler Drive, Mississauga (Ontario) L4W 2T3, dans les soixante (60) jours suivant la date d'achat original. Joignez à votre envoi une pièce justificative de votre achat et une description du problème.

Recours – La responsabilité de PCI - et votre seul recours - dans le cas de toute défaillance couverte par la garantie sur ce support de logiciel est limitée au seul remplacement du support. Elle ne couvre aucun autre dommage, y compris, mais non exclusivement, la perte d'usage ou de profits, ni aucun dommage spécial, indirect ou consécutif, ni aucune autre réclamation de nature similaire ou autre.

Produits non couverts – La présente garantie limitée ne s'applique pas si la ou les disquettes ou autre support ont été utilisés dans un produit d'une marque autre que Panasonic ou dans des conditions environnementales autres que celles spécifiées par PCI ou le fabricant, ou soumis à une mauvaise utilisation, à la négligence, à une manutention inadéquate ou encore si le programme a été modifié ou subi une tentative de modification ou des dommages attribuables à un accident ou à un cas fortuit. De plus, PCI n'assume aucune responsabilité pour toute perte de, ou tout dommage à, un programme, des données ou un support de sauvegarde amovible.

GÉNÉRALITÉS

PCI NE RECONNAÎT AUCUNE AUTRE GARANTIE, EXPLICITE OU IMPLICITE, Y COMPRIS, MAIS NON EXCLUSIVEMENT, LES GARANTIES IMPLICITES DE VALEUR COMMERCIALE ET D'UTILITÉ À UNE FIN QUELCONQUE, À L'ÉGARD DU LOGICIEL, SUPPORTS DE LOGICIELS, PRODUITS INFORMATIQUES, PÉRIPHÉRIQUES ET ACCESSOIRES.

SOUS AUCUNE CIRCONSTANCE PCI NE POURRA ÊTRE TENUE RESPONSABLE DES DOMMAGES SPÉCIAUX, INDIRECTS OU CONSÉCUTIFS ATTRIBUABLES À UN MANQUEMENT AUX GARANTIES LIMITÉES DÉCRITES DANS LE PRÉSENT DOCUMENT OU À L'UTILISATION DU PRODUIT INFORMATIQUE, Y COMPRIS, SANS RESTRICTION, LA PERTE DE DONNÉES, D'AFFAIRES, D'ACHALANDAGE OU DE PROFIT.

DANS TOUS LES CAS, LA RESPONSABILITÉ MAXIMALE DE PCI POUR TOUT MANQUEMENT NE POURRA EXCÉDER LE PRIX DE VENTE DU PRODUIT INFORMATIQUE.

AUCUNE RÉCLAMATION, SANS ÉGARD À SES MOTIFS, NE POURRA ÊTRE FAITE AUPRÈS DE PCI PLUS DE DEUX (2) ANS APRÈS LES FAITS INVOQUÉS À LA BASE D'UNE TELLE RÉCLAMATION.

Garantie statutaires – Certaines juridictions interdisent de telles limitations ou exclusions; aussi, pourraient-elles ne pas s'appliquer.



As an ENERGY STAR® Partner, Panasonic Corporation has determined that this product meets ENERGY STAR® guidelines for energy efficiency. By enabling available power management settings, Panasonic computers enter a low-power sleep mode after a period of inactivity, saving the user energy. To learn more about power management, please visit the web site:

www.energystar.gov/index.cfm?c=power_mgt.pr_power_management

Outline of the International ENERGY STAR® Office Equipment Program

The international ENERGY STAR® Office Equipment Program is an international program that promotes energy saving through the use of computers and other office equipment. The program backs the development and dissemination of products with functions that effectively reduce energy consumption. It is an open system in which business proprietors can participate voluntarily. The targeted products are office equipment such as computers, displays, printers, facsimiles, and copiers. Their standards and logos are uniform among participating nations.

For information about ENERGY STAR®, refer to the following web site:

Web Site: www.energystar.gov

22-M-1

Panasonic Solutions Company
3 Panasonic Way, Panazip 2F-5,
Secaucus, NJ 07094

Panasonic Canada Inc.
5770 Ambler Drive, Mississauga,
Ontario L4W 2T3

