

LED TV Monitor

User Manual

The colour and the appearance may differ depending on the product, and the specifications are subject to change without prior notice to improve the performance.



Table Of Contents

MAJOR SAFETY PRECAUTIONS

Before You Start	1-1
Care and Maintenance	1-2
Safety Precautions	1-3

INSTALLING THE PRODUCT

Package Contents	2-1
Installing the Stand	2-2
Removing the Stand	2-3
Connecting to a Computer	2-4
Using it as a TV	2-5
Connecting an HDMI cable	2-6
Connecting Using a HDMI to DVI Cable	2-7
Connecting a Component cable	2-8
Connecting AV Devices	2-9
Connecting a Scart cable	2-10
Connecting COMMON INTERFACE	2-11
Connecting to an Amplifier	2-12
Connecting Headphones	2-13
Kensington Lock	2-14

USING THE PRODUCT

Plug & Play Feature	3-1
Viewing the Control panel	3-2
Remote Control	3-3
Teletext Feature	3-4
Using the Screen Adjustment Menu (OSD: On Screen Display)	3-5
Media Play	3-6
Anynet+ (HDMI-CEC)	3-7
Installing the Device Driver	3-8
Standard Signal Mode Table	3-9

INSTALLING THE SOFTWARE

Natural Color	4-1
MultiScreen	4-2

TROUBLESHOOTING

Product Self-Diagnosis	5-1
Before Requesting Service	5-2
FAQ	5-3



MORE INFORMATION

Specifications	6-1
Power Saving Function	6-2
Contact SAMSUNG WORLDWIDE	6-3

1 Major Safety Precautions

1-1 Before You Start





Icons used in this manual

ICON	NAME	MEANING
	Caution	Indicates cases where the function may not work or the setting may be canceled.
	Note	Indicates a hint or tip to operate a function.

Using this Manual

- The contents of this manual are subject to change without prior notice for performance improvement.
- Make yourself fully aware of the safety precautions before using this product.
- If a problem occurs, refer to the 'Troubleshooting' section.

Licence

	<p>Manufactured under licence from Dolby Laboratories. Dolby and the double-D symbol are trademarks of Dolby Laboratories.</p>
	<p>DivX Certified to play DivX video up to HD 1080p, including premium content. ABOUT DIVX VIDEO: DivX® is a digital video format created by DivX, Inc. This is an official DivX Certified device that plays DivX video. Visit www.divx.com for more information and software tools to convert your files into DivX video. ABOUT DIVX VIDEO-ON-DEMAND: This DivX Certified® device must be registered in order to play DivX Video-on-Demand (VOD) content. To generate the registration code, locate the DivX VOD section in the device setup menu. Go to vod.divx.com with this code to complete the registration process and learn more about DivX VOD. Pat. 7,295,673; 7,460,688; 7,519,274</p>
	<p>Manufactured under licence under U.S. Patent #'s: 5,451,942; 5,956,674; 5,974,380; 5,978,762; 6,487,535 & other U.S. and worldwide patents issued & pending. DTS and the Symbol are registered trademarks, & DTS 2.0+ Digital Out and the DTS logos are trademarks of DTS, Inc. Product includes software. ©DTS, Inc. All Rights Reserved.</p>
	<p>TheaterSound, SRS and the  symbol are trademarks of SRS Labs, Inc. TheaterSound technology is incorporated under licence from SRS Labs, Inc.</p>

Open Source Licence Notice

In the case of using open source software, Open Source licences are available on the product menu.

Copyright Notice

Copyright ©2010 Samsung Electronics Co., Ltd. All Rights Reserved.

The copyright of this manual is reserved by Samsung Electronics, Co., Ltd.

The contents of this manual may not be partially or in whole reproduced, distributed or used in any form without the written permission of Samsung Electronics, Co., Ltd.

The SAMSUNG logo and SyncMaster are the registered trademarks of Samsung Electronics, Co., Ltd.

Microsoft, Windows and Windows NT are the registered trademarks of Microsoft Corporation.

VESA, DPM and DDC are the registered trademarks of the Video Electronics Standard Association.

All other trademarks mentioned herein belong to their respective companies.

1-2 Care and Maintenance

External Surface and Screen Maintenance

Clean the product with a soft dry cloth.

- Avoid cleaning the product with an inflammable substance such as benzene or thinner or with a wet cloth. This may result in a problem with the product.
- Avoid scratching the screen with your fingernails or a sharp object.
- Avoid cleaning the product by spraying water onto it. If water enters the product, it may result in fire, electric shock or a problem with the product.
- A white stain may be generated on the surface of the model if a supersonic humidifier is used near it.

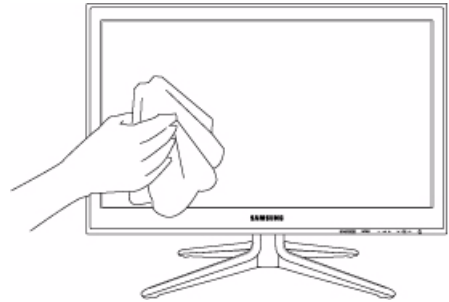

 The appearance and the colour may differ depending on models.

Securing the Installation Space

- Keep the required distances between the product and other objects (e.g. walls) to ensure proper ventilation. Failing to do so may result in fire or a problem with the product due to an increase in the internal temperature of the product.

 When using a stand or wall-mount, use parts provided by Samsung Electronics only.

- If you use parts provided by another manufacturer, it may result in a problem with the product or an injury due to the product falling.

 The appearance may differ depending on the product.

When installing the product with a stand

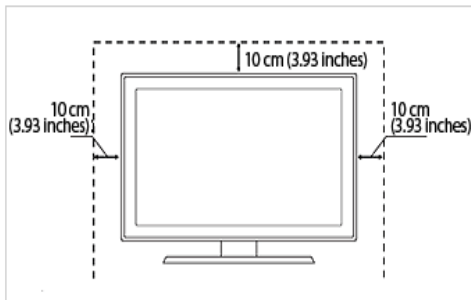

When installing the product with a wall-mount

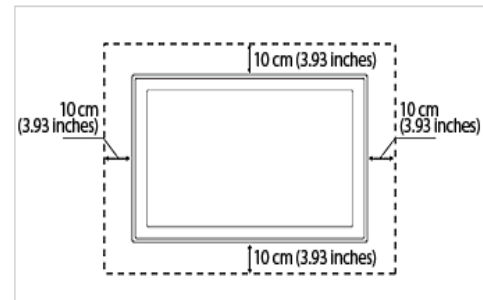

About persistent images

- Displaying a still image for a long time may create a persistent image or stain on the screen. If you do not use the product for a long time, set the power-saving mode or screen saver.
- Due to technological constraints of the Panel manufacturer, the images generated by this product may appear either brighter or darker than normal by appr. 1ppm (parts per million) pixel.

The number of sub-pixels of an panel by size: The number of Sub-Pixels = Max. Horizontal Resolution x Max. Vertical Resolution x 3

Example) If the maximum resolution is 1920 x 1080, the number of sub-pixels is 1920 x 1080 x 3 = 6,220,800.

1-3 Safety Precautions

Icons used for safety precautions

ICON	NAME	MEANING
	Warning	Failing to follow the precautions marked with this sign may result in a serious injury or even a fatality.
	Caution	Failing to follow the precautions marked with this sign may result in a personal injury or property damage.

Meaning of Signs



Do not perform.



Must be followed.



Do not disassemble.



The power plug must be unplugged from the wall outlet.



Do not touch.



Must be grounded to prevent electric shock.

Power Related

The following images are for your reference and may differ depending on models and countries.

Warning

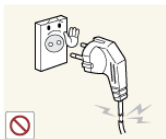

Avoid using a damaged power cord or plug or a loose power outlet.

- Otherwise, it may result in electric shock or fire.



Avoid connecting multiple electric appliances to a single wall outlet.

- Otherwise, it may result in fire due to overheating of the wall outlet.



Avoid plugging in or unplugging the power supply with wet hands.

- Otherwise, it may result in electric shock.

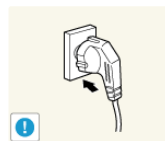

Plug the power plug in firmly.

- Otherwise, it may result in fire.



Make sure to connect the power cord to a grounded wall outlet (for insulation class 1 equipment only).

- Otherwise, it may result in electric shock or injury.



Avoid bending or twisting the power cord excessively and avoid placing heavy objects on the cord.

- Otherwise, it may result in electric shock or fire due to a damaged power cord.

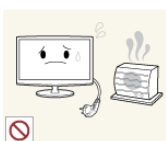

Keep the power cord and the product away from a heater.

- Otherwise, it may result in electric shock or fire.



If the pins of the power plug or the wall outlet are covered in dust, clean it using a dry cloth.

- Otherwise, it may result in fire.

Caution



Avoid unplugging the power plug while the product is operating.

- Otherwise, it may damage the product due to electric shock.

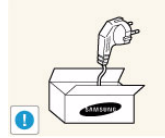

Make sure to use only the power cord supplied by our company. In addition, do not use the power cord of another electric appliance.

- Otherwise, it may result in electric shock or fire.

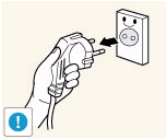

When unplugging the power plug from the wall outlet, make sure to hold it by the plug and not by the cord.

- Otherwise, it may result in electric shock or fire.



Connect the power plug to a wall outlet that can be easily reached.

- When a problem occurs with the product, you must unplug the power plug to cut the power off completely. You cannot cut the power off completely using only the power button on the product.

Installation Related

Warning



Avoid placing burning candles, mosquito-repellent or cigarettes on the product.

- Otherwise, it may result in fire.

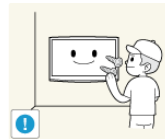

Ask an installation engineer or relevant company to install the product onto the wall.

- Otherwise, it may result in injury.
- Make sure to use the specified wall mount.



Avoid installing the product in a badly-ventilated location such as inside a bookshelf or closet.

- Otherwise, it may result in fire due to internal over-heating.

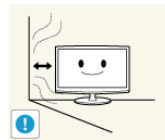

Keep a distance of at least 10 cm (3.93 inches) from the wall when installing the product for ventilation.

- Otherwise, it may result in fire due to internal over-heating.

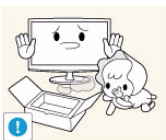

Keep the plastic bags used to pack the product away from children.

- If children place the plastic bags over their heads, they may suffocate.



Avoid installing the product in a location that is unstable or exposed to excessive vibration such as on an unstable or slanted shelf.

- The product may fall and this may result in damage to the product or injury.
- If you use the product in a location exposed to excessive vibrations, it may result in a problem with the product or fire.

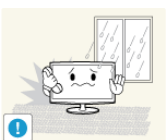

Avoid installing the product in a location exposed to dust, moisture (sauna), oil, smoke or water (rain drops) and installing it within a vehicle.

- This may result in electric shock or fire.

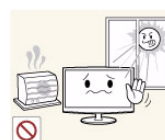

Avoid installing the product in a location exposed to direct sunlight and installing the product near a heat source such as a fireplace or heater.

- This may shorten the product life cycle or cause fire.



Avoid installing the product where children may reach it.

- If a child touches the product, the product may fall and this may result in injury.
- Since the front part is heavier, install the product on a flat and stable surface.



Bend the outdoor antenna cable downwards at the location where it comes in the house so that rainwater does not flow in.

- If rainwater enters the product, it may result in electric shock or fire.



Install the antenna far away from any high voltage cables.

- If the antenna touches or falls onto a high voltage cable, it may result in electric shock or fire.

Caution



Do not let the product drop while moving it.

- This may result in a problem with the product or injury.

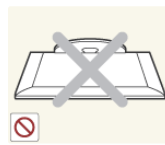

Do not place the product face down on the floor.

- This may damage the panel of the product.



When installing the product on a console or shelf, make sure that the front of the product does not protrude out of the console or shelf.

- Otherwise, this may cause the product to fall off and result in a malfunction or injury.
- Make sure to use a cabinet or shelf suitable to the size of the product.



When putting the product down, handle it gently.

- Otherwise, it may result in a problem with the product or injury.



If the product is installed in a location where the operating conditions vary considerably, a serious quality problem may occur due to the surrounding environment. In this case, install the product only after consulting one of our service engineers about the matter.

- Places exposed to microscopic dust, chemicals, too high or low temperature, high humidity, airports or stations where the product is continuously used.

Cleaning Related

Warning



Before cleaning the product, unplug the power cord.

- Otherwise, it may result in electric shock or fire.

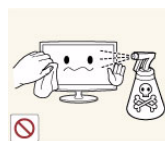

When cleaning the product, do not spray water directly over the product parts.

- Make sure that water does not enter the product.
- Otherwise, it may result in fire, electric shock or a problem with the product.

Caution



Avoid spraying cleansing agent directly onto the product.

- This may result in discoloration or cracking of the exterior of the product or the panel coming off.



When cleaning the product, disconnect the power cord and clean the product with the supplied cleaning cloth.

- Avoid using chemicals such as wax, benzene, alcohol, thinner, mosquito-repellent, fragrance, lubrication or cleansing agent when cleaning the product.
This may result in the exterior being deformed or the print being removed.

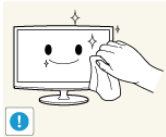

If you can't get the product clean with just the supplied cloth, use a soft, damp cloth with a "monitor-exclusive cleansing agent" and wipe the product with it.

- If no monitor-exclusive cleansing agent is available, dilute a cleansing agent with water at a ratio of 1:10 before cleaning the product.



Since the exterior of the product is easily scratched, be sure to use the supplied cleansing cloth.

Usage Related

Warning



Since a high voltage runs through the product, never disassemble, repair or modify the product yourself.

- Otherwise, it may result in fire or electric shock.
- If the product needs to be fixed, contact a service centre.



To move the product, turn the power off and unplug the power cord, the antenna cable and any other wires connected to the product.

- Otherwise, it may result in electric shock or fire due to the damaged power cord.



If the product generates a strange noise, a burning smell, or smoke, unplug the power plug immediately and contact a service centre.

- Otherwise, it may result in electric shock or fire.

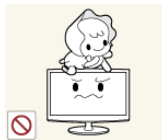

Avoid letting children hang or climb onto the product.

- Otherwise, it may result in the product falling and this may result in injury or death.



If you drop the product or the case is damaged, turn the power off and unplug the power cord. Contact a service centre.

- Otherwise, it may result in fire or electric shock.



Avoid placing objects such as toys and cookies on top of the product.

- If a child hangs over the product to grab an object, the object or the product may fall and this may result in injury or even death.

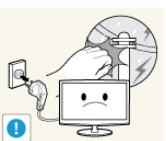

When thunder or lightning occurs, unplug the power cord and under no circumstance touch the antenna cable as this is dangerous.

- Otherwise, it may result in electric shock or fire.



Avoid dropping an object over the product or cause impact to the product.

- Otherwise, it may result in electric shock or fire.



Avoid moving the product by pulling the power cord or antenna cable.

- Otherwise, it may result in electric shock, fire or a problem with the product due to damage to the cable.



When a gas leak occurs, do not touch the product or the power plug and ventilate immediately.

- A spark may result in an explosion or fire.
- During a thunder or lightning storm, do not touch the power cord or antenna cable.

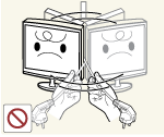

Avoid lifting up or moving the product by holding only the power cord or signal cable.

- Otherwise, it may result in electric shock, fire or a problem with the product due to damage to the cable.



Avoid using or placing inflammable spray or objects near the product.

- This may result in an explosion or fire.



Take care not to block the vent by a table cloth or curtain.

- Otherwise, it may result in fire due to internal overheating.



Avoid inserting metal objects such as a chopsticks, coins or hairpins, or inflammable objects into the product (the vents, ports, etc).

- If water or substances enters the product, turn the power off, unplug the power cord and contact a service centre.
- Otherwise, it may result in a problem with the product, electric shock or fire.



Avoid placing a liquid container such as a vase, flowerpot, beverage, cosmetics or drugs, or a metal object over the product.

- If water or substances enter the product, turn the power off, unplug the power cord and contact a service centre.
- Otherwise, it may result in a problem with the product, electric shock or fire.

Caution



Displaying a still image for a long time may create a persistent image or stain on the screen.

- If you do not use the product for a long time, use the power-saving mode or set the screensaver to the moving picture mode.

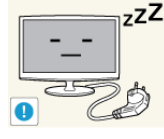

When not using the product for a long time such as leaving your home, unplug the power cord from the wall outlet.

- Otherwise, it may cause dust accumulation and result in fire caused by overheating or short circuit or result in an electric shock.



Set the appropriate resolution and frequency for the product.

- Otherwise, it may result in eye strain.



Avoid turning the product upside down or move the product holding only the stand.

- This may cause the product to fall, resulting in damage to the product or injury.



Do not place the adapter on top of another adapter.

- Otherwise, it may result in fire.



Keep power adaptor away from any other heat source.

- Otherwise, it may result in fire.



Remove the vinyl cover of the adaptor before using the adaptor.

- Otherwise, it may result in fire.

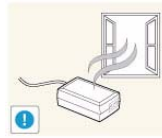

Always keep power adaptor in well-ventilated area.



Be careful that adaptor should not be in contact with water and therefore not be wet.

- This may cause a malfunction, electric shock or fire. Do not use adaptor by the waterside or outside particularly when it rains or snows. Be careful that adaptor should not be wet while cleaning floor with water.

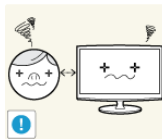

Watching the product from too close a distance continuously may damage your eyesight.



Avoid using a humidifier or cooker near the product.

- Otherwise, it may result in electric shock or fire.

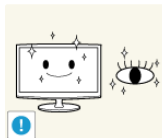

It is important to give your eyes some rest (5 minutes every hour) when viewing the product screen for long periods of time.

- This will alleviate any eye strain.



Since the display panel is hot after using it for a long time, do not touch the product.



Keep the small accessories in a location out of the reach of children.



Take care when adjusting the angle of the product or the height of the stand.

- If your hand or finger is caught, you may be injured.
- If the product is tilted excessively, the product may fall and this may result in injury.



Avoid placing a heavy object over the product.

- Otherwise, it may result in a problem with the product or injury.



When using headphones or earphones, do not turn the volume too high.

- Having the sound too loud may damage your hearing.



Be careful that children do not place the batteries in their mouths when removed from the remote control. Place the battery in a location that children or infants cannot reach.

- If children have had the battery in their mouths, consult your doctor immediately.

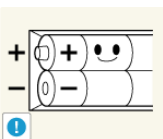

When replacing the batteries, insert them with right polarity (+, -).

- Otherwise, the battery may become damaged or it may cause fire, personal injury or damage due to leakage of the internal liquid.

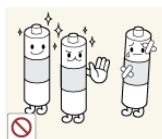

Use only specified standard batteries. Do not use new and used batteries together.

- This may cause a battery to break or leak and may cause fire, injury, or contamination (damage).

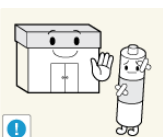

The batteries (and rechargeable batteries) are not ordinary refuse and must be returned for recycling purposes. The customer is responsible for returning the used or rechargeable batteries for recycling.

- The customer can return used or rechargeable batteries to a nearby public recycling centre or to a store selling the same type of the battery or rechargeable battery.

Maintaining the Correct Posture when Using this Product













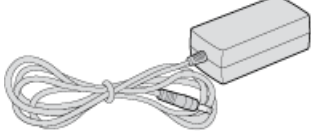

Maintain the correct posture when using this product.

- Straighten your back.
- Keep a distance of 45~50 cm (15~19 inches) from your eyes to the screen. Look down at the screen and face the screen forwards.
- Adjust the angle of the product so that light is not reflected onto the screen.
- Keep your elbow at a right angle and keep your arm level with the back of your hand.
- Keep your elbow at a right angle.
- Place your heels flat on the ground while keeping your knees at an angle of 90 degrees or higher and maintain the position of your arm so that your arm is below your heart.

2 Installing the Product

2-1 Package Contents

- Unpack the product and check if all of the following contents have been included.
- Store the packaging box in case you need to move the Product later.
- If any items are missing, contact your dealer.
- Contact a local dealer to purchase optional items.

CONTENTS			
			
Quick Setup Guide	Warranty Card (Not available in all locations)	User Manual	DC-Adapter
			
Power Cord	D-Sub Cable	Stereo Cable	Stand & Screw (2EA)
			
Remote Control / Batteries (AAA X 2)	Scart Adapter	AV Adapter	Component Adapter
			
Cleaning Cloth	Cable Holder		
SOLD SEPARATELY			
			
HDMI Cable	HDMI to DVI Cable	Audio Adapter	

- The colour and the appearance may differ depending on the product, and the specifications are subject to change without prior notice to improve the performance.
- The cleaning cloth is supplied with black high-glossy models only.

2-2 Installing the Stand

- Before assembling the product, place the product down on a flat and stable surface so that the screen is facing downwards.



Place a soft cloth over the table to protect the product and place the product onto the cloth face down.

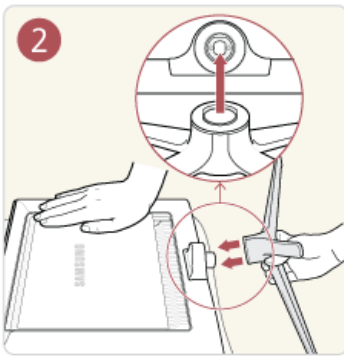

Insert the stand base into the stand as shown in the figure.

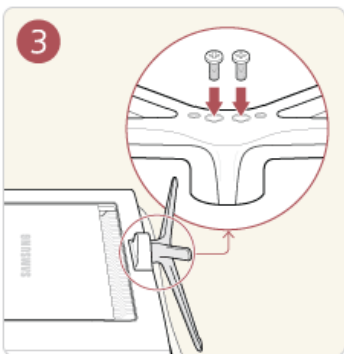

Firmly fasten the stand using the screws.



- Caution
Do not lift the product by only its stand.

- The colour and the appearance may differ depending on the product, and the specifications are subject to change without prior notice to improve the performance.

2-3 Removing the Stand

Before removing the stand, place the product down on a flat and stable surface so that the screen faces downwards.

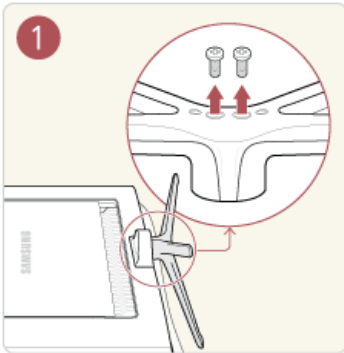

Place a soft cloth over the table to protect the product and place the product face down. Remove the screws from the bottom of the stand.

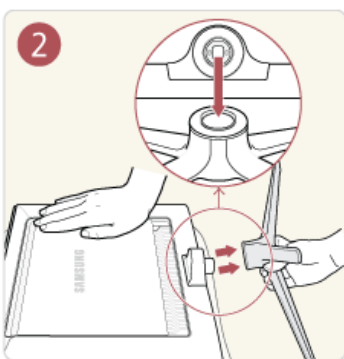

Pull the stand from the stand base to remove.

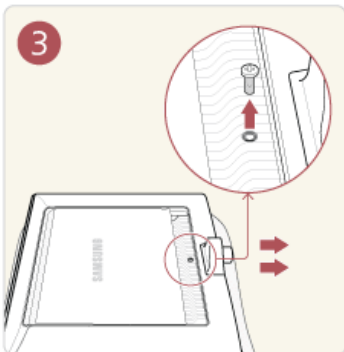

Before you attach the bracket, unfasten the screw and remove the stand base.



After the stand base is removed, you can attach the bracket to the product.

- If you want to purchase this Wall Mount, contact an authorized dealer.
- The Wall mount of this model is only supported as WMN-2490.
- The wall mount kit is not supplied, but sold separately.

The colour and the appearance may differ depending on the product, and the specifications are subject to change without prior notice to improve the performance.

2-4 Connecting to a Computer

1. 1. Connect the product to a PC depending on the video output supported by the PC.

 The connecting part may differ depending on the product model.

- When the graphics card provides a D-Sub <Analogue> output
 - Connect the [PC IN] port of the product to the D-Sub port of the PC with the D-Sub cable.

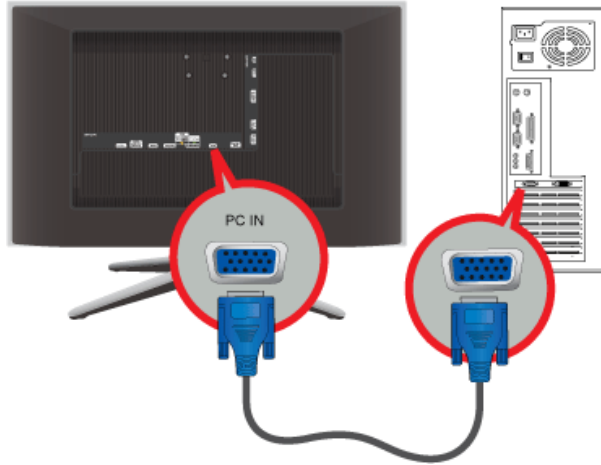

- When the graphics card provides a DVI <Digital> output
 - Connect the [HDMI IN 1, 2 (DVI)] port of the product to the DVI port of the PC with the HDMI to DVI cable.

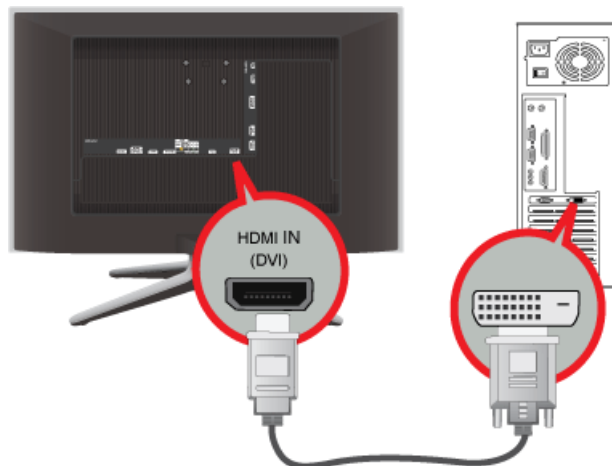

- When the graphics card provides a HDMI output
 - Connect the [HDMI IN 1, 2 (DVI)] port of the product to the HDMI port of the PC with the HDMI cable.

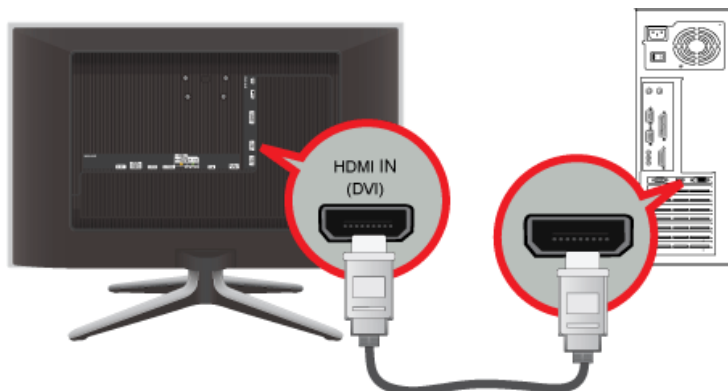

 When a PC with a resolution of 1920 x 1080 @ 60 Hz is connected to the [HDMI IN 1, 2 (DVI)]port, you should set the <HDMI> mode to <DVI PC> in the <Edit Name> of the <Input> mode. In this case, a separate sound connection is required.

2. Connect the [PC / DVI AUDIO IN] port on the rear side of the product to the sound card of the PC.

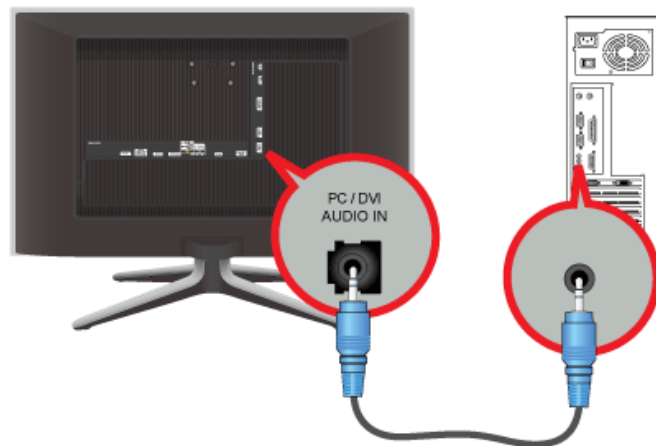

3. Connect the power adapter to [DC 14V] on the rear of the product. Connect the power cord to the adapter and wall socket. (The input voltage is switched automatically.)

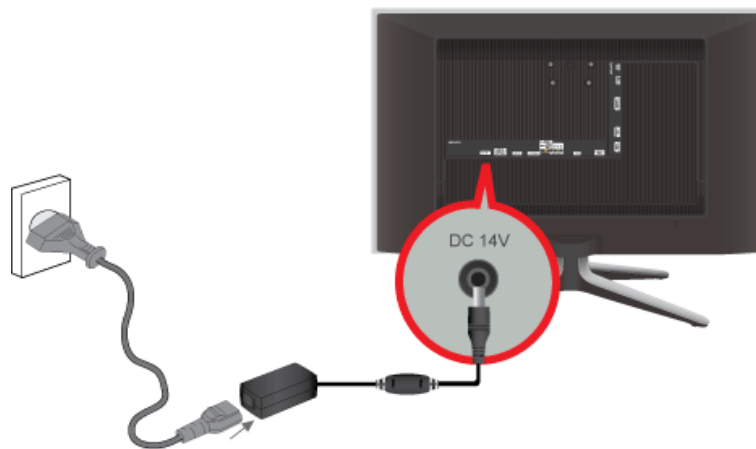

- You may enjoy clear and quality sound from the computer sound card using the product's speakers. (You don't need to install separate speakers for your computer.)

2-5 Using it as a TV

You may view television programs on the product if it is connected to an antenna or cable system without installing any separate TV reception hardware or software on your computer.

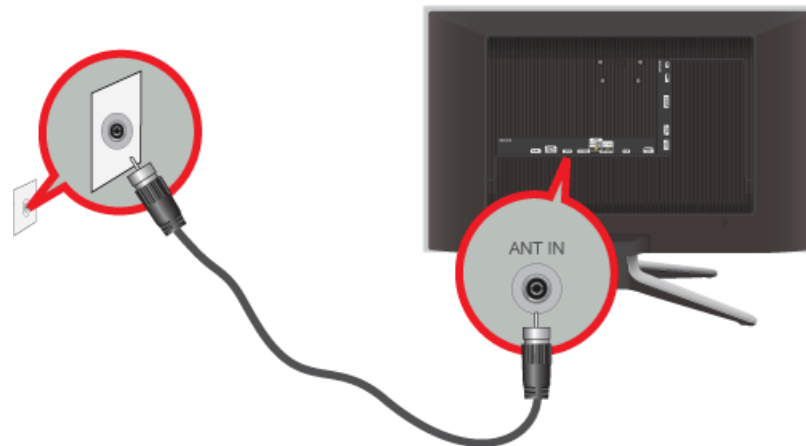

1. Connect the cable or TV antenna cable to the [ANT IN] port on the rear side of the product.
 - When using an indoor antenna/cable terminal:
Check the antenna terminal on the wall and then connect the antenna/cable TV cable.
 - When using an outdoor antenna:
When using an outdoor antenna, we strongly suggest using a qualified technician to install it.
2. When the connections are completed, connect the TV power.
3. When the product is turned on for the first time after it was purchased, the initial setup operations <Plug&Play> begin.

 Be careful that the coaxial cable is not bent when connecting it to the antenna input terminal [ANT IN].

Digital TV notice

- Functionalities related to Digital TV (DVB) are only available in countries/areas where DVB-T (MPEG2 and MPEG4 AVC) digital terrestrial signals are broadcasted or where you are able to access to a compatible DVB-C (MPEG2 and MPEG4 AAC) cable-TV service. Please check with your local dealer the possibility to receive DVB-T or DVB-C signal.
- DVB-T is the DVB European consortium standard for the broadcast transmission of digital terrestrial television and DVB-C is that for the broadcast transmission of digital TV over cable. However, some differentiated features like EPG (Electric Programme Guide), VOD (Video On Demand) and so on, are not included in this specification. So, they cannot be workable at this moment.
- Although this TV set meets the latest DVB-T and DVB-C standards, as of [August, 2008], the compatibility with future DVB-T digital terrestrial and DVB-C digital cable broadcasts cannot be guaranteed.
- Depending on the countries/areas where this TV set is used some cable-TV providers may charge an additional fee for such a service and you may be required to agree to terms and conditions of their business.
- Some Digital TV functions might be unavailable in some countries or regions and DVB-C might not work correctly with some cable service providers.
- For more information, please contact your local Samsung customer care centre.
 - The reception quality of TV may be affected due to differences in broadcasting method between the countries. Please check the TV performance in the local SAMSUNG Authorized Dealer, or the Samsung Call Centre whether it can be improved by reconfiguring TV setting or not.

Standby mode

Do not leave your TV in standby mode for long periods of time (when you are away on a holiday, for example). A small amount of electric power is still consumed even when the power button is turned off. It is best to unplug the power cord.

2-6 Connecting an HDMI cable

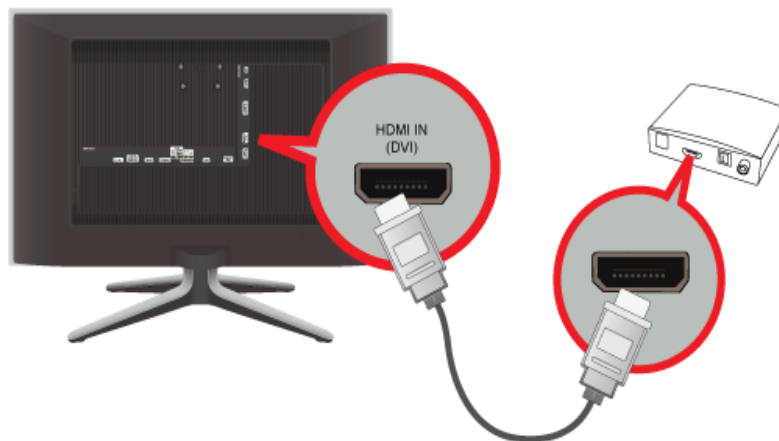

1. Connect the HDMI OUT port of the AV device (Blu-ray/DVD/Cable/Satellite box) to the [HDMI IN 1, 2 (DVI)] terminal of the product using the HDMI cable.
2. Press the [SOURCE] button at the front of the product or on the remote control to select <HDMI> mode.

 You do not need to make a separate audio connection when connecting via HDMI.

2-7 Connecting Using a HDMI to DVI Cable

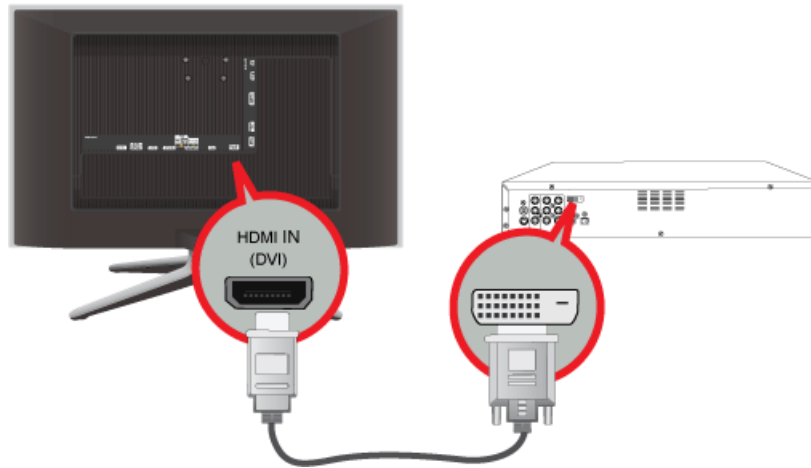

1. Connect the DVI output terminal of an external device to the [HDMI IN 1, 2 (DVI)] terminal of the product using a HDMI to DVI cable.

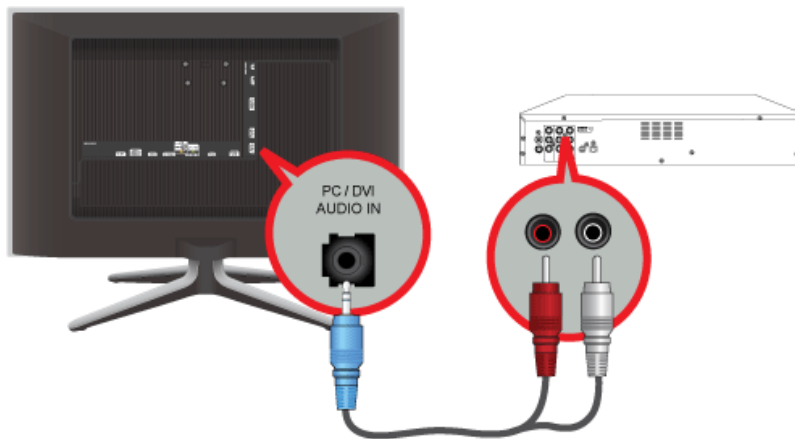

2. Connect the red and white plugs of an RCA to stereo (for PC) cable to the same coloured audio output terminals of the digital output device, and connect the opposite plug to the [PC / DVI AUDIO IN] terminal of the product. Press the [SOURCE] button at the front of the product or on the remote control to select <HDMI> mode.

2-8 Connecting a Component cable

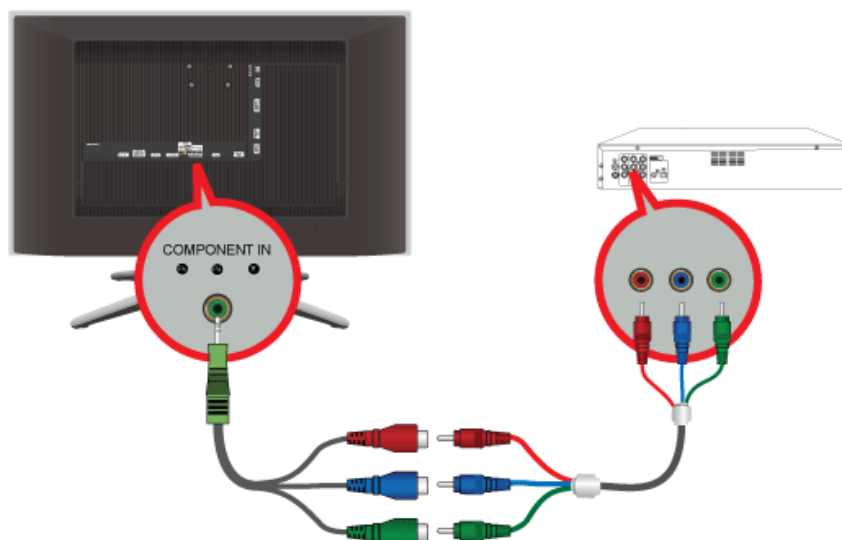

1. Connect the component adapter to [COMPONENT IN] on the rear of the product.
2. Connect the component cable to the corresponding matching colours on the component adapter and AV device.

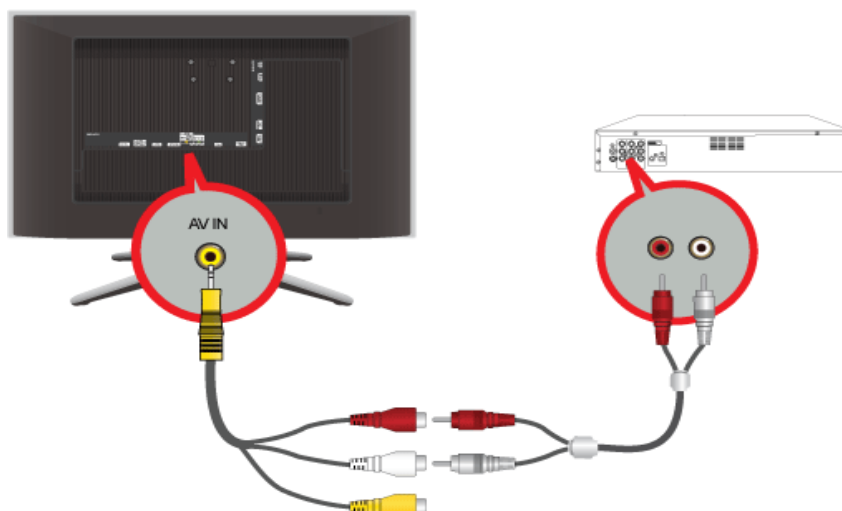

3. Connect the audio adapter to [AV IN] on the rear of the product.
4. Connect the audio cable to the corresponding matching colours on the audio adapter and AV device.
5. Press the [SOURCE] button at the front of the product or on the remote control to select the <Component> mode.

 For an explanation of Component video, consult your DVD/VCR/Cable/Satellite box manual.

2-9 Connecting AV Devices

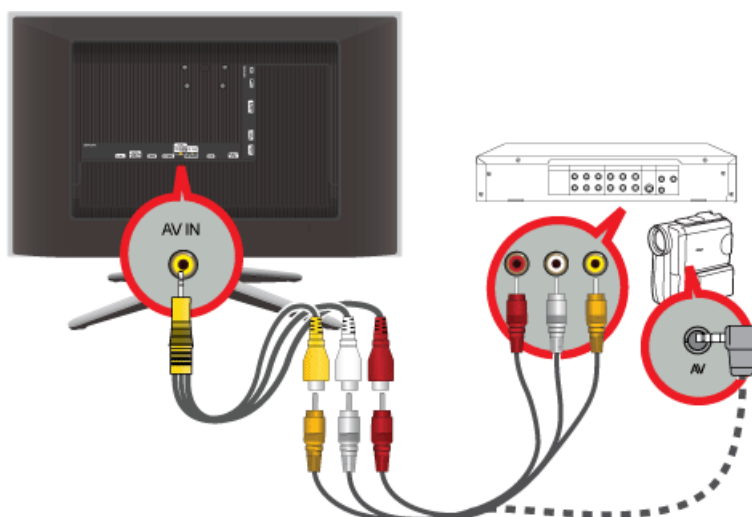

1. Connect the AV adapter to [AV IN] on the rear of the product.
2. Connect the audio-and-video cable to the corresponding matching colours on the AV adapter and AV device.
3. Press the [SOURCE] button at the front of the product or on the remote control to select the <AV> mode.

 The audio-video cables shown here are usually included with a Camcorder. (If not, check your local electronics store.)

2-10 Connecting a Scart cable

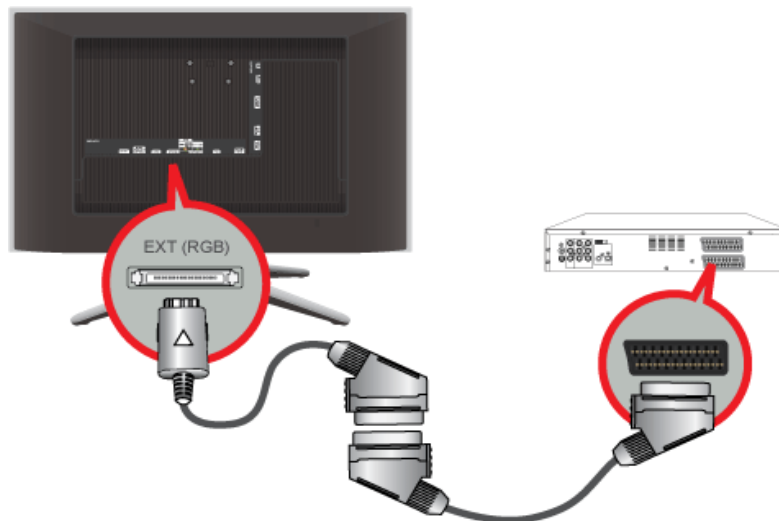

1. Connect the Scart adapter to [EXT (RGB)] on the rear of the product.
 2. Connect the Scart cable to the Scart adapter and AV device.
 3. Press the [SOURCE] button at the front of the product or on the remote control to select the <Ext.> mode.
- Connect to the DVD Devices input if the device has a [EXT [RGB]] jack.
 - You can watch DVD simply by hooking up the DVD player with the product as long as the power is on.

2-11 Connecting COMMON INTERFACE

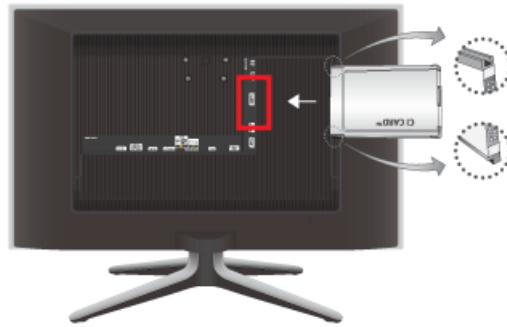

To watch paid channels, the “CI or CI+ CARD” must be inserted.

- If you don't insert the "CI or CI+ CARD," some channels will display the message "Scrambled Signal".
 - The pairing information containing a telephone number, the "CI or CI+ CARD" ID the Host ID and other information will be displayed in about 2~3 minutes. If an error message is displayed, please contact your service provider.
 - When the configuration of channel information has finished, the message "Updating Completed" is displayed, indicating the channel list is updated.
-  • You must obtain a "CI or CI+ CARD" from a local cable service provider.
- When removing the "CI or CI+ CARD", carefully pull it out with your hands since dropping the "CI or CI+ CARD" may cause damage to it.
 - Insert the "CI or CI+ CARD" in the direction marked on the card.
 - The location of the COMMON INTERFACE slot may be different depending on the model.
 - "CI or CI+ CARD" is not supported in some countries and regions; check with your authorized dealer.
 - If you have any problems, please contact a service provider.
 - Insert the “CI or CI+ CARD” that supports the current antenna settings. The screen will be distorted or will not be seen.

2-12 Connecting to an Amplifier

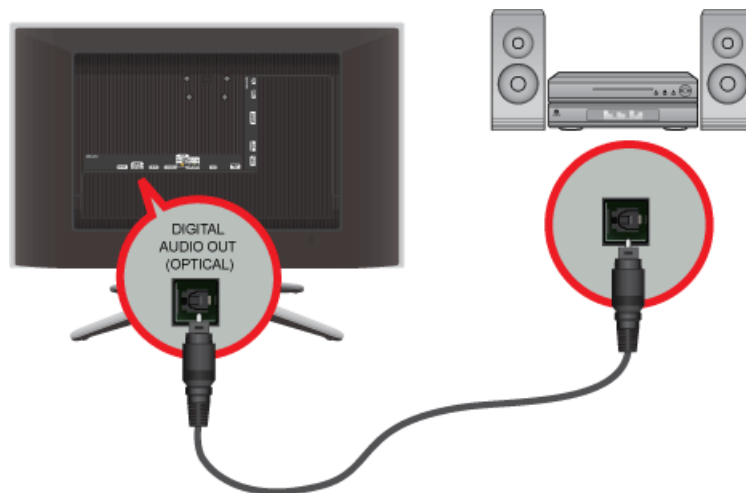

- Connect the [DIGITAL AUDIO OUT (OPTICAL)] terminal of your product to the optical input of your amplifier using an optical cable.
- 🔧 • If no sound is emitted from the product, you need to use an amplifier.
- For information on how to connect a speaker and amplifier, refer to the respective user manuals provided by their manufacturers.

2-13 Connecting Headphones

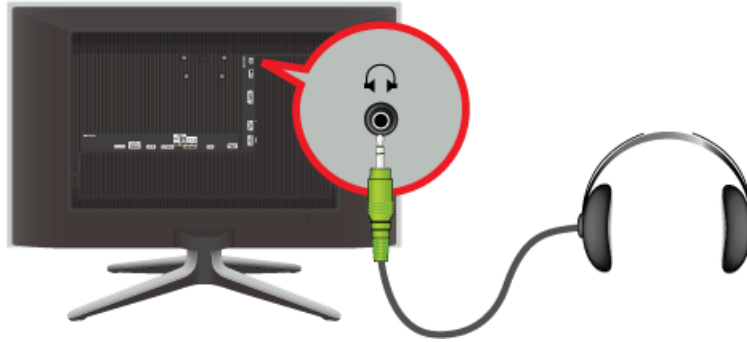

- Connect your headphones to the Headphone connection terminal.

2-14 Kensington Lock

A Kensington Lock is an anti-theft device that enables users to lock the product so that they can safely use it in public locations. Since the shape and usage of the locking device may differ depending on the model and the manufacturer, for more information, refer to the User Manual supplied with the locking device for more information.

 You must purchase the Kensington Lock separately.

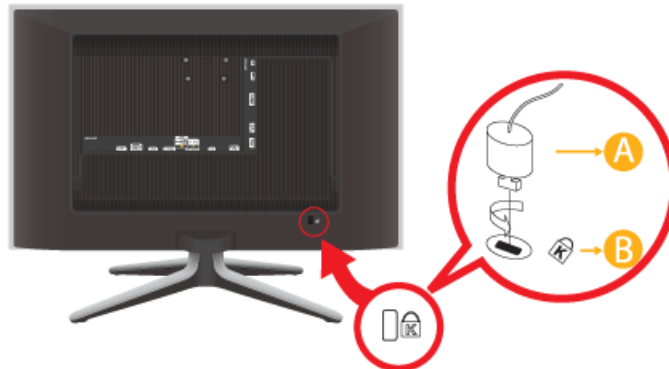

To lock the product, follow these steps:

1. Wrap the Kensington lock cable around a large, stationary object such as a desk or chair.
2. Slide the end of the cable with the lock attached through the looped end of the Kensington lock cable.
3. Insert the locking device into the Kensington slot on the product (**B**).
4. Lock the lock (**A**).

-  • These are general instructions. For exact instructions, see the User Manual supplied with the locking device.
- You can purchase the locking device from an electronics store, an online shop, or our service centre.

3 Using the Product

3-1 Plug & Play Feature

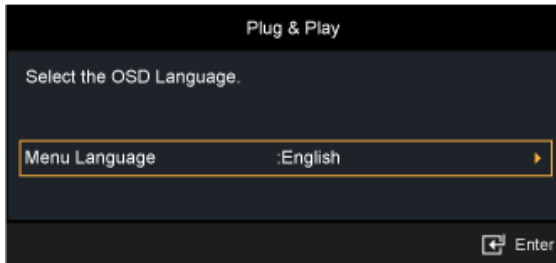

When the TV is initially powered on, basic settings proceed automatically and subsequently.

 To return to the previous step, press the Red button.

1. Press the [POWER] button on the remote control.

-  You can also use the [] button on the TV.
- The message <Select the OSD Language>. is displayed.

2. Press the [] button. Select the appropriate language by pressing the ▲ or ▼ button.
Press the [] button to confirm your choice.

3. Press the ◀ or ▶ button to select <Store Demo> or <Home Use>, then the [] button.

-  We recommend setting the TV to <Home Use> mode for the best picture in your home environment.
- <Store Demo> mode is only intended for use in retail environments. If the unit is accidentally set to <Store Demo> mode and you want to return to <Home Use> (Standard): Press the volume button on the TV. When the volume OSD is displayed, press and hold the [MENU] button on the TV for 5 seconds.

4. Press the [] button.

Select the appropriate country by pressing the ▲ or ▼ button. Press the [] button to confirm your choice

5. Press the [] button.

Press the ▲ or ▼ button to select <Air> or <Cable>, then press the [] button.

-  <Air> : <Air> antenna signal.
- <Cable> : <Cable> antenna signal.

6. Press the ▲ or ▼ button to select the channel source to memorise.

Press the ▼ button to select <Search>, then press the [] button.

-  When setting the antenna source to <Cable>, a step appears allowing you to set a value for the digital channel search. For more information, refer to <Channel> → <Auto Store>.
- <Digital & Analogue>: Digital and Analogue channels.
- <Digital>: Digital channels.
- <Analogue>: Analogue channels.
- The channel search will start and end automatically.
- Press the [] button at any time to interrupt the memorisation process.
- After all the available channels are stored, the message <Set the Clock Mode> is displayed.

7. Press the [] button.

Press the ▲ or ▼ button to select <Auto>, then Press the [] button.

-  If you select <Manual>, <Set current date and time> is displayed.

- If you have received a digital signal, the time will be set automatically. If not, select <Manual> to set the clock.
8. The description for the connection method providing the best HD screen quality is displayed. Check the description and press the [ENTER] button.
 9. The message <Enjoy your TV.> is displayed. When you have finished, press the [ENTER] button.

If you want to reset this feature...

1. Press the [MENU] button to display the menu. Press the ▲ or ▼ button to select <Setup>, then press the [ENTER] button.
2. Press the [ENTER] button again to select <Plug & Play>.
3. Enter your 4 digit PIN number.
The default PIN number of a new TV set is 0-0-0-0. You can change the PIN by selecting <Change PIN> from the menu.

 The <Plug & Play> feature is only available in the <TV> mode.

3-2 Viewing the Control panel

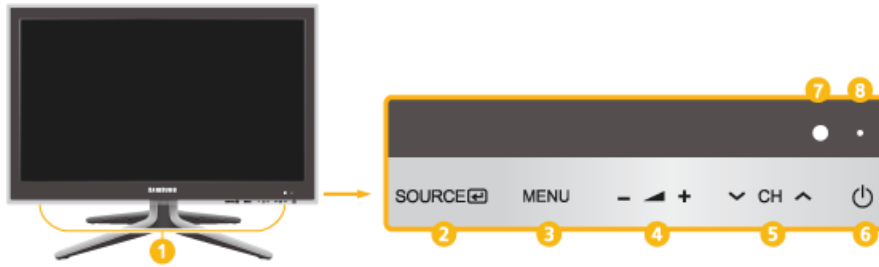

NUMBER	ICON	DESCRIPTION
1	Speaker	-
2	SOURCE	Toggles between all the available input sources. In the on-screen menu, use this button as you would use the [] button on the remote control.
3	MENU	Press this button to view the On Screen Display (OSD). This button is also used to exit the OSD or to return to a higher-level OSD menu.
4		Moves from one menu item to another horizontally or adjusts selected menu values. Adjusts the audio volume.
5		Use these buttons to navigate the menu or to adjust a value in the OSD. Press to change channels in <TV> mode.
6		Press this button to turn the product on or off.
7	Remote control sensor	Aim the remote control towards this spot on the TV.
8	Power Indicator	-

Installing Batteries in the Remote Control

1. Lift the cover at the back of the remote control upward as shown in the figure.

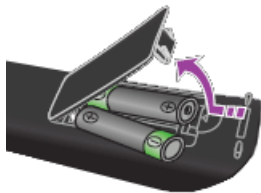

2. Install two AAA size batteries.

 Make sure to match the + and - ends of the batteries with the diagram inside the compartment.

3. Close the cover.

 Remove the batteries and store them in a cool, dry place if you won't be using the remote control for a long time.

If the remote control doesn't work, check the following :

- Is the TV power on?
- Are the plus and minus ends of the batteries reversed?
- Are the batteries drained?
- Is there a power outage or is the power cord unplugged?
- Is there a special fluorescent light or neon sign nearby?

3-4 Teletext Feature

Most television stations provide written information services via Teletext. The index page of the teletext service gives you information on how to use the service. In addition, you can select various options to suit your requirements by using the remote control buttons.

- For teletext information to be displayed correctly, channel reception must be stable. Otherwise, information may be missing or some pages may not be displayed.

You can change teletext pages by pressing the numeric buttons on the remote control.

- 1**  (teletext on/mix)
Press to activate teletext mode after selecting the channel providing the teletext service. Press it twice to overlap the teletext with the current broadcasting screen.

- 2**  (index)
Used to display the index (contents) page at any time while you are viewing teletext.



- 3**  (size)
Press to display the double-size letters in the upper half of the screen. For lower half of the screen, press it again. To display normal screen, press it once again.

- 4**  (hold)
Used to hold the display on a given page if the selected page is linked with several secondary pages which follow on automatically. To resume, press it again.

- 5** Colour buttons (red / green / yellow / blue)
If the FASTEXT system is used by a broadcasting company, the different topics covered on a teletext page are colour-coded and can be selected by pressing the coloured buttons.

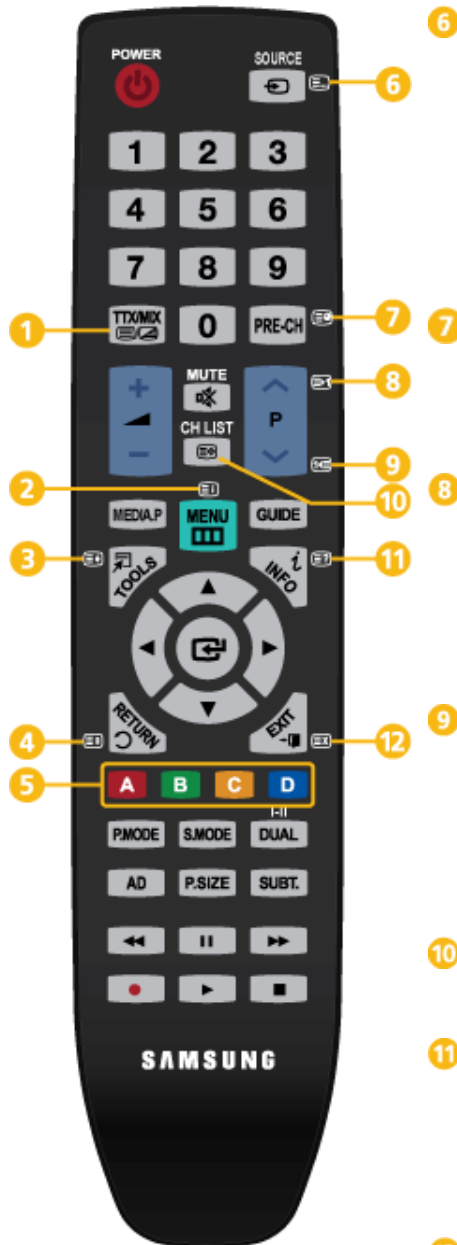
Press one of them corresponding to the required. The page is displayed with other coloured information that can be selected in the same way. To display the previous or next page, press the corresponding coloured button.





- 6**  (mode)
Press to select the teletext mode (LIST/FLOF). If you press it in the LIST mode, it switches into the List save mode. In the List save mode, you can save teletext page into list using the  (store) button.

- 7**  (sub-page)
Used to display the available sub-page.

- 8**  (page up)
Used to display the next teletext page.

- 9**  (page down)
Used to display the previous teletext page.

- 10**  (store)
Used to store the teletext pages.

- 11**  (reveal)
Used to display the hidden text (answers to quiz games, for example). To display normal screen, press it again.

- 12**  (cancel)
Used to display the broadcast when searching for a page.

Typical Tetetext page

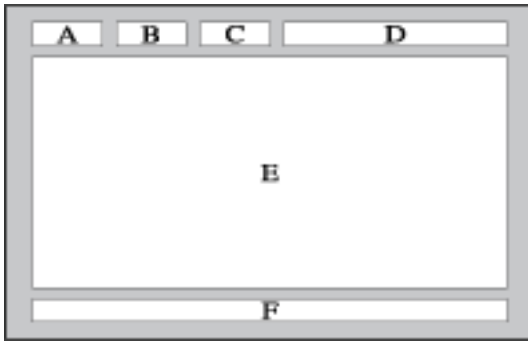

PART	CONTENTS
A	Selected page number.
B	Broadcasting channel identity.
C	Current page number or search indications.
D	Date and time.
E	Text.
F	Status information. FASTEXT information.

3-5 Using the Screen Adjustment Menu (OSD: On Screen Display)



The Screen Adjustment Menu (OSD: On Screen Display) Structure



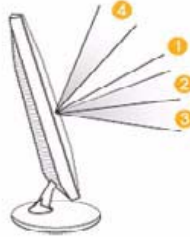
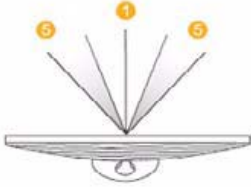

TOP MENUS	SUB MENUS				
Picture [PC / HDMI PC Timing]	MagicBright	MagicAngle	Contrast	Brightness	Sharpness
	Eco Solution	Auto Adjustment	Screen	Picture Options	Picture Reset
Picture [TV / Ext. / AV / Component / HDMI1 / HDMI2]	Mode	MagicAngle	Backlight	Contrast	Brightness
	Sharpness	Colour	Tint (G/R)	Eco Solution	Advanced Settings
	Picture Options	Picture Reset			
Sound	Mode	Equalizer	Virtual Surround	Dialog Clarity	Audio Language
	Audio Format	Audio Description	Auto Volume	Speaker Select	Additional Setting
	Sound Reset				
Channel	Antenna	Country	Auto Store	Manual Store	Cable Search Option
	Guide	Channel Manager	Channel List	Channel List Transfer	Fine Tune
Setup	Plug & Play	Time	Language	Subtitle	Digital Text
	Security	General	PIP	Common Interface	
Input	Source List	Edit Name			
Application	Media Play	Anynet+ (HDMI-CEC)			
Support	Self Diagnosis	Software Upgrade	HD Connection Guide	Contact Samsung	

Picture [PC / HDMI PC Timing]



- The default setting may be different depending on the selected Input Mode (input signal source selected in External Input List) and the selected resolution







MENU	DESCRIPTION
MagicBright	<p><MagicBright> is a feature providing an optimum viewing environment depending on the contents of the image you are watching. Currently five different modes are available: <Entertain>, <Internet>, <Text>, <Dynamic Contrast> and <Custom>. Each mode has its own pre-configured brightness value.</p> <ul style="list-style-type: none"> • <Entertain> High Brightness For watching motion pictures such as a Blu-ray or DVD. • <Internet> For working with a mixture of images such as texts and graphics. • <Text> For documents or work involving heavy text. • <Dynamic Contrast> <Dynamic Contrast> automatically detects the distribution of the visual signal and adjusts to create an optimum contrast. • <Custom> Although the values are carefully chosen by our engineers, the pre-configured values may not be comfortable to your eyes depending on your taste. If this is the case, adjust the Brightness and Contrast by using the OSD menu.
MagicAngle	<p>This feature allows you to see optimal screen quality according to your viewing position. When viewing the screen at an angle from below, above or the side of the product, by setting the appropriate mode for each position you can obtain a similar picture quality as viewing the screen directly from the front.</p> <p> Set to <Off> when viewing directly in front of the screen.</p> <ul style="list-style-type: none"> • <Off> 1 Select when viewing from the front position. • <Lean Back Mode1> 2 Select when viewing from a slightly lower position. • <Lean Back Mode2> 3 Select when viewing from the lower position. • <Standing Mode> 4 Select when viewing from the upper position. • <Side Mode > 5 Select when viewing from the left or right position. <div style="display: flex; justify-content: space-around; align-items: center;">   </div> <p> Press the [TOOLS] button to display the Tools menu. You can also set the <MagicAngle> by selecting <Tools> → <MagicAngle>.</p>



MENU	DESCRIPTION
Contrast / Brightness / Sharpness	<p>You can use the on-screen menus to change the contrast and brightness according to personal preference.</p> <ul style="list-style-type: none"> • <Contrast> Adjust the Contrast. • <Brightness> Adjust the Brightness. • <Sharpness> Adjust the Sharpness. <p> This menu is unavailable when <MagicBright> is set to <Dynamic Contrast> mode.</p>
Eco Solution	<p>You can choose various options of <Energy Saving> features.</p> <ul style="list-style-type: none"> • <No-Signal Power Off> Saves power by turning the TV off when no signal is received from any source. <ul style="list-style-type: none"> - <Off> - <15 min> - <30 min> - <60 min> <p> Disabled when the PC is on DPM(Display Power Management).</p>
Auto Adjustment	<p>The values of <Fine>, <Coarse> and <Position> are adjusted automatically. By changing the resolution in the control panel, auto function is performed.</p> <p> Available in <PC> Mode Only</p> <p> Press the [TOOLS] button to display the Tools menu. You can also set the auto adjustment by selecting <Tools> → <Auto Adjustment>.</p>
Screen	<ul style="list-style-type: none"> • <Coarse> Removes noise such as vertical stripes. <Coarse> adjustment may move the screen image area. You may relocate it to the centre using the horizontal control menu • <Fine> Removes noise such as horizontal stripes. If the noise persists even after <Fine> tuning, repeat it after adjusting the frequency (Coarse). • <Position> Adjusts the screen location horizontally and vertically. • <Image Reset> Image parameters are replaced with the factory default values. <p> Available in <PC> Mode Only</p>



MENU	DESCRIPTION
Picture Options	<ul style="list-style-type: none"> • <Colour Tone> The tone of the colour can be changed. - <Cool> - <Normal> - <Warm> - <Custom> <ul style="list-style-type: none"> • Available in <PC> mode only • Not available when <MagicBright> is <Dynamic Contrast>. • <R-Gain > - < G-Gain > - <B-Gain > Adjusts the individual R, G, B (Red, Green, Blue) colour controls. <ul style="list-style-type: none"> • Not available when <MagicBright> is <Dynamic Contrast>. • <Size> You can switch the Size. - <16:9> - <4:3> • <Auto Protection Time> Set the time the screen remains idle with a still image until the screen saver is activated. The screen saver prevents the formation of ghost images on the screen. - <2 hours> - <4 hours> - <8 hours> - <10 hours> - <Off>
Picture Reset	<p>Picture parameters are replaced with the factory default values.</p> <ul style="list-style-type: none"> • <OK> - <Cancel>



Picture [TV / Ext. / Component or AV / HDMI]





MENU	DESCRIPTION
Mode	<p>You can select the type of picture which best corresponds to your viewing requirements.</p> <p>You can activate either <Dynamic>, <Standard> or <Movie>.</p> <ul style="list-style-type: none"> • <Dynamic> Selects the picture for high-definition in a bright room. • <Standard> Selects the picture for optimum display in a normal environment. • <Movie> Selects the picture for viewing movies in a dark room.
MagicAngle	<p>This feature allows you to see optimal screen quality according to your viewing position.</p> <p>When viewing the screen at an angle from below, above or the side of the product, by setting the appropriate mode for each position you can obtain a similar picture quality as viewing the screen directly from the front.</p> <ul style="list-style-type: none"> •  Set to <Off> when viewing directly in front of the screen. • The <TV>, <Component>, <AV> and <HDMI> modes only support the <Lean Back Mode1> and <Lean Back Mode2> menus. <hr/> <ul style="list-style-type: none"> • <Off>  Select when viewing from the front position. • <Lean Back Mode1>  Select when viewing from a slightly lower position. • <Lean Back Mode2>  Select when viewing from the lower position. • <Standing Mode>  Select when viewing from the upper position. • <Side Mode >  Select when viewing from the left or right position. <div data-bbox="683 1272 1212 1512" data-label="Image"> </div> <p> Press the [TOOLS] button to display the Tools menu. You can also set the <MagicAngle> by selecting <Tools> → <MagicAngle>.</p>

MENU	DESCRIPTION
Backlight / Contrast / Brightness / Sharpness / Colour / Tint (G/R)	<p>Your product has several setting options that allow you to control the picture quality.</p> <ul style="list-style-type: none"> • <Backlight > Adjusts the brightness of LED back light. • <Contrast> Adjusts the contrast level of the picture. • <Brightness> Adjusts the brightness level of the picture. • <Sharpness> Adjusts the edge definition of the picture. • <Colour> Adjusts colour saturation of the picture. • <Tint (G/R)> Adjusts the colour tint of the picture. <p> It is activated when the signal is NTSC.</p>
Eco Solution	<p>You can choose various options of <Energy Saving> features.</p> <ul style="list-style-type: none"> • <Energy Saving > You can reduce the power consumption by adjusting the screen brightness. - <Off> - <Low> - <Medium> - <High> - <Picture Off> - <Auto>  • If you select <Picture Off>, the screen is turned off, but the sound remains on. Press any button except volume button to turn on the screen. <ul style="list-style-type: none"> • Not available in PC/HDMI PC timing. • <No Signal Power Off> Saves power by turning the TV off when no signal is received from any source. - <Off> - <15 min> - <30 min> - <60 min> <p> Disabled when the PC is on DPM(Display Power Management).</p>





MENU	DESCRIPTION
Advanced Settings	<p>Samsung's new TVs allow you to make even more precise picture settings than previous models. See below to adjust detailed picture settings.</p> <p> <Advanced Settings> is available in <Standard> or <Movie> mode.</p> <ul style="list-style-type: none"> • <Black Tone> You can select the level on the screen to adjust the screen depth. - <Off> - <Dark> - <Darker> - <Darkest> • <Dynamic Contrast> You can adjust the screen contrast so that the optimal contrast is provided. - <Off> - <Low> - <Medium> - <High> • <Shadow Detail> Increase the brightness of dark images. • <Gamma> You can adjust the Primary Colour (Red, Green, Blue) Intensity. • <RGB Only Mode> Displays the red, green, or blue colour for making fine adjustments to hue and saturation. - <Off> - <Red> - <Green> - <Blue> • <Colour Space> <Colour Space> is a colour matrix composed of red, green and blue colours. Select your Favourite <Colour Space> to experience the most natural colour. - <Auto> - <Native> • <White Balance> You can adjust the colour temperature for more natural picture colours. - <R-Offset> - <G-Offset> - <B-Offset> - <R-Gain> - <G-Gain> - <B-Gain> - <Reset> • <Flesh Tone> - You can emphasize the pink <Flesh Tone> in the picture. <p> Changing the adjustment value will refresh the adjusted screen.</p> <ul style="list-style-type: none"> • <Edge Enhancement> You can emphasize object boundaries in the picture. - <Off> - <On>



MENU	DESCRIPTION
Picture Options	<ul style="list-style-type: none"> • <Colour Tone> The tone of the colour can be changed. <ul style="list-style-type: none"> - <Cool> - <Normal> - <Warm1> - <Warm2>  Settings can be adjusted and stored for each external device you have connected to an input of the TV. • <Size> You can switch the Size. <ul style="list-style-type: none"> - <Auto Wide> Automatically adjusts the picture size to the "16:9" aspect ratio. - <16:9> Adjusts the picture size to 16:9 appropriate for DVD or wide broadcasting. - <Wide Zoom> Magnify the size of the picture more than 4:3. - <Zoom> Magnifies the 16:9 wide picture (in the vertical direction) to fit the screen size. - <4:3> This is the default setting for a video movie or normal broadcasting. - <Screen Fit> Use the function to see the original image with no cut-off with HDMI (720p/ 1080i / 1080p) or Component (1080i / 1080p) signals are input.  <ul style="list-style-type: none"> • Depending on the input source, the picture size options may vary. • The items available may differ depending on the selected mode. • Settings can be adjusted and stored for each external device you have connected to an input of the TV. <ul style="list-style-type: none"> - <Wide Zoom> : Press the ► button to Select Position, then press the [↔] button. Press the ▲ or ▼ button to move the picture up/down. Then press the [↔] button. - <Zoom> : Press the ► button to Select Position, then press the [↔] button. Press the ▲ or ▼ button to move the picture up and down. Then press the [↔] button. Press the ► button to Select Size, then press the [↔] button. Press the ▲ or ▼ button to magnify or reduce the picture size in the vertical direction. Then press the [↔] button. • After selecting <Screen Fit> in HDMI (1080i) or Component (1080i) mode: Select Position by pressing the ◀ or ▶ button. Use the ▲, ▼, ◀ or ▶ button to move the picture. <ul style="list-style-type: none"> - <Reset> : Press the ◀ or ▶ button to select Reset, then press the [↔] button. You can initialize the setting. - If you use the <Screen Fit> function with HDMI 720p input, 1 line will be cut at the top, bottom, left and right as in the Overscan function. • <Screen Mode> Only when setting the picture size to <Auto Wide> can the user determine the <Screen mode>. Each individual European country requires a different picture size so this function is intended to help users to select it. <ul style="list-style-type: none"> - <16:9> - <Wide Zoom> - <Zoom> - <4:3>  • This function is not available in <PC>, <Component> or <HDMI> mode.



MENU	DESCRIPTION
Picture Options	<ul style="list-style-type: none"> • <Digital Noise Filter > If the broadcast signal received by your TV is weak, you can activate the Digital Noise Reduction feature to help reduce any static and ghosting that may appear on the screen. - <Off> - <Low> - <Medium> - <High> - <Auto> - <Auto Visualisation>  Auto Visualisation: When changing analogue channels, displays the intensity of the current signal and defines the screen noise filter. Only available for analogue channels. • <MPEG Noise Filter> Reduces MPEG noise to provide improved picture quality. - <Off> - <Low> - <Medium> - <High> - <Auto> • <HDMI Black Level> Selects the black level on the screen to adjust the screen depth. - <Normal> - <Low>  Available only in <HDMI> mode. • <Film Mode> The <Film Mode> feature offers you a theatre-quality viewing experience. - <Off> - <Auto1> - <Auto2>  <Film Mode> is supported in <TV>, <Component> (480i / 1080i) and <HDMI>(480i / 1080i) • <Auto Protection Time> Set the time the screen remains idle with a still image until the screen saver is activated. The screen saver prevents the formation of ghost images on the screen. - <2 hours> - <4 hours> - <8 hours> - <10 hours> - <Off>
Picture Reset	<p>Picture parameters are replaced with the factory default values.</p> <ul style="list-style-type: none"> • <OK> - <Cancel>

Sound



MENU	DESCRIPTION
Mode	<ul style="list-style-type: none"> • <Standard> Choose Standard for the standard factory settings. • <Music> Choose Music when watching music videos or concerts. • <Movie> Choose Movie when viewing movies. • <Clear Voice > Emphasizes voice over other sounds. • <Amplify > Increase the intensity of high-frequency sound to allow a better listening experience for the hearing impaired. <p> Press the [TOOLS] button to display the Tools menu. You can also set the <Sound Mode> by selecting <Tools> → <Sound Mode>.</p>
Equalizer	<p>You can adjust the left and right sound balance and equalizer settings as required.</p> <ul style="list-style-type: none"> • <Balance> You can adjust the left and right sound balance and equalizer settings as required. • <100Hz> - <300Hz> - <1kHz> - <3kHz> - <10kHz> To adjust the level of different bandwidth frequencies. • <Reset> Resets the equalizer settings to the default values. <p> <Standard> sound mode only</p>
Virtual Surround	<p>Use <Virtual Surround> technology to enjoy a more realistic sound when you are listening to the DVD or music.</p> <ul style="list-style-type: none"> • <Off> - <On> <p> <Standard> sound mode only</p>
Dialog Clarity	<p><Dialog Clarity> emphasizes voice while maintaining background sound level.</p> <ul style="list-style-type: none"> • <Off> - <On> <p> <Standard> sound mode only</p>
Audio Language	<p>You can change the default value for audio languages.</p> <ul style="list-style-type: none"> • While viewing a digital channel, this function can be selected. • You can only select the language among the actual languages being broadcast.

MENU	DESCRIPTION
Audio Format	<p>When sound is emitted from both the main speaker and the audio receiver, a sound echo may occur due to the decoding speed difference between the main speaker and the audio receiver. In this case, use the TV Speaker function.</p> <ul style="list-style-type: none"> • <MPEG> - <Dolby Digital> <p> • While viewing a digital channel, this function can be selected.</p> <ul style="list-style-type: none"> • <Audio Format> option may differ depending on the broadcast. 5.1ch Dolby digital sound is only available when connecting an external speaker through an optical cable.
Audio Description (not available in all locations)	<p>This is an auxiliary audio function that provides an additional audio track for visually challenged persons. This function handles the Audio Stream for the AD (Audio Description), when it is sent along with the Main audio from the broadcaster. Users can turn the Audio Description On or Off and control the volume.</p> <ul style="list-style-type: none"> • <Audio Description> Turn the audio description function on or off. • <Volume> You can adjust the audio description volume. <ul style="list-style-type: none"> - Volume is active when Audio Description is set to On. <p> While viewing a Digital channel, this function can be selected.</p>
Auto Volume	<p>Reduces the differences in volume level among channels.</p> <ul style="list-style-type: none"> • <Off> - <Normal> - <Night>
Speaker Select	<p>If you want to hear the sound through separate speakers, cancel the internal amplifier.</p> <ul style="list-style-type: none"> • <External Speaker> - <TV Speaker> <p> • If you select <External Speaker> in the <Speaker Select> menu, the sound settings will be limited.</p> <ul style="list-style-type: none"> • The volume and [MUTE] buttons do not operate when the <Speaker Select> is set to <External Speaker>. Please set the volume on your Home theatre.

MENU	DESCRIPTION
Additional Setting	<p>Digital channels only</p> <ul style="list-style-type: none"> • <DTV Audio Level> This function allows you to reduce the disparity of a voice signal (which is one of the signals received during a digital TV broadcast) to a desired level.  <ul style="list-style-type: none"> • According to the type of broadcast signal, MPEG / HE-AAC can be adjusted between -10dB and 0dB. • To increase or decrease the volume, adjust between the range 0 and -10 respectively. • <SPDIF Output> SPDIF (Sony Philips Digital InterFace) is used to provide digital sound, reducing interference going to speakers and various digital devices such as a DVD player. <ul style="list-style-type: none"> - <Audio Format> During the reception of a digital TV broadcast, you can select the Digital Audio output (SPDIF) format from the options <PCM> or <Dolby Digital>. - <Audio Delay> Correct audio-video sync problems, when watching TV or video, and when listening to digital audio output using an external device such as an AV receiver (0ms ~ 250ms). • <Dolby Digital Comp> This function minimizes signal disparity between a dolby digital signal and a voice signal (i.e. MPEG Audio, HE-AAC, ATV Sound).  <ul style="list-style-type: none"> • Select Line to obtain dynamic sound, and RF to reduce the difference between loud and soft sounds at night time. - <Line> Set the output level for signals greater or less than -31dB (reference) to either -20dB or -31dB. - <RF> Set the output level for signals greater or less than -20dB (reference) to either -10dB or -20dB.
Sound Reset	<p>You can restore the Sound settings to the factory defaults.</p> <ul style="list-style-type: none"> • <OK> - <Cancel>

Selecting the Sound Mode

When you set to <Dual I-II> the current sound mode is displayed on the screen.



	Audio Type	Dual I / II	Default
A2 Stereo	Mono	<MONO>	Automatic change
	Stereo	<STEREO> ↔ <MONO>	Automatic change
	Dual	<DUAL I> ↔ <DUAL II>	<DUAL I>
NICAM Stereo	Mono	<MONO>	Automatic change
	Stereo	<MONO> ↔ <STEREO>	Automatic change
	Dual	<MONO> ↔ <DUAL I> ↕ <DUAL II> ↕	<DUAL I>

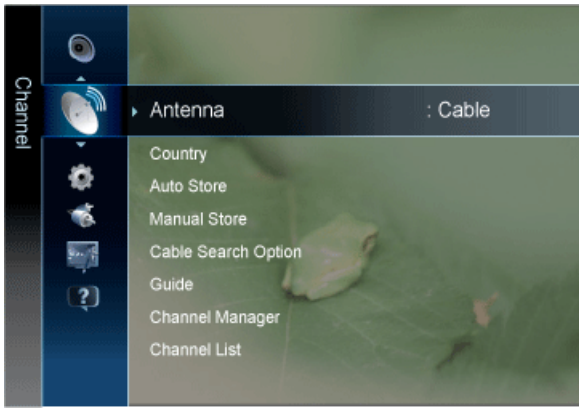

- 
 - If the stereo signal is weak and an automatic switching occurs, then switch to the mono.
 - This function is only activated in stereo sound signal. It is deactivated in mono sound signal.
 - This function is only available in <TV> mode.









Channel



















MENU	DESCRIPTION
Antenna	<p>You can select antenna or cable TV.</p> <p>If [ANT IN] connected, select the antenna input you want. If the antenna input is not selected properly, noise may appear on the screen.</p> <ul style="list-style-type: none"> • <Air> - <Cable>
Country	<p>Select the country in which the product is being used before you use the Auto Store feature. If you do not see your country in the list, select others.</p> <ul style="list-style-type: none"> • <Digital Channel> You can change the country for digital channels. • <Analogue Channel> You can change the country for analogue channels. <p> • The PIN number input screen appears. Enter your 4 digit PIN number.</p> <ul style="list-style-type: none"> • The default PIN number of a new TV set is 0-0-0-0.

MENU	DESCRIPTION
Auto Store	<p>You can scan for the frequency ranges available to you (and availability depends on your country).</p> <p> Automatically allocated programme numbers may not correspond to actual or desired programme numbers. If a channel is locked using the <Child Lock> function, the PIN input window appears.</p> <ul style="list-style-type: none"> • <Antenna Source> Select the antenna source to memorise. <ul style="list-style-type: none"> - <Air> - <Cable> • <Channel Source> Select the channel source to memorise. * When selecting <Cable> → <Digital & Analogue> or <Cable> → < Digital >: Provide a value to scan for cable channels. <ul style="list-style-type: none"> - <Digital & Analogue> - <Digital> - <Analogue> - <Search Mode> Scans for all channels with active broadcast stations and stores them in the TV. <ul style="list-style-type: none"> ▪ <Full> - <Network> - <Quick> <p> If you select <Quick>, you can set up the <Network>, <Network ID>, <Frequency>, <Modulation> and <Symbol Rate> manually by pressing the button on the remote control.</p> <ul style="list-style-type: none"> - Network Selects the <Network ID> setting mode among <Auto> or <Manual>. <ul style="list-style-type: none"> ▪ <Auto> - <Manual> - Network ID When <Network> is <Manual>, you can set up <Network ID> using the numeric buttons. - Frequency Displays the frequency for the channel. (Differs in each country) - Symbol Rate Displays available symbol rates. - Modulation Displays available modulation values. <p> Scans for all channels with active broadcast stations and stores them in the TV's memory.</p>

MENU	DESCRIPTION
Manual Store	<p>You can scan the frequency ranges available on your television in your area and store all the channels found manually.</p> <p> If a channel is locked using the <Child Lock> function, the PIN input window appears.</p> <ul style="list-style-type: none"> • <Digital Channel> When scanning has finished, channels are updated in the channel list. <ul style="list-style-type: none"> - When selecting <Antenna> → <Air> <ul style="list-style-type: none"> ▪ <Channel> - <Frequency> - <Bandwidth> - When selecting <Antenna> → <Cable> <ul style="list-style-type: none"> ▪ <Frequency> - <Modulation> - <Symbol Rate>  • Digital Channel is only available in DTV mode. <ul style="list-style-type: none"> • When it has finished, channels are updated in the channel list. • <Analogue Channel> Manual store for analogue channel. <ul style="list-style-type: none"> - <Programme> When tuning is complete, the broadcasting stations in your area have been assigned to position numbers from 0 to 99. You can select a channel by entering the position number in this mode. - <Colour System> Adjusts repeatedly until the colour is of the best quality. Sets the colour system value using the ▲ or ▼ button. <ul style="list-style-type: none"> ▪ <Auto> - <PAL> - <SECAM> - <NTSC4.43> - <Sound System> Adjusts repeatedly until the sound is of the best quality. Sets the sound system value using the ▲ or ▼ button. <ul style="list-style-type: none"> ▪ <BG> - <DK> - <I> - <L> - <Channel> (When you know the number of the channel to be stored) You can store television channels, including those received via cable networks. When storing channels manually, you can choose: Whether or not to store each of the channels found. The Programme number of each stored channel which you wish to identify <ul style="list-style-type: none"> ▪ <C> (Air channel mode) You can select a channel by entering the assigned number to each air broadcasting station in this mode. ▪ <S> (Cable channel mode) You can select a channel by entering the assigned number for each cable channel in this mode. - <Search> (When you do not know the channel numbers) Press the ▲ or ▼ button to start the search. The tuner scans the frequency range until the first channel or the channel that you selected is received on your screen. - <Store> (When you store the channel and associated programme number) It's used to restore the number user inputs. Set to OK by pressing the [] button.
Cable Search Option (depending on the country)	<p>Using this function, you can manually add the channel range to be scanned by full search mode of the Auto Store function.</p> <ul style="list-style-type: none"> • <Freq.Start~Stop> Displays the frequency for the channel. (Differs in each country) • <Modulation > Displays available modulation values. • <Symbol Rate> Displays available symbol rates.

MENU	DESCRIPTION
Guide	<p>The EPG (Electronic Programme Guide) information is provided by broadcasters. Using programme schedules provided by broadcasters, you can specify programmes you want to watch in advance so that the channel automatically changes to the selected programme channel at the specified time. Programme entries may appear blank or out of date depending on a channel status.</p> <ul style="list-style-type: none"> •  Red (View Mode) View the list of programmes that are playing now or coming up. •  Yellow (+24 Hours) Viewing the list of programmes to be broadcasted after 24 hours. •  Blue (Ch. Mode) Select the type of channels you want to display on the <Channel View> window. <p> The <Ch. Mode> differs according to the antenna source.</p> <ul style="list-style-type: none"> •  Information Displays details of the selected programme. •  (Page) Move to next or previous page. •  button <ul style="list-style-type: none"> - When selecting the current programme, you can watch the selected programme. - When selecting the future programme, you can reserve to watch the selected programme. <p>To cancel the schedule, press the  button again and select Cancel Schedules.</p>



MENU	DESCRIPTION
Channel Manager	<p>Delete or set favourites channels and use the programme guide for digital broadcasts. Select a channel in the <Channels>, <My Channels> or <Scheduled> screen.</p> <ul style="list-style-type: none"> • <Channels> Shows the channel list according to channel type. • <My Channels> Shows the group of the channel. • <Scheduled> Shows all the currently reserved programmes <p>Using the colour buttons with the Channel Manager.</p> <ul style="list-style-type: none"> •  Red (Antenna) Toggle among <Air> or <Cable>. •  Green (Zoom) Enlarges or shrinks a channel number. •  Yellow (Select) Select desired channels and press the Yellow button to set all the selected channels at the same time. The  mark appears to the left of the selected channels. •  Blue (Sort) Change the list ordered by channel name or channel number. •  (Page) Move to next or previous page. •  (Tools) Displays the Channel Manager option menu. (The options menus may differ depending on the situation.) <p> Channel Status Display Icons</p> <ul style="list-style-type: none"> • : An analogue channel. • : A channel set as a Favourite. • : A channel selected by pressing the yellow button. • : A Program currently being broadcast. • : A locked channel. • : A reserved program.
Channel List	<p>You can see all the channels searched. You can select these options by simply pressing the [CH LIST] button on the remote control.</p>



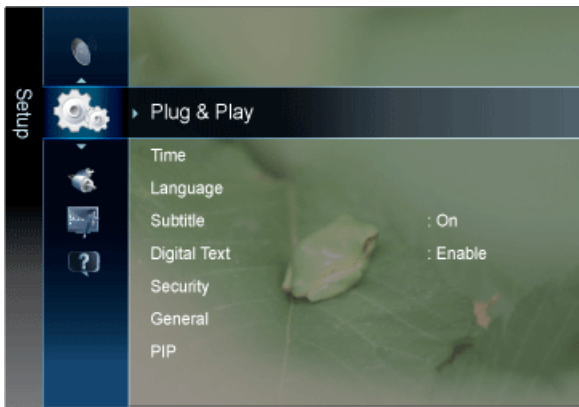

MENU	DESCRIPTION
Channel List Transfer	<p data-bbox="395 181 1377 210">Imports or exports the channel map. You should connect a USB storage to use this function.</p> <ul style="list-style-type: none"> <li data-bbox="405 241 1241 271">  • The PIN number input screen appears. Enter your 4 digit PIN number. <li data-bbox="456 284 1038 313">• The default PIN number of a new TV set is 0-0-0-0. <li data-bbox="432 344 1011 374">• <Import from USB> : Import channel list from USB. <li data-bbox="432 387 959 416">• <Export to USB> : Export channel list to USB.
Fine Tune	<p data-bbox="395 432 1206 461">Use fine tuning to manually adjust a particular channel for optimal reception.</p> <ul style="list-style-type: none"> <li data-bbox="405 492 1358 521">  • If you do not store the fine-tuned channel in memory, adjustments are not saved. <li data-bbox="456 535 1461 595">• Fine tuned channels that have been saved are marked with an asterisk ‘*’ on the right-hand side of the channel number in the channel banner. <ul style="list-style-type: none"> <li data-bbox="529 609 1461 674">- To reset the fine tuning setting, press the ▼ button to select <Reset>, then press the [↵] button. <li data-bbox="456 687 991 716">• Only Analogue TV channels can be fine tuned.





Setup















MENU	DESCRIPTION
Plug & Play	This brings up the menu items that appeared when you first plugged in the TV.
Time	<ul style="list-style-type: none"> • <Clock> Setting the clock is necessary in order to use the various timer features of the TV. - <Clock Mode> You can set up the current time manually or automatically. <ul style="list-style-type: none"> ▪ <Auto> - <Manual> <ul style="list-style-type: none"> 🔗 • Depending on the broadcast station and signal, the auto time may not be set correctly. If this occurs, set the time manually. • The Antenna or cable must be connected in order to set the time automatically. - <Clock Set> You can set the current time manually. <ul style="list-style-type: none"> 🔗 • This function is only available when <Clock Mode> is set to <Manual>. • You can set the day, month, year, hour and minute directly by pressing the number buttons on the remote control. 🔗 • The current time will appear every time you press the [INFO] button. • If you disconnect the power cord, you have to set the clock again. • <Sleep Timer> The sleep timer automatically shuts off the TV after a preset time . <ul style="list-style-type: none"> - <Off> - <30 min> - <60 min> - <90 min> - <120 min> - <150 min> - <180 min> <ul style="list-style-type: none"> 🔗 Press the [TOOLS] button to display the Tools menu. You can also set the sleep timer by selecting <Tools> → <Sleep Timer>. 🔗 To cancel the <Sleep Timer> function, select <Off>.

MENU	DESCRIPTION
	<ul style="list-style-type: none"> • <Timer1 / Timer2 / Timer3> Three different on / off timer settings can be made. You must set the clock first. - <On Time> / <Off Time> Set the <Activate/Inactivate>, <Hour> and <Minute>. (To activate the timer with the setting you've chosen, set to <Activate>.) - <Volume> Set the desired volume level. - <Source> Select TV or USB content to be played when the TV is turned on automatically. (USB can be selected only when a USB device is connected to the TV) - <Antenna> View antenna type. (<Air> or <Cable>). <p> You can set the <Antenna> by selecting <Channel> → <Antenna>.</p> <ul style="list-style-type: none"> - <Channel> (when the <Source> is set to <TV>) Select the desired channel. - <Contents> (when the <Source> is set to <USB>) Select a folder in the USB device containing music or photo files to be played when the TV is turned on automatically. <p> • If there is no music file on the USB device or the folder containing a music file is not selected, the Timer function does not operate correctly.</p> <ul style="list-style-type: none"> • When there is only one photo file in the USB, the Slide Show will not play. • If a folder name is too long, the folder cannot be selected. • Each USB you use is assigned its own folder. When using more than one of the same type of USB, make sure the folders assigned to each USB have different names. <ul style="list-style-type: none"> - <Repeat> Select <Once>, <Everyday>, <Mon~Fri>, <Mon~Sat>, <Sat~Sun> or <Manual>. <p> • When <Manual> is selected, press the ► button to select the desired day of the week. Press the [⊕] button over the desired day and the (✓) mark will appear.</p> <ul style="list-style-type: none"> • You can set the <hour>, <minute> and channel by pressing the number buttons on the remote control. • Auto Power Off • When you set the timer On, the television will eventually turn off if no controls are operated for 3 hours after the TV was turned on by the timer. This function is only available in timer On mode and prevents overheating, which may occur if a TV is on for too long time.

MENU	DESCRIPTION
Language	<ul style="list-style-type: none"> • <Menu Language> The language chosen affects only the language of the OSD. • <Teletext Language> You can set the Teletext language by selecting the language type. <p> English is the default in cases where the selected language is unavailable in the broadcast.</p> <ul style="list-style-type: none"> • <Preference> <ul style="list-style-type: none"> - <Primary Audio Language> / <Secondary Audio Language> / <Primary Subtitle Language> / <Secondary Subtitle Language> / <Primary Teletext Language> / <Secondary Teletext Language> <p>Using this feature, users can select one of the languages. The language selected here is the default when the user selects a channel.</p> <p> • If you change the language setting, the Subtitle Language, Audio Language, and the Teletext Language of the Language menu are automatically changed to the selected language.</p> <ul style="list-style-type: none"> • The Subtitle Language, Audio Language, and the Teletext Language of the Language menu show a list of languages supported by the current channel and the selection is highlighted. • If you change this language setting, the new selection is only valid for the current channel. The changed setting does not change the setting of the Primary Subtitle Language, Primary Audio Language, or the Primary Teletext Language of the Preference menu.
Subtitle	<p>Use this menu to set the <Subtitle> mode.</p> <p><Normal> under the menu is the basic subtitle and <Hearing Impaired> is the subtitle for a hearing-impaired person.</p> <ul style="list-style-type: none"> • <Subtitle> Switches subtitles on or off. • <Mode> Sets the subtitle mode. <ul style="list-style-type: none"> - <Normal> - <Hearing Impaired> • <Subtitle Language> Set the subtitle language. <p> • If the programme you are watching does not support the <Hearing Impaired> function, <Normal> automatically activates even though <Hearing Impaired> mode is selected.</p> <ul style="list-style-type: none"> • English is the default in cases where the selected language is unavailable in the broadcast. • You can select these options simply by pressing the [SUBT]. button on the remote control. <p></p>
Digital Text (UK only)	<p>If the programme is broadcast with digital text, this feature is enabled.</p> <ul style="list-style-type: none"> • <Disable> - <Enable> <p> • MHEG (Multimedia and Hypermedia Information Coding Experts Group)</p> <ul style="list-style-type: none"> • An International standard for data encoding systems used in multimedia and hypermedia. This is at a higher level than the MPEG system which includes data-linking hypermedia such as still images, character service, animation, graphic and video files as well as multimedia data. MHEG is user runtime interaction technology and is being applied to various fields including VOD (Video-On-Demand), ITV (Interactive TV), EC (Electronic Commerce), tele-education, tele-conferencing, digital libraries and network games.

MENU	DESCRIPTION
Security	<ul style="list-style-type: none">  <ul style="list-style-type: none"> • Before the setup screen appears, the PIN number input screen appears. Enter your 4 digit PIN number. • The default PIN number of a new TV set is 0-0-0-0. You can change the PIN by selecting <Change PIN> from the menu. • <Child Lock> This feature allows you to prevent unauthorized users, such as children, from watching unsuitable programme by muting out video and audio. <ul style="list-style-type: none"> - <Off> - <On>  Available only when the <Input> source is set to <TV>. • <Parental Lock> (depending on the country) Prevent unauthorized users, such as children, from watching unsuitable programme with a user-defined 4-digit PIN code. If the selected channel is locked, the  symbol will be displayed. <ul style="list-style-type: none"> - <Allow All> Unlock all TV ratings (Not supported in France and Sweden).  <ul style="list-style-type: none"> • When <Parental Lock> is set to <18>, the PIN input screen appears before changing the channels (France only). • You can block TV programs by set up rating in <Parental Lock> as the <I> (children), <T> (All public), <SC> (Unclassified) and <X> (X rated). When <Parental Lock> is set to <X>, the PIN input screen always before changing the channels (Spain only). • You can block TV programs by set up rating in <Parental Lock> as the <Children>, <Youth> or <Adult> (Sweden only). • <Change PIN> You can change your personal ID number that is required to set up the TV.  If you forget the PIN code, press the remote control buttons in the following sequence, which resets the PIN to 0-0-0-0: [POWER] (Off) → [MUTE] → 8 → 2 → 4 → [POWER] (On).

MENU	DESCRIPTION
General	<ul style="list-style-type: none"> • <Max. Power Saving> Conserve power by turning the product off when the PC is not used for a specified period. - <Off> - <On>  Available in <PC> Mode Only • <Game Mode> When connecting to a game console such as PlayStation™ or Xbox™, you can enjoy a more realistic gaming experience by selecting game menu. - <Off> - <On>  <ul style="list-style-type: none"> • Restrictions on game mode (Caution) <ul style="list-style-type: none"> - To disconnect the game console and connect another external device, set <Game Mode> to <Off> in the setup menu. If you display the TV menu in <Game mode>, the screen shakes slightly. • If <Game Mode> is <On> : <ul style="list-style-type: none"> - <Picture> mode is automatically changed to <Standard> and cannot be changed. - <Sound> mode is automatically changed to <Movie> and cannot be changed. Adjust the sound using the equalizer. • <Game Mode> is not available in regular <TV> and <PC> mode. • If the picture is poor when external device is connected to TV, check if <Game Mode> is <On>. Set <Game Mode> to <Off> and connect external devices. • <Menu Transparency> Set the Transparency of the menu. - <Bright> - <Dark> • <Melody> A melody sound can be set to come on when the product is powered On or Off. - <Off> - <Low> - <Medium> - <High>  The <Melody> does not play <ul style="list-style-type: none"> • When no sound is output from the TV because the [MUTE] button has been pressed. • When no sound is output from the TV because the volume has been reduced to minimum with the volume [-] button. • When the TV is turned off by <Sleep Timer> function.

MENU	DESCRIPTION				
PIP	<p>You can use the PIP feature to simultaneously watch the TV tuner and one external video source. This product has one built-in tuner, which does not allow PIP to function in the same mode.</p> <p> Press the [TOOLS] button to display the Tools menu. You can also set the sleep timer by selecting <Tools> → <PIP>.</p> <ul style="list-style-type: none">  • PIP Settings. <table border="1" data-bbox="496 416 1046 483"> <thead> <tr> <th>Main picture</th> <th>Sub picture</th> </tr> </thead> <tbody> <tr> <td>Component, HDMI1, HDMI2, PC</td> <td>TV</td> </tr> </tbody> </table> <ul style="list-style-type: none"> If you turn the TV off while watching in PIP mode and turn it on again, the PIP window will disappear. You may notice that the picture in the PIP window becomes slightly unnatural when you use the main screen to view a game or karaoke. <PIP> You can activate or deactivate the PIP function. - <On> - <Off> <Channel> You can select the channel for the sub-screen. <p> <Channel> is available when the <Source> is set to <TV>.</p> <ul style="list-style-type: none"> <Source> You can select a source of the sub-picture. <Size> →  /  You can select a size of the sub-picture. <Position> →  /  /  /  You can select a position of the PIP-picture. Sound Select You can choose the desired sound (<Main> / <Sub>) in <PIP> mode. - <Main> - <Sub> 	Main picture	Sub picture	Component, HDMI1, HDMI2, PC	TV
Main picture	Sub picture				
Component, HDMI1, HDMI2, PC	TV				
Common Interface	<ul style="list-style-type: none"> <CI Menu> This enables the user to select from the CAM-provided menu. Select the CI Menu based on the menu PC Card. <Application Info.> This contains information on CAM inserted in the CI slot and displays it. The Application Info inserting is about the CI CARD. You can install the CAM anytime whether the TV is ON or OFF. <ol style="list-style-type: none"> Purchase a CI CAM module at your nearest dealer or by phone. Firmly insert the “CI or CI+ CARD” into the CAM in the direction of the arrow. Insert the CAM with the “CI or CI+ CARD” into the common interface slot, in the direction of the arrow so that it aligns parallel with the slot. Check if you can see a picture on a scrambled signal channel. 				

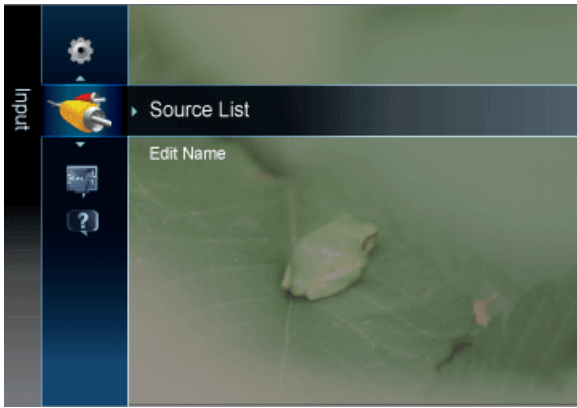

Input

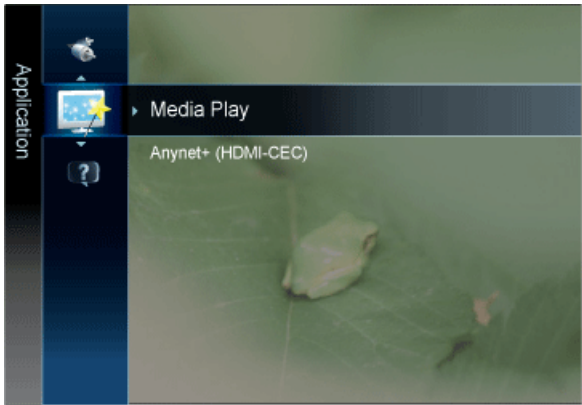

MENU	DESCRIPTION
Source List	<p>Use to select <PC>, <TV> or an external input source connected to the product. Use to select the screen of your choice.</p> <p>You can use the [SOURCE] button on the remote control.</p> <ul style="list-style-type: none"> • <TV> / <Ext> / <PC> / <AV> / <Component> / <HDMI1> / <HDMI2> / <USB> <ul style="list-style-type: none"> • <AV> and <Component> cannot be connected at the same time. • In the <Source List>, connected inputs will be highlighted. • <Ext> and <PC> always stay activated.
Edit Name	<p>Name the input device connected to the input jacks to make your input source selection easier.</p> <ul style="list-style-type: none"> • <VCR> - <DVD> - <Cable STB> - <Satellite STB> - <PVR STB> - <AV Receiver> - < Game> - <Camcorder> - <PC> - <DVI PC> - <DVI Devices> - <TV> - <IPTV> - <Blu-ray> - <HD DVD> - <DMA> <ul style="list-style-type: none"> • When a PC with a resolution of 1920 x 1080 @ 60 Hz is connected to the [HDMI IN 1, 2 (DVI)] port, you should set the <HDMI> mode to <DVI PC> in the <Edit Name> of the <Input> mode. In this case, a separate sound connection is required.

Application



MENU	DESCRIPTION
Media Play	Enjoy photos, music and/or movie files saved on a USB Mass Storage Class (MSC) device.  See "3-6. Media Play" for details.
Anynet+ (HDMI-CEC)	What is <Anynet+>? <Anynet+> is a function that enables you to control all connected Samsung devices that support <Anynet+> with your Samsung TV's remote. The <Anynet+ > system can be used only with Sam-sung devices that have the <Anynet+> feature. To be sure your Samsung device has this feature, check if there is an <Anynet+> logo on it.  See "3-7. Anynet+ (HDMI-CEC)" for details.

Support



MENU	DESCRIPTION
Self Diagnosis	<ul style="list-style-type: none"> • <Picture Test> If you think you have a picture problem, perform the picture test. Check the colour pattern on the screen to see if the problem still exists. <ul style="list-style-type: none"> - <Yes> If the test pattern does not appear or there is noise in the test pattern, select <Yes>. There may be a problem with the TV. Contact Samsung's call centre for assistance. - <No> If the test pattern is properly displayed, select <No>. There may be a problem with your external equipment. Please check your connections. If the problem still persists, refer to the external device's user manual. • <Sound Test> If you think you have a sound problem, please perform the sound test. You can check the sound by playing a built-in melody sound through the TV. <ul style="list-style-type: none"> - <Yes> If during the sound test you can hear sound only from one speaker or not at all, select <Yes>. There may be a problem with the TV. Contact Samsung's call centre for assistance. - <No> If you can hear sound from the speakers, select <No>. There may be a problem with your external equipment. Please check your connections. If the problem still persists, refer to the external device's user manual. <ul style="list-style-type: none"> 🔧 • If you hear no sound from the TV's speakers, before performing the sound test, make sure <Speaker Select > is set to <TV Speaker> in the <Sound> menu. • The melody will be heard during the test even if <Speaker Select> is set to <External Speaker> or the sound is muted by pressing the [MUTE] button. <hr/> <ul style="list-style-type: none"> • <Signal Information (digital channels only)> Unlike analogue channels, which can vary in reception quality from snowy to clear, digital (HDTV) channels have either perfect reception quality or you will not receive them at all. So, unlike analogue channels, you cannot fine tune a digital channel. You can, however, adjust your antenna to improve the reception of available digital channels. <ul style="list-style-type: none"> 🔧 If the signal strength meter indicates that the signal is weak, physically adjust your antenna to increase the signal strength. Continue to adjust the antenna until you find the best position with the strongest signal. • <Troubleshooting> If the TV seems to have a problem, refer to this description. <ul style="list-style-type: none"> 🔧 If none of these troubleshooting tips apply, contact the Samsung customer service centre.

MENU	DESCRIPTION
Software Upgrade	<ul style="list-style-type: none"> • <By USB> Insert a USB drive containing the firmware upgrade downloaded from samsung.com into the TV. Please be careful not to disconnect the power or remove the USB drive while upgrades are being applied. The TV will turn off and turn on automatically after completing the firmware upgrade. Please check the firmware version after the upgrades are complete (the new version will have a higher number than the older version). When software is upgraded, video and audio settings you have made will return to their default (factory) settings. We recommend you write down your settings so that you can easily reset them after the upgrade. • <By Channel> Upgrades the software using the broadcasting signal. • <Standby Mode Upgrade> To continue software upgrade with master power on, select on by pressing the ▲ or ▼ button. 45 minutes after entering standby mode, a manual upgrade is automatically conducted. Since the power of the unit is turned on internally, the screen may be on slightly for the LED product. This phenomenon may continue for more than 1 hour until the software upgrade is completed. • <Alternative Software>(Backup) If there is an issue with the new firmware and it is affecting operation, you can change the software to the previous version. <p> • If software was changed, existing software is displayed.</p> <ul style="list-style-type: none"> • You can change current software to alternative software by 'Alternative Software'.
HD Connection Guide	This menu presents the connection method that provides the optimal quality for the HDTV. Refer to this information when connecting external devices to the TV.
Contact Samsung	View this information when your TV does not work properly or when you want to upgrade the software. You can view the information regarding the call centre, product and software file download method.



Enjoy photos, music and/or movie files saved on a USB Mass Storage Class (MSC) device and/or your pc.

MENU[] → Application → Media Play → []

Connecting a USB Device



1. Turn on your TV.
2. Connect a USB device containing photo, music and/or movie files to the [USB] jack on the back of the TV.
3. When USB is connected to the TV, a popup window appears. Then you can select <Media Play>.

It might not work properly with unlicensed multimedia files.

Need-to-Know List before using <Media Play>

- MTP (Media Transfer Protocol) is not supported.
- The file system supports FAT16, FAT32 and NTFS.
- Certain types of USB Digital camera and audio devices may not be compatible with this TV.
- <Media Play> only supports USB Mass Storage Class (MSC) devices. MSC is a Mass Storage Class Bulk-Only Transport device. Examples of MSC are Thumb drives and Flash Card Readers. Devices should be connected directly to the TV's USB port. USB (HDD) is not supported.
- Before connecting your device to the TV, please back up your files to prevent them from damage or loss of data. SAMSUNG is not responsible for any data file damage or data loss.
- Do not disconnect the USB device while it is loading.
- The higher the resolution of the image, the longer it takes to display on the screen.
- The maximum supported JPEG resolution is 15360X8640 pixels.
- For unsupported or corrupted files, the "Not Supported File Format" message is displayed.
- If the files are sorted by Basic View, up to 1000 files can be displayed in each folder.

- MP3 files with DRM that have been downloaded from a non-free site cannot be played. Digital Rights Management(DRM) is a technology that supports the creation, distribution and management of the content in an integrated and comprehensive way, including the protection of the rights and interests of the content providers, the prevention of the illegal copying of contents, as well as managing billings and settlements.
- If more than 2 PTP devices are connected, you can only use one at a time.
- If more than two MSC devices are connected, some of them may not be recognized. A USB device that requires high power (more than 500mA or 5V) may not be supported.
- If an over-power warning message is displayed while you are connecting or using a USB device, the device may not be recognized or may malfunction.
- If the TV has been no input during time set in <Auto Protection Time>, the Screensaver will run.
- The power-saving mode of some external hard disk drives may be released automatically when connected to the TV.
- If a USB extension cable is used, the USB device may not be recognized or the files on the device may not be read.
- If a USB device connected to the TV is not recognized, the list of files on the device is corrupted or a file in the list is not played, connect the USB device to the PC, format the device and check the connection.
- If a file deleted from the PC is still found when <Media Play> is run, use the “Empty the Recycle Bin” function on the PC to permanently delete the file.



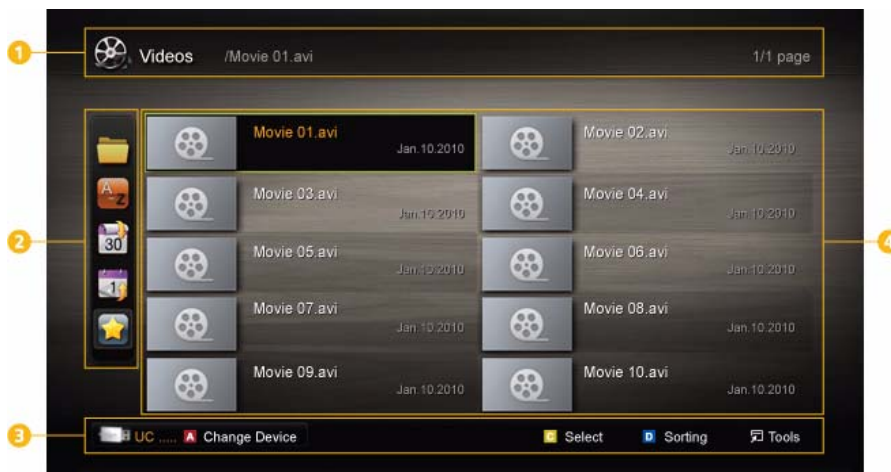

Screen Display

Move to the file you desired using the up/down/right/left buttons and then press the [↵] or [▶] (Play) button. The file is played.

- ☑ Supports the <View Devices> and <Home> in <Media Play> homepage.







NUMBER	MENU	DESCRIPTION
1	Information	You can ascertain the selected file name and the number of files and page.
2	Sort List Section	Displays sorting standard. ☑ Sorting standard is different depending on the contents.

NUMBER	MENU	DESCRIPTION
3	Operation Buttons	<ul style="list-style-type: none"> A Red (Change Device) Selects a connected device. B Green (Preference) Sets the file preference. (not supported in Basic view) C Yellow (Select) Selects multiple files from file list. Selected files are marked with a symbol. D Blue (Sorting) Selects the sort list.  (Tools) Displays the option menu. <p> Using the [] (REW) or [] (FF) button, file list can move to next or previous page.</p>
4	File List Section	You can confirm the files and groups that is sorted by each category.

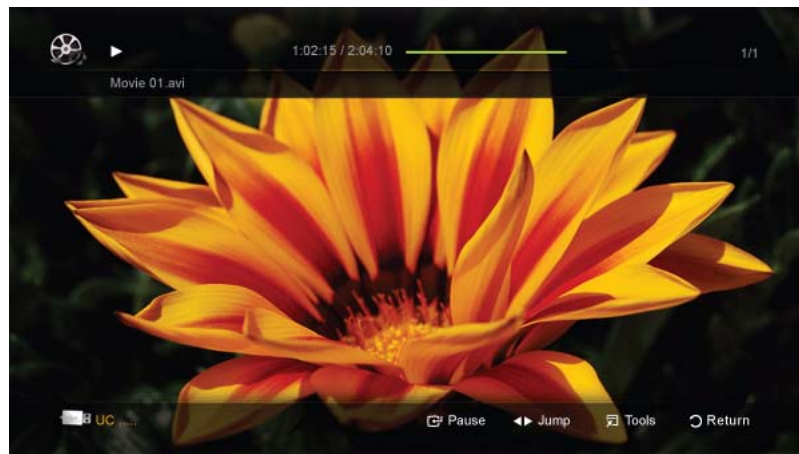
Videos

Playing Video



- Press the ◀ or ▶ button to select <Videos>, then press the [] button in the <Media Play> menu.
- Press the ◀/▶/▲/▼ button to select the desired video in the file list.
- Press the [] button or [] (Play) button.
 - The selected file is displayed on the top with its playing time.
 - If video time information is unknown, play time and progress bar are not displayed.
 - During playing the video, you can search using the ◀ and ▶ button.

 In this mode, you can enjoy movie clips contained on a Game, but you cannot play the Game itself.

- Supported Subtitle Formats

NAME	FILE EXTENSION	FORMAT
MPEG-4 time-based text	.txt	XML
SAMI	.smi	HTML
SubRip	.srt	string-based

NAME	FILE EXTENSION	FORMAT
SubViewer	.sub	string-based
Micro DVD	.sub or .txt	string-based

- Supported Video Formats

FILE EXTENSION	CONTAINER	VIDEO CODEC	RESOLUTION	FRAME RATE (FPS)	BIT RATE (MBPS)	AUDIO CODEC
*.avi *.mkv	AVI MKV	Divx 3.11 / 4.x / 5.1 / 6.0	1920 x 1080	6 ~ 30	8	MP3 AC3 LPCM ADPCM DTS Core
		XviD	1920 x 1080	6 ~ 30	8	
		H.264 BP / MP / HP	1920 x 1080	6 ~ 30	25	
		MPEG4 SP / ASP	1920 x 1080	6 ~ 30	8	
*.asf	ASF	Divx 3.11 / 4.x / 5.1 / 6.0	1920 x 1080	6 ~ 30	8	MP3 AC3 LPCM ADPCM WMA
		XviD	1920 x 1080	6 ~ 30	8	
		H.264 BP / MP / HP	1920 x 1080	6 ~ 30	25	
		MPEG4 SP / ASP	1920 x 1080	6 ~ 30	8	
*.wmv	ASF	Window Media Video v9	1920 x 1080	6 ~ 30	25	WMA
*.mp4	MP4	H.264 BP / MP / HP	1920 x 1080	6 ~ 30	25	MP3 ADPCM AAC
		MPEG4 SP / ASP	1920 x 1080	6 ~ 30	8	
		XVID	1920 x 1080	6 ~ 30	8	
*.3gp	3GPP	H.264 BP / MP / HP	1920 x 1080	6 ~ 30	25	ADPCM AAC HE-AAC
		MPEG4 SP / ASP	1920 x 1080	6 ~ 30	8	
*.vro	VRO VOB	MPEG1	1920 x 1080	24 / 25 / 30	30	AC3 MPEG LPCM
		MPEG2	1920 x 1080	24 / 25 / 30	30	
*.mpg *.mpeg	PS	MPEG1	1920 x 1080	24 / 25 / 30	30	AC3 MPEG LPCM AAC
		MPEG2	1920 x 1080	24 / 25 / 30	30	
		H.264	1920 x 1080	6 ~ 30	25	

FILE EXTENSION	CONTAINER	VIDEO CODEC	RESOLUTION	FRAME RATE (FPS)	BIT RATE (MBPS)	AUDIO CODEC
*.ts *.tp *.trp	TS	MPEG2	1920 x 1080	24 / 25 / 30	30	AC3
		H.264	1920 x 1080	6 ~ 30	25	AAC
		VC1	1920 x 1080	6 ~ 30	25	MP3 DD+ HE-AAC

Other Restrictions

- If there are problems with the contents of a codec, the codec will not be supported.
- If the information for a Container is incorrect and the file is in error, the Container will not be able to play correctly.
- Sound or video may not work if the contents have a standard bitrate/frame rate above the compatible Frame/sec listed in the table above. If the information for a Container is incorrect and the file is in error, the Container will not be able to play correctly.

VIDEO DECODER	AUDIO DECODER
<ul style="list-style-type: none"> • Supports up to H.264, Level 4.1 • H.264 FMO / ASO / RS, VC1 SP / MP / AP L4 and AVCHD are not supported. • GMC is not supported. • H.263 is not supported. 	<ul style="list-style-type: none"> • Supports up to WMA 7, 8, 9, STD • WMA 9 PRO does not support 2 channel excess multi channel or lossless audio. • WMA sampling rate 22050Hz mono is not supported.

Playing movie file continuously (Resume Play)

If you exit the playing videos function, it can be played later from the point where it was stopped.

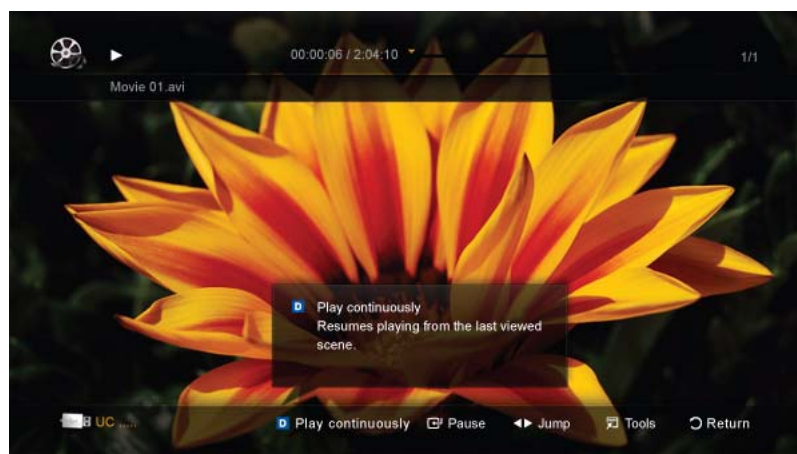

1. Select the movie file you want to play continuously by pressing the ◀ or ▶ button to select it from the file list section.
2. Press the [▶] (Play) / [⏮] button.
3. Select <Play Continuously> (Resume Play) by pressing the Blue button. The Movie will begin to play from where it was stopped.

- The Blue button is available when resuming play.
- If the <Continuous Movie Play Help> function is set to <On> in the <Settings> menu, a pop-up message will appear when you resume play a movie file.

Music

Playing Music

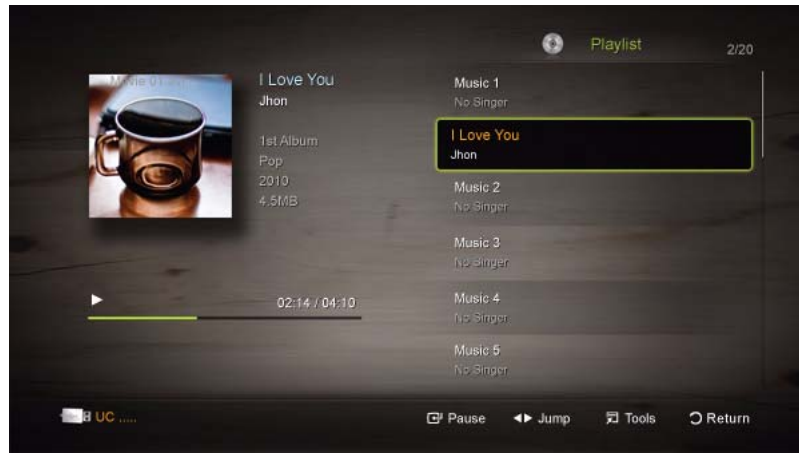

1. Press the ◀ or ▶ button to select <Music>, then press the [⏪] button in the <Media Play> menu.
 2. Press the ◀/▶/▲/▼ button to select the desired file in the file list.
 3. Press the [⏪] button or [▶] (Play) button.
 - During playing the music, you can search using the ◀ and ▶ button.
 - [⏮] (REW) and [⏭] (FF) buttons do not function during play.
- Only displays the files with MP3 and PCM file extension. Other file extensions are not displayed, even if they are saved on the same USB device.
 - If the sound is abnormal when playing MP3 files, adjust the <Equalizer> in the <Sound> menu. (An over-modulated MP3 file may cause a sound problem.)

Photos

Viewing a Photo (or Slide Show)

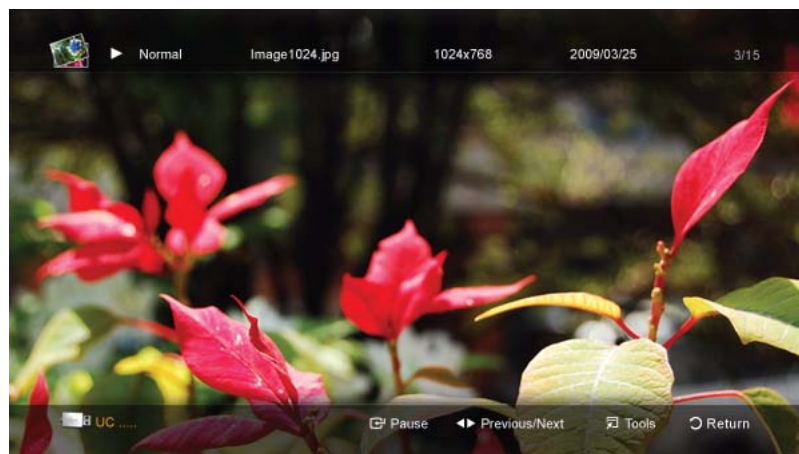

1. Press the ◀ or ▶ button to select <Photos>, then press the [⏪] button in the <Media Play> menu.
 2. Press the ◀/▶/▲/▼ button to select the desired photo in the file list.
 3. Press the [⏪] button or [▶] (Play) button.
 - While a photo list is displayed, press the [▶] (Play) / [⏪] button on the remote control to start the slide show.
 - All files in the file list section will be displayed in the slide show.
 - During the slide show, files are displayed in order.
- Music files can be automatically played during the Slide Show if the <Background Music> is set to <On>.

- The <BGM Mode> cannot be changed until the BGM has finished loading.

Playing the Multiple Files

Playing the selected video/music/photo files



1. Press the Yellow button in the file list to select the desired file.
2. Repeat the above operation to select multiple files.

- The  mark appears to the left of the selected files.
- To cancel a selection, press the Yellow button again.
- To deselect all selected files, press the TOOLS button and select <Deselect All>.

3. Press the TOOLS button and select <Play Selected Contents>.















Playing the video/music/photo file group







1. While a file list is displayed, move to the any file in desired group.
2. Press the TOOLS button and select <Play Current Group>.

Media Play Additional Function

Sorting the file list

Press the Blue button in the file list to sort the files.

CATEGORY		OPERATIONS	VIDEOS	MUSIC	PHOTOS
	Basic View	It shows whole folder. You can view the photo by selecting the folder.			
	Title	It sorts and displays the file title in Symbol / Number / Alphabet / Special order.			
	Preference	It sorts and displays the file by preference. You can change the file preference in the file list section using the Green button.			
	Latest Date	It sorts and shows files by latest date.			

CATEGORY		OPERATIONS	VIDEOS	MUSIC	PHOTOS
	Earliest Date	It sorts and shows files by earliest date.	✓		✓
	Artist	It sorts the music file by artist in alphabetical.		✓	
	Album	It sorts the music file by album in alphabetical order.		✓	
	Genre	It sorts music files by the genre.		✓	
	Mood	It sorts music files by the mood. You can change the music mood information.		✓	
	Monthly	It sorts and shows photo files by month. It sorts only by month (from January to December) regardless of year.			✓

Videos / Music / Photos Play Option menu

During playing a file, press the TOOLS button.

CATEGORY	OPERATIONS	VIDEOS	MUSIC	PHOTOS
Title	You can move the other file directly.	✓		
Repeat Mode	You can play movie and music files repeatedly.	✓	✓	
Picture Size	You can adjust the picture size for preference.	✓		
Picture Setting	You can adjust the picture setting.	✓		✓
Sound Setting	You can adjust the sound setting.	✓	✓	✓
Subtitle Setting	You can play the video file with Subtitle. This function only works if the subtitles are the same file name as the video file.	✓		
Audio	You can enjoy video in one of supported languages as required. The function is only enabled when stream-type files which support multiple audio formats are played.	✓		
Stop Slide Show / Start Slide Show	You can start or stop a slide show.			✓
Slide Show Speed	You can select the slide show speed during the slide show.			✓
Background Music	You can set and select background music when watching a slide show.			✓
Zoom	You can zoom into images in full screen mode.			✓
Rotate	You can rotate images in full screen mode.			✓
Information	You can see detailed information about the played file.	✓	✓	✓

Settings

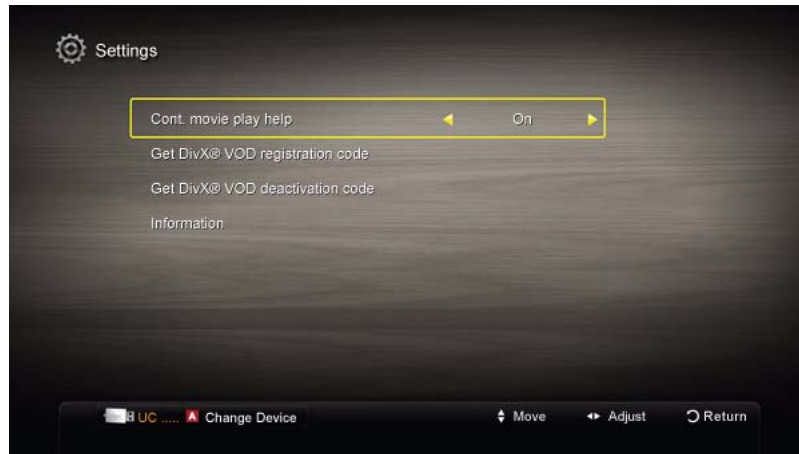

Using the Settings Menu

MENU	DESCRIPTION
Cont. movie play help	Select to display the help pop-up message for continuous movie playback. <ul style="list-style-type: none">• <On> - <Off>
Get DivX® VOD registration code	Shows the registration code authorized for the TV. If you connect to the DivX web site and register the registration code with a personal account, you can download VOD registration file. If you play the VOD registration using <Media Play>, the registration is completed.  For more information on DivX® VOD, visit "www.DivX.com."
Get the DivX® VOD deactivation code	When DivX® VOD is not registered, the registration deactivation code is displayed. If you execute this function when DivX® VOD is registered, the current DivX® VOD registration is deactivated.
Information	Select to view information about the connected device.

3-7 Anynet+ (HDMI-CEC)

What is <Anynet+>?

<Anynet+> is a function that enables you to control all connected **Samsung** devices that support <Anynet+> with your Samsung TV's remote. The <Anynet+ > system can be used only with **Samsung** devices that have the <Anynet+> feature. To be sure your Samsung device has this feature, check if there is an <Anynet+> logo on it.

Connecting Anynet+ Devices

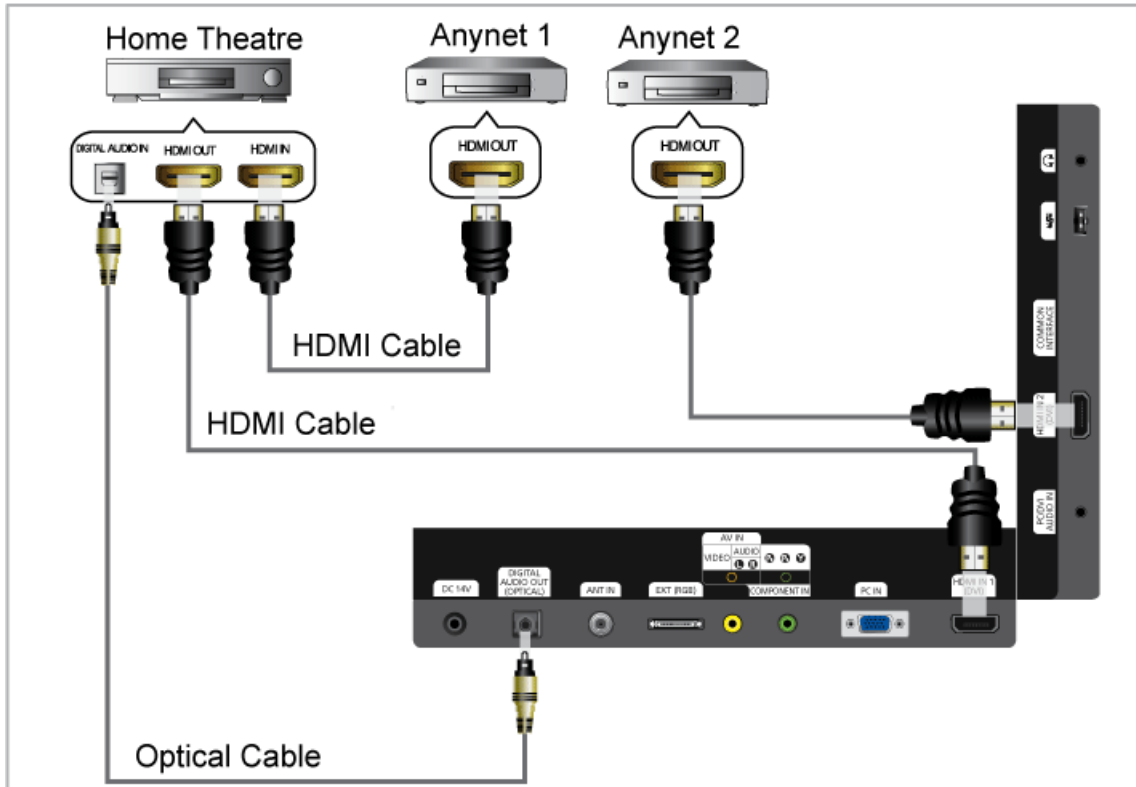

1. Connect the [HDMI IN 1, 2 (DVI)] jack on the TV and the HDMI OUT jack of the corresponding <Anynet+> device using an HDMI cable.
 2. Connect the HDMI IN jack of the home theatre and the HDMI OUT jack of the corresponding <Anynet+> device using an HDMI cable.
- Connect the Optical cable between the [DIGITAL AUDIO OUT (OPTICAL)] jack on your TV and the Digital Audio Input on the Home Theatre.
 - When following the connection above, the Optical jack only outputs 2 channel audio. You will only hear sound from the Home Theatre's Front Left and Right speakers and the subwoofer. If you want to hear 5.1 channel audio, connect the [DIGITAL AUDIO OUT (OPTICAL)] jack on the DVD / Satellite Box (i.e. Anynet Device 1 or 2) directly to the Amplifier or Home Theatre, not the TV.
 - You can connect only one Home Theatre.
 - You can connect an <Anynet+> device using the HDMI cable. Some HDMI cables may not support <Anynet+> functions.
 - <Anynet+> works when the AV device supporting <Anynet+> is in the Standby or On status.
 - <Anynet+> supports up to 10 AV devices in total. Note that you can connect up to 3 devices of the same type.

<Anynet+> Menu

The <Anynet+> menu changes depending on the type and status of the Anynet+ devices connected to the TV.



<ANYNET+> MENU	DESCRIPTION
View TV	Changes <Anynet+> mode to TV broadcast mode.
Device List	Shows the Anynet+ device list.
Recording: (*recorder)	Starts recording immediately using the recorder. (This is only available for devices that support the recording function.)
(device_name) MENU	Shows the connected device menus. E.g. If a DVD recorder is connected, the disc menu of the DVD recorder will appear.
(device_name) INFO	Shows the play menu of the connected device. E.g. If a DVD recorder is connected, the play menu of the DVD recorder will appear.
Stop Recording: (*recorder)	Stops recording.
Receiver	Sound is played through the receiver.

If more than one recording device is connected, they are displayed as (*recorder) and if only one recording device is connected, it will be represented as (*device_name).

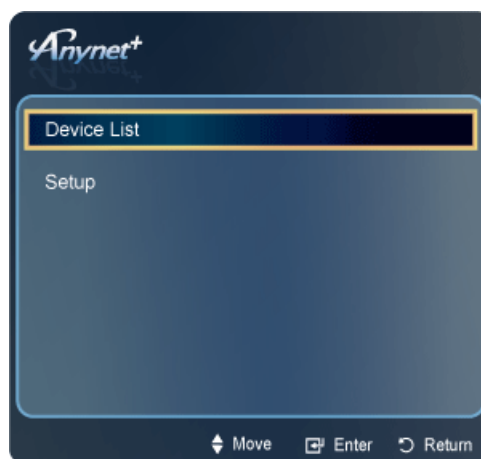
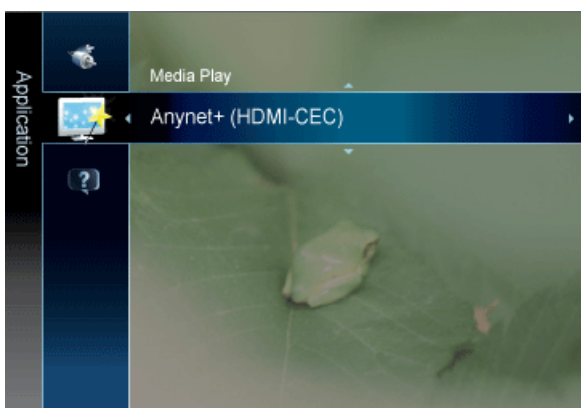
Setting Up <Anynet+>



Press the [TOOLS] button to display the <Tools> menu. You can also display the <Anynet+> menu by selecting <Tools> → <Anynet+ (HDMI-CEC)>

MENU	DESCRIPTION
Device List	<p>1. Press the [TOOLS] button. Press the [↵] button to select <Anynet+ (HDMI-CEC)>.</p> <p>2. Press the ▲ or ▼ button to select <Device List>, then press the [↵] button.</p> <ul style="list-style-type: none"> - <Anynet+> devices connected to the TV are listed. - If you cannot find a device you want, press the red button to scan for devices. <p>3. Press the ▲ or ▼ button to select a particular device and press the [↵] button. It is switched to the selected device.</p> <ul style="list-style-type: none"> - <Anynet+ (HDMI-CEC)> must be set to <On> in the <Application> menu for the <Device List> menu to appear. <p> Switching to the selected devices may take up to 2 minutes. You cannot cancel the operation during the switching operation.</p> <p>The time required to scan for devices is determined by the number of connected devices.</p> <p>When the device scan is complete, the number of devices found are not displayed.</p> <p>Although the TV automatically searches the device list when the TV is turned on via the power button, devices connected to the TV may not always be automatically displayed in the device list. Press the red button to search for the connected device.</p> <p>If you have selected external input mode by pressing the [SOURCE] button, you cannot use the <Anynet+> function. Make sure to switch to an <Anynet+> device by using the <Device List>.</p>
Setup	<ul style="list-style-type: none"> • <Anynet+ (HDMI-CEC)> <ul style="list-style-type: none"> To use the <Anynet+> Function, <Anynet+ (HDMI-CEC)> must be set to <On>.  When the <Anynet+ (HDMI-CEC)>function is disabled, all the <Anynet+> related operations are deactivated. • <Auto Turn Off> <ul style="list-style-type: none"> Setting an <Anynet+> Device to turn Off automatically when the TV is turned off.  The active source on the TV remote must be set to TV to use the <Anynet+> function. <p>If you set <Auto Turn Off> to <Yes>, connected external devices are also turned off when the TV is turned off. If an external device is still recording, it may or may not turn off.</p>

3-8 Installing the Device Driver

If you install the device driver, you can set up the appropriate resolution and frequency for the product. The device driver is included on the CD supplied with the product. If the supplied drive file is corrupted, please visit the Samsung Electronics website (www.samsung.com), and download the driver.

1. Insert the driver installation CD into the CD-ROM drive.
2. Click on Windows Driver.
3. Complete the remaining installation steps according to the instructions displayed on the screen.
4. Select the model of your product from the model list.

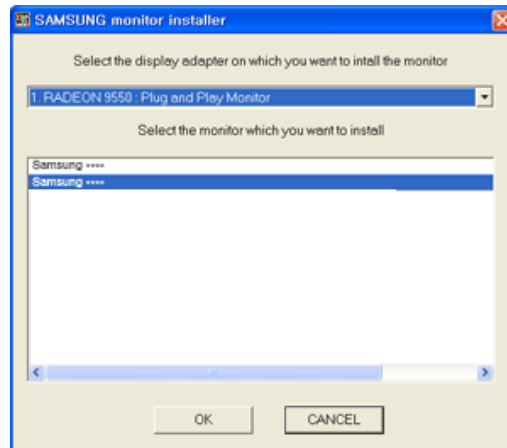

5. Check if the appropriate resolution and screen refresh rate are displayed in the Control Panel settings. For more information, refer to the document about the Windows operating system.

3-9 Standard Signal Mode Table

- This product delivers the best picture quality when viewed under the optimal resolution setting. The optimal resolution setting is dependent on the screen size.

Therefore, the visual quality will be degraded if the optimal resolution is not set for the panel size. It is recommended setting the resolution to the optimal resolution of the product.

PC Timing (D-Sub and HDMI input)

If the signal from the PC is one of the following standard signal modes, the screen is set automatically. However, if the signal from the PC is not one of the following signal modes, a blank screen may be displayed or only the Power LED may be turned on. Therefore, configure it as follows referring to the User Manual of the graphics card.

RESOLUTION	HORIZONTAL FREQUENCY (KHZ)	VERTICAL FREQUENCY (HZ)	CLOCK FREQUENCY (MHZ)	POLARITY (H/V)
IBM, 640 x 350	31.469	70.086	25.175	+/-
IBM, 640 x 480	31.469	59.940	25.175	-/-
IBM, 720 x 400	31.469	70.087	28.322	-/+
MAC, 640 x 480	35.000	66.667	30.240	-/-
MAC, 832 x 624	49.726	74.551	57.284	-/-
MAC, 1152 x 870	68.681	75.062	100.000	-/-
VESA, 640 x 480	37.861	72.809	31.500	-/-
VESA, 640 x 480	37.500	75.000	31.500	-/-
VESA, 800 x 600	35.156	56.250	36.000	+/+
VESA, 800 x 600	37.879	60.317	40.000	+/+
VESA, 800 x 600	48.077	72.188	50.000	+/+
VESA, 800 x 600	46.875	75.000	49.500	+/+
VESA, 1024 x 768	48.363	60.004	65.000	-/-
VESA, 1024 x 768	56.476	70.069	75.000	-/-
VESA, 1024 x 768	60.023	75.029	78.750	+/+
VESA, 1152 x 864	67.500	75.000	108.000	+/+
VESA, 1280 X 800	49.702	59.810	83.500	-/+
VESA, 1280 X 960	60.000	60.000	108.000	+/+
VESA, 1280 X 1024	63.981	60.020	108.000	+/+
VESA, 1280 X 1024	79.976	75.025	135.000	+/+
VESA, 1440 x 900	55.935	59.887	106.500	-/+
VESA, 1680 x 1050	65.290	59.954	146.250	-/+
VESA, 1920 x 1080	67.500	60.000	148.500	+/+

Horizontal Frequency

The time taken to scan one line from the left-most position to the right-most position on the screen is called the horizontal cycle and the reciprocal of the horizontal cycle is called the horizontal frequency. The horizontal frequency is represented in kHz.

Vertical Frequency

A panel must display the same picture on the screen tens of times every second so that humans can see the picture. This frequency is called the vertical frequency. The vertical frequency is represented in Hz.

4 Installing the Software

4-1 Natural Color

What is Natural Color ?

This software is for Samsung products only and enables you to adjust the displayed colours on the product so they more closely match the colours of printed pictures. For more information, refer to the online help of the software (F1).

Natural Color is provided online. You can download it from the website below and install;



http://www.samsung.com/us/consumer/learningresources/monitor/naturalcolorexpert/pop_download.html

What is MultiScreen ?



MultiScreen enables you to partition multiple sections on the product.

Installing the Software

1. Insert the installation CD into the CD-ROM drive.
2. Select the MultiScreen setup program.
 -  If the pop-up screen for the software installation does not appear on the main screen, find and double-click the MultiScreen setup file on the CD-ROM.
3. When the Installation Wizard appears, click [Next].
4. Complete the remaining software installation steps according to the instructions displayed on the screen.
 - 
 - The software may not work properly if you do not restart the computer after the installation.
 - The MultiScreen icon may not appear depending on the computer system and the product specifications.
 - If the shortcut icon does not appear, press the F5 key.

MultiScreen Installation Requirements

The MultiScreen installation may be affected by the graphics card, motherboard and the networking environment.

Operating System

OS

- Windows 2000
- Windows XP Home Edition
- Windows XP Professional
- Windows Vista 32Bit
- Windows 7 32Bit

 For MultiScreen, Windows 2000 or later operating systems are recommended.

Hardware

- At least 32MB of memory
- At least 60MB of free space on the hard disk drive

Removing the Software

Click [Start], select [Settings]/[Control Panel], and then double-click [Add or Remove Programs].

Select MultiScreen from the program list and click the [Add/Delete] button.

5 Troubleshooting

5-1 Product Self-Diagnosis

- You can check if the product is working properly using the Self-Diagnosis function.
- If a blank screen is displayed and the Power LED blinks even if the product and the PC are properly connected, perform the self-diagnosis function according to the procedures below.

1. Turn the product and the PC off.
2. Remove the D-Sub cable from the product.
3. Turn the product on.
4. If the product is working properly, the <Check Signal Cable> message appears.

In this case, if a blank screen is displayed again, make sure that there is no problem with the PC and the connection.

5-2 Before Requesting Service

- ☞ Please check the following before requesting After-Sales service. If the problem continues, please contact your nearest Samsung Electronics Service Centre.

PROBLEMS RELATED TO INSTALLATION (PC MODE)	
The monitor screen flickers.	Check if the signal cable between the computer and the monitor is securely connected and tightened. (Refer to Connecting to a Computer)
Blank spaces are found at the top and bottom of the screen when an HDMI or HDMI-DVI cable is connected to the monitor and PC.	Blank spaces on the screen are not caused by the monitor. The cause of the problem is the PC or graphics card, and can be fixed by adjusting the screen size in the HDMI or DVI option of the graphics card settings menu. If the graphics card settings menu has no option to adjust the screen size, update the graphics card driver to the latest version. (Please contact the graphics card or computer manufacturer for details on how to adjust the screen settings.)
PROBLEMS RELATED TO SCREEN	
Screen is blank and power indicator is off.	Ensure that the power cord is firmly connected and the product is on. (Refer to Connecting to a Computer)
<Check Signal Cable> message	Ensure that the signal cable is firmly connected to the PC or video sources. (Refer to Connecting to a Computer)
<Mode not supported> message is shown	Check the maximum resolution and the frequency of the video adapter. Compare these values with the data in the Standard Signal Mode Table.
Picture rolls vertically.	Check if the signal cable is securely connected. Connect it again securely. (Refer to Connecting to a Computer)
Image is not clear. Picture is blurred.	Run Frequency <Coarse > and < Fine> tuning. Turn on again after removing all accessories(video extension cable, etc.) Set resolution and frequency to the recommended ranges.
Picture image is unstable and vibrates.	Check if the resolution and frequency set for the computer video card falls in the range supported by the monitor. If not, reset them referring to the current <Information> under the monitor menu and Standard Signal Mode Table.
Ghost images are shown in the picture.	
The image is too light or too dark	Adjust the Brightness and Contrast (Refer to the <Brightness>, <Contrast>) The display brightness can differ according to the mode set for <MagicAngle>. If <MagicBright> is set to <Dynamic Contrast>, the display brightness can differ according to the input signal.
Screen is blank and the power indicator light blinks every 0.5 or 1 seconds	The monitor is using its power management system Press a key on the keyboard
The screen is blank and is blinking.	If you see the TEST GOOD message on the screen when you press the [MENU] button, check the cable connection between the monitor and the computer to ensure that the connector is properly connected.

PROBLEMS RELATED TO AUDIO

No sound

Ensure that the audio cable is firmly connected to both the audio-in port on your monitor and the audio-out port on your sound card.

(Refer to Connecting to a Computer)

Check the volume level.

The sound level is too low.

Check the volume level.

If the volume is still too low after turning the control to its maximum, check the volume control on the computer sound card or software program.

PROBLEMS RELATED TO REMOTE CONTROL

The remote control buttons do not respond.

Check the battery polarities (+/-).

Check if the batteries have been exhausted.

Check if the power is on.

Check if the power cord is securely connected.

Check if a special fluorescent or neon lamp is on in the vicinity

NOTE ON THE PRODUCT APPEARANCE

You may see small particles if you look closely at the edge of the bezel surrounding the screen.

This is part of the product's design and is not a defect.

FAQ	PLEASE TRY THE FOLLOWING!
How can I change the frequency of the video signal?	<p>You have to change the frequency of the graphics card.</p> <p>Windows XP : Change the frequency by selecting Control Panel → Appearance and Themes → Display → Settings → Advanced → Monitor, and then change the refresh rate under Monitor Settings.</p> <p>Windows ME/2000 : Change the frequency by selecting Control Panel → Display → Settings → Advanced → Monitor, and then change the refresh rate under Monitor Settings.</p> <p>Windows Vista : Change the frequency by selecting Control Panel → Appearance and Personalization → Personalization → Display settings → Advanced settings → Monitor, and then change the refresh rate under Monitor Settings.</p> <p>Windows 7 : Change the frequency by selecting Control Panel → Appearance and Personalization → Display → Adjust resolution → Advanced settings → Monitor, and then change the refresh rate under Monitor Settings.</p> <p>(For more information, refer to the User Manual of the computer or the graphics card.)</p>
How can I change the resolution?	<p>Windows XP : Change the resolution by selecting Control Panel → Appearance and Themes → Display → Settings.</p> <p>Windows ME/2000 : Change the resolution by selecting Control Panel → Display → Settings.</p> <p>Windows Vista : Change the resolution by selecting Control Panel → Appearance and Personalization → Personalization → Display settings.</p> <p>Windows 7 : Change the resolution by selecting Control Panel → Appearance and Personalization → Display → Adjust resolution.</p> <p>(For more information, refer to the User Manual of the computer or the graphics card.)</p>
How can I use the power saving function?	<p>Windows XP : Configure it by selecting Control Panel → Appearance and Themes → Display → Screen Saver Setting or configure it in the BIOS Setup of the computer.</p> <p>Windows ME/2000 : Configure it by selecting Control Panel → Display → Screen Saver Setting or Configure it in the BIOS Setup of the computer.</p> <p>Windows Vista : Change settings by selecting Control Panel → Appearance and Personalization → Personalization → Screen Saver. You can also use the BIOS SETUP menu on the PC.</p> <p>Windows 7 : Change settings by selecting Control Panel → Appearance and Personalization → Personalization → Screen Saver. You can also use the BIOS SETUP menu on the PC.</p> <p>(For more information, refer to the Windows user manual for the computer.)</p>
How can I clean the outer case/Panel?	<p>Disconnect the power cord and then clean the monitor with a soft cloth, using either a plain water.</p> <p>Do not leave any detergent or scratches on the case.</p> <p>Do not let any water enter the monitor.</p>

FAQ	PLEASE TRY THE FOLLOWING!
<p>Can I watch digital TV broadcasting with an analogue TV?</p>	<p>No. The analogue TV cannot interpret digital signals. Therefore, a digital TV is required to watch digital TV broadcasting.</p>
<p>Can I use my present antenna to receive digital broadcasting?</p>	<p>As for existing analogue TV, digital TV is designed so that digital broadcasting signals are received via both indoor and outdoor antennas. If signal reception is very good in your environment, you can watch digital broadcasts with your existing indoor antenna. If not, it is better to install an outdoor antenna.</p>

6 More Information

6-1 Specifications

MODEL NAME		FX2490HD
Panel	Screen Size	24 inches (61 cm)
	Display Area	531.36 mm (H) x 298.89mm (V)
	Pixel Pitch	0.27675 mm (H) x 0.27675 mm (V)
Synchronization	Horizontal Frequency	30 ~81 kHz
	Vertical Frequency	56 ~ 75 Hz
Colour		16.7 M
Resolution	Optimal Resolution	1920 x 1080 @ 60 Hz
	Maximum Resolution	1920 x 1080 @ 60 Hz
Input Signal, Terminated		Analogue(D-Sub port), Digital DVI(HDMI port) 0.7 Vp-p ± 5 % Separate Type H/V Sync, Composite TTL Level (V high ≥ 2.0 V, V low ≤ 0.8 V)
Maximum Pixel Clock		148.500 MHz (Analogue, Digital)
Power Supply		This product supports 100 – 240 V. Since the standard voltage may differ from country to country, please check the label on the back of the product. (DC 14V  4.5A)
Dimension (Width x Height x Depth) / Weight		579.0 x 363.0 x 36.5 mm (22.8 x 14.3 x 1.4 inches) (Without Stand) 579.0 x 436.0 x 216.0 mm (22.8 x 17.2 x 8.5 inches) (With Stand) / 5.3 kg (11.7 lbs)
Environmental considerations	Operating	Temperature : 50°F ~ 104°F (10°C ~ 40°C) Humidity : 10 % ~ 80 %, non-condensing
	Storage	Temperature : -4°F ~ 113°F (-20°C ~ 45°C) Humidity : 5 % ~ 95 %, non-condensing
Tilt		-1° ~ 21° (±1°)

 Design and specifications are subject to change without prior notice.

 Class B (Information Communication equipment for residential use)

This device is registered for EMC requirements for home use (Class B). It can be used in all areas.

(Class B equipment emits less electromagnetic waves than Class A equipment.)

6-2 Power Saving Function

This product provides a power saving function that automatically turns the screen off when the product is not used for a predetermined period of time to reduce power consumption. If the product enters power saving mode, the power LED turns to a different Colour to indicate that the product is in power saving mode.

When the product is in power saving mode, the power is not turned off and you can turn the screen on again by pressing any key or clicking the mouse. However, the power saving function only works when the product is connected to a computer that provides the power saving function.

POWER SAVING FUNCTION	NORMAL OPERATION	POWER SAVING MODE (DPM)	POWER OFF (POWER BUTTON)
Power LED	On	Blinks	Off
Power Consumption	35 Watts	Analogue : less than 0.3 Watts	less than 0.3 Watts

- The actual power consumption may be different from the indicated power consumption above if the system conditions or settings are changed.
- If there is no power cut-off switch, the power consumption is "0" only when the power cord is disconnected.
- DPM(Display Power Management) Function does not work if you used in conjunction with the [HDMI IN 1, 2 (DVI)] port of this product.

6-3 Contact SAMSUNG WORLDWIDE

 If you have any questions or comments relating to Samsung products, please contact the SAMSUNG customer care centre.

EUROPE		
AUSTRIA	0810 - SAMSUNG(7267864,€ 0.07/min)	http://www.samsung.com
BELGIUM	02-201-24-18	http://www.samsung.com/be (Dutch) http://www.samsung.com/be_fr (French)
CZECH	800 - SAMSUNG (800-726786)	http://www.samsung.com
	Distributor pro Českou republiku: Samsung Zrt, česká organizační složka, Oasis Florenc, Sokolovská394/17, 180 00, Praha 8	
DENMARK	70 70 19 70	http://www.samsung.com
EIRE	0818 717100	http://www.samsung.com
ESTONIA	800-7267	http://www.samsung.com
FINLAND	030 - 6227 515	http://www.samsung.com
FRANCE	01 48 63 00 00	http://www.samsung.com
GERMANY	01805 - SAMSUNG (726-7864,€ 0,14/Min)	http://www.samsung.com
HUNGARY	06-80-SAMSUNG(726-7864)	http://www.samsung.com
ITALIA	800-SAMSUNG(726-7864)	http://www.samsung.com
LATVIA	8000-7267	http://www.samsung.com
LITHUANIA	8-800-77777	http://www.samsung.com
LUXEMBURG	261 03 710	http://www.samsung.com
NETHERLANDS	0900 - SAMSUNG (0900-7267864) (€ 0,10/Min)	http://www.samsung.com
NORWAY	815-56 480	http://www.samsung.com
POLAND	0 801 1SAMSUNG (172678) 022 - 607 - 93 - 33	http://www.samsung.com
PORTUGAL	80820 - SAMSUNG (726-7864)	http://www.samsung.com
SLOVAKIA	0800-SAMSUNG(726-7864)	http://www.samsung.com
SPAIN	902 - 1 - SAMSUNG (902 172 678)	http://www.samsung.com
SWEDEN	0771 726 7864 (SAMSUNG)	http://www.samsung.com
SWITZERLAND	0848-SAMSUNG(7267864, CHF 0.08/min)	http://www.samsung.com/ch http://www.samsung.com/ch_fr (French)
U.K	0845 SAMSUNG (7267864)	http://www.samsung.com
CIS		
ARMENIA	0-800-05-555	
AZERBAIJAN	088-55-55-555	
BELARUS	810-800-500-55-500	
GEORGIA	8-800-555-555	

CIS		
KAZAKHSTAN	8-10-800-500-55-500	
KYRGYZSTAN	00-800-500-55-500	http://www.samsung.com
MOLDOVA	00-800-500-55-500	
RUSSIA	8-800-555-55-55	http://www.samsung.com
TADJIKISTAN	8-10-800-500-55-500	http://www.samsung.com
UKRAINE	0-800-502-000	http://www.samsung.com/ua http://www.samsung.com/ua_ru
UZBEKISTAN	8-10-800-500-55-500	http://www.samsung.com

6-4 Correct Disposal

CORRECT DISPOSAL OF THIS PRODUCT (WASTE ELECTRICAL & ELECTRONIC EQUIPMENT)



(Applicable in the European Union and other European countries with separate collection systems)

This marking on the product, accessories or literature indicates that the product and its electronic accessories (e.g. charger, headset, USB cable) should not be disposed of with other household waste at the end of their working life. To prevent possible harm to the environment or human health from uncontrolled waste disposal, please separate these items from other types of waste and recycle them responsibly to promote the sustainable reuse of material resources.

Household users should contact either the retailer where they purchased this product, or their local government office, for details of where and how they can take these items for environmentally safe recycling.

Business users should contact their supplier and check the terms and conditions of the purchase contract. This product and its electronic accessories should not be mixed with other commercial wastes for disposal.

CORRECT DISPOSAL OF BATTERIES IN THIS PRODUCT - EUROPE ONLY



(Applicable in the European Union and other European countries with separate battery return systems.)

This marking on the battery, manual or packaging indicates that the batteries in this product should not be disposed of with other household waste at the end of their working life. Where marked, the chemical symbols Hg, Cd or Pb indicate that the battery contains mercury, cadmium or lead above the reference levels in EC Directive 2006/66. If batteries are not properly disposed of, these substances can cause harm to human health or the environment.

To protect natural resources and to promote material reuse, please separate batteries from other types of waste and recycle them through your local, free battery return system.

-  The rechargeable battery incorporated in this product is not user replaceable. For information on its replacement, please contact your service provider.