



HP EliteBook 2540p Notebook PC

Maintenance and Service Guide

© Copyright 2010 Hewlett-Packard
Development Company, L.P.

Bluetooth is a trademark owned by its proprietor and used by Hewlett-Packard Company under license. Intel and Core are U.S. registered trademarks of Intel Corporation. Java is a U.S. trademark of Sun Microsystems, Inc. Microsoft, Windows, and Windows Vista are U.S. registered trademarks of Microsoft Corporation. SD Logo is a trademark of its proprietor.

The information contained herein is subject to change without notice. The only warranties for HP products and services are set forth in the express warranty statements accompanying such products and services. Nothing herein should be construed as constituting an additional warranty. HP shall not be liable for technical or editorial errors or omissions contained herein.

First Edition: March 2010

Document Part Number: 592768-001

MSG Revision history

Revision	Publication date	Description
A	December 2010	<p>The 6.35-cm (2.50-in) hard drive is installed in the optical drive bay, using a hard drive carrier, spare part number 598787-001. The information was updated in the following locations: Illustrated parts catalog on page 19, Sequential part number listing on page 32, and Standard-voltage hard drive or solid-state drive on page 61.</p> <p>The computer feet are hot melted to the base enclosure and cannot be replaced. The information was updated in the following location: Computer feet on page 43.</p>

Safety warning notice

 **WARNING!** To reduce the possibility of heat-related injuries or of overheating the computer, do not place the computer directly on your lap or obstruct the computer air vents. Use the computer only on a hard, flat surface. Do not allow another hard surface, such as an adjoining optional printer, or a soft surface, such as pillows or rugs or clothing, to block airflow. Also, do not allow the AC adapter to contact the skin or a soft surface, such as pillows or rugs or clothing, during operation. The computer and the AC adapter comply with the user-accessible surface temperature limits defined by the International Standard for Safety of Information Technology Equipment (IEC 60950).

Table of contents

1 Product description	1
2 External component identification	7
Display components	8
Buttons and fingerprint reader	10
Keys	12
Pointing device components	13
Front components	14
Left-side components	15
Rear components	16
Right-side components	16
Bottom components	17
3 Illustrated parts catalog	19
Serial number location	19
Computer major components	20
Display components	26
Mass storage	28
Plastics Kit	30
Miscellaneous parts	31
Sequential part number listing	32
4 Removal and replacement procedures	37
Preliminary replacement requirements	37
Tools required	37
Service considerations	37
Plastic parts	37
Cables and connectors	38
Drive handling	38
Grounding guidelines	39
Electrostatic discharge damage	39
Packaging and transporting guidelines	40
Workstation guidelines	40
Equipment guidelines	41
Component replacement procedures	42
Service tag	42

Computer feet	43
Battery	44
SIM	45
Bluetooth module	46
Expansion memory module	48
Low-voltage hard drive or solid-state drive	50
WLAN module	53
WWAN module	57
Optical drive	59
Standard-voltage hard drive or solid-state drive	61
Switch cover and keyboard	65
RTC battery	69
Primary memory module	70
Display assembly	72
Top cover	81
Card reader board	84
Speaker	86
Bluetooth module cable	87
System board	89
Modem module	92
Fan/heat sink assembly	93

5 Computer Setup 96

Windows 7	96
Starting Computer Setup	96
Using Computer Setup	96
Navigating and selecting in Computer Setup	96
Restoring factory settings in Computer Setup	97
Computer Setup menus	98
File menu	98
Security menu	99
System Configuration menu	100
Windows Vista	103
Starting Computer Setup	103
Using Computer Setup	103
Navigating and selecting in Computer Setup	103
Restoring factory settings in Computer Setup	105
Computer Setup menus	106
File menu	106
Security menu	107
System Configuration menu	108

Windows XP	112
Starting Computer Setup	112
Using Computer Setup	112
Navigating and selecting in Computer Setup	112
Restoring factory settings in Computer Setup	113
Computer Setup menus	114
File menu	114
Security menu	115
System Configuration menu	116
6 Specifications	120
Computer specifications	120
12.1-in display specifications	121
Hard drive specifications	121
DVD±RW and CD-RW SuperMulti Double-Layer Drive specifications	122
DVD-ROM Drive specifications	122
7 Backup and recovery	124
Windows 7	124
Backing up your information	125
Performing a recovery	126
Using the Windows recovery tools	126
Using f11 recovery tools	127
Using a Windows 7 operating system DVD (purchased separately)	128
Windows Vista	128
Backing up your information	129
Performing a recovery	130
Using the Windows recovery tools	130
Using f11 recovery tools	131
Using a Windows Vista operating system DVD (purchased separately)	131
Windows XP	133
Backing up your information	133
Performing a recovery	134
Recovering your information	134
Recovering the operating system and programs	134
8 Connector pin assignments	135
1394	135
Audio-in (microphone)/audio-out (headphone) combo	135
DisplayPort	136

External monitor	137
RJ-11 (modem)	138
RJ-45 (network)	138
Universal Serial Bus	139
9 Power cord set requirements	140
Requirements for all countries	140
Requirements for specific countries and regions	141
10 Recycling	142
Battery	142
Display	142
Index	148

1 Product description

Category	Description
Product Name	HP EliteBook 2540p Notebook PC
Processors	<p>Intel® Dual Core™ processors (support Intel Turbo Boost Technology):</p> <ul style="list-style-type: none">• Intel Dual Core i7-640LM 2.13-GHz processor, (turbo up to 2.93-GHz), 4-MB L3 cache, 4 threads, low-voltage (25-W)• Intel Dual Core i7-620M 2.66-GHz processor, (turbo up to 3.33-GHz), 4-MB L3 cache, 4 threads, standard-voltage (35-W)• Intel Dual Core i5-540M 2.53-GHz processor, (turbo up to 3.06-GHz), 3-MB L3 cache, 4 threads, standard-voltage (35-W)• Intel Dual Core i5-520M 2.40-GHz processor, (turbo up to 2.93-GHz), 3-MB L3 cache, 4 threads, standard-voltage (35-W)
Chipset	Mobile Intel QM57 Express chipset (non-HDI)
Graphics	Intel HD Graphics with up to 512-MB unified memory architecture (UMA) graphics subsystem memory
Panel	<p>All display assemblies include 2 wireless local area network (WLAN) antenna cables and 2 wireless wide area network (WWAN) antenna cables:</p> <ul style="list-style-type: none">• 12.1-in WXGA light-emitting diode (LED), AntiGlare (AG) with webcam• 12.1-in WXGA LED, AG without webcam <p>Supports privacy filter</p> <p>Supports 16:10 resolution</p> <p>Supports 1280 ×800 resolution</p>
Memory	<p>2 customer-accessible/upgradable memory module slots</p> <p>Supports up to 8192 GB of system RAM</p> <p>DDR3 1333-MHz, PC3-10600</p> <p>Supports the following configurations:</p> <ul style="list-style-type: none">• 8192-MB total system memory (4096 × 2)• 6144-MB total system memory (4096 + 2048)• 4096-MB total system memory (4096 × 1, 2048 × 2)• 3072-MB total system memory (2048 + 1024)• 2048-MB total system memory (2048 × 1, 1024 × 2)• 1024-MB total system memory (1024 × 1)

Category	Description
Internal storage	<p>Computer models equipped with a standard-voltage (35-W) processor support the following 2.5-in storage devices:</p> <ul style="list-style-type: none"> • 500-GB hard drive (7200-rpm, SMART SATA II) • 320-GB hard drive (7200-rpm, SMART SATA II) • 320 self-encrypting drive (SED) GB hard drive (7200-rpm, SMART SATA II) • 250-GB hard drive (7200-rpm, SMART SATA II) <p>– or –</p> <ul style="list-style-type: none"> • 160-GB solid-state drive • 80-GB solid-state drive <p>NOTE: The 1.8-in hard drive bay is not supported on computer models equipped with a standard-voltage (35-W) processor.</p>
	<p>Computer models equipped with a low-voltage (25-W) processor support the following storage devices:</p> <ul style="list-style-type: none"> • In the 1.8-in hard drive bay: <ul style="list-style-type: none"> ◦ 320-GB hard drive (5400-rpm, SMART SATA II) ◦ 250-GB hard drive (5400-rpm, SMART SATA II) ◦ 160-GB hard drive (5400-rpm, SMART SATA II) <p>– or –</p> <ul style="list-style-type: none"> ◦ 160-GB solid-state drive ◦ 80-GB solid-state drive • In the 2.5-in hard drive carrier (for RAID support): 2.5-in, 250-GB, 7200-rpm SMART SATA II hard drive (requires the installation of a 1.8-in, 250-GB, 5400-rpm hard drive in the 1.8-in hard drive bay) <p>NOTE: Internal storage devices are customer-removable and will withstand multiple insertion and removal cycles. Up to 15 GB is reserved for the system recovery software.</p>
Optical drives	<p>NOTE: The optical drive is an optional feature and is available only on computer models equipped with a low voltage (25-W) processor.</p> <p>Fixed (removal of 1 screw required)</p> <p>Customer-accessible</p> <p>Serial ATA</p> <p>9.5-mm tray load</p> <p>Supports the following drives:</p> <ul style="list-style-type: none"> • DVD±RW and CD-RW SuperMulti Double-Layer Drive • DVD-ROM Drive
Audio and video	<p>Integrated dual-array microphones</p> <p>IDT 92HD75B high-definition (HD) audio</p> <p>Supports 2 stereo speakers</p> <p>Integrated 2.0-megapixel webcam with macro focus for business card reader</p>
Modem	56K V.92 1.5-in data/fax modem

Category	Description
	Supports “no modem” option
	Modem cable not included
Ethernet	Intel 82577-LM 10/100/1000 GB network interface card (NIC) with iAMT 4.0 support
	S3/S4/S5 wake on LAN: DC - no
	S3/S4/S5 wake on LAN: AC - yes
	NIC power-down technology
	Ethernet cable not included
Wireless	Integrated wireless local area network (WLAN) options by way of wireless module:
	Two WLAN antennas built into display assembly
	Support for no WLAN option
	Support for the following WLAN formats: <ul style="list-style-type: none"> • Broadcom 43224AGN 802.11 a/b/g/draft-n WiFi Adapter • Broadcom 4312G 802.11b/g WiFi Adapter • Intel Centrino Advanced-N 6200 WLAN module
	Integrated wireless wide area network (WWAN) options by way of wireless module:
	Two WWAN antennas built into display assembly (world-wide, 5-band)
	Support for no WWAN option
	Supports WWAN after-market option (product number WD301AA)
	Security provided by Subscriber Identify Module (SIM) located inside battery bay
	Support for the following WWAN formats: <ul style="list-style-type: none"> • High-Speed Packet Access (HSPA) WWAN module • HSPA Evolution-Data Optimized (EV-DO) WWAN module
	Integrated personal area network (PAN) options by way of Bluetooth® module:
	Broadcom Bluetooth specification v2.1 compliant
	Support for no-WPAN option
External media card	One ExpressCard34 slot, supporting USB and PCIe ExpressCard modules
	One Digital Media Reader slot, supporting MultiMediaCard (MMC) and Secure Digital (SD) Memory Card optional digital card formats.

Category	Description
Ports	<ul style="list-style-type: none"> • 1394a • 3-pin AC power • Headphone/microphone combo audio • DisplayPort • Docking • RJ-11 (modem) • RJ-45 (Ethernet, includes link and activity lights) • USB 2.0 (4 on computer models equipped with standard voltage processors, 3 on computer models equipped with low voltage processors; 1 powered) • VGA (Dsub 15-pin) supporting 1600 × 1200 external resolution at 75-GHz (hot plug/unplug with auto-detect)
Docking	HP 2540 Docking Station
Keyboard/pointing devices	<p>Full-size keyboard</p> <p>Dual point (pointing stick and TouchPad with scroll zone)</p> <p>Spill-resistant keyboard with HP drainage system</p>
Power requirements	<p>65-W HP Smart AC adapter with localized cable plug support (3-wire plug with ground pin, supports 3-pin DC connector)</p> <p>Supports HP Fast-Charge technology</p> <p>Supports the following primary batteries:</p> <ul style="list-style-type: none"> • 9-cell, 2.80-Ah (93-WHr) Li-ion battery • 6-cell, 2.80-Ah (62-WHr) Li-ion battery • 6-cell, 2.80-Ah (55-WHr) Li-ion long life battery • 3-cell, 2.80-Ah (31-WHr) Li-ion battery • 3-cell, 2.80-Ah (28-WHr) Li-ion long life battery
Security	<p>Integrated fingerprint reader (select models only)</p> <p>Integrated smart card reader (active)</p> <p>Full-volume encryption</p> <p>Security cable slot</p> <p>Trusted platform module (TPM) v.1.2</p>
Operating system	<p>Preinstalled:</p> <ul style="list-style-type: none"> • Windows® 7 Home Premium 32/64 • Windows 7 Professional 32/64 • Windows Vista® Home Basic • Windows Vista Business 32 with Windows 7 license • Windows XP Professional 32 with Windows 7 license • FreeDOS

Category	Description
	Preinstalled with Microsoft® Office: <ul style="list-style-type: none">• Windows 7 Home Basic 32• Windows 7 Home Premium 32/64• Windows 7 Professional 32/64• Windows Vista Home Basic• Windows Vista Business 32 with Windows 7 license• Windows Vista Business 32 with Windows 7 license with Personal without PowerPoint• Windows Vista Business 32 with Windows 7 license with Personal with PowerPoint• Windows Vista Business 32 with Windows 7 license with Professional• Windows XP Professional 32 with Windows 7 Professional license
	Restore media (OSDVD): <ul style="list-style-type: none">• Windows 7 Home Basic 32• Windows 7 Home Premium 32/64• Windows 7 Professional 32/64• Windows Vista Business 32• Windows Vista Home Basic• Windows XP Professional 32
	Certified: SUSE Linux Enterprise Desktop
	Office restore media: Office Ready restore DVD
	DRDVD (Device driver and Application DVD): <ul style="list-style-type: none">• Windows 7 with WINDVD• Windows 7 without WINDVD• Windows Vista• Windows XP Professional
	Supported: <ul style="list-style-type: none">• Microsoft WHQL• Novell

Category	Description
	Web-only support: <ul style="list-style-type: none">• Windows 7 Enterprise 32/64• Windows 7 Ultimate 32/64• Windows Vista Business 64• Windows Vista Enterprise 32/64
Serviceability	End-user replaceable parts: <ul style="list-style-type: none">• AC adapter• Bluetooth module• Battery• Expansion memory module• Hard drive• Optical drive• Power cord• Primary memory module• RTC battery• SIM• Solid-state drive• WLAN module• WWAN module

2 External component identification

Components included with the computer may vary by region and model. The illustrations in this chapter identify the standard features on most computer models.

To see a list of hardware installed in the computer, follow these steps:

In Windows 7:

- ▲ Select **Start > Control Panel > System and Security > Device Manager**.

In Windows Vista:

1. Select **Start > Computer > System Properties**.
2. In the left pane, click **Device Manager**.

 **NOTE:** Windows 7 and Windows Vista use the User Account Control feature to improve the security of your computer. You may be prompted for your permission or password for tasks such as installing software, running utilities, or changing Windows settings. Refer to Help and Support for more information.

In Windows XP:

1. Select **Start > My Computer**.
2. In the left pane of the System Tasks window, select **View system information**.
3. Select **Hardware tab > Device Manager**.

You can also add hardware or modify device configurations using Device Manager.

Display components



Item	Component	Description
1	WWAN antennas (2)*	Send and receive wireless signals to communicate with WWANs (select models only).
2	WLAN antennas (2)*	Send and receive wireless signals to communicate with WLANs (select models only).
3	Webcam light	On: The webcam is in use.
4	Webcam	Records audio and video and captures still photographs.
5	Keyboard light and button	Opens and turns on the keyboard light, which illuminates the keyboard in low-light conditions.
6	Internal microphones (2)	Record sound.

Item	Component	Description
7	Ambient light sensor	Automatically adjusts the display brightness based on the lighting conditions in your environment.

*The antennas are not visible from the outside of the computer. For optimal transmission, keep the areas immediately around the antennas free from obstructions.

To see wireless regulatory notices, refer to the section of the *Regulatory, Safety and Environmental Notices* that applies to your country or region. These notices are located in Help and Support.

Buttons and fingerprint reader



Item	Component	Description
(1)	Power button	<ul style="list-style-type: none"> When the computer is off, press the button to turn on the computer. When the computer is on, press the button to shut down the computer. <p>NOTE: Although you can shut down the computer with the power button, the recommended procedure is to use the Windows Shut down command (in Windows 7) or Windows Shut Down command (in Windows Vista and Windows XP).</p> <ul style="list-style-type: none"> When the computer is in the Sleep state (in Windows 7 and Windows Vista) or in Standby (in Windows XP), press the button briefly to exit Sleep (in Windows 7 and Windows Vista) or Standby (in Windows XP). When the computer is in Hibernation, press the button briefly to exit Hibernation. <p>If the computer has stopped responding and Windows shutdown procedures are ineffective, press and hold the power button for at least 5 seconds to turn off the computer.</p> <p>To learn more about your power settings, select:</p> <ul style="list-style-type: none"> In Windows 7, select Start > Control Panel > System and Security > Power Options In Windows Vista, select Start > Control Panel > System and Maintenance > Power Options In Windows XP, select Start > Control Panel > Performance and Maintenance > Power Options.
(2)	QuickLook button	<ul style="list-style-type: none"> When the computer is off, press the button to open HP QuickLook. When the computer is on, press the button to open HP Software Setup. <p>NOTE: If HP Software Setup is not available, the default Web browser opens.</p>
(3)	QuickWeb button	<ul style="list-style-type: none"> When the computer is off, press the button to open HP QuickWeb. When the computer is on, press the button to open the default Web browser.
(4)	Wireless button	<p>Turns the installed wireless devices on or off but does not establish a wireless connection.</p> <p>NOTE: A wireless network must be set up in order to establish a wireless connection.</p>
(5)	TouchPad on/off button	Turns the TouchPad on or off.
(6)	Volume mute button	Mutes and restores speaker sound.
(7)	Volume down button	Decreases speaker volume.

Item	Component	Description
(8)	Volume up button	Increases speaker volume.
(9)	Fingerprint reader (select models only)	Allows a fingerprint logon to Windows, instead of a password logon.

Keys

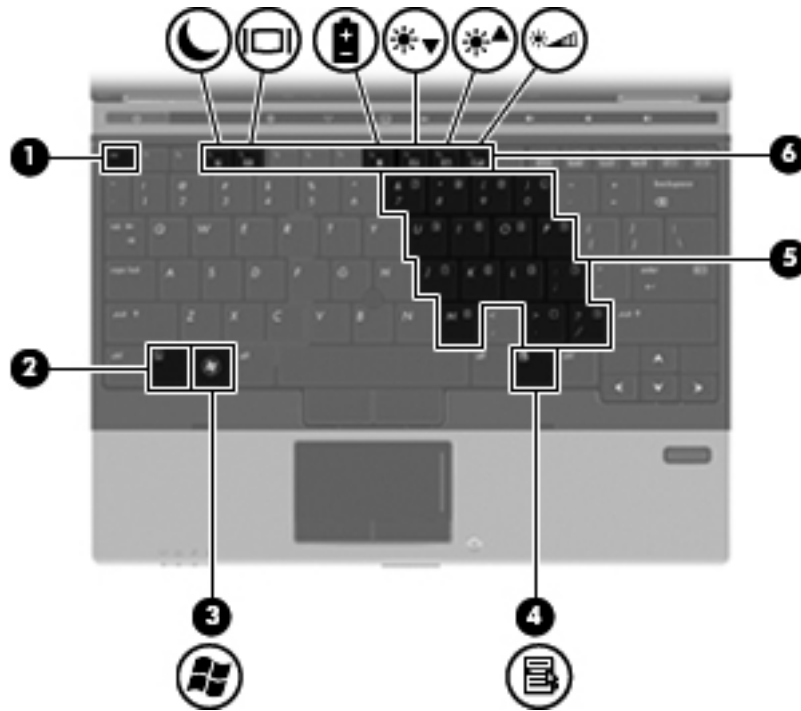

Item	Component	Description
(1)	<code>esc</code> key	Displays system information when pressed in combination with the <code>fn</code> key.
(2)	<code>fn</code> key	Executes frequently used system functions when pressed in combination with a function key or the <code>esc</code> key.
(3)	Windows logo key	Displays the Windows Start menu.
(4)	Windows applications key	Displays a shortcut menu for items beneath the pointer.
(5)	Embedded numeric keypad keys	Can be used like the keys on an external numeric keypad.
(6)	Function keys	Execute frequently used system functions when pressed in combination with the <code>fn</code> key.

Pointing device components

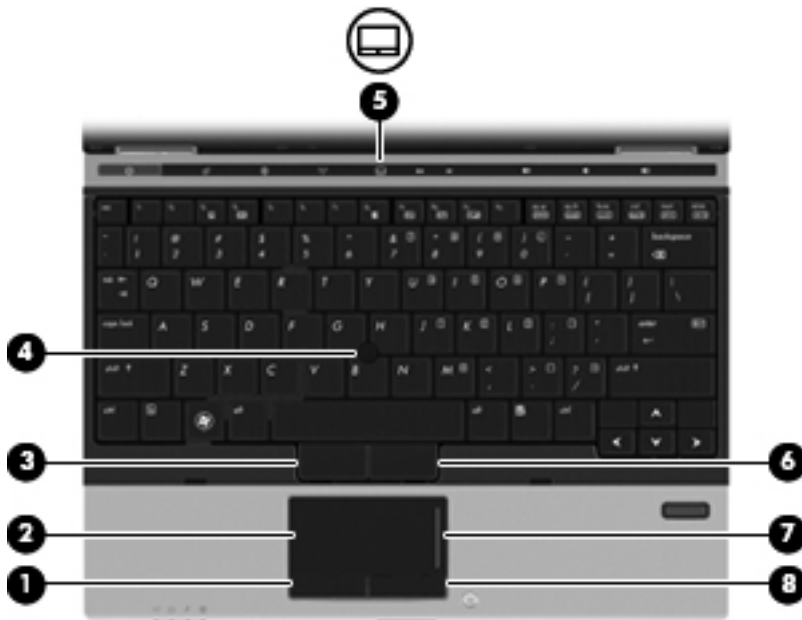

Item	Component	Description
(1)	Left TouchPad button*	Functions like the left button on an external mouse.
(2)	TouchPad*	Moves the pointer and selects or activates items on the screen.
(3)	Left pointing stick button*	Functions like the left button on an external mouse.
(4)	Pointing stick*	Moves the pointer and selects or activates items on the screen.
(5)	TouchPad on/off button	Turns the TouchPad on and off.
(6)	Right pointing stick button*	Functions like the right button on an external mouse.
(7)	TouchPad scroll zone	Scrolls up or down.
(8)	Right TouchPad button*	Functions like the right button on an external mouse.

*This table describes factory settings. To view or change pointing device preferences:

- In Windows 7, select **Start > Devices and Printers**. Then, right-click the device representing your computer, and select **Mouse settings**.
- In Windows Vista, select **Start > Control Panel > Hardware and Sound > Mouse**.
- In Windows XP, select **Start > Control Panel > Printers and Other Hardware > Mouse**.

Front components

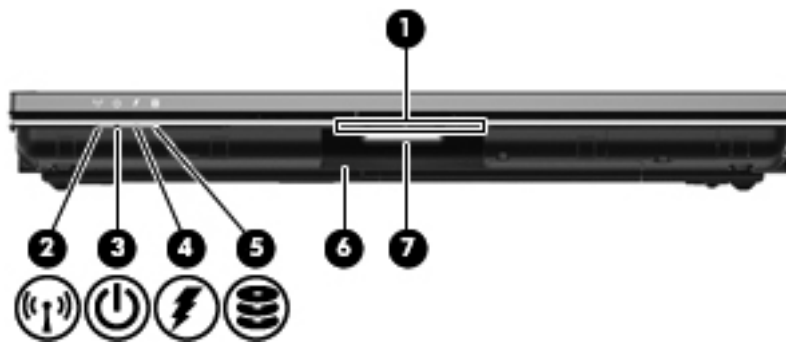

Item	Component	Description
(1)	Business card slot	Holds a business card in position so that the webcam can capture the information on the card.
(2)	Wireless light	<ul style="list-style-type: none"> Blue: An integrated wireless device, such as a WLAN device, the HP Mobile Broadband Module (select models only), and/or a Bluetooth device, is on. Amber: All wireless devices are off.
(3)	Power light	<ul style="list-style-type: none"> On: The computer is on. Blinking: The computer is in the Sleep state (Windows 7 and Windows Vista) or Standby (Windows XP). Off: The computer is off or in Hibernation.
(4)	Battery light	<ul style="list-style-type: none"> Amber: A battery is charging. White: A battery is close to full charge capacity. Blinking amber: A battery that is the only available power source has reached a low battery level. When the battery reaches a critical battery level, the battery light begins blinking rapidly. Off: If the computer is plugged into an external power source, the light turns off when all batteries in the computer are fully charged. If the computer is not plugged into an external power source, the light stays off until the battery reaches a low battery level.
(5)	Drive light	<ul style="list-style-type: none"> White: The hard drive or optical drive is being accessed. Amber: HP 3D DriveGuard has temporarily parked the hard drive.
(6)	Speakers (2)	Produce sound.
(7)	Display release button	Opens the computer.

Left-side components

 **NOTE:** Refer to the illustration that most closely matches your computer.

Computer model equipped with a low-voltage processor

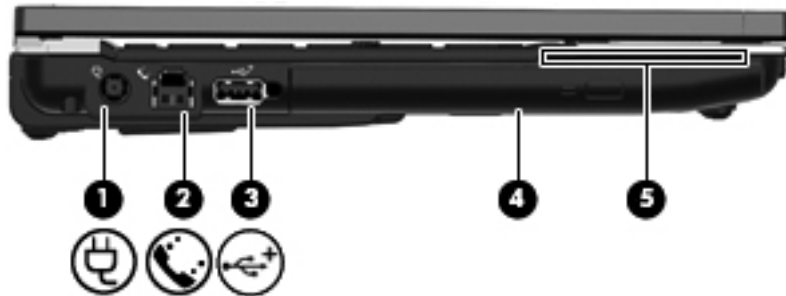

Item	Component	Description
(1)	Power connector	Connects an AC adapter.
(2)	RJ-11 (modem) jack	Connects a modem cable (select models only).
(3)	Powered USB port	Provides power to a USB device, such as an optional external MultiBay or an optional external optical drive, if used with a powered USB cable.
(4)	Optical drive	Reads and writes to (select models only) an optical disc.
(5)	Smart card reader	Supports optional smart cards and Java™ Cards.

Computer model equipped with a standard-voltage processor

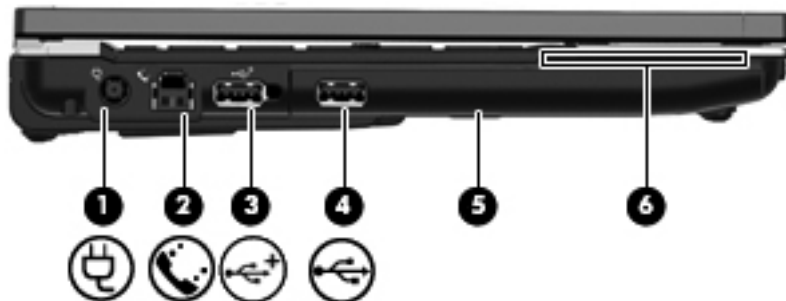

Item	Component	Description
(1)	Power connector	Connects an AC adapter.
(2)	RJ-11 (modem) jack	Connects a modem cable (select models only).
(3)	Powered USB port	Provides power to a USB device, such as an optional external MultiBay or an optional external optical drive, if used with a powered USB cable.
(4)	USB port	Connects an optional USB device.
(5)	Hard drive bay	Holds a 2.5-in hard drive.
(6)	Smart card reader	Supports optional smart cards and Java Cards.

Rear components



Item	Component	Description
(1)	RJ-45 network jack	Connects a network cable.
(2)	USB ports (2)	Connect optional USB devices.

Right-side components



Item	Component	Description
(1)	ExpressCard34 slot	Supports optional ExpressCards.
(2)	Docking connector	Connects an optional docking device.
(3)	Security cable slot	Attaches an optional security cable to the computer. NOTE: The security cable is designed to act as a deterrent, but it may not prevent the computer from being mishandled or stolen.
(4)	Vent	Enables airflow to cool internal components. NOTE: The computer fan starts up automatically to cool internal components and prevent overheating. It is normal for the internal fan to cycle on and off during routine operation.
(5)	DisplayPort	Connects a digital display device, such as a high-performance monitor or projector.
(6)	External monitor port	Connects an external VGA monitor or projector.
(7)	Audio-out (headphone) jack/Audio-in (microphone) jack	Produces sound when connected to optional powered stereo speakers, headphones, ear buds, a headset, or television audio. Also connects an optional headset microphone. NOTE: When a device is connected to the headphone jack, the computer speakers are disabled.
(8)	1394 port	Connects an optional IEEE 1394 or 1394a device, such as a camcorder.
(9)	SD Card Reader	Supports the MultiMediaCard (MMC) and Secure Digital (SD) Memory Card optional digital card formats.

Bottom components

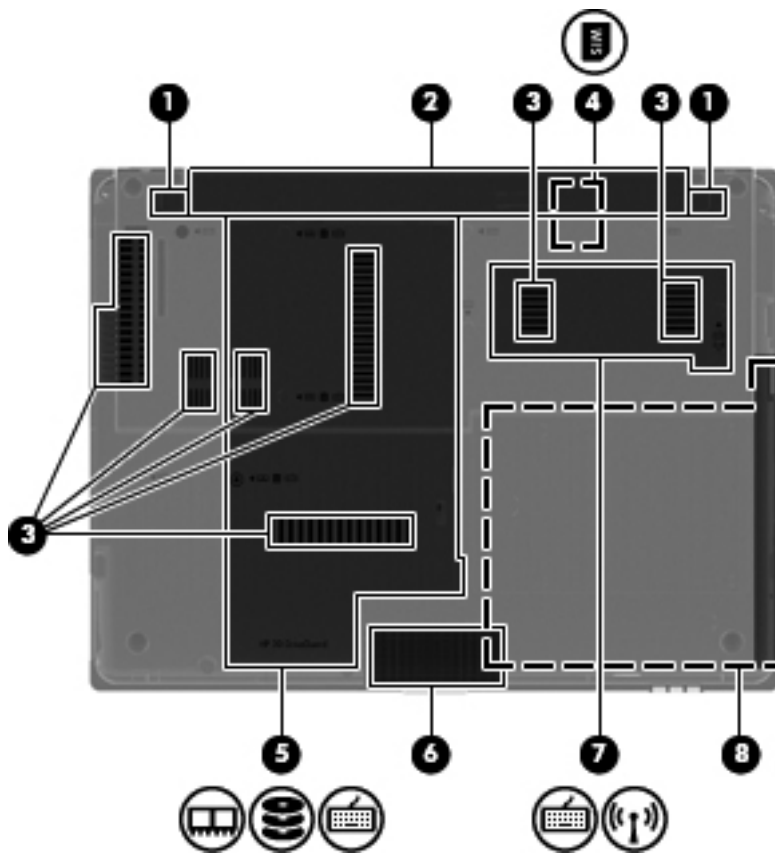

Item	Component	Description
(1)	Battery release latches (2)	Release the battery from the battery bay.
(2)	Battery bay	Holds the battery.
(3)	Vents (7)	Enable airflow to cool internal components. NOTE: The computer fan starts up automatically to cool internal components and prevent overheating. It is normal for the internal fan to cycle on and off during routine operation.
(4)	SIM slot (select models only)	Contains a wireless SIM. The SIM slot is located inside the battery bay.
(5)	Hard drive bay and memory module compartment	Holds a 1.8-in hard drive and contains an expansion memory module slot. NOTE: If the computer is equipped with a 1.8-in hard drive or solid-state drive, it is installed in this location. If the computer is equipped with a 2.5-in hard drive or solid-state drive, it is installed in the optical drive bay (see item 8).
(6)	Speakers (2)	Produce sound.

Item	Component	Description
(7)	Wireless module compartment	<p>Contains an HP Mobile Broadband Module (select models only) and a WLAN module (select models only).</p> <p>CAUTION: To prevent an unresponsive system, replace the wireless module only with a wireless module authorized for use in the computer by the governmental agency that regulates wireless devices in your country or region. If you replace the module and then receive a warning message, remove the module to restore computer functionality, and then contact technical support through Help and Support.</p>
(8)	Optical drive bay or hard drive bay	<p>Holds an optical drive or a 2.5-in hard drive.</p> <p>NOTE: If the computer is equipped with a low-voltage (25-W) processor, an optical drive will be installed in this location. If the computer is equipped with a standard-voltage (35-W) processor, a hard drive will be installed in this location.</p>

3 Illustrated parts catalog

Serial number location

The service tag, affixed to the bottom of the computer, provides information that may be needed when troubleshooting system problems. The service tag provides the following information:

- (1) Product name: This is the product name affixed to the front of the computer.
- (2) Serial number (s/n): This is an alphanumeric identifier that is unique to each product.
- (3) Part number/Product number (p/n): This number provides specific information about the product's hardware components. The part number helps a service technician to determine what components and parts are needed.
- (4) Model description: This is the number used to locate documents, drivers, and support for the computer.
- (5) Warranty period: This number describes the duration of the warranty period for the computer.

When ordering parts or requesting information, provide the computer serial number and model description provided on the service tag.

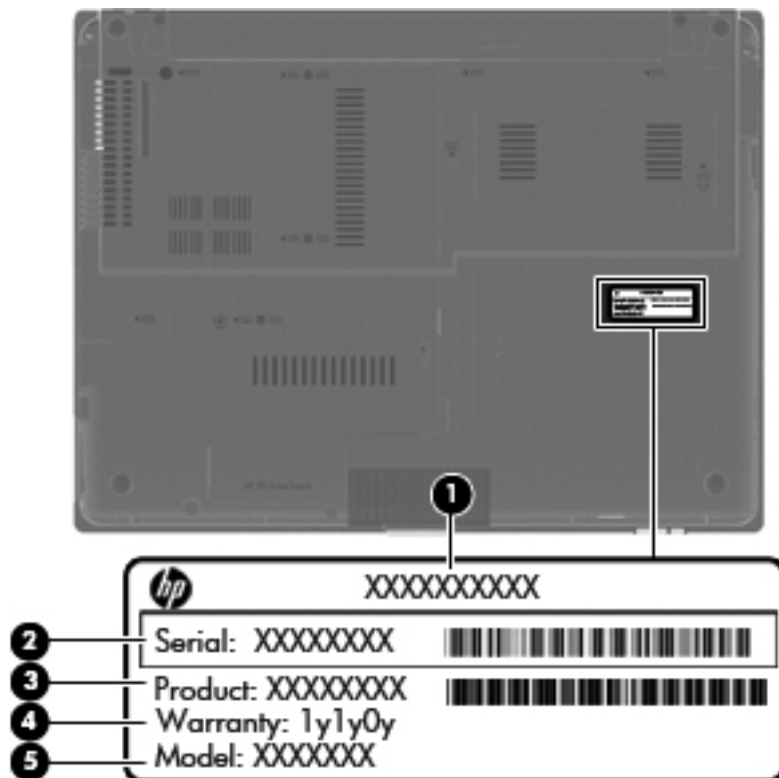

Computer major components

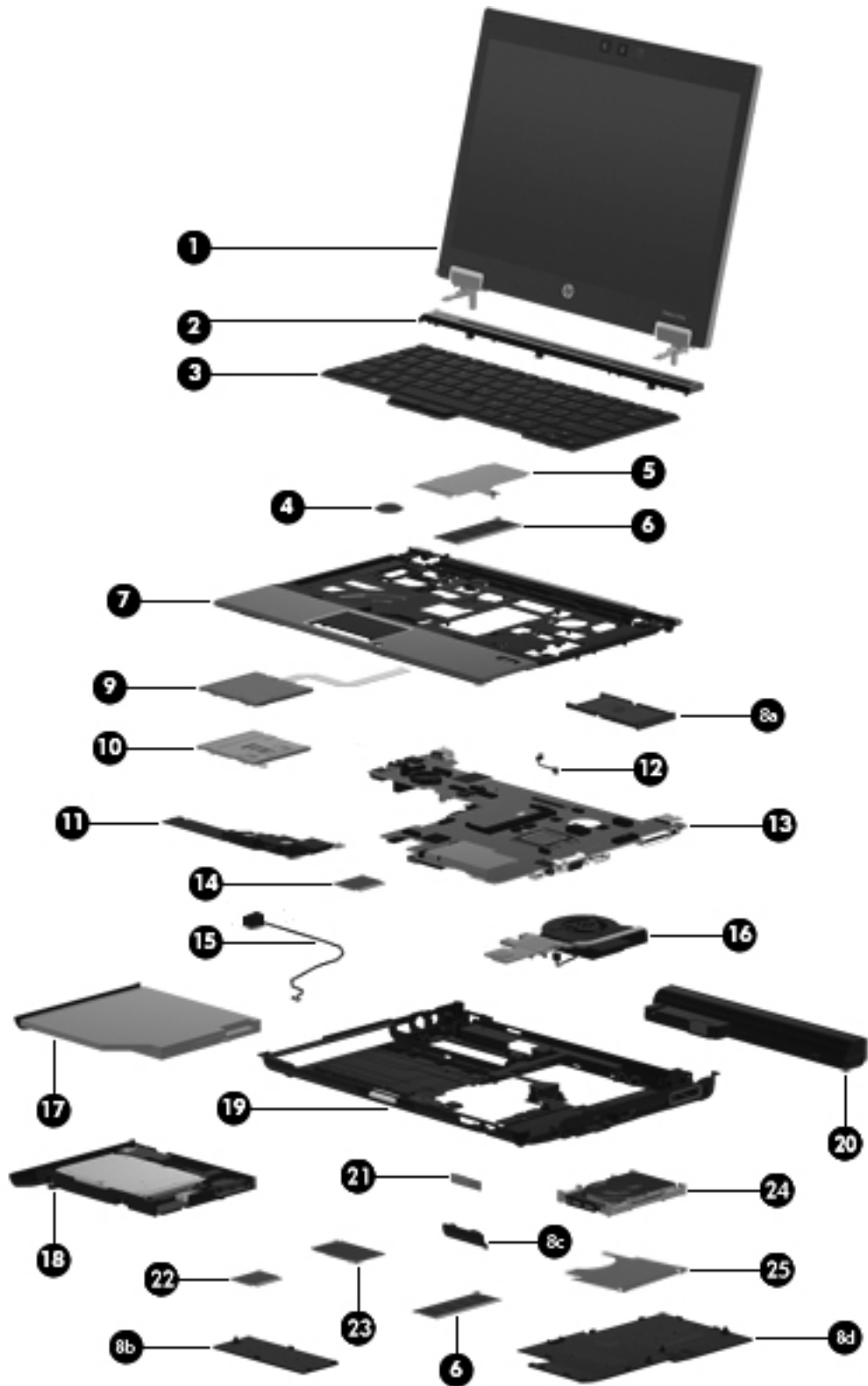

Item	Description	Spare part number
(1)	12.1-in, WXGA AntiGlare LED display assembly (includes display panel cable, WLAN antenna transceivers and cables, and WWAN antenna transceivers and cables. See Display components on page 26 for display assembly component spare part number information.):	
	For use only with computer models equipped with a webcam	598794-001
	For use only with computer models not equipped with a webcam	598795-001
(2)	Switch cover (includes display lid switch board and cable and capacitive board and cable)	598800-001
(3)	Keyboard with pointing stick (includes keyboard cable and pointing stick cable):	
	• For use in Belgium	598790-A41
	• For use in Brazil	598790-201
	• For use in Bulgaria	598790-261
	• For use in the Czech Republic	598790-A81
	• For use in Denmark	598790-081
	• For use in Finland and Sweden	598790-B71
	• For use in France	598790-051
	• For use in French Canada	598790-121
	• For use in Germany	598790-041
	• For use in Greece	598790-DJ1
	• For use in Hungary	598790-211
	• For use in Iceland	598790-DD1
	• For use in Israel	598790-BB1
	• For use in Italy	598790-061
	• For use in Japan	598790-291
	• For use in Latin America	598790-161
	• For use in the Netherlands	598790-B31
	• For use in Norway	598790-091
	• For use in Portugal	598790-131
	• For use in Russia	598790-251
	• For use in Saudi Arabia	598790-171
	• For use in Slovakia	598790-A81
	• For use in Slovenia	598790-BA1
	• For use in South Korea	598790-AD1
	• For use in Spain	598790-071
	• For use in Switzerland	598790-BG1
	• For use in Taiwan	598790-AB1

Item	Description	Spare part number
	<ul style="list-style-type: none"> For use in Thailand 	598790-281
	<ul style="list-style-type: none"> For use in Turkey 	598790-141
	<ul style="list-style-type: none"> For use in the United Kingdom 	598790-031
	<ul style="list-style-type: none"> For use in the United States 	598790-001
(4)	RTC battery	481089-001
(5)	Memory shield	598793-001
(6)	Memory modules (2, 1333-MHz, DDR3):	
	4 GB	599092-002
	2 GB	598856-002
	1 GB	598859-002
(7)	Top cover (includes TouchPad board and cable, TouchPad button board and cable, and TouchPad bracket):	
	For use only with computer models equipped with a fingerprint reader	598801-001
	For use only with computer models not equipped with a fingerprint reader	598802-001
	Plastics Kit , includes:	598796-001
(8a)	ExpressCard slot bezel	
(8b)	Wireless module compartment cover	
(8c)	Bluetooth module compartment cover	
(8d)	Memory module compartment cover	
	NOTE: The Plastics Kit also includes the display hinge covers and the optical drive bezel, which are not illustrated. See Plastics Kit on page 30 for more Plastics Kit spare part information.	
(9)	Card reader board and cable	598768-001
(10)	Card reader board bracket	598767-001
(11)	Speaker	598799-001
(12)	Bluetooth module cable (included in the Cable Kit, spare part number 598766-001)	
(13)	System board (includes processor, replacement thermal material, and replacement thermal material cleaning kit):	
	System boards for use on computer models equipped with a standard-voltage (35-W) processor:	
	Equipped with an Intel Core i7-620M 2.66-GHz processor for use in all countries and regions except the People's Republic of China and Russia	598765-001
	Equipped with an Intel Core i7-620M 2.66-GHz processor for use only in the People's Republic of China and Russia	614968-001
	Equipped with an Intel Core i5-540M 2.53-GHz processor for use in all countries and regions except the People's Republic of China and Russia	598764-001
	Equipped with an Intel Core i5-540M 2.53-GHz processor for use only in the People's Republic of China and Russia	614967-001
	Equipped with an Intel Core i5-520M 2.40-GHz processor for use in all countries and regions except the People's Republic of China and Russia	598763-001

Item	Description	Spare part number
	Equipped with an Intel Core i5-520M 2.40-GHz processor for use only in the People's Republic of China and Russia	614966-001
	System boards for use on computer models equipped with low-voltage (25-W) processors:	
	Equipped with an Intel Core i7-640M 2.13-GHz processor for use in all countries and regions except the People's Republic of China and Russia	598762-001
	Equipped with an Intel Core i7-640M 2.13-GHz processor for use only in the People's Republic of China and Russia	614965-001
(14)	Modem module: NOTE: The modem module spare part kit does not include a modem module cable. The modem module cable is included in the Cable Kit, spare part number 598766-001.	
	For use in all countries and regions except Australia and New Zealand	510099-001
	For use only in Australia and New Zealand	510099-011
(15)	Modem module cable (includes RJ-11 connector, included in the Cable Kit, spare part number 598766-001)	
(16)	Fan/heat sink assembly (includes replacement thermal material and replacement thermal material cleaning kit):	
	For use only with a standard-voltage (35-W) processor	598789-001
	For use only with a low-voltage (25-W) processor	598788-001
(17)	Optical drive (includes bezel and bracket):	
	DVD±RW and CD-RW SuperMulti Double-Layer Drive	598776-001
	DVD-ROM Drive	598775-001
	NOTE: The optical drive is an optional feature and is available only on computer models equipped with a low voltage (25-W) processor.	
(18)	Hard drive carrier kit	
	4.57-cm (1.80-in)	598786-001
	6.35-cm (2.50-in) (includes HDD and ODD connector boards and the USB board)	598787-001
(19)	Base enclosure (includes display release latch, battery release latch, LED board and cable, and rubber feet)	598759-001
	Rubber Kit (includes display bezel rubber bumpers, display bezel screw covers, RJ-11 jack cover, and Mylar used in the WLAN module compartment)	598797-001
(20)	Battery	
	9-cell, 93-WH, 2.8-AH, Li-ion battery	593587-001
	6-cell, 62-WH, 2.8-AH, Li-ion battery	593586-001
	6-cell, 55-WH, 2.8-AH, Li-ion long life battery	593585-001
	3-cell, 31-WH, 2.8-AH, Li-ion battery	492548-001
	3-cell, 28-WH, 2.8-AH, Li-ion long life battery	593584-001
(21)	HP Integrated Module with Bluetooth 2.1 Wireless Technology	537921-001
	NOTE: The Bluetooth module spare part kit does not include a Bluetooth module cable. The Bluetooth module cable is included in the Cable Kit, spare part number 598766-001.	

Item	Description	Spare part number
(22)	WLAN module	
	Broadcom 43224AGN 802.11a/b/g/draft-n WiFi Adapter for use in Antigua and Barbuda, Argentina, Aruba, the Bahamas, Barbados, Bermuda, Brunei, Canada, the Cayman Islands, Chile, Colombia, Costa Rica, the Dominican Republic, Ecuador, El Salvador, Guam, Guatemala, Haiti, Honduras, Hong Kong, India, Indonesia, Malaysia, Mexico, Panama, Paraguay, Peru, Saudi Arabia, Taiwan, Uruguay, the United States, Venezuela, and Vietnam	582564-001
	Broadcom 43224AGN 802.11a/b/g/draft-n WiFi Adapter for use in Afghanistan, Albania, Algeria, Andorra, Angola, Antigua and Barbuda, Argentina, Armenia, Aruba, Australia, Austria, Azerbaijan, the Bahamas, Bahrain, Bangladesh, Barbados, Belarus, Belgium, Belize, Benin, Bermuda, Bhutan, Bolivia, Bosnia and Herzegovina, Botswana, Brazil, the British Virgin Islands, Brunei, Bulgaria, Burkina Faso, Burundi, Cambodia, Cameroon, Cape Verde, the Central African Republic, Chad, Chile, Colombia, Comoros, the Congo, Costa Rica, Croatia, Cyprus, the Czech Republic, Denmark, Djibouti, Dominica, the Dominican Republic, East Timor, Ecuador, Egypt, El Salvador, Equatorial Guinea, Eritrea, Estonia, Ethiopia, Fiji, Finland, France, French Guiana, Gabon, Gambia, Georgia, Germany, Ghana, Gibraltar, Greece, Grenada, Guadeloupe, Guatemala, Guinea, Guinea-Bissau, Guyana, Haiti, Honduras, Hong Kong, Hungary, Iceland, India, Indonesia, Ireland, Israel, Italy, the Ivory Coast, Jamaica, Jordan, Kazakhstan, Kenya, Kiribati, Kuwait, Kyrgyzstan, Laos, Latvia, Lebanon, Lesotho, Liberia, Liechtenstein, Lithuania, Luxembourg, Macedonia, Madagascar, Malawi, Malaysia, the Maldives, Mali, Malta, the Marshall Islands, Martinique, Mauritania, Mauritius, Mexico, Micronesia, Monaco, Mongolia, Montenegro, Morocco, Mozambique, Namibia, Nauru, Nepal, the Nether Antilles, the Netherlands, New Zealand, Nicaragua, Niger, Nigeria, Norway, Oman, Palau, Panama, Papua New Guinea, Paraguay, the People's Republic of China, Peru, the Philippines, Poland, Portugal, Qatar, the Republic of Moldova, Romania, Russia, Rwanda, Samoa, San Marino, Sao Tome and Principe, Saudi Arabia, Senegal, Serbia, the Seychelles, Sierra Leone, Singapore, Slovakia, Slovenia, the Solomon Islands, Somalia, South Africa, South Korea, Spain, Sri Lanka, St. Kitts and Nevis, St. Lucia, St. Vincent and the Grenadines, Suriname, Swaziland, Sweden, Switzerland, Taiwan, Tajikistan, Tanzania, Thailand, Togo, Tonga, Trinidad and Tobago, Tunisia, Turkey, Turkmenistan, Tuvalu, Uganda, Ukraine, the United Arab Emirates, the United Kingdom, Uruguay, Uzbekistan, Vanuatu, Venezuela, Vietnam, Yemen, Zaire, Zambia, and Zimbabwe	582564-002
	Broadcom 4312G 802.11b/g WiFi Adapter for use in Antigua and Barbuda, Argentina, Aruba, the Bahamas, Barbados, Bermuda, Brunei, Canada, the Cayman Islands, Chile, Colombia, Costa Rica, the Dominican Republic, Ecuador, El Salvador, Guam, Guatemala, Haiti, Honduras, Hong Kong, India, Indonesia, Malaysia, Mexico, Panama, Paraguay, Peru, Saudi Arabia, Taiwan, Uruguay, the United States, Venezuela, and Vietnam	582562-001

Item	Description	Spare part number
	Broadcom 4312G 802.11b/g WiFi Adapter for use in Afghanistan, Albania, Algeria, Andorra, Angola, Antigua and Barbuda, Argentina, Armenia, Aruba, Australia, Austria, Azerbaijan, the Bahamas, Bahrain, Bangladesh, Barbados, Belarus, Belgium, Belize, Benin, Bermuda, Bhutan, Bolivia, Bosnia and Herzegovina, Botswana, Brazil, the British Virgin Islands, Brunei, Bulgaria, Burkina Faso, Burundi, Cambodia, Cameroon, Cape Verde, the Central African Republic, Chad, Chile, Colombia, Comoros, the Congo, Costa Rica, Croatia, Cyprus, the Czech Republic, Denmark, Djibouti, Dominica, the Dominican Republic, East Timor, Ecuador, Egypt, El Salvador, Equatorial Guinea, Eritrea, Estonia, Ethiopia, Fiji, Finland, France, French Guiana, Gabon, Gambia, Georgia, Germany, Ghana, Gibraltar, Greece, Grenada, Guadeloupe, Guatemala, Guinea, Guinea-Bissau, Guyana, Haiti, Honduras, Hong Kong, Hungary, Iceland, India, Indonesia, Ireland, Israel, Italy, the Ivory Coast, Jamaica, Jordan, Kazakhstan, Kenya, Kiribati, Kuwait, Kyrgyzstan, Laos, Latvia, Lebanon, Lesotho, Liberia, Liechtenstein, Lithuania, Luxembourg, Macedonia, Madagascar, Malawi, Malaysia, the Maldives, Mali, Malta, the Marshall Islands, Martinique, Mauritania, Mauritius, Mexico, Micronesia, Monaco, Mongolia, Montenegro, Morocco, Mozambique, Namibia, Nauru, Nepal, the Nether Antilles, the Netherlands, New Zealand, Nicaragua, Niger, Nigeria, Norway, Oman, Palau, Panama, Papua New Guinea, Paraguay, the People's Republic of China, Peru, the Philippines, Poland, Portugal, Qatar, the Republic of Moldova, Romania, Russia, Rwanda, Samoa, San Marino, Sao Tome and Principe, Saudi Arabia, Senegal, Serbia, the Seychelles, Sierra Leone, Singapore, Slovakia, Slovenia, the Solomon Islands, Somalia, South Africa, South Korea, Spain, Sri Lanka, St. Kitts and Nevis, St. Lucia, St. Vincent and the Grenadines, Suriname, Swaziland, Sweden, Switzerland, Taiwan, Tajikistan, Tanzania, Thailand, Togo, Tonga, Trinidad and Tobago, Tunisia, Turkey, Turkmenistan, Tuvalu, Uganda, Ukraine, the United Arab Emirates, the United Kingdom, Uruguay, Uzbekistan, Vanuatu, Venezuela, Vietnam, Yemen, Zaire, Zambia, and Zimbabwe	582564-002
	Intel Centrino Advanced-N 6200 WLAN module for use in the United States and Canada	572509-001
(23)	WWAN module	
	HP un2420 Broadband Module for use in all countries and regions	531993-001
	HP hs2330 HSPA Mobile Broadband Module for use in all countries and regions	574249-001
	HP hs2320 HSPA Mobile Broadband Module for use only in Europe, the Middle East, and Africa	574248-001
	NOTE: For use only on selected computer models.	
(24)	Hard drive and solid-state drive	
	4.57-cm (1.80-in) hard drive:	
	NOTE: The 4.57-cm (1.80-in) hard drive must be installed in the hard drive bay. Installation of this drive in the optical drive bay is not supported.	
	• 320-GB, 5400-rpm hard drive	614537-001
	• 250-GB, 5400-rpm hard drive	598778-001
	• 160-GB, 5400-rpm hard drive	598777-001
	4.57-cm (1.80-in) solid-state drive:	
	NOTE: The 4.57-cm (1.80-in) solid-state drive must be installed in the hard drive bay. Installation of this drive in the optical drive bay is not supported.	
	• 160-GB solid-state drive	598782-001
	• 80-GB solid-state drive	602675-001

Item	Description	Spare part number
	6.35-cm (2.50-in) hard drive:	
	NOTE: The 6.35-cm (2.50-in) hard drive must be installed in the optical drive bay, using a hard drive carrier. Installation of these devices in the hard drive bay is not supported. (This option is not available when the optical drive is installed.)	
	<ul style="list-style-type: none"> 500-GB, 7200-rpm hard drive 	598781-001
	<ul style="list-style-type: none"> 320-GB, 7200-rpm hard drive 	598780-001
	<ul style="list-style-type: none"> 320-GB, 7200-rpm SED hard drive 	618243-001
	<ul style="list-style-type: none"> 250-GB, 7200-rpm hard drive 	598779-001
	6.35-cm (2.50-in) solid-state drive:	
	NOTE: The 6.35-cm (2.50-in) solid-state drive must be installed in the optical drive bay, using a hard drive carrier, spare part number 598787-001 (includes HDD and ODD connector boards and the USB board). Installation of these devices in the hard drive bay is not supported. (This option is not available when the optical drive is installed.)	
	<ul style="list-style-type: none"> 160-GB, solid-state drive 	598783-001
	<ul style="list-style-type: none"> 80-GB, solid-state drive 	602676-001
(25)	Hard drive shield (includes two captive screws, included with the hard drive spare part kit)	

Display components

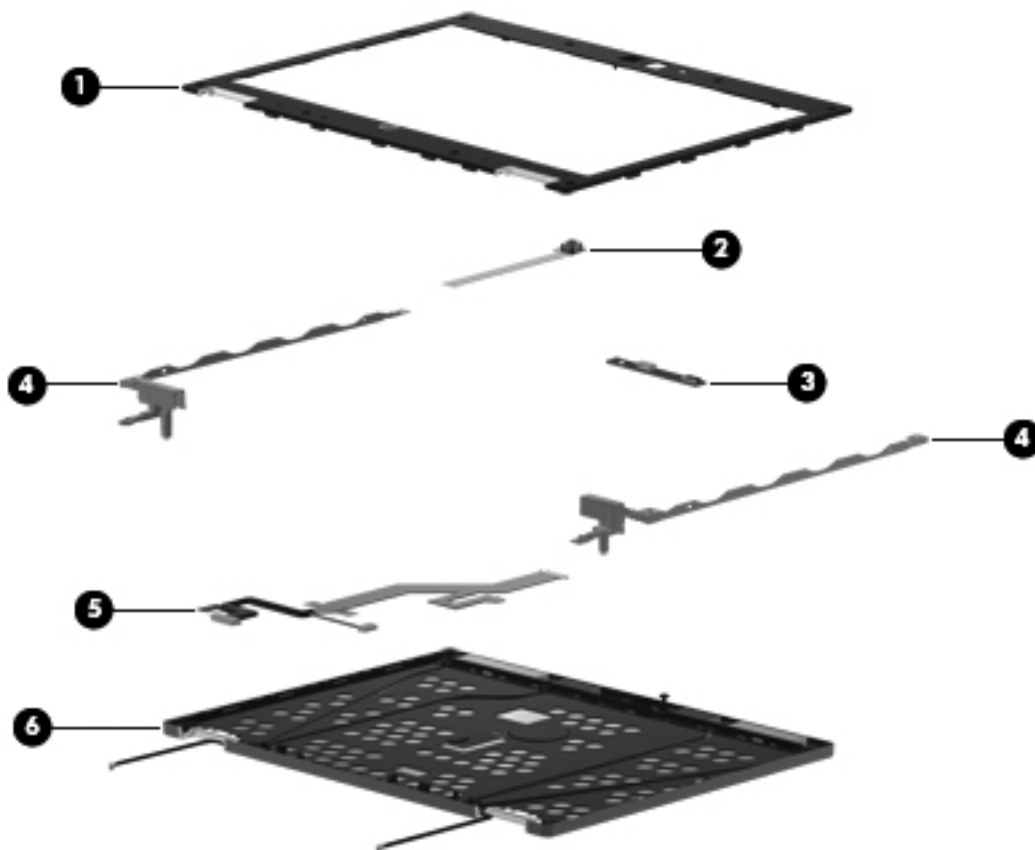

Item	Description	Spare part number
(1)	Display bezel	
	For use only with computer models equipped with a webcam	598770-001
	For use only with computer models not equipped with a webcam	598771-001
(2)	Webcam module	598803-001
(3)	Ambient light sensor board	598761-001
(4)	Display Hinge Kit , includes:	598773-001
(5)	Display panel cable (includes webcam module cable and ambient light sensor board cable)	598772-001
(6)	Display enclosure (includes microphone receivers and cables, WLAN antenna cables and transceivers, and WWAN antenna cables and transceivers)	598769-001

Mass storage

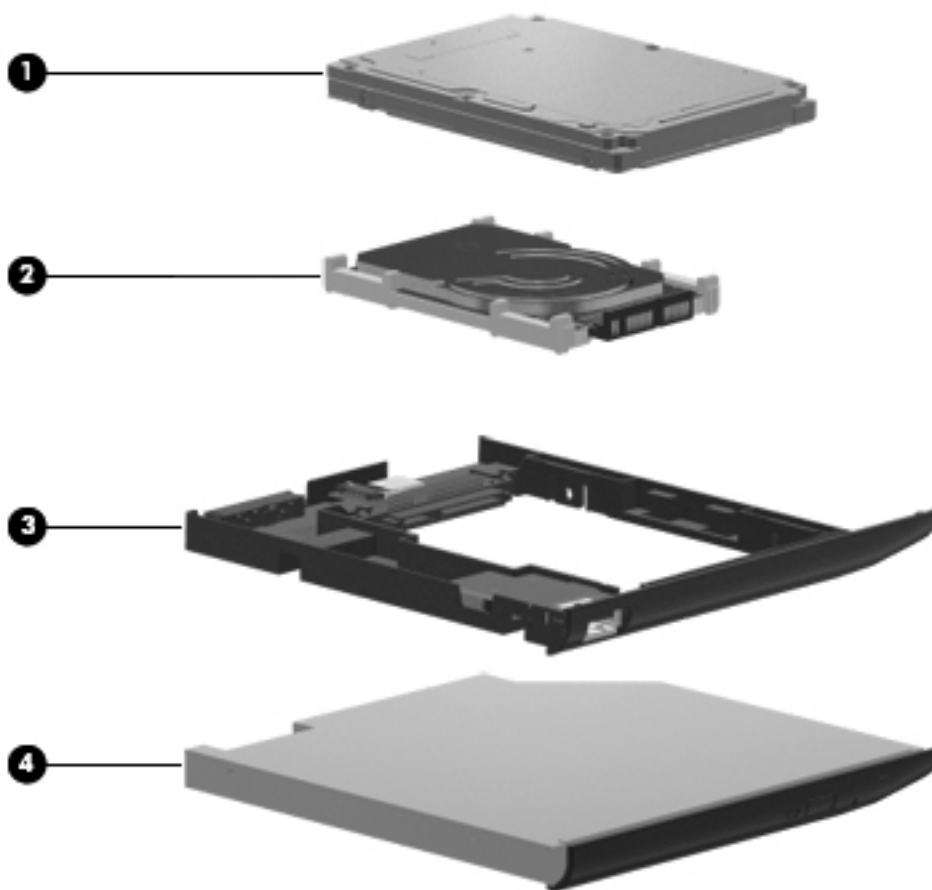

Item	Description	Spare part number
(1)	6.35-cm (2.50-in) mass storage device	
	<p>NOTE: 6.35-cm (2.50-in) devices must be installed in the optical drive bay, using a hard drive carrier, spare part number 598787-001 (includes HDD and ODD connector boards and the USB board). Installation of 6.35-cm (2.50-in) devices in the hard drive bay is not supported.</p>	
	<p>6.35-cm (2.50-in) mass storage devices available for use on computer models equipped with a standard-voltage (35-W) processor:</p>	
	<ul style="list-style-type: none"> 500-GB, 7200-rpm hard drive 	598781-001
	<ul style="list-style-type: none"> 320-GB, 7200-rpm hard drive 	598780-001
	<ul style="list-style-type: none"> 320-GB, 7200-rpm SED hard drive 	618243-001
	<ul style="list-style-type: none"> 250-GB, 7200-rpm hard drive 	598779-001
	<ul style="list-style-type: none"> 160-GB solid-state drive 	598783-001
	<ul style="list-style-type: none"> 80-GB solid-state drive 	602676-001
	<p>A 6.35-in (2.50-in), 250-GB, 7200-rpm, hard drive, spare part number 598779-001, can be used on computer models equipped with a low-voltage (25-W) processor. Use of this hard drive requires the use of a 1.8-in, 250-GB, 5400-rpm hard drive in the 1.8-in hard drive bay for RAID support.</p>	

Item	Description	Spare part number
(2)	4.57-cm (1.80-in) mass storage device	
	NOTE: 4.57-cm (1.80-in) devices must be installed in the hard drive bay. Installation of these devices in the optical drive bay is not supported.	
	4.57-cm (1.80-in) mass storage devices available for use on computer models equipped with a low-voltage (25-W) processor:	
	<ul style="list-style-type: none"> 320-GB, 5400-rpm hard drive 	614537-001
	<ul style="list-style-type: none"> 250-GB, 5400-rpm hard drive 	598778-001
	<ul style="list-style-type: none"> 160-GB, 5400-rpm hard drive 	598777-001
	<ul style="list-style-type: none"> 160-GB solid-state drive 	598782-001
	<ul style="list-style-type: none"> 80-GB solid-state drive 	602675-001
(3)	Hard drive carrier	
	4.57-cm (1.80-in)	598786-001
	6.35-cm (2.50-in) (includes HDD and ODD connector boards and the USB board)	598787-001
(4)	Optical drive (includes bezel and bracket):	
	DVD±RW and CD-RW SuperMulti Double-Layer Drive	598776-001
	DVD-ROM Drive	598775-001

Plastics Kit

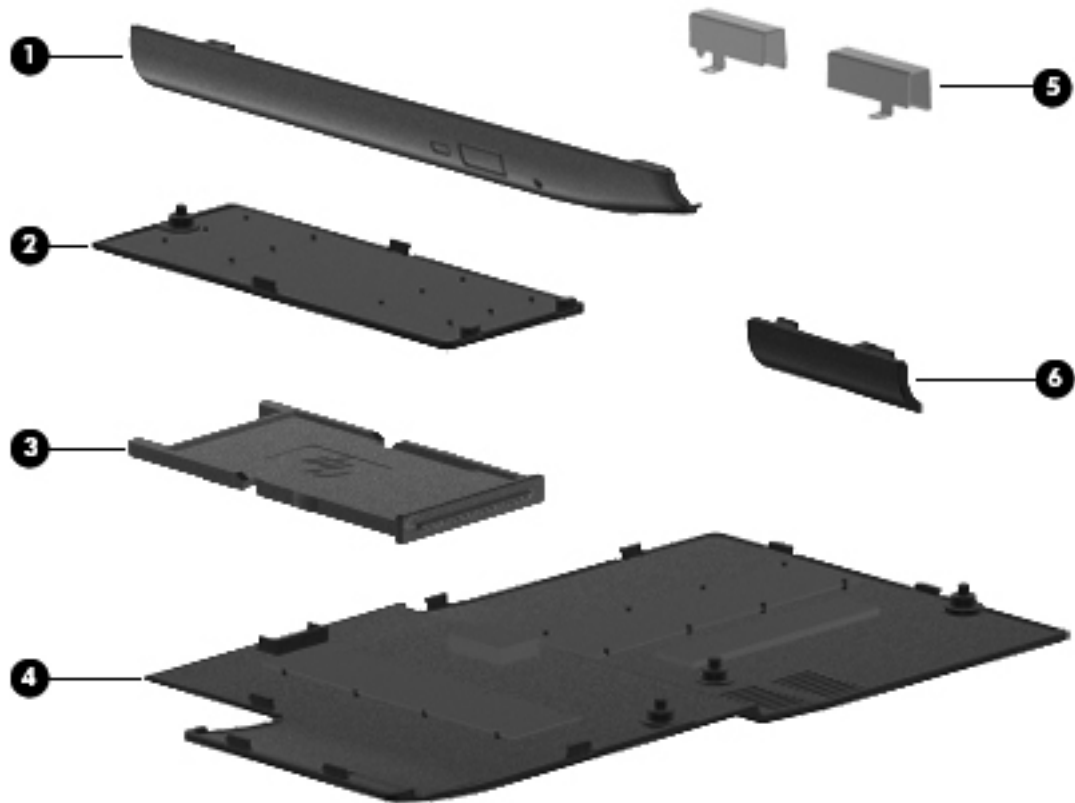

Item	Description	Spare part number
	Plastics Kit:	598796-001
(1)	Optical drive bezel	
(2)	Wireless module compartment cover (includes one captive screw, secured by a C-clip)	
(3)	ExpressCard slot bezel	
(4)	Memory module compartment cover (includes one captive screw, secured by a C-clip)	
(5)	Display hinge covers	
(6)	Bluetooth module compartment cover (includes one captive screw, secured by a C-clip)	

Miscellaneous parts

Description	Spare part number
AC adapter	
65-W non-PFC AC adapter	613152-001
65-W PFC AC adapter	613161-001
Cable Kit (includes Bluetooth module cable and modem module cable)	598766-001
HP 2540 Series Docking Station	598774-001
Power cord	
For use in Argentina	490371-D01
For use in Australia and New Zealand	490371-011
For use in Brazil	490371-202
For use in Canada and the United States	490371-001
For use in Denmark	490371-081
For use in Europe, the Middle East, and Africa	490371-021
For use in India	490371-D61
For use in Israel	490371-BB1
For use in Italy	490371-061
For use in Japan	490371-291
For use in the People's Republic of China	490371-AA1
For use in South Africa	490371-AR1
For use in South Korea	490371-AD1
For use in Switzerland	490371-111
For use in Taiwan	490371-AB1
Power cord for use in Singapore and the United Kingdom	490371-031
Screw Kit	598798-001

Sequential part number listing

Spare part number	Description
481089-001	RTC battery
490371-001	Power cord for use in Canada and the United States
490371-011	Power cord for use in Australia and New Zealand
490371-021	Power cord for use in Europe, the Middle East, and Africa
490371-031	Power cord for use in Singapore and the United Kingdom
490371-061	Power cord for use in Italy
490371-081	Power cord for use in Denmark
490371-111	Power cord for use in Switzerland
490371-202	Power cord for use in Brazil
490371-291	Power cord for use in Japan
490371-AA1	Power cord for use in the People's Republic of China
490371-AB1	Power cord for use in Taiwan
490371-AD1	Power cord for use in South Korea
490371-AR1	Power cord for use in South Africa
490371-BB1	Power cord for use in Israel
490371-D01	Power cord for use in Argentina
490371-D61	Power cord for use in India
492548-001	3-cell, 31-WH, 2.8-AH, Li-ion battery
510099-001	Modem module for use in all countries and regions except Australia and New Zealand NOTE: The modem module spare part kit does not include a modem module cable. The modem module cable is included in the Cable Kit, spare part number 598766-001.
510099-011	Modem module for use only in Australia and New Zealand NOTE: The modem module spare part kit does not include a modem module cable. The modem module cable is included in the Cable Kit, spare part number 598766-001.
531993-001	HP un2420 Broadband Module for use in all countries and regions
537921-001	HP Integrated Module with Bluetooth 2.1 Wireless Technology NOTE: The Bluetooth module spare part kit does not include a Bluetooth module cable. The Bluetooth module cable is included in the Cable Kit, spare part number 598766-001.
572509-001	Intel Centrino Advanced-N 6200 WLAN module for use in Canada and the United States
574248-001	HP hs2320 HSPA Mobile Broadband Module for use only in Europe, the Middle East, and Africa NOTE: For use only on selected computer models.
574249-001	HP hs2330 HSPA Mobile Broadband Module for use in all countries and regions

Spare part number	Description
582562-001	Broadcom 4312G 802.11b/g WiFi Adapter for use in Antigua and Barbuda, Argentina, Aruba, the Bahamas, Barbados, Bermuda, Brunei, Canada, the Cayman Islands, Chile, Colombia, Costa Rica, the Dominican Republic, Ecuador, El Salvador, Guam, Guatemala, Haiti, Honduras, Hong Kong, India, Indonesia, Malaysia, Mexico, Panama, Paraguay, Peru, Saudi Arabia, Taiwan, Uruguay, the United States, Venezuela, and Vietnam
582562-002	Broadcom 4312G 802.11b/g WiFi Adapter for use in Afghanistan, Albania, Algeria, Andorra, Angola, Antigua and Barbuda, Argentina, Armenia, Aruba, Australia, Austria, Azerbaijan, the Bahamas, Bahrain, Bangladesh, Barbados, Belarus, Belgium, Belize, Benin, Bermuda, Bhutan, Bolivia, Bosnia and Herzegovina, Botswana, Brazil, the British Virgin Islands, Brunei, Bulgaria, Burkina Faso, Burundi, Cambodia, Cameroon, Cape Verde, the Central African Republic, Chad, Chile, Colombia, Comoros, the Congo, Costa Rica, Croatia, Cyprus, the Czech Republic, Denmark, Djibouti, Dominica, the Dominican Republic, East Timor, Ecuador, Egypt, El Salvador, Equatorial Guinea, Eritrea, Estonia, Ethiopia, Fiji, Finland, France, French Guiana, Gabon, Gambia, Georgia, Germany, Ghana, Gibraltar, Greece, Grenada, Guadeloupe, Guatemala, Guinea, Guinea-Bissau, Guyana, Haiti, Honduras, Hong Kong, Hungary, Iceland, India, Indonesia, Ireland, Israel, Italy, the Ivory Coast, Jamaica, Jordan, Kazakhstan, Kenya, Kiribati, Kuwait, Kyrgyzstan, Laos, Latvia, Lebanon, Lesotho, Liberia, Liechtenstein, Lithuania, Luxembourg, Macedonia, Madagascar, Malawi, Malaysia, the Maldives, Mali, Malta, the Marshall Islands, Martinique, Mauritania, Mauritius, Mexico, Micronesia, Monaco, Mongolia, Montenegro, Morocco, Mozambique, Namibia, Nauru, Nepal, the Nether Antilles, the Netherlands, New Zealand, Nicaragua, Niger, Nigeria, Norway, Oman, Palau, Panama, Papua New Guinea, Paraguay, the People's Republic of China, Peru, the Philippines, Poland, Portugal, Qatar, the Republic of Moldova, Romania, Russia, Rwanda, Samoa, San Marino, Sao Tome and Principe, Saudi Arabia, Senegal, Serbia, the Seychelles, Sierra Leone, Singapore, Slovakia, Slovenia, the Solomon Islands, Somalia, South Africa, South Korea, Spain, Sri Lanka, St. Kitts and Nevis, St. Lucia, St. Vincent and the Grenadines, Suriname, Swaziland, Sweden, Switzerland, Taiwan, Tajikistan, Tanzania, Thailand, Togo, Tonga, Trinidad and Tobago, Tunisia, Turkey, Turkmenistan, Tuvalu, Uganda, Ukraine, the United Arab Emirates, the United Kingdom, Uruguay, Uzbekistan, Vanuatu, Venezuela, Vietnam, Yemen, Zaire, Zambia, and Zimbabwe
582564-001	Broadcom 43224AGN 802.11a/b/g/draft-n WiFi Adapter for use in Antigua and Barbuda, Argentina, Aruba, the Bahamas, Barbados, Bermuda, Brunei, Canada, the Cayman Islands, Chile, Colombia, Costa Rica, the Dominican Republic, Ecuador, El Salvador, Guam, Guatemala, Haiti, Honduras, Hong Kong, India, Indonesia, Malaysia, Mexico, Panama, Paraguay, Peru, Saudi Arabia, Taiwan, Uruguay, the United States, Venezuela, and Vietnam
582564-002	Broadcom 43224AGN 802.11a/b/g/draft-n WiFi Adapter for use in Afghanistan, Albania, Algeria, Andorra, Angola, Antigua and Barbuda, Argentina, Armenia, Aruba, Australia, Austria, Azerbaijan, the Bahamas, Bahrain, Bangladesh, Barbados, Belarus, Belgium, Belize, Benin, Bermuda, Bhutan, Bolivia, Bosnia and Herzegovina, Botswana, Brazil, the British Virgin Islands, Brunei, Bulgaria, Burkina Faso, Burundi, Cambodia, Cameroon, Cape Verde, the Central African Republic, Chad, Chile, Colombia, Comoros, the Congo, Costa Rica, Croatia, Cyprus, the Czech Republic, Denmark, Djibouti, Dominica, the Dominican Republic, East Timor, Ecuador, Egypt, El Salvador, Equatorial Guinea, Eritrea, Estonia, Ethiopia, Fiji, Finland, France, French Guiana, Gabon, Gambia, Georgia, Germany, Ghana, Gibraltar, Greece, Grenada, Guadeloupe, Guatemala, Guinea, Guinea-Bissau, Guyana, Haiti, Honduras, Hong Kong, Hungary, Iceland, India, Indonesia, Ireland, Israel, Italy, the Ivory Coast, Jamaica, Jordan, Kazakhstan, Kenya, Kiribati, Kuwait, Kyrgyzstan, Laos, Latvia, Lebanon, Lesotho, Liberia, Liechtenstein, Lithuania, Luxembourg, Macedonia, Madagascar, Malawi, Malaysia, the Maldives, Mali, Malta, the Marshall Islands, Martinique, Mauritania, Mauritius, Mexico, Micronesia, Monaco, Mongolia, Montenegro, Morocco, Mozambique, Namibia, Nauru, Nepal, the Nether Antilles, the Netherlands, New Zealand, Nicaragua, Niger, Nigeria, Norway, Oman, Palau, Panama, Papua New Guinea, Paraguay, the People's Republic of China, Peru, the Philippines, Poland, Portugal, Qatar, the Republic of Moldova, Romania, Russia, Rwanda, Samoa, San Marino, Sao Tome and Principe, Saudi Arabia, Senegal, Serbia, the Seychelles, Sierra Leone, Singapore, Slovakia, Slovenia, the Solomon Islands, Somalia, South Africa, South Korea, Spain, Sri Lanka, St. Kitts and Nevis, St. Lucia, St. Vincent and the Grenadines, Suriname, Swaziland, Sweden, Switzerland, Taiwan, Tajikistan, Tanzania, Thailand, Togo, Tonga, Trinidad and Tobago, Tunisia, Turkey, Turkmenistan, Tuvalu, Uganda, Ukraine, the United Arab Emirates, the United Kingdom, Uruguay, Uzbekistan, Vanuatu, Venezuela, Vietnam, Yemen, Zaire, Zambia, and Zimbabwe
593584-001	3-cell, 28-WH, 2.8-AH, Li-ion long life battery
593585-001	6-cell, 55-WH, 2.8-AH, Li-ion long life battery
593586-001	6-cell, 62-WH, 2.8-AH, Li-ion battery

Spare part number	Description
593587-001	9-cell, 93-WH, 2.8-AH, Li-ion battery
598759-001	Base enclosure (includes display release latch, battery release latch, LED board and cable, and rubber feet)
598761-001	Ambient light sensor board
598762-001	System board equipped with an Intel Core i7-640LM 2.13-GHz, low-voltage (25-W) processor for use in all countries and regions except the People's Republic of China and Russia (includes replacement thermal material and replacement thermal material cleaning kit)
598763-001	System board equipped with an Intel Core i5-520M 2.40-GHz, standard-voltage (35-W) processor for use in all countries and regions except the People's Republic of China and Russia (includes replacement thermal material and replacement thermal material cleaning kit)
598764-001	System board equipped with an Intel Core i5-540M 2.53-GHz, standard-voltage (35-W) processor for use in all countries and regions except the People's Republic of China and Russia (includes replacement thermal material and replacement thermal material cleaning kit)
598765-001	System board equipped with an Intel Core i7-620M 2.66-GHz, standard-voltage (35-W) processor for use in all countries and regions except the People's Republic of China and Russia (includes replacement thermal material and replacement thermal material cleaning kit)
598766-001	Cable Kit (includes Bluetooth module cable and modem module cable)
598767-001	Card reader board bracket
598768-001	Card reader board and cable
598769-001	Display enclosure (includes WLAN antenna cables and transceivers and WWAN antenna cables and transceivers)
598770-001	Display bezel for use only with computer models equipped with a webcam
598771-001	Display bezel for use only with computer models not equipped with a webcam
598772-001	Display panel cable (includes webcam module cable and ambient light sensor board cable)
598773-001	Display Hinge Kit (includes left and right display hinges and left and right hinge covers)
598774-001	HP 2540 Series Docking Station
598775-001	DVD-ROM Drive
598776-001	DVD±RW and CD-RW Super Multi Double-Layer Drive
598777-001	4.57-cm (1.80-in), 160-GB, 5400-rpm hard drive
598778-001	4.57-cm (1.80-in), 250-GB, 5400-rpm hard drive
598779-001	6.35-cm (2.50-in), 250-GB, 7200-rpm hard drive
598780-001	6.35-cm (2.50-in), 320-GB, 7200-rpm hard drive
598781-001	6.35-cm (2.50-in), 500-GB, 7200-rpm hard drive
598782-001	4.57-cm (1.80-in), 160-GB solid-state drive
598783-001	6.35-cm (2.50-in), 160-GB solid-state drive
598786-001	4.57-cm (1.80-in), Hard drive carrier kit
598787-001	6.35-cm (2.50-in), Hard drive carrier kit (includes HDD and ODD connector boards and the USB board)
598788-001	Fan/heat sink assembly for use only with 25-W processors (includes replacement thermal material and replacement thermal material cleaning kit)

Spare part number	Description
598789-001	Fan/heat sink assembly for use only with 35-W processors (includes replacement thermal material and replacement thermal material cleaning kit)
598790-001	Keyboard for use in the United States (includes cable)
598790-031	Keyboard for use in the United Kingdom (includes cable)
598790-041	Keyboard for use in Germany (includes cable)
598790-051	Keyboard for use in France (includes cable)
598790-061	Keyboard for use in Italy (includes cable)
598790-071	Keyboard for use in Spain (includes cable)
598790-081	Keyboard for use in Denmark (includes cable)
598790-091	Keyboard for use in Norway (includes cable)
598790-121	Keyboard for use in French Canada (includes cable)
598790-131	Keyboard for use in Portugal (includes cable)
598790-141	Keyboard for use in Turkey (includes cable)
598790-161	Keyboard for use in Latin America (includes cable)
598790-171	Keyboard for use in Saudi Arabia (includes cable)
598790-201	Keyboard for use in Brazil (includes cable)
598790-211	Keyboard for use in Hungary (includes cable)
598790-A81	Keyboard for use in the Czech Republic and Slovakia (includes cable)
598790-251	Keyboard for use in Russia (includes cable)
598790-261	Keyboard for use in Bulgaria (includes cable)
598790-281	Keyboard for use in Thailand (includes cable)
598790-291	Keyboard for use in Japan (includes cable)
598790-A41	Keyboard for use in Belgium (includes cable)
598790-AB1	Keyboard for use in Taiwan (includes cable)
598790-AD1	Keyboard for use in South Korea (includes cable)
598790-B31	Keyboard for use in the Netherlands (includes cable)
598790-B71	Keyboard for use in Finland and Sweden (includes cable)
598790-BA1	Keyboard for use in Slovenia (includes cable)
598790-BB1	Keyboard for use in Israel (includes cable)
598790-BG1	Keyboard for use in Switzerland (includes cable)
598790-DD1	Keyboard for use in India (includes cable)
598790-DJ1	Keyboard for use in Greece (includes cable)
598793-001	Memory shield

Spare part number	Description
598794-001	12.1-in, WXGA AntiGlare LED display assembly for use only with computer models equipped with a webcam (includes display panel cable, WLAN antenna transceivers and cables, and WWAN antenna transceivers and cables).
598795-001	12.1-in, WXGA AntiGlare LED display assembly for use only with computer models not equipped with a webcam (includes display panel cable, WLAN antenna transceivers and cables, and WWAN antenna transceivers and cables).
598796-001	Plastics Kit NOTE: See Plastics Kit on page 30 for more Plastics Kit spare part information.
598797-001	Rubber Kit (includes display bezel rubber bumpers, display bezel screw covers, RJ-11 jack cover, and Mylar used in the WLAN module compartment)
598798-001	Screw Kit
598799-001	Speaker
598800-001	Switch cover (includes display lid switch board and cable and capacitive board and cable)
598801-001	Top cover for use only with computer models equipped with a fingerprint reader (includes fingerprint reader board and cable, TouchPad board and cable, TouchPad button board and cable, and TouchPad bracket)
598802-001	Top cover for use only with computer models not equipped with a fingerprint reader (includes TouchPad board and cable, TouchPad button board and cable, and TouchPad bracket)
598803-001	Webcam module
598856-002	2 GB memory module (1333-MHz, DDR3)
598859-002	1 GB memory module (1333-MHz, DDR3)
599092-002	4 GB memory module (1333-MHz, DDR3)
602675-001	4.57-cm (1.80-in), 80-GB solid-state drive
602676-001	6.35-cm (2.50-in), 80-GB solid-state drive
613152-001	65-W non-PFC AC adapter
613161-001	65-W PFC AC adapter
614537-001	4.57-cm (1.80-in), 320-GB, 5400-rpm hard drive
614965-001	System board equipped with an Intel Core i7-640LM 2.13-GHz, low-voltage (25-W) processor for use only in the People's Republic of China and Russia (includes replacement thermal material and replacement thermal material cleaning kit)
614966-001	System board equipped with an Intel Core i5-520M 2.40-GHz, standard-voltage (35-W) processor for use only in the People's Republic of China and Russia (includes replacement thermal material and replacement thermal material cleaning kit)
614966-001	System board equipped with an Intel Core i5-540M 2.53-GHz, standard-voltage (35-W) processor for use only in the People's Republic of China and Russia (includes replacement thermal material and replacement thermal material cleaning kit)
614967-001	System board equipped with an Intel Core i7-620M 2.66-GHz, standard-voltage (35-W) processor for use only in the People's Republic of China and Russia (includes replacement thermal material and replacement thermal material cleaning kit)
618243-001	6.35-cm (2.50-in), 320-GB, 7200-rpm SED hard drive

4 Removal and replacement procedures

Preliminary replacement requirements

Tools required

You will need the following tools to complete the removal and replacement procedures:

- Flat-bladed screwdriver
- Magnetic screwdriver
- Phillips P0 and P1 screwdrivers
- Torx T8 screwdriver

Service considerations

The following sections include some of the considerations that you must keep in mind during disassembly and assembly procedures.

 **NOTE:** As you remove each subassembly from the computer, place the subassembly (and all accompanying screws) away from the work area to prevent damage.

Plastic parts

 **CAUTION:** Using excessive force during disassembly and reassembly can damage plastic parts. Use care when handling the plastic parts. Apply pressure only at the points designated in the maintenance instructions.

Cables and connectors

⚠ CAUTION: When servicing the computer, be sure that cables are placed in their proper locations during the reassembly process. Improper cable placement can damage the computer.

Cables must be handled with extreme care to avoid damage. Apply only the tension required to unseat or seat the cables during removal and insertion. Handle cables by the connector whenever possible. In all cases, avoid bending, twisting, or tearing cables. Be sure that cables are routed in such a way that they cannot be caught or snagged by parts being removed or replaced. Handle flex cables with extreme care; these cables tear easily.

Drive handling

⚠ CAUTION: Drives are fragile components that must be handled with care. To prevent damage to the computer, damage to a drive, or loss of information, observe these precautions:

Before removing or inserting a hard drive, shut down the computer. If you are unsure whether the computer is off or in Hibernation, turn the computer on, and then shut it down through the operating system.

Before handling a drive, be sure that you are discharged of static electricity. While handling a drive, avoid touching the connector.

Before removing a diskette drive or optical drive, be sure that a diskette or disc is not in the drive and be sure that the optical drive tray is closed.

Handle drives on surfaces covered with at least one inch of shock-proof foam.

Avoid dropping drives from any height onto any surface.

After removing a hard drive, an optical drive, or a diskette drive, place it in a static-proof bag.

Avoid exposing an internal hard drive to products that have magnetic fields, such as monitors or speakers.

Avoid exposing a drive to temperature extremes or liquids.

If a drive must be mailed, place the drive in a bubble pack mailer or other suitable form of protective packaging and label the package "FRAGILE."

Grounding guidelines

Electrostatic discharge damage

Electronic components are sensitive to electrostatic discharge (ESD). Circuitry design and structure determine the degree of sensitivity. Networks built into many integrated circuits provide some protection, but in many cases, ESD contains enough power to alter device parameters or melt silicon junctions.

A discharge of static electricity from a finger or other conductor can destroy static-sensitive devices or microcircuitry. Even if the spark is neither felt nor heard, damage may have occurred.

An electronic device exposed to ESD may not be affected at all and can work perfectly throughout a normal cycle. Or the device may function normally for a while, then degrade in the internal layers, reducing its life expectancy.

⚠ CAUTION: To prevent damage to the computer when you are removing or installing internal components, observe these precautions:

Keep components in their electrostatic-safe containers until you are ready to install them.

Before touching an electronic component, discharge static electricity by using the guidelines described in this section.

Avoid touching pins, leads, and circuitry. Handle electronic components as little as possible.

If you remove a component, place it in an electrostatic-safe container.

The following table shows how humidity affects the electrostatic voltage levels generated by different activities.

⚠ CAUTION: A product can be degraded by as little as 700 V.

Typical electrostatic voltage levels

Event	Relative humidity		
	10%	40%	55%
Walking across carpet	35,000 V	15,000 V	7,500 V
Walking across vinyl floor	12,000 V	5,000 V	3,000 V
Motions of bench worker	6,000 V	800 V	400 V
Removing DIPS from plastic tube	2,000 V	700 V	400 V
Removing DIPS from vinyl tray	11,500 V	4,000 V	2,000 V
Removing DIPS from Styrofoam	14,500 V	5,000 V	3,500 V
Removing bubble pack from PCB	26,500 V	20,000 V	7,000 V
Packing PCBs in foam-lined box	21,000 V	11,000 V	5,000 V

Packaging and transporting guidelines

Follow these grounding guidelines when packaging and transporting equipment:

- To avoid hand contact, transport products in static-safe tubes, bags, or boxes.
- Protect ESD-sensitive parts and assemblies with conductive or approved containers or packaging.
- Keep ESD-sensitive parts in their containers until the parts arrive at static-free workstations.
- Place items on a grounded surface before removing items from their containers.
- Always be properly grounded when touching a component or assembly.
- Store reusable ESD-sensitive parts from assemblies in protective packaging or nonconductive foam.
- Use transporters and conveyors made of antistatic belts and roller bushings. Be sure that mechanized equipment used for moving materials is wired to ground and that proper materials are selected to avoid static charging. When grounding is not possible, use an ionizer to dissipate electric charges.

Workstation guidelines

Follow these grounding workstation guidelines:

- Cover the workstation with approved static-shielding material.
- Use a wrist strap connected to a properly grounded work surface and use properly grounded tools and equipment.
- Use conductive field service tools, such as cutters, screwdrivers, and vacuums.
- When fixtures must directly contact dissipative surfaces, use fixtures made only of static-safe materials.
- Keep the work area free of nonconductive materials, such as ordinary plastic assembly aids and Styrofoam.
- Handle ESD-sensitive components, parts, and assemblies by the case or PCM laminate. Handle these items only at static-free workstations.
- Avoid contact with pins, leads, or circuitry.
- Turn off power and input signals before inserting or removing connectors or test equipment.

Equipment guidelines

Grounding equipment must include either a wrist strap or a foot strap at a grounded workstation.

- When seated, wear a wrist strap connected to a grounded system. Wrist straps are flexible straps with a minimum of one megohm $\pm 10\%$ resistance in the ground cords. To provide proper ground, wear a strap snugly against the skin at all times. On grounded mats with banana-plug connectors, use alligator clips to connect a wrist strap.
- When standing, use foot straps and a grounded floor mat. Foot straps (heel, toe, or boot straps) can be used at standing workstations and are compatible with most types of shoes or boots. On conductive floors or dissipative floor mats, use foot straps on both feet with a minimum of one megohm resistance between the operator and ground. To be effective, the conductive must be worn in contact with the skin.

The following grounding equipment is recommended to prevent electrostatic damage:

- Antistatic tape
- Antistatic smocks, aprons, and sleeve protectors
- Conductive bins and other assembly or soldering aids
- Nonconductive foam
- Conductive tabletop workstations with ground cords of one megohm resistance
- Static-dissipative tables or floor mats with hard ties to the ground
- Field service kits
- Static awareness labels
- Material-handling packages
- Nonconductive plastic bags, tubes, or boxes
- Metal tote boxes
- Electrostatic voltage levels and protective materials

The following table lists the shielding protection provided by antistatic bags and floor mats.

Material	Use	Voltage protection level
Antistatic plastic	Bags	1,500 V
Carbon-loaded plastic	Floor mats	7,500 V
Metallized laminate	Floor mats	5,000 V

Component replacement procedures

This chapter provides removal and replacement procedures.

There are as many as 72 screws that must be removed, replaced, or loosened when servicing the computer. Make special note of each screw size and location during removal and replacement.

Service tag

The service tag, affixed to the bottom of the computer, provides information that may be needed when troubleshooting system problems. The service tag provides the following information:

- (1) Product name: This is the product name affixed to the front of the computer.
- (2) Serial number (s/n): This is an alphanumeric identifier that is unique to each product.
- (3) Part number/Product number (p/n): This number provides specific information about the product's hardware components. The part number helps a service technician to determine what components and parts are needed.
- (4) Model description: This is the number used to locate documents, drivers, and support for the computer.
- (5) Warranty period: This number describes the duration of the warranty period for the computer.

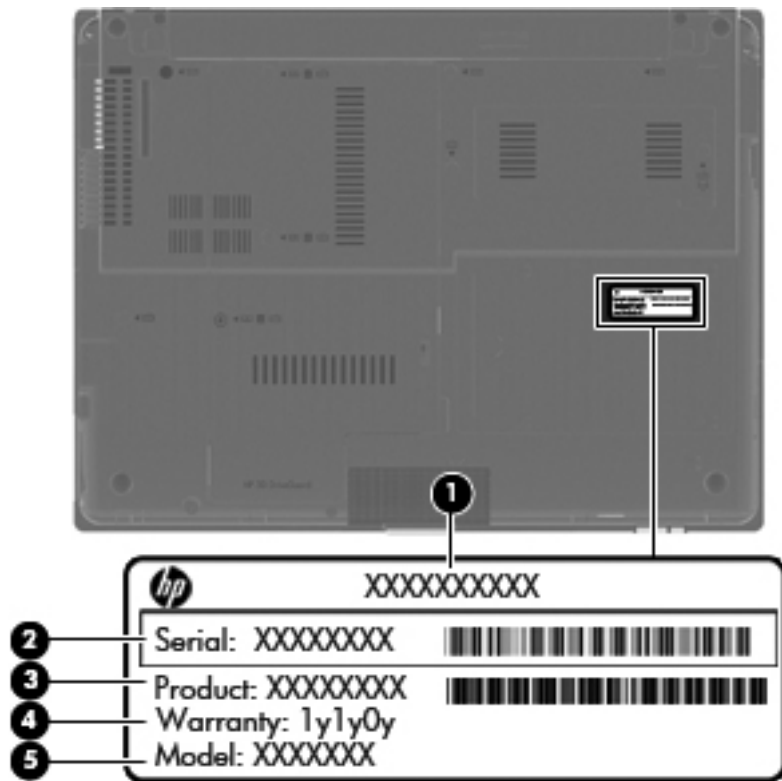

Computer feet

The computer feet are hot melted to the base enclosure in the locations illustrated below. There are two different sized feet: the five square feet **(1)** are installed on the front and the back of the base enclosure. The three rectangular feet **(2)** are installed in the rear/left corner of the base enclosure and near the vents.

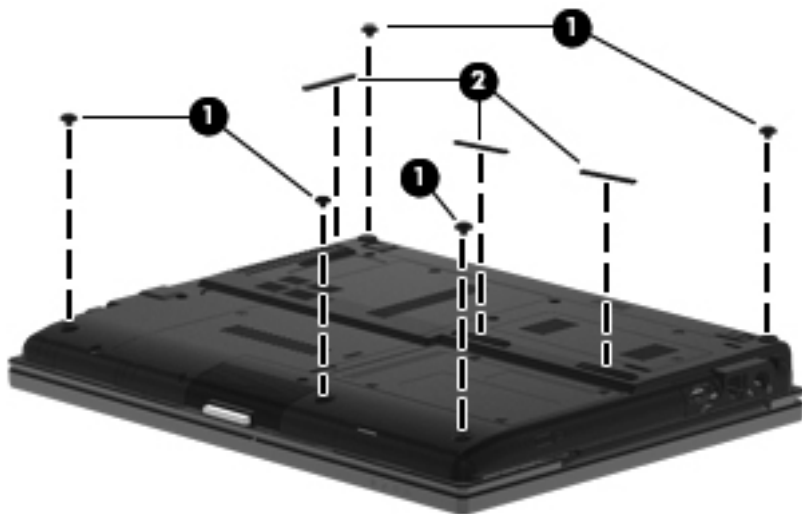

Battery

Description	Spare part number
9-cell, 93-WH, 2.8-WH Li battery	593587-001
6-cell, 62-WH, 2.8-WH Li battery	593586-001
6-cell, 55-WH, 2.8-WH Li long life battery	593585-001
3-cell, 31-WH, 2.8-WH Li battery	492548-001
3-cell, 28-WH, 2.8-WH Li long life battery	593584-001

Before disassembling the computer, follow these steps:

1. Shut down the computer. If you are unsure whether the computer is off or in Hibernation, turn the computer on, and then shut it down through the operating system.
2. Disconnect all external devices connected to the computer.
3. Disconnect the power from the computer by first unplugging the power cord from the AC outlet and then unplugging the AC adapter from the computer.

Remove the battery:

1. Turn the computer upside down on a flat surface, with the battery bay toward you.
2. Slide the battery lock latch **(1)** to unlock the battery.
3. Slide the battery release latch **(2)** to release the battery.
4. Remove the battery **(3)** from the computer.

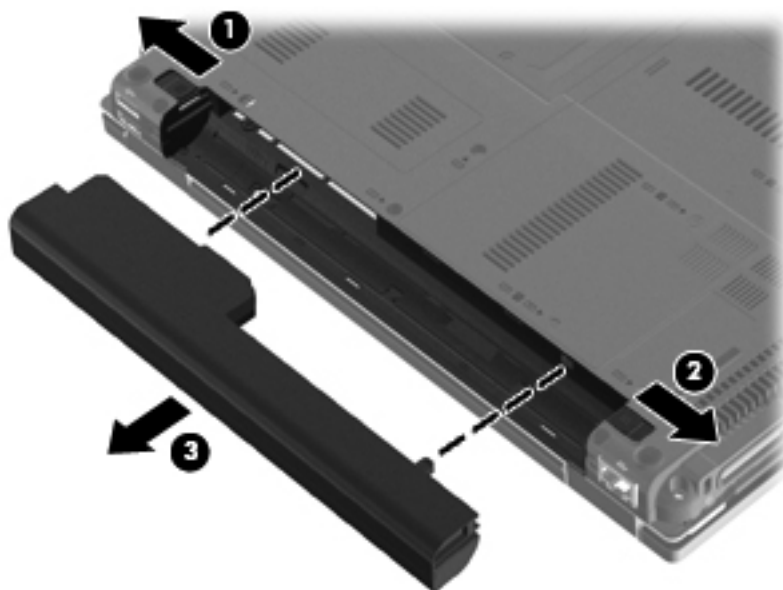

Install the battery by inserting it into the battery bay until you hear a click.

SIM

 **NOTE:** This section applies only to computer models with WWAN capability.

NOTE: If there is a SIM inserted in the SIM slot, it must be removed before disassembling the computer. Be sure that the SIM is reinserted in the SIM slot after reassembling the computer.

Before removing the SIM, follow these steps:

1. Shut down the computer. If you are unsure whether the computer is off or in Hibernation, turn the computer on, and then shut it down through the operating system.
2. Disconnect all external devices connected to the computer.
3. Disconnect the power from the computer by first unplugging the power cord from the AC outlet and then unplugging the AC adapter from the computer.
4. Remove the battery (see [Battery on page 44](#)).

Remove the SIM:

1. Press in on the SIM **(1)**. (The module partially ejects from the SIM slot.)
2. Remove the SIM **(2)** from the SIM slot.

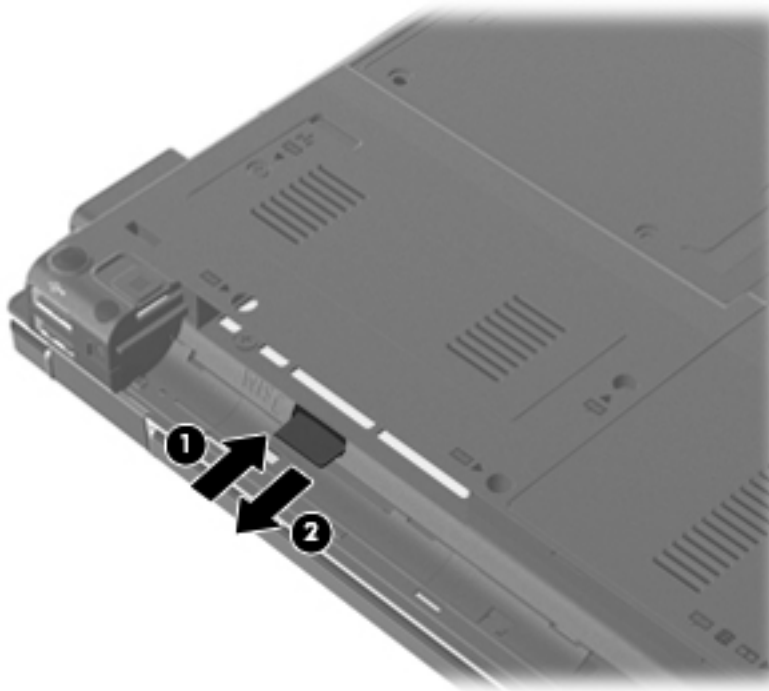

Reverse this procedure to insert the SIM.

Bluetooth module

Description	Spare part number
HP Integrated Module with Bluetooth 2.1 Wireless Technology	537921-001

NOTE: The Bluetooth module spare part kit does not include a Bluetooth module cable. The Bluetooth module cable is included in the Cable Kit, spare part number 598766-001.

Before removing the Bluetooth module, follow these steps:

1. Shut down the computer. If you are unsure whether the computer is off or in Hibernation, turn the computer on, and then shut it down through the operating system.
2. Disconnect all external devices connected to the computer.
3. Disconnect the power from the computer by first unplugging the power cord from the AC outlet and then unplugging the AC adapter from the computer.
4. Remove the battery (see [Battery on page 44](#)).

Remove the Bluetooth module:

1. Loosen the captive screw (1) that secures the Bluetooth module compartment cover to the computer.
2. Lift the cover (2) and release it as far as the Bluetooth module compartment cable allows. The Bluetooth module compartment cover is included in the Plastics Kit, spare part number 598796-001.

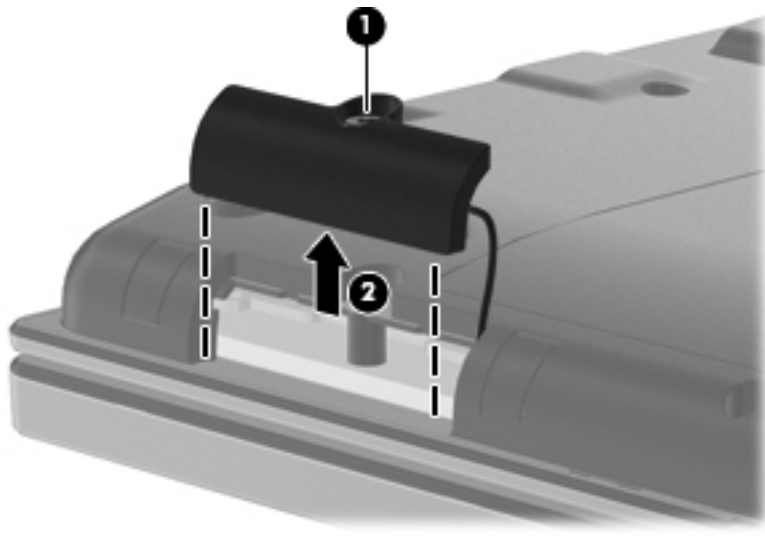

3. Disconnect the Bluetooth module cable from the Bluetooth module (1).



NOTE: See [Bluetooth module cable on page 87](#) for removal information for the Bluetooth module cable.

4. Remove the Bluetooth module **(2)** from the Bluetooth module compartment cover. The Bluetooth module compartment cover is included in the Plastics Kit, spare part number 598796-001.

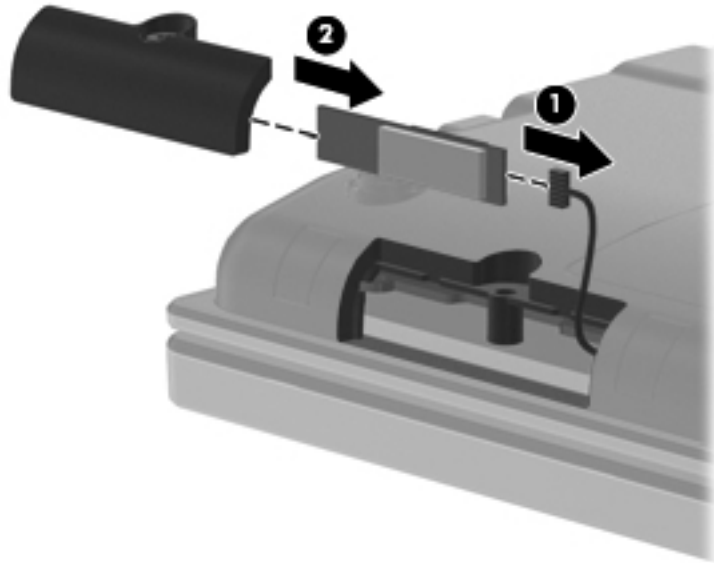

5. Remove the Bluetooth module.
Reverse the above procedure to install the Bluetooth module.

Expansion memory module

Description	Spare part number
4096-MB memory module (1333-MHz, DDR3)	599092-002
2048-MB memory module (1333-MHz, DDR3)	598856-002
1024-MB memory module (1333-MHz, DDR3)	598859-002

Before removing the memory module, follow these steps:

1. Shut down the computer. If you are unsure whether the computer is off or in Hibernation, turn the computer on, and then shut it down through the operating system.
2. Disconnect all external devices connected to the computer.
3. Disconnect the power from the computer by first unplugging the power cord from the AC outlet and then unplugging the AC adapter from the computer.
4. Remove the battery (see [Battery on page 44](#)).

Remove the memory module:

1. Position the computer with the front toward you.
2. Loosen the three captive screws (1) that secure the memory module compartment cover to the computer.
3. Lift the rear edge of the cover (2), swing it up and forward back, and then remove the cover. The memory module compartment cover is included in the Plastics Kit, spare part number 598796-001.

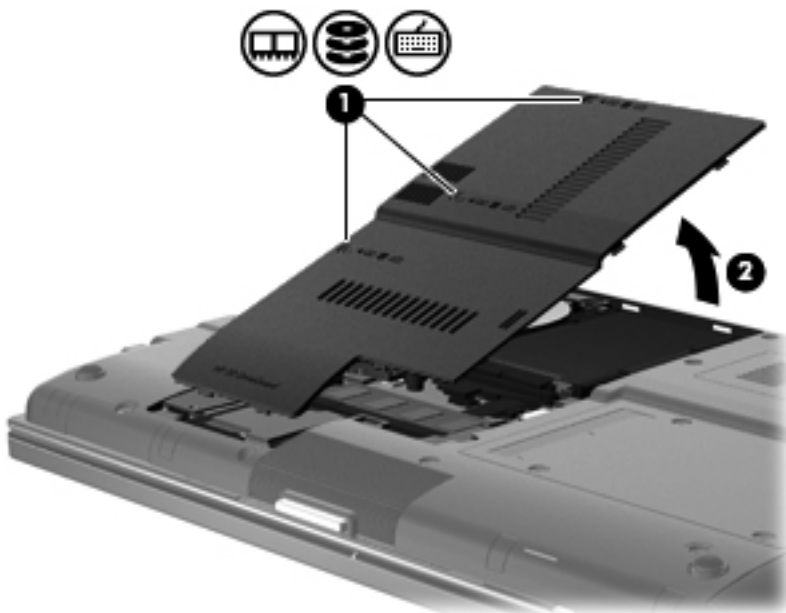

4. Spread the retaining tabs (1) on each side of the memory module slot to release the memory module. (The edge of the module opposite the slot rises away from the computer.)

5. Remove the memory module (2) by pulling the module away from the slot at an angle.

 **NOTE:** The memory module is designed with a notch to prevent incorrect insertion into the memory module slot.

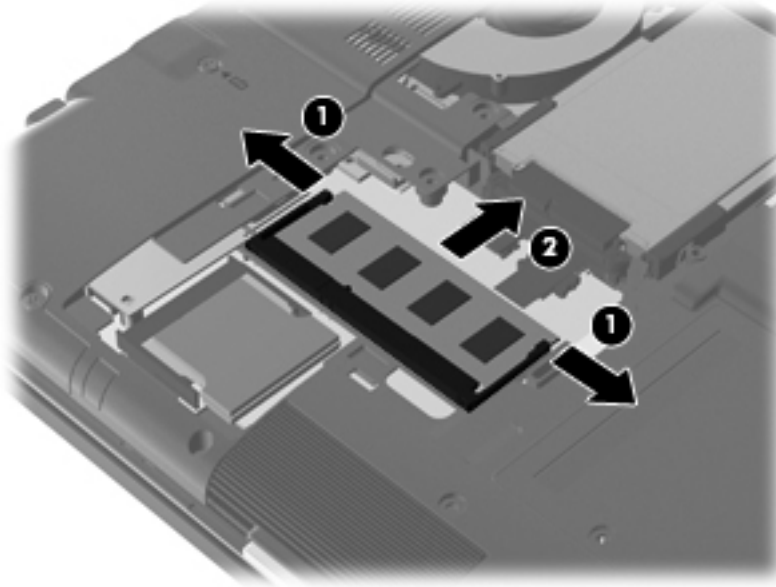

Reverse this procedure to install the memory module.

Low-voltage hard drive or solid-state drive



NOTE: The **4.57-cm** (1.80-in) hard drive and solid-state drive spare part kit includes a hard drive or solid-state drive bracket.

Description	Spare part number
4.57-cm (1.80-in), 320-GB, 5400-rpm hard drive	614537-001
4.57-cm (1.80-in), 250-GB, 5400-rpm hard drive	598778-001
4.57-cm (1.80-in), 160-GB, 5400-rpm hard drive	598777-001
4.57-cm (1.80-in), 160-GB, solid-state drive	598782-001
4.57-cm (1.80-in), 80-GB, solid-state drive	602675-001

Before removing the low-voltage hard drive or solid-state drive, follow these steps:

1. Shut down the computer. If you are unsure whether the computer is off or in Hibernation, turn the computer on, and then shut it down through the operating system.
2. Disconnect all external devices connected to the computer.
3. Disconnect the power from the computer by first unplugging the power cord from the AC outlet and then unplugging the AC adapter from the computer.
4. Remove the battery (see [Battery on page 44](#)).
5. Remove the memory module compartment cover (see [Expansion memory module on page 48](#)).

Remove the low-voltage hard drive or solid-state drive:

1. Position the computer with the front toward you.
2. Loosen the 2 captive screws **(1)** that secure the hard drive shield to the computer.

3. Lift the right edge of the hard drive shield (2), swing it up and to the left, and then remove the cover (3) by sliding it up and to the right at an angle. The hard drive shield is included in the hard drive spare part kit.

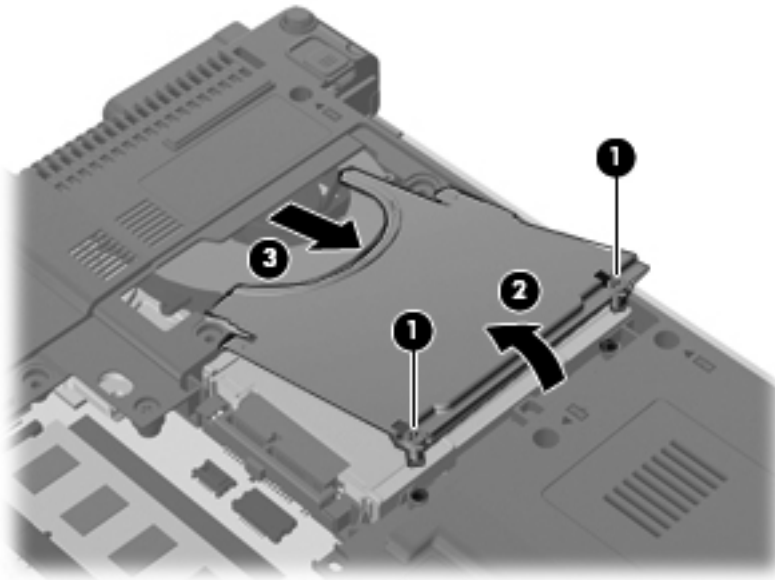

4. Lift the right side of the low-voltage hard drive (1) to disconnect it from the system board.
5. Remove the low-voltage hard drive (2).

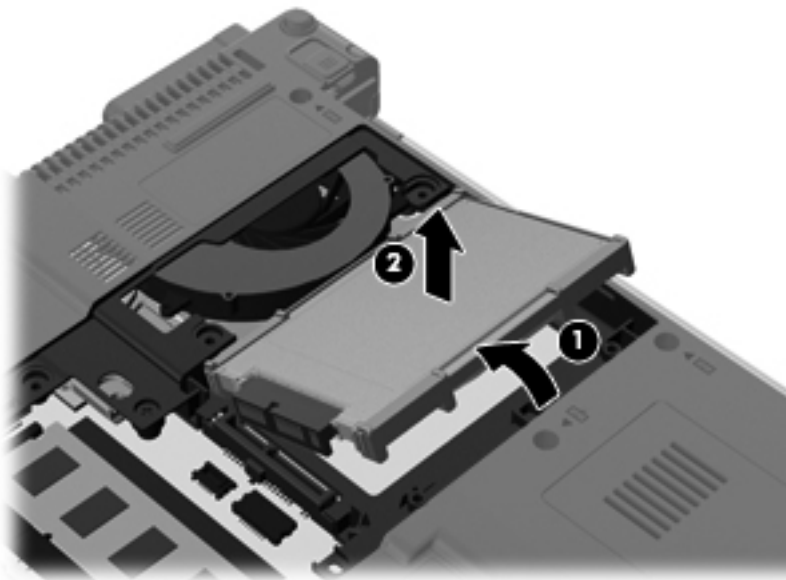

6. If it is necessary to replace the rubber isolator, separate the edges of the isolator from the end of the low-voltage hard drive, and remove the isolator.



7. If it is necessary to replace the low-voltage hard drive connector, slide the connector off of the hard drive.

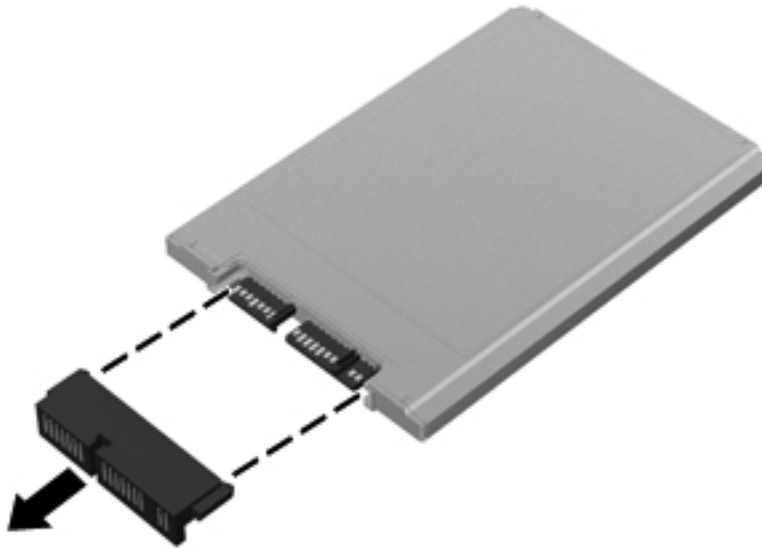

Reverse this procedure to reassemble and install the low-voltage hard drive.

WLAN module

Description	Spare part number
Broadcom 43224AGN 802.11a/b/g/draft-n WiFi Adapter for use in Antigua and Barbuda, Argentina, Aruba, the Bahamas, Barbados, Bermuda, Brunei, Canada, the Cayman Islands, Chile, Colombia, Costa Rica, the Dominican Republic, Ecuador, El Salvador, Guam, Guatemala, Haiti, Honduras, Hong Kong, India, Indonesia, Malaysia, Mexico, Panama, Paraguay, Peru, Saudi Arabia, Taiwan, Uruguay, the United States, Venezuela, and Vietnam	582564-001
Broadcom 43224AGN 802.11a/b/g/draft-n WiFi Adapter for use in Afghanistan, Albania, Algeria, Andorra, Angola, Antigua and Barbuda, Argentina, Armenia, Aruba, Australia, Austria, Azerbaijan, the Bahamas, Bahrain, Bangladesh, Barbados, Belarus, Belgium, Belize, Benin, Bermuda, Bhutan, Bolivia, Bosnia and Herzegovina, Botswana, Brazil, the British Virgin Islands, Brunei, Bulgaria, Burkina Faso, Burundi, Cambodia, Cameroon, Cape Verde, the Central African Republic, Chad, Chile, Colombia, Comoros, the Congo, Costa Rica, Croatia, Cyprus, the Czech Republic, Denmark, Djibouti, Dominica, the Dominican Republic, East Timor, Ecuador, Egypt, El Salvador, Equatorial Guinea, Eritrea, Estonia, Ethiopia, Fiji, Finland, France, French Guiana, Gabon, Gambia, Georgia, Germany, Ghana, Gibraltar, Greece, Grenada, Guadeloupe, Guatemala, Guinea, Guinea-Bissau, Guyana, Haiti, Honduras, Hong Kong, Hungary, Iceland, India, Indonesia, Ireland, Israel, Italy, the Ivory Coast, Jamaica, Jordan, Kazakhstan, Kenya, Kiribati, Kuwait, Kyrgyzstan, Laos, Latvia, Lebanon, Lesotho, Liberia, Liechtenstein, Lithuania, Luxembourg, Macedonia, Madagascar, Malawi, Malaysia, the Maldives, Mali, Malta, the Marshall Islands, Martinique, Mauritania, Mauritius, Mexico, Micronesia, Monaco, Mongolia, Montenegro, Morocco, Mozambique, Namibia, Nauru, Nepal, the Nether Antilles, the Netherlands, New Zealand, Nicaragua, Niger, Nigeria, Norway, Oman, Palau, Panama, Papua New Guinea, Paraguay, the People's Republic of China, Peru, the Philippines, Poland, Portugal, Qatar, the Republic of Moldova, Romania, Russia, Rwanda, Samoa, San Marino, Sao Tome and Principe, Saudi Arabia, Senegal, Serbia, the Seychelles, Sierra Leone, Singapore, Slovakia, Slovenia, the Solomon Islands, Somalia, South Africa, South Korea, Spain, Sri Lanka, St. Kitts and Nevis, St. Lucia, St. Vincent and the Grenadines, Suriname, Swaziland, Sweden, Switzerland, Taiwan, Tajikistan, Tanzania, Thailand, Togo, Tonga, Trinidad and Tobago, Tunisia, Turkey, Turkmenistan, Tuvalu, Uganda, Ukraine, the United Arab Emirates, the United Kingdom, Uruguay, Uzbekistan, Vanuatu, Venezuela, Vietnam, Yemen, Zaire, Zambia, and Zimbabwe	582564-002
Broadcom 4312G 802.11b/g WiFi Adapter for use in Antigua and Barbuda, Argentina, Aruba, the Bahamas, Barbados, Bermuda, Brunei, Canada, the Cayman Islands, Chile, Colombia, Costa Rica, the Dominican Republic, Ecuador, El Salvador, Guam, Guatemala, Haiti, Honduras, Hong Kong, India, Indonesia, Malaysia, Mexico, Panama, Paraguay, Peru, Saudi Arabia, Taiwan, Uruguay, the United States, Venezuela, and Vietnam	582562-001

Description	Spare part number
Broadcom 4312G 802.11b/g WiFi Adapter for use in Afghanistan, Albania, Algeria, Andorra, Angola, Antigua and Barbuda, Argentina, Armenia, Aruba, Australia, Austria, Azerbaijan, the Bahamas, Bahrain, Bangladesh, Barbados, Belarus, Belgium, Belize, Benin, Bermuda, Bhutan, Bolivia, Bosnia and Herzegovina, Botswana, Brazil, the British Virgin Islands, Brunei, Bulgaria, Burkina Faso, Burundi, Cambodia, Cameroon, Cape Verde, the Central African Republic, Chad, Chile, Colombia, Comoros, the Congo, Costa Rica, Croatia, Cyprus, the Czech Republic, Denmark, Djibouti, Dominica, the Dominican Republic, East Timor, Ecuador, Egypt, El Salvador, Equatorial Guinea, Eritrea, Estonia, Ethiopia, Fiji, Finland, France, French Guiana, Gabon, Gambia, Georgia, Germany, Ghana, Gibraltar, Greece, Grenada, Guadeloupe, Guatemala, Guinea, Guinea-Bissau, Guyana, Haiti, Honduras, Hong Kong, Hungary, Iceland, India, Indonesia, Ireland, Israel, Italy, the Ivory Coast, Jamaica, Jordan, Kazakhstan, Kenya, Kiribati, Kuwait, Kyrgyzstan, Laos, Latvia, Lebanon, Lesotho, Liberia, Liechtenstein, Lithuania, Luxembourg, Macedonia, Madagascar, Malawi, Malaysia, the Maldives, Mali, Malta, the Marshall Islands, Martinique, Mauritania, Mauritius, Mexico, Micronesia, Monaco, Mongolia, Montenegro, Morocco, Mozambique, Namibia, Nauru, Nepal, the Nether Antilles, the Netherlands, New Zealand, Nicaragua, Niger, Nigeria, Norway, Oman, Palau, Panama, Papua New Guinea, Paraguay, the People's Republic of China, Peru, the Philippines, Poland, Portugal, Qatar, the Republic of Moldova, Romania, Russia, Rwanda, Samoa, San Marino, Sao Tome and Principe, Saudi Arabia, Senegal, Serbia, the Seychelles, Sierra Leone, Singapore, Slovakia, Slovenia, the Solomon Islands, Somalia, South Africa, South Korea, Spain, Sri Lanka, St. Kitts and Nevis, St. Lucia, St. Vincent and the Grenadines, Suriname, Swaziland, Sweden, Switzerland, Taiwan, Tajikistan, Tanzania, Thailand, Togo, Tonga, Trinidad and Tobago, Tunisia, Turkey, Turkmenistan, Tuvalu, Uganda, Ukraine, the United Arab Emirates, the United Kingdom, Uruguay, Uzbekistan, Vanuatu, Venezuela, Vietnam, Yemen, Zaire, Zambia, and Zimbabwe	582562-002
Intel Centrino Advanced-N 6200 WLAN module for use in the United States and Canada	572509-001

 **CAUTION:** The WWAN module and the WLAN module are not interchangeable.

CAUTION: To prevent an unresponsive system, replace the wireless module only with a wireless module authorized for use in the computer by the governmental agency that regulates wireless devices in your country or region. If you replace the module and then receive a warning message, remove the module to restore computer functionality, and then contact technical support through Help and Support.

Before removing the WLAN module, follow these steps:

1. Shut down the computer. If you are unsure whether the computer is off or in Hibernation, turn the computer on, and then shut it down through the operating system.
2. Disconnect all external devices connected to the computer.
3. Disconnect the power from the computer by first unplugging the power cord from the AC outlet and then unplugging the AC adapter from the computer.
4. Remove the battery (see [Battery on page 44](#)).

Remove the WLAN module:

1. Loosen the captive screw **(1)** that secures the wireless module compartment cover to the computer.

2. Lift the right edge of the wireless module compartment cover **(2)**, swing it up and to the left, and remove the cover. The wireless module compartment cover is included in the Plastics Kit, spare part number 598796-001.

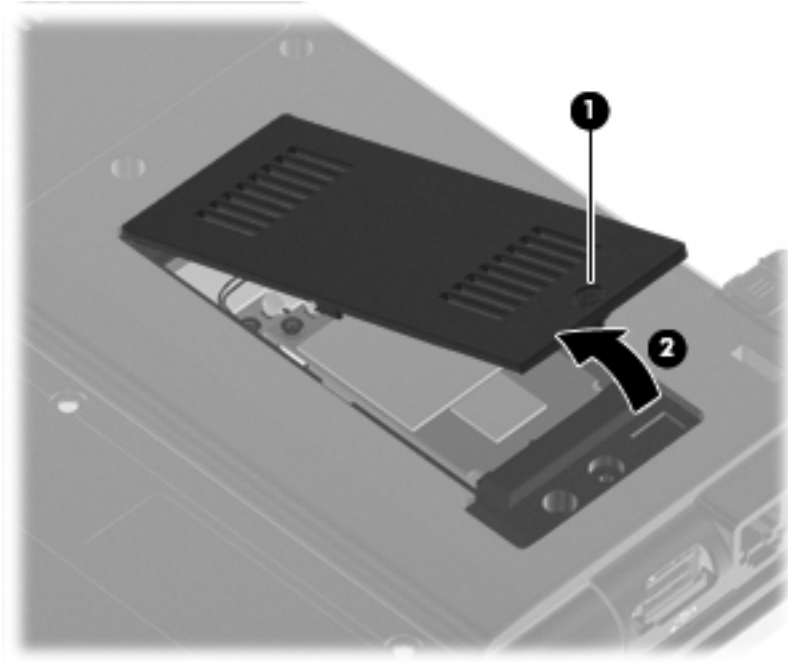

3. Disconnect the WLAN antenna cables **(1)** from the terminals on the WLAN module.





NOTE: The black WLAN antenna cable is connected to the WLAN module “Main” terminal.
The white WLAN antenna cable is connected to the WLAN module “Aux” terminal.

4. Remove the two Phillips PM2.5×6.0 screws **(2)** that secure the WLAN module to the computer. (The edge of the module opposite the slot rises away from the computer.)

5. Remove the WLAN module (3) by pulling the module away from the slot at an angle.

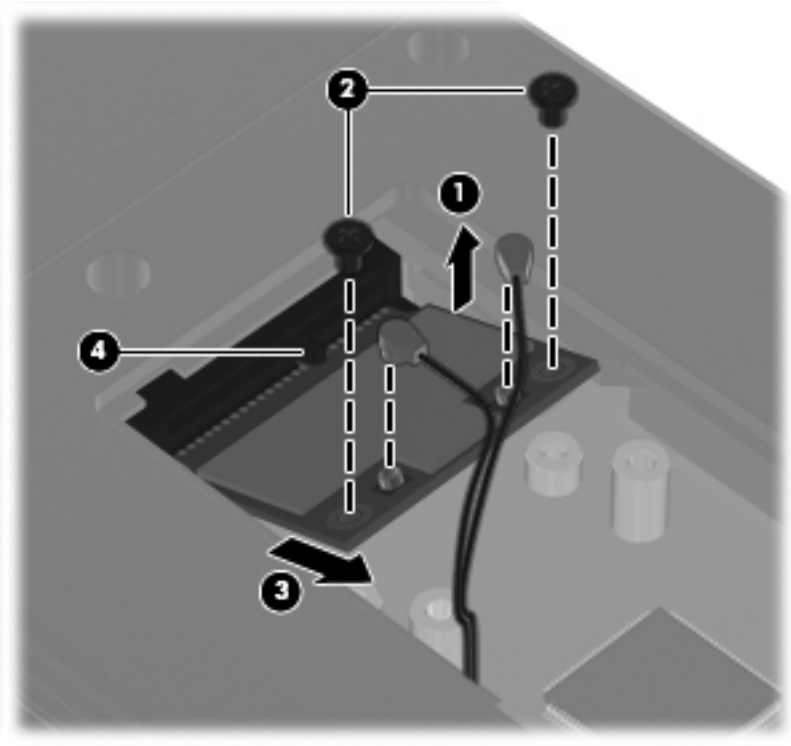
 **NOTE:** WLAN modules are designed with a notch (4) to prevent incorrect insertion.



 **NOTE:** If the WLAN antennas are not connected to the terminals on the WLAN module, the protective sleeves must be installed on the antenna connectors, as shown in the following illustration.

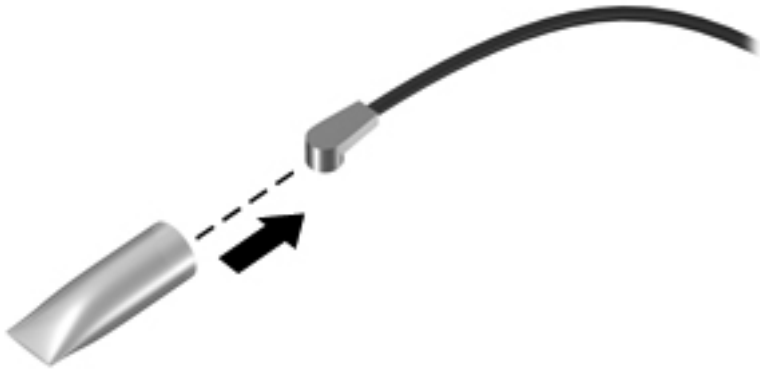

Reverse this procedure to install the WLAN module.

WWAN module

Description	Spare part number
HP un2420 Broadband Module for use in all countries and regions	531993-001
HP hs2330 HSPA Mobile Broadband Module for use in all countries and regions	574249-001
HP hs2320 HSPA Mobile Broadband Module for use only in Europe, the Middle East, and Africa	574248-001

NOTE: For use only on selected computer models.

 **CAUTION:** The WWAN module and the WLAN module are not interchangeable.

CAUTION: To prevent an unresponsive system, replace the wireless module only with a wireless module authorized for use in the computer by the governmental agency that regulates wireless devices in your country or region. If you replace the module and then receive a warning message, remove the module to restore computer functionality, and then contact technical support through Help and Support.

Before removing the WWAN module, follow these steps:

1. Shut down the computer. If you are unsure whether the computer is off or in Hibernation, turn the computer on, and then shut it down through the operating system.
2. Disconnect all external devices connected to the computer.
3. Disconnect the power from the computer by first unplugging the power cord from the AC outlet and then unplugging the AC adapter from the computer.
4. Remove the battery (see [Battery on page 44](#)).
5. Remove the wireless module compartment cover (see [WLAN module on page 53](#)).

Remove the WWAN module:

1. Disconnect the WWAN antenna cables **(1)** from the terminals on the WWAN module.





NOTE: The red WWAN antenna cable is connected to the WWAN module “Main” terminal. The blue WWAN antenna cable is connected to the WWAN module “Aux” terminal.

2. Remove the two Phillips PM2.5×6.0 screws that secure the WWAN module to the computer **(2)**. (The edge of the module opposite the socket rises.)

3. Remove the WWAN module (3) by pulling the module away from the slot at an angle.

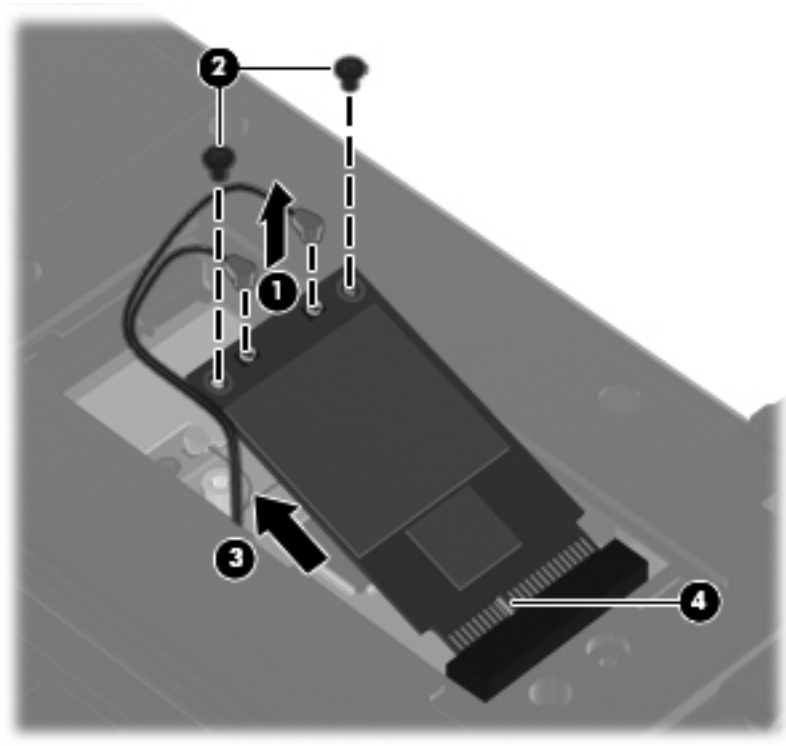
 **NOTE:** WWAN modules are designed with a notch (4) to prevent incorrect insertion.



 **NOTE:** If the WWAN antennas are not connected to the terminals on the WWAN module, the protective sleeves must be installed on the antenna connectors, as shown in the following illustration.

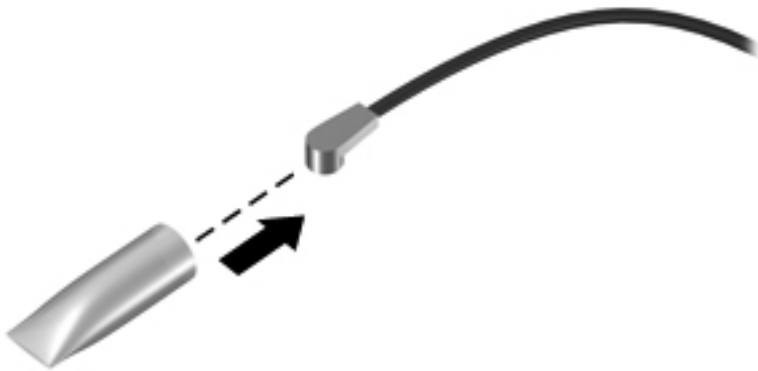

Reverse this procedure to install the WWAN module.

Optical drive

 **NOTE:** The optical drive is an optional feature and is available only on computer models equipped with a low voltage (25-W) processor.

Description	Spare part number
DVD±RW and CD-RW SuperMulti Double-Layer Drive	598776-001
DVD-ROM Drive	598775-001

Before removing the optical drive, follow these steps:

1. Shut down the computer. If you are unsure whether the computer is off or in Hibernation, turn the computer on, and then shut it down through the operating system.
2. Disconnect all external devices connected to the computer.
3. Disconnect the power from the computer by first unplugging the power cord from the AC outlet and then unplugging the AC adapter from the computer.
4. Remove the battery (see [Battery on page 44](#)).
5. Remove the memory module compartment cover (see [Expansion memory module on page 48](#)).

Remove the optical drive:

1. Position the computer with the right side toward you.
2. Remove the two Phillips PM2.0×5.0 screws that secure the optical drive to the computer.

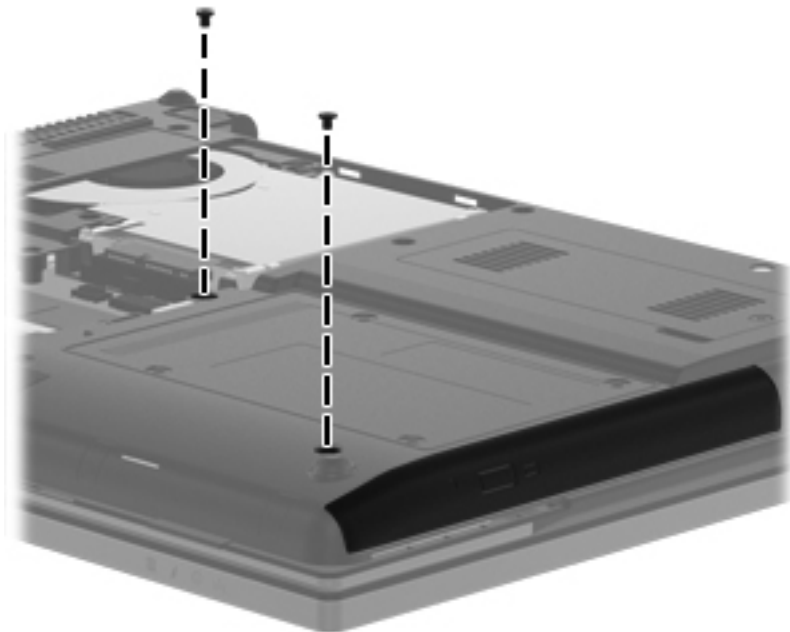

3. Insert a flat-bladed screwdriver or similar tool into the optical drive tab access (1) and press the tab to the right to release the optical drive from the computer.

4. Remove the optical drive **(2)** from the computer.

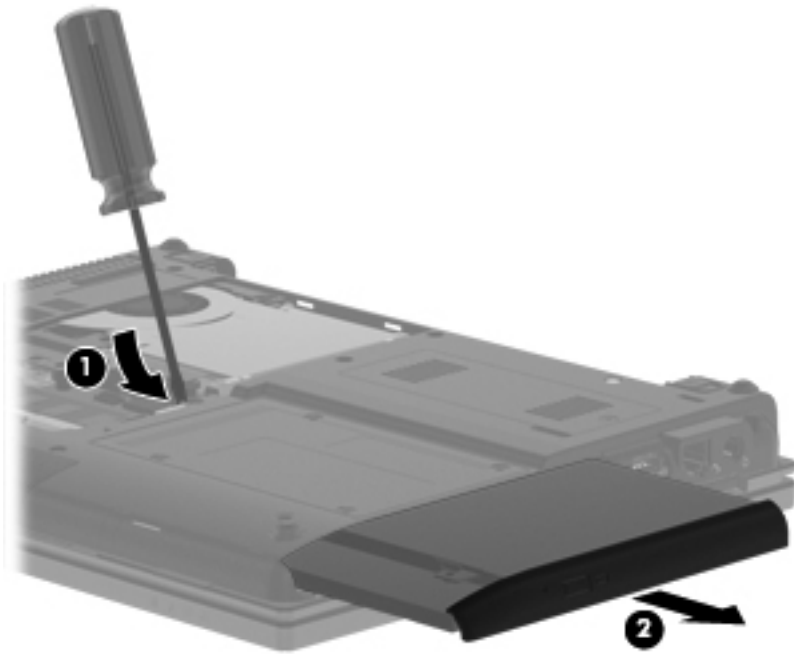

5. If it is necessary to replace the optical drive bracket, position the optical drive with the rear toward you.
6. Remove the two Phillips PM2.0×4.0 screws **(1)** that secure the optical drive bracket to the optical drive.
7. Remove the optical drive bracket **(2)**.

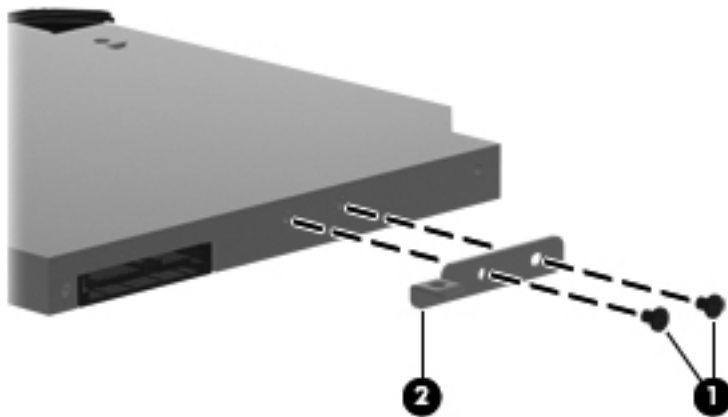

Reverse this procedure to reassemble and install the optical drive.

Standard-voltage hard drive or solid-state drive

 **NOTE:** Installation of the **6.35-cm** (2.50-in) hard drive or solid-state drive in the hard drive bay is not supported. The **6.35-cm** (2.50-in) hard drive or solid-state drive cannot be installed when the optical drive is installed.

Description	Spare part number
2.50-in, 500-GB, 7200-rpm hard drive	598781-001
2.50-in, 320-GB, 7200-rpm hard drive	598780-001
2.50-in, 320-GB, 7200-rpm SED hard drive	618243-001
2.50-in, 250-GB, 7200-rpm hard drive	598779-001
2.50-in, Hard drive carrier kit (includes HDD and ODD connector boards and the USB board)	598787-001
1.80-in, 160-GB, solid-state drive	598783-001
1.80-in, 80-GB, solid-state drive	602676-001
1.80-in, Hard drive carrier kit	598786-001

 **NOTE:** The standard-voltage hard drive or solid-state drive must be installed in the optical drive bay, and replaces the optical drive.

Before removing the standard-voltage hard drive, follow these steps:

1. Shut down the computer. If you are unsure whether the computer is off or in Hibernation, turn the computer on, and then shut it down through the operating system.
2. Disconnect all external devices connected to the computer.
3. Disconnect the power from the computer by first unplugging the power cord from the AC outlet and then unplugging the AC adapter from the computer.
4. Remove the battery. (See [Battery on page 44](#))
5. Remove the memory module compartment cover (see [Expansion memory module on page 48](#)).

Remove the standard-voltage hard drive:

1. Remove the four Phillips PM3.0×3.0 screws **(1)** and the two Phillips PM2.0×5.0 screws **(2)** that secure the hard drive carrier to the computer.

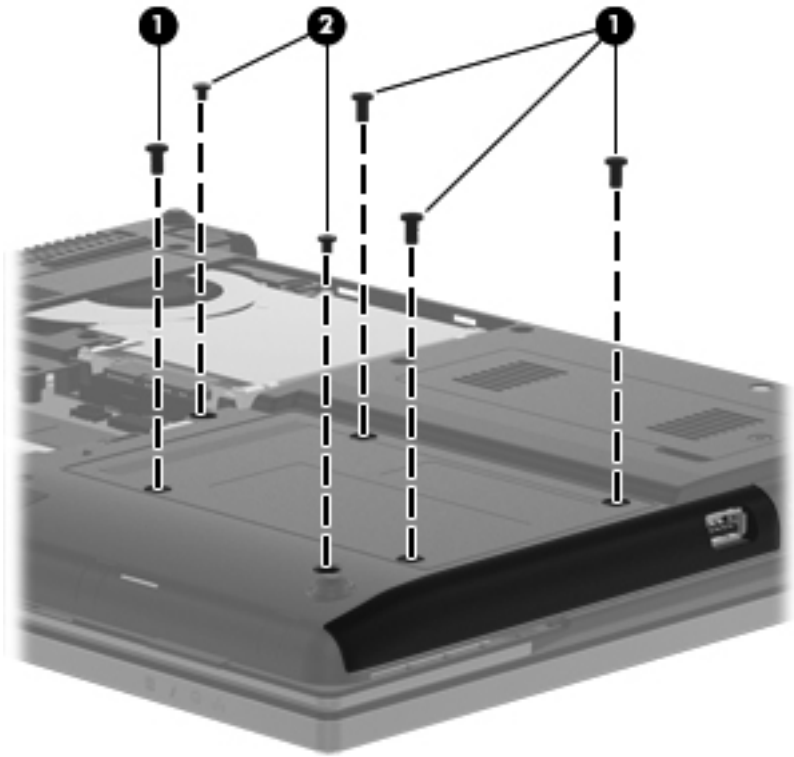

2. Insert a flat-bladed screwdriver or similar tool into the optical drive tab access **(1)** and press the tab to the right to release the hard drive carrier **(2)** from the computer.

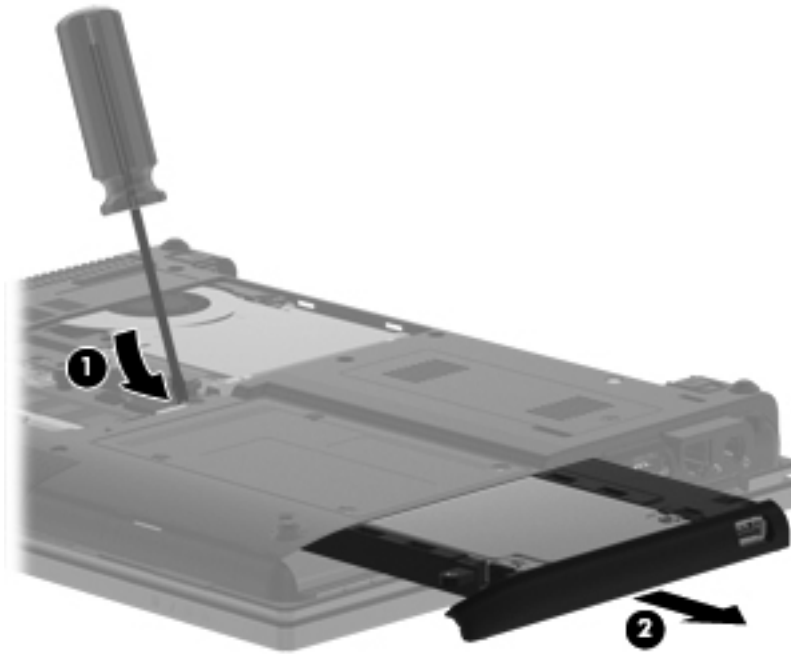

3. Remove the four Phillips PM3.0×3.0 screws that secure the standard-voltage hard drive to the hard drive carrier.

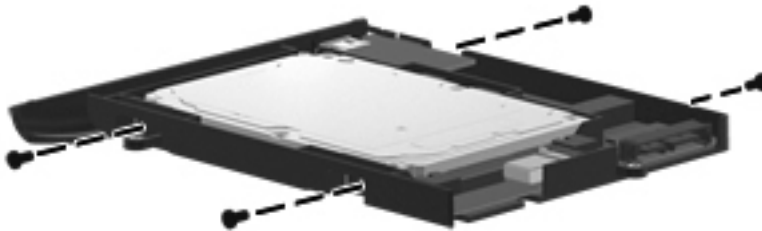

4. Lift the front edge of the standard-voltage hard drive **(1)** until it clears the front edge of the hard drive carrier.

5. Remove the standard-voltage hard drive (2) by sliding it up and away from the hard drive carrier at an angle.

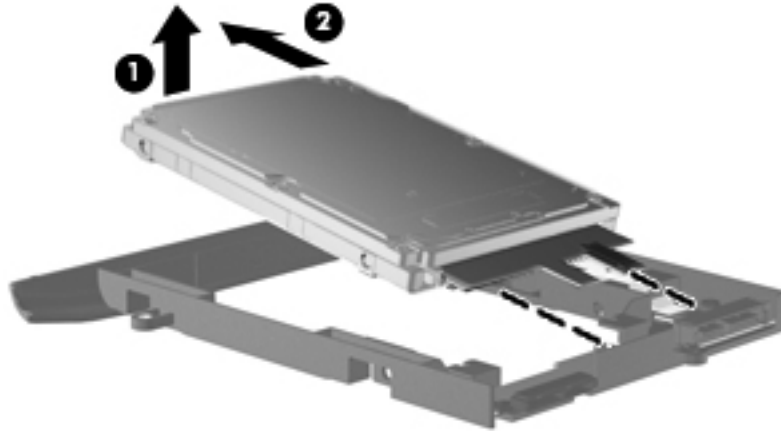

Reverse the above procedure to reassemble and install the standard-voltage hard drive.

Switch cover and keyboard

Description		Spare part number	
Switch cover (includes power button board and cable)		598800-001	
Keyboard for use in country/ region	Spare part number	Keyboard for use in country/ region	Spare part number
Belgium	598790-A41	Norway	598790-091
Brazil	598790-201	Portugal	598790-131
Bulgaria	598790-261	Russia	598790-251
The Czech Republic	598790-A81	Saudi Arabia	598790-171
Denmark	598790-081	Slovakia	598790-A81
France	598790-051	Slovenia	598790-BA1
French Canada	598790-121	South Korea	598790-AD
Germany	598790-041	Spain	598790-071
Greece	598790-DJ	Sweden and Finland	598790-B71
Hungary	598790-211	Switzerland	598790-BG1
Iceland	598790-DD1	Taiwan	598790-AB1
Israel	598790-BB1	Thailand	598790-281
Italy	598790-061	Turkey	598790-141
Japan	598790-291	The United Kingdom and Singapore	598790-031
Latin America	598790-161	The United States	598790-001
The Netherlands	598790-B31		

Before removing the switch cover and keyboard, follow these steps:

1. Shut down the computer. If you are unsure whether the computer is off or in Hibernation, turn the computer on, and then shut it down through the operating system.
2. Disconnect all external devices connected to the computer.
3. Disconnect the power from the computer by first unplugging the power cord from the AC outlet and then unplugging the AC adapter from the computer.
4. Remove the battery (see [Battery on page 44](#)).
5. Remove the memory module compartment cover (see [Expansion memory module on page 48](#)).
6. Remove the wireless module compartment cover (see [WLAN module on page 53](#)).

Remove the switch cover and keyboard:

1. Loosen the three captive screws **(1)** that secure the switch cover to the computer.

2. Loosen the four captive screws (2) that secure the keyboard to the computer.

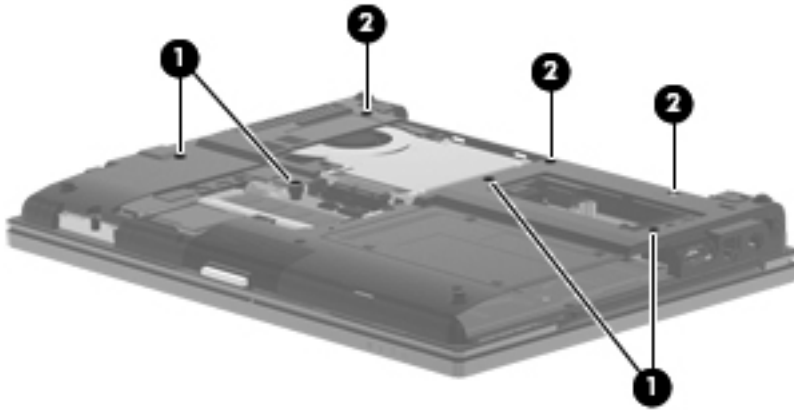

3. Turn the computer right-side up, with the front toward you.
4. Open the display as far as possible.
5. Lift the right side of the switch cover (1) to detach it from the computer.
6. Release the switch cover (2) as far as the power button board and capacitive board cables allow.

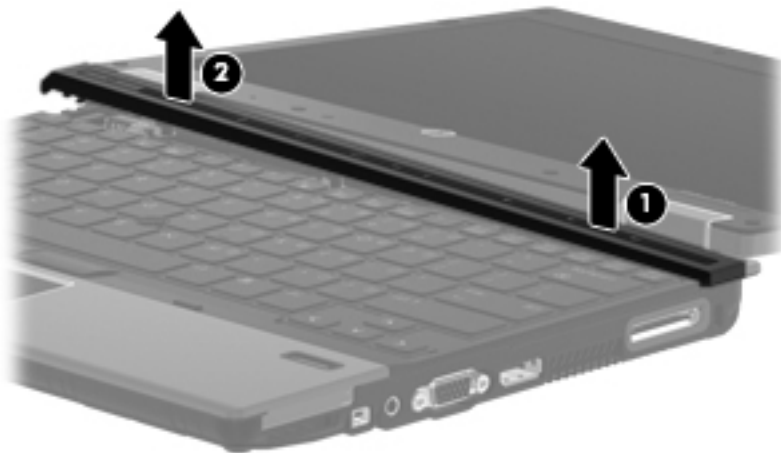

7. Lift the rear edge of the keyboard (1) until it rests at an angle.
8. Slide the keyboard (2) back until the tabs on the front edge of the keyboard disengage from the slots in the top cover.

9. Swing the rear edge of the keyboard (3) up and forward until the keyboard rests upside down on the palm rest.

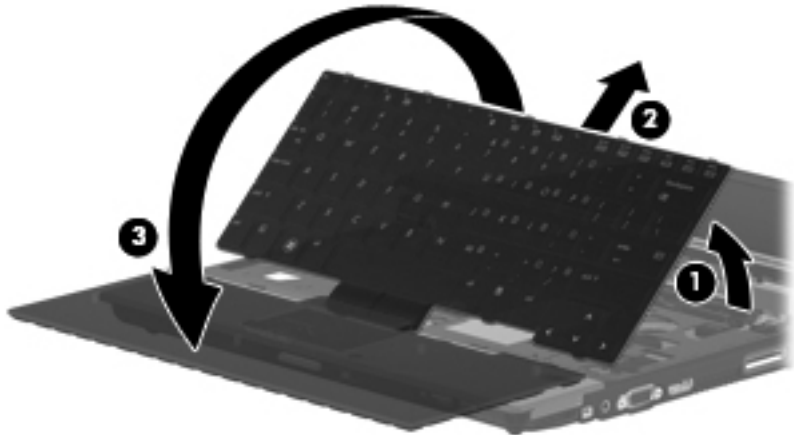

10. Release the zero insertion force (ZIF) connector (1) to which the keyboard cable is attached, and then disconnect the keyboard cable (2) from the system board.
11. Release the ZIF connector (3) to which the pointing stick cable is attached, and then disconnect the pointing stick cable (4) from the system board.
12. Remove the keyboard (5).

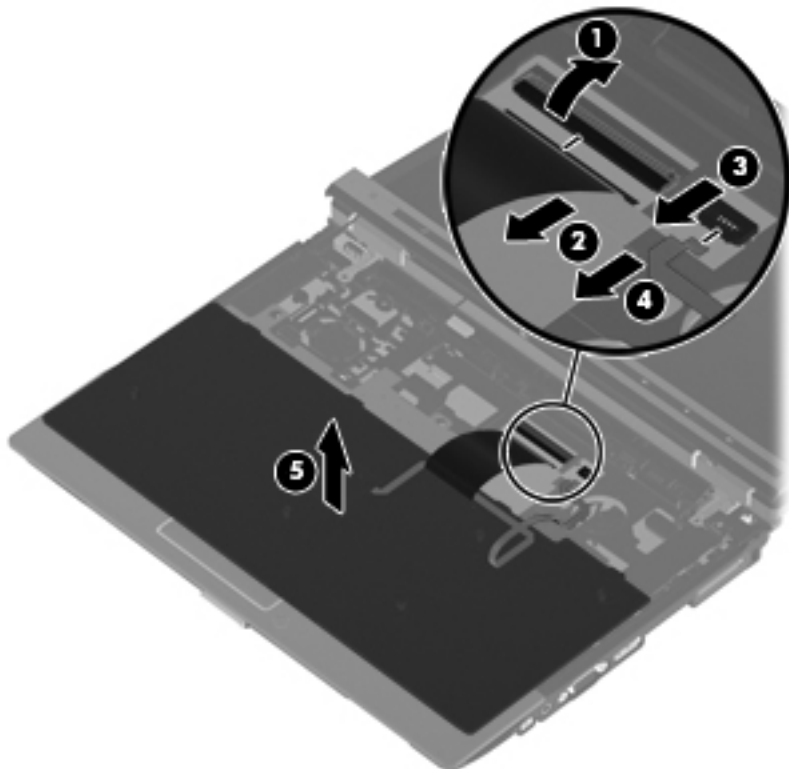

13. Disconnect the power button board cable (1) and the capacitive board cable (2) from the system board.

14. Remove the switch cover (3).

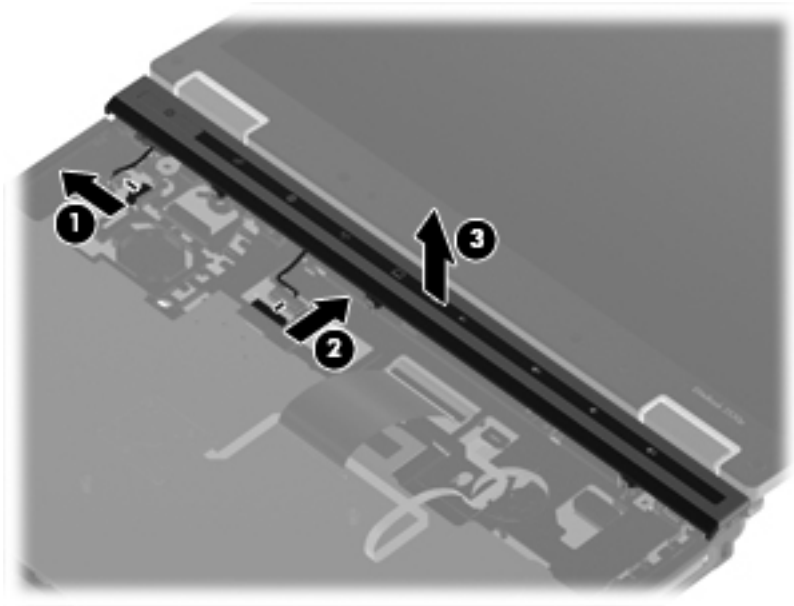

Reverse this procedure to install the switch cover and keyboard.

RTC battery

Description	Spare part number
RTC battery	481089-001

Before removing the RTC battery, follow these steps:

1. Shut down the computer. If you are unsure whether the computer is off or in Hibernation, turn the computer on, and then shut it down through the operating system.
2. Disconnect all external devices connected to the computer.
3. Disconnect the power from the computer by first unplugging the power cord from the AC outlet and then unplugging the AC adapter from the computer.
4. Remove the battery (see [Battery on page 44](#)), and then remove the following components:
 - a. Memory module compartment cover (see [Expansion memory module on page 48](#))
 - b. Wireless module compartment cover (see [WLAN module on page 53](#))
 - c. Switch cover and keyboard (see [Switch cover and keyboard on page 65](#))

Remove the RTC battery:

- ▲ Use a flat-bladed, non-conductive tool to remove the RTC battery from the socket.

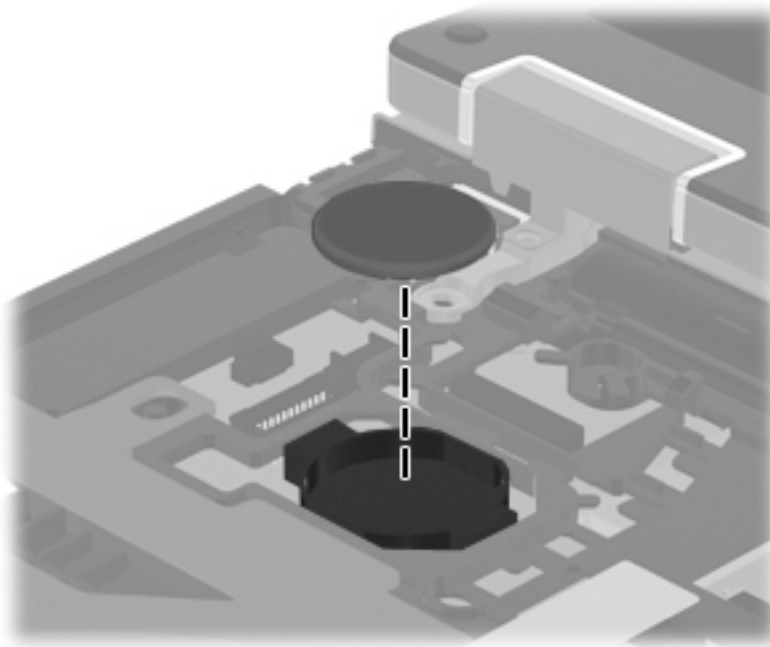

Reverse this procedure to install the RTC battery.

Primary memory module

Description	Spare part number
4096-MB memory module (1333-MHz, DDR3)	599092-002
2048-MB memory module (1333-MHz, DDR3)	598856-002
1024-MB memory module (1333-MHz, DDR3)	598859-002
Memory shield (includes one captive screw)	598793-001

Before removing the primary memory module, follow these steps:

1. Shut down the computer. If you are unsure whether the computer is off or in Hibernation, turn the computer on, and then shut it down through the operating system.
2. Disconnect all external devices connected to the computer.
3. Disconnect the power from the computer by first unplugging the power cord from the AC outlet and then unplugging the AC adapter from the computer.
4. Remove the battery (see [Battery on page 44](#)), and then remove the following components:
 - a. Memory module compartment cover (see [Expansion memory module on page 48](#))
 - b. Wireless module compartment cover (see [WLAN module on page 53](#))
 - c. Switch cover and keyboard (see [Switch cover and keyboard on page 65](#))

Remove the primary memory module:

1. Remove the Phillips PM2.0×5.0 screw (1) that secures the primary memory module shield to the top cover.
2. Remove the primary memory module shield (2). The primary memory module shield is available using spare part number 598793-001.

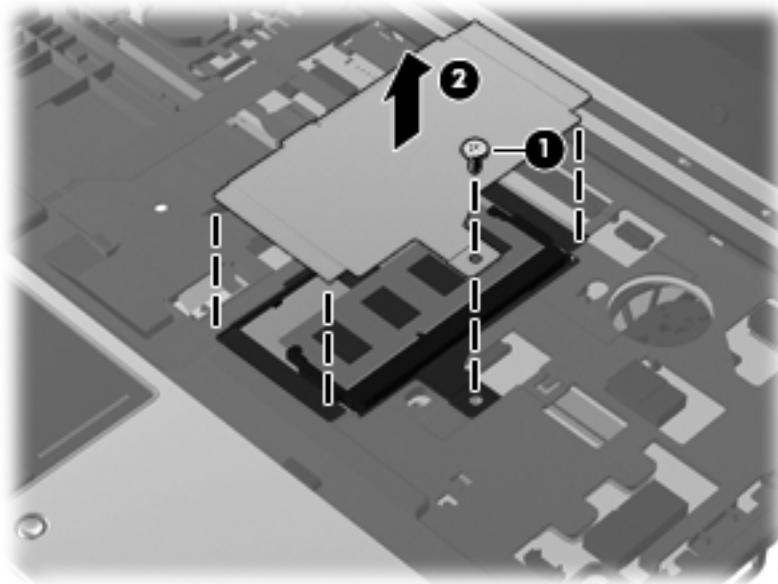

3. Spread the retaining tabs **(1)** on each side of the memory module slot to release the memory module. (The edge of the module opposite the slot rises away from the computer.)
4. Remove the memory module **(2)** by pulling the module away from the slot at an angle.

 **NOTE:** The memory module is designed with a notch to prevent incorrect insertion into the memory module slot.

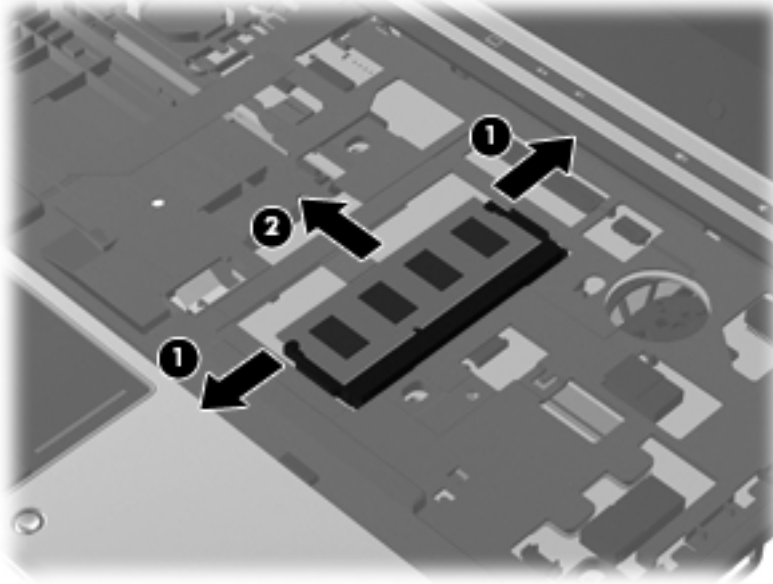

Reverse this procedure to install the memory module.

Display assembly

Description	Spare part number
12.1-in, WXGA AntiGlare LED display assembly for use only with computer models equipped with a webcam (includes display panel cable, WLAN antenna transceivers and cables, and WWAN antenna transceivers and cables).	598794-001
12.1-in, WXGA AntiGlare LED display assembly for use only with computer models not equipped with a webcam (includes display panel cable, WLAN antenna transceivers and cables, and WWAN antenna transceivers and cables).	598795-001

Before removing the display assembly, follow these steps:

1. Shut down the computer. If you are unsure whether the computer is off or in Hibernation, turn the computer on, and then shut it down through the operating system.
2. Disconnect all external devices connected to the computer.
3. Disconnect the power from the computer by first unplugging the power cord from the AC outlet and then unplugging the AC adapter from the computer.
4. Remove the battery (see [Battery on page 44](#)).
5. Remove the memory module compartment cover (see [Expansion memory module on page 48](#)).
6. Remove the wireless module compartment cover (see [WLAN module on page 53](#)).
7. Disconnect the wireless antenna cables from the WLAN module (see [WLAN module on page 53](#)) and the WWAN module (see [WWAN module on page 57](#)).
8. Remove the switch cover and keyboard (see [Switch cover and keyboard on page 65](#)).

Remove the display assembly:

1. Close the computer and turn it upside down, with the rear panel toward you.
2. Remove the two rubber screw covers **(1)** and the two Torx T8M2.0×6.0 screws **(2)** from the bottom of the base enclosure.
3. Remove the two Torx T8M2.0×6.0 screws **(3)** from the rear panel.

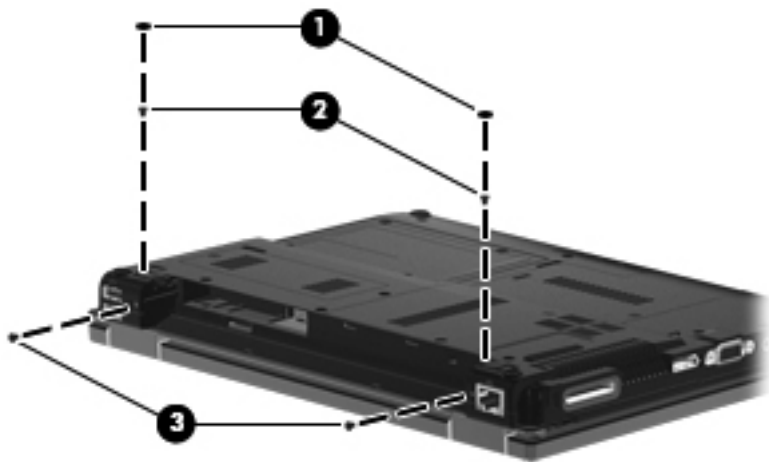

4. Turn the computer right-side up, with the front toward you.

5. Open the display as far as it will open.
6. Disconnect the display panel cable (1) from the system board and release it from the clip built into the top cover.
7. Release the wireless antenna cables from the clips (2) built into the top cover.

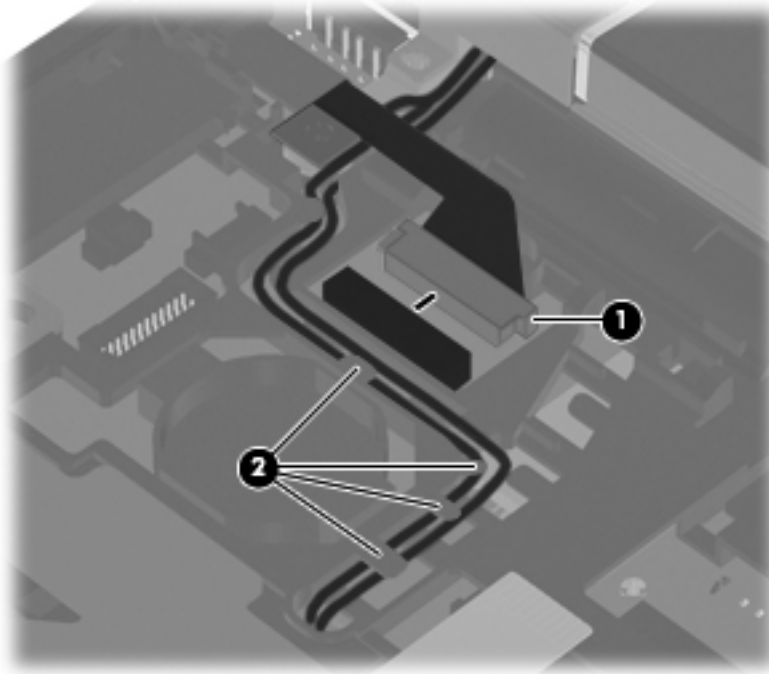

8. Disconnect the microphone cable (1) from the system board.

9. Release the microphone cable and the wireless antenna cables from the clips **(2)** built into the top cover.

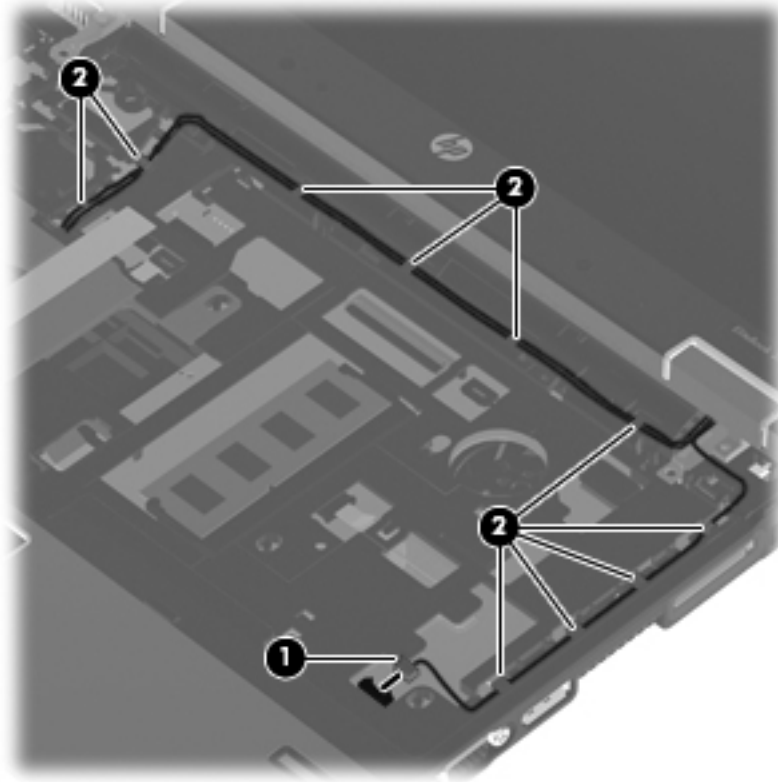

⚠ CAUTION: The display assembly will be unsupported when the following screws are removed. To prevent damage to the display assembly, support it before removing the screws.

10. Remove the two Torx T8M2.5×6.0 screws **(1)** that secure the display assembly to the computer.

📝 NOTE: The screw on the left display hinge also secures a display panel cable ground loop **(2)**.

11. Lift the display assembly straight up to remove it (3).

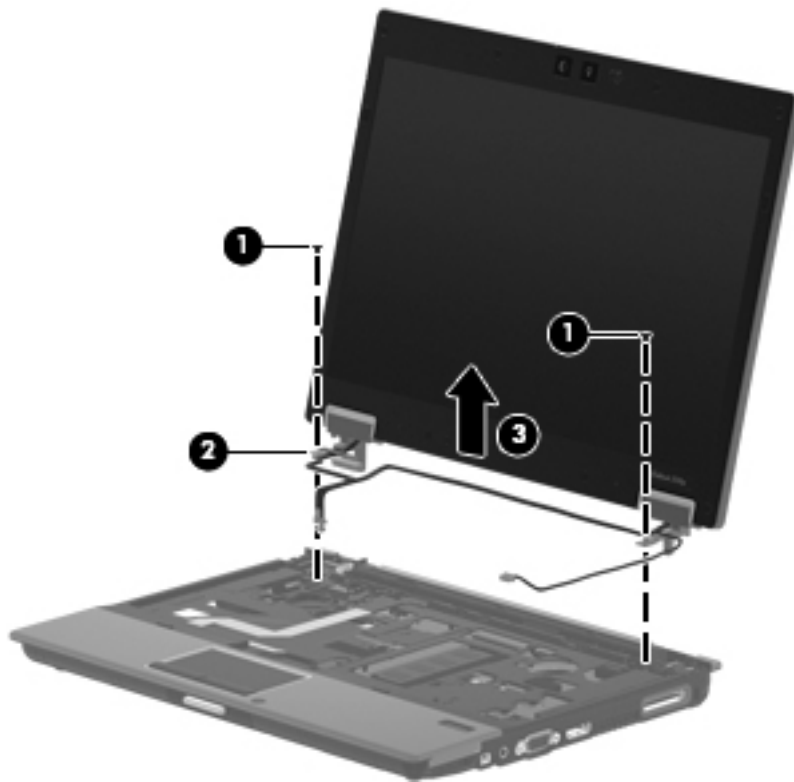

12. If it is necessary to replace the display bezel or any of the display assembly internal components:
- Remove the four rubber screw covers (1) and the four Torx T8M2.5×5.0 screws (2) that secure the display bezel to the display assembly.

 **NOTE:** The rubber screw covers on the display bezel top edge are thicker than the rubber screw covers on the display bezel bottom edge.

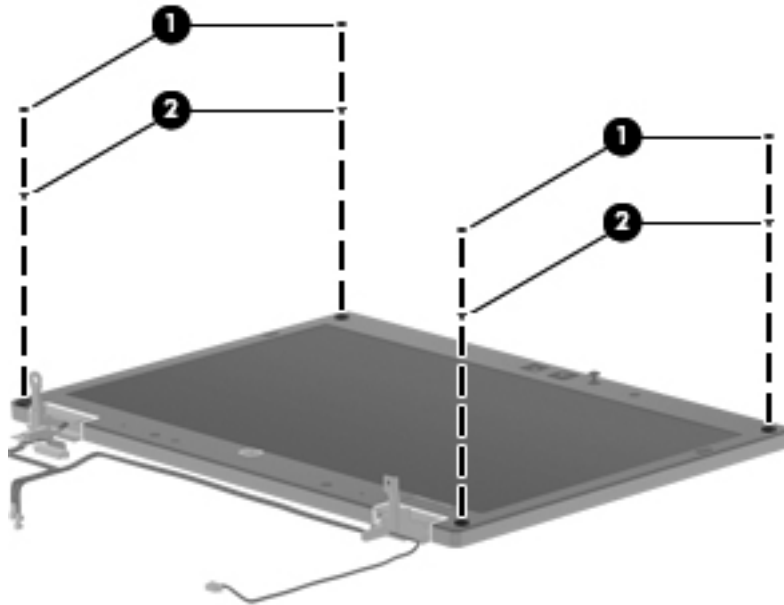

- Flex the inside edges of the top edge (1), the left and right sides (2), and the bottom edge (3) of the display bezel until the bezel disengages from the display enclosure.

- c. Remove the display bezel (4). The display bezel is available using spare part numbers 598770-001 (for use only with computer models equipped with a webcam) and 598771-001 (for use only with computer models not equipped with a webcam).

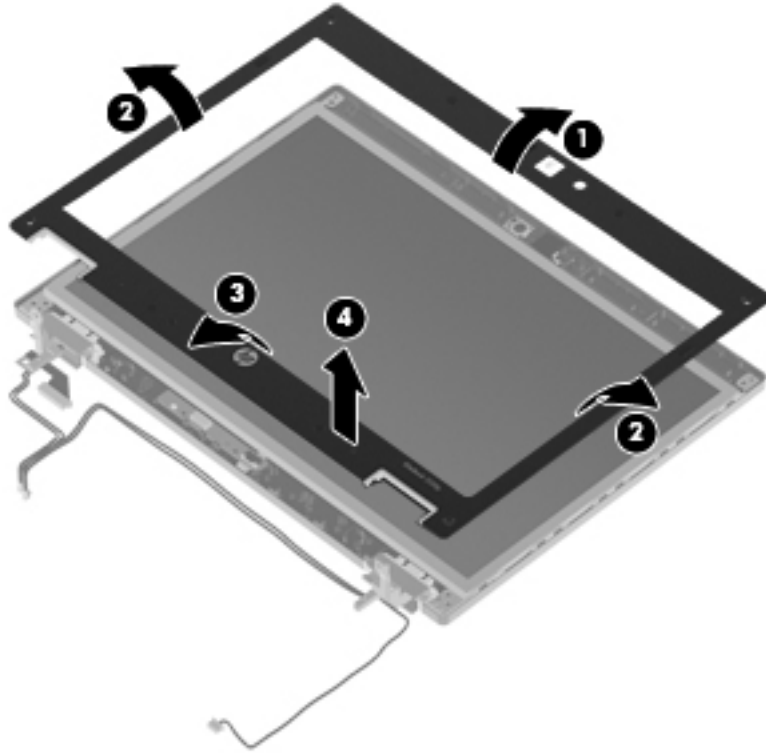

- 13. If it is necessary to replace the ambient light sensor board:
 - a. Release the ZIF connector to which the ambient light sensor board is connected, and then disconnect the cable (1) from the board.
 - b. Remove the Torx T8M2.0×3.0 screw (2) that secures the ambient light sensor board to the display enclosure.

- c. Remove the ambient light sensor board (3). The ambient light sensor board is available using spare part number 598761-001.

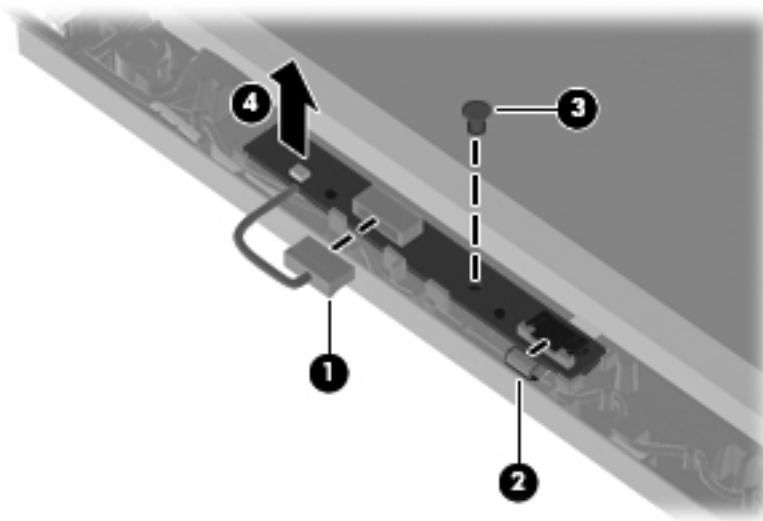

14. If it is necessary to replace the webcam module, display hinges, display panel cable, or display enclosure:
- Release the display panel cable (1) from the clips built into the display enclosure.
 - Disconnect the display panel cable (2) from the ambient light sensor board.

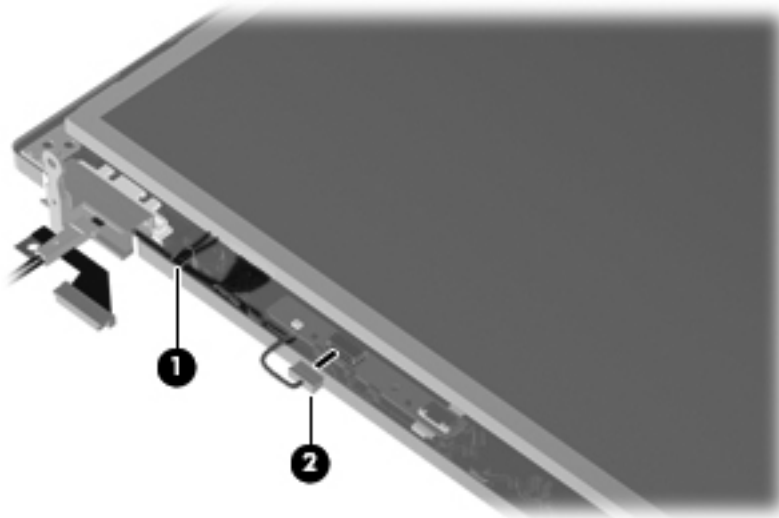

- Remove the two Torx T8M2.5×6.0 screws (1) that secure the display panel and hinges to the display enclosure.
- Lift the bottom edge of the display panel (2) until it rests at an angle.

- e. Disconnect the display panel cable (3) from the passthrough board.

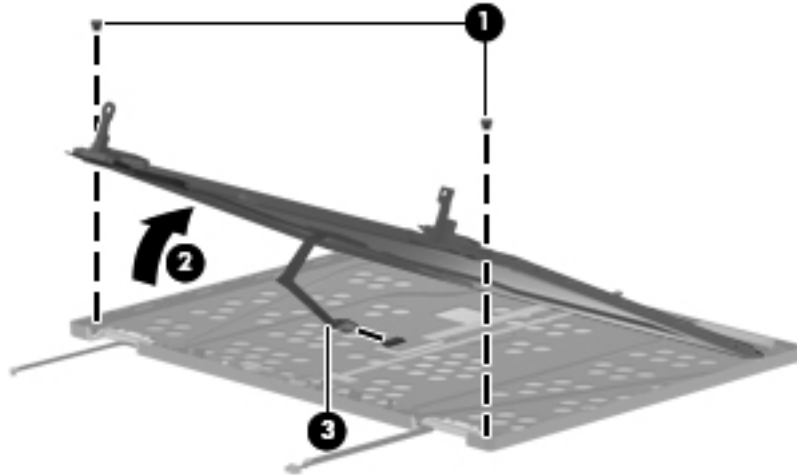

- f. Remove the display panel.
- g. Remove the two Phillips PM2.0×4.0 screws (1) that secure each display hinge to the display panel.
- h. Remove the display hinges (2). The display hinges are included in the Display Hinge Kit, spare part number 598773-001.
- i. Remove the Torx T8M2.0×4.0 screws (3) that secure the hinge covers to the hinges.
- j. Remove the hinge covers (4). The hinge covers are included in the Plastics Kit, spare part number 598796-001.

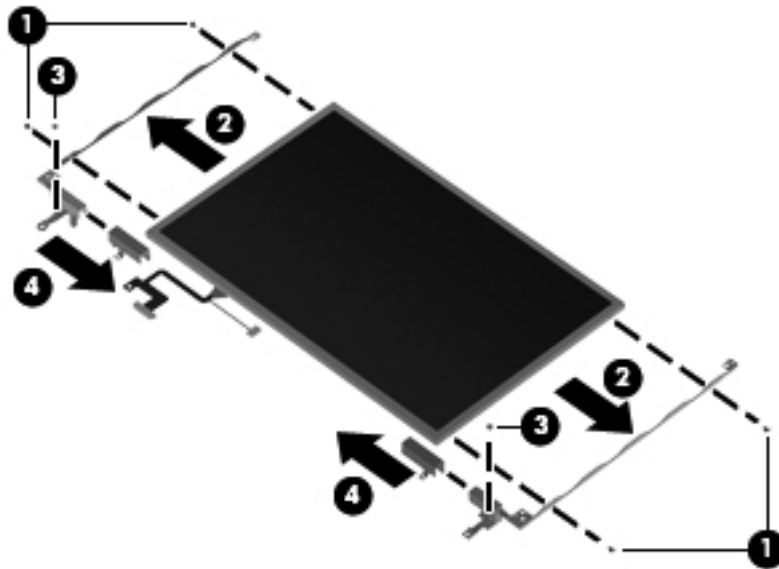

- k. Disconnect the webcam module cable (1) from the passthrough board.
- l. Release the webcam module (2) from the clip built into the display enclosure. The webcam module is available using spare part number 598772-001.

- m. Route the webcam module cable (3) through the slot built into the display enclosure.

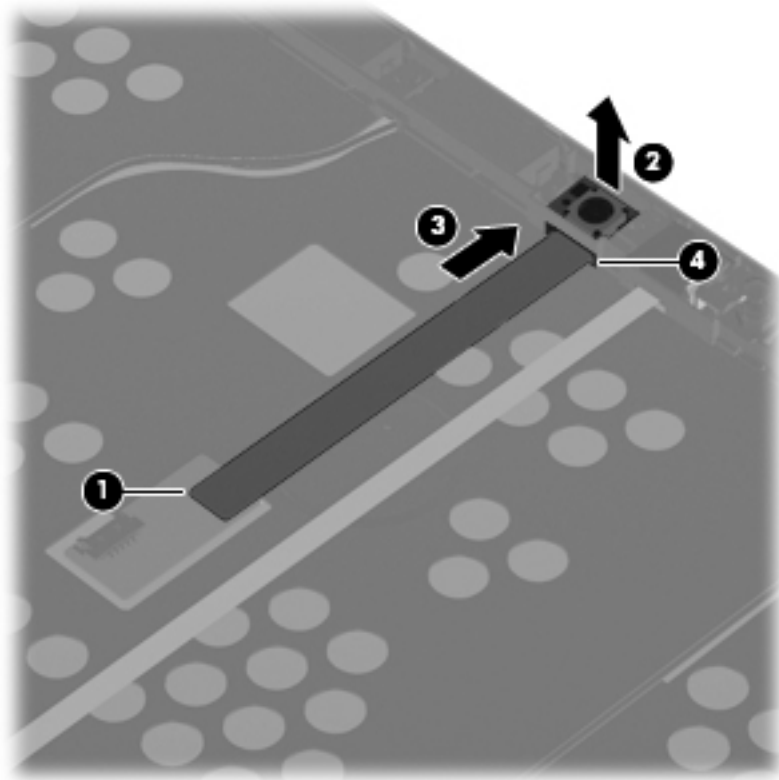

Reverse this procedure to reassemble and install the display assembly.

Top cover

 **NOTE:** The top cover spare part kit includes the TouchPad board and cable, TouchPad button board and cable, and TouchPad bracket.

Description	Spare part number
For use only on computer models equipped with a fingerprint reader (includes fingerprint reader and cable)	598801-001
For use only on computer models not equipped with a fingerprint reader	598802-001

Before removing the top cover, follow these steps:

1. Shut down the computer. If you are unsure whether the computer is off or in Hibernation, turn the computer on, and then shut it down through the operating system.
2. Disconnect all external devices connected to the computer.
3. Disconnect the power from the computer by first unplugging the power cord from the AC outlet and then unplugging the AC adapter from the computer.
4. Remove the battery (see [Battery on page 44](#)), and then remove the following components:
 - a. Memory module compartment cover (see [Expansion memory module on page 48](#))
 - b. Wireless module compartment cover (see [WLAN module on page 53](#))
 - c. Switch cover and keyboard (see [Switch cover and keyboard on page 65](#))
 - d. Display assembly (see [Display assembly on page 72](#))

Remove the top cover:

1. Turn the computer upside down, with the front toward you.
2. Remove the four rubber screw covers (1) on the front edge of the base enclosure.
3. Remove the two rubber screw covers (2) in the rear corners of the base enclosure.

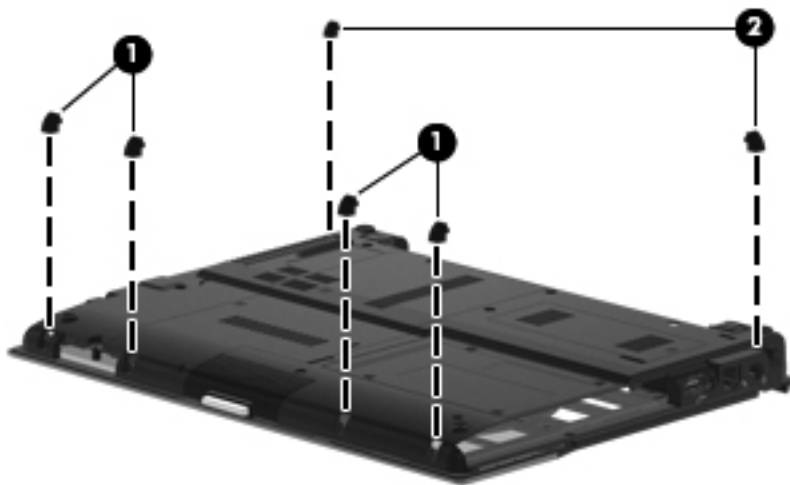

4. Remove the following screws:
 - (1) Four Torx T8M2.5×5.0 screws
 - (2) Three Torx T8M2.5×6.0 screws
 - (3) One Torx T8M2.0×5.0 screw.
 - (4) One Torx T8M2.0×4.0 screw.

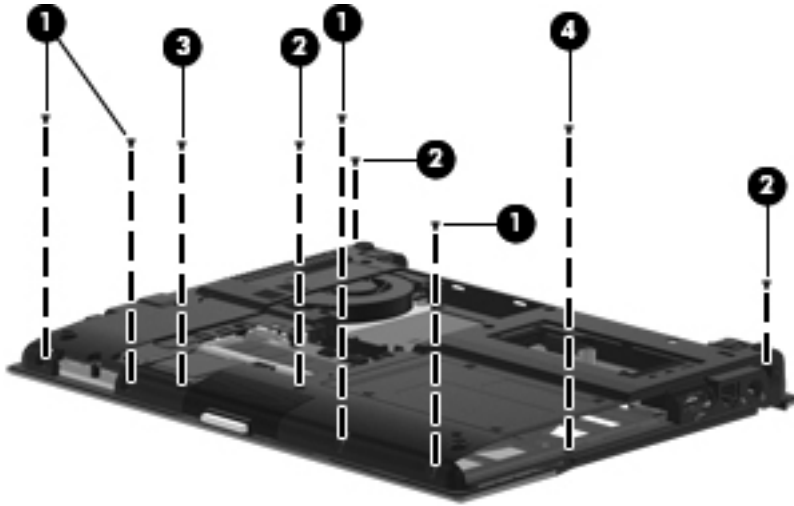

5. Turn the computer right-side up, with the front toward you.
6. Release the ZIF connector to which the card reader board cable is attached, and then disconnect the card reader board cable (1) from the system board.
7. Release the ZIF connector to which the TouchPad cable is attached, and then disconnect the TouchPad cable (2) from the system board.

8. Release the ZIF connector to which the fingerprint reader board cable is attached, and then disconnect the fingerprint reader board cable (3) from the system board.

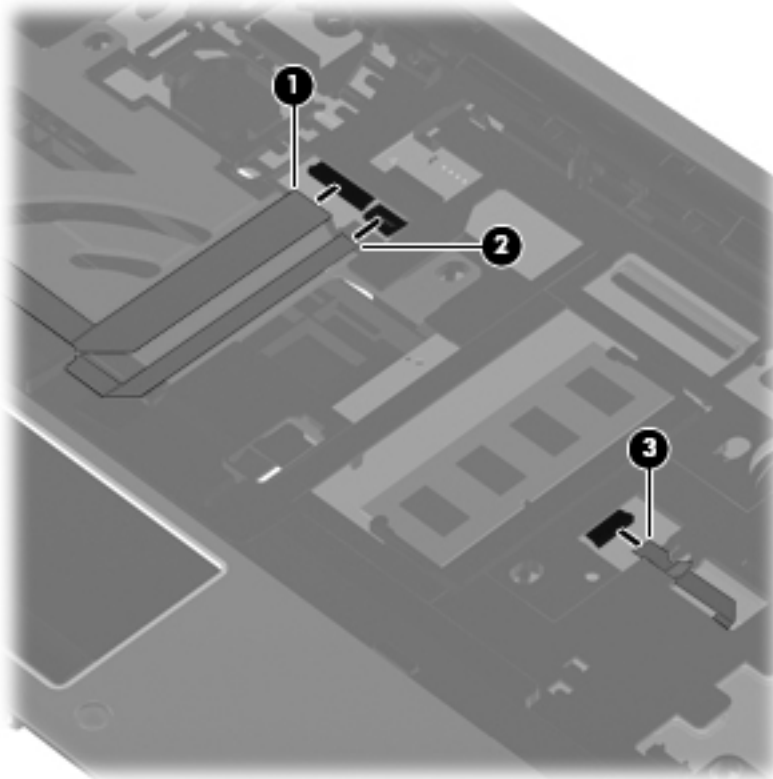

9. Lift the rear edge of the top cover (1), and then swing it up and forward until it rests at an angle.
10. Lift the front edge of the top cover (2) until it disengages from the base enclosure.

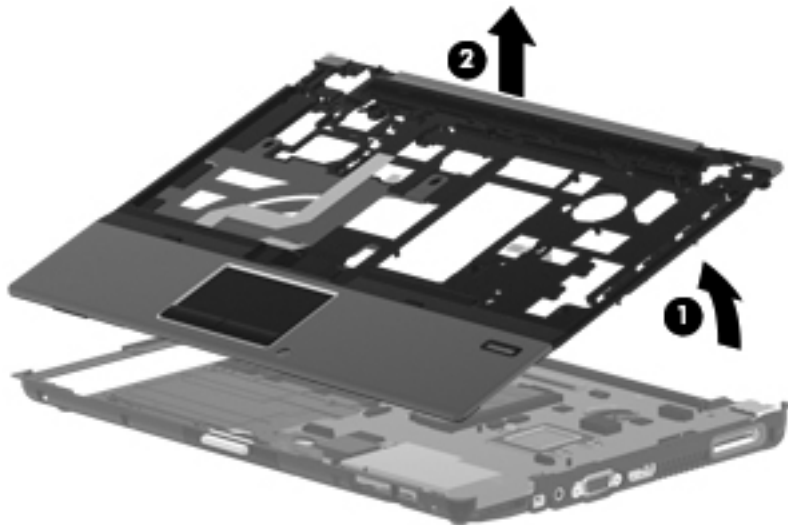

11. Remove the top cover.

Reverse this procedure to install the top cover.

Card reader board

Description	Spare part number
Card reader board (includes cable)	598768-001
Card reader board bracket	598767-001

Before removing the card reader board and bracket, follow these steps:

1. Shut down the computer. If you are unsure whether the computer is off or in Hibernation, turn the computer on, and then shut it down through the operating system.
2. Disconnect all external devices connected to the computer.
3. Disconnect the power from the computer by first unplugging the power cord from the AC outlet and then unplugging the AC adapter from the computer.
4. Remove the battery (see [Battery on page 44](#)), and then remove the following components:
 - a. Memory module compartment cover (see [Expansion memory module on page 48](#))
 - b. Wireless module compartment cover (see [WLAN module on page 53](#))
 - c. Switch cover and keyboard (see [Switch cover and keyboard on page 65](#))
 - d. Display assembly (see [Display assembly on page 72](#))
 - e. Top cover (see [Top cover on page 81](#))

Remove the card reader board and bracket:

1. Detach the card reader board cable (1) from the surface of the top cover (2). (The card reader board cable is attached to the top cover by double-sided tape.)

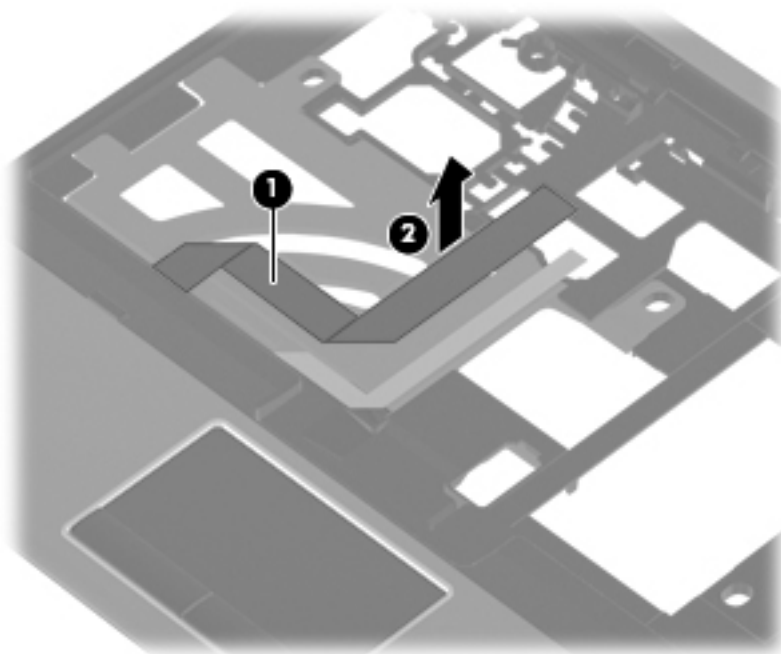

2. Turn the top cover upside down, with the front toward you.

3. Remove the two Phillips PM2.0×2.0 broad head screws **(1)** and the Phillips PM2.0×5.0 screw **(2)** that secure the card reader board bracket to the top cover.
4. Lift the front edge of the card reader board bracket **(3)** until it rests at an angle.
5. Remove the card reader board bracket **(4)** by sliding it up and forward at an angle.

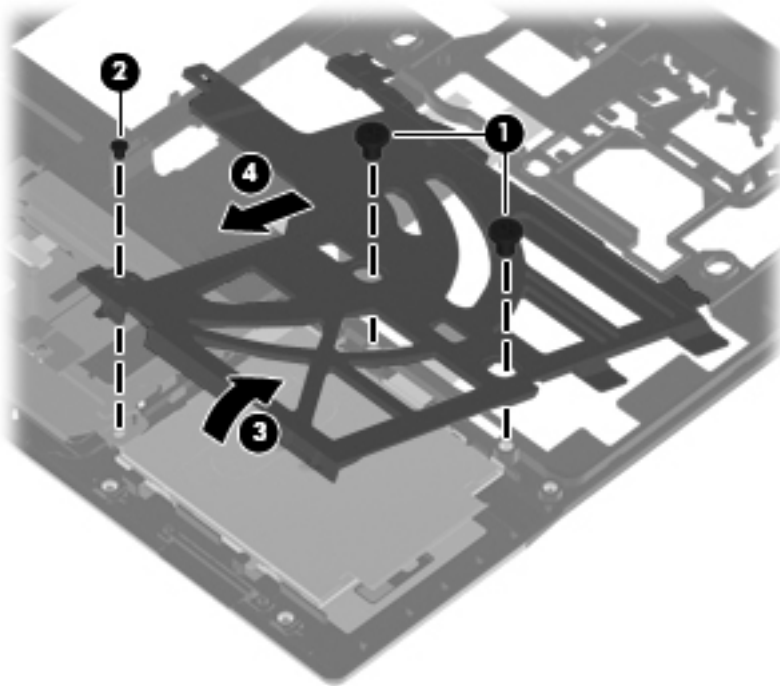

6. Slide the card reader board **(1)** to the right until the tabs on the card reader board disengage from the slots on the top cover.

7. Remove the card reader board (2) and cable.

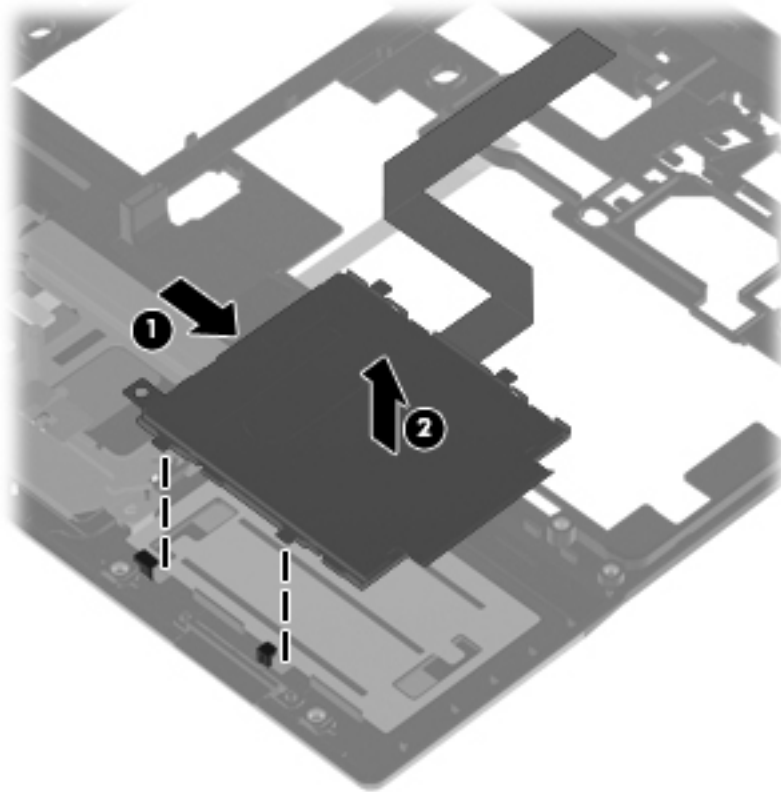

Reverse this procedure to install the card reader board, cable, and bracket.

Speaker

Description	Spare part number
Speaker	598799-001

Before removing the speaker, follow these steps:

1. Shut down the computer. If you are unsure whether the computer is off or in Hibernation, turn the computer on, and then shut it down through the operating system.
2. Disconnect all external devices connected to the computer.
3. Disconnect the power from the computer by first unplugging the power cord from the AC outlet and then unplugging the AC adapter from the computer.
4. Remove the battery (see [Battery on page 44](#)), and then remove the following components:
 - a. Memory module compartment cover (see [Expansion memory module on page 48](#))
 - b. Wireless module compartment cover (see [WLAN module on page 53](#))
 - c. Switch cover and keyboard (see [Switch cover and keyboard on page 65](#))
 - d. Display assembly (see [Display assembly on page 72](#))
 - e. Top cover (see [Top cover on page 81](#))

Remove the speaker:

1. Disconnect the speaker cable (1) from the system board.
2. Remove the Phillips PM2.0×4.0 screw (2) and the Phillips PM2.0×6.0 screw (3) that secure the speaker to the base enclosure.
3. Remove the speaker (4) from the base enclosure.

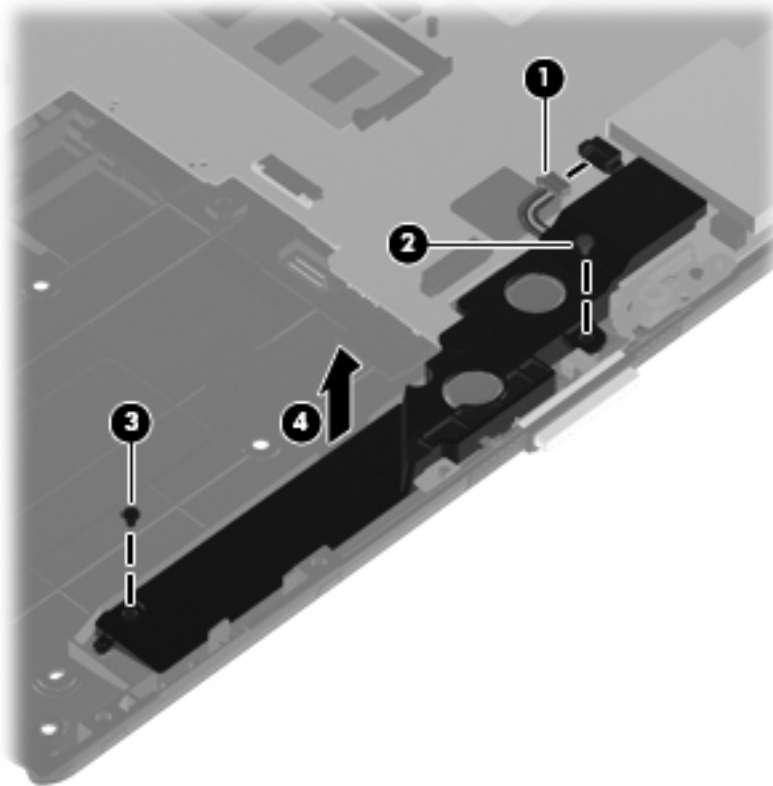

Reverse this procedure to install the speaker.

Bluetooth module cable

 **NOTE:** The Bluetooth module cable is included in the Cable Kit, spare part number 598766-001.

Before removing the Bluetooth module cable, follow these steps:

1. Shut down the computer. If you are unsure whether the computer is off or in Hibernation, turn the computer on, and then shut it down through the operating system.
2. Disconnect all external devices connected to the computer.
3. Disconnect the power from the computer by first unplugging the power cord from the AC outlet and then unplugging the AC adapter from the computer.
4. Remove the battery (see [Battery on page 44](#)), and then remove the following components:
 - a. Memory module compartment cover (see [Expansion memory module on page 48](#))
 - b. Wireless module compartment cover (see [WLAN module on page 53](#))
 - c. Switch cover and keyboard (see [Switch cover and keyboard on page 65](#))

- d. Display assembly (see [Display assembly on page 72](#))
- e. Top cover (see [Top cover on page 81](#))

Remove the Bluetooth module cable:

1. Release the Bluetooth module cable (1) from the opening in the base enclosure.
2. Disconnect the Bluetooth module cable (2) from the system board.

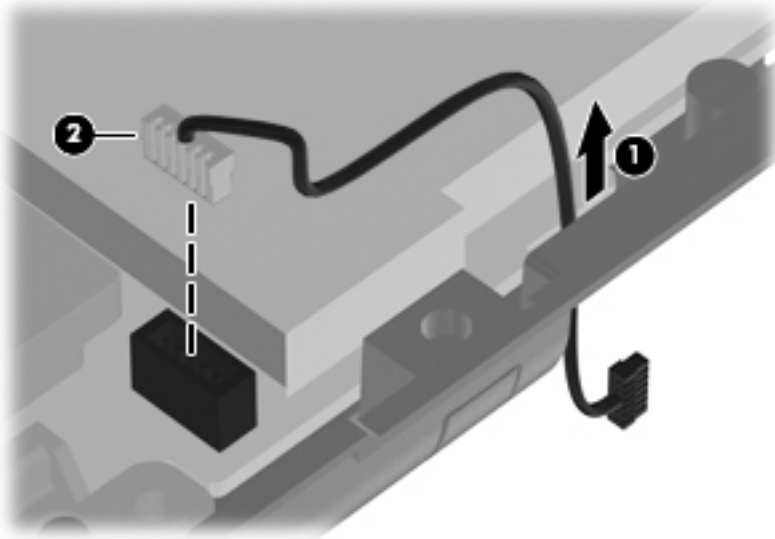

3. Remove the Bluetooth module cable.

Reverse this procedure to install the Bluetooth module cable.

System board



NOTE: The system board spare part kit includes the processor, replacement thermal material, and a replacement thermal material cleaning kit.

Description	Spare part number
System boards equipped with a standard-voltage (35-W) processor:	
Equipped with an Intel Core i7-620M 2.66-GHz processor for use in all countries and regions except the People's Republic of China and Russia	598765-001
Equipped with an Intel Core i7-620M 2.66-GHz processor for use only in the People's Republic of China and Russia	614968-001
Equipped with an Intel Core i5-540M 2.53-GHz processor for use in all countries and regions except the People's Republic of China and Russia	598764-001
Equipped with an Intel Core i5-540M 2.53-GHz processor for use only in the People's Republic of China and Russia	614967-001
Equipped with an Intel Core i5-520M 2.40-GHz processor for use in all countries and regions except the People's Republic of China and Russia	598763-001
Equipped with an Intel Core i5-520M 2.40-GHz processor for use only in the People's Republic of China and Russia	614966-001
System boards equipped with a low-voltage (25-W) processor:	
Equipped with an Intel Core i7-640M 2.13-GHz processor for use in all countries and regions except the People's Republic of China and Russia	598762-001
Equipped with an Intel Core i7-640M 2.13-GHz processor for use only in the People's Republic of China and Russia	614965-001

Before removing the system board, follow these steps:

1. Shut down the computer. If you are unsure whether the computer is off or in Hibernation, turn the computer on, and then shut it down through the operating system.
2. Disconnect all external devices connected to the computer.
3. Disconnect the power from the computer by first unplugging the power cord from the AC outlet and then unplugging the AC adapter from the computer.
4. Remove the battery (see [Battery on page 44](#)), and then remove the following components:
 - a. Bluetooth module (see [Bluetooth module on page 46](#))
 - b. Low-voltage hard drive (see [Low-voltage hard drive or solid-state drive on page 50](#))
 - c. Memory module compartment cover (see [Expansion memory module on page 48](#))
 - d. Wireless module compartment cover (see [WLAN module on page 53](#))
 - e. Optical drive (see [Optical drive on page 59](#)) or standard-voltage hard drive (see [Standard-voltage hard drive or solid-state drive on page 61](#))
 - f. Switch cover and keyboard (see [Switch cover and keyboard on page 65](#))
 - g. Display assembly (see [Display assembly on page 72](#))

- h. Top cover (see [Top cover on page 81](#))
- i. Speaker (see [Speaker on page 86](#))

When replacing the system board, be sure that the following components are removed from the defective system board and installed on the replacement system board:

- SIM (see [SIM on page 45](#))
- Memory modules (see [Expansion memory module on page 48](#) and [Primary memory module on page 70](#))
- WLAN module (see [WLAN module on page 53](#))
- WWAN module (see [WWAN module on page 57](#))
- RTC battery (see [RTC battery on page 69](#))
- Bluetooth module cable (see [Bluetooth module cable on page 87](#))
- Modem module (see [Modem module on page 92](#))
- Fan/heat sink assembly (see [Fan/heat sink assembly on page 93](#))

Remove the system board:

1. Release the ZIF connector to which the LED board cable is attached, and then disconnect the LED board cable **(1)** from the system board.
2. Remove the Torx8 T8M2.5×5.0 screw **(2)** that secures the system board to the base enclosure.

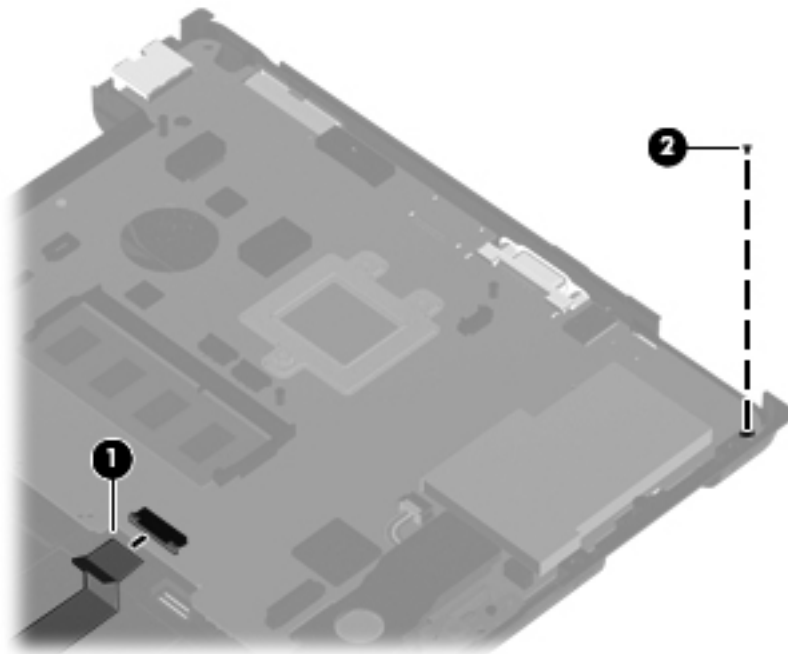

3. Flex the left side of the base enclosure **(1)** until the RJ-11 jack and USB ports are clear of the openings in the base enclosure.
4. Use the optical drive connector **(2)** to lift the left side of the system board **(3)** until it rests at an angle.

5. Remove the system board (4) from the base enclosure by sliding it up and to the left.

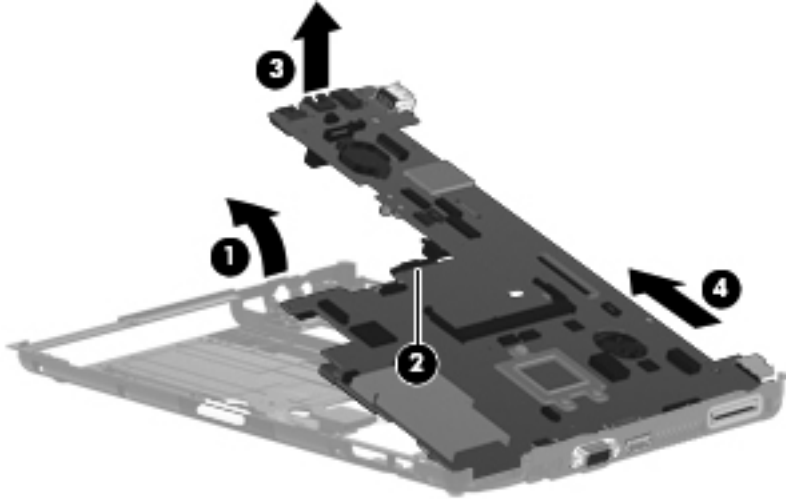

Reverse this procedure to install the system board.

Modem module



NOTE: The modem module spare part kit does not include a modem module cable. The modem module cable is included in the Cable Kit, spare part number 598766-001.

Description	Spare part number
For use in all countries and regions except Australia and New Zealand	510099-001
For use only in Australia and New Zealand	510099-011

Before removing the modem module, follow these steps:

1. Shut down the computer. If you are unsure whether the computer is off or in Hibernation, turn the computer on, and then shut it down through the operating system.
2. Disconnect all external devices connected to the computer.
3. Disconnect the power from the computer by first unplugging the power cord from the AC outlet and then unplugging the AC adapter from the computer.
4. Remove the battery (see [Battery on page 44](#)), and then remove the following components:
 - a. Memory module compartment cover (see [Expansion memory module on page 48](#))
 - b. Wireless module compartment cover (see [WLAN module on page 53](#))
 - c. Switch cover and keyboard (see [Switch cover and keyboard on page 65](#))
 - d. Display assembly (see [Display assembly on page 72](#))
 - e. Top cover (see [Top cover on page 81](#))
 - f. System board (see [System board on page 89](#))

Remove the modem module:

1. Remove the two Phillips PM2.0×4.0 screws **(1)** that secure the modem module to the system board.
2. Lift the modem module **(2)** straight up to disconnect it from the system board.

3. Disconnect the modem module cable (3) from the modem module.

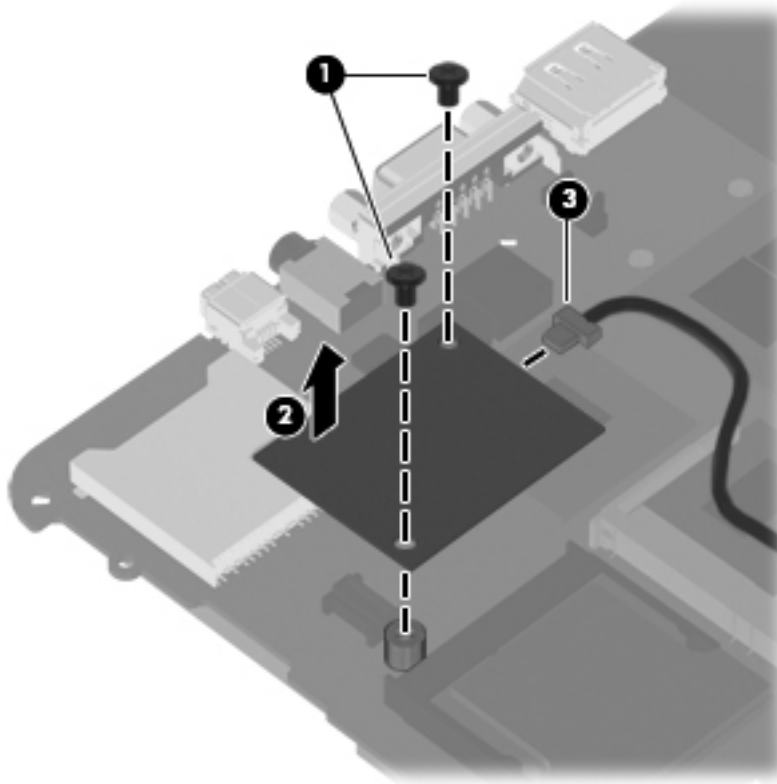

4. Remove the modem module.

Reverse this procedure to install the modem module.

Fan/heat sink assembly

Description	Spare part number
For use only on computer models equipped with a standard-voltage (35-W) processor	598789-001
For use only on computer models equipped with a low-voltage (25-W) processor	598788-001

Before removing the fan/heat sink assembly, follow these steps:

1. Shut down the computer. If you are unsure whether the computer is off or in Hibernation, turn the computer on, and then shut it down through the operating system.
2. Disconnect all external devices connected to the computer.
3. Disconnect the power from the computer by first unplugging the power cord from the AC outlet and then unplugging the AC adapter from the computer.
4. Remove the battery (see [Battery on page 44](#)), and then remove the following components:
5. Remove the following components:
 - a. Memory module compartment cover (see [Expansion memory module on page 48](#))
 - b. Wireless module compartment cover (see [WLAN module on page 53](#))

- c. Switch cover and keyboard (see [Switch cover and keyboard on page 65](#))
- d. Display assembly (see [Display assembly on page 72](#))
- e. Top cover (see [Top cover on page 81](#))
- f. System board (see [System board on page 89](#))

Remove the fan/heat sink assembly:

1. Turn the system board upside down, with the front toward you.
2. Disconnect the fan cable (1) from the system board.
3. Remove the Torx T8M2.0×5.0 screw (2) that secures the fan/heat sink assembly to the system board.
4. Following the 1, 2, 3, 4 sequence stamped into the fan/heat sink assembly, loosen the four captive screws (3) that secure the fan/heat sink assembly to the system board.
5. Remove the fan/heat sink assembly (4).

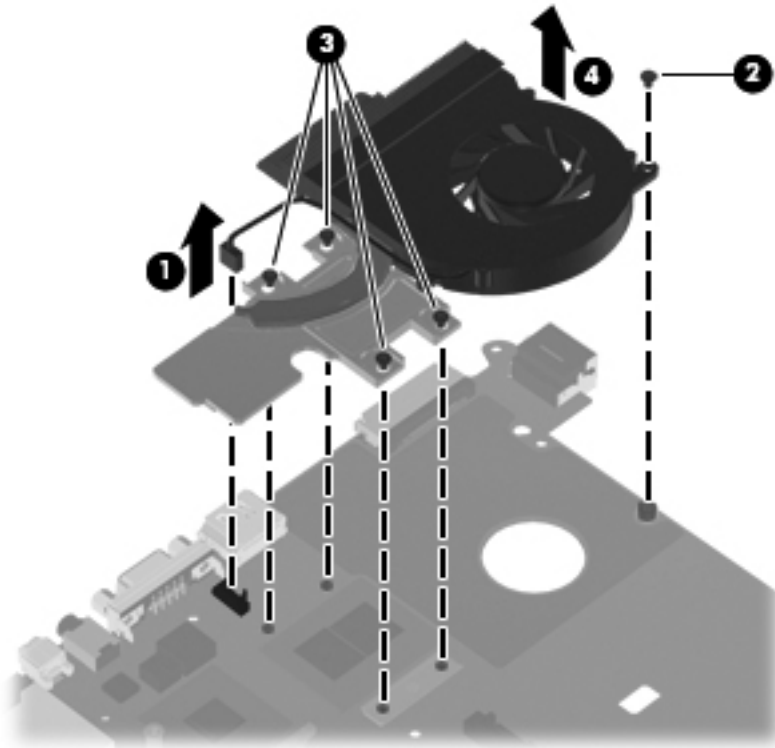

 **NOTE:** The thermal material must be thoroughly cleaned from the surfaces of the fan/heat sink assembly and system board each time the fan/heat sink assembly is removed. Thermal paste is located on the processor/Northbridge component (1) and the fan/heat sink assembly section that services it (2). A thermal pad is used on the graphics subsystem component (3) and the fan/heat sink assembly section that services it (4). Replacement thermal material is included with all fan/heat sink assembly and system board spare part kits.

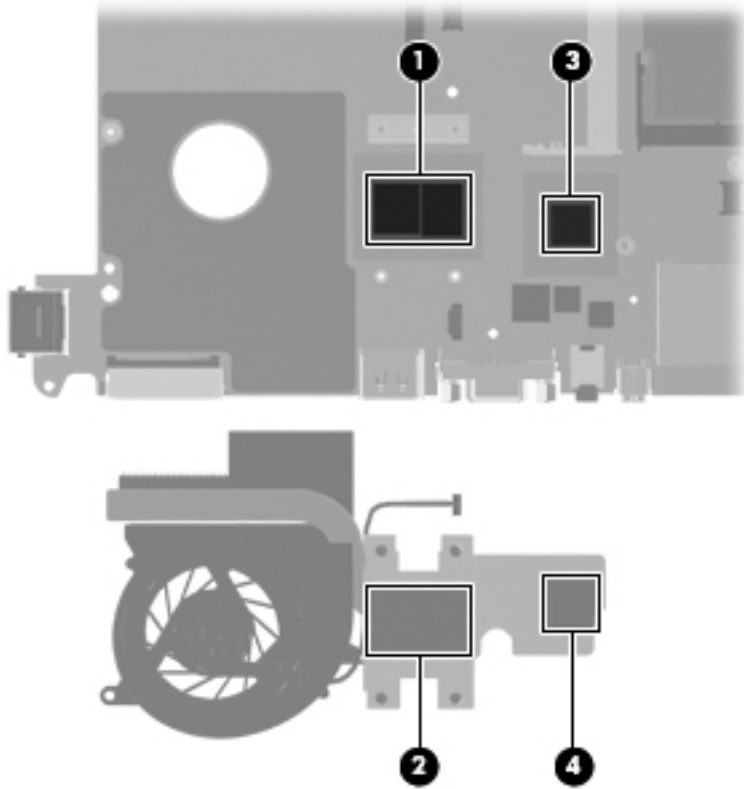

Reverse this procedure to install the fan/heat sink assembly.

5 Computer Setup

Windows 7

Starting Computer Setup

Computer Setup is a preinstalled, ROM-based utility that can be used even when the operating system is not working or will not load.

 **NOTE:** Some of the Computer Setup menu items listed in this guide may not be supported by your computer.

NOTE: An external keyboard or mouse connected to a USB port can be used with Computer Setup only if USB legacy support is enabled.

To start Computer Setup, follow these steps:

1. Turn on or restart the computer, and then press **esc** while the “Press the ESC key for Startup Menu” message is displayed at the bottom of the screen.
2. Press **f10** to enter BIOS Setup.

Using Computer Setup

Navigating and selecting in Computer Setup

The information and settings in Computer Setup are accessed from the File, Security, Diagnostics, and System Configuration menus.

To navigate and select in Computer Setup, follow these steps:

1. Turn on or restart the computer, and then press **esc** while the “Press the ESC key for Startup Menu” message is displayed at the bottom of the screen.
 - To select a menu or a menu item, use the **tab** key and the keyboard arrow keys and then press **enter**, or use a pointing device to click the item.
 - To scroll up and down, click the up arrow or the down arrow in the upper-right corner of the screen, or use the up arrow key or the down arrow key.
 - To close open dialog boxes and return to the main Computer Setup screen, press **esc**, and then follow the on-screen instructions.

 **NOTE:** You can use either a pointing device (TouchPad, pointing stick, or USB mouse) or the keyboard to navigate and make selections in Computer Setup.

2. Press **f10** to enter BIOS Setup.
3. Select the **File**, **Security**, or **System Configuration** menu.

To exit Computer Setup menus, choose one of the following methods:

- To exit Computer Setup menus without saving your changes, click the **Exit** icon in the lower-left corner of the screen, and then follow the on-screen instructions.

– or –

Use the **tab** key and the arrow keys to select **File > Ignore changes and exit**, and then press **enter**.

– or –

- To save your changes and exit Computer Setup menus, click the **Save** icon in the lower-left corner of the screen, and then follow the on-screen instructions.

– or –

Use the **tab** key and the arrow keys to select **File > Save changes and exit**, and then press **enter**.

Your changes go into effect when the computer restarts.

Restoring factory settings in Computer Setup

 **NOTE:** Restoring defaults will not change the hard drive mode.

To return all settings in Computer Setup to the values that were set at the factory, follow these steps:

1. Turn on or restart the computer, and then press **esc** while the “Press the ESC key for Startup Menu” message is displayed at the bottom of the screen.
2. Press **f10** to enter BIOS Setup.
3. Use a pointing device or the arrow keys to select **File > Restore defaults**.
4. Follow the on-screen instructions.
5. To save your changes and exit, click the **Save** icon in the lower-right corner of the screen, and then follow the on-screen instructions.

– or –

Use the arrow keys to select **File > Save changes and exit**, and then press **enter**.

Your changes go into effect when the computer restarts.

 **NOTE:** Your password settings and security settings are not changed when you restore the factory settings.

Computer Setup menus

The menu tables in this section provide an overview of Computer Setup options.



NOTE: Some of the Computer Setup menu items listed in this chapter may not be supported by your computer.

File menu

Select	To do this
System Information	<ul style="list-style-type: none">• View identification information for the computer and the batteries in the system.• View specification information for the processor, cache and memory size, system ROM, video revision, and keyboard controller version.
Set System Date and Time	Set or change the date and time on the computer.
System Diagnostics	Displays the following information: <ul style="list-style-type: none">• System Information<ul style="list-style-type: none">◦ Identification information for the computer and the batteries in the system.◦ Specification information for the processor, cache and memory size, system ROM, video revision, and keyboard controller version.• Start-up Test—Verifies the system components needed for starting the computer.• Run-In Test—Runs a comprehensive check on system memory.• Hard Disk Test—Runs a comprehensive self-test on any hard drive in the system.• Memory Test—Runs a comprehensive test on any memory installed in the computer.• Battery Test—Runs a comprehensive test on any batteries installed in the computer.• Error Log—Displays a log file if any errors have occurred.
Restore defaults	Replace the configuration settings in Computer Setup with the original factory settings. (Hard drive mode, password settings, and security settings are not changed when you restore the factory settings.)
Reset BIOS security to factory default	Restore the BIOS security settings to the factory default.
Ignore changes and exit	Cancel any changes entered during the current session. Then exit and restart the computer.
Save changes and exit	Save any changes entered during the current session. Then exit and restart the computer. Your changes go into effect when the computer restarts.

Security menu



NOTE: Some of the menu items listed in this section may not be supported by your computer.

Select	To do this
Administrator Tools	
Setup BIOS Administrator Password	Set up a BIOS administrator password
User Management (requires a BIOS administrator password)	
Create New BIOS User Account	<ul style="list-style-type: none">Select from a list of BIOS users.Select from a list of ProtectTools users.
Password Policy (requires a BIOS administrator password)	Revise password policy criteria.
HP SpareKey	Enable/disable HP SpareKey (enabled by default).
Always Prompt for HP SpareKey Enrollment	Enable/disable HP SpareKey enrollment (enabled by default).
Fingerprint Reset on Reboot (If Present)	Reset/clear the fingerprint reader ownership (select models only; disabled by default).
User Tools	
Change Password	Enter, change, or delete a BIOS administrator password.
HP SpareKey Enrollment	Enroll or reset HP SpareKey, which is a set of security questions and answers used if you forget your password.
Anti Theft	
AT-P	Enable/disable Anti-Theft Protection.
DriveLock Passwords	<ul style="list-style-type: none">Enable/disable DriveLock on any computer hard drive (enabled by default).Change a DriveLock user password or master password. <p>NOTE: DriveLock settings are accessible only when you enter Computer Setup by turning on (not restarting) the computer.</p>
Automatic DriveLock	Enable/disable Automatic DriveLock support.
TPM Embedded Security	Enable/disable support for Trusted Platform Module (TPM) Embedded Security, which protects the computer from unauthorized access to owner functions available in Embedded Security for ProtectTools. For more information, refer to the ProtectTools software
	<p>NOTE: You must have a setup password to change this setting.</p>
Disk Sanitizer	Run Disk Sanitizer to destroy all existing data on the low-voltage hard drive or the standard-voltage hard drive in the Upgrade bay.
	<p>CAUTION: If you run Disk Sanitizer, the data on the selected drive is destroyed permanently.</p>
System IDs	Enter a user-defined computer asset tracking number and ownership tag.

System Configuration menu



NOTE: Some of the menu items listed in this section may not be supported by your computer.

Select	To do this
Language	Change the Computer Setup language.
Boot Options	<ul style="list-style-type: none">• Set a Startup Menu delay (in seconds).• Set the MultiBoot Express Boot Popup delay in seconds.• Enable/disable Custom Logo (disabled by default).• Enable/disable Display Diagnostic URL (enabled by default).• Enable/disable CD-ROM boot (disabled by default).• Enable/disable SD Card boot (enabled by default).• Enable/disable floppy boot (enabled by default).• Enable/disable PXE Internal NIC boot (enabled by default).• Enable/disable Unified Extensible Firmware Interface (UEFI) Boot Mode (disabled by default).• Set the Legacy Boot Order.
Device Configurations	<ul style="list-style-type: none">• Enable/disable USB legacy support (enabled by default). When enabled, USB legacy support allows the following:<ul style="list-style-type: none">◦ Use of a USB keyboard in Computer Setup even when a Windows operating system is not running◦ Startup from bootable USB devices, including a hard drive, diskette drive, or optical drive connected by a USB port to the computer• Select a parallel port mode: ECP (Enhanced Capabilities Port), standard, bidirectional, or EPP (Enhanced Parallel Port).• Enable/disable fan always on while connected to an AC outlet (enabled by default).• Enable/disable Data Execution Prevention (select models only). When enabled, the processor can disable some virus code execution, which helps to improve computer security (disabled by default).• SATA (Serial Advanced Technology Attachment) device mode. The following options are available:<ul style="list-style-type: none">◦ AHCI (Advanced Host Controller Interface)◦ IDE (Integrated Drive Electronics)◦ RAID (select models only)

Select	To do this
Device Configurations (<i>continued</i>)	<p data-bbox="879 226 1417 275">NOTE: Availability of these options varies by computer model.</p> <ul data-bbox="879 296 1461 926" style="list-style-type: none"><li data-bbox="879 296 1461 344">• Enable/disable secondary battery fast charge (enabled by default).<li data-bbox="879 365 1417 386">• Enable/disable HP QuickLook (enabled by default).<li data-bbox="879 407 1358 455">• Enable/disable Preboot Authentication on HP QuickLook Boot (enabled by default).<li data-bbox="879 476 1417 497">• Enable/disable HP QuickWeb (enabled by default).<li data-bbox="879 518 1461 567">• Enable/disable HP QuickWeb Write Protect (disabled by default).<li data-bbox="879 588 1461 636">• Enable/disable Virtualization Technology (select models only; disabled by default).<li data-bbox="879 657 1442 705">• Enable/disable TXT (Intel Trusted Execution Technology) (select models only; disabled by default).<li data-bbox="879 726 1278 747">• Multi Core CPU (enabled by default).<li data-bbox="879 768 1321 789">• Intel HT Technology (enabled by default).<li data-bbox="879 810 1417 831">• Enable/disable Wake on USB (enabled by default).<li data-bbox="879 852 1417 900">• Enable/disable Num lock state at boot (disabled by default).

Select	To do this
Built-In Device Options	<ul style="list-style-type: none"> • Enable/disable the wireless button state (enabled by default). • Enable/disable embedded WLAN device radio (select models only; enabled by default). • Enable/disable the embedded Bluetooth device radio (enabled by default). • Enable/disable the Network Interface Controller (LAN) (enabled by default). • Enable/disable LAN/WLAN switching (disabled by default). • Set the wake on LAN state. Options include the following: <ul style="list-style-type: none"> ◦ Disabled ◦ Boot to Network ◦ Follow Boot Order • Enable/disable the Ambient Light Sensor. • Enable/disable the Notebook Upgrade bay device (enabled by default). • Enable/disable the fingerprint device (enabled by default). • Enable/disable the integrated camera (enabled by default). • Enable/disable the Power Monitor Circuit (enabled by default). • Enable/disable the audio device (enabled by default). • Enable/disable a modem device (enabled by default). • Enable/disable the microphone (enabled by default). • Enable/disable the internal speakers (enabled by default).
Port Options	<p>NOTE: NOTE: All port options are enabled by default.</p> <ul style="list-style-type: none"> • Enable/disable the serial port. • Enable/disable the parallel port. • Enable/disable the flash media reader. • Enable/disable the USB port. <p>CAUTION: Disabling the USB port also disables MultiBay devices and ExpressCard devices on the advanced port replicator.</p> • Enable/disable the 1394 port. • Enable/disable the ExpressCard slot. • Enable/disable the Smart Card slot. • Enable/disable the eSATA port.

Select	To do this
AMT Options	<ul style="list-style-type: none"> • Enable/disable Firmware Verbosity. • Enable/disable AMT Setup Prompt (Ctrl-P). • Enable/disable USB Key Provisioning Support. • Enable/disable Unconfigure AMT on next boot. • Select Terminal Emulation Mode. <ul style="list-style-type: none"> ◦ ANSI ◦ VT100 • Enable/disable Firmware Progress Event Support. • Enable/disable Initiate Intel CIRA.
Set Security Level	Change, view, or hide security levels for all BIOS menu items.
Restore Security Defaults	Restore the default security settings.

Windows Vista

Starting Computer Setup

Computer Setup is a preinstalled, ROM-based utility that can be used even when the operating system is not working or will not load.

 **NOTE:** Some of the Computer Setup menu items listed in this guide may not be supported by your computer.

NOTE: An external keyboard or mouse connected to a USB port can be used with Computer Setup only if USB legacy support is enabled.

To start Computer Setup, follow these steps:

1. Turn on or restart the computer, and then press **esc** while the “Press the ESC key for Startup Menu” message is displayed at the bottom of the screen.
2. Press **f10** to enter BIOS Setup.

Using Computer Setup

Navigating and selecting in Computer Setup

The information and settings in Computer Setup are accessed from the File, Security, Diagnostics, and System Configuration menus.

To navigate and select in Computer Setup, follow these steps:

1. Turn on or restart the computer, and then press **esc** while the “Press the ESC key for Startup Menu” message is displayed at the bottom of the screen.
 - To select a menu or a menu item, use the **tab** key and the keyboard arrow keys and then press **enter**, or use a pointing device to click the item.
 - To scroll up and down, click the up arrow or the down arrow in the upper-right corner of the screen, or use the up arrow key or the down arrow key.
 - To close open dialog boxes and return to the main Computer Setup screen, press **esc**, and then follow the on-screen instructions.



NOTE: You can use either a pointing device (TouchPad, pointing stick, or USB mouse) or the keyboard to navigate and make selections in Computer Setup.

2. Press **f10** to enter BIOS Setup.
3. Select the **File**, **Security**, or **System Configuration** menu.

Restoring factory settings in Computer Setup

 **NOTE:** Restoring defaults will not change the hard drive mode.

To return all settings in Computer Setup to the values that were set at the factory, follow these steps:

1. Turn on or restart the computer, and then press **esc** while the “Press the ESC key for Startup Menu” message is displayed at the bottom of the screen.
2. Press **f10** to enter BIOS Setup.
3. Use a pointing device or the arrow keys to select **File > Restore defaults**.
4. Follow the on-screen instructions.
5. To save your changes and exit, click the **Save** icon in the lower-right corner of the screen, and then follow the on-screen instructions.

– or –

Use the arrow keys to select **File > Save changes and exit**, and then press **enter**.

Your changes go into effect when the computer restarts.

 **NOTE:** Your password settings and security settings are not changed when you restore the factory settings.

Computer Setup menus

The menu tables in this section provide an overview of Computer Setup options.



NOTE: Some of the Computer Setup menu items listed in this chapter may not be supported by your computer.

File menu

Select	To do this
System Information	<ul style="list-style-type: none">• View identification information for the computer and the batteries in the system.• View specification information for the processor, cache and memory size, system ROM, video revision, and keyboard controller version.
Set System Date and Time	Set or change the date and time on the computer.
System Diagnostics	Displays the following information: <ul style="list-style-type: none">• System Information<ul style="list-style-type: none">◦ Identification information for the computer and the batteries in the system.◦ Specification information for the processor, cache and memory size, system ROM, video revision, and keyboard controller version.• Start-up Test—Verifies the system components needed for starting the computer.• Run-In Test—Runs a comprehensive check on system memory.• Hard Disk Test—Runs a comprehensive self-test on any hard drive in the system.• Memory Test—Runs a comprehensive test on any memory installed in the computer.• Battery Test—Runs a comprehensive test on any batteries installed in the computer.• Error Log—Displays a log file if any errors have occurred.
Restore defaults	Replace the configuration settings in Computer Setup with the original factory settings. (Hard drive mode, password settings, and security settings are not changed when you restore the factory settings.)
Reset BIOS security to factory default	Restore the BIOS security settings to the factory default.
Ignore changes and exit	Cancel any changes entered during the current session. Then exit and restart the computer.
Save changes and exit	Save any changes entered during the current session. Then exit and restart the computer. Your changes go into effect when the computer restarts.

Security menu



NOTE: Some of the menu items listed in this section may not be supported by your computer.

Select	To do this
Administrator Tools	
Setup BIOS Administrator Password	Set up a BIOS administrator password
User Management (requires a BIOS administrator password)	
Create New BIOS User Account	<ul style="list-style-type: none">• Select from a list of BIOS users.• Select from a list of ProtectTools users.
Password Policy (requires a BIOS administrator password)	Revise password policy criteria.
HP SpareKey	Enable/disable HP SpareKey (enabled by default).
Always Prompt for HP SpareKey Enrollment	Enable/disable HP SpareKey enrollment (enabled by default).
Fingerprint Reset on Reboot (If Present)	Reset/clear the fingerprint reader ownership (select models only; disabled by default).
User Tools	
Change Password	Enter, change, or delete a BIOS administrator password.
HP SpareKey Enrollment	Enroll or reset HP SpareKey, which is a set of security questions and answers used if you forget your password.
Anti Theft	
AT-P	Enable/disable Anti-Theft Protection.
DriveLock Passwords	<ul style="list-style-type: none">• Enable/disable DriveLock on any computer hard drive (enabled by default).• Change a DriveLock user password or master password. <p>NOTE: DriveLock settings are accessible only when you enter Computer Setup by turning on (not restarting) the computer.</p>
Automatic DriveLock	Enable/disable Automatic DriveLock support.
TPM Embedded Security	Enable/disable support for Trusted Platform Module (TPM) Embedded Security, which protects the computer from unauthorized access to owner functions available in Embedded Security for ProtectTools. For more information, refer to the ProtectTools software
	<p>NOTE: You must have a setup password to change this setting.</p>
Disk Sanitizer	Run Disk Sanitizer to destroy all existing data on the low-voltage hard drive or the standard-voltage hard drive in the Upgrade bay.
	<p>CAUTION: If you run Disk Sanitizer, the data on the selected drive is destroyed permanently.</p>
System IDs	Enter a user-defined computer asset tracking number and ownership tag.

System Configuration menu



NOTE: Some of the menu items listed in this section may not be supported by your computer.

Select	To do this
Language	Change the Computer Setup language.
Boot Options	<ul style="list-style-type: none">• Set a Startup Menu delay (in seconds).• Set the MultiBoot Express Boot Popup delay in seconds.• Enable/disable Custom Logo (disabled by default).• Enable/disable Display Diagnostic URL (enabled by default).• Enable/disable CD-ROM boot (disabled by default).• Enable/disable SD Card boot (enabled by default).• Enable/disable floppy boot (enabled by default).• Enable/disable PXE Internal NIC boot (enabled by default).• Enable/disable Unified Extensible Firmware Interface (UEFI) Boot Mode (disabled by default).• Set the Legacy Boot Order.
Device Configurations	<ul style="list-style-type: none">• Enable/disable USB legacy support (enabled by default). When enabled, USB legacy support allows the following:<ul style="list-style-type: none">◦ Use of a USB keyboard in Computer Setup even when a Windows operating system is not running◦ Startup from bootable USB devices, including a hard drive, diskette drive, or optical drive connected by a USB port to the computer• Select a parallel port mode: ECP (Enhanced Capabilities Port), standard, bidirectional, or EPP (Enhanced Parallel Port).• Enable/disable fan always on while connected to an AC outlet (enabled by default).• Enable/disable Data Execution Prevention (select models only). When enabled, the processor can disable some virus code execution, which helps to improve computer security (disabled by default).• SATA (Serial Advanced Technology Attachment) device mode. The following options are available:<ul style="list-style-type: none">◦ AHCI (Advanced Host Controller Interface)◦ IDE (Integrated Drive Electronics)◦ RAID (select models only)

Select	To do this
Device Configurations (<i>continued</i>)	<p data-bbox="879 222 1417 275">NOTE: Availability of these options varies by computer model.</p> <ul data-bbox="879 296 1461 919" style="list-style-type: none"><li data-bbox="879 296 1461 348">• Enable/disable secondary battery fast charge (enabled by default).<li data-bbox="879 369 1417 390">• Enable/disable HP QuickLook (enabled by default).<li data-bbox="879 411 1358 464">• Enable/disable Preboot Authentication on HP QuickLook Boot (enabled by default).<li data-bbox="879 485 1417 506">• Enable/disable HP QuickWeb (enabled by default).<li data-bbox="879 527 1461 579">• Enable/disable HP QuickWeb Write Protect (disabled by default).<li data-bbox="879 600 1461 653">• Enable/disable Virtualization Technology (select models only; disabled by default).<li data-bbox="879 674 1445 726">• Enable/disable TXT (Intel Trusted Execution Technology) (select models only; disabled by default).<li data-bbox="879 747 1278 768">• Multi Core CPU (enabled by default).<li data-bbox="879 789 1326 810">• Intel HT Technology (enabled by default).<li data-bbox="879 831 1417 852">• Enable/disable Wake on USB (enabled by default).<li data-bbox="879 873 1417 919">• Enable/disable Num lock state at boot (disabled by default).

Select	To do this
Built-In Device Options	<ul style="list-style-type: none"> • Enable/disable the wireless button state (enabled by default). • Enable/disable embedded WLAN device radio (select models only; enabled by default). • Enable/disable the embedded Bluetooth device radio (enabled by default). • Enable/disable the Network Interface Controller (LAN) (enabled by default). • Enable/disable LAN/WLAN switching (disabled by default). • Set the wake on LAN state. Options include the following: <ul style="list-style-type: none"> ◦ Disabled ◦ Boot to Network ◦ Follow Boot Order • Enable/disable the Ambient Light Sensor. • Enable/disable the Notebook Upgrade bay device (enabled by default). • Enable/disable the fingerprint device (enabled by default). • Enable/disable the integrated camera (enabled by default). • Enable/disable the Power Monitor Circuit (enabled by default). • Enable/disable the audio device (enabled by default). • Enable/disable a modem device (enabled by default). • Enable/disable the microphone (enabled by default). • Enable/disable the internal speakers (enabled by default).
Port Options	<p>NOTE: NOTE: All port options are enabled by default.</p> <ul style="list-style-type: none"> • Enable/disable the serial port. • Enable/disable the parallel port. • Enable/disable the flash media reader. • Enable/disable the USB port. <p>CAUTION: Disabling the USB port also disables MultiBay devices and ExpressCard devices on the advanced port replicator.</p> • Enable/disable the 1394 port. • Enable/disable the ExpressCard slot. • Enable/disable the Smart Card slot. • Enable/disable the eSATA port.

Select	To do this
AMT Options	<ul style="list-style-type: none">• Enable/disable Firmware Verbosity.• Enable/disable AMT Setup Prompt (Ctrl-P).• Enable/disable USB Key Provisioning Support.• Enable/disable Unconfigure AMT on next boot.• Select Terminal Emulation Mode.<ul style="list-style-type: none">◦ ANSI◦ VT100• Enable/disable Firmware Progress Event Support.• Enable/disable Initiate Intel CIRA.
Set Security Level	Change, view, or hide security levels for all BIOS menu items.
Restore Security Defaults	Restore the default security settings.

Windows XP

Starting Computer Setup

Computer Setup is a preinstalled, ROM-based utility that can be used even when the operating system is not working or will not load.

 **NOTE:** Some of the Computer Setup menu items listed in this guide may not be supported by your computer.

NOTE: An external keyboard or mouse connected to a USB port can be used with Computer Setup only if USB legacy support is enabled.

To start Computer Setup, follow these steps:

1. Turn on or restart the computer, and then press **esc** while the “Press the ESC key for Startup Menu” message is displayed at the bottom of the screen.
2. Press **f10** to enter BIOS Setup.

Using Computer Setup

Navigating and selecting in Computer Setup

The information and settings in Computer Setup are accessed from the File, Security, Diagnostics, and System Configuration menus.

To navigate and select in Computer Setup, follow these steps:

1. Turn on or restart the computer, and then press **esc** while the “Press the ESC key for Startup Menu” message is displayed at the bottom of the screen.
 - To select a menu or a menu item, use the **tab** key and the keyboard arrow keys and then press **enter**, or use a pointing device to click the item.
 - To scroll up and down, click the up arrow or the down arrow in the upper-right corner of the screen, or use the up arrow key or the down arrow key.
 - To close open dialog boxes and return to the main Computer Setup screen, press **esc**, and then follow the on-screen instructions.

 **NOTE:** You can use either a pointing device (TouchPad, pointing stick, or USB mouse) or the keyboard to navigate and make selections in Computer Setup.

2. Press **f10** to enter BIOS Setup.
3. Select the **File**, **Security**, or **System Configuration** menu.

To exit Computer Setup menus, choose one of the following methods:

- To exit Computer Setup menus without saving your changes, click the **Exit** icon in the lower-left corner of the screen, and then follow the on-screen instructions.

– or –

Use the **tab** key and the arrow keys to select **File > Ignore changes and exit**, and then press **enter**.

– or –

- To save your changes and exit Computer Setup menus, click the **Save** icon in the lower-left corner of the screen, and then follow the on-screen instructions.

– or –

Use the tab key and the arrow keys to select **File > Save changes and exit**, and then press [enter](#).

Your changes go into effect when the computer restarts.

Restoring factory settings in Computer Setup



NOTE: Restoring defaults will not change the hard drive mode.

To return all settings in Computer Setup to the values that were set at the factory, follow these steps:

1. Turn on or restart the computer, and then press [esc](#) while the “Press the ESC key for Startup Menu” message is displayed at the bottom of the screen.
2. Press [f10](#) to enter BIOS Setup.
3. Use a pointing device or the arrow keys to select **File > Restore defaults**.
4. Follow the on-screen instructions.
5. To save your changes and exit, click the **Save** icon in the lower-right corner of the screen, and then follow the on-screen instructions.

– or –

Use the arrow keys to select **File > Save changes and exit**, and then press [enter](#).

Your changes go into effect when the computer restarts.



NOTE: Your password settings and security settings are not changed when you restore the factory settings.

Computer Setup menus

The menu tables in this section provide an overview of Computer Setup options.



NOTE: Some of the Computer Setup menu items listed in this chapter may not be supported by your computer.

File menu

Select	To do this
System Information	<ul style="list-style-type: none">• View identification information for the computer and the batteries in the system.• View specification information for the processor, cache and memory size, system ROM, video revision, and keyboard controller version.
Set System Date and Time	Set or change the date and time on the computer.
System Diagnostics	Displays the following information: <ul style="list-style-type: none">• System Information<ul style="list-style-type: none">◦ Identification information for the computer and the batteries in the system.◦ Specification information for the processor, cache and memory size, system ROM, video revision, and keyboard controller version.• Start-up Test—Verifies the system components needed for starting the computer.• Run-In Test—Runs a comprehensive check on system memory.• Hard Disk Test—Runs a comprehensive self-test on any hard drive in the system.• Memory Test—Runs a comprehensive test on any memory installed in the computer.• Battery Test—Runs a comprehensive test on any batteries installed in the computer.• Error Log—Displays a log file if any errors have occurred.
Restore defaults	Replace the configuration settings in Computer Setup with the original factory settings. (Hard drive mode, password settings, and security settings are not changed when you restore the factory settings.)
Reset BIOS security to factory default	Restore the BIOS security settings to the factory default.
Ignore changes and exit	Cancel any changes entered during the current session. Then exit and restart the computer.
Save changes and exit	Save any changes entered during the current session. Then exit and restart the computer. Your changes go into effect when the computer restarts.

Security menu



NOTE: Some of the menu items listed in this section may not be supported by your computer.

Select	To do this
Administrator Tools	
Setup BIOS Administrator Password	Set up a BIOS administrator password
User Management (requires a BIOS administrator password)	
Create New BIOS User Account	<ul style="list-style-type: none">Select from a list of BIOS users.Select from a list of ProtectTools users.
Password Policy (requires a BIOS administrator password)	Revise password policy criteria.
HP SpareKey	Enable/disable HP SpareKey (enabled by default).
Always Prompt for HP SpareKey Enrollment	Enable/disable HP SpareKey enrollment (enabled by default).
Fingerprint Reset on Reboot (If Present)	Reset/clear the fingerprint reader ownership (select models only; disabled by default).
User Tools	
Change Password	Enter, change, or delete a BIOS administrator password.
HP SpareKey Enrollment	Enroll or reset HP SpareKey, which is a set of security questions and answers used if you forget your password.
Anti Theft	
AT-P	Enable/disable Anti-Theft Protection.
DriveLock Passwords	<ul style="list-style-type: none">Enable/disable DriveLock on any computer hard drive (enabled by default).Change a DriveLock user password or master password. <p>NOTE: DriveLock settings are accessible only when you enter Computer Setup by turning on (not restarting) the computer.</p>
Automatic DriveLock	Enable/disable Automatic DriveLock support.
TPM Embedded Security	Enable/disable support for Trusted Platform Module (TPM) Embedded Security, which protects the computer from unauthorized access to owner functions available in Embedded Security for ProtectTools. For more information, refer to the ProtectTools software
	<p>NOTE: You must have a setup password to change this setting.</p>
Disk Sanitizer	Run Disk Sanitizer to destroy all existing data on the low-voltage hard drive or the standard-voltage hard drive in the Upgrade bay.
	<p>CAUTION: If you run Disk Sanitizer, the data on the selected drive is destroyed permanently.</p>
System IDs	Enter a user-defined computer asset tracking number and ownership tag.

System Configuration menu



NOTE: Some of the menu items listed in this section may not be supported by your computer.

Select	To do this
Language	Change the Computer Setup language.
Boot Options	<ul style="list-style-type: none">• Set a Startup Menu delay (in seconds).• Set the MultiBoot Express Boot Popup delay in seconds.• Enable/disable Custom Logo (disabled by default).• Enable/disable Display Diagnostic URL (enabled by default).• Enable/disable CD-ROM boot (disabled by default).• Enable/disable SD Card boot (enabled by default).• Enable/disable floppy boot (enabled by default).• Enable/disable PXE Internal NIC boot (enabled by default).• Enable/disable Unified Extensible Firmware Interface (UEFI) Boot Mode (disabled by default).• Set the Legacy Boot Order.
Device Configurations	<ul style="list-style-type: none">• Enable/disable USB legacy support (enabled by default). When enabled, USB legacy support allows the following:<ul style="list-style-type: none">◦ Use of a USB keyboard in Computer Setup even when a Windows operating system is not running◦ Startup from bootable USB devices, including a hard drive, diskette drive, or optical drive connected by a USB port to the computer• Select a parallel port mode: ECP (Enhanced Capabilities Port), standard, bidirectional, or EPP (Enhanced Parallel Port).• Enable/disable fan always on while connected to an AC outlet (enabled by default).• Enable/disable Data Execution Prevention (select models only). When enabled, the processor can disable some virus code execution, which helps to improve computer security (disabled by default).• SATA (Serial Advanced Technology Attachment) device mode. The following options are available:<ul style="list-style-type: none">◦ AHCI (Advanced Host Controller Interface)◦ IDE (Integrated Drive Electronics)◦ RAID (select models only)

Select	To do this
Device Configurations (<i>continued</i>)	<p data-bbox="879 222 1417 275">NOTE: Availability of these options varies by computer model.</p> <ul data-bbox="879 296 1461 919" style="list-style-type: none"><li data-bbox="879 296 1461 348">• Enable/disable secondary battery fast charge (enabled by default).<li data-bbox="879 369 1417 390">• Enable/disable HP QuickLook (enabled by default).<li data-bbox="879 411 1361 464">• Enable/disable Preboot Authentication on HP QuickLook Boot (enabled by default).<li data-bbox="879 485 1417 506">• Enable/disable HP QuickWeb (enabled by default).<li data-bbox="879 527 1461 579">• Enable/disable HP QuickWeb Write Protect (disabled by default).<li data-bbox="879 600 1461 653">• Enable/disable Virtualization Technology (select models only; disabled by default).<li data-bbox="879 674 1445 726">• Enable/disable TXT (Intel Trusted Execution Technology) (select models only; disabled by default).<li data-bbox="879 747 1278 768">• Multi Core CPU (enabled by default).<li data-bbox="879 789 1326 810">• Intel HT Technology (enabled by default).<li data-bbox="879 831 1417 852">• Enable/disable Wake on USB (enabled by default).<li data-bbox="879 873 1417 919">• Enable/disable Num lock state at boot (disabled by default).

Select	To do this
Built-In Device Options	<ul style="list-style-type: none"> • Enable/disable the wireless button state (enabled by default). • Enable/disable embedded WLAN device radio (select models only; enabled by default). • Enable/disable the embedded Bluetooth device radio (enabled by default). • Enable/disable the Network Interface Controller (LAN) (enabled by default). • Enable/disable LAN/WLAN switching (disabled by default). • Set the wake on LAN state. Options include the following: <ul style="list-style-type: none"> ◦ Disabled ◦ Boot to Network ◦ Follow Boot Order • Enable/disable the Ambient Light Sensor. • Enable/disable the Notebook Upgrade bay device (enabled by default). • Enable/disable the fingerprint device (enabled by default). • Enable/disable the integrated camera (enabled by default). • Enable/disable the Power Monitor Circuit (enabled by default). • Enable/disable the audio device (enabled by default). • Enable/disable a modem device (enabled by default). • Enable/disable the microphone (enabled by default). • Enable/disable the internal speakers (enabled by default).
Port Options	<p>NOTE: NOTE: All port options are enabled by default.</p> <ul style="list-style-type: none"> • Enable/disable the serial port. • Enable/disable the parallel port. • Enable/disable the flash media reader. • Enable/disable the USB port. <p>CAUTION: Disabling the USB port also disables MultiBay devices and ExpressCard devices on the advanced port replicator.</p> • Enable/disable the 1394 port. • Enable/disable the ExpressCard slot. • Enable/disable the Smart Card slot. • Enable/disable the eSATA port.

Select	To do this
AMT Options	<ul style="list-style-type: none">• Enable/disable Firmware Verbosity.• Enable/disable AMT Setup Prompt (Ctrl-P).• Enable/disable USB Key Provisioning Support.• Enable/disable Unconfigure AMT on next boot.• Select Terminal Emulation Mode.<ul style="list-style-type: none">◦ ANSI◦ VT100• Enable/disable Firmware Progress Event Support.• Enable/disable Initiate Intel CIRA.
Set Security Level	Change, view, or hide security levels for all BIOS menu items.
Restore Security Defaults	Restore the default security settings.

6 Specifications

Computer specifications

	Metric	U.S.
Dimensions		
Depth	21.34 cm	8.40 in
Width	28.22 cm	11.11 in
Height (front to back)	2.80 cm to 3.40 cm	1.10 in to 1.34 in
Weight		
	1.50 kg	3.31 lbs
Input power		
Operating voltage	19.0 V dc @ 3.5 A – 65 W	
Operating current	3.5 A	
Temperature		
Operating (not writing to optical disc)	0°C to 35°C	32°F to 95°F
Operating (writing to optical disc)	5°C to 35°C	41°F to 95°F
Nonoperating	-20°C to 60°C	-4°F to 140°F
Relative humidity		
Operating	10% to 90%	
Nonoperating	5% to 90%	
Maximum altitude (unpressurized)		
Operating (14.7 to 10.1 psia)	-15 m to 3,048 m	-50 ft to 10,000 ft
Nonoperating (14.7 to 4.4 psia)	-15 m to 12,192 m	-50 ft to 40,000 ft
Shock		
Operating	125 g, 2 ms, half-sine	
Nonoperating	200 g, 2 ms, half-sine	
Random vibration		
Operating	0.75 g zero-to-peak, 10 Hz to 500 Hz, 0.25 oct/min sweep rate	
Nonoperating	1.50 g zero-to-peak, 10 Hz to 500 Hz, 0.5 oct/min sweep rate	
NOTE: Applicable product safety standards specify thermal limits for plastic surfaces. The computer operates well within this range of temperatures.		

12.1-in display specifications

	Metric	U.S.
Dimensions		
Width	16.9 cm	6.7 in
Depth	26.2 cm	10.3 in
Diagonal	30.8 cm	12.1 in
Number of colors	Up to 16.8 million	
Contrast ratio	250:1 (typical)	
Brightness	180 nits (typical)	
Backlight	LED	
Character display	80 × 25	
Total power consumption	4.0 W	
Viewing angle	+/-40° horizontal, +20°/-40° vertical (typical)	

Hard drive specifications

	500-GB*	320-GB*	250-GB*
Dimensions			
Height	9.5 mm	9.5 mm	9.5 mm
Width	70 mm	70 mm	70 mm
Weight	101 g	101 g	101 g
Interface type	SATA	SATA	SATA
Transfer rate	100 MB/sec	100 MB/sec	100 MB/sec
Security	ATA security	ATA security	ATA security
Seek times (typical read, including setting)			
Single track	3 ms	3 ms	3 ms
Average	13 ms	13 ms	13 ms
Maximum	24 ms	24 ms	24 ms
Logical blocks	976,752,240	625,121,433	488,376,120
Disk rotational speed	7200 rpm	7200 rpm	7200 rpm
Operating temperature	5°C to 55°C (41°F to 131°F)		

*1 GB = 1 billion bytes when referring to hard drive storage capacity. Actual accessible capacity is less. Actual drive specifications may differ slightly.

NOTE: Certain restrictions and exclusions apply. Contact technical support for details.

DVD±RW and CD-RW SuperMulti Double-Layer Drive specifications

Applicable disc	Read:	Write:
	CD-DA, CD+(E)G, CD-MIDI, CD-TEXT, CD-ROM, CD-ROM XA, MIXED MODE CD, CD-I, CD-I Bridge (Photo-CD, Video CD), Multisession CD, CD-EXTRA, Portfolio, CD-R, CD-RW), CD-R, CD-RW, DVD-ROM (DVD-5, DVD-9, DVD-10, DVD-18), DVD-R, DVD-RW, DVD+R, DVD+RW, DVD-RAM	CD-R and CD-RW DVD+R, DVD+RW, DVD-R, DVD-RW, DVD-RAM
Access time	CD	DVD
Random	< 175 ms	< 230 ms
Cache buffer	2.5 MB	
Data transfer rate		
24X CD-ROM	3,600 KB/sec	
8X DVD	10,800 KB/sec	
24X CD-R	3,600 KB/sec	
16X CD-RW	2,400 KB/sec	
8X DVD+R	10,800 KB/sec	
4X DVD+RW	5,400 KB/sec	
8X DVD-R	10,800 KB/sec	
4X DVD-RW	5,400 KB/sec	
2.4X DVD+R(9)	2,700 KB/sec	
5X DVD-RAM	6,750 KB/sec	
Transfer mode	Multiword DMA Mode	

DVD-ROM Drive specifications

Applicable disc	Read:	Write:
	CD-DA, CD+(E)G, CD-MIDI, CD-TEXT, CD-ROM, CD-ROM XA, MIXED MODE CD, CD-I, CD-I Bridge (Photo-CD, Video CD), Multisession CD (Photo-CD, CDEXTRA, Portfolio, CD-R, CD-RW), CDR, CD-RW, DVD-ROM (DVD-5, DVD-9, DVD-10, DVD-18), DVD-R, DVD-RW, DVD+R, DVD+RW, DVD-RAM	CD-R and CD-RW
Access time	CD	DVD
Random	< 110 ms	< 130 ms

Applicable disc	Read:	Write:
Cache buffer	2 MB	
Data transfer rate		
24X CD-ROM	3,600 KB/sec	
8X DVD	10,800 KB/sec	
24X CD-R	3,600 KB/sec	
16X CD-RW	3,600 KB/sec	

7 Backup and recovery

Windows 7

To protect your information, use Windows Backup and Restore to back up individual files and folders, back up your entire hard drive (select models only), create system repair discs (select models only), or create system restore points. In case of system failure, you can use the backup files to restore the contents of your computer.

Windows Backup and Restore provides the following options:

- Creating a system repair disc (select models only)
- Backing up individual files and folders
- Creating a system image (select models only)
- Scheduling automatic backups (select models only)
- Creating system restore points
- Recovering individual files
- Restoring the computer to a previous state
- Recovering information using recovery tools



NOTE: For detailed instructions, perform a search for these topics in Help and Support.

NOTE: In case of system instability, HP recommends that you print the recovery procedures and save them for later use.

Backing up your information

Recovery after a system failure is as complete as your most current backup. You should create system repair discs (select models only) and your initial backup immediately after software setup. As you add new software and data files, you should continue to back up your system on a regular basis to maintain a reasonably current backup. The system repair discs (select models only) are used to start up (boot) the computer and repair the operating system in case of system instability or failure. Your initial and subsequent backups allow you to restore your data and settings if a failure occurs.

You can back up your information to an optional external hard drive, a network drive, or discs.

Note the following when backing up:

- Store personal files in the Documents library, and back it up regularly.
- Back up templates that are stored in their associated programs.
- Save customized settings that appear in a window, toolbar, or menu bar by taking a screen shot of your settings. The screen shot can be a time-saver if you have to reset your preferences.

To create a screen shot:

1. Display the screen you want to save.
2. Copy the screen image:

To copy only the active window, press **alt+fn+prt sc**.

To copy the entire screen, press **fn+prt sc**.

3. Open a word-processing document, and then select **Edit > Paste**.

The screen image is added to the document.

4. Save the document.
- When backing up to discs, use any of the following types of discs (purchased separately): CD-R, CD-RW, DVD+R, DVD+R DL, DVD-R, DVD-R DL, or DVD±RW. The discs you use will depend on the type of optical drive installed in your computer.

 **NOTE:** DVDs and DVDs with double-layer (DL) support store more information than CDs, so using them for backup reduces the number of recovery discs required.

- When backing up to discs, number each disc before inserting it into the optical drive of the computer.

To create a backup using Backup and Restore, follow these steps:

 **NOTE:** Be sure that the computer is connected to AC power before you start the backup process.

NOTE: The backup process may take over an hour, depending on file size and the speed of the computer.

1. Select **Start > All Programs > Maintenance > Backup and Restore**.
2. Follow the on-screen instructions to set up your backup, create a system image (select models only), or create a system repair disc (select models only).

 **NOTE:** Windows includes the User Account Control feature to improve the security of your computer. You may be prompted for your permission or password for tasks such as installing software, running utilities, or changing Windows settings. Refer to Help and Support for more information.

Performing a recovery

In case of system failure or instability, the computer provides the following tools to recover your files:

- Windows recovery tools: You can use Windows Backup and Restore to recover information you have previously backed up. You can also use Windows Startup Repair to fix problems that might prevent Windows from starting correctly.
- **f11** recovery tools: You can use the **f11** recovery tools to recover your original hard drive image. The image includes the Windows operating system and software programs installed at the factory.

 **NOTE:** If you are unable to boot (start up) your computer and you cannot use the system repair discs you previously created (select models only), you must purchase a Windows 7 operating system DVD to reboot the computer and repair the operating system. For additional information, refer to the “Using a Windows 7 operating system DVD (purchased separately)” section in this guide.

Using the Windows recovery tools

To recover information you previously backed up, follow these steps:

1. Select **Start > All Programs > Maintenance > Backup and Restore**.
2. Follow the on-screen instructions to recover your system settings, your computer (select models only), or your files.

 **NOTE:** Windows includes the User Account Control feature to improve the security of your computer. You may be prompted for your permission or password for tasks such as installing software, running utilities, or changing Windows settings. Refer to Help and Support for more information.

To recover your information using Startup Repair, follow these steps:

 **CAUTION:** Using Startup Repair completely erases hard drive contents and reformats the hard drive. All files you have created and any software installed on the computer are permanently removed. When reformatting is complete, the recovery process restores the operating system, as well as the drivers, software, and utilities from the backup used for recovery.

1. If possible, back up all personal files.
2. If possible, check for the presence of the Windows partition or the HP Recovery partition.

To check for the Windows partition, select **Start > Computer**.

To check for the HP Recovery partition, click **Start**, right-click **Computer**, click **Manage**, and then click **Disk Management**.

 **NOTE:** If the Windows partition or the HP Recovery partition is not listed, you must recover your operating system and programs using the Windows 7 operating system DVD and the *Driver Recovery* disc (both purchased separately). For additional information, refer to the “Using a Windows 7 operating system DVD (purchased separately)” section.

3. If the Windows partition and the HP Recovery partition are listed, restart the computer, and then press **f8** before the Windows operating system loads.
4. Select **Startup Repair**.
5. Follow the on-screen instructions.

 **NOTE:** For additional information on recovering information using the Windows tools, perform a search for these topics in Help and Support.

Using f11 recovery tools

 **CAUTION:** Using **f11** completely erases hard drive contents and reformats the hard drive. All files you have created and any software installed on the computer are permanently removed. The **f11** recovery tool reinstalls the operating system and HP programs and drivers that were installed at the factory. Software not installed at the factory must be reinstalled. Personal files must be restored from a backup.

To recover the original hard drive image using **f11**, follow these steps:

1. If possible, back up all personal files.
2. If possible, check for the presence of the HP Recovery partition: click **Start**, right-click **Computer**, click **Manage**, and then click **Disk Management**.

 **NOTE:** If the HP Recovery partition is not listed, you must recover your operating system and programs using the Windows 7 operating system DVD and the *Driver Recovery* disc (both purchased separately). For additional information, refer to the “Using a Windows 7 operating system DVD (purchased separately)” section.

3. If the HP Recovery partition is listed, restart the computer, and then press **esc** while the “Press the ESC key for Startup Menu” message is displayed at the bottom of the screen.
4. Press **f11** while the “Press <F11> for recovery” message is displayed on the screen.
5. Follow the on-screen instructions.

Using a Windows 7 operating system DVD (purchased separately)

If you are unable to boot (start up) your computer and you cannot use the system repair discs you previously created (select models only), you must purchase a Windows 7 operating system DVD to reboot the computer and repair the operating system. Be sure that your most recent backup (stored on discs or on an external drive) is easily accessible. To order a Windows 7 operating system DVD, go to <http://www.hp.com/support>, select your country or region, and follow the on-screen instructions. You can also order the DVD by calling technical support. For contact information, refer to the Worldwide Telephone Numbers booklet included with the computer.

 **CAUTION:** Using a Windows 7 operating system DVD completely erases hard drive contents and reformats the hard drive. All files you have created and any software installed on the computer are permanently removed. When reformatting is complete, the recovery process helps you restore the operating system, as well as drivers, software, and utilities.

To initiate recovery using a Windows 7 operating system DVD, follow these steps:

 **NOTE:** This process takes several minutes.

1. If possible, back up all personal files.
2. Restart the computer, and then insert the Windows 7 operating system DVD into the optical drive before the Windows operating system loads.
3. When prompted, press any keyboard key.
4. Follow the on-screen instructions.
5. Click **Next**.
6. Select **Repair your computer**.
7. Follow the on-screen instructions.

Windows Vista

To protect your information, use the Backup and Restore Center to back up individual files and folders, back up your entire hard drive (select models only), or create system restore points. In case of system failure, you can use the backup files to restore the contents of your computer.

The Backup and Restore Center provides the following options:

- Backing up individual files and folders
- Backing up the entire hard drive (select models only)
- Scheduling automatic backups (select models only)
- Creating system restore points
- Recovering individual files
- Restoring the computer to a previous state
- Recovering information using recovery tools

 **NOTE:** For detailed instructions, perform a search for these topics in Help and Support.

NOTE: In case of system instability, HP recommends that you print the recovery procedures and save them for later use.

Backing up your information

Recovery after a system failure is as complete as your most current backup. You should create your initial backup immediately after software setup. As you add new software and data files, you should continue to back up your system on a regular basis to maintain a reasonably current backup.

You can back up your information to an optional external hard drive, a network drive, or discs.

Note the following when backing up:

- Store personal files in the Documents folder, and back it up regularly.
- Back up templates that are stored in their associated programs.
- Save customized settings that appear in a window, toolbar, or menu bar by taking a screen shot of your settings. The screen shot can be a time-saver if you have to reset your preferences.

To create a screen shot:

1. Display the screen you want to save.
2. Copy the screen image:

To copy only the active window, press **alt+fn+prt sc**.

To copy the entire screen, press **fn+prt sc**.

3. Open a word-processing document, and then select **Edit > Paste**.

The screen image is added to the document.

4. Save the document.

- When backing up to discs, use any of the following types of discs (purchased separately): CD-R, CD-RW, DVD+R, DVD+R DL, DVD-R, DVD-R DL, or DVD±RW. The discs you use will depend on the type of optical drive installed in your computer.

 **NOTE:** DVDs and DVDs with double-layer (DL) support store more information than CDs, so using them for backup reduces the number of recovery discs required.

- When backing up to discs, number each disc before inserting it into the optical drive of the computer.

 **NOTE:** Be sure that the computer is connected to AC power before you start the backup process.

NOTE: The backup process may take over an hour, depending on file size and the speed of the computer.

1. Select **Start > All Programs > Maintenance > Backup and Restore Center**.
2. Follow the on-screen instructions to back up your entire computer (select models only) or your files.

 **NOTE:** Windows includes the User Account Control feature to improve the security of your computer. You may be prompted for your permission or password for tasks such as installing software, running utilities, or changing Windows settings. Refer to Help and Support for more information.

Performing a recovery

In case of system failure or instability, the computer provides the following tools to recover your files:

- Windows recovery tools: You can use the Backup and Restore Center to recover information you have previously backed up. You can also use Windows Startup Repair to fix problems that might prevent Windows from starting correctly.
- **f11** recovery tools: You can use the **f11** recovery tools to recover your original hard drive image. The image includes the Windows operating system and software programs installed at the factory.

 **NOTE:** If you are unable to boot (start up) your computer, you must purchase a Windows Vista operating system DVD to reboot the computer and repair the operating system. For additional information, refer to the “Using a Windows Vista operating system DVD (purchased separately)” section in this guide.

Using the Windows recovery tools

To recover information you previously backed up, follow these steps:

1. Select **Start > All Programs > Maintenance > Backup and Restore Center**.
2. Follow the on-screen instructions to recover your entire computer (select models only) or your files.

 **NOTE:** Windows includes the User Account Control feature to improve the security of your computer. You may be prompted for your permission or password for tasks such as installing software, running utilities, or changing Windows settings. Refer to Help and Support for more information.

To recover your information using Startup Repair, follow these steps:

 **CAUTION:** Using Startup Repair completely erases hard drive contents and reformats the hard drive. All files you have created and any software installed on the computer are permanently removed. When reformatting is complete, the recovery process restores the operating system, as well as the drivers, software, and utilities from the backup used for recovery.

1. If possible, back up all personal files.
2. If possible, check for the presence of the Windows partition or the HP Recovery partition. To find the partitions, select **Start > Computer**.

 **NOTE:** If the Windows partition and the HP Recovery partition have been deleted, you must recover your operating system and programs using the Windows Vista operating system DVD and the *Driver Recovery* disc (both purchased separately). For additional information, refer to the “Using a Windows Vista operating system DVD (purchased separately)” section.

3. Restart the computer, and then press **f8** before the Windows operating system loads.
4. Select **Repair your computer**.
5. Follow the on-screen instructions.

 **NOTE:** For additional information on recovering information using the Windows tools, perform a search for these topics in Help and Support.

Using f11 recovery tools

 **CAUTION:** Using **f11** completely erases hard drive contents and reformats the hard drive. All files you have created and any software installed on the computer are permanently removed. The **f11** recovery tool reinstalls the operating system and HP programs and drivers that were installed at the factory. Software not installed at the factory must be reinstalled. Personal files must be restored from a backup.

 **NOTE:** If your computer includes a solid-state drive (SSD), you may not have a recovery partition. Recovery discs have been included for computers that do not have a partition. Use these discs to recover your operating system and software. To check for the presence of a recovery partition, select **Start > Computer**. If the partition is present, an HP Recovery drive is listed in the **Hard Disk Drives** section of the window.

To recover the original hard drive image using **f11**, follow these steps:

1. If possible, back up all personal files.
2. If possible, check for the presence of the HP Recovery partition. To find the partition, select **Start > Computer**.

 **NOTE:** If the HP Recovery partition has been deleted, you must recover your operating system and programs using the Windows Vista operating system DVD and the *Driver Recovery* disc (both purchased separately). For additional information, refer to the “Using a Windows Vista operating system DVD (purchased separately)” section.

3. Turn on or restart the computer, and then press **esc** while the “Press the ESC key for Startup Menu” message is displayed at the bottom of the screen.
4. Press **f11** while the “Press <F11> for recovery” message is displayed on the screen.
5. Follow the on-screen instructions.

Using a Windows Vista operating system DVD (purchased separately)

If you are unable to boot (start up) your computer, you must purchase a Windows Vista operating system DVD to reboot the computer and repair the operating system. Be sure that your most recent backup (stored on discs or on an external drive) is easily accessible. To order a Windows Vista operating system DVD, go to <http://www.hp.com/support>, select your country or region, and follow the on-screen instructions. You can also order the DVD by calling technical support. For contact information, refer to the Worldwide Telephone Numbers booklet included with the computer.

 **CAUTION:** Using a Windows Vista operating system DVD completely erases hard drive contents and reformats the hard drive. All files you have created and any software installed on the computer are permanently removed. When reformatting is complete, the recovery process helps you restore the operating system, as well as drivers, software, and utilities.

To initiate recovery using a Windows Vista operating system DVD, follow these steps:

 **NOTE:** This process takes several minutes.

1. If possible, back up all personal files.
2. Restart the computer, and then insert the Windows Vista operating system DVD into the optical drive before the Windows operating system loads.
3. When prompted, press any keyboard key.
4. Follow the on-screen instructions.
5. Click **Next**.

6. Select **Repair your computer**.
7. Follow the on-screen instructions.

Windows XP

To protect your information, use the Windows Backup utility to back up files and folders or create recovery points. In case of system failure, you can use the backup files to restore your computer.

Windows provides the following options:

- Backing up individual files and folders
- Backing up all files and folders
- Scheduling automatic backups
- Creating recovery points
- Recovering information



NOTE: For detailed instructions, perform a search for these topics in Help and Support.

NOTE: In case of system instability, HP recommends that you print the recovery procedures and save them for later use.

Backing up your information

Recovery after a system failure is as complete as your most current backup. You should create your initial backup immediately after software setup. As you add new software and data files, you should continue to back up your system on a regular basis to maintain a reasonably current backup.

You can back up individual files or folders to an optional external hard drive or to a network drive.

Note the following when backing up:

- Store personal files in the My Documents folder, and back it up periodically.
- Back up templates stored in their associated programs.
- Save customized settings that appear in a window, toolbar, or menu bar by taking a screen shot of your settings. The screen shot can be a time saver if you have to reset your preferences.

To copy the screen and paste it into a word-processing document:

1. Display the screen you want to save.
2. Copy the screen image:
To copy only the active window, press **alt+fn+prt sc**.
To copy the entire screen, press **fn+prt sc**.
3. Open a word-processing document, and then select **Edit > Paste**.
The screen image is added to the document.
4. Save the document.

To create a backup using the Windows Backup utility (select models only), follow these steps:



NOTE: Be sure that the computer is connected to AC power before you start the backup process.

NOTE: The backup process may take over an hour, depending on file size and the speed of the computer.

1. Select **Start > All Programs > Accessories > System Tools > Backup**.
2. Follow the on-screen instructions.

Performing a recovery

In case of system failure or instability, the computer provides the following tools to recover your files:

- Windows recovery tools (select models only): You can use the Windows Backup utility to recover information you have previously backed up.
- *Operating System* and *Driver Recovery* discs (included with your computer): You can use the discs to recover your operating system and programs installed at the factory.

Recovering your information

To recover information you previously backed up, follow these steps:

1. If possible, back up all personal files.
2. Select **Start > All Programs > Accessories > System Tools > Backup**.
The Backup or Restore Wizard opens.
3. Click **Restore files and settings**, and then click **Next**.
4. Follow the on-screen instructions.



NOTE: For additional information on initiating a recovery in Windows, perform a search for this topic in Help and Support.

Recovering the operating system and programs



CAUTION: The recovery process reformats and completely erases the hard drive. All files you have created and any software installed on the computer are permanently removed. The recovery process reinstalls the original operating system as well as software and drivers. Software, drivers, and updates not installed by HP must be manually reinstalled. Personal files must be restored from a backup.

To recover your operating system and programs, follow these steps:

1. If possible, back up all personal files.
2. Shut down the computer.
3. Insert the *Operating System* disc into the optical drive.
4. Turn on the computer.
5. Follow the on-screen instructions to install the operating system.
6. After the operating system is installed, remove the *Operating System* disc and insert the *Driver Recovery* disc.
7. Follow the on-screen instructions to install the drivers and programs.

8 Connector pin assignments

1394

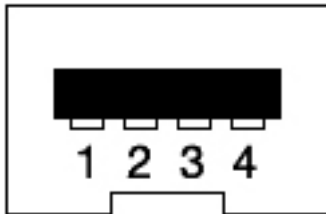

Pin	Signal
1	TPB-
2	TPB+
3	TPA-
4	TPA+

Audio-in (microphone)/audio-out (headphone) combo

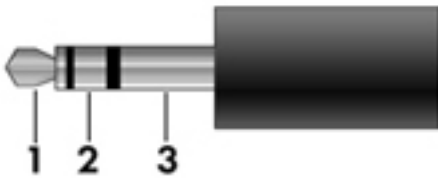

Pin	Signal
1	Audio signal in (microphone) / audio out, left channel (headphone)
2	Audio signal in (microphone) / audio out, right channel (headphone)
3	Ground (microphone) / ground (headphone)

DisplayPort

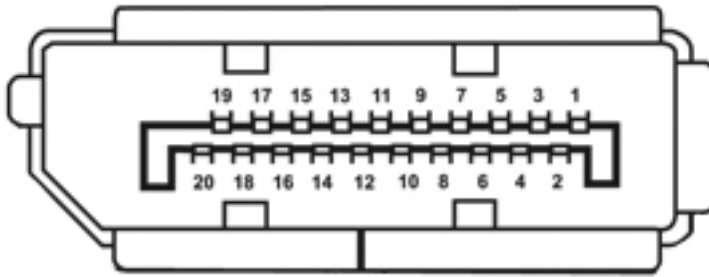

Pin	Signal
1	ML_lane 0 (positive)
2	Ground
3	Lane 0 (negative)
4	Lane 1 (positive)
5	Ground
6	Lane 1 (negative)
7	Lane 2 (positive)
8	Ground
9	Lane 2 (negative)
10	Lane 3 (positive)
11	Ground
12	Lane 3 (negative)
13	Connected to ground
14	Connected to ground
15	Auxiliary channel (positive)
16	Ground
17	Auxiliary channel
18	Hot plug detect
19	Return for power
20	Power for connector

External monitor

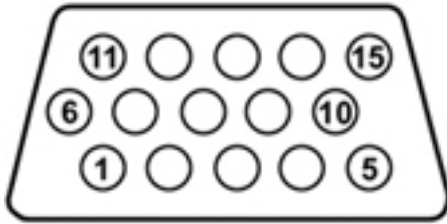

Pin	Signal
1	Red analog
2	Green analog
3	Blue analog
4	Not connected
5	Ground
6	Ground analog
7	Ground analog
8	Ground analog
9	+5 VDC
10	Ground
11	Monitor detect
12	DDC 2B data
13	Horizontal sync
14	Vertical sync
15	DDC 2B clock

RJ-11 (modem)

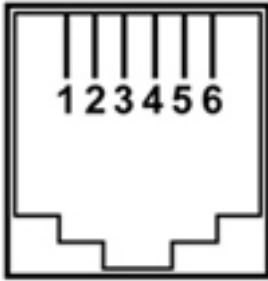

Pin	Signal
1	Unused
2	Tip
3	Ring
4	Unused
5	Unused
6	Unused

RJ-45 (network)

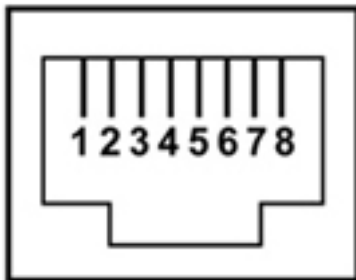

Pin	Signal
1	Transmit +
2	Transmit -
3	Receive +
4	Unused
5	Unused
6	Receive -
7	Unused
8	Unused

Universal Serial Bus

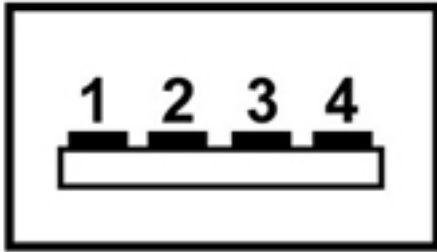

Pin	Signal
1	+5 VDC
2	Data
3	Data +
4	Ground

9 Power cord set requirements

The wide-range input feature of the computer permits it to operate from any line voltage from 100 to 120 volts AC, or from 220 to 240 volts AC

The 3-conductor power cord set included with the computer meets the requirements for use in the country or region where the equipment is purchased.

Power cord sets for use in other countries and regions must meet the requirements of the country or region where the computer is used.

Requirements for all countries

The following requirements are applicable to all countries and regions:

- The length of the power cord set must be at least **1.5 m** (5.0 ft) and no more than **2.0 m** (6.5 ft).
- All power cord sets must be approved by an acceptable accredited agency responsible for evaluation in the country or region where the power cord set will be used.
- The power cord sets must have a minimum current capacity of 10 amps and a nominal voltage rating of 125 or 250 V AC, as required by the power system of each country or region.
- The appliance coupler must meet the mechanical configuration of an EN 60 320/IEC 320 Standard Sheet C13 connector for mating with the appliance inlet on the back of the computer.

Requirements for specific countries and regions

Country/region	Accredited agency	Applicable note number
Australia	EANSW	1
Austria	OVE	1
Belgium	CEBC	1
Canada	CSA	2
Denmark	DEMKO	1
Finland	FIMKO	1
France	UTE	1
Germany	VDE	1
Italy	IMQ	1
Japan	METI	3
The Netherlands	KEMA	1
Norway	NEMKO	1
The People's Republic of China	COC	5
South Korea	EK	4
Sweden	SEMKO	1
Switzerland	SEV	1
Taiwan	BSMI	4
The United Kingdom	BSI	1
The United States	UL	2

1. The flexible cord must be Type HO5VV-F, 3-conductor, 1.0-mm² conductor size. Power cord set fittings (appliance coupler and wall plug) must bear the certification mark of the agency responsible for evaluation in the country or region where it will be used.
2. The flexible cord must be Type SPT-3 or equivalent, No. 18 AWG, 3-conductor. The wall plug must be a two-pole grounding type with a NEMA 5-15P (15 A, 125 V) or NEMA 6-15P (15 A, 250 V) configuration.
3. The appliance coupler, flexible cord, and wall plug must bear a "T" mark and registration number in accordance with the Japanese Dentori Law. The flexible cord must be Type VCT or VCTF, 3-conductor, 1.00-mm² conductor size. The wall plug must be a two-pole grounding type with a Japanese Industrial Standard C8303 (7 A, 125 V) configuration.
4. The flexible cord must be Type RVV, 3-conductor, 0.75-mm² conductor size. Power cord set fittings (appliance coupler and wall plug) must bear the certification mark of the agency responsible for evaluation in the country or region where it will be used.
5. The flexible cord must be Type VCTF, 3-conductor, 0.75-mm² conductor size. Power cord set fittings (appliance coupler and wall plug) must bear the certification mark of the agency responsible for evaluation in the country or region where it will be used.

10 Recycling

Battery

When a battery has reached the end of its useful life, do not dispose of the battery in general household waste. Follow the local laws and regulations in your area for computer battery disposal.

Display

⚠ WARNING! The backlight contains mercury. Caution must be exercised when removing and handling the backlight to avoid damaging this component and causing exposure to the mercury.

⚠ CAUTION: The procedures in this chapter can result in damage to display components. The only components intended for recycling purposes are the liquid crystal display (LCD) panel and the backlight. When you remove these components, handle them carefully.

📄 NOTE: Materials Disposal. This HP product contains mercury in the backlight in the display assembly that might require special handling at end-of-life. Disposal of mercury may be regulated because of environmental considerations. For disposal or recycling information, contact your local authorities, or see the Electronic Industries Alliance (EIA) Web site at <http://www.eiai.org>.

This section provides disassembly instructions for the display assembly. The display assembly must be disassembled to gain access to the backlight **(1)** and the liquid crystal display (LCD) panel **(2)**.



📄 NOTE: The procedures provided in this chapter are general disassembly instructions. Specific details, such as screw sizes, quantities, and locations, and component shapes and sizes, can vary from one computer model to another.

Perform the following steps:

1. Remove all screw covers (1) and screws (2) that secure the display bezel to the display assembly.

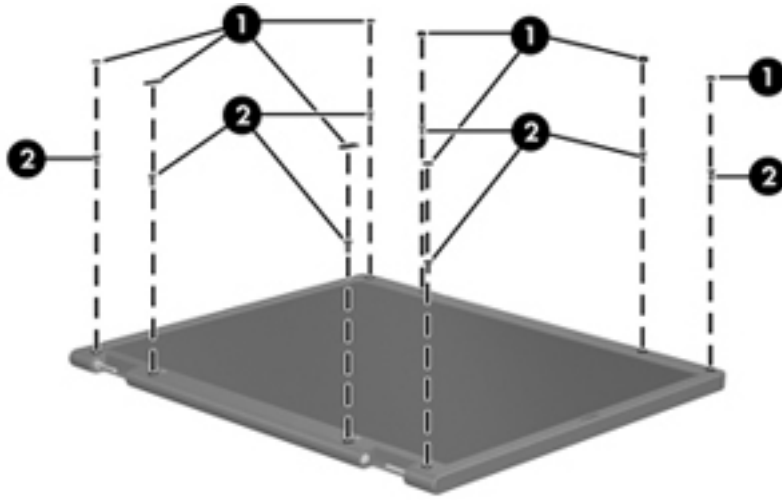

2. Lift up and out on the left and right inside edges (1) and the top and bottom inside edges (2) of the display bezel until the bezel disengages from the display assembly.
3. Remove the display bezel 3.

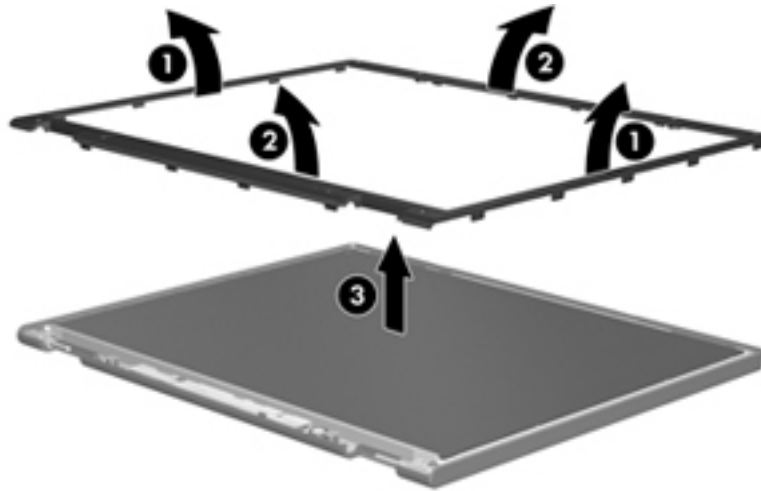

4. Disconnect all display panel cables (1) from the display inverter and remove the inverter 2.

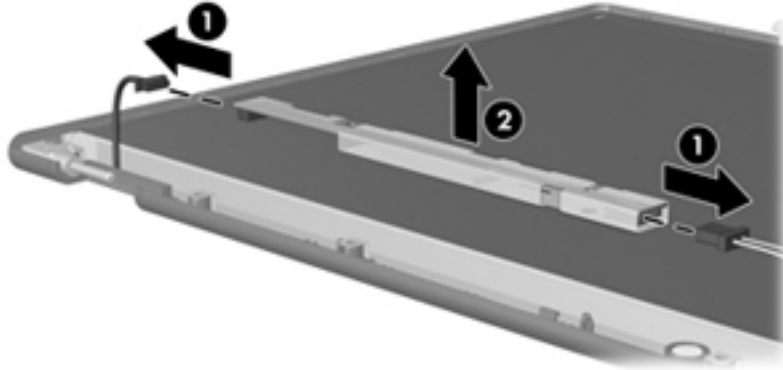

5. Remove all screws (1) that secure the display panel assembly to the display enclosure.
6. Remove the display panel assembly (2) from the display enclosure.

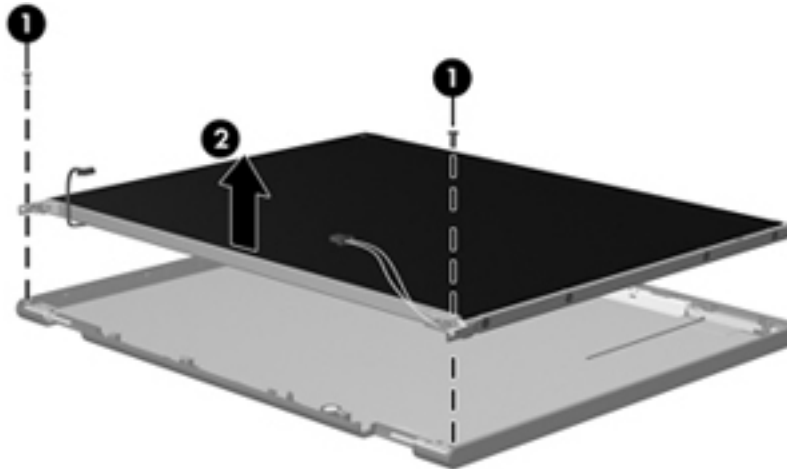

7. Turn the display panel assembly upside down.
8. Remove all screws that secure the display panel frame to the display panel.

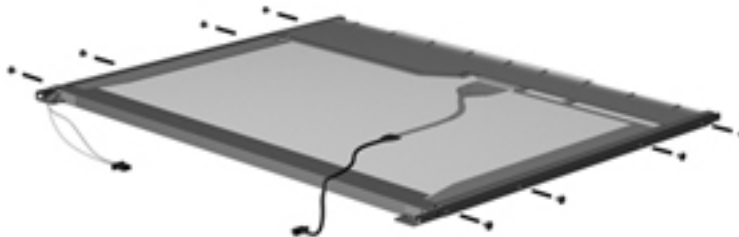

9. Use a sharp-edged tool to cut the tape (1) that secures the sides of the display panel to the display panel frame.

10. Remove the display panel frame (2) from the display panel.

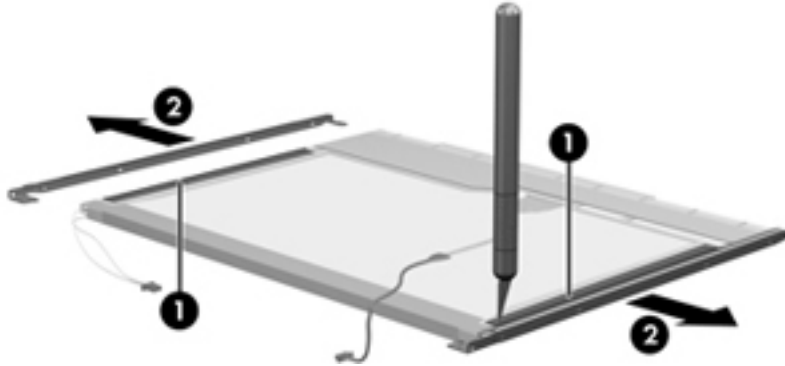

11. Remove the screws (1) that secure the backlight cover to the display panel.

12. Lift the top edge of the backlight cover (2) and swing it outward.

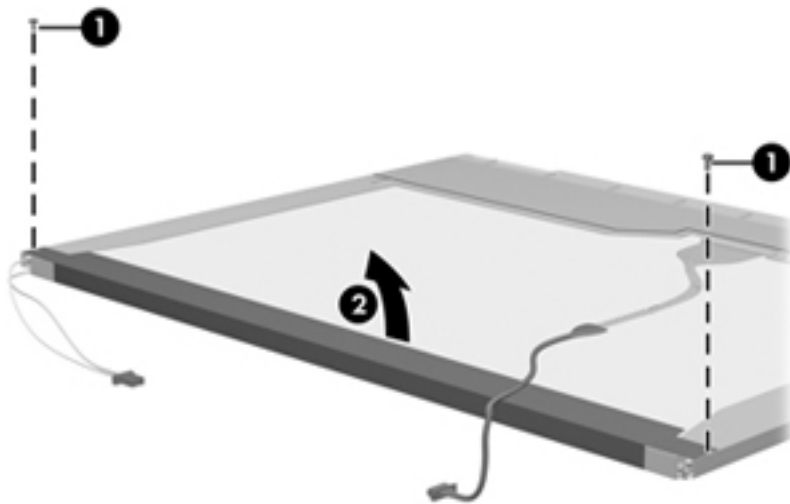

13. Remove the backlight cover.

14. Turn the display panel right-side up.

15. Remove the backlight cables (1) from the clip (2) in the display panel.

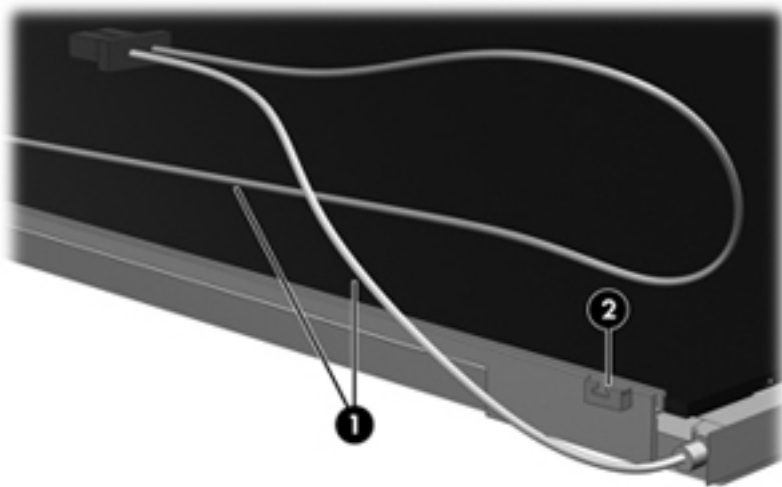

16. Turn the display panel upside down.
17. Remove the backlight frame from the display panel.

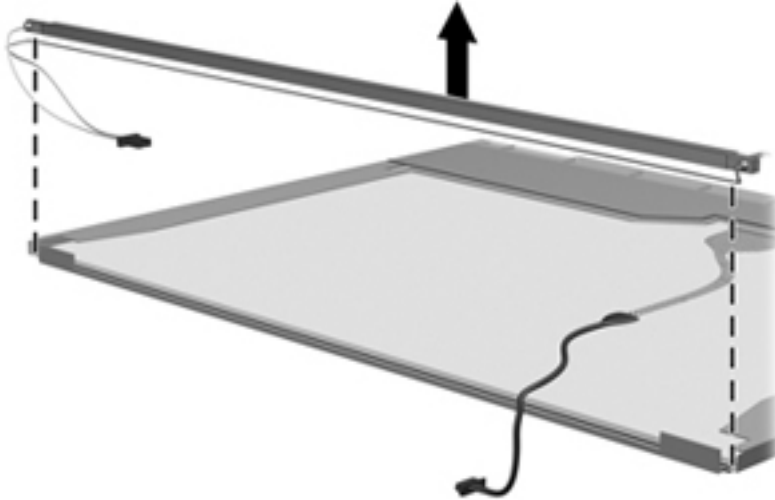

⚠ WARNING! The backlight contains mercury. Exercise caution when removing and handling the backlight to avoid damaging this component and causing exposure to the mercury.

18. Remove the backlight from the backlight frame.

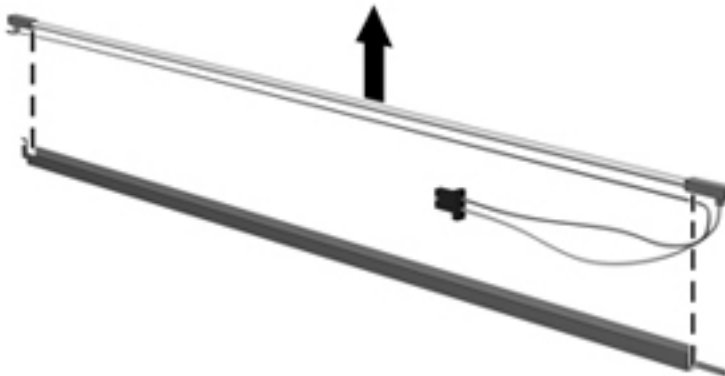

19. Disconnect the display cable (1) from the LCD panel.
20. Remove the screws (2) that secure the LCD panel to the display rear panel.
21. Release the LCD panel (3) from the display rear panel.

22. Release the tape (4) that secures the LCD panel to the display rear panel.

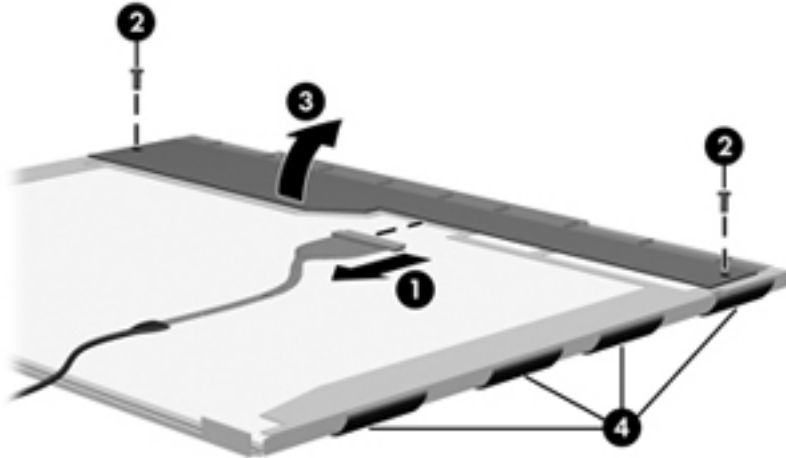

23. Remove the LCD panel.

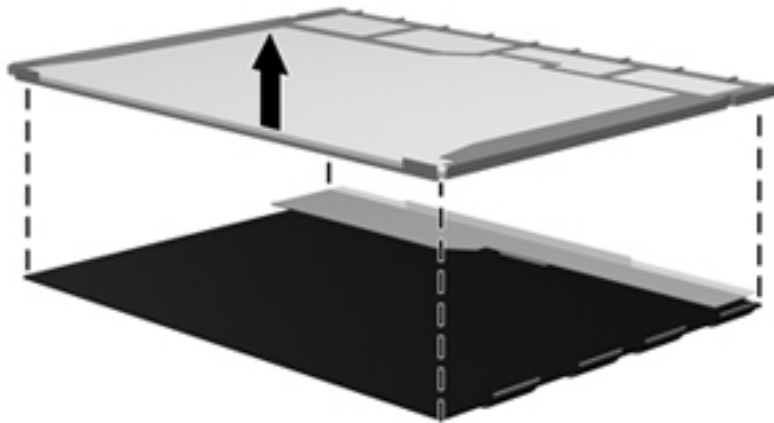

24. Recycle the LCD panel and backlight.

Index

Symbols/Numerics

1394 port
connector pinout 135
location 16

A

AC adapter, spare part numbers
31, 36
ambient light sensor board
location 9
removal 77
spare part number 27, 34, 77
antenna
disconnecting 55, 57
location 8
audio, product description 2
audio-in jack
connector pinout 135
location 16
audio-out jack
connector pinout 135
location 16

B

base enclosure, spare part
number 23, 34
battery
removal 44
spare part numbers 23, 32,
33, 34, 44
battery bay 17
battery light 14
battery release latch 17
Bluetooth module
removal 46
spare part number 23, 32, 46
Bluetooth module cable, removal
87
Bluetooth module compartment
cover
illustrated 30
removal 46
bottom components 17
business card slot 14
button components 10

buttons

display release 14
keyboard light 8
pointing stick 13
power 11
QuickLook 11
QuickWeb 11
TouchPad 13
TouchPad button 13
TouchPad on/off 11, 13
volume down 11
volume mute 11
volume up 12
wireless 11

C

Cable Kit, spare part number 31,
34
cables, service considerations 38
card reader board
removal 84
spare part number 22, 34, 84
card reader board bracket
removal 84
spare part number 22, 34, 84
chipset, product description 1
components
bottom 17
buttons 10
display 8
front 14
keys 12
left-side 15
pointing device 13
rear 16
right-side 16
computer feet
locations 43
spare part number 43
computer specifications 120
connector pinout
1394 port 135
audio-in jack 135
audio-out jack 135
DisplayPort 136

external monitor port 137
headphone jack 135
microphone jack 135
modem jack 138
monitor port 137
network jack 138
RJ-11 jack 138
RJ-45 jack 138
Universal Serial Bus (USB)
port 139
connectors, service
considerations 38

D

diskette drive, precautions 38
display assembly
removal 72
spare part numbers 21, 36, 72
display bezel
removal 76
spare part numbers 27, 34, 76
display components 8
display enclosure, spare part
number 27, 34
Display Hinge Kit, spare part
number 27, 34, 79
display panel cable, spare part
number 27, 34
display panel, product
description 1
display release button 14
display specifications 121
DisplayPort
connector pinout 136
docking connector 16
docking station, spare part
number 31, 34
docking support, product
description 4
drive light 14
drives, preventing damage 38
DVD-ROM Drive
precautions 38
removal 59

- spare part number 23, 29, 34, 59
- specifications 122
- DVD±RW and CD-RW SuperMulti Double-Layer Drive
 - precautions 38
 - removal 59
 - spare part number 23, 29, 34, 59
 - specifications 122

E

- electrostatic discharge 39
- esc key 12
- Ethernet, product description 3
- ExpressCard slot 16
- ExpressCard slot bezel, illustrated 30
- external media cards, product description 3
- external monitor port
 - connector pinout 137
 - location 16

F

- fan/heat sink assembly
 - removal 93
 - spare part numbers 23, 34, 35, 93

feet

- locations 43
- spare part number 43

- fingerprint reader 12

- fn key 12

- front components 14

- function keys 12

G

- graphics, product description 1
- grounding equipment and methods 41

H

- hard drive

- precautions 38
- product description 2
- removal 50, 61
- spare part numbers 25, 26, 28, 29, 34, 36, 50, 61
- specifications 121
- hard drive bay 15, 17, 18

- hard drive carrier
 - removal 61
 - spare part numbers 23, 29, 34, 61

- hard drive shield

- removal 51

- headphone jack

- connector pinout 135

- location 16

- hinge

- removal 79

- spare part number 27, 34, 79

- hinge cover, illustrated 30

I

- internal storage, product description 2

J

- jacks

- audio-in 16

- audio-out 16

- headphone 16

- microphone 16

- modem 15

- network 16

- RJ-11 15

- RJ-45 16

K

- key components 12

- keyboard

- product description 4

- removal 65

- spare part numbers 21, 35, 65

- keyboard light 8

- keyboard light button 8

- keys

- esc 12

- fn 12

- function 12

- numeric keypad 12

- Windows application 12

- Windows logo 12

L

- left-side components 15

- lights

- battery 14

- drive 14

- keyboard 8

- power 14
- webcam 8
- wireless 14

M

- mass storage device

- removal 50

- spare part numbers 25, 28, 29, 50

- memory module

- product description 1

- removal 48, 70

- spare part numbers 22, 36, 48, 70

- memory module compartment 17

- memory module compartment

- cover

- illustrated 30

- removal 48

- memory shield

- removal 70

- spare part number 22, 35, 70

- microphone

- location 8

- product description 2

- microphone jack

- connector pinout 135

- location 16

- model name 1

- modem jack

- connector pinout 138

- location 15

- modem module

- product description 2

- removal 92

- spare part numbers 23, 32, 92

- monitor port

- connector pinout 137

- location 16

N

- network jack

- connector pinout 138

- location 16

- numeric keypad keys 12

O

- operating system, product

- description 4

- optical drive

- location 15

- precautions 38
- product description 2
- removal 59
- spare part numbers 23, 29, 34, 59
- specifications 122
- optical drive bay 18
- optical drive bezel, illustrated 30

P

- packing guidelines 40
- plastic parts 37
- Plastics Kit
 - contents 30
 - spare part number 22, 30, 36
- pointing device
 - components 13
 - product description 4
- pointing stick 13
- pointing stick button 13
- ports
 - 1394 16
 - external monitor 16
 - monitor 16
 - product description 4
 - Universal Serial Bus (USB) 15, 16
- power button 11
- power connector 15
- power cord
 - set requirements 140
 - spare part numbers 31, 32
- power light 14
- power requirements, product description 4
- processor, product description 1
- product description
 - audio 2
 - chipset 1
 - display panel 1
 - docking support 4
 - Ethernet 3
 - external media cards 3
 - graphics 1
 - hard drives 2
 - internal storage 2
 - keyboard 4
 - memory module 1
 - microphone 2
 - modem module 2

- operating system 4
- optical drives 2
- pointing devices 4
- ports 4
- power requirements 4
- processors 1
- product name 1
- security 4
- solid state drive 2
- video 2
- wireless 3
- product name 1

Q

- QuickLook button 11
- QuickWeb button 11

R

- rear components 16
- removal/replacement
 - preliminaries 37
 - procedures 42
- right-side components 16
- RJ-11 jack
 - connector pinout 138
 - location 15
- RJ-45 jack
 - connector pinout 138
 - location 16
- RTC battery
 - removal 69
 - spare part number 22, 32, 69
- Rubber Kit, spare part number 23, 36

S

- Screw Kit, spare part number 31, 36
- SD Card Reader 16
- security cable slot 16
- security, product description 4
- serial number 19, 42
- service considerations 37
- SIM
 - removal 45
 - spare part number 45
- SIM slot 17
- smart card reader 15
- solid-state drive
 - product description 2

- removal 50, 61
- spare part numbers 25, 26, 28, 29, 34, 36, 50, 61

- speaker
 - removal 86
 - spare part number 22, 36, 86
- speakers 14, 17
- specifications
 - computer 120
 - display 121
 - DVD-ROM Drive 122
 - DVD±RW and CD-RW SuperMulti Double-Layer Drive 122
 - hard drive 121
 - optical drive 122
- static-shielding materials 41
- switch cover
 - removal 65
 - spare part number 21, 36, 65
- system board
 - removal 89
 - spare part numbers 22, 34, 36, 89

T

- thermal material, replacement 94
- tools required 37
- top cover
 - removal 81
 - spare part numbers 22, 36, 81
- TouchPad 13
- TouchPad button 13
- TouchPad on/off button 11, 13
- TouchPad scroll zone 13
- transporting guidelines 40

U

- Universal Serial Bus (USB) port
 - connector pinout 139
 - location 15, 16

V

- vents 16, 17
- video, product description 2
- volume down button 11
- volume mute button 11
- volume up button 12

W

- webcam 8

- webcam light 8
- webcam module
 - removal 78, 79
 - spare part number 27, 36, 78, 79
- Windows applications key 12
- Windows logo key 12
- wireless antenna
 - disconnecting 55, 57
 - location 8
- wireless button 11
- wireless light 14
- wireless module compartment 18
- wireless module compartment cover
 - illustrated 30
 - removal 55
- wireless, product description 3
- WLAN antenna
 - disconnecting 55
 - location 8
- WLAN module
 - removal 53
 - spare part numbers 24, 32, 33, 53
- workstation guidelines 40
- WWAN antenna
 - disconnecting 57
 - location 8
- WWAN module
 - removal 57
 - spare part numbers 25, 32, 57