

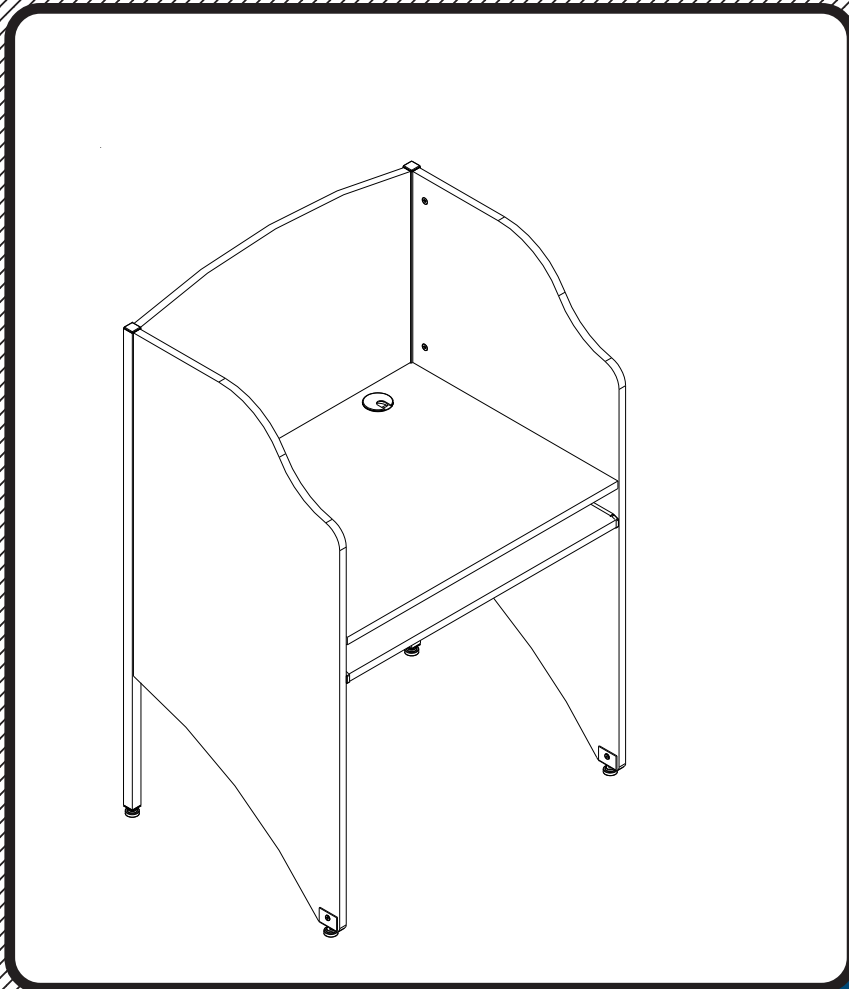











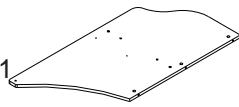

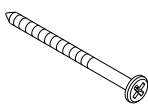

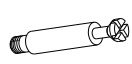
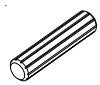
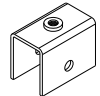

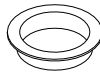

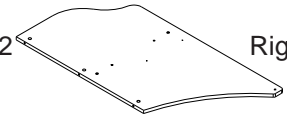
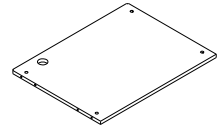
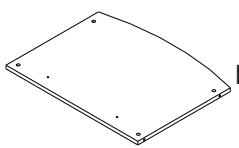
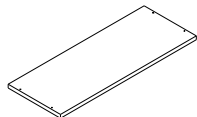
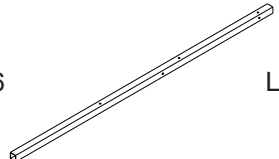
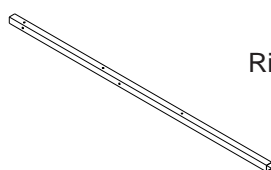
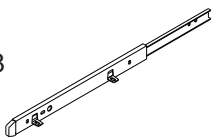
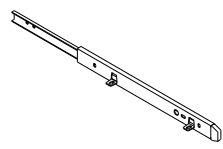
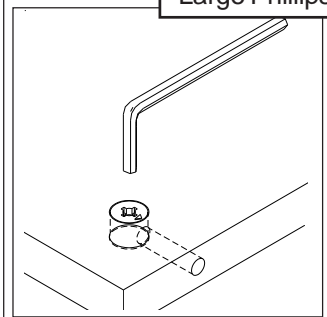
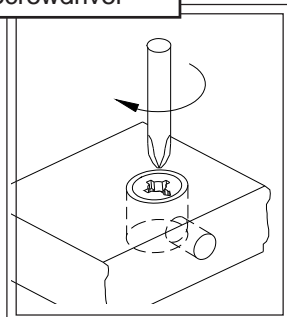

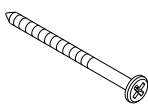

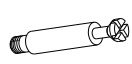
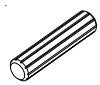
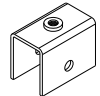

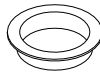
#89868 Single Floor Carrel

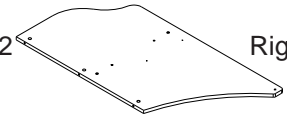
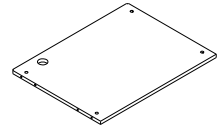
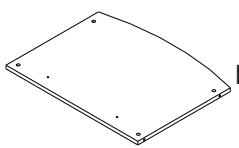
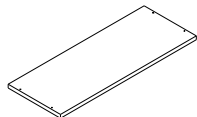
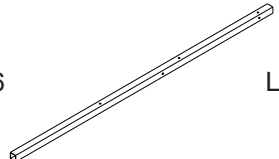
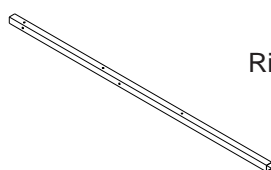
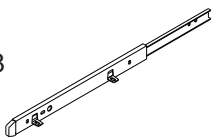
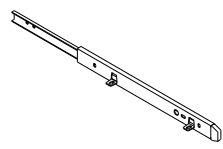
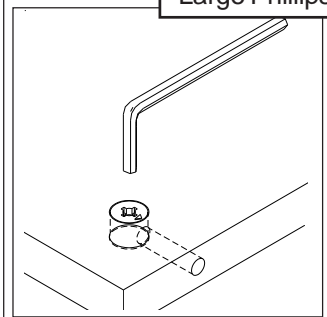
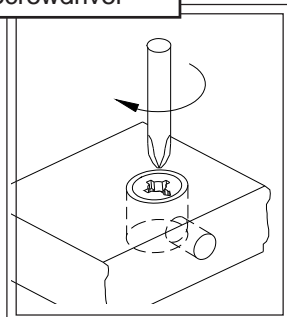
Teak HP Laminate

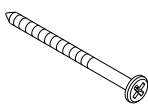

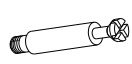
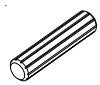
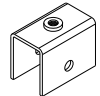
Assembly Instructions

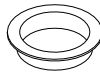
#89868 Single Floor Carrel

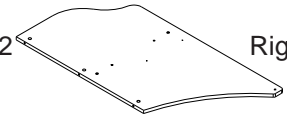
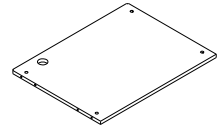
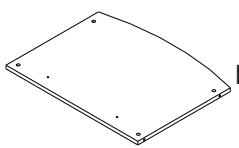
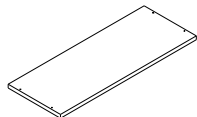
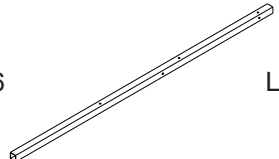
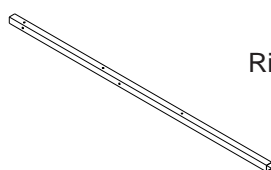
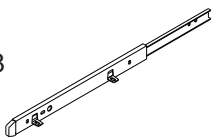
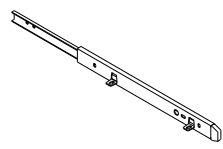
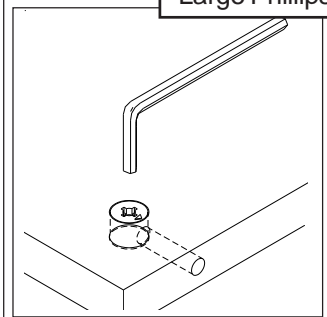
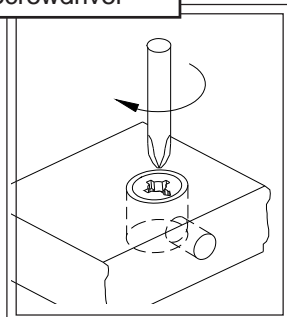
Part	Drawing	Description	Qty	Part	Drawing	Description	Qty																																																																																								
P-1		Left Side Panel	1 EA	<div style="border: 1px solid black; border-radius: 10px; padding: 10px;"> <h3 style="text-align: center;">Hardware List</h3> <table style="width: 100%; border-collapse: collapse;"> <tr> <td style="width: 5%;">A</td> <td style="width: 15%;"></td> <td style="width: 60%;">Socket Screw M5X15 mm</td> <td style="width: 20%;">2 EA</td> </tr> <tr> <td>A1</td> <td></td> <td>Wood Screw #6X1/2</td> <td>8 EA</td> </tr> <tr> <td>A2</td> <td></td> <td>Wood Screw #8X1 1/4</td> <td>2 EA</td> </tr> <tr> <td>B</td> <td></td> <td>Interior Threaded Post</td> <td>2 EA</td> </tr> <tr> <td>C</td> <td></td> <td>Cam Lock</td> <td>14 EA</td> </tr> <tr> <td>D</td> <td></td> <td>Cam Post</td> <td>14 EA</td> </tr> <tr> <td>E</td> <td></td> <td>Wood Dowel</td> <td>4 EA</td> </tr> <tr> <td>F</td> <td></td> <td>Glide Bracket</td> <td>2 EA</td> </tr> <tr> <td>G</td> <td></td> <td>Glide</td> <td>4 EA</td> </tr> <tr> <td>H</td> <td></td> <td>Grommet Sleeve</td> <td>1 EA</td> </tr> <tr> <td>J</td> <td></td> <td>Grommet Cap</td> <td>1 EA</td> </tr> <tr> <td>K</td> <td></td> <td>Allen Wrench</td> <td>1 EA</td> </tr> </table> </div> <tr> <td>P-2</td> <td></td> <td>Right Side Panel</td> <td>1 EA</td> </tr> <tr> <td>P-3</td> <td></td> <td>Top Panel</td> <td>1 EA</td> </tr> <tr> <td>P-4</td> <td></td> <td>Back Panel</td> <td>1 EA</td> </tr> <tr> <td>P-5</td> <td></td> <td>Keyboard Panel</td> <td>1 EA</td> </tr> <tr> <td>P-6</td> <td></td> <td>Left Leg</td> <td>1 EA</td> </tr> <tr> <td>P-7</td> <td></td> <td>Right Leg</td> <td>1 EA</td> </tr> <tr> <td>P-8</td> <td></td> <td>Left Keyboard Slide</td> <td>1 EA</td> </tr> <tr> <td>P-9</td> <td></td> <td>Right Keyboard Slide</td> <td>1 EA</td> </tr> <tr> <td colspan="4" style="text-align: center;"> <p>Tools required: Phillips Head Screwdriver</p> </td> <td colspan="4" style="text-align: center;"> <div style="border: 1px solid black; padding: 5px; width: fit-content; margin: 0 auto;"> <p>Note: Camlocks can be turned with Allen Wrench, or Large Phillips Screwdriver</p> </div> <div style="display: flex; justify-content: space-around; margin-top: 10px;">   </div> </td> </tr>				A		Socket Screw M5X15 mm	2 EA	A1		Wood Screw #6X1/2	8 EA	A2		Wood Screw #8X1 1/4	2 EA	B		Interior Threaded Post	2 EA	C		Cam Lock	14 EA	D		Cam Post	14 EA	E		Wood Dowel	4 EA	F		Glide Bracket	2 EA	G		Glide	4 EA	H		Grommet Sleeve	1 EA	J		Grommet Cap	1 EA	K		Allen Wrench	1 EA	P-2		Right Side Panel	1 EA	P-3		Top Panel	1 EA	P-4		Back Panel	1 EA	P-5		Keyboard Panel	1 EA	P-6		Left Leg	1 EA	P-7		Right Leg	1 EA	P-8		Left Keyboard Slide	1 EA	P-9		Right Keyboard Slide	1 EA	<p>Tools required: Phillips Head Screwdriver</p>				<div style="border: 1px solid black; padding: 5px; width: fit-content; margin: 0 auto;"> <p>Note: Camlocks can be turned with Allen Wrench, or Large Phillips Screwdriver</p> </div> <div style="display: flex; justify-content: space-around; margin-top: 10px;">   </div>			
A		Socket Screw M5X15 mm	2 EA																																																																																												
A1		Wood Screw #6X1/2	8 EA																																																																																												
A2		Wood Screw #8X1 1/4	2 EA																																																																																												
B		Interior Threaded Post	2 EA																																																																																												
C		Cam Lock	14 EA																																																																																												
D		Cam Post	14 EA																																																																																												
E		Wood Dowel	4 EA																																																																																												
F		Glide Bracket	2 EA																																																																																												
G		Glide	4 EA																																																																																												
H		Grommet Sleeve	1 EA																																																																																												
J		Grommet Cap	1 EA																																																																																												
K		Allen Wrench	1 EA																																																																																												
P-2		Right Side Panel	1 EA																																																																																												
P-3		Top Panel	1 EA																																																																																												
P-4		Back Panel	1 EA																																																																																												
P-5		Keyboard Panel	1 EA																																																																																												
P-6		Left Leg	1 EA																																																																																												
P-7		Right Leg	1 EA																																																																																												
P-8		Left Keyboard Slide	1 EA																																																																																												
P-9		Right Keyboard Slide	1 EA																																																																																												
<p>Tools required: Phillips Head Screwdriver</p>				<div style="border: 1px solid black; padding: 5px; width: fit-content; margin: 0 auto;"> <p>Note: Camlocks can be turned with Allen Wrench, or Large Phillips Screwdriver</p> </div> <div style="display: flex; justify-content: space-around; margin-top: 10px;">   </div>																																																																																											

#89868 Single Floor Carrel

Assembly Diagram

Illustration # 1

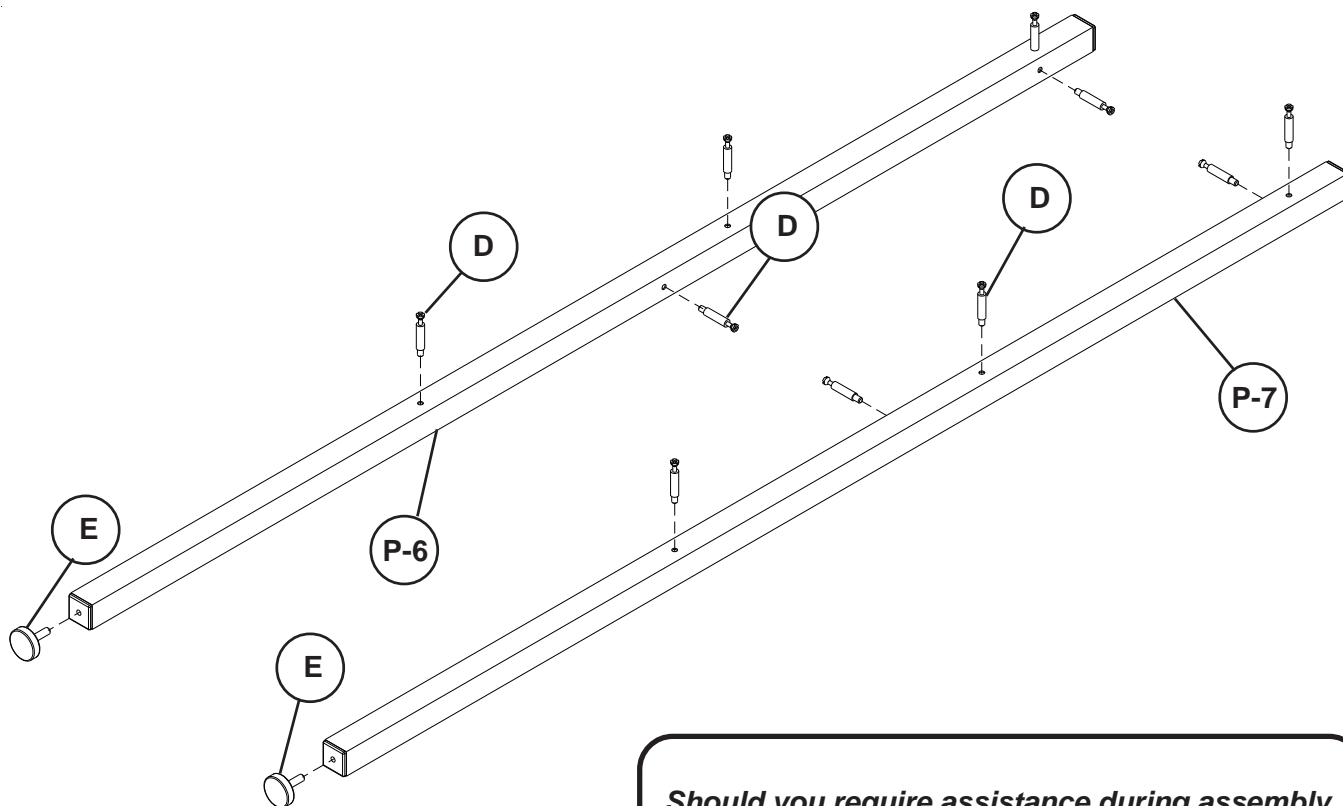

***Should you require assistance during assembly,
please call our Customer Service Department
Monday - Friday 8 a.m. - 5 p.m.
Central Standard Time
Toll-Free Customer Service
1-800-749-2258***

To Assemble:

1. Identify and Separate all the Parts and Hardware.
2. Place the Left Leg (P-6) and Right Leg (P-7) with the three threaded holes facing up.
Install 5 Cam Posts (D) in each Leg as shown in illustration # 1.
3. Install 1 Leveling Glide (G) in the bottom of each leg as shown in illustration # 1.
4. Tighten Cam Posts (D) using Phillips Screwdriver.

Do not use unless all screws are tight. At least every six months, check all screws to be sure they are tight. If parts are missing, broken, damaged, or worn, stop use of the product until repairs are made by your dealer using factory authorized parts.

5. Place the Left Side Panel (P-1) with the Predrilled holes facing up and install 2 each Cam Posts (D) in the 2 threaded insert nuts (Pre-installed) as shown in illustration # 2.

6. Install 2 each Dowels (E) into the holes as shown in illustration # 2.

7. Attach Left Side Panel (P-1) to Left Leg (P-6) as shown in illustration # 2. Secure by turning the Cam Locks (C) 1/4 turn until they lock.

8. Attach Left Keyboard Slide (P-8) to the Left Side Panel (P-1) using 2 each Screws (A1) as shown in illustration #2.

9. Attach 1 Glide Bracket (F) using 1 Socket Screws (A) and 1 Interior Threaded Posts (B) as shown in illustration #2. Tighten Screws using Phillips Screwdriver.

10. Insert 1 Glide (G) into the Glide Bracket (F) as shown in illustration #2.

Be sure that arrow on top of Camlock (C) aligns with centerline of Edge Drilled hole.

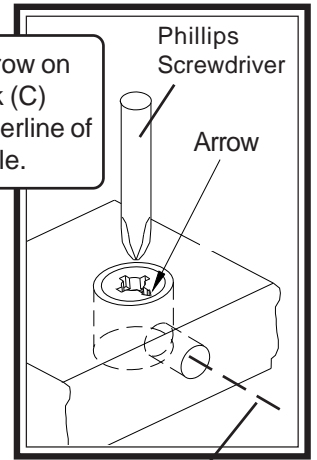

Centerline of Edge Drilled hole.

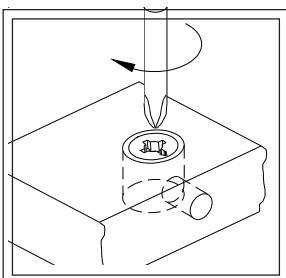
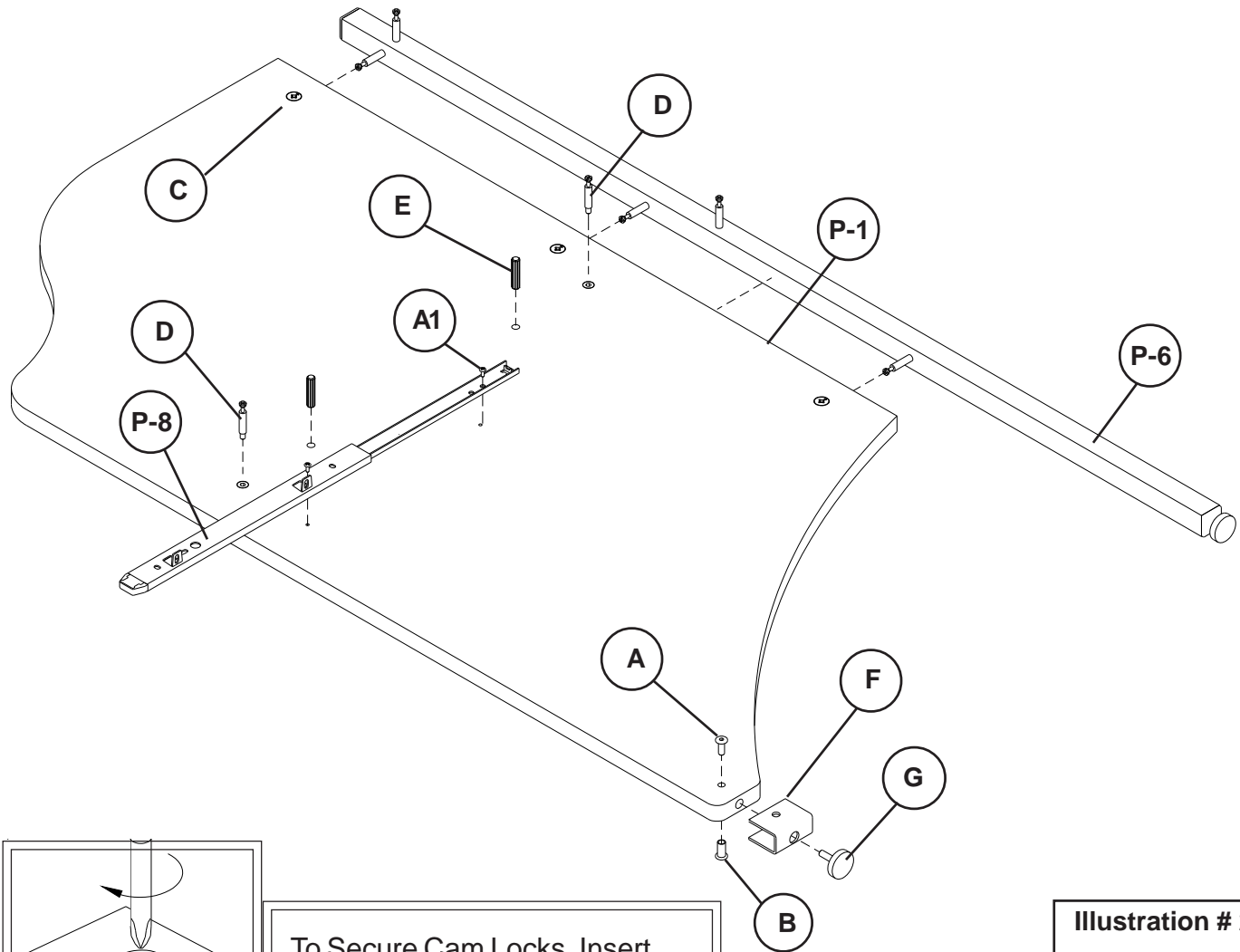

To Secure Cam Locks, Insert Large Phillips Head Screwdriver and turn Cam Lock 1/4 turn (90 degrees) clockwise.

Illustration # 2

11. Place the Right Side Panel (P-1) with the Predrilled holes facing up and install 2 each Cam Posts (D) in the 2 threaded insert nuts (Pre-installed) as shown in illustration # 3.

12. Install 2 each Dowels (E) into the holes as shown in illustration # 3.

13. Attach Right Side Panel (P-2) to Right Leg (P-7) as shown in illustration # 3. Secure by turning the Cam Locks (C) 1/4 turn until they lock.

14. Attach Right Keyboard Slide (P-9) to the Right Side Panel (P-2) using 2 each Screws (B) as shown in illustration #3.

15. Attach 1 Glide Bracket (F) using 1 Socket Screw (A) and 1 Interior Threaded Post (B) as shown in illustration #3. Tighten Screws using Phillips Screwdriver.

16. Insert 1 Glide (G) into the Glide Bracket (F) as shown in illustration #3.

Be sure that arrow on top of Camlock (C) aligns with centerline of Edge Drilled hole.

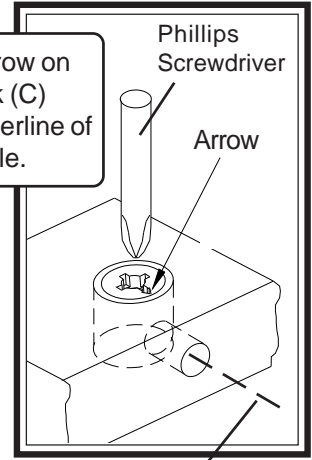

Centerline of Edge Drilled hole.

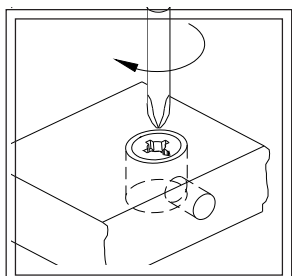
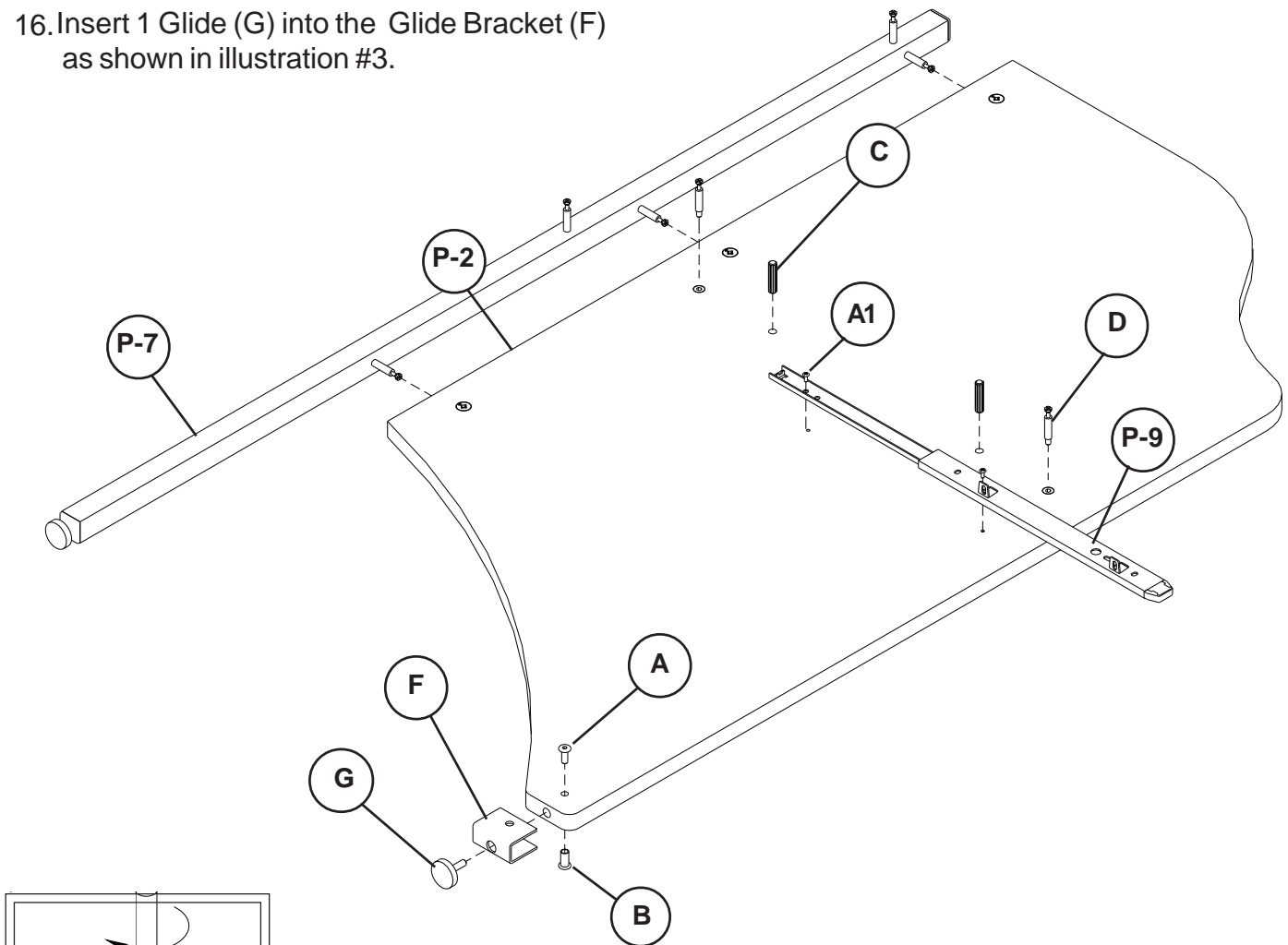

To Secure Cam Locks, Insert Large Phillips Head Screwdriver and turn Cam Lock 1/4 turn (90 degrees) clockwise.

Illustration # 3

17. Slide Top Panel (P-3) over the Wood Dowels (E) and the Camposts (D) in the Left Side Panel (P-1) as shown in illustration #4. Secure by turning the Cam Locks (C) 1/4 turn until they lock.

18. Slide Back Panel (P-4) over the Campost (D) in the Left Leg (P-6) as shown in illustration # 4. Secure by turning the Cam Locks (C) 1/4 turn until they lock.

19. Secure Back Panel (P-4) to Top Panel (P-3) using 2 Wood Screws (A2) as shown in illustration # 4. Tighten Screws using Phillips Screwdriver.

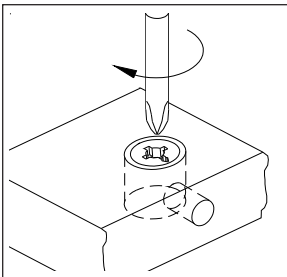

To Secure Cam Locks, Insert Large Phillips Head Screwdriver and turn Cam Lock 1/4 turn (90 degrees) clockwise.

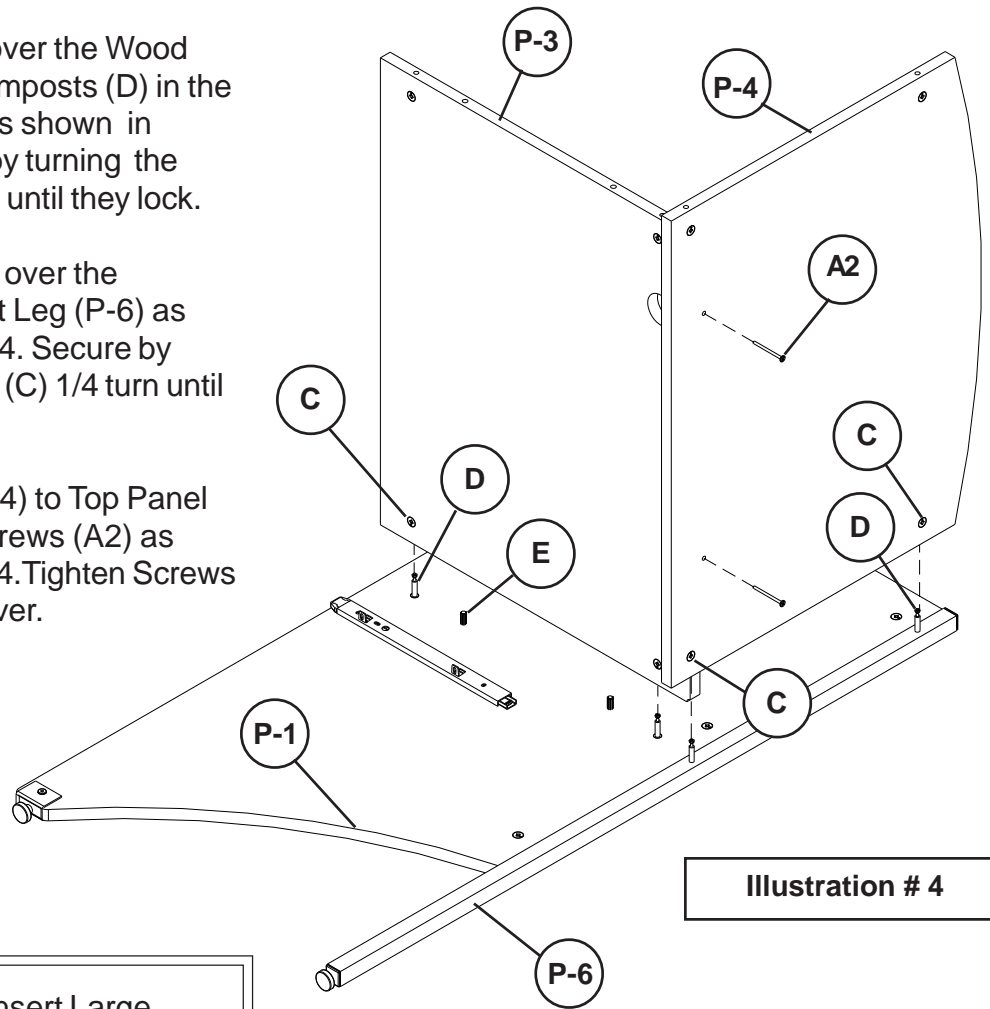

Illustration # 4

20. Attach Right Side Panel (P-2) and Right Leg (P-7) to Top Panel (P-3) and Back Panel (P-4) as shown in illustration # 5.

21. Secure by turning the Cam Locks (C) 1/4 turn until they lock.

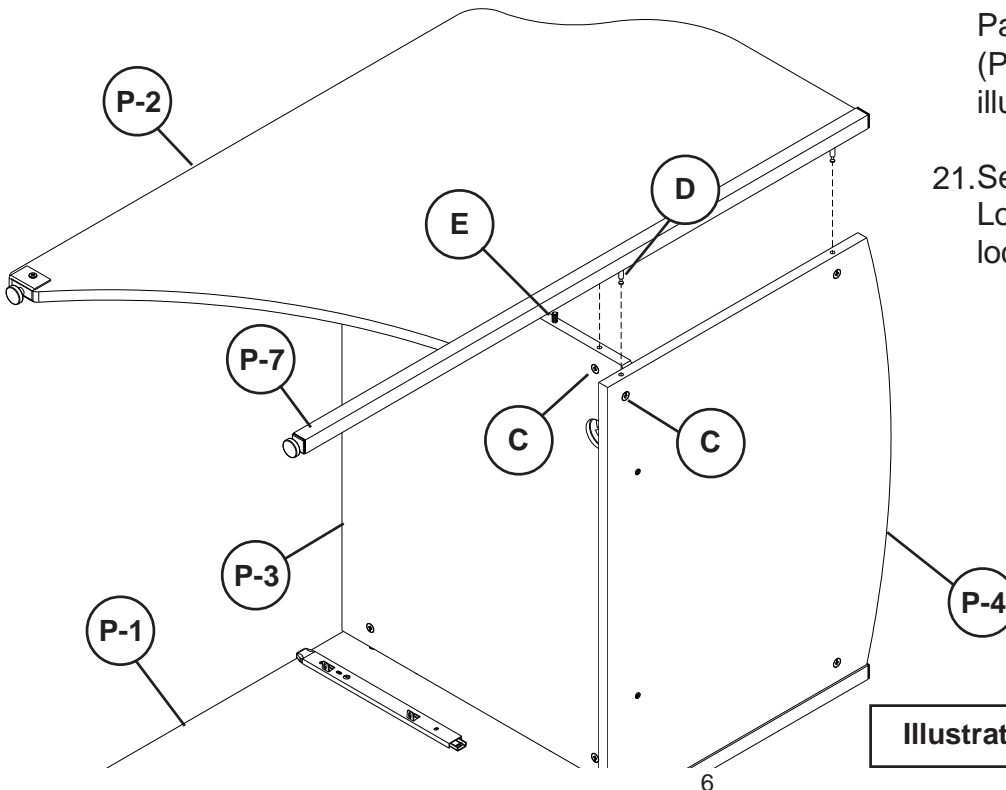
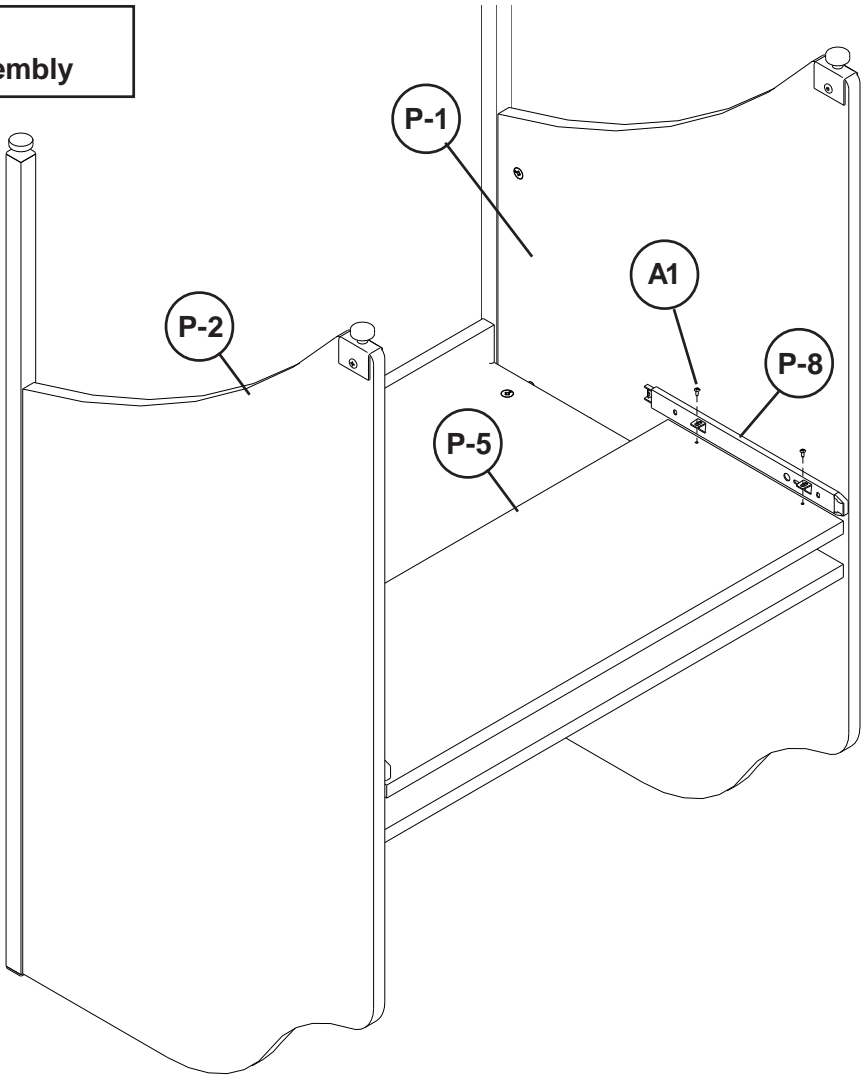

Illustration # 5

**Illustration # 6
Keyboard Slide Assembly**

22. Attach Keyboard (P-5) to Left Keyboard Slide (P-8) and Right Keyboard Slide (P-9) using 4 Wood Screws (A1) as shown in illustrations # 6.

23. Tighten Screws (A1) using Phillips Screwdriver.



To install Grommets:

24. Insert Grommet Sleeve (H) in Round openings in Top Platforms (P-2) as shown in illustration #7.

25. Snap Grommet Cap (J) into Grommet Sleeve (H) as shown in illustration #7.

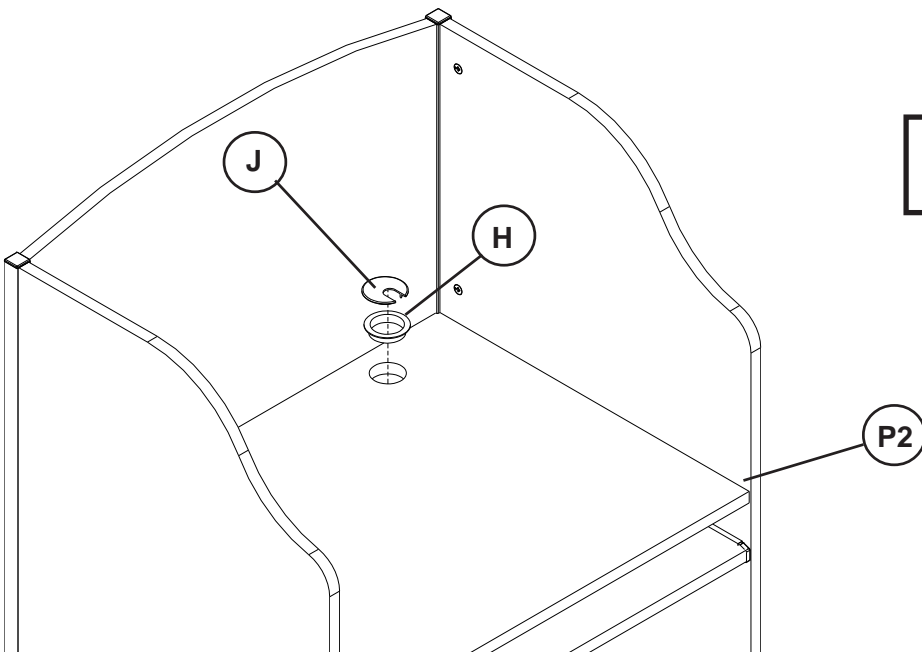

**Grommet(B) installation
Illustration #7**