

**Uniden®** | **GUARDIAN™** 

**UDS655**  
**Wireless Video Surveillance System**

## **CUSTOMER CARE**

At Uniden®, we care about you!

If you need assistance, please do NOT return this product to your place of purchase. Our customer care specialists are available to serve you.

Quickly find answers to your questions by:

1. Reading your owner's manual, included with this product.
2. Visiting our customer support website at [www.uniden.com](http://www.uniden.com).
3. Calling our customer care specialists at 1-817-858-2900 or 1-800-658-8068.

# CONTENTS

<b>Getting Started .....</b>	<b>4</b>
Using This Manual .....	4
What's Included.....	5
Setting Up the Equipment .....	6
Set Up the Camera.....	6
Set Up the Monitor .....	8
Pairing Accessory Cameras to The Monitor .....	9
<b>BASIC OPERATION .....</b>	<b>10</b>
Getting to Know Your Monitor .....	10
Screen icons .....	11
Getting to Know Your Camera.....	13
Basic Operation Rules.....	13
Using your UDS655 .....	14
<b>UDS655 Screen Descriptions .....</b>	<b>16</b>
UDS655 Main Menu Screen .....	16
Camera Setup Screen.....	18
Pair a New Device.....	19
Image Brightness.....	20
Activate/Deactivate.....	21
Recorder Setup.....	21
Record Schedule.....	22
Motion Detection Sensitivity .....	24
Format Storage .....	25
Setup Masking Area .....	25
Event List.....	27
Play Back Recorded File .....	28
Delete Recorded Files.....	29
System Setup.....	29
Date and Time.....	30
TV Output.....	30
Power Saving.....	30
Multi Channel Idle Display .....	31
Default.....	32

Alarm Buzzer.....	33
Pan Tilt Zoom.....	33
Scan Activated Cameras.....	35
Memory Card OverWrite .....	35
<b>SPECIAL FEATURES .....</b>	<b>37</b>
Remote Access.....	37
System Requirements.....	37
Install Uniden Remote Service Software.....	38
Setting up a Portal Account .....	41
Using Remote Access .....	44
Record Video Through the Portal.....	44
Take A Snapshot Through the Portal.....	45
Play Back Recorded Files on Your PC.....	45
View Live Video on TV.....	45
<b>Downloading and Using the Apps .....</b>	<b>47</b>
Android™.....	47
Download .....	47
App Operation .....	48
iPhone®.....	49
Download .....	49
App Operation .....	50
<b>Maintaining Your System .....</b>	<b>52</b>
Upgrading your Uniden UDS655 Firmware .....	52
Taking Care of Your Hardware.....	52
Receiver.....	52
Cameras.....	52
<b>Solving Problems.....</b>	<b>53</b>
<b>Specifications.....</b>	<b>56</b>

Uniden surveillance products are not manufactured and/or sold with the intent to be used for illegal purposes. Uniden expects consumer's use of these products to be in compliance with all local, state and federal law. For further information on video surveillance and audio recording legal requirements, please consult your local, state and federal law.

© 2013. All rights allowed by law are hereby reserved.

# GETTING STARTED

## USING THIS MANUAL

This manual is set up in seven sections:

- Getting Started. This section lists the hardware that should have been in your box and how to physically set it up. If any items are missing or damaged, contact our Customer Care Line immediately (817-858-2929 or 800-297-1023).
- Basic Operations. This section describes your equipment's function keys in detail. It also provides a list of basic operations in an abbreviated format, referencing screen details in the third section.
- Uniden UDS655 Screen Descriptions. Here you will find detailed descriptions of each screen and how it is used.
- Special Features. This section tells you about the UDS655 special features, such as how to connect your surveillance system to the internet and access it from your PC or other wired/wireless devices.
- Downloading and Using the Apps. Here you will find instructions for downloading the Uniden Guardian app for Android based smartphones and iPhones and how to use them with your system.
- Maintaining Your System. This section provides tips on how to keep your UDS655 hardware clean and in excellent working condition.
- Solving Problems - Troubleshooting tips are located here.
- Specification - This last section contains hardware and software specifications.

***If any items are missing or damaged, contact our Customer Care Line immediately.  
Never use damaged products!***

## WHAT'S INCLUDED

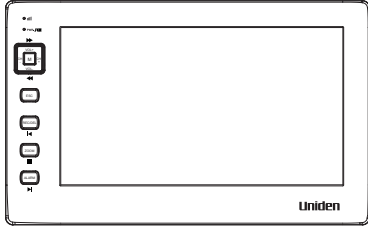

7" LCD Digital Wireless Monitor  
(1)

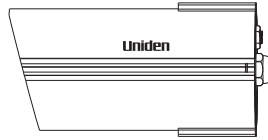

Digital Wireless Camera (2)



Camera Antenna (2)

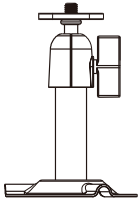

Camera Stand (2)



5V/1A Power Adaptor for  
Monitor / Camera (1)

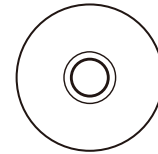

Uniden Media Player and  
Remote System software CD (1)



A/V Cable

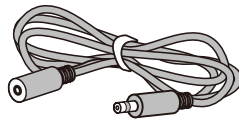

Extension Cable for Camera  
Adaptor (2)

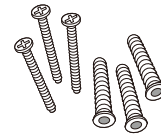

Screw Bag (1)



4GB microSD™ Card and  
Adapter (1 each)

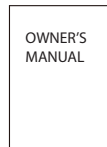

Manual (1)



USB cable

# SETTING UP THE EQUIPMENT

## Set Up the Camera

### *General Placement Guidelines*

The Uniden UDSC15 cameras included with your monitor are weatherproof and have an IP66 weather rating. Water can be sprayed on them and they will still work; however, the cameras cannot be submerged underwater.

Although the cameras can be exposed directly to the rain, it is recommended that, if they are used outdoors, they be mounted under some type of cover like a patio overhang or eave. As rainwater drops start to dry on the camera glass, it can create spots that will reflect the light from the infrared LEDs used for night vision, thus causing lower quality video.

Also, as dust, grime, and cobwebs accumulate on the camera glass, they can reflect light from the infrared LED and might lower video quality. Periodically clean the lens glass with a soft cloth.

Consider the following when placing cameras:

- Clear line of sight video transmission distance is up to 500 ft.
  - Walls, especially brick and concrete, shorten the transmission distance.
  - Placement next to windows allows better transmission.
- Avoid having a direct light source in the view of the camera, including street lights, ceiling or floor lamps, spotlights in the driveway, etc.
- The cameras are equipped with built-in infra-red LEDs so you can use night vision for 24-hour surveillance. The LEDs will automatically activate at night and the picture viewed will turn to black and white. The night viewing range is up to 40 ft. Avoid pointing the camera lens directly at clear glass; the night vision LEDs will cause a blurred image.
- Optimized motion detection range is 6 - 18 feet for the UDSC15 camera. The farther away an object is, the less accurate the motion detection.

- Avoid pointing the camera directly at any bushes, tree branches, or moving objects that might naturally move due to winds. Otherwise, the motion detection feature may record unnecessarily.

You can mount the camera with the stand on the bottom (on a flat surface such as a table-top), on the side (on a wall), or on the top (on the ceiling). When you are positioning the camera, you might want to bring the monitor along; it's much easier to get the camera into the right position when you have the display handy.

### *Mount the Camera Base*

The following tools are required:

- Electric Drill
  - 5mm Drill Bit
  - 15mm Drill Bit
  - No. 2 Philips Screwdriver
1. Hold the base of the camera stand where you want to mount it and mark the location of the screw holes.
  2. Use the included screws and anchors to attach the base to the wall or ceiling. You can also screw the base into a flat surface such as a tabletop if needed.
  3. Before attaching the camera, tug gently on the stand to make sure it is securely in place.

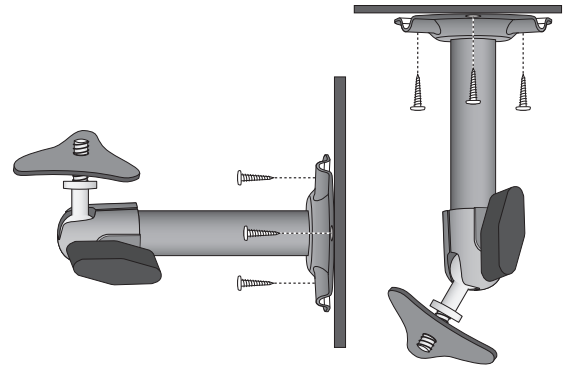

## Attach the camera

1. For each camera, attach the camera bracket to the mounting screw. You can attach the stand to the top or the bottom of the camera as needed. Tighten it a few turns, then turn the camera to face the direction you want.
2. Tighten the camera brace up against the camera to secure it into place.
3. Unlock the mounting post by turning the wingnut to the left a few turns.
4. Set the mounting post to the correct angle, then tighten the wingnut until the post is locked into place.
5. Attach the antenna to the rear of the camera.
6. Connect one end of an AC adapter to the camera's power pigtail and plug the other end into a 120 volt AC (standard indoor) power outlet. (If necessary, connect the extension cord to the camera's pigtail and connect the AC adapter to the extension cord.)

***Be sure the power plug and the connector are tightly twisted together to avoid water leaking in.***

7. Make sure the Power status light turns on. If it doesn't, try reconnecting the AC adapter, and make sure the power outlet isn't controlled by a wall switch.

## Set Up the Monitor

1. Remove the protective plastic from the monitor screen.
2. Flip out the stand on the back of the monitor and extend the antenna.
3. Connect an AC adapter to the power input on the side of the monitor.

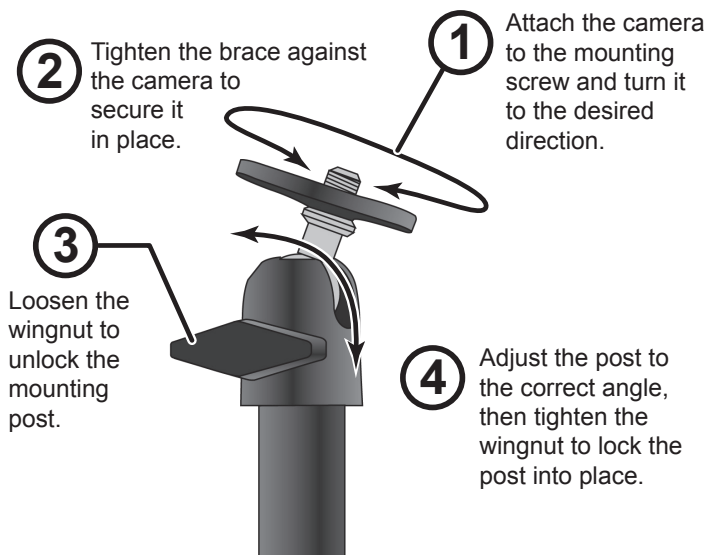



4. Connect the other end of the adapter to a 120 volt AC (standard indoor) power outlet.
5. Press and hold the **POWER** button on the top of the monitor for 1 - 2 seconds to power it up.

If...	Try this...
there is no camera picture	Verify that the power supply adapter for the camera(s) is plugged in.
the picture quality is poor	Clean the camera lens.
a white image appears at night	The camera's infra-red LED shines invisible light that reflects off surfaces such as glass, causing white light. Place the camera on the other side of windows with the lens flush against the surface to improve the night vision, or place the camera in a well-lit area.

6. The monitor displays the Uniden title screen and then displays the LIVE view.
7. After the system powers on, adjust the camera viewing position if needed.

## PAIRING ACCESSORY CAMERAS TO THE MONITOR

The two cameras that come with your UDS655 are paired to your monitor at the factory. If you add cameras, install them and then pair the camera to the monitor.

1. From the main menu, select *CAMERA SETUP* and press **M**. Scroll to the camera number you want to assign to the new camera. Press **M**.
2. Press **CH+** to scroll to the pairing option. Press **M** to pair the camera.
3. Within 30 seconds, press the **PAIRING** button on the camera's power cord.

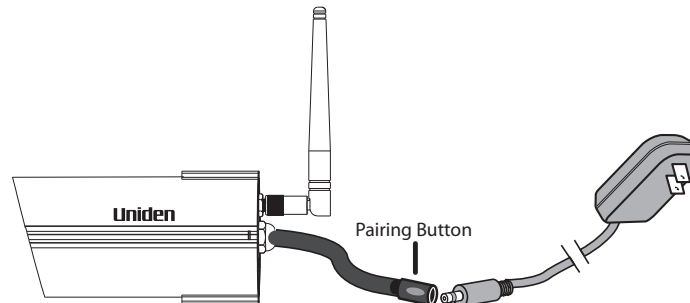

# BASIC OPERATION

## GETTING TO KNOW YOUR MONITOR











Your monitor operates in three modes: M, Playback, and Record. The monitor's keys may operate differently based on what mode it is in.

	Key	M (MENU)	Playback	REC Mode	Other
1					Link LED (Green)
2					Power/Charge LED (Red)
3	Channel Switch (CH-)	Cursor Left	Change Camera (-)		

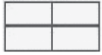
	Key	M (MENU)	Playback	REC Mode	Other
4	Volume - ( <b>VOL-</b> )	Cursor Down	Skip Backward (◀◀)		
5	Volume ( <b>VOL+</b> )	Cursor Up	Skip Forward (▶▶)		
6	Channel Switch + (+)	Cursor Right	Change Camera +		
7	<b>M</b>	Select / Enter	Pause/Play (▶  )		
8	<b>ESC</b>	Esc/Exit/Back	Esc/Exit/Back		
9	Record/Stop ( <b>REC/DEL</b> )		Previous File ( ◀)	Stop	
10	<b>ZOOM</b>		Full Stop (■)		
11	<b>ALARM</b>		Next File (▶ )		
12					Power Button

### Screen icons

Icon	Meaning
	Signal Indicator
	Channel Indicator
	Recording Indicator (Red)

Icon	Meaning
Display Modes 	Quad Display
	Scan Display
	Camera Displayed
	There are seven audio levels.
	Monitor Power Indicator
YYYY-MM-DD AMhh:mm:ss	Date and Time
	In ZOOM mode - Zoom Level Indicator. X1 - Normal view. X2 - Second level of zoom in (X2 Zoom).

## GETTING TO KNOW YOUR CAMERA

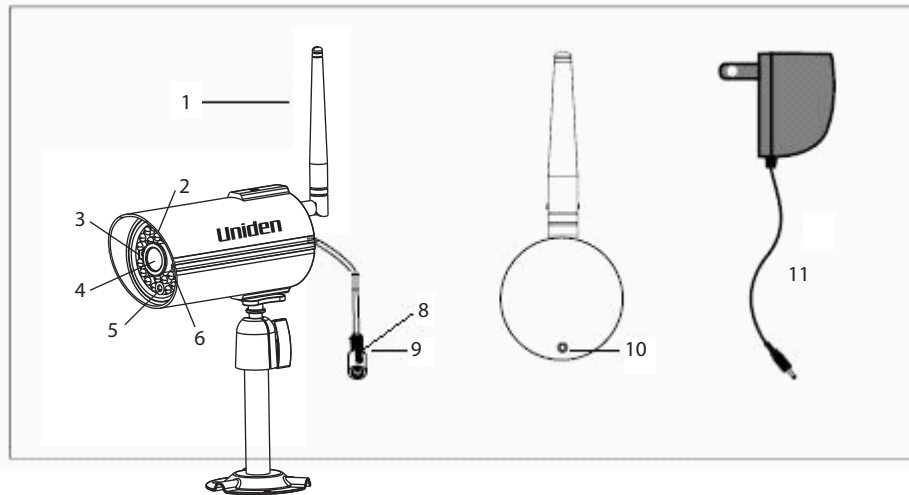

1.	Antenna	5.	Link LED (Green)	9.	Power Jack
2.	Light Level Sensor	6.	IR LED (25)	10.	Microphone
3.	Power LED (Red)	7.	Camera Stand	11.	Power Adaptor
4.	Camera Lens	8.	Pairing Key		

## BASIC OPERATION RULES

- The Pairing LED on the camera will blink once to indicate pairing process has begun and then remain solid to indicate pairing success and data transmission is in progress.
- The UDS655 will return to QUAD mode from any screen after the monitor is idle for two minutes.
- The UDS655 cannot begin recording if the memory card is not inserted.
- After recording begins, it cannot be stopped within the first 15 seconds. Refer to *RECORDER SETUP*, page 22, for details.

- The UDS655 can record in QUAD mode (all 4 channels recorded simultaneously), with each channel in 320 x 240 resolution. If only one camera is turned on (Camera Setup), then the UDS655 records that camera in full screen (640 x 480).
- Press and hold **POWER** for 1 second to turn on the system.
- Press and hold **POWER** for 2 seconds to turn off the system.

## USING YOUR UDS655

To...	Do This
Change from quad view to single view (or back)	With the screen in quad view, press <b>CH+</b> or <b>CH-</b> to cycle your cameras in full view mode. Once all cameras have displayed, the next press takes you back to quad mode.
Manually start recording	Press <b>REC/DEL</b> button. Refer to <i>RECORDER SETUP</i> , page 22, for details.
Set up to record automatically	Refer to <i>RECORDER SETUP</i> , page 22, for details.
Manually stop/cancel recording in Manual or Motion mode	Press <b>REC/DEL</b> .
Manually cancel a Scheduled Record (either future recording or currently recording)	<p>Because this recording block has been pre-set to record for a specific amount of time, you must reset that recording block from Schedule to Manual or Motion Detect.</p> <p>Press REC/DEL after the recording has been going for 15 seconds and quickly (within 5 seconds) press M. The main menu displays.</p> <p>Go to RECORDER SETUP/RECORD SCHEDULE and press M. Select X : MANUAL and press M again. Navigate to the block containing the recording in progress' time frame. Press M until X : MANUAL is selected.</p> <p>Press ESC to back out of the screens.</p> <p>Refer to <i>RECORDER SETUP</i>, page 22, for details.</p>

To...	Do This
Playing back a recording	Select the record to play back ( <i>EVENT LIST</i> , page 27) and press <b>M</b> .
Cancel watching a recorded video	Press <b>ESC</b> . The <i>EVENT LIST</i> screen with video files for a selected date and time displays.
Watching recorded video on PC or television	To view on PC: Either place the memory card in the PC's memory slot or transfer the recorded files from the memory card to the computer.  Uniden Media Player must be installed; it is included on the CD.  To view on TV: Use the AV cable to connect the monitor to the TV (refer to page 37).
Set the date and time	See <i>SYSTEM SETUP</i> , page 29.
Transfer a recording from the monitor's SD card to the computer.	Remove the memory card from the monitor and insert it in an adapter. Insert the SD adapter into your PC. Select a destination to store the files.
Watch live video on your smartphone	See page 45 for details on downloading and using the apps.

# UDS655 SCREEN DESCRIPTIONS

## UDS655 MAIN MENU SCREEN

The UDS655 main menu lets you select from 8 screens to set your system preferences, from camera brightness to setting up and viewing recordings. This section describes the screens in detail. It provides a path to the screen being viewed and operation procedures for that screen.

Press **M** to enter the main menu.

Use **CH+**, **CH-**, **VOL+**, and **VOL-** to scroll through the screen selectons; the title of that screen dispays as you scroll onto it. Press **M** to select that screen.





Screen	Sub Screens	What it Does
<i>CAMERA SETUP</i>	<i>PAIRING</i>	Pairs new cameras to the monitor.
	<i>BRIGHTNESS</i>	Brightens or darkens the video of that camera.
	<i>ACTIVATE OR DEACTIVATE</i>	Makes the cameras visible to the monitor.
<i>RECORD SETUP</i>	<i>RECORD SCHEDULE</i>	Sets up a schedule for pre-determined recording times and lengths.
	<i>MOTION DETECTION SENSITIVITY</i>	Records when something moves in front of the camera. Continues recording for 2, 5, or 10 minutes. Motion detection is on by default.
	<i>FORMAT STORAGE</i>	Formats memory card.
	<i>SETUP MASKING AREA</i>	Masks off areas from motion detection.
	<i>RECORD TIME</i>	Sets the length of recording to 2, 5, or 10 minutes.
<i>EVENT LIST</i>	<i>EVENT LIST</i>	Selects and plays back recorded video.
<i>SYSTEM SETUP</i>	<i>DATE AND TIME</i>	Sets date (year/month/day) and time (hour/minute)
	<i>TV PUTPUT</i>	Sets TV output to PAL or NTSC format. (Default = NTSC)  <b><i>NTSC is the TV standard for North America.</i></b>
	<i>POWER SAVING</i>	Sets the idle time required (5 or 10 minutes) before the system changes to power saving mode. <b><i>ALWAYS ON</i></b> blocks Power Saving mode).
	<i>MULTI CHANNEL IDLE DISPLAY</i>	Sets how the cameras will display during Idle mode (Quad mode or in 5-, 10-, or 15-second display cycles).
	<i>DEFAULT</i>	Sets default language (English, French, or Spanish).

Screen	Sub Screens	What it Does
<i>ALARM BUZZER</i>	NA	You can set the alarm buzzer to sound when movement triggers a motion sensitive recording. Set it to ON or OFF.  <b><i>The SD card must be inserted and have sufficient space for the alarm buzzer to operate.</i></b>
<i>PAN TILT ZOOM</i>	NA	Zooms in and adjusts the viewing area
<i>SCAN ACTIVATED CAMERA</i>	NA	Activates SCAN mode.
<i>MEMORY CARD OVERWRITE</i>	NA	Allows the oldest files to be deleted when you want to record but the memory card is full.

## CAMERA SETUP SCREEN

From this selection on the main menu -



This screen should display:

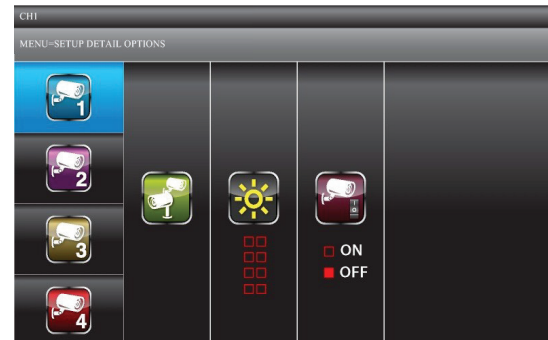

The *SETUP DETAIL OPTIONS* screen has three options:

- Pair a New Device
- Image Brightness
- Activate or Deactivate

## Pair a New Device

Your cameras are paired to the monitor at the factory to channels 1 and 2. You can add up to 2 more accessory cameras to your system; see our website at [www.uniden.com](http://www.uniden.com) for more information on how to buy accessory cameras for this system. When you add an accessory camera, you have to pair it to the monitor (that is, you have “introduce” the camera and monitor so they can communicate).

*Some things to know about pairing cameras:*

- If a camera is already assigned to the selected channel, the monitor overwrites that camera link with the new one.
  - Only pair one camera at a time! The monitor links to the first camera it detects. If two or more cameras are in pairing mode, you can't control which camera the monitor will detect first.
1. From the *SETUP DETAIL OPTONS* screen, use **VOL+** and **VOL-** to select the camera being added. Press **M**. The *PAIR A NEW DEVICE* screen highlights the Pairing selection.



2. Press **M** again to begin camera pairing.

3. Quickly (within 30 seconds) press the **PAIRING** key on the camera cable. The green Pair LED on the selected camera blinks once, pauses, and then stays on to indicate that data transmission is in progress.

*PAIRED* displays on the screen if pairing is successful or *PAIRING FAIL* if it isn't. If Pairing fails, repeat these steps. If Pairing fails again, move the camera and monitor closer together and repeat.

Press **ESC** to back out and return to the main menu or press **VOL+** or **VOL-** to select another camera to pair.

### Image Brightness



1. With the *SETUP DETAIL OPTIONS* screen displayed for a camera, press **CH+** to highlight the Brightness selection.
2. Press **VOL+** or **VOL-** to adjust the camera's brightness; the five levels are OFF, 1 - 4. The default level is 2.
3. Press **M** to accept the new setting and return to the *SETUP DETAIL OPTIONS* screen. Select another camera if needed.

## Activate or Deactivate

This feature "turns off" the camera so it won't be viewed on the monitor. The camera is still powered on, just not visible to the monitor. This feature is useful for viewing a single camera in full screen mode constantly and to record that camera in full screen (640 x 480) resolution.

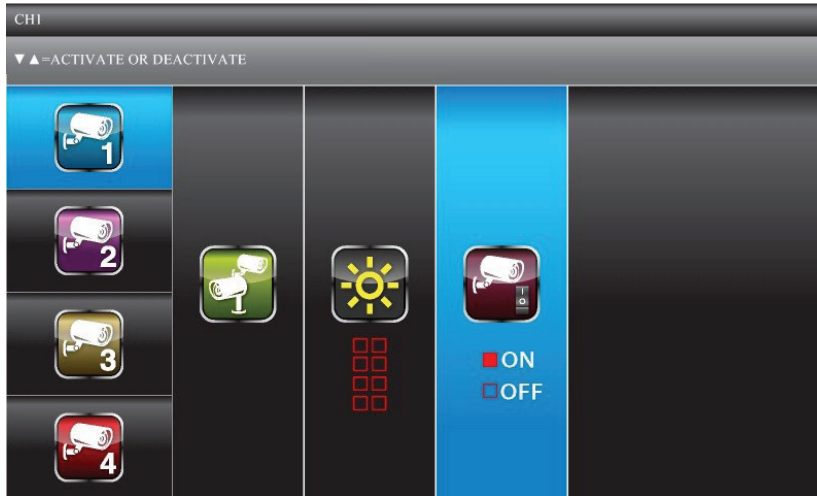

1. With the *SETUP DETAIL OPTIONS* screen displayed for a camera, press **CH+** to highlight the Camera Activation selection.
2. Press **CH+** or **CH-** to activate or deactivate a camera/  
***Cameras not paired to the system cannot be activated.***
3. Press **M** to accept the new setting and return to the *SETUP DETAIL OPTIONS* screen. Select another camera if needed.

## RECORDER SETUP

You can only record if the monitor is in LIVE view and an SD card is inserted.

From this selection on the main menu -



This screen should display:

The RECORD SCHEDULE screen displays a grid of recording options. The first column contains icons for Schedule (S), Motion (M), and Schedule (S). The subsequent columns show recording times in 1-hour blocks.

Icon	AM 12:00	AM 01:00	AM 02:00	AM 03:00
S	X	X	X	X
M	X	X	X	X
S	X	X	X	X
M	X	X	X	X
S	X	X	X	X
M	X	X	X	X
S	X	X	X	X
M	X	X	X	X

The *RECORDER SETUP* screen has five options:

- Record Schedule
- Motion Detection Sensitivity
- Format Storage
- Setup Masking Area
- Motion Record Time

### Record Schedule

*RECORD SCHEDULE* lets you schedule recordings in 1 hour blocks. All active cameras will record; if you only want to record from specific cameras, turn off the other cameras. During LIVE view, audio is only available for camera 1 by default.

Recording options are:

- Motion (M). Select this option if you want the camera to record only when it detects motion.
- Schedule (S). Use this option if you want the cameras to automatically record during a specific hour block.

- Manual (X). Select this option if you want to be able to press the **REC/DEL** to record. You can also use this option when you want to combine recording options for a 24 hour period.

	XAM12:00	XAM01:00	XAM02:00	XAM03:00
	XAM04:00	XAM05:00	XAM06:00	XAM07:00
	XAM08:00	XAM09:00	XAM10:00	XAM11:00
	XPM12:00	XPM01:00	XPM02:00	XPM03:00
	XPM04:00	XPM05:00	XPM06:00	XPM07:00
	XPM08:00	XPM09:00	XPM10:00	XPM11:00

#### *Assign MOTION or SCHEDULE recording mode to all cameras*

- From the main menu, select *RECORDER SETUP*. The *RECORD SCHEDULE* screen displays with the latest camera recording settings.
- Press **M** to show the recording options
- Press **CH+** and **CH-** to highlight either *MOTION* or *SCHEDULE*. Press **M** to select it. All recording blocks now display the recording option abbreviation (*M* or *S*).
- Press **ESC** to back out of those screens.

#### *Combine recording modes*

- From the main menu, select *RECORDER SETUP*. The *RECORD SCHEDULE* screen displays with the latest camera recording settings.
- Press **M** to show the recording options, and then press **CH+** and **CH-** to select *MANUAL*. A blue bar displays at the top of the first hour block. The blue bar indicates you can now navigate to different hour blocks.

3. Press **CH+**, **CH-**, **VOL+**, and **VOL-** to select the hour block you want. Press **M** to change the recording option for that hour block.
4. When you have set the recording option you want, simply navigate to another block.
5. Once you have set the hour blocks as you want them, press **ESC** to back out of the screens.

### **Motion Detection Sensitivity**

This screen lets you adjust how much motion activity will trigger a motion detection. When motion detection is on, the live video view will display an active blue box around the object that triggered the motion event.

1. From the *RECORDER SETUP* screen, press **VOL+** and **VOL-** to select *MOTION DETECTION SENSITIVITY*; press **M** to enter.



2. Press **CH+** and **CH-** to select the camera for motion detection sensitivity adjustment.
3. Press **VOL+** and **VOL-** to adjust sensitivity level – OFF (no box highlighted) / LEVEL 1 (low) / LEVEL 2 (medium) / LEVEL 3 (high).



- When you have finished setting the camera's motion sensitivity levels, press **ESC** to accept the settings and press **ESC** again to back out.

## Format Storage

This feature will delete all data on the microSD card, including recorded files.

- From the *RECORDER SETUP* screen, use **VOL+** and **VOL-** to select *FORMAT STORAGE*; press **M** to select it. *MENU : CONTINUE FORMAT* heading displays.

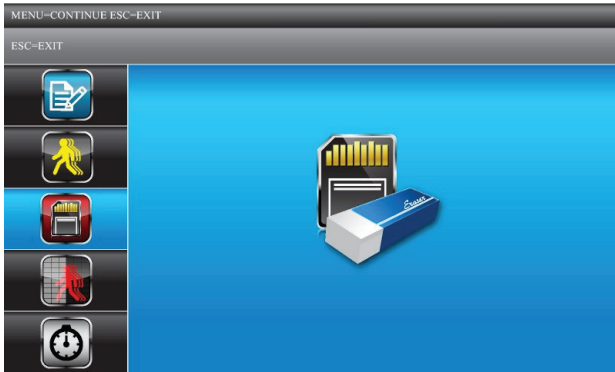

- Press **ESC** to exit or **M** to initiate the memory card format process.
- FORMAT OK* displays when complete. Press **ESC** to back out.

## Setup Masking Area

You can mask off areas in the camera's view where movement in those areas could be normal, but also trigger recording (i. e., bushes and trees).

1. From the *RECORDER SETUP* screen, use **VOL+** and **VOL-** to select *SETUP MASKING AREA*; press **M** to enter. The *SETUP MASKING AREA* screen displays:



2. Use **CH+** and **CH-** to select a camera (1 - 4) for setting up the masking area. Press **M** to enter the camera masking preview page.
3. A grid displays over the image on the screen. While in masking preview, use **CH+**, **CH-**, **VOL+**, and **VOL-** to select the masking block(s) where motion is to be ignored. Press **M** to confirm each selection. You can also press **M** again to unmask a block.
4. Press **ESC** to save the entire mask and return to the previous screen. Mask other cameras as needed.

### **Record Time**

Use *RECORD TIME* to set a specific length of time for motion recording. Options are 2, 5, or 10 minutes.

1. From the *RECORDER SETUP* screen, use **VOL+** and **VOL-** to select *RECORD TIME*; press **M** to select. The *SETUP DETAIL OPTIONS* screen displays.

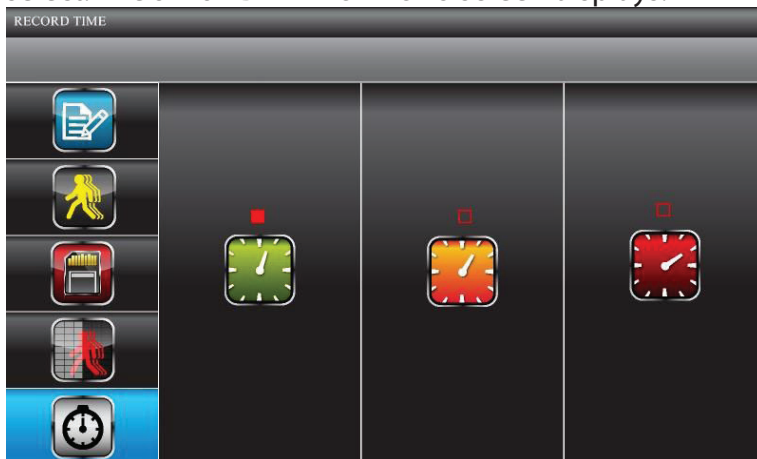

2. Use **CH+** and **CH-** to select either 2, 5, or 10 minutes as the recording time. Press **M** to confirm selection.
3. Press **ESC** to return to the previous screen.

## EVENT LIST

This selection lets you play back recorded files. The *EVENT LIST* screens let you browse through levels of folders for find a specific recorded file for a specific date and hour on a particular day.

***This is the default screen when you access the main menu from any other screen.***

From this selection on the main menu -



This screen should display:

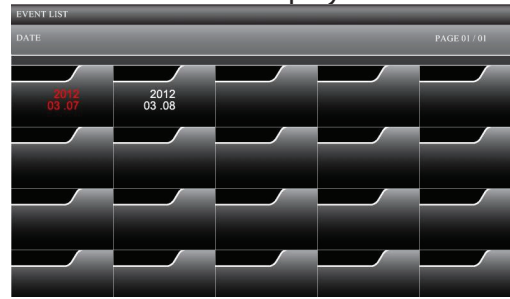

### Play Back Recorded File

1. Use **CH+**, **CH-**, **VOL+**, and **VOL-** to select the *DATE* and *HOUR* folders containing recorded file(s). Press **M** to confirm and enter each file.
2. Use **CH+**, **CH-**, **VOL+**, and **VOL-** to select the recorded file. Each of the recorded file blocks contains detailed information about the recording.

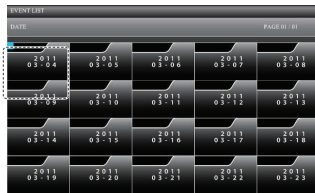

Date screen

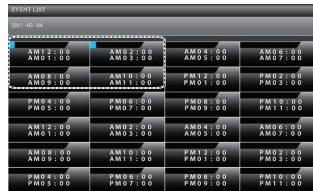

Recorded block screen

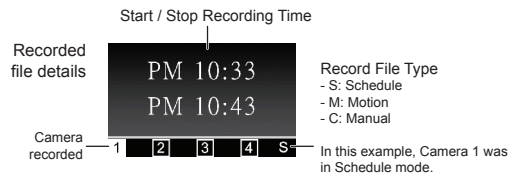

3. Press **M** to begin playback.

- By default, video plays back in QUAD mode. The  icon represents quad mode.

- To play back a single camera on the screen, press **M** once after playback begins to pause playback. Use **CH+** and **CH-** to select the channel for full screen playback. A boxed number icon indicates which camera is in full screen playback mode.

## Delete Recorded Files

You can delete files from Date or Hour folders as well as individual recorded files.

1. Select a folder or individual recorded file. Press **REC/DEL**.
2. **DEL : DELETE** displays. Press **M** to confirm the deletion.

***Schedule and Motion Sensor recordings will function while the system is in playback mode.***

## SYSTEM SETUP

From this selection on the main menu -



This screen should display:



*SYSTEM SETUP* has five subscreens:

- Date and Time
- TV Output
- Power Saving
- Multi Channels Idle Display
- Default

## Date and Time

1. From the *SYSTEM SETUP* screen, use **CH+** and **CH-** to select *YEAR*, *MONTH*, *DATE*, *HOURL*, and *MINUTE*.
2. Use **VOL+** and **VOL-** to scroll through the options for that selection, then **CH+** and **CH-** to make another selection. Press **M** to save the settings when you are finished.

## TV Output

1. From the *SYSTEM SETUP* screen, use **VOL+** and **VOL-** to select *TV OUTPUT*; press **M**. The *TV OUTPUT* screen displays.

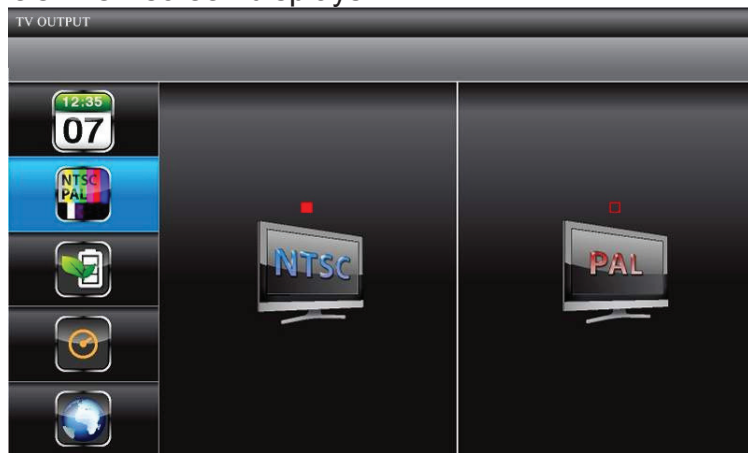

2. Use **CH+** or **CH-** to select *NTSC* or *PAL*; press **M** to confirm. Default = *NTSC*.

***NTSC is the TV standard in North America.***

## Power Saving

Use this setting to determine how long your system will remain in an idle mode until it moves into power saving mode. Power Saving mode turns off the LCD screen to conserve the monitor's battery

or to not have a bright LCD when sleeping. If Power Saving mode is on, motion detection events will turn the LCD screen back on.

1. From the *SYSTEM SETUP* screen, use **VOL+** and **VOL-** to select *POWER SAVING*; press **M**. The *POWER SAVING* screen displays.



2. Use **CH+** and **CH-** to choose between *5 MIN*, or *10 MIN*; the third option is *ALWAYS ON*, which keeps the system from entering Power Saving mode. Press **M** to accept the setting and return to the *POWER SAVING* screen.

### **Multi Channel Idle Display**

This screen lets you decide if the channels will display in quad mode or if they will cycle individually in 5, 10, or 15 second intervals.

1. From the *SYSTEM SETUP* screen, use **VOL+** and **VOL-** to select *MULTI CHANNEL IDLE DISPLAY*; press **M**. The *MULTI CHANNEL IDLE DISPLAY* screen displays.



2. Use **CH+** and **CH-** to choose between *QUAD* and *5, 10, and 15* second intervals. Press **M** to accept the change and return to the *MULTI CHANNEL DISPLAY* screen.
  - The Activate or Deactivate setting (*CAMERA SETUP* screen) affects which cameras display in Scan mode.
  - Audio is available from camera 1 in Quad mode, from whatever camera is a previously viewed channel, or from a channel triggered by motion detection.

### Default

The *DEFAULT* screen gives you the options of selecting a default language. Options are English, French (Français) or Spanish (Espanol).

1. From the *SYSTEM SETUP* screen, use **VOL+** and **VOL-** to select *DEFAULT* and press **M**. The *DEFAULT* screen displays.

***The language selected when setting the DEFAULT will be the system language after any system restoration.***



2. Use **CH+** and **CH-** to choose between English, French (Français), or Spanish (Español). Press **M** to confirm and back out.

The *DEFAULT* screen will also alert you when it detects a new firmware upgrade on the SD card. Go to page 52 for details.

## ALARM BUZZER

You can set the alarm buzzer to go off when a camera detects motion and begins recording.

1. From the main menu, use **CH+**, **CH-**, **VOL+**, and **VOL-** to select *ALARM BUZZER*.



2. Press **M** to toggle the setting between *ON* and *OFF*.

## PAN TILT ZOOM

This setting lets you change the orientation of the camera (pan and tilt) and the zoom distance.



1. From the main menu, use CH+, CH-, VOL+, and VOL- to select PAN TILT ZOOM and press M. The first camera displays in single camera mode.
2. Press **ZOOM**. The camera zooms into Level 1. Press **ZOOM** again to zoom into Level 2. (Sample actually goes into QUAD mode, then press **ZOOM** and into camera 1.)
3. Press **CH+** and **CH-** to pan the camera from left to right and back or **VOL+** and **VOL-** to tilt the camera up and down.
4. Press **ESC** to return to the the main menu.

***The system will exit Zoom mode after it is idle for 2 minutes.***

## SCAN ACTIVATED CAMERAS



1. From the the main menu, press **CH+**, **CH-**, **VOL+**, and **VOL-** to select *SCAN ACTIVATED CAMERAS* and press **M** to enter Scanning mode.
2. The screen scans between the cameras according to the scan time set up in the *MULTI CHANNELS IDLE DISPLAY* screen (refer to page 31).

***If a recording session started during SCAN mode (Schedule or Motion recording), the system resumes display in quad mode.***

## MEMORY CARD OVERWRITE

Turning on Memory Card Overwrite allows you to overwrite the oldest files when your memory card is full. If you turn this function off, an error message displays when you have no more room to save files.

1. From the main menu, press **CH+**, **CH-**, **VOL+**, and **VOL-** to select *MEMORY CARD OVERWRITE* and press **M**.



2. Press **M** again to toggle the overwrite setting between *ON* and *OFF*. Press **M**. The system overwrites the oldest files first. The system displays the following SD card detail information.

- SD card available storage space
- If no space is available, 0.00GB displays.
- Error indicator displays if:
  - SD card not present
  - SD card is locked.
  - SD card is unformatted
  - SD card is damaged.

***Please use well-known brands of micro SD cards to avoid operation errors. The UDS655 supports up to 32GB microSD cards.***

## SPECIAL FEATURES

This section provides Remote Access requirements and software installation, setup, and usage procedures for accessing your live feeds from a number of wired and wireless devices. It also provides information on other special features such as:

- Recording video and taking pictures through the Portal account
- Viewing live video on TV
- Playing back recorded files on a PC

### REMOTE ACCESS

The Uniden USD655 let you view live video from your system on your television or PC (home or remote) or on wireless devices such as an iPhone®, iPad®, or Android™ smartphone or tablet. A free Uniden Guardian app is available through the iTunes® App Store or the Android Market. You can also view your recorded video files on any PC with Uniden Media Player installed.

The Uniden Remote System software CD in your kit provides the software you need to install. You will also need to set up a Uniden Portal account. Multiple user accounts on your PC can access live video on their accounts through the Portal account as long as they have the Device ID (DID) code and security code to log in and you have specified that the Portal can provide access to multiple users on that PC when you set up the account.

***The number of remote viewers is determined by the amount of “available upload bandwidth” on your home network. Each remote viewer requires ~350kbps of bandwidth on the network.***

#### System Requirements

- Microsoft® Windows XP, Vista, or Windows 7

***Uniden Remote Service software operates in a Windows environment only.***

- Internet Explorer® 8 or greater.

- iPhone® or
- iPad® or
- Android™ smartphone or tablet

## Install Uniden Remote Service Software

1. Insert the UDS655 Remote Software CD in your PC's CD ROM.
2. Select Uniden Remote Service and double-click to install.
3. The *WELCOME* window appears. Click *NEXT* to select an installation folder.
4. The default folder is located at C:\Program Files\. If you want to store it in a different installation location, click *BROWSE*. When you have selected an installation location, click *NEXT* to proceed.

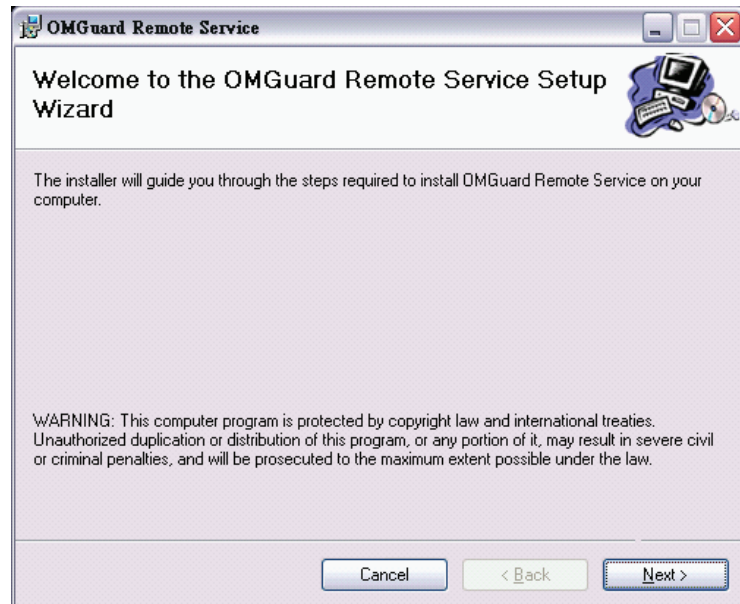

**If the computer has more than one user account that needs to access the video feed, select EVERYONE; otherwise, select JUST ME.**

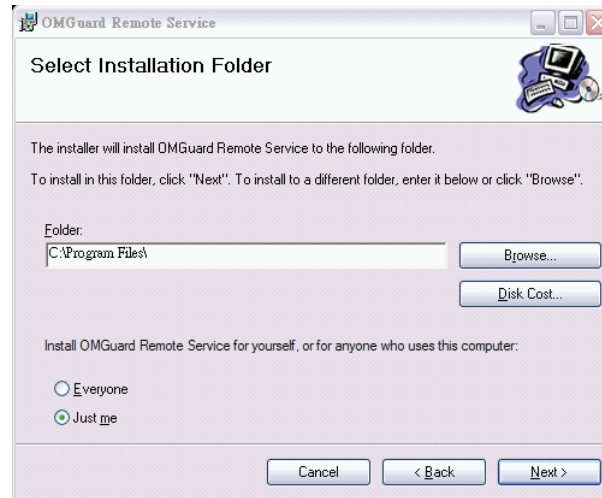

5. The *CONFIRM INSTALLATION* screen displays. Click *NEXT* to begin installing the software. A progress bar displays.

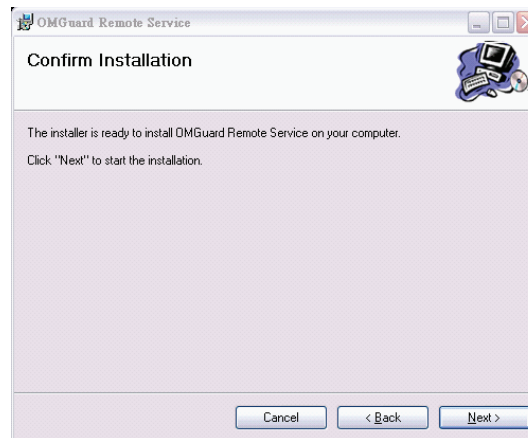

- The *INSTALLATION COMPLETE* screen displays when the software is installed. Click *CLOSE* to leave the Installation wizard.

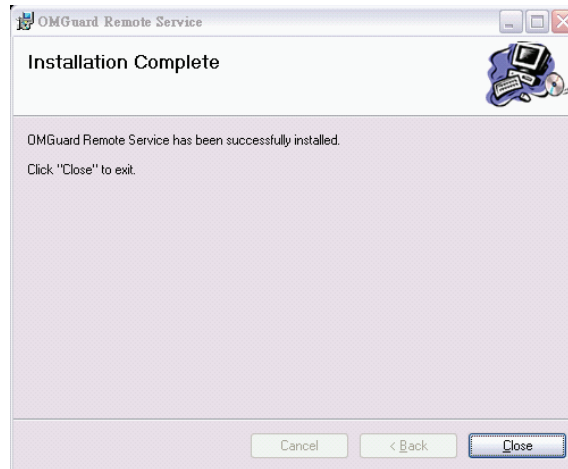

- Turn on the UDS655 monitor and connect it to the PC using the USB cable.
- A *NEW HARDWARE FOUND INDICATOR* appears on the lower right-hand side of the PC screen.
- Click *START* to activate OMGuard Remote Service. The *OMGUARD SETUP* screen displays.

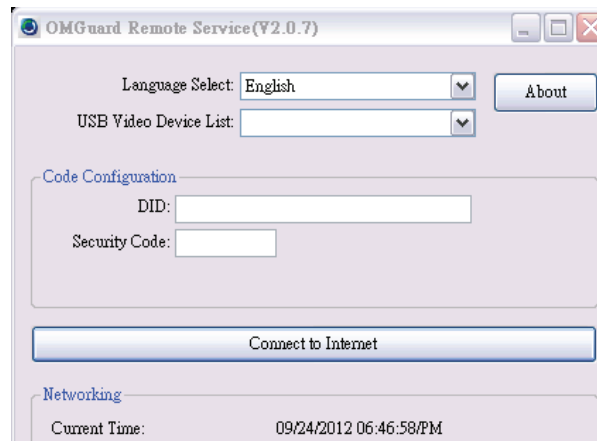



10. Select or enter the following:

- Display language (Default = English).
- USB 2.0 Camera (from USB Video Device dropdown list)
- DID Code (located on the back of the monitor)
- Security Code (The default security code is 12345.)

***You can set up a different security code at this time, but be sure and use that code when you're using the app and setting up a Portal account. You can enter up to 8 numeric digits.***

11. Click *CONNECT TO INTERNET*.

### Setting up a Portal Account

***Be sure you have the security code set up through Uniden Remote System software installation. This is required for remote access to your UDS655 system.***

1. Go to <http://www.unidenvideo.com>.
2. Click *ADD NEW ACCOUNT*. The *LEGAL AGREEMENT* displays.
3. Read and agree to the Legal Agreement.

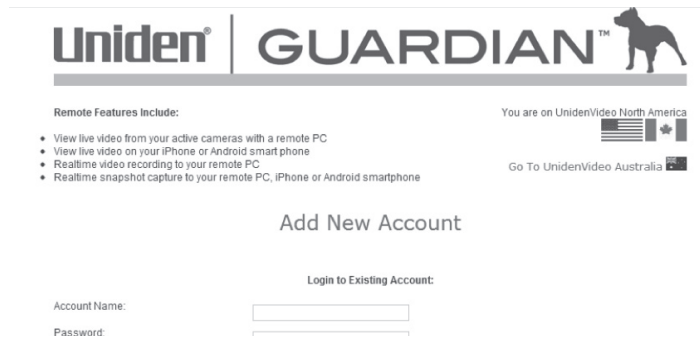

The screenshot displays the Uniden Guardian web interface. At the top, the logo for Uniden Guardian is shown, featuring a dog silhouette. Below the logo, there are two columns of text. The left column, titled "Remote Features Include:", lists four bullet points: "View live video from your active cameras with a remote PC", "View live video on your iPhone or Android smart phone", "Realtime video recording to your remote PC", and "Realtime snapshot capture to your remote PC, iPhone or Android smartphone". The right column, titled "You are on UnidenVideo North America", shows flags for the United States and Canada, with a link "Go To UnidenVideo Australia" and the Australian flag below. In the center, the text "Add New Account" is displayed. Below this, there is a section titled "Login to Existing Account:" with two input fields: "Account Name:" and "Password:".

The *ACCOUNT SETUP* screen displays

4. Enter *ACCOUNT NAME* (1).
5. Enter a *PASSWORD* (2).
6. Enter it again to *VERIFY PASSWORD* (3).
7. Complete all required fields (4).
8. Click in the check box (5) to receive information on firmware updates and news. We recommend you check this box to receive updates.
9. Click in the check box (6) to receive information on special offers from Uniden.
10. Click *SUBMIT* (7). The *NEW ACCOUNT CREATED* screen displays.
11. Click *CONTINUE*. The *VIDEO SYSTEM REGISTRATION* screen appears.
12. Provide a *DEVICE NICKNAME* (1).
13. Select your retailer from the list (2).



Account Setup:

\*Account name:  1

\*Password:  2  
(Choose at least 6 letters or numbers)

\*Verify Password:  3

\*Address:

\*City:

\*State: --SELECT STATE/PROVIN-- 4

\*Zip:

\*Country:

\*Phone:

\*Email:

Please notify me of Uniden Guardian firmware updates and news:  5

Receive special offers from Uniden.com:  6

7

\* Required



Video System Registration:

\*Device Nickname:  1

Retailer: Uniden.com  2

Please Select Your Model:

## Select Your Model/Enter the DID Code

1. The *VIDEO SYSTEM REGISTRATION* screen displays. Select *UDS655*.
2. Click the radio button by your system (3).
3. Enter the DID code in all capital letters (4).
4. Click *CONTINUE* (5).

Uniden® GUARDIAN™

Video System Registration:

\*Device Nickname: UDS655Home      Retailer: Other

Please Select Your Model:

Guardian Series:

(UID can be found on the network information page on your monitor.)

G455      UID

(Please use upper case letters for UID code)

OR

(DID can be found on the network information page on your monitor.)

G755      DID  4

(Please use upper case letters for DID code)

G766

UDS655 3

Back      Continue 5

5. A *CONFIRMATION* screen displays; select *VIEW NOW*.
6. The *VIEW NOW* screen displays. At the bottom of the screen is a prompt to install the OCX plug-in. Install it on whatever PC you want to remotely view your video.
7. Click on the link near the bottom of the page and it will ask you to *RUN* or *SAVE* the file.
8. Save it to your desktop. After the download is complete, click on it to install.
9. After the installation is complete, return to the *VIEW NOW* screen on the Portal.
10. Now you will see the DID code from your device that you entered during account setup. Enter the security sode you created in Uniden Remote Service software installation (see page 41).
11. Click *START*.

***The security code you enter on the Uniden Video Portal and the apps must match the security code you entered during Uniden Remote Service software installation. Anytime you change the security code in that software, you must make the corresponding change on the Portal or the apps.***

## Using Remote Access

If you want to view your video remotely, you must do the following:

1. Verify that your PC is connected to the internet and that Uniden Remote Service software is installed.
2. Use the USB cable to connect the monitor and the PC.
3. Launch the Uniden Remote Service software.
4. Enter the security code.
5. Select *CONNECT TO INTERNET*.

Your system is now connected to the internet and your cameras' video can now be remotely viewed through iPhone, iPad, Android smartphones and tablets, and PC via the UnidenVideo Portal.

## RECORD VIDEO THROUGH THE PORTAL

The Portal lets you record live video and save it to your PC.

1. Click *RECORD* to start recording.

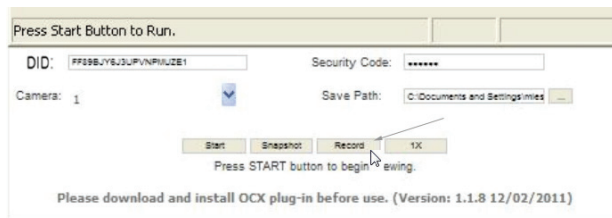

2. Click *STOP RECORD* to stop recording.

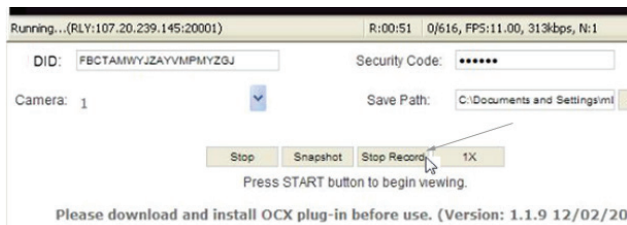

## TAKE A SNAPSHOT THROUGH THE PORTAL

The Portal lets you take snapshots of video and save to your PC.

Click *SNAPSHOT*.

***You specify the save location for all video and snapshots. Select Save and then browse to the location where you want to save them.***

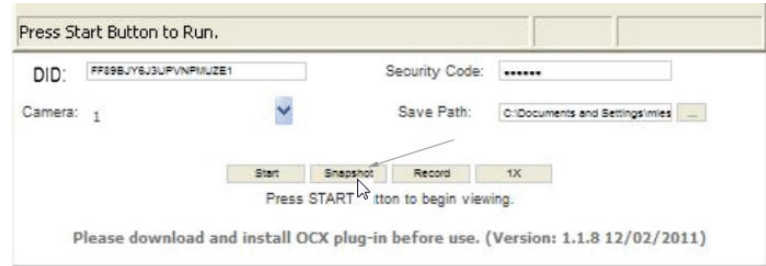

## PLAY BACK RECORDED FILES ON YOUR PC

The files that record on the UDS655 record onto the microSD card. You can take that card and play it on your PC. You will need:

- UDS655 microSD card
  - Uniden Media Player software (on UDS655 PC Software CD included in the box)
  - SD card adapter (included in the box).
1. Insert the UDS655 PC Software CD into your PC..
  2. Install Uniden Media Player onto your PC. It will post a shortcut icon to your desktop.
  3. Remove SD card from the UDS655. Place it in the adapter and insert adapter into your PC.
  4. Launch Uniden Media Player; click *LOAD*.
  5. Navigate to the SD card on your system.
  6. Select the files you want to view and click *OPEN*.
  7. The files begin playing, in order, on the Uniden Media Player screen.



## VIEW LIVE VIDEO ON TV

1. Be sure the UDS655 and the television are turned on.

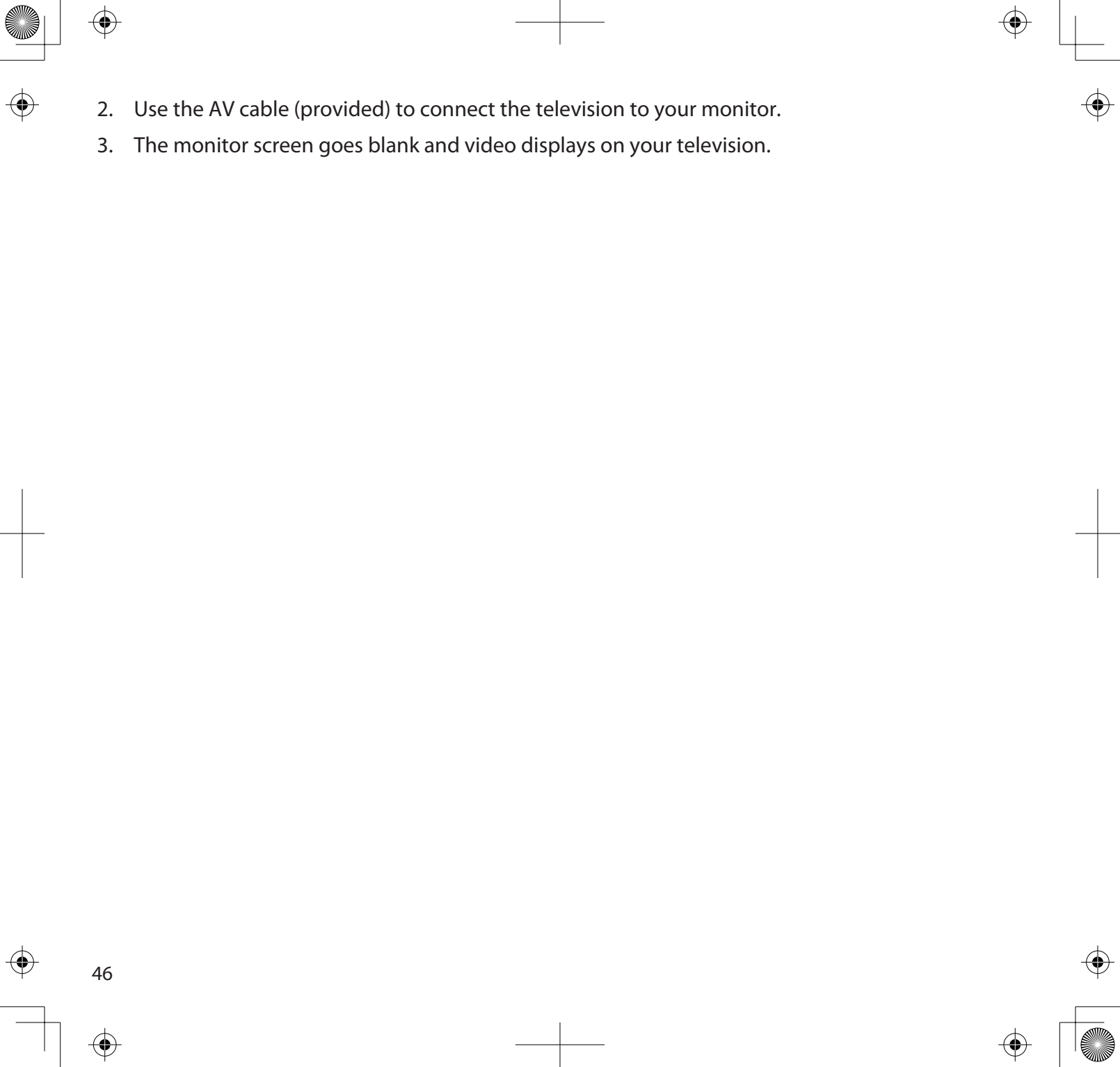

2. Use the AV cable (provided) to connect the television to your monitor.
3. The monitor screen goes blank and video displays on your television.

# DOWNLOADING AND USING THE APPS

## ANDROID™

### Download

You can use a Google® Android™ smart phone or tablet with your Uniden Guardian 2 System to remotely connect to and view live camera video. Follow these steps to download, add, and use the app.

1. From your Android™ smart phone or tablet device search the Android Market for *UNIDEN GUARDIAN 2*.
2. Download the Uniden Guardian 2 app. This app has a black and gold icon.
3. Launch the app; select *ADD* to add your system information to the app.
4. Enter a name for your system in the *SYSTEM NAME* field.
5. Enter the same DID code from your Uniden Guardian monitor in the *DEVICE DID* field.
6. Enter the same security code that you set on your Uniden Guardian monitor in the *SECURITY CODE* field.
7. Select *SAVE*.
8. Select the system you wish to view.

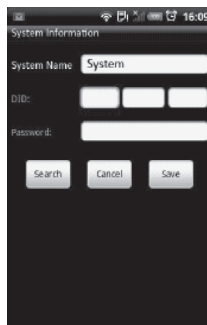
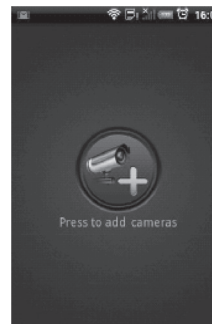

**The Uniden Guardian 2 app has a Search feature which will automatically find your UDS655 system on your "intranet." If the phone is connected via WiFi to the same router/network that the PC is on, selecting the Search button in the app will automatically find your system and enter the DID code in the DID Code field. You will only have to enter the Security Code you entered in the Remote Access software.**

## App Operation

When you open the app on your Android phone, the image displayed on the main screen is the last camera image, captured automatically, from your previously established session.

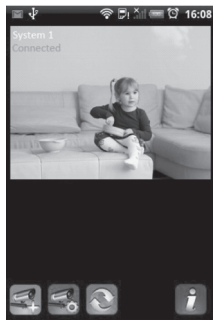

Tap to add an additional Guardian system.



Tap to enter *SYSTEM SETUP* page.



Tap to refresh the system.



Tap to enter the app *INFORMATION* page. The screen displays the app version number and the API version number. Tap *OK* to exit.

Main screen

If you have multiple systems, scroll down and tap on the system image you want to view. Follow these steps to view video:

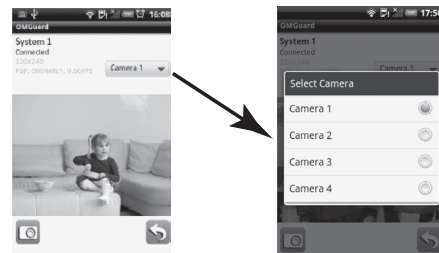

1. Select a system.
2. Select a camera from the drop-down menu.
3. View video.

**You can turn your device sideways and for a horizontal view.**





4. Tap *RETURN* to stop the video and enter the system page.  
You can take snapshots from the video by using the Snapshot and Return icons.

	Snapshot icon. Tap to take a picture.
	Return icon. Tap to return to the Main screen

## IPHONE®

In a similar fashion to the Android smart phone, you can use the Apple® iPhone® smart phone or iPad® tablet with your Uniden Guardian System to remotely connect to and view camera videos. Follow these steps to download the Uniden Guardian iPhone® app and set it up to work with your Uniden Guardian system.

### Download

1. From your iPhone® or iPad®, go to the iTunes® app Store and search for *UNIDEN GUARDIAN 2*.
2. Download the Uniden Guardian 2 app. This app has the black and gold icon.
3. Launch the app; select *SETTINGS* then **ADD** to add your system information to the app.
4. Enter a name for your system in the *SYSTEM NAME* field.
5. Enter the same DID code from your Uniden Guardian monitor in the *DID* field.
6. Enter the same security code that you set on your Uniden Guardian monitor in the *SECURITY CODE* field.
7. Tap *SAVE*. The video streams automatically with Camera 1 selected by default

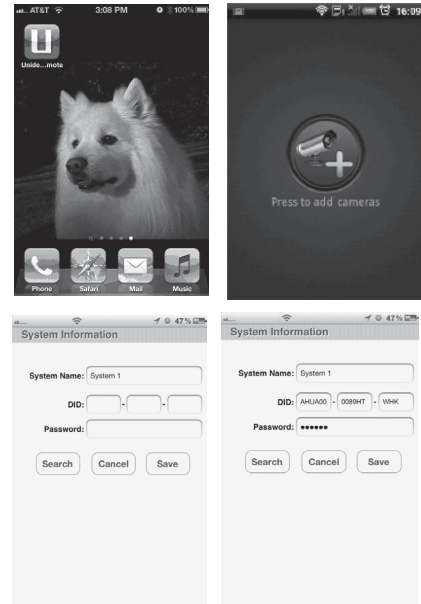

**The Uniden Guardian 2 app has a Search feature which will automatically find your UDS655 system on your "intranet." If the phone is connected via WiFi to the same router/network that the PC is on, selecting the Search button in the app will automatically find your system and enter the DID code in the DID Code field. You will only have to enter the Security Code you entered in the Remote Access software.**

## App Operation

When you open the app on your iPhone or iPad, several icons display on the bottom task bar.

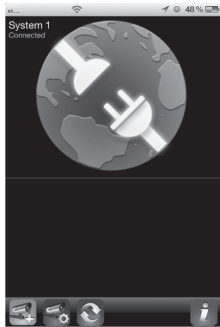

Tap to add an additional Guardian system.



Tap to enter *SYSTEM SETUP* page.



Tap to refresh the system.



Tap to enter the app *INFORMATION* page. The screen displays the app version number and the API version number. Tap *OK* to exit.

Main screen

If you have multiple systems, scroll down and tap on the system image you want to view.

To View Video:

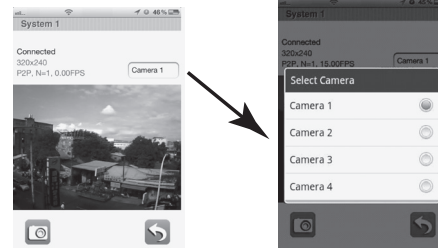

1. Select a system.
2. Select a camera from the drop-down M.
3. View video.

**You can turn your device sideways and go to a horizontal view.**



4. Tap *RETURN* to stop the video and enter the system page.

You can take snapshots from the video by using the Snapshot and Return icons.

	Snapshot icon. Tap to take a picture.
	Return icon. Tap to return to the Main screen.

# MAINTAINING YOUR SYSTEM

## UPGRADING YOUR UNIDEN UDS655 FIRMWARE

Check your system firmware version by selecting your language again on the *DEFAULT* screen. Both the cameras and monitor firmware display.

Go to [www.unidenvideo.com](http://www.unidenvideo.com) to check the current firmware level. Compare it to your system firmware level. If you need to update your UDS655 firmware, download the most current firmware version to your system's microSD card and then upload that firmware to the monitor.

1. Eject the microSD card from the monitor and insert it into the SD card adapter.
2. Insert the SD card adapter into your PC and go to [www.unidenvideo.com](http://www.unidenvideo.com).
3. Copy the current firmware to the SD card.
4. Remove the SD card from your PC. Remove the microSD card from the adapter and reinsert it into the monitor. Plug the AC adapter into the monitor.
5. Upgrade the system firmware by going to the *DEFAULT* screen in *SYSTEM SETUP*. Press **M**; the system displays *MENU : SOFTWARE UPGRADE*.
6. Press **M** again to automatically update the firmware. The upgrade turns off the system and deletes the file after update.

## TAKING CARE OF YOUR HARDWARE

### Monitor

As you use your monitor keep the screen clean by wiping it with a microfiber cloth to remove fingerprints, dust, etc.

### Cameras

When dust and grime builds up on the camera lens and glass, it affects night vision capability. The infrared light reflects off of the dust and grime, limiting the camera's "vision." Use a microfiber cloth to regularly clean the cameras or when night vision video is cloudy or unclear.

## SOLVING PROBLEMS

If you have any trouble with your system, try these simple steps. If you are still having a problem with your camera, check the manual that came with your camera.

If...	Try..
Motion detection won't respond to movement.	<ul style="list-style-type: none"><li>• Increasing the motion sensitivity (see page 24).</li><li>• Checking the settings on the <i>RECORD SCHEDULE</i> screen (see page 22).</li></ul>
Motion detection goes off when there's nothing there.	<ul style="list-style-type: none"><li>• Decreasing motion sensitivity (see page 24).</li><li>• Refer to General Placement Considerations on page 6.</li></ul>
I can't play my video clips in another program	<ul style="list-style-type: none"><li>• You must install Uniden Media Player to play back recorded files. This player is found on the CD included in the box.</li></ul>
I schedule a recording, save the schedule, and the recording does not happen at the scheduled time.	<ul style="list-style-type: none"><li>• Ensure that the system time is set to the current time.</li><li>• Make sure that the SD card is inserted into the monitor and there is still memory available on that card.</li></ul>
The camera's signal status icon shows no bars	<ul style="list-style-type: none"><li>• Making sure the camera is plugged in and the red LED is on.</li><li>• Making sure the camera is paired to the correct channel.</li><li>• Re-pairing the camera and monitor.</li><li>• Moving the camera closer to the monitor; it might be out of range.</li><li>• Making sure the camera setting is turned on (refer to <i>ACTIVATE OR DEACTIVATE</i> screen on page 21).</li></ul>
The camera's signal status icon shows one or two bars or the video quality is poor	See General Placement Considerations on page 6 for tips on improving video quality.
The camera won't pair with the monitor	<ul style="list-style-type: none"><li>• Making sure the camera is plugged in and the red LED is on.</li><li>• Pressing and releasing the pairing button quickly. Do not press and hold the pairing button.</li></ul>

If...	Try..
When I power up my monitor and cameras for the first time, they seem to be on but there is no picture on the screen	If the Power Saving feature has been turned on, the monitor's LCD screen will power off. Tap the power button to turn the LCD back on.
There is no video (or audio) when I try to watch live video on the television.	<ul style="list-style-type: none"> <li>• Making sure the UDS655 is turned on.</li> <li>• Making sure the AV plugs are inserted into the correct jacks on the television.</li> <li>• Making sure they are fully seated.</li> </ul>
There is no video on my wireless device	<ul style="list-style-type: none"> <li>• Making sure the UDS655 is turned on and connected properly to your PC.</li> <li>• Making sure the Remote View software is on and connected to the internet.</li> </ul>
There is no audio on my wireless device	<ul style="list-style-type: none"> <li>• Audio is not available for remote viewing; only video is.</li> </ul>
The app won't connect.	<ul style="list-style-type: none"> <li>• Checking your internet/Wifi connection.</li> </ul>
I can't view video on the portal through my remote PC.	<ul style="list-style-type: none"> <li>• Be sure you install the OCX plug in on that PC during Portal login (see page 43).</li> </ul>

**Need Help? Get answers 24/7 at our website: [www.uniden.com](http://www.uniden.com).**

If You...	Contact Uniden's...	Phone Number
have a question or problem	Customer Care Line*	817-858-2929 or 800-297-1023
need a replacement part or accessory	Parts Department*	800-554-3988
need special help due to a disability	Accessibility Help Line	800-874-9314 (voice or TTY)

\* During regular business hours, Central Standard Time. Visit our website for detailed business hours.

# SPECIFICATIONS

	Camera	Monitor
Maximum Channels	4	
Communication Range	500 ft in open space	
Monitor Resolution	800 x 480	
Camera Resolution	640 x 480	
Operating Temperature	-10°C ~ +50°C	
Operating voltage	DC 5V / 1A	
Current consumption	550mA (max)	860mA (max)
Night Vision	40 ft	
Dimension	123L x 65H x 65W mm	200L x 122H x 25W mm

MicroSD Card Capacity (1GB = 10 hours)

## Recycling and Disposal Information

- Do not dispose of electronic devices or any of their components (especially batteries and LCD displays) in your municipal trash collection.
- Consult your local waste management authority or a recycling organization like [Earth911.com](http://Earth911.com) to find an electronics recycling facility in your area.
- If you are unable to locate proper recycling facilities in your area, please return this product to Uniden for recycling.

## FCC Compliance Information

### Part 15 Compliance Statement

This device complies with Part 15 of the FCC Rules. Operation is subjected to the following two conditions: (1) this device may not cause harmful interference, and (2) this device must accept any interference received, including interference that may cause undesired operation.

This equipment has been tested and found to comply with limits for a Class B digital device, pursuant to Part 15 of the FCC rules and ETSI (EN) 300328. These limits are designed to provide reasonable protection against harmful interference in residential installations. This equipment generates, uses, and can radiate

radio frequency energy, and if not installed and used in accordance with the instructions, may cause harmful interference to radio communications.

However, there is no guarantee that interference will not occur in a particular installation. If this equipment does cause interference to radio or television equipment reception, which can be determined by turning the equipment off and on, the user is encouraged to try to correct the interference by one or more of the following measures:

- Reorient or relocate the receiving antenna.
- Move the equipment away from the monitor.
- Plug the equipment into an outlet on a circuit different from that to which the monitor is connected.
- Consult the dealer or an experienced radio/television technician for additional suggestions.

**CAUTION! Any changes or modifications to this equipment not expressly approved by the party responsible for compliance could void your authority to operate the equipment.**

### **RF Exposure Information**

The antenna used for this transmitter must be installed to provide a separation distance of at least 20 cm (7.9") from all persons and must not be collocated or operating in conjunction with any other antenna or transmitter.

### **IC Compliance Information**

#### **Radio Equipment Notice**

The term "IC:" before the radio certification number only signifies that Industry Canada technical specifications were met. Operation is subject to the following two conditions: (1) this device may not cause interference, and (2) this device must accept any interference, including interference that may cause undesired operation of the device. "Privacy of communications may not be ensured when using this device".

### **CE Compliance Information**

Products with CE Marking comply with EMC Directive (2004/108/EC); Low Voltage Directive (73/23/EEC); R&TTE(1999/5/EC) issued by the Commission of the European Community. Compliance with these directives implies conformity to the following European Norms:

- EMC: EN 301 489
- LVD: EN 60950
- Radio: EN 300 328



## One-year Limited Warranty

**Important: Evidence of original purchase is required for warranty service.**

WARRANTOR: UNIDEN AMERICA CORPORATION (“Uniden”) ELEMENTS OF WARRANTY: Uniden warrants, for one year, to the original retail owner, this Uniden Product to be free from defects in materials & craftsmanship with only the limitations or exclusions set out below.

WARRANTY DURATION: This warranty to the original user shall terminate & be of no further effect 12 months after the date of original retail sale. The warranty is invalid if the Product is (A) damaged or not maintained as reasonable or necessary, (B) modified, altered, or used as part of any conversion kits, subassemblies, or any configurations not sold by Uniden, (C) improperly installed, (D) serviced or repaired by someone other than an authorized Uniden service center for a defect or malfunction covered by this warranty, (E) used in any conjunction with equipment or parts or as part of any system not manufactured by Uniden, or (F) installed or programmed by anyone other than as detailed by the owner’s manual for this product.

STATEMENT OF REMEDY: In the event that the product does not conform to this warranty at any time while this warranty is in effect, warrantor will either, at its option, repair or replace the defective unit & return it to you without charge for parts, service, or any other cost (except shipping & handling) incurred by warrantor or its representatives in connection with the performance of this warranty. Warrantor, at its option, may replace the unit with a new or refurbished unit.

THE LIMITED WARRANTY SET FORTH ABOVE IS THE SOLE & ENTIRE WARRANTY PERTAINING TO THE PRODUCT & IS IN LIEU OF & EXCLUDES ALL OTHER WARRANTIES OF ANY NATURE WHATSOEVER, WHETHER EXPRESS, IMPLIED OR ARISING BY OPERATION OF LAW, INCLUDING, BUT NOT LIMITED TO ANY IMPLIED WARRANTIES OF MERCHANTABILITY OR FITNESS FOR A PARTICULAR PURPOSE. THIS WARRANTY DOES NOT COVER OR PROVIDE FOR THE REIMBURSEMENT OR PAYMENT OF INCIDENTAL OR CONSEQUENTIAL DAMAGES. Some states do not allow this exclusion or limitation of incidental or consequential damages so the above limitation or exclusion may not apply to you.

LEGAL REMEDIES: This warranty gives you specific legal rights, & you may also have other rights which vary from state to state. This warranty is void outside the United States of America & Canada.

PROCEDURE FOR OBTAINING PERFORMANCE OF WARRANTY: If, after following the instructions in the owner’s manual you are certain that the Product is defective, pack the Product carefully (preferably in its original packaging). Disconnect the battery from the Product & separately secure the battery in its own separate packaging within the shipping carton. The Product should include all parts & accessories originally



packaged with the Product. Include evidence of original purchase & a note describing the defect that has caused you to return it. The Product should be shipped freight prepaid, by traceable means, to warrantor at:

Uniden America Service  
4700 Amon Carter Blvd.  
Fort Worth, TX 76155



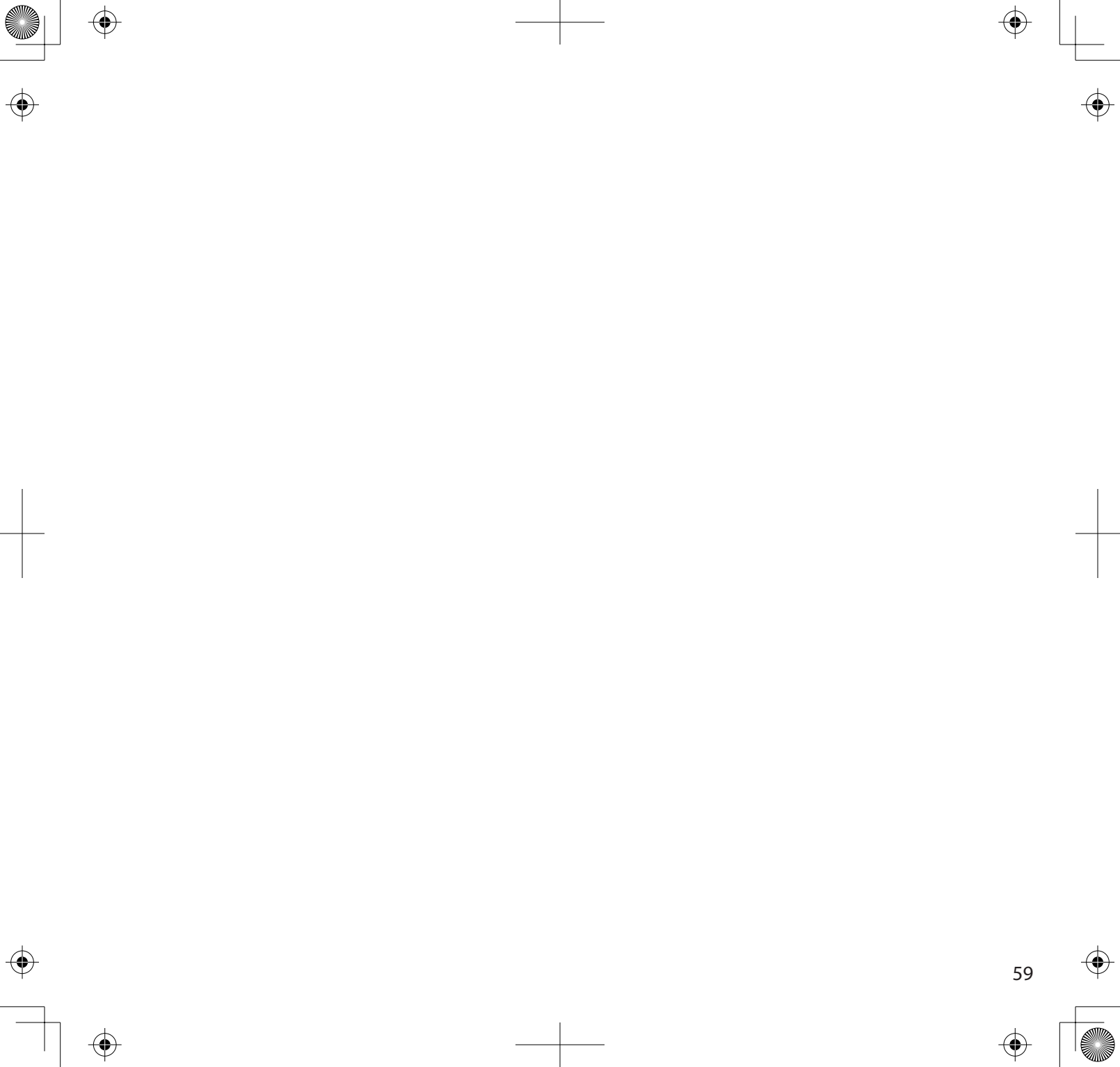

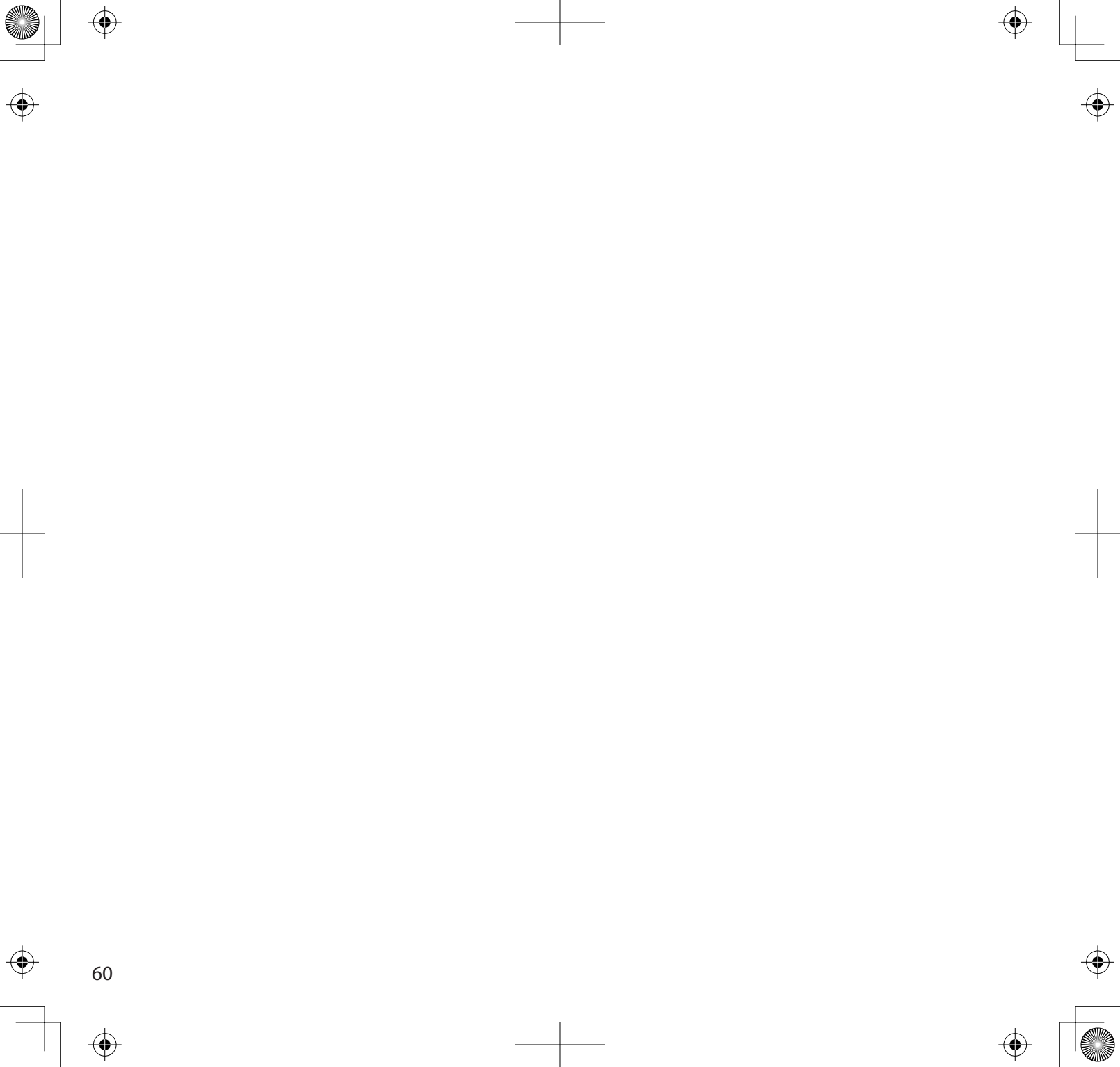

60

