

SUPER  [®]

X9SCM
X9SCM-F
X9SCL
X9SCL-F
X9SCL+-F

USER'S MANUAL

Revision 1.2b

The information in this User's Manual has been carefully reviewed and is believed to be accurate. The vendor assumes no responsibility for any inaccuracies that may be contained in this document, makes no commitment to update or to keep current the information in this manual, or to notify any person or organization of the updates. **Please Note: For the most up-to-date version of this manual, please see our web site at www.supermicro.com.**

Super Micro Computer, Inc. ("Supermicro") reserves the right to make changes to the product described in this manual at any time and without notice. This product, including software and documentation, is the property of Supermicro and/or its licensors, and is supplied only under a license. Any use or reproduction of this product is not allowed, except as expressly permitted by the terms of said license.

IN NO EVENT WILL SUPER MICRO COMPUTER, INC. BE LIABLE FOR DIRECT, INDIRECT, SPECIAL, INCIDENTAL, SPECULATIVE OR CONSEQUENTIAL DAMAGES ARISING FROM THE USE OR INABILITY TO USE THIS PRODUCT OR DOCUMENTATION, EVEN IF ADVISED OF THE POSSIBILITY OF SUCH DAMAGES. IN PARTICULAR, SUPER MICRO COMPUTER, INC. SHALL NOT HAVE LIABILITY FOR ANY HARDWARE, SOFTWARE, OR DATA STORED OR USED WITH THE PRODUCT, INCLUDING THE COSTS OF REPAIRING, REPLACING, INTEGRATING, INSTALLING OR RECOVERING SUCH HARDWARE, SOFTWARE, OR DATA.

Any disputes arising between manufacturer and customer shall be governed by the laws of Santa Clara County in the State of California, USA. The State of California, County of Santa Clara shall be the exclusive venue for the resolution of any such disputes. Supermicro's total liability for all claims will not exceed the price paid for the hardware product.

FCC Statement: This equipment has been tested and found to comply with the limits for a Class B digital device pursuant to Part 15 of the FCC Rules. These limits are designed to provide reasonable protection against harmful interference in a residential installation. This equipment generates, uses, and can radiate radio frequency energy and, if not installed and used in accordance with the manufacturer's instruction manual, may cause interference with radio communications. However, there is no guarantee that interference will not occur in a particular installation. If this equipment does cause harmful interference to radio or television reception, which can be determined by turning the equipment off and on, you are encouraged to try to correct the interference by one or more of the following measures:

- Reorient or relocate the receiving antenna.
- Increase the separation between the equipment and the receiver.
- Connect the equipment into an outlet on a circuit different from that to which the receiver is connected.
- Consult the dealer or an experienced radio/television technician for help.

California Best Management Practices Regulations for Perchlorate Materials: This Perchlorate warning applies only to products containing CR (Manganese Dioxide) Lithium coin cells. "Perchlorate Material-special handling may apply. See www.dtsc.ca.gov/hazardouswaste/perchlorate".

WARNING: Handling of lead solder materials used in this product may expose you to lead, a chemical known to the State of California to cause birth defects and other reproductive harm.

Manual Revision 1.2b

Release Date: February 18, 2014

Unless you request and receive written permission from Super Micro Computer, Inc., you may not copy any part of this document. Information in this document is subject to change without notice. Other products and companies referred to herein are trademarks or registered trademarks of their respective companies or mark holders.

Copyright © 2014 by Super Micro Computer, Inc. All rights reserved.

Printed in the United States of America

Preface

This manual is written for system integrators, PC technicians and knowledgeable PC users. It provides information for the installation and use of the **SUPER**® X9SCM/X9SCM-F/X9SCL/X9SCL-F/X9SCL+-F motherboard.

About This Motherboard

The **SUPER**® X9SCM/X9SCM-F/X9SCL/X9SCL-F/X9SCL+-F supports a single Intel® Xeon E3-1200 series, 2nd generation Intel Core® i3, Pentium®, Celeron® processor in an LGA 1155 socket. With the Intel® Cougar Point chipset built in, the X9SCM/X9SCL series motherboard offers substantial enhancement in system performance and storage capability for entry-level to mid-range servers in a sleek package. Please refer to our website (<http://www.supermicro.com/products/>) for processor and memory support updates. This product is intended to be installed and serviced by professional technicians.

Manual Organization

Chapter 1 describes the features, specifications and performance of the motherboard, and provides detailed information about the Intel Cougar Point chipset.

Chapter 2 provides hardware installation instructions. Read this chapter when installing the processor, memory modules and other hardware components into the system. If you encounter any problems, see **Chapter 3**, which describes troubleshooting procedures for video, memory and system setup stored in the CMOS.

Chapter 4 includes an introduction to the BIOS, and provides detailed information on running the CMOS Setup utility.

Appendix A provides BIOS Error Beep Codes.

Appendix B lists software program installation instructions.

Appendix C contains BIOS Recovery instructions.

Conventions Used in This Manual

Pay special attention to the following symbols for proper motherboard installation and to prevent damage to the system or injury to yourself:



Danger/Caution: Instructions to be strictly followed to prevent catastrophic system failure or to avoid bodily injury,

Warning: Important information given to ensure proper system installation or to prevent damage to the components,



Note: Additional information given to differentiate between various models or to provide information for correct system setup.

Contacting Supermicro

Headquarters

Address: Super Micro Computer, Inc.
980 Rock Ave.
San Jose, CA 95131 U.S.A.

Tel: +1 (408) 503-8000

Fax: +1 (408) 503-8008

Email: marketing@supermicro.com (General Information)
support@supermicro.com (Technical Support)

Web Site: www.supermicro.com

Europe

Address: Super Micro Computer B.V.
Het Sterrenbeeld 28, 5215 ML
's-Hertogenbosch, The Netherlands

Tel: +31 (0) 73-6400390

Fax: +31 (0) 73-6416525

Email: sales@supermicro.nl (General Information)
support@supermicro.nl (Technical Support)
rma@supermicro.nl (Customer Support)

Web Site: www.supermicro.com

Asia-Pacific

Address: Super Micro Computer, Inc.
3F, No. 150, Jian 1st Rd.
Zhonghe Dist., New Taipei City 235
Taiwan (R.O.C)

Tel: +886-(2) 8226-3990

Fax: +886-(2) 8226-3992

Email: support@supermicro.com.tw

Tel: +886-(2)-8226-3990

Web Site: www.supermicro.com.tw

Table of Contents

Preface

Chapter 1 Introduction

1-1	Overview	1-1
1-2	Chipset Overview	1-12
1-3	Special Features	1-13
1-4	PC Health Monitoring	1-13
1-5	ACPI Features	1-14
1-6	Power Supply	1-14
1-7	Super I/O	1-15
1-8	Overview of the Nuvoton WPCM450 Controller	1-15

Chapter 2 Installation

2-1	Static-Sensitive Devices	2-1
	Precautions	2-1
	Unpacking	2-1
2-2	Processor and Heatsink Installation	2-2
	Installing the LGA1155 Processor	2-2
	Installing a Passive CPU Heatsink	2-5
	Removing the Heatsink	2-6
	Installing an Active Fan CPU Heatsink	2-7
	Removing the Heatsink	2-9
2-3	Installing DDR3 Memory	2-10
	DIMM Installation	2-10
	Removing Memory Modules	2-10
	Memory Support	2-11
	Memory Population Guidelines	2-11
2-4	Motherboard Installation	2-13
	Tools Needed	2-13
	Location of Mounting Holes	2-13
	Installing the Motherboard	2-14
2-5	Connectors/IO Ports	2-15
	Back I/O Panel	2-15
	ATX PS/2 Keyboard/Mouse Ports	2-16
	Universal Serial Bus (USB)	2-17
	Ethernet Ports	2-18
	Serial Ports	2-19
	Video Connector	2-20

	Front Control Panel.....	2-21
	Front Control Panel Pin Definitions.....	2-22
	Power LED	2-22
	HDD LED.....	2-22
	NIC1/NIC2 (LAN1/LAN2).....	2-23
	Overheat (OH)/Fan Fail/Front UID LED.....	2-23
	Reset Button	2-24
	Power Button	2-24
2-6	Connecting Cables.....	2-25
	ATX Main PWR & CPU PWR Connectors	2-25
	Fan Headers.....	2-26
	Chassis Intrusion	2-26
	Internal Buzzer	2-27
	Speaker	2-27
	Onboard Power LED.....	2-28
	Power Supply I ² C Connector.....	2-28
	T-SGPIO 0/1 Headers	2-29
	TPM Header.....	2-29
	DOM PWR Connector.....	2-30
	Wake-On-LAN	2-30
2-7	Jumper Settings	2-31
	Explanation of Jumpers	2-31
	LAN Port Enable/Disable	2-31
	CMOS Clear.....	2-32
	PCI Slot SMB Enable.....	2-32
	VGA Enable.....	2-33
	Watch Dog Enable	2-33
	USB Wake-Up	2-34
	BMC Enable	2-34
	ME Recovery.....	2-35
2-8	Onboard Indicators.....	2-36
	LAN 1/LAN 2 LEDs	2-36
	IPMI Dedicated LAN LEDs	2-36
	IPMI Heartbeat LED	2-37
	Power Standby LED.....	2-37
2-9	SATA Connections.....	2-38
	SATA Connections.....	2-38

Chapter 3 Troubleshooting

3-1	Troubleshooting Procedures	3-1
3-2	Technical Support Procedures	3-3
3-3	Frequently Asked Questions	3-4
3-4	Battery Removal and Installation	3-6
3-5	Returning Merchandise for Service.....	3-7

Chapter 4 BIOS

4-1	Introduction.....	4-1
4-2	Main Setup.....	4-2
4-3	Advanced Setup Configurations.....	4-4
4-4	Event Logs	4-15
4-5	IPMI Configuration (X9SCM-F/X9SCL-F/X9SCL+F).....	4-16
4-6	Boot Settings	4-18
4-7	Security Settings	4-19
4-8	Exit Options.....	4-20

Appendix A BIOS Error Beep Codes

A-1	BIOS Error Beep Codes	A-1
-----	-----------------------------	-----

Appendix B Software Installation Instructions

B-1	Installing Drivers.....	B-1
B-2	Configuring SuperDoctor [®] III.....	B-2

Appendix C UEFI BIOS Recovery Instructions

	An Overview to the UEFI BIOS.....	1
	How to Recover the UEFI BIOS Image (-the Main BIOS Block).....	1
	To Recover the Main BIOS Block Using a USB-Attached Device.....	1

Chapter 1

Introduction

1-1 Overview

Checklist

Congratulations on purchasing your computer motherboard from an acknowledged leader in the industry. Supermicro boards are designed with the utmost attention to detail to provide you with the highest standards in quality and performance.

Please check that the following items have all been included with your motherboard. If anything listed here is damaged or missing, contact your retailer.

The following items are included in the retail box:

- One (1) Supermicro Mainboard
- Six (6) SATA cables
- One (1) I/O shield
- One (1) Supermicro CD containing drivers and utilities
- One (1) User's Manual

SUPER[®] Motherboard Image (X9SCM/X9SCM-F)

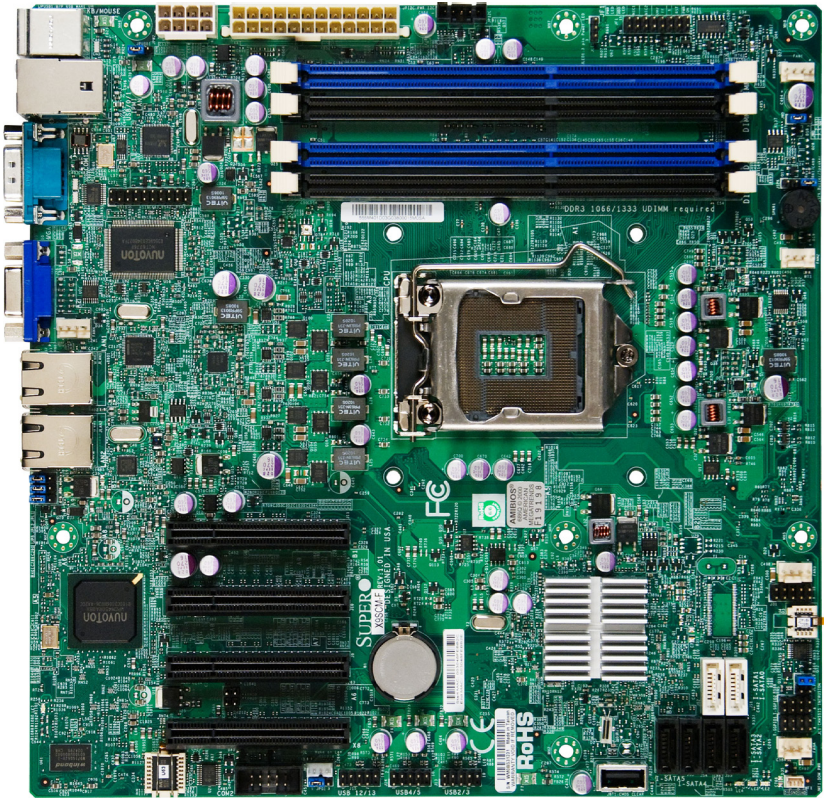

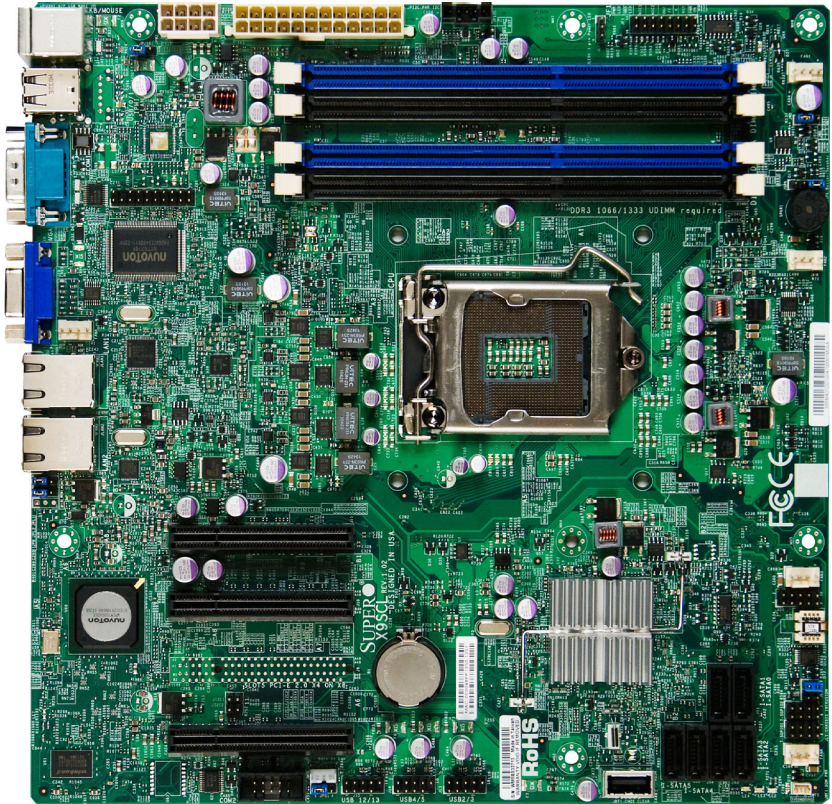

 **Note:** All graphics shown in this manual were based upon the latest PCB Revision available at the time of publishing of the manual. The motherboard you've received may or may not look exactly the same as the graphics shown in this manual.

SUPER Motherboard Image (X9SCL/X9SCL-F)

 **Note:** All graphics shown in this manual were based upon the latest PCB Revision available at the time of publishing of the manual. The motherboard you've received may or may not look exactly the same as the graphics shown in this manual.

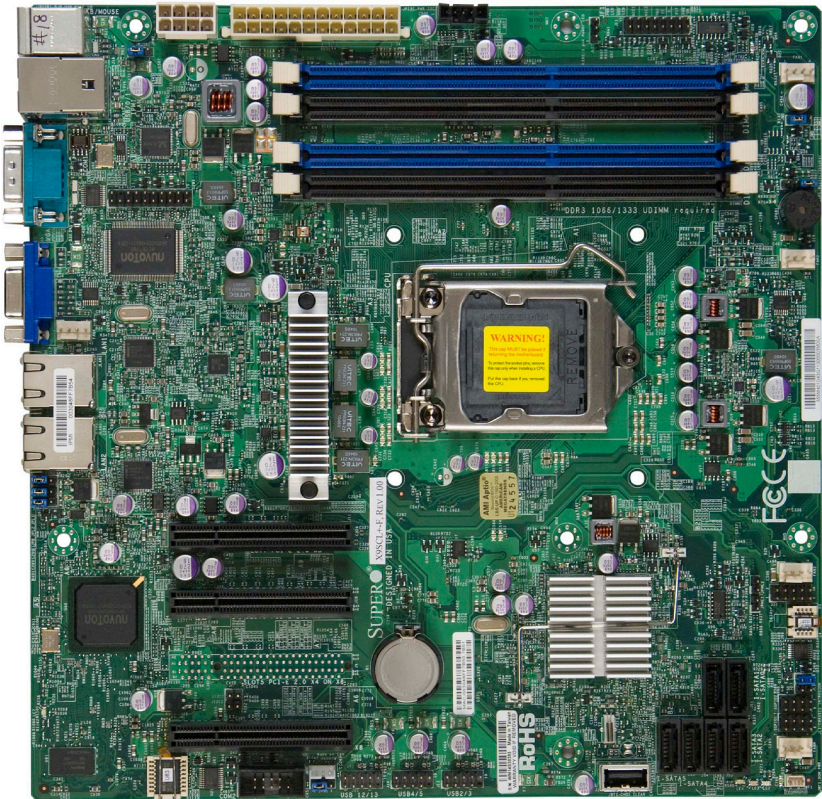
SUPER Motherboard Image (X9SCL+-F)



 **Note:** All graphics shown in this manual were based upon the latest PCB Revision available at the time of publishing of the manual. The motherboard you've received may or may not look exactly the same as the graphics shown in this manual.

Motherboard Layout

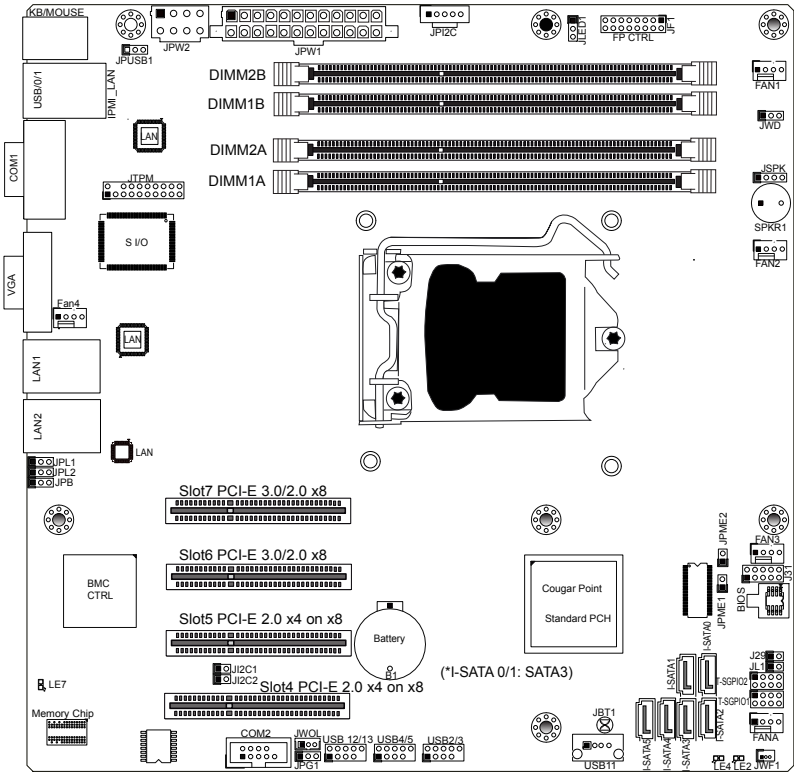

Important Notes to the User

- See Chapter 2 for detailed information on jumpers, I/O ports and JF1 front panel connections.
- "■" indicates the location of "Pin 1".
- Jumpers not indicated are for testing only.
- SATA-III ports (6Gb/s) are available on the X9SCM(-F) only.
- For X9SCM(-F): Two SATA-III ports (I-SATA#0~1) and four SATA-II ports (3 Gb/s, I-SATA#2~5) are located on the board. For X9SCL(+)(-F): Six SATA-II ports (I-SATA #0~5) are included on the motherboard.
- PCI-E Slot5 (PCI-E 2.0 x4 on x8 slot) is available on the X9SCM(-F) only.

X9SCM/X9SCM-F/X9SCL/X9SCL-F/X9SCL+-F Quick Reference

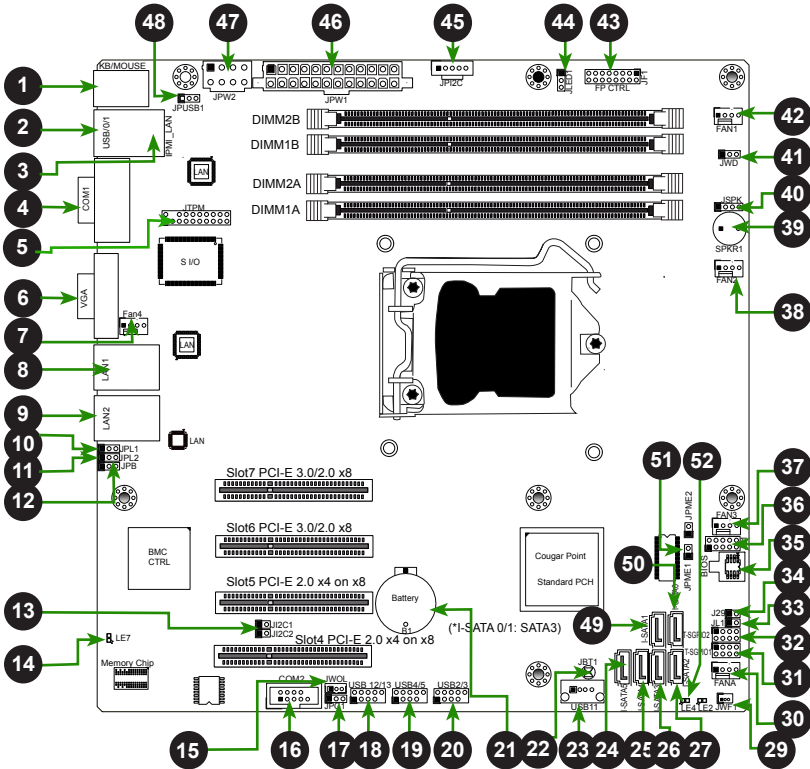

X9SCM/X9SCM-F/X9SCL/X9SCL-F/X9SCL+-F Jumpers			
Number	Jumper	Description	Default
34	J29	SPI Programming (internal use)	Closed (Normal)
22	JBT1	CMOS Clear	(See Chpt. 2)
13	JPC1/JPC2	SMB to PCI Slots	(See Chpt. 2)
12	JPB	BMC Enable	Pins 1-2 (Enabled)
17	JPG1	Onboard VGA Enable	Pins 1-2 (Enabled)
10,11	JPL1/JPL2	LAN1/LAN2 Enable	Pins 1-2 (Enabled)
48	JPUSB1	USB 0/1 Wake-Up Enable	Pins 1-2 (Enabled)
41	JWD	Watch_Dog Timer Enable	Pins 1-2 (Reset)
51	JPME1	ME Recovery	Open (Normal)

X9SCM/X9SCM-F/X9SCL/X9SCL-F/X9SCL+F Headers/Connectors		
Number	Connector	Description
21	B1	Onboard Battery
4,16	COM1/COM2	COM1/2 Serial Connection Headers
35	BIOS	SPI BIOS
42,38,37,7,30	Fans 1~4, Fan A	System/CPU Fan Headers
36	J31	SPI Programming (internal use)
43	JF1	Front Panel Control Header
33	JL1	Chassis Intrusion Header
44	JLED1	Power LED Indicator Header
46	JPW1	24-pin ATX Main Power Connector (Required)
47	JPW2	+12V 8-pin CPU power Connector (Required)
1	KB/Mouse	Keyboard/Mouse Connectors
8,9,3	LAN1/LAN2, IPMI_LAN	Gigabit (RJ45) Ports (LAN1/2), IPMI_LAN (F-models)
50,49	I-SATA 0/1	Serial ATA Ports 0/1 (X9SCL: SATA-II Ports, X9SCM: SATA-III Ports)
27,26,25,24	I-SATA 2~5	SATA-II Ports
45	JPC	PWR supply (I ² C) System Management Bus
40	JSPK	Speaker Header (Pins 3/4: Internal, 1~4:External)
5	JTPM	Trusted Platform Module (TPM) Header
29	JWF1	SATA DOM (Device_On_Module) Power Connector
15	JWOL	Wake_On_LAN Header
39	SPKR1	Internal Speaker/Buzzer
31, 32	T-SGPIO-1/2	Serial_Link General Purpose IO 1/2 Headers (5V Gen1/Gen 2)
2	USB0/1	Backpanel USB 0/1
20,19,18	USB2/3, USB4/5, USB 12/13	Front Accessible USB Connections (via 3 Headers)
23	USB 11	Front Accessible Type A USB Connector
6	VGA	Onboard Video Port

X9SCM/X9SCM-F/X9SCL/X9SCL-F/X9SCL+F LED Indicators				
Number	LED	Description	Color/State	Status
14	LE7	IPMI Heartbeat LED	Green: Blinking	IPMI Active
52	LE4	Power Standby	Green: Solid on	System is plugged in

Motherboard Features

CPU	Single Intel® Xeon E3-1200 & E3-1200 v2 series, 2nd & 3rd generation Intel Core® i3, Pentium®, Celeron® processor in an LGA 1155 socket.	
Memory 	Four (4) SDRAM DIMM slots support up to 32 GB of DDR3 Unbuffered, ECC 1600/1333/1066 MHz memory.	
	Note: For memory speed 1600 MHz support, an E3-1200 v2 CPU is required.	
	Supports dual-channel memory bus	
	DIMM sizes	
Chipset	UDIMM	1 GB, 2 GB, 4GB and 8GB
	Intel® C204 Express (X9SCM Series) Intel® C202 Express (X9SCL Series)	
Expansion Slots	Two (2) PCI Express 2.0 x8 slots	
	Two (2) PCI Express x4 in x8 slots, One (1) on the X9SCL/X9SCL-F/X9SCL+-F	
Integrated Graphics	Matrox® G200eW	
Network Connections	One (1) Intel 82574L Gigabit Ethernet controller for LAN 1, and one (1) Intel 82579 PHY for LAN 2. Note: The X9SCL+-F features two (2) Intel 82574L Gigabit Ethernet controllers, one each for LAN 1 and LAN 2.	
	Two (2) RJ-45 Rear IO Panel Connectors with Link and Activity LEDs	
	Single Realtek RTL8201N PHY to support IPMI 2.0 LAN (X9SCM-F/X9SCL-F/X9SCL+-F Only)	
I/O Devices	SATA Connections	
	(X9SCM/X9SCM-F)	
	• SATA-III Ports (6Gb/s)	• Two (2) (I-SATA 0/1)
	• SATA-II Ports (3Gb/s)	• Four (4) (I-SATA 2~5)
	(X9SCL/X9SCL-F/X9SCL+-F)	
	• SATA-II Ports	• Six (6) (I-SATA 0~5)
	RAID (Windows)	RAID 0, 1, 5, 10
	Onboard IPMI (X9SCM-F/X9SCL-F/X9SCL+-F Only)	
	IPMI 2.0 supported by the WPCM450 Server BMC	
	USB Devices	
	Two (2) USB ports on the rear IO panel (USB 0/1)	
	Six (6) USB header connectors for front access (USB 2/3, USB 4/5, USB 12/13)	
One (1) Type A USB internal connector (USB 11)		

	Keyboard/Mouse PS/2 Keyboard/Mouse ports on the I/O backpanel
	Serial (COM) Ports Two (2) Fast UART 16550 connections: one 9-pin RS-232 port (Backplane COM1 port) and one header (FP COM2)
	Super I/O Winbond Super I/O NCP6776F
BIOS	64 MB SPI AMI BIOS® SM Flash BIOS Play and Plug (PnP0, DMI 2.3, PCI 2.3, ACPI 1.0/2.0/3.0, USB Keyboard and SMBIOS 2.5)
Power Configuration	ACPI/ACPM Power Management Main Switch Override Mechanism Keyboard Wake-up from Soft-Off Internal/External Modem Ring-On Power-on mode for AC power recovery
PC Health Monitoring	CPU Monitoring Onboard voltage monitors for CPU core, +3.3V, +5V, +/-12V, +3.3V Stdbby, VBAT, Memory, VCORE for CPU CPU 4-phase switching voltage regulator CPU/System overheat LED and control CPU Thermal Trip support Thermal Monitor 2 (TM2) support
	Fan Control Fan status monitoring with firmware 4-pin (Pulse Width Modulation) fan speed control Low noise fan speed control
System Management	PECI (Platform Environment Configuration Interface) 3.0 support System resource alert via SuperDoctor® III SuperDoctor® III, Watch Dog, NMI Chassis Intrusion header and detection
CD Utilities	BIOS flash upgrade utility Drivers and software for Intel® Cougar Point chipset utilities
Other	ROHS 6/6 (Full Compliance, Lead Free)
Dimensions	Micro ATX form factor (9.6" x 9.6") (243.84mm x 243.84mm)



Note: For IPMI Configuration Instructions, please refer to the Embedded IPMI Configuration User's Guide available @ <http://www.supermicro.com/support/manuals/>.

X9SCM/X9SCM-F/X9SCL/X9SCL-F/X9SCL+-F Block Diagram

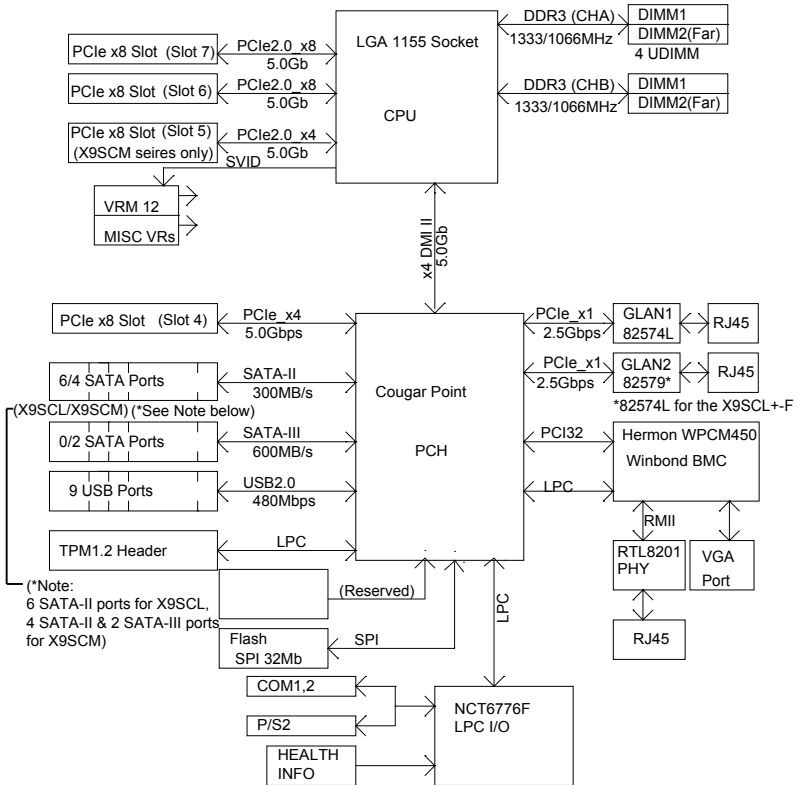

System Block Diagram



Note: This is a general block diagram and may not exactly represent the features on your motherboard. See the Motherboard Features pages for the actual specifications of each motherboard.

1-2 Chipset Overview

The X9SCM/X9SCM-F/X9SCL/X9SCL-F/X9SCL+-F supports a single Intel® Xeon E3-1200 series, 2nd generation Intel Core® i3, Pentium®, Celeron® processor in an LGA 1155 socket. Built upon the functionality and the capability of the Intel C202/C204 chipset, the motherboard provides substantial enhancement to system performance and storage capability for entry-level to mid-range servers in a sleek package.

The high-speed Direct Media Interface (DMI) featured in the Intel C202/C204 chipset supports high-speed Direct Media Interface (DMI) for chip-to-chip true isochronous communication, providing up to 10 Gb/s of software-transparent data transfer rate on each read/write direction. In addition, the X9SCM/X9SCM-F/X9SCL/X9SCL-F/X9SCL+-F also features a TCO timer which allows the system to recover from a software/hardware lock and perform tasks, including ECC Error Reporting, Function Disable and Intruder Detect.

Intel C202/C204 Express Chipset Features

- Direct Media Interface (up to 20 Gb/s transfer, Full Duplex)
- Intel® Intel Rapid Storage Technology
- Intel I/O Virtualization (VT-d) Support
- Intel Trusted Execution Technology Support
- PCI Express 2.0 Interface (up to 5.0 GT/s)
- SATA Controller
 - 6G/s on up to two ports
 - 3G/s on all ports
- Advanced Host Controller Interface (AHCI)

1-3 Special Features

Recovery from AC Power Loss

Basic I/O System (BIOS) provides a setting for you to determine how the system will respond when AC power is lost and then restored to the system. You can choose for the system to remain powered off (in which case you must press the power switch to turn it back on), or for it to automatically return to a power-on state. See the Advanced BIOS Setup section to change this setting. The default setting is **Last State**.

1-4 PC Health Monitoring

This section describes the PC health monitoring features of the board. All have an onboard System Hardware Monitoring chip that supports PC health monitoring. An onboard voltage monitor will scan these onboard voltages continuously: CPU Vcore, NIC Vcore, BMC Vcore, AUX Vcore, Standby ME Vcore, 12V Scale, 1.5V, 3.3V Vcc(V), 3.3VSB, and Battery Voltage. Once a voltage becomes unstable, a warning is given, or an error message is sent to the screen. The user can adjust the voltage thresholds to define the sensitivity of the voltage monitor.

Fan Status Monitor with Firmware Control

PC health monitoring in the BIOS can check the RPM status of the cooling fans. The onboard CPU and chassis fans are controlled by Thermal Management via BIOS (under the Hardware Monitoring section in the Advanced Setting).

Environmental Temperature Control

The thermal control sensor monitors the CPU temperature in real time and will turn on the thermal control fan whenever the CPU temperature exceeds a user-defined threshold. The overheat circuitry runs independently from the CPU. Once the thermal sensor detects that the CPU temperature is too high, it will automatically turn on the thermal fans to prevent the CPU from overheating. The onboard chassis thermal circuitry can monitor the overall system temperature and alert the user when the chassis temperature is too high.



Note: To avoid possible system overheating, please be sure to provide adequate airflow to your system.

System Resource Alert

This feature is available when the system is used with SuperDoctor® III in the

Windows OS environment or used with SuperDoctor II in Linux. SuperDoctor is used to notify the user of certain system events. For example, you can also configure SuperDoctor to provide you with warnings when the system temperature, CPU temperatures, voltages and fan speeds go beyond predefined thresholds.

1-5 ACPI Features

ACPI stands for Advanced Configuration and Power Interface. The ACPI specification defines a flexible and abstract hardware interface that provides a standard way to integrate power management features throughout a PC system, including its hardware, operating system and application software. This enables the system to automatically turn on and off peripherals such as CD-ROMs, network cards, hard disk drives and printers.

In addition to enabling operating system-directed power management, ACPI also provides a generic system event mechanism for Plug and Play, and an operating system-independent interface for configuration control. ACPI leverages the Plug and Play BIOS data structures, while providing a processor architecture-independent implementation that is compatible with Windows XP, Windows Vista and Windows 2008 Operating Systems.

Slow Blinking LED for Suspend-State Indicator

When the CPU goes into a suspend state, the chassis power LED will start to blink to indicate that the CPU is in suspend mode. When the user presses any key, the CPU will "wake up", and the LED will automatically stop blinking and remain on.

1-6 Power Supply

As with all computer products, a stable power source is necessary for proper and reliable operation. It is even more important for processors that have high CPU clock rates.

This motherboard accommodates 24-pin ATX power supplies. Although most power supplies generally meet the specifications required by the CPU, some are inadequate. In addition, the 12V 8-pin power connector located at JPW2 is also required to ensure adequate power supply to the system. Also your power supply must supply 1.5A for the Ethernet ports.

Warning: Please use a power supply that contains a 24-pin and an 8-pin or a 4-pin power connector. Be sure to connect these connectors to the 24-pin (JPW1) and the 8-pin (JPW2) power connectors on the motherboard.



Note: The JPW2 power connector on the motherboard also supports one 4-pin connector.

It is strongly recommended that you use a high quality power supply that meets ATX power supply Specification 2.02 or above. It must also be SSI compliant. (For more information, please refer to the web site at <http://www.ssiforum.org/>). Additionally, in areas where noisy power transmission is present, you may choose to install a line filter to shield the computer from noise. It is recommended that you also install a power surge protector to help avoid problems caused by power surges.

1-7 Super I/O

The Super I/O supports two high-speed, 16550 compatible serial communication ports (UARTs). Each UART includes a 16-byte send/receive FIFO, a programmable baud rate generator, complete modem control capability and a processor interrupt system. Both UARTs provide legacy speed with baud rate of up to 115.2 Kbps as well as an advanced speed with baud rates of 250 K, 500 K, or 1 Mb/s, which support higher speed modems.

The Super I/O provides functions that comply with ACPI (Advanced Configuration and Power Interface), which includes support of legacy and ACPI power management through an SMI or SCI function pin. It also features auto power management to reduce power consumption.

1-8 Overview of the Nuvoton WPCM450 Controller

The Nuvoton WPCM450R Controller is a Baseboard Management Controller (BMC) that supports 2D/VGA-compatible Graphics cores, Virtual Media, and Keyboard/Video/Mouse Redirection (KVMR) modules. With blade-oriented Super I/O capability built in, the WPCM450R Controller is ideal for legacy-reduced server platforms.

The WPCM450R interfaces with a host system via PCI interface to communicate with the Graphics core. It supports USB 2.0 and 1.1 for remote keyboard/mouse/virtual media emulation. It also provides LPC interface to control Super IO functions. The WPCM450R is connected to the network via an external Ethernet PHY module.

The WPCM450R communicates with onboard components via six SMBus interfaces, fan control, and Platform Environment Control Interface (PECI) buses.



Note: For more information on IPMI configuration, please refer to the Embedded IPMI User's Guide posted on our Website @ <http://www.supermicro.com/support/manuals/>.

Notes

Chapter 2

Installation

2-1 Static-Sensitive Devices

Electrostatic-Discharge (ESD) can damage electronic components. To avoid damaging your system board, it is important to handle it very carefully. The following measures are generally sufficient to protect your equipment from ESD.

Precautions

- Use a grounded wrist strap designed to prevent static discharge.
- Touch a grounded metal object before removing the board from the antistatic bag.
- Handle the board by its edges only; do not touch its components, peripheral chips, memory modules or gold contacts.
- When handling chips or modules, avoid touching their pins.
- Put the motherboard and peripherals back into their antistatic bags when not in use.
- For grounding purposes, make sure your computer chassis provides excellent conductivity between the power supply, the case, the mounting fasteners and the motherboard.
- Use only the correct type of onboard CMOS battery. Do not install the onboard battery upside down to avoid possible explosion.

Unpacking

The motherboard is shipped in antistatic packaging to avoid static damage. When unpacking the board, make sure that the person handling it is static protected.

2-2 Processor and Heatsink Installation

Warning: When handling the processor package, avoid placing direct pressure on the label area of the fan.

 **Notes:**

- Always connect the power cord last, and always remove it before adding, removing or changing any hardware components. Make sure that you install the processor into the CPU socket before you install the CPU heatsink.
- If you buy a CPU separately, make sure that you use an Intel-certified multi-directional heatsink only.
- Make sure to install the system board into the chassis before you install the CPU heatsink.
- When receiving a server board without a processor pre-installed, make sure that the plastic CPU socket cap is in place and none of the socket pins are bent; otherwise, contact your retailer immediately.
- Refer to the Supermicro website for updates on CPU support.

Installing the LGA1155 Processor

1. Press the load lever to release the load plate, which covers the CPU socket, from its locking position.

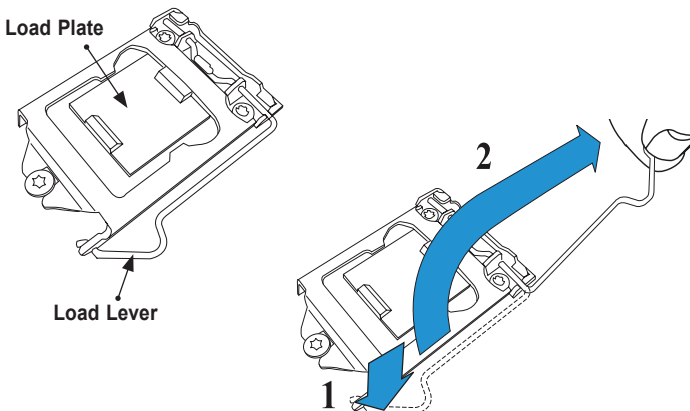

2. Gently lift the load lever to open the load plate. Remove the plastic cap.

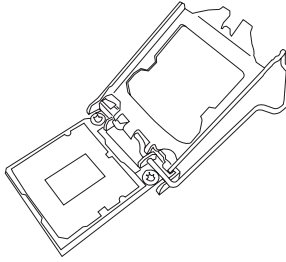

3. Use your thumb and your index finger to hold the CPU at the North center edge and the South center edge of the CPU.

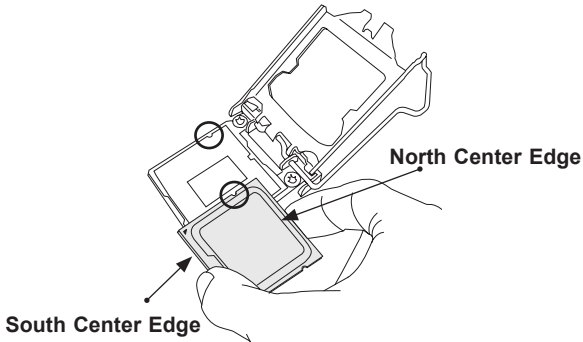

4. Align the CPU key that is the semi-circle cutouts against the socket keys. Once it is aligned, carefully lower the CPU straight down into the socket. (Do not drop the CPU on the socket. Do not move the CPU horizontally or vertically.)

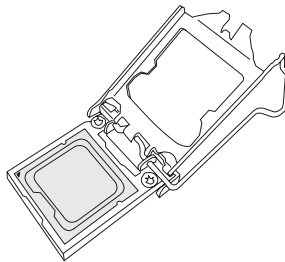

5. Do not rub the CPU against the surface or against any pins of the socket to avoid damaging the CPU or the socket.)

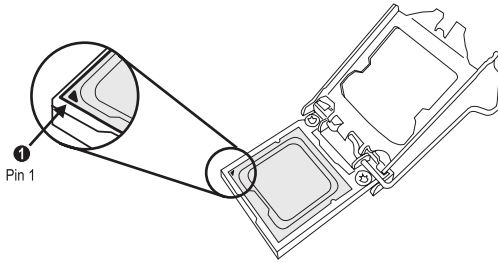

6. With the CPU inside the socket, inspect the four corners of the CPU to make sure that the CPU is properly installed.
7. Use your thumb to gently push the load lever down to the lever lock.

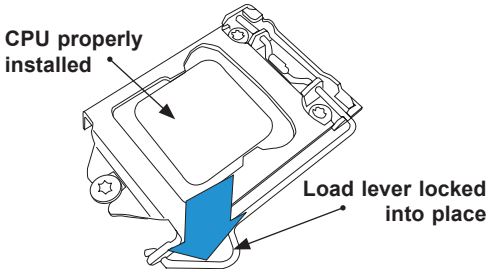

Warning: You can only install the CPU inside the socket only in one direction. Make sure that it is properly inserted into the CPU socket before closing the load plate. If it doesn't close properly, do not force it as it may damage your CPU. Instead, open the load plate again and double-check that the CPU is aligned properly.

Installing a Passive CPU Heatsink

1. Do not apply any thermal grease to the heatsink or the CPU die -- the required amount has already been applied.
2. Place the heatsink on top of the CPU so that the four mounting holes are aligned with those on the Motherboard's and the Heatsink Bracket underneath.
3. Screw in two diagonal screws (i.e., the #1 and the #2 screws) until just snug (-do not over-tighten the screws to avoid possible damage to the CPU.)
4. Finish the installation by fully tightening all four screws.

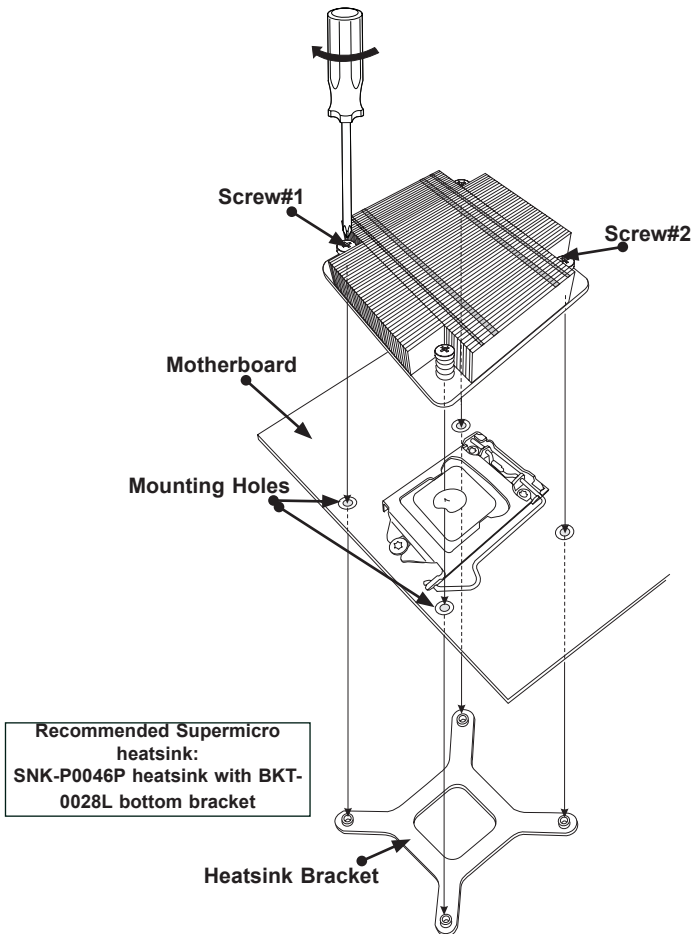

Removing the Heatsink

Warning: We do not recommend that the CPU or the heatsink be removed. However, if you do need to uninstall the heatsink, please follow the instructions below to uninstall the heatsink to prevent damage done to the CPU or the CPU socket.

1. Unscrew the heatsink screws from the motherboard in the sequence as shown in the illustration below.
2. Gently wriggle the heatsink to loosen it from the CPU. (Do not use excessive force when wriggling the heatsink!!)
3. Remove the heatsink, then remove the CPU from the CPU socket.
4. Clean the surface of the CPU and the heatsink, removing the used thermal grease. Reapply the proper amount of thermal grease on the surface before re-installing the CPU and the heatsink.

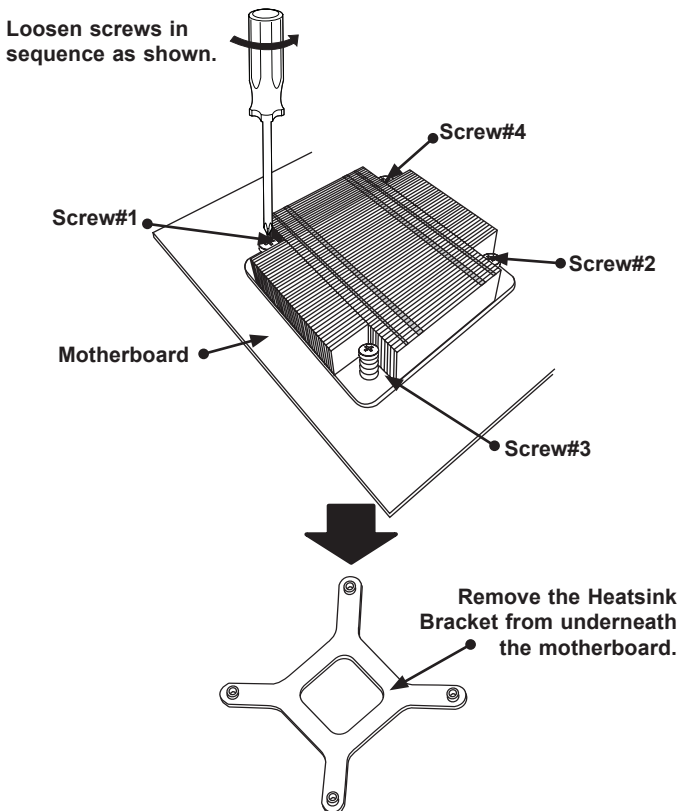

Installing an Active Fan CPU Heatsink

1. Locate the CPU Fan power connector on the motherboard. (Refer to the layout on the right for the CPU Fan location.)
2. Position the heatsink so that the heatsink fan wires are closest to the CPU fan power connector and are not interfered with other components.
3. Inspect the CPU Fan wires to make sure that the wires are routed through the bottom of the heatsink.
4. Remove the thin layer of the protective film from the copper core of the heatsink.

Warning: CPU may overheat if the protective film is not removed from the heatsink.

5. Apply the proper amount of thermal grease on the CPU.

 **Note:** If your heatsink came with a thermal pad, please ignore this step.

6. If necessary, rearrange the wires to make sure that the wires are not pinched between the heatsink and the CPU. Also make sure to keep clearance between the fan wires and the fins of the heatsink.
7. Align the four heatsink fasteners with the mounting holes on the

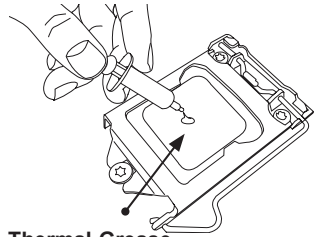

Thermal Grease

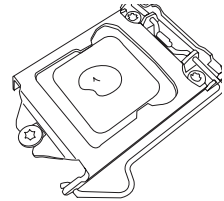

Heatsink Fins

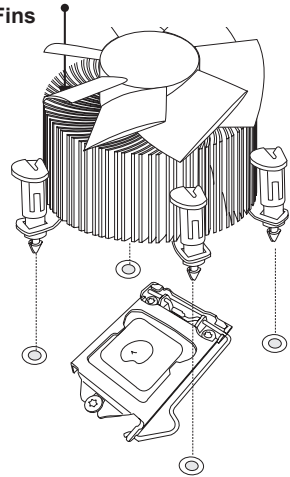

**Recommended Supermicro heatsink:
SNK-P0046A4 active heatsink**

motherboard. Gently push the pairs of diagonal fasteners (#1 & #2, and #3 & #4) into the mounting holes until you hear a click. Also, make sure to orient each fastener so that the narrow end of the groove is pointing outward.

8. Repeat Step 7 to insert all four heatsink fasteners into the mounting holes.
9. Once all four fasteners are securely inserted into the mounting holes, and the heatsink is properly installed on the motherboard, connect the heatsink fan wires to the CPU Fan connector.

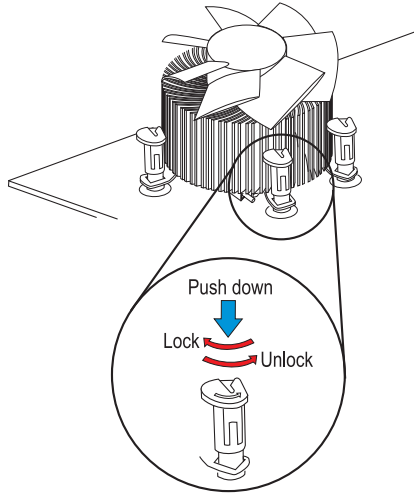

Removing the Heatsink

Warning: We do not recommend that the CPU or the heatsink be removed. However, if you do need to remove the heatsink, please follow the instructions below to remove the heatsink and to prevent damage done to the CPU or other components.

Active Heatsink Removal

1. Unplug the power cord from the power supply.
2. Disconnect the heatsink fan wires from the CPU fan header.
3. Use your finger tips to gently press on the fastener cap and turn it counterclockwise to make a 1/4 (90°) turn, and pull the fastener upward to loosen it.
4. Repeat Step 3 to loosen all fasteners from the mounting holes.
5. With all fasteners loosened, remove the heatsink from the CPU.

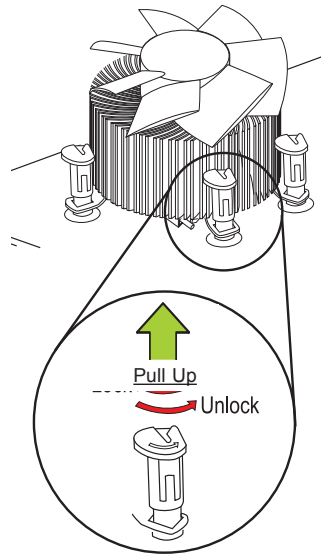
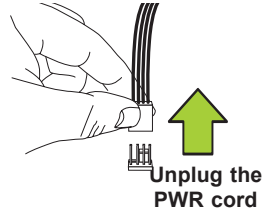

2-3 Installing DDR3 Memory

 **Note:** Check the Supermicro website for recommended memory modules.



CAUTION

Exercise extreme care when installing or removing DIMM modules to prevent any possible damage.

DIMM Installation

1. Insert the desired number of DIMMs into the memory slots, starting with DIMM2A. (For best performance, please use the memory modules of the same type and speed in the same bank.)
2. Push the release tabs outwards on both ends of the DIMM slot to unlock it.
3. Align the key of the DIMM module with the receptive point on the memory slot.
4. Align the notches on both ends of the module against the receptive points on the ends of the slot.

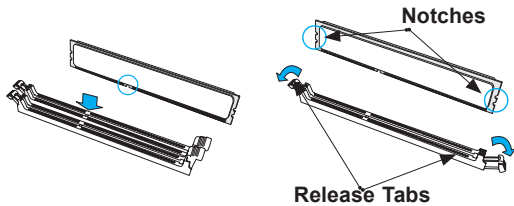
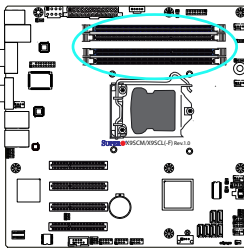

5. Use two thumbs together to press the notches on both ends of the module straight down into the slot until the module snaps into place.

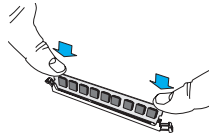

Press both notches straight down into the memory slot.

6. Press the release tabs to the lock positions to secure the DIMM module into the slot.

Removing Memory Modules

Reverse the steps above to remove the DIMM modules from the motherboard.

Memory Support

The X9SCM/X9SCL series supports up to 32GB of Unbuffered (UDIMM) DDR3 ECC 1600/1333/1066 MHz DIMMs in 4 memory slots.

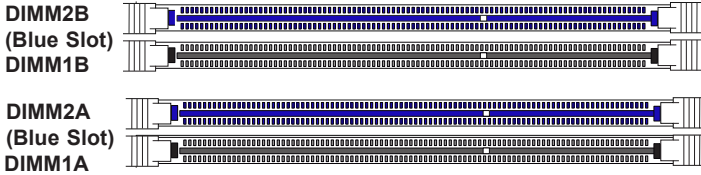

Memory Population Guidelines

When installing memory modules, the DIMM slots should be populated in the following order: DIMM2A, DIMM2B, DIMM1A and DIMM1B.

- Always use DDR3 DIMM modules of the same size, type and speed.
- Mixed DIMM speeds can be installed. However, all DIMMs will run at the speed of the slowest DIMM.
- The motherboard will support one DIMM module or three DIMM modules installed, but it is recommended that a balanced DIMM population (installed in pairs) are followed for best performance.

Recommended Population (Balanced)				
DIMM2A Slot	DIMM2B Slot	DIMM1A Slot	DIMM1B Slot	Total System Memory
2GB DIMM	2GB DIMM			4GB
2GB DIMM	2GB DIMM	2GB DIMM	2GB DIMM	8GB
4GB DIMM	4GB DIMM			8GB
4GB DIMM	4GB DIMM	4GB DIMM	4GB DIMM	16GB
8GB DIMM	8GB DIMM			16GB
8GB DIMM	8GB DIMM	8GB DIMM	8GB DIMM	32GB



Note: For memory speed 1600 MHz support, an E3-1200 v2 CPU is required.

The table explains the different types of memory supported that can be accommodated in each memory slot.

DDR3 Unbuffered ECC (UDIMM) Memory				
DIMM Slots per Channel	DIMMs Populated per Channel	DIMM Type	POR Speeds	Ranks per DIMM (any combination)
2	1	Unbuffered DDR3	1066, 1333	Single Rank, Dual Rank
2	2	Unbuffered DDR3	1066, 1333	Single Rank, Dual Rank

Note: Due to memory allocation to system devices, the amount of memory that remains available for operational use will be reduced when 4 GB of RAM is used. The reduction in memory availability is disproportional.

For Microsoft Windows users: Microsoft implemented a design change in the Windows XP with Service Pack 2 (SP2) and Windows Vista. This change is specific to the behavior of Physical Address Extension (PAE) mode which improves driver compatibility. For more information, please read the following article at Microsoft's Knowledge Base website at: <http://support.microsoft.com/kb/888137>.

Possible System Memory Allocation & Availability		
System Device	Size	Physical Memory Remaining (-Available) (4 GB Total System Memory)
Firmware Hub flash memory (System BIOS)	1 MB	3.99
Local APIC	4 KB	3.99
Area Reserved for the chipset	2 MB	3.99
I/O APIC (4 Kbytes)	4 KB	3.99
PCI Enumeration Area 1	256 MB	3.76
PCI Express (256 MB)	256 MB	3.51
PCI Enumeration Area 2 (if needed) -Aligned on 256-MB boundary-	512 MB	3.01
VGA Memory	16 MB	2.85
TSEG	1 MB	2.84
Memory available to OS and other applications		2.84

2-4 Motherboard Installation

All motherboards have standard mounting holes to fit different types of chassis. Make sure that the locations of all the mounting holes for both motherboard and chassis match. Although a chassis may have both plastic and metal mounting fasteners, metal ones are highly recommended because they ground the motherboard to the chassis. Make sure that the metal standoffs click in or are screwed in tightly. Then use a screwdriver to secure the motherboard onto the motherboard tray.

Tools Needed



Location of Mounting Holes

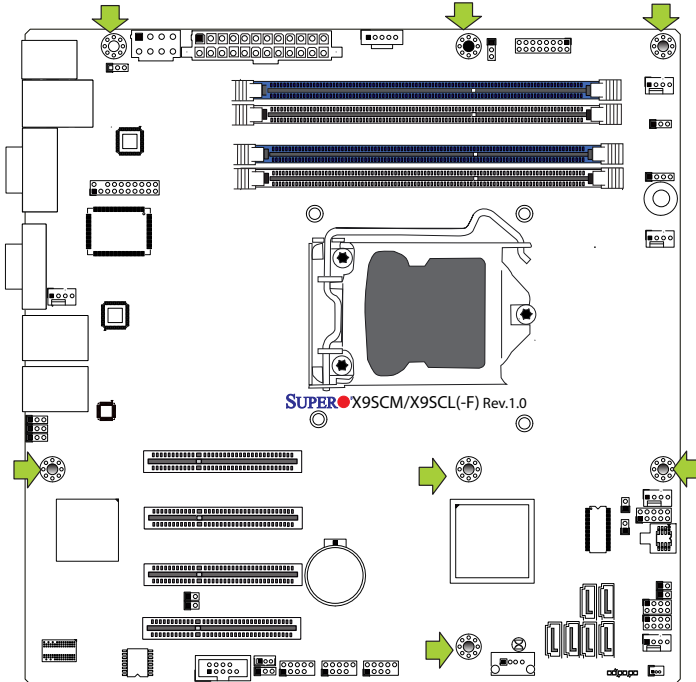

Caution: 1) To prevent damage to the motherboard and its components, please do not use a force greater than 8 lb/inch on each mounting screw during motherboard installation. 2) Some components are very close to the mounting holes. Please take precautionary measures to avoid damaging these components when installing the motherboard to the chassis.

Installing the Motherboard

1. Install the I/O shield into the chassis.

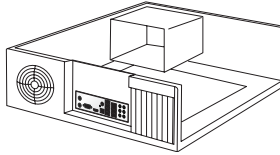

2. Locate the mounting holes on the motherboard.
3. Locate the matching mounting holes on the chassis. Align the mounting holes on the motherboard against the mounting holes on the chassis.
4. Install standoffs in the chassis as needed.

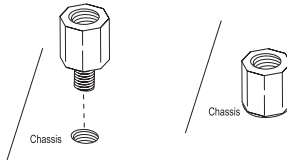

5. Install the motherboard into the chassis carefully to avoid damaging motherboard components.
6. Using the Philips screwdriver, insert a Pan head #6 screw into a mounting hole on the motherboard and its matching mounting hole on the chassis.

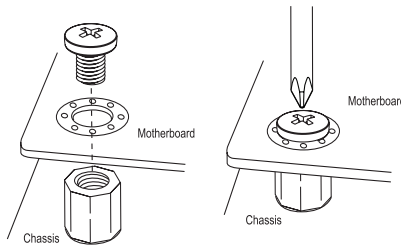

7. Repeat Step 5 to insert #6 screws into all mounting holes.
8. Make sure that the motherboard is securely placed in the chassis.

 **Note:** Images displayed are for illustration only. Your chassis or components might look different from those shown in this manual.

2-5 Connectors/I/O Ports

The I/O ports are color coded in conformance with the industry standards. See the figure below for the colors and locations of the various I/O ports.

Back I/O Panel

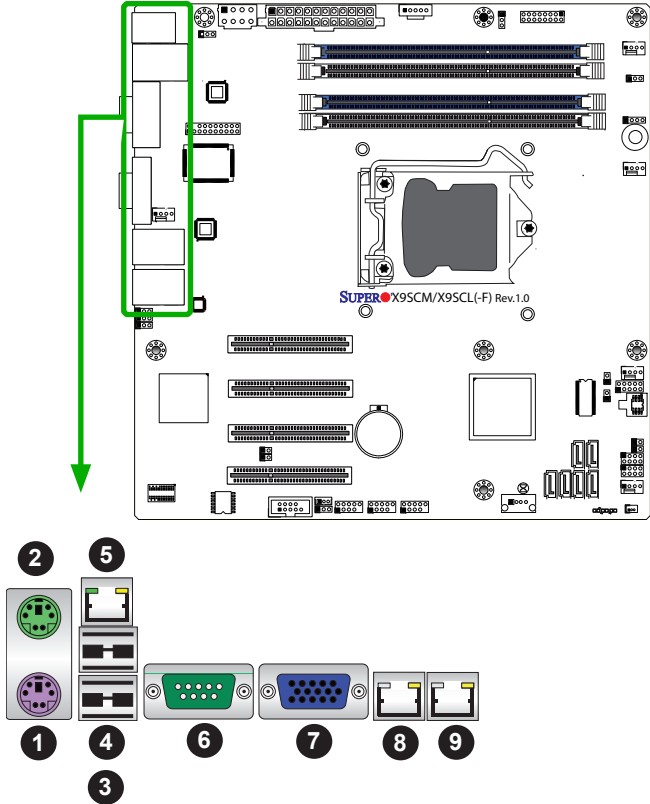

Back I/O Panel	
1. Keyboard (Purple)	6. COM 1
2. PS/2 Mouse (Green)	7. VGA
3. USB Port 0	8. LAN1
4. USB Port 1	9. LAN2
5. IPMI LAN (X9SCM-F/X9SCL-F/X9SCL+-F Only)	

ATX PS/2 Keyboard/Mouse Ports

The ATX PS/2 keyboard and PS/2 mouse are located next to the Back Panel USB Ports 0/1 on the motherboard. See the table at right for pin definitions.

PS/2 Keyboard/Mouse Pin Definitions			
PS2 Keyboard		PS2 Mouse	
Pin#	Definition	Pin#	Definition
1	KB Data	1	Mouse Data
2	No Connection	2	No Connection
3	Ground	3	Ground
4	Mouse/KB VCC (+5V)	4	Mouse/KB VCC (+5V)
5	KB Clock	5	Mouse Clock
6	No Connection	6	No Connection

VCC: with 1.5A PTC (current limit)

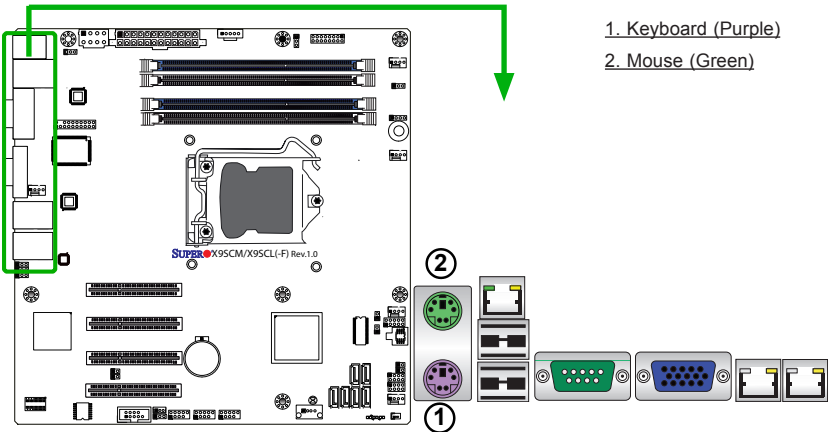
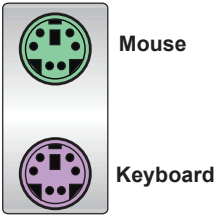

Universal Serial Bus (USB)

Two Universal Serial Bus ports (USB 0/1) are located on the I/O back panel. In addition, six USB connections (USB 2/3, USB 4/5, USB 12/13) are used to provide front chassis access. USB 11 is a Type A Connector. (USB Cables are not included). See the tables on the right for pin definitions.

Back Panel USB 0/1 Pin Definitions			
Pin#	Definition	Pin#	Definition
1	+5V	5	+5V
2	USB_PN0	6	USB_PN1
3	USB_PP0	7	USB_PP1
4	Ground	8	Ground

Front Panel USB 2/3, 4/5, 12/13 Pin Definitions			
USB 2/4/12/11		USB 3/5/13	
Pin #	Definition	Pin #	Definition
1	+5V	6	+5V
2	USB_PN2	7	USB_PN3
3	USB_PP2	8	USB_PP3
4	Ground	9	Ground
5	No Connection	10	Key

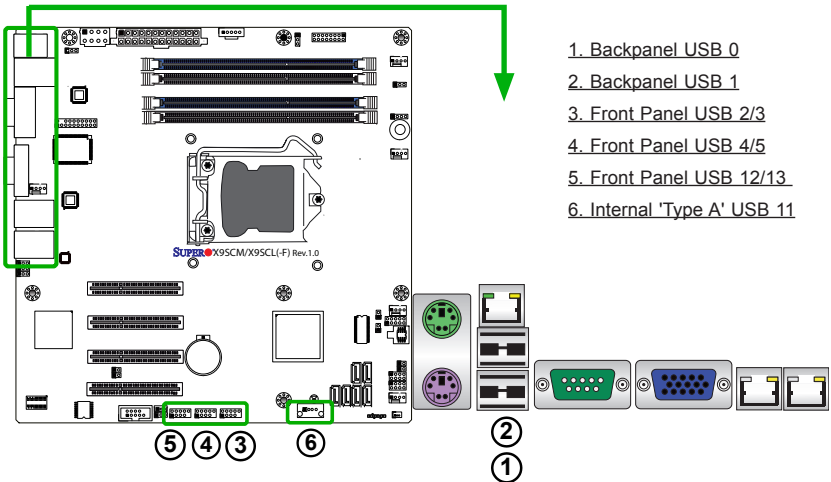

Ethernet Ports

Two Ethernet ports (LAN1/LAN2) are located next to the VGA port on the I/O Backpanel. In addition, an IPMI Dedicated LAN is also located above USB 0/1 ports on the X9SCM-F/X9SCL-F/X9SCL+-F to provide a dedicated network connection for IPMI 2.0. These ports accept RJ45 type cables.

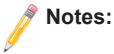

Notes:

1. The IPMI Dedicated LAN is for the X9SCM-F/X9SCL-F/X9SCL+-F only.
2. Please refer to the LED Indicator Section for LAN LED information.

LAN Ports Pin Definition			
Pin#	Definition		
1	TD0-	10	SGND
2	TD0+	11	P3V3SB
3	TD1-	12	Act LED
4	TD1+	13	Link 100 LED (Green, +3V3SB)
5	TD2-	14	Link 1000 LED (Yellow, +3V3SB)
6	TD2+	15	Ground
7	TD3-	16	Ground
8	TD3+	17	Ground
9	P2V5SB	88	Ground

(NC: No Connection)

1. LAN1
2. LAN2
3. IPMI Dedicated LAN (X9SCM-F/
X9SCL-F/X9SCL+-F only)

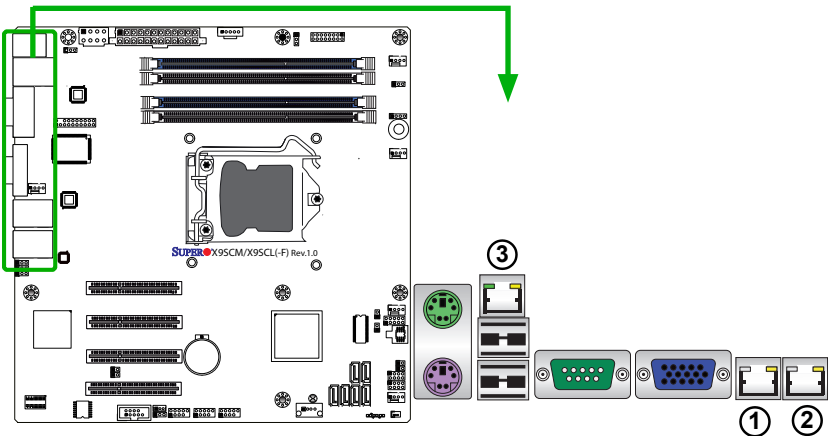

Serial Ports

A COM Port (COM1) is located on the I/O backpanel, and another Serial Connection (COM2) is located below PCI-E Slot4 to provide front access. See the table on the right for pin definitions.

Serial Port Pin Definitions (COM1/COM2)			
Pin #	Definition	Pin #	Definition
1	DCD	6	DSR
2	RXD	7	RTS
3	TXD	8	CTS
4	DTR	9	RI
5	Ground	10	NC

1. COM1

2. COM2

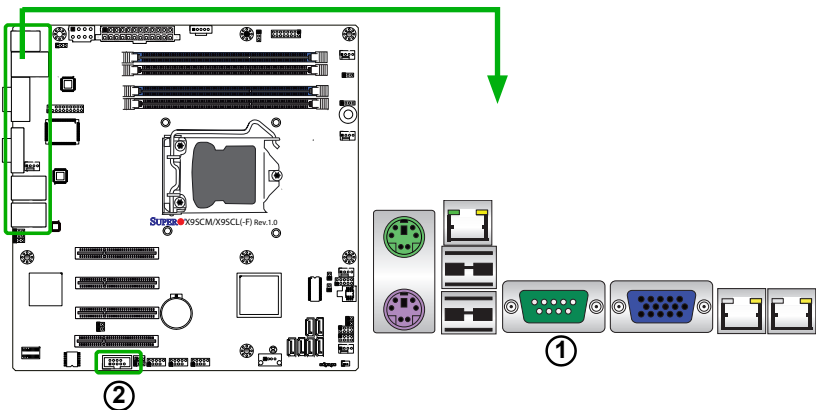

Video Connector

A Video (VGA) connector is located next to the COM Port on the I/O backpanel. This connector is used to provide video and CRT display. Refer to the board layout below for the location.

VGA/CRT Pin Definitions			
Pin#	Definition	Pin#	Definition
1	Red	10	Ground
2	Green	11	NC
3	Blue	12	MS1: SDA (DDC Data)
4	NC	13	HSYNSC
5	Ground	14	VSYSNC
6	Ground	15	MS3: SCL (DDC CLK)
7	Ground	16	Case
8	Ground	17	Case
9	5V		

NC= No Connection

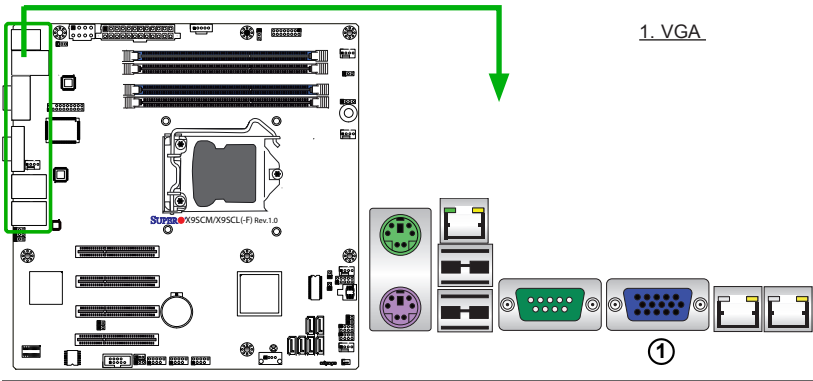

Front Control Panel

JF1 contains header pins for various buttons and indicators that are normally located on a control panel at the front of the chassis. These connectors are designed specifically for use with Supermicro server chassis. See the figure below for the descriptions of the various control panel buttons and LED indicators. Refer to the following section for descriptions and pin definitions.

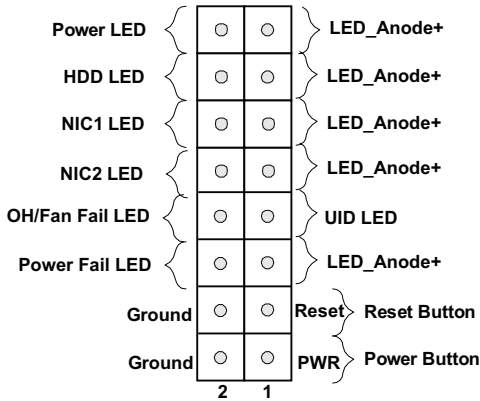

JF1 Header Pins

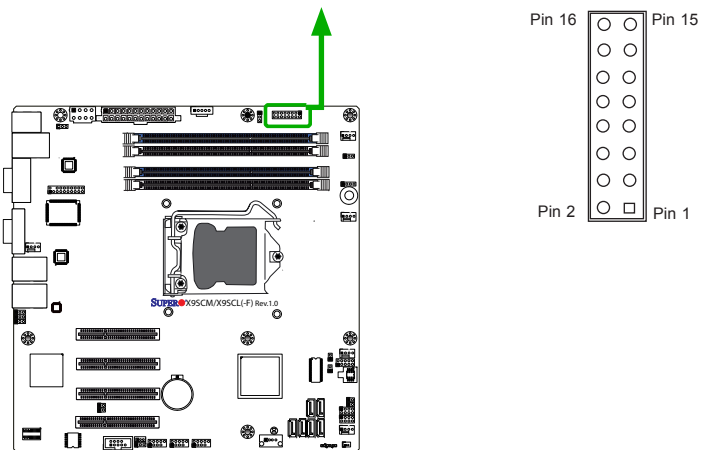

Front Control Panel Pin Definitions

Power LED

The Power LED connection is located on pins 15 and 16 of JF1. Refer to the table on the right for pin definitions.

Power LED Pin Definitions (JF1)	
Pin#	Definition
15	3.3V/vcc
16	Ground

HDD LED

The HDD LED connection is located on pins 13 and 14 of JF1. Attach a cable here to indicate the status of HDD-related activities, including IDE, SATA activities. See the table on the right for pin definitions.

HDD LED Pin Definitions (JF1)	
Pin#	Definition
13	3.3V/vcc
14	HD Active

A. PWR LED

B. HDD LED

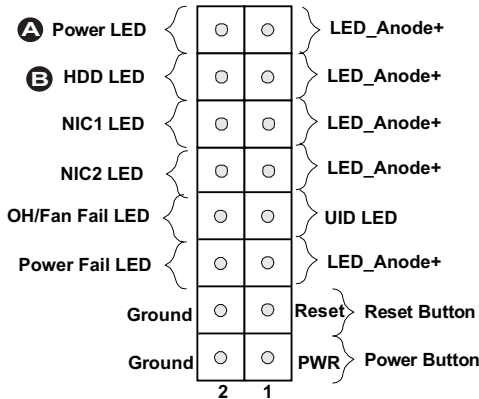

NIC1/NIC2 (LAN1/LAN2)

The NIC (Network Interface Controller) LED connection for LAN port 1 is located on pins 11 and 12 of JF1, and the LED connection for LAN Port 2 is on Pins 9 and 10. NIC1 LED and NIC2 LED are 2-pin NIC LED headers. Attach NIC LED cables to NIC1 and NIC2 LED indicators to display network activities. Refer to the table on the right for pin definitions.

LAN1/LAN2 LED Pin Definitions (JF1)	
Pin#	Definition
9/11	Vcc
10/12	LAN Active

Overheat (OH)/Fan Fail/Front UID LED

Connect an LED cable to the Front UID and OH/Fan Fail connections on pins 7 and 8 of JF1 to display UID (Unit ID) signals or to provide advanced warnings for chassis overheating/fan failure. Refer to the table on the right for pin definitions.

OH/Fan Fail LED Pin Definitions (JF1)	
Pin#	Definition
7	Vcc/Blue UID LED
8	OH/Fan Fail LED

OH/Fan Fail Indicator Status	
State	Definition
Off	Normal
On	Overheat
Flash- ing	Fan Fail

A. NIC1 LED

B. NIC2 LED

C. OH/Fan Fail/UID LED

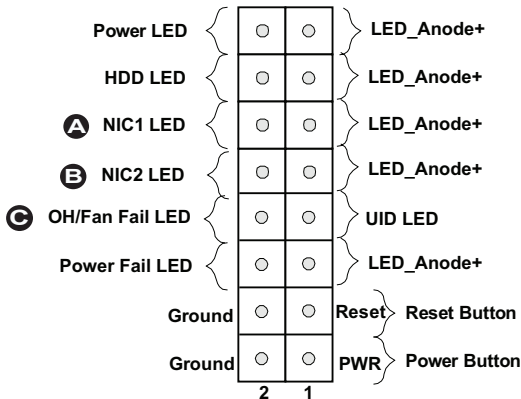

Reset Button

The Reset Button connection is located on pins 3 and 4 of JF1. Attach it to a hardware reset switch on the computer case to reset the system. Refer to the table on the right for pin definitions.

Reset Button Pin Definitions (JF1)	
Pin#	Definition
3	Reset
4	Ground

Power Button

The Power Button connection is located on pins 1 and 2 of JF1. Momentarily contacting both pins will power on/off the system. This button can also be configured to function as a suspend button (with a setting in the BIOS - see Chapter 4). To turn off the power in the suspend mode, press the button for at least 4 seconds. Refer to the table on the right for pin definitions.

Power Button Pin Definitions (JF1)	
Pin#	Definition
1	Signal
2	Ground

[A. Reset Button](#)

[B. PWR Button](#)

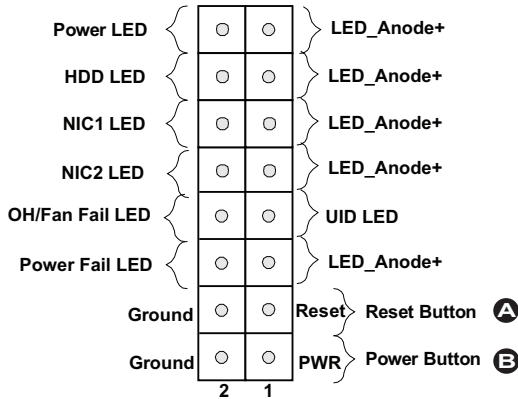

2-6 Connecting Cables

This section provides brief descriptions and pin-out definitions for onboard headers and connectors. Be sure to use the correct cable for each header or connector. For information on Backpanel USB and Front Panel USB ports, refer to Page 2-17. For COM Port 1 and COM Port 2, please see Page 2-19.

ATX Main PWR & CPU PWR Connectors

The 24-pin main power connector (JPW1) is used to provide power to the motherboard. The 8-pin connector (JPW2) is also required for the processor. These power connectors meet the SSI EPS 12V specification. See the table on the right for pin definitions. **Note:** The 8-pin JPW2 will also support one 4-pin power connector.

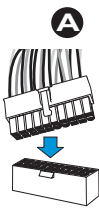

24-Pin Main PWR

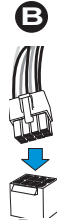

8-Pin/4-pin Processor PWR

**ATX Power 24-pin Connector
Pin Definitions (JPW1)**

Pin#	Definition	Pin #	Definition
13	+3.3V	1	+3.3V
14	-12V	2	+3.3V
15	COM	3	COM
16	PS_ON	4	+5V
17	COM	5	COM
18	COM	6	+5V
19	COM	7	COM
20	Res (NC)	8	PWR_OK
21	+5V	9	5VSB
22	+5V	10	+12V
23	+5V	11	+12V
24	COM	12	+3.3V

**12V 8-pin Power Connector
Pin Definitions**

Pins	Definition
1 through 4	Ground
5 through 8	+12V

(Required)

A. 24-Pin ATX Main PWR

B. 8-Pin Processor PWR

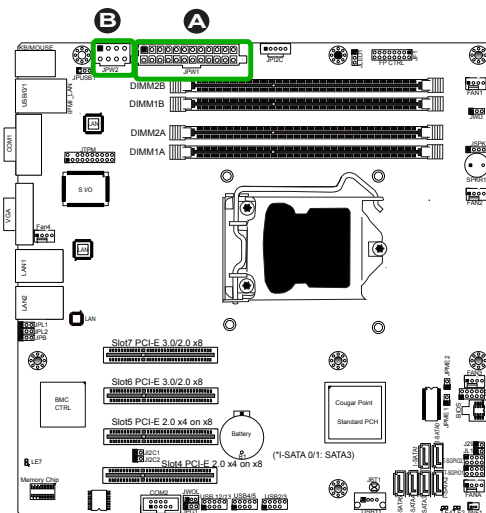

Fan Headers

The X9SCM/X9SCM-F/X9SCL/X9SCL-F/X9SCL+-F has five fan headers (Fan 1~Fan 4 and Fan A). These are 4-pin fan headers. A fan speed control setting in the BIOS Hardware Monitoring section allows the BIOS to automatically set fan speeds based on the system temperature. Refer to the table on the right for pin definitions and fan designations.

 **Note:** Please use 4-pin fans only. Though 3-pin fans will still work on this motherboard, they will only run at full speed and cannot be automatically controlled.

Fan Header Pin Definitions	
Pin#	Definition
1	Ground (Black)
2	2.5A/+12V (Red)
3	Tachometer
4	PWM_Control

Fan Header Designations	
Fan#	Use with
Fan1-Fan4	CPU/Memory Zone
FanA	I/O/Add-on Cards

Chassis Intrusion

A Chassis Intrusion header is located at JL1 on the motherboard. Attach the appropriate cable from the chassis to inform you of a chassis intrusion when the chassis is opened.

Chassis Intrusion Pin Definitions (JL1)	
Pin#	Definition
1	Intrusion Input
2	Ground

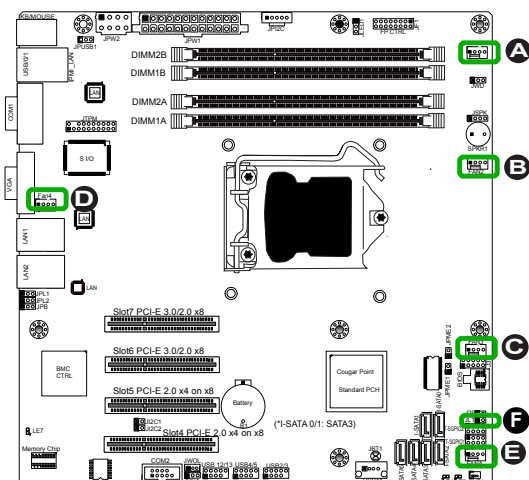

- A. Fan 1
- B. Fan 2
- C. Fan 3
- D. Fan 4
- E. Fan A
- F. Chassis Intrusion

Internal Buzzer

The Internal Buzzer (SPKR1) can be used to provide audible indications for various beep codes. See the table on the right for pin definitions.

Internal Buzzer Pin Definition		
Pin#	Definitions	
Pin 1	Pos. (+)	Beep In
Pin 2	Neg. (-)	Alarm Speaker

Speaker

On the JSPK header, Pins 3~4 are used for internal speaker. Close Pins 3~4 with a cap to use the onboard speaker. If you wish to use an external speaker, close Pins 1~4 with a cable. See the table on the right for pin definitions.

Speaker Connector Pin Definitions	
Pin Setting	Definition
Pins 3~4	Internal Speaker
Pins 1~4	External Speaker

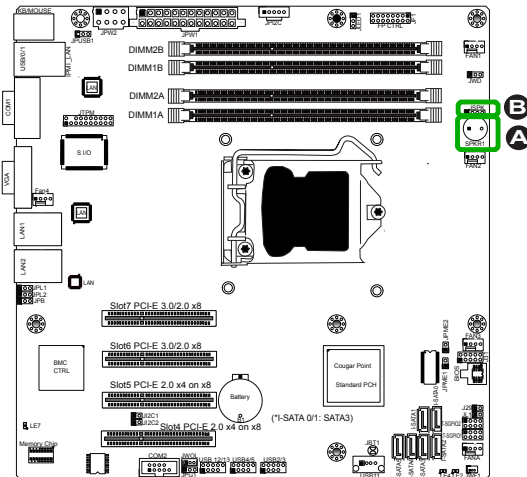

- A. Internal Buzzer
- B. Speaker Header

Onboard Power LED

An onboard Power LED header is located at JLED1. This Power LED header is connected to Front Control Panel located at JF1 to indicate the status of system power. See the table on the right for pin definitions.

Onboard PWR LED Pin Definitions	
Pin#	Definition
1	VCC
2	No Connection
3	Connection to PWR LED in JF1

Power Supply I²C Connector

Power Supply I²C Connector, located at JPI²C, monitors the status of the power supply, fan and system temperature. See the table on the right for pin definitions.

PWR Supply I ² C Pin Definitions	
Pin#	Definition
1	Clock
2	Data
3	PWR Fail
4	Ground
5	3.3V

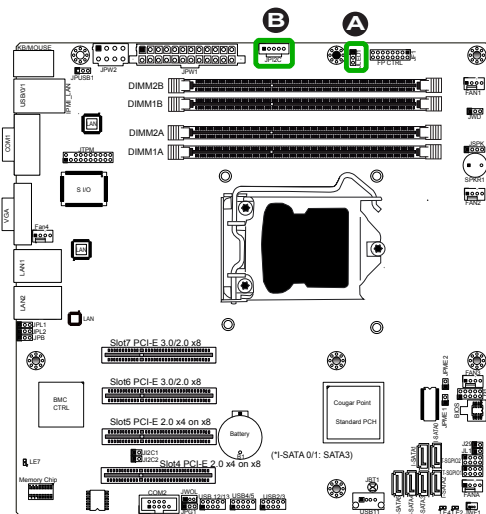

- A. PWR LED
- B. PWR SMB

T-SGPIO 0/1 Headers

Two T-SGPIO (Serial-Link General Purpose Input/Output) headers are located near the SATA connectors on the motherboard. These headers are used to communicate with the enclosure management chip in the system. See the table on the right for pin definitions. Refer to the board layout below for the locations of the headers.

Serial_Link-SGPIO Pin Definitions			
Pin#	Definition	Pin	Definition
1	NC	2	NC
3	Ground	4	DATA Out
5	Load	6	Ground
7	Clock	8	NC

NC: No Connections

TPM Header

This header is used to connect a Trusted Platform Module (TPM), which is available from a third-party vendor. A TPM is a security device that supports encryption and authentication in hard drives. It enables the motherboard to deny access if the TPM associated with the hard drive is not installed in the system. See the table on the right for pin definitions.

Trusted Platform Module Header Pin Definitions			
Pin #	Definition	Pin #	Definition
1	LCLK	2	GND
3	LFRAME	4	No Pin
5	LRESET	6	VCC5
7	LAD3	8	LAD2
9	VCC3	10	LAD1
11	LAD0	12	GND
13	RSV0	14	RSV1
15	SB3V	16	SERIRQ
17	GND	18	CLKRUN
19	LPCPD	20	RSV2

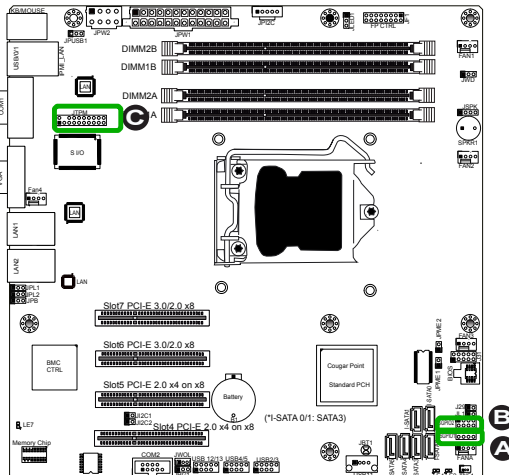

A. T-SGPIO 0

B. T-SGPIO 1

C. TPM Header

DOM PWR Connector

The Disk-On-Module (DOM) power connector, located at JWF1, provides 5V (Gen1/Gen) power to a solid_state DOM storage device connected to one of the SATA ports. See the table on the right for pin definitions.

DOM PWR Pin Definitions	
Pin#	Definition
1	5V
2	Ground
3	Ground

Wake-On-LAN

The Wake-On-LAN header is located at JWOL on the motherboard. See the table on the right for pin definitions. (You must also have a LAN card with a Wake-On-LAN connector and cable to use this feature.)

Wake-On-LAN Pin Definitions (JWOL)	
Pin#	Definition
1	+5V Standby
2	Ground
3	Wake-up

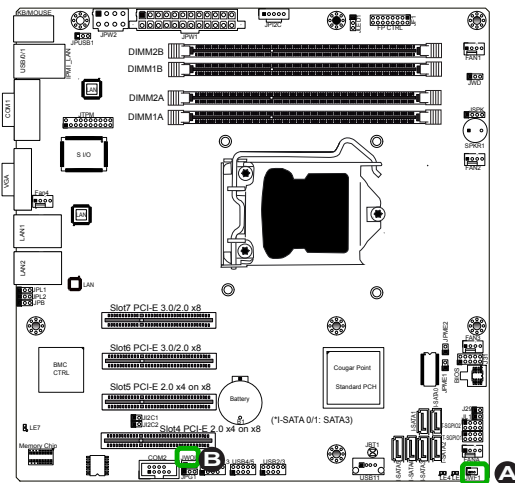

A. DOM PWR

B. WOL

2-7 Jumper Settings

Explanation of Jumpers

To modify the operation of the motherboard, jumpers can be used to choose between optional settings. Jumpers create shorts between two pins to change the function of the connector. Pin 1 is identified with a square solder pad on the printed circuit board.

 **Note:** On two-pin jumpers, "Closed" means the jumper is on, and "Open" means the jumper is off the pins.

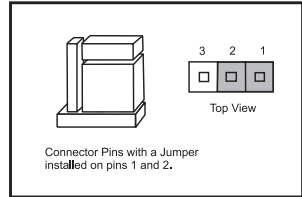
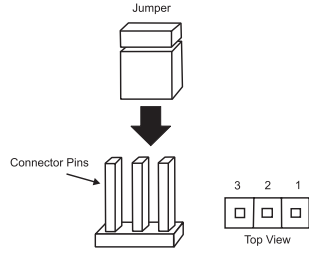

LAN Port Enable/Disable

Jumpers JPL1/JPL2 enable or disable LAN Port 1/LAN Port 2 on the motherboard. See the table on the right for jumper settings. The default setting is enabled.

GLAN Enable Jumper Settings	
Pin#	Definition
1-2	Enabled (default)
2-3	Disabled

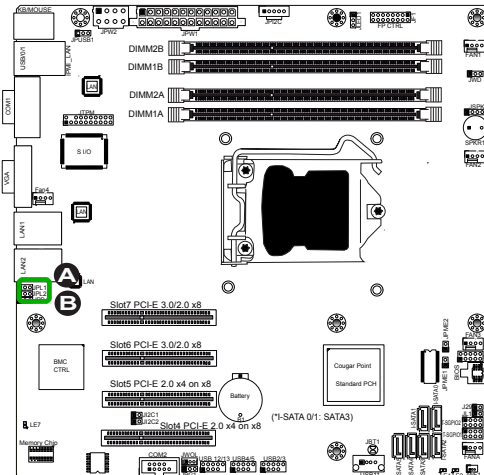

A. LAN Port 1 Enable

B. LAN Port 2 Enable

CMOS Clear

JBT1 is used to clear CMOS. Instead of pins, this "jumper" consists of contact pads to prevent accidental clearing of CMOS. To clear CMOS, use a metal object such as a small screwdriver to touch both pads at the same time to short the connection. Always remove the AC power cord from the system before clearing CMOS. 

 **Note:** For an ATX power supply, you must completely shut down the system, remove the AC power cord and then short JBT1 to clear CMOS.

PCI Slot SMB Enable

Use Jumpers J²C1/J²C2 to enable PCI SMB (System Management Bus) support to improve system management for the PCI slots. See the table on the right for jumper settings.

PCI Slot_SMB Enable Jumper Settings	
Jumper Setting	Definition
Short	Enabled
Open (Default)	Disabled

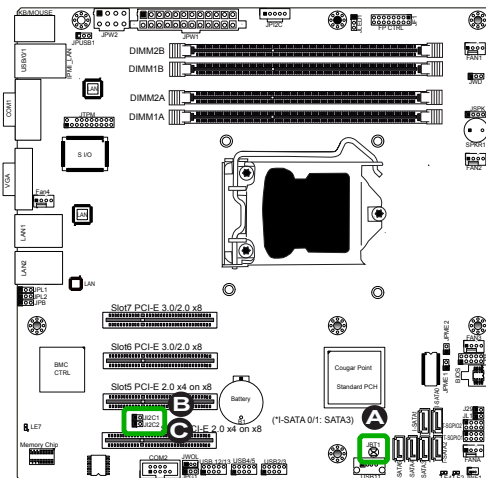

- A. Clear CMOS
- B. J1²C1
- C. J1²C2

VGA Enable

JPG1 allows you to enable or disable the onboard VGA connector. The default position is on pins 1 and 2 to enable VGA. See the table on the right for jumper settings.

VGA Enable/Disable Jumper Settings (JPG1)	
Both Jumpers	Definition
Pins 1-2	Enabled
Pins 2-3	Disabled

Watch Dog Enable

Watch Dog (JWD) is a system monitor that can reboot the system when a software application hangs. Close Pins 1-2 to reset the system if an application hangs. Close Pins 2-3 to generate a non-maskable interrupt signal for the application that hangs. See the table on the right for jumper settings. Watch Dog must also be enabled in the BIOS.

Watch Dog Jumper Settings	
Jumper Setting	Definition
Pins 1-2	Reset (default)
Pins 2-3	NMI
Open	Disabled

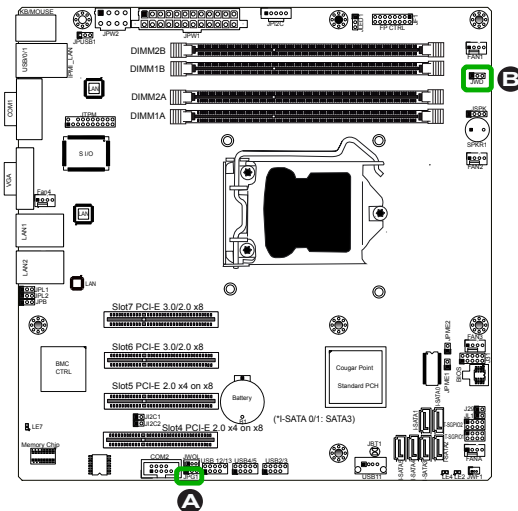

A. VGA Enable

B. Watch Dog Timer Enable

USB Wake-Up

Use the jumper JPUSB1 to "wake-up" your system by pressing a key on a USB keyboard or clicking the USB mouse connected to the Backplane USB Ports 0/1. JPUSB1 is used together with a USB Wake-Up feature in the BIOS. Enable this jumper and the USB support in the BIOS to wake up your system via USB devices.

 **Note:** When the USB is set to Enabled in the BIOS, and JPUSB1 is set to Disabled, remove the USB devices from Backplane USB Ports 0/1 before the system goes into the standby mode.

JPUSB1 (Backplane USB 0/1 Wake-up Enable)	
Pin#	Definition
1-2	Enabled (Default)
2-3	Disabled

BMC Enable

JPB is used to enable or disable the BMC (Baseboard Management Control) chip and the onboard IPMI connection. This jumper is used together with the IPMI settings in the BIOS. See the table on the right for jumper settings.

BMC IPMI Enable/Disable Jumper Settings	
Settings	Definition
Pins 1-2	Enabled (Default)
Pins 2-3	Disabled

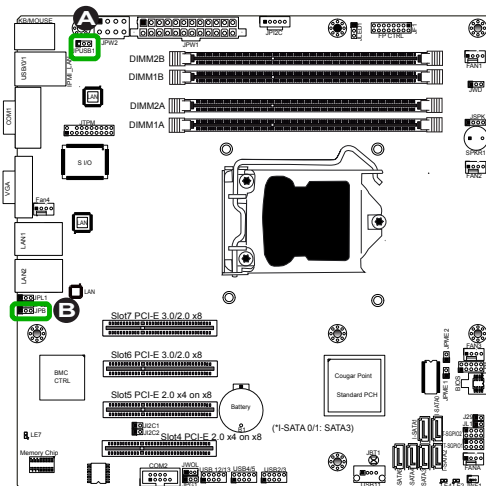

A. BP USB 0/1 Wake-up

B. BMC Enable

ME Recovery

When enabled, Intel ME Recovery (JPME1) is used to update the ME (Management Engine) firmware. When disabled, the firmware is protected.

ME Recovery (JPME1)	
Pin#	Definition
1-2	Enabled
Open	Normal (Default)

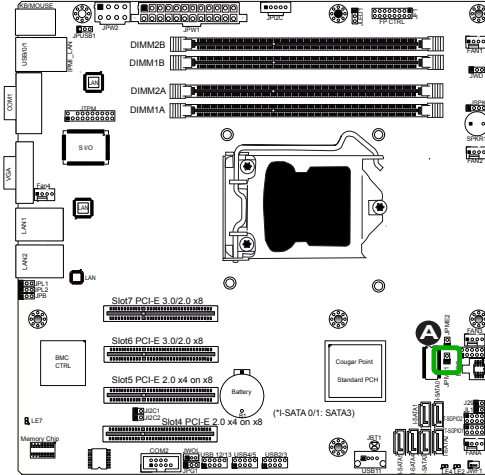

A. JPME1

2-8 Onboard Indicators

LAN 1/LAN 2 LEDs

Two LAN ports (LAN 1/LAN 2) are located on the I/O backpanel of the motherboard. Each Ethernet LAN port has two LEDs. The yellow LED indicates activity, while the Link LED may be green, amber, or off to indicate the speed of the connections. See the tables at right for more information.

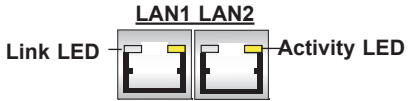

LAN 1/LAN 2 Link LEDs (Green/Amber/Off)	
LED Color	Definition
Off	No Connection or 10 Mbps
Green	100 Mbps
Amber	1 Gbps

IPMI Dedicated LAN LEDs

In addition to LAN 1/LAN 2, an IPMI Dedicated LAN is also located on the X9SCM-F/X9SCL-F/X9SCL+-F. The yellow LED on the right indicates activity, while the green LED on the left indicates the speed of the connection. See the tables at right for more information.

IPMI LAN Link LED (Left) & Activity LED (Right)		
Status	Color	Definition
Link (Left)	Green: Solid	100 Mbps
Activity (Right)	Yellow: Blinking	Active

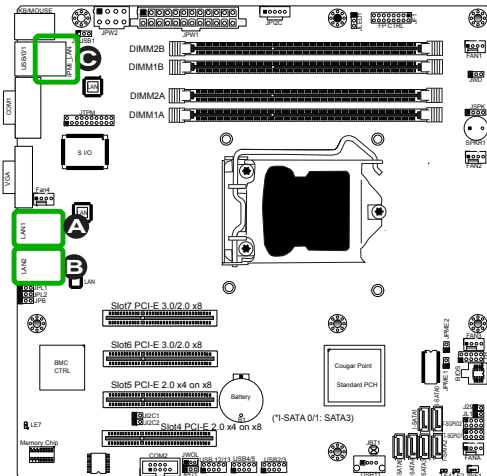
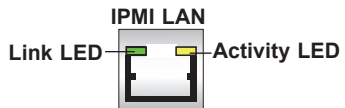

- A. LAN Port 1
- B. LAN Port 2
- C. IPMI LAN (X9SCM-F/X9SCL-F Only)

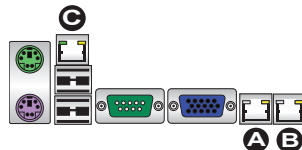

IPMI Heartbeat LED

An IPMI Heartbeat LED is located at LE7. When LE7 blinks, the IPMI functions properly. Refer to the table on the right for details. Also see the layout below for the LED location.

IPMI Heartbeat LED Indicator (LE7) LED Settings	
Green: Blinking	IPMI is Active

Power Standby LED

The Power Standby LED is located at LE4. When the power supply is plugged into an AC outlet, and the power supply hard switch is switched on, LE4 will turn on indicating Power Standby mode. Please make sure LE4 is off before performing service on the motherboard.

Power Standby LED Indicator (LE4) LED Settings	
Green: Solid On	Standby Power is On
Green: Off	Standby Power is Off (either the power supply hard switch is off or system is unplugged, or BOTH.)

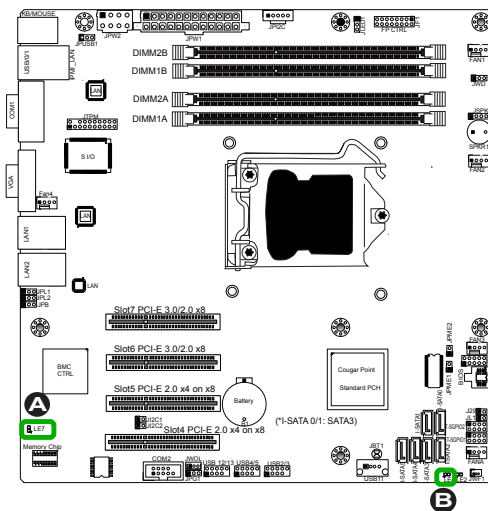

A. IPMI Heartbeat LED

B. Power Standby

2-9 SATA Connections

Note the following conditions when connecting the Serial ATA disk drive cables:

- Be sure to use the correct cable for each connector. Refer to Page 1-1 for cables that came with your shipment.
- A red mark on a wire indicates the location of pin 1.

SATA Connections

Six Serial ATA (SATA) connectors (I-SATA 0~5) are located on the motherboard. For the X9SCM series, I-SATA Ports 0/1 support SATA-III, and I-SATA Ports 2~5 support SATA-II. For the X9SCL models, all SATA ports support SATAII. These Serial Link connections provide faster data transmission than legacy Parallel ATA. See the table on the right for pin definitions.

SATA Connector Types			
X9SCM/X9SCM-F		X9SCL/X9SCL-F/X9SCL+-F	
Port#	Connection Type	Port#	Connection Type
I-SATA 0/1	SATA-III	I-SATA 0~5	SATA-II
I-SATA 2~5	SATA-II		

SATA Connectors Pin Definitions	
Pin#	Signal
1	Ground
2	SATA_TXP
3	SATA_TXN
4	Ground
5	SATA_RXN
6	SATA_RXP
7	Ground

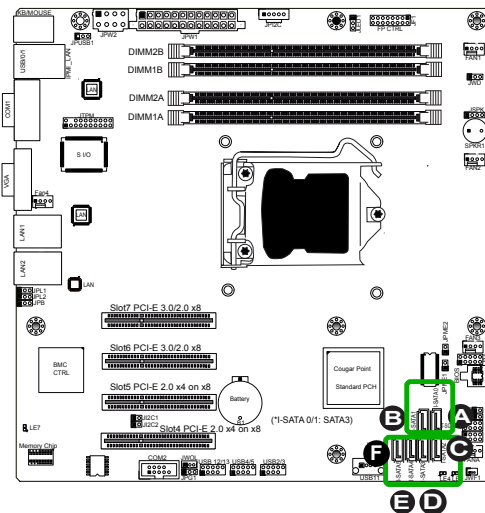

- A. I-SATA 0
- B. I-SATA 1
- C. I-SATA 2
- D. I-SATA 3
- E. I-SATA 4
- F. I-SATA 5

Chapter 3

Troubleshooting

3-1 Troubleshooting Procedures

Use the following procedures to troubleshoot your system. If you have followed all of the procedures below and still need assistance, refer to the 'Technical Support Procedures' and/or 'Returning Merchandise for Service' section(s) in this chapter. Always disconnect the AC power cord before adding, changing or installing any hardware components.

Before Power On

1. Make sure that the Standby PWR LED (LE2) is not on. (**Note:** If LE2 is on, the onboard power is on. Be sure to unplug the power cable before installing or removing the components.)
2. Make sure that there are no short circuits between the motherboard and chassis.
3. Disconnect all ribbon/wire cables from the motherboard, including those for the keyboard and mouse. Also, be sure to remove all add-on cards.
4. Install a CPU and heatsink (-be sure that it is fully seated) and then connect the chassis speaker and the power LED to the motherboard. Check all jumper settings as well.

No Power

1. Make sure that there are no short circuits between the motherboard and chassis.
2. Make sure that all jumpers are set to their default positions.
3. Check if the 115V/230V switch on the power supply is properly set.
4. Turn the power switch on and off to test the system.
5. The battery on your motherboard may be old. Check to make sure that it still supplies ~3VDC. If it does not, replace it with a new one.

No Video

1. If the power is on, but you have no video--in this case, you will need to remove all the add-on cards and cables first.
2. Use the speaker to determine if any beep codes exist. (Refer to Appendix A for details on beep codes.)
3. Remove all memory modules and turn on the system. (If the alarm is on, check the specs of memory modules, reset the memory or try a different one.)

Memory Errors

1. Make sure that the DIMM modules are properly installed and fully seated in the slots.
2. You should be using unbuffered ECC DDR3 (1.5V) 1333/1066 MHz memory (recommended by the manufacturer). Also, it is recommended that you use the memory modules of the same type and speed for all DIMMs in the system. Do not use memory modules of different sizes, different speeds and different types on the same motherboard.
3. Check for bad DIMM modules or slots by swapping modules between slots to see if you can locate the faulty ones.
4. Check the switch of 115V/230V power supply.

Losing the System's Setup Configuration

1. Please be sure to use a high quality power supply. A poor quality power supply may cause the system to lose CMOS setup information. Refer to Section 1-6 for details on recommended power supplies.
2. The battery on your motherboard may be old. Check to verify that it still supplies ~3VDC. If it does not, replace it with a new one.
3. If the above steps do not fix the Setup Configuration problem, contact your vendor for repairs.

3-2 Technical Support Procedures

Before contacting Technical Support, please make sure that you have followed all the steps listed below. Also, Note that as a motherboard manufacturer, Supermicro does not sell directly to end users, so it is best to first check with your distributor or reseller for troubleshooting services. They should know of any possible problem(s) with the specific system configuration that was sold to you.

1. Please go through the 'Troubleshooting Procedures' and 'Frequently Asked Question' (FAQ) sections in this chapter or see the FAQs on our website (<http://www.supermicro.com/support/faqs/>) before contacting Technical Support.
2. BIOS upgrades can be downloaded from our website at (<http://www.supermicro.com/support/bios/>).

Note: Not all BIOS can be flashed. Some cannot be flashed; it depends on the boot block code of the BIOS.

3. If you've followed the instructions above to troubleshoot your system, and still cannot resolve the problem, then contact Supermicro's technical support and provide them with the following information:
 - Motherboard model and PCB revision number
 - BIOS release date/version (this can be seen on the initial display when your system first boots up)
 - System configuration
 - An example of a Technical Support form is on our website at (<http://www.supermicro.com/support/contact.cfm>).
4. Distributors: For immediate assistance, please have your account number ready when placing a call to our technical support department. We can be reached by e-mail at support@supermicro.com, by phone at: (408) 503-8000, option 2, or by fax at (408)503-8019.

3-3 Frequently Asked Questions

Question: What type of memory does my motherboard support?

Answer: The X9SCM/X9SCM-F/X9SCL/X9SCL-F/X9SCL+-F supports up to 32GB of unbuffered ECC DDR3 SDRAM (1.5V, 1333/1066 MHz). See Section 2-3 for details on installing memory.

Question: How do I update my BIOS?

Answer: It is recommended that you **do not** upgrade your BIOS if you are not experiencing any problems with your system. Updated BIOS files are located on our website at <http://www.supermicro.com/support/bios/>. Please check our BIOS warning message and the information on how to update your BIOS on our web site. Select your motherboard model and download the BIOS ROM file to your computer. Also, check the current BIOS revision to make sure that it is newer than your BIOS before downloading. After downloading the BIOS file (.zip archive), please unzip the file into a bootable USB pen/thumb drive. To flash the BIOS, run the batch file named "ami.bat" with the new BIOS ROM file from your bootable device or USB pen/thumb drive. Use the following format:

```
F:\> ami.bat BIOS-ROM-filename.xxx <Enter>
```



Note: Always use the file named "ami.bat" to update the BIOS, and insert a space between "ami.bat" and the filename. The BIOS-ROM-filename will bear the motherboard name (i.e., X9SCM) and build version as the extension. For example, "X9SCM0.115". When completed, your system will automatically reboot.

When the BIOS flashing screen is completed, the system will reboot and will show "Press F1 or F2". At this point, you will need to load the BIOS defaults. Press <F1> to go to the BIOS setup screen, and press <F9> to load the default settings. Next, press <F10> to save and exit. The system will then reboot.

Warning: Do not shut down or reset the system while updating the BIOS to prevent possible system boot failure!



Note: The SPI BIOS chip installed on this motherboard is not removable. To repair or replace a damaged BIOS chip, please send your motherboard to RMA at Supermicro for service.

Question: I think my BIOS is corrupted. How can I recover my BIOS?

Answer: Please see Appendix C-BIOS Recovery for detailed instructions.

Question: What's on the CD that came with my motherboard?

Answer: The supplied compact disc has quite a few drivers and programs that will greatly enhance your system. We recommend that you review the CD and install the software you need. Software on the CD include chipset drivers for Windows, security programs, and audio drivers.

Question: Why do I get an error message "IASTOR.SYS read error" and "press F6 to install Intel RAID driver" when installing Windows on my motherboard?

Answer: To solve this issue, disable the IPMI jumper. Another solution is to use a USB floppy drive instead of the onboard floppy drive. For the IPMI jumper location, please check Chapter 1.

Question: What is the heatsink part number for my X9SCM/X9SCM-F/X9SCL/X9SCL-F/X9SCL+-F motherboard?

Answer: For the 1U passive heatsink, ask for SNK-P0046P (back plate is included). For the 2U active heatsink, use SNK-P0046A4.

Question: Why can't I recover the BIOS even when I've followed the instructions in the user's manual for the motherboard?

Answer: Please disable the IPMI jumper and try it again. For the jumper location, please check Chapter 1.

3-4 Battery Removal and Installation

Battery Removal

To remove the onboard battery, follow the steps below:

1. Power off your system and unplug your power cable.
2. Locate the onboard battery as shown below.
3. Using a tool such as a pen or a small screwdriver, push the battery lock outwards to unlock it. Once unlocked, the battery will pop out from the holder.
4. Remove the battery.

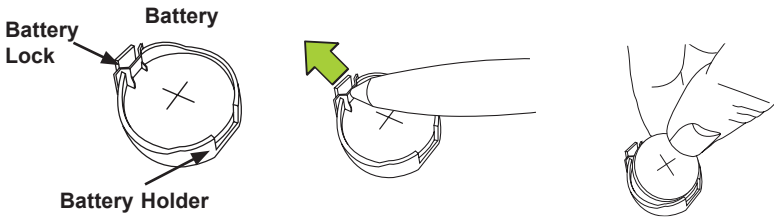

Proper Battery Disposal

Warning! Please handle used batteries carefully. Do not damage the battery in any way; a damaged battery may release hazardous materials into the environment. Do not discard a used battery in the garbage or a public landfill. Please comply with the regulations set up by your local hazardous waste management agency to dispose of your used battery properly.

Battery Installation

1. To install an onboard battery, follow the steps 1 & 2 above and continue below:
2. Identify the battery's polarity. The positive (+) side should be facing up.
3. Insert the battery into the battery holder and push it down until you hear a click to ensure that the battery is securely locked.

Warning: When replacing a battery, be sure to only replace it with the same type.

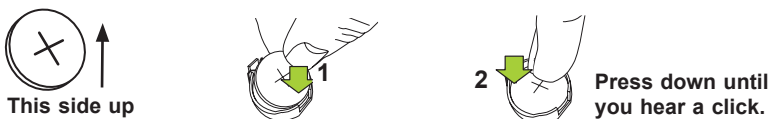

3-5 Returning Merchandise for Service

A receipt or copy of your invoice marked with the date of purchase is required before any warranty service will be rendered. You can obtain service by calling your vendor for a Returned Merchandise Authorization (RMA) number. For faster service, you may also obtain RMA authorizations online (<http://www.supermicro.com/RmaForm/>). When you return the motherboard to the manufacturer, the RMA number should be prominently displayed on the outside of the shipping carton, and mailed prepaid or hand-carried. Shipping and handling charges will be applied for all orders that must be mailed when service is complete.

This warranty only covers normal consumer use and does not cover damages incurred in shipping or from failure due to the alteration, misuse, abuse or improper maintenance of products.

During the warranty period, contact your distributor first for any product problems.

Notes

Chapter 4

BIOS

4-1 Introduction

This chapter describes the AMI BIOS Setup Utility for the X9SCM/X9SCM-F/X9SCL/X9SCL-F/X9SCL+-F. The AMI ROM BIOS is stored in a Flash EEPROM and can be easily updated. This chapter describes the basic navigation of the AMI BIOS Setup Utility setup screens.



Note: For instructions on BIOS recovery, please refer to the instruction guide posted at <http://www.supermicro.com/support/manuals/>.

Starting BIOS Setup Utility

To enter the AMI BIOS Setup Utility screens, press the <Delete> key while the system is booting up.



Note: In most cases, the <Delete> key is used to invoke the AMI BIOS setup screen. There are a few cases when other keys are used, such as <F1>, <F2>, etc.

Each main BIOS menu option is described in this manual. The Main BIOS setup menu screen has two main frames. The left frame displays all the options that can be configured. Grayed-out options cannot be configured. Options in blue can be configured by the user. The right frame displays the key legend. Above the key legend is an area reserved for a text message. When an option is selected in the left frame, it is highlighted in white. Often a text message will accompany it. (**Note:** the AMI BIOS has default text messages built in. Supermicro retains the option to include, omit, or change any of these text messages.)

The AMI BIOS Setup Utility uses a key-based navigation system called "hot keys". Most of the AMI BIOS setup utility "hot keys" can be used at any time during the setup navigation process. These keys include <F1>, <F10>, <Enter>, <ESC>, arrow keys, etc.



Note: Options printed in **Bold** are default settings.

How To Change the Configuration Data

The configuration data that determines the system parameters may be changed by entering the AMI BIOS Setup utility. This Setup utility can be accessed by pressing at the appropriate time during system boot.

How to Start the Setup Utility

Normally, the only visible Power-On Self-Test (POST) routine is the memory test. As the memory is being tested, press the <Delete> key to enter the main menu of the AMI BIOS Setup Utility. From the main menu, you can access the other setup screens. An AMI BIOS identification string is displayed at the left bottom corner of the screen, below the copyright message.

Warning: Do not upgrade the BIOS unless your system has a BIOS-related issue. Flashing the wrong BIOS can cause irreparable damage to the system. In no event shall Supermicro be liable for direct, indirect, special, incidental, or consequential damages arising from a BIOS update. If you have to update the BIOS, do not shut down or reset the system while the BIOS is updating. This is to avoid possible boot failure.

4-2 Main Setup

When you first enter the AMI BIOS Setup Utility, you will enter the Main setup screen. You can always return to the Main setup screen by selecting the Main tab on the top of the screen. The Main BIOS Setup screen is shown below.

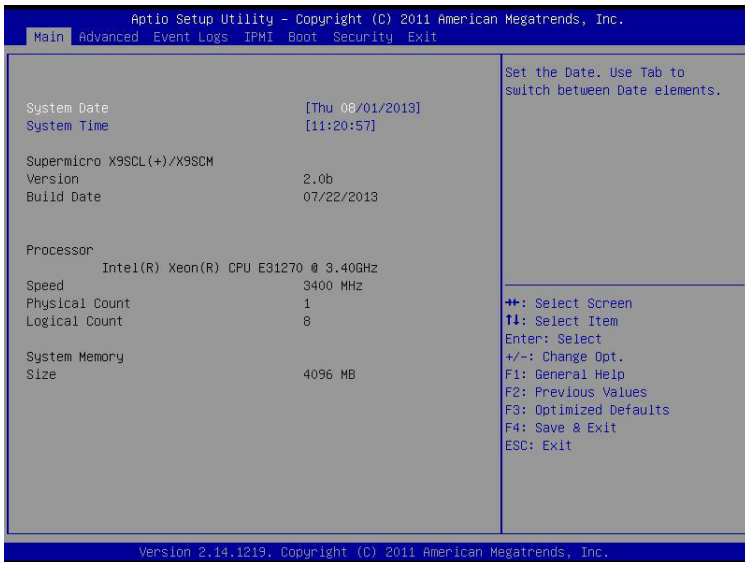

System Overview: The following BIOS information will be displayed:

System Time/System Date

Use this option to change the system time and date. Highlight *System Time* or *System Date* using the arrow keys. Enter new values through the keyboard. Press the <Tab> key or the arrow keys to move between fields. The date must be entered in Day MM/DD/YY format. The time is entered in HH:MM:SS format. (**Note:** The time is in the 24-hour format. For example, 5:30 P.M. appears as 17:30:00.)

Supermicro X9SCL/X9SCM

Version

Build Date

Processor

The AMI BIOS will automatically display the status of processor as shown below:

Processor

Speed

Physical Count

Logical Count

System Memory

This displays the size of memory available in the system:

Size

4-3 Advanced Setup Configurations

Use the arrow keys to select Boot Setup and hit <Enter> to access the submenu items:

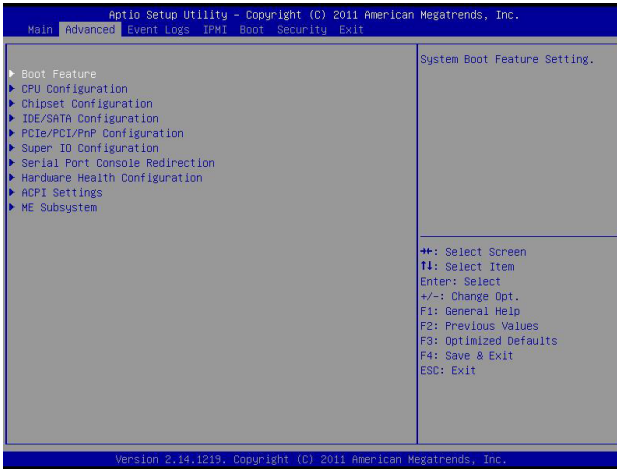

►BOOT Feature

Quiet Boot

This option allows the bootup screen options to be modified between POST messages or the OEM logo. Select Disabled to display the POST messages. Select Enabled to display the OEM logo instead of the normal POST messages. The options are **Enabled** and Disabled.

AddOn ROM Display Mode

This sets the display mode for Option ROM. The options are **Force BIOS** and Keep Current.

Bootup Num-Lock

This feature selects the Power-on state for Numlock key. The options are Off and **On**.

Wait For 'F1' If Error

This forces the system to wait until the 'F1' key is pressed if an error occurs. The options are Disabled and **Enabled**.

Interrupt 19 Capture

Interrupt 19 is the software interrupt that handles the boot disk function. When this item is set to Enabled, the ROM BIOS of the host adaptors will "capture" Interrupt

19 at boot and allow the drives that are attached to these host adaptors to function as bootable disks. If this item is set to Disabled, the ROM BIOS of the host adaptors will not capture Interrupt 19, and the drives attached to these adaptors will not function as bootable devices. The options are **Enabled** and Disabled.

Watch Dog Function

If enabled, the Watch Dog Timer will allow the system to reboot when it is inactive for more than 5 minutes. The options are Enabled and **Disabled**.

Power Button Function

This feature controls how the system shuts down when the power button is pressed. Select 4-Second Override to force the user to press and hold the Power Button for 4 seconds before the system turns off. Select Instant Off if you want the system to instantly power off when the Power Button is pressed. The options are 4 Second Override and **Instant Off**.

Restore on AC Power Loss

Use this feature to set the power state after a power outage. Select Power-Off for the system power to remain off after a power loss. Select Power-On for the system power to be turned on after a power loss. Select Last State to allow the system to resume its last state before a power loss. The options are Power-On, Power-Off and **Last State**.

VFC

This item enables or disables the VESA Feature Connector (VFC) option. The options are **Enabled** and Disabled.

Deep Sx

Select Enabled to enable Deep Sleep State support. The settings are Enabled and **Disabled**.

►Processor & Clock Options

Warning: Take Caution when changing the Advanced settings. An incorrect value, a very high DRAM frequency or incorrect DRAM timing may cause system to become unstable. When this occurs, revert to the default setting.

Hardware Prefetcher (Available when supported by the CPU)

If set to Enabled, the hardware pre fetcher will pre fetch streams of data and instructions from the main memory to the L2 cache in the forward or backward manner to improve CPU performance. The options are Disabled and **Enabled**.

Adjacent Cache Line Prefetch (Available when supported by the CPU)

The CPU fetches the cache line for 64 bytes if this option is set to Disabled. The CPU fetches both cache lines for 128 bytes as comprised if **Enabled**.

Intel® Virtualization Technology (Available when supported by the CPU)

Select Enabled to use the feature of Virtualization Technology to allow one platform to run multiple operating systems and applications in independent partitions, creating multiple "virtual" systems in one physical computer. The options are **Enabled** and Disabled. **Note:** If there is any change to this setting, you will need to power off and restart the system for the change to take effect. Please refer to Intel's web site for detailed information.

Execute-Disable Bit Capability (Available when supported by the OS and the CPU)

Set to Enabled to enable the Execute Disable Bit which will allow the processor to designate areas in the system memory where an application code can execute and where it cannot, thus preventing a worm or a virus from flooding illegal codes to overwhelm the processor or damage the system during an attack. The default is **Enabled**. (Refer to Intel and Microsoft Web Sites for more information.)

Intel® AES-NI

Set to Enabled to use the processor's Advanced Encryption Standard (AES) feature. The options are Enabled and **Disabled**.

Intel® Hyper Threading Technology

Set to Enabled to use the processor's Hyper Threading Technology feature. The options are **Enabled** and Disabled.

Active Processor Cores

Set to Enabled to use a processor's Second Core and beyond. (Please refer to Intel's web site for more information.) The options are **All**, 1, 2 and 3.

Power Technology

This feature determines what power-saving scheme the motherboard uses. The options are Disabled, Energy Efficient and Custom. If Custom is selected, the following options become available:

EIST

EIST (Enhanced Intel SpeedStep Technology) allows the system to automatically adjust processor voltage and core frequency in an effort to reduce power consumption and heat dissipation. **Please refer to Intel's web site for detailed information.** The options are **Disabled** and Enabled.

P-STATE Coordination

This feature selects the type of coordination for the P-State of the processor. P-State is a processor operational state that reduces the processor's voltage and frequency. This makes the processor more energy efficient, resulting in further gains. The options are **HW_ALL**, **SW_ALL** and **SW-ANY**.

CPU C3 Report, CPU C6 Report

This BIOS feature enables or disables C3 (ACPI C2) or C6 (ACPI C3) reporting to the operating system. The options are **Disabled** and **Enabled**.

C-State package limit setting

If set to Auto, the AMI BIOS will automatically set the limit on the C-State package register. The options are **C0**, **C1**, **C6**, **C7** and **No Limit**.

►Intel® Turbo Boost Technology (Available if Intel® EIST technology is Enabled)

Turbo Mode

This feature allows processor cores to run faster than marked frequency in specific conditions. The options are **Disabled** and **Enabled**.

Long duration power limit - this is the processor power consumption limit (in Watts) during a long duration time window.

Long duration maintained - this is the time in milliseconds where the Long Duration Power Limit is maintained.

Short duration power limit - During Turbo Mode, the system may exceed the processor's default power setting and exceed the Short Duration Power limit. By increasing this value, the processor can provide better performance for a short duration.

►Chipset Configuration

WARNING: Setting the wrong values in the following sections may cause the system to malfunction.

►CPU Bridge Configuration

This item displays the current CPU Revision, Current CPU1 Memory Frequency, Memory Type and Memory Reference Code Revision.

Memory Frequency

This feature allows the user to select the memory speed. Under normal conditions, please set this to Auto. The options are **Auto**, **Force DDR-800**, **Force DDR-1067**, **Force DDR-1333**, and **Force DDR-1600**.

► North Bridge Configuration

This item displays the current North Bridge Revision.

VT-d

Select Enabled to enable Intel's Virtualization Technology support for Direct I/O VT-d by reporting the I/O device assignments to VMM through the DMAR ACPI Tables. This feature offers fully-protected I/O resource-sharing across the Intel platforms, providing the user with greater reliability, security and availability in networking and data-sharing. The settings are Enabled and **Disabled**.

Active State Power Management

Select Enabled to start Active-State Power Management for signal transactions between L0 and L1 Links on the PCI Express Bus. This maximizes power-saving and transaction speed. The options are Enabled and **Disabled**.

PCIE Maximum Payload Size

This feature selects the setting for the PCIE maximum payload size. The options are **Auto**, 128 Bytes, 256 Bytes, 512 Bytes, 1024 Bytes, 2048 Bytes, and 4096 Bytes.

PCI Express Port

This feature enables or disables the PCI Express port. The options are Disabled, Enabled and **Auto**.

PEG Force Gen1

This feature forces Gen1 support on the PCI Express Graphics (PEG) port. The options are **Disabled**, and Enabled.

Detect Non-Compliant Device

This feature enables or disables the detection of a non-compliant device that is attached to the PCI Express Graphics (PEG) port. The options are **Disabled**, and Enabled.

► South Bridge Configuration

This item displays the current South Bridge Revision.

GbE Controller

Select Enabled to enable the onboard gigabit Ethernet controller. The settings are **Enabled** and Disabled.

Wake on LAN from S5

Select Enabled to enable the capability to 'wake-up' the system from the S5 power state (Soft Off State) through the Ethernet controller. The settings are **Enabled** and Disabled.

Legacy USB Support

This feature enables support for legacy USB devices. Select Auto to disable legacy support if USB devices are not present. Select Disable to have USB devices available only for EFI applications. The options are **Enabled**, Disabled and Auto.

BIOS EHCI Hand-Off

This item is for Operating Systems that does not support Enhanced Host Controller Interface (EHCI) hand-off. When enabled, EHCI ownership change will be claimed by the EHCI driver. The settings are **Enabled** and Disabled.

►IDE/SATA Configuration

When this submenu is selected, the AMI BIOS automatically detects the presence of the IDE Devices and displays the following items:

SATA Mode

This item selects the mode for the installed drives. The options are Disabled, IDE Mode, **AHCI Mode** and RAID Mode.

IDE Mode

The following items are displayed when IDE Mode is selected:

Serial-ATA Controller 0~1

This feature is used to activate/deactivate the SATA controller, and sets the compatibility mode. The options are Enhanced and **Compatible**. The default of Serial-ATA Controller 1 is **Enhanced**.

SATA Port0~Port5

This item displays the information detected on the installed SATA drives on the particular SATA port.

AHCI Mode

The following items are displayed when AHCI Mode is selected:

Aggressive Link Power Management

This feature Enables or Disables Aggressive Link Power Management support for Cougar Point B0 stepping and later. The options are **Enabled** and **Disabled**.

SATA Port0~Port5

This item displays the information detected on the installed SATA drives on the particular SATA port.

Staggered Spin Up

Set this item to **Enabled** to enable Staggered Spin-up support. The options are **Enabled** and **Disabled**.

External SATA Port

Set this item to **Enabled** to enable eSATA support. The options are **Enabled** and **Disabled**.

Hot Plug

Set this item to **Enabled** to enable hot-plugging. The options are **Enabled** and **Disabled**.

RAID Mode

The following items are displayed when RAID Mode is selected:

SATA Port0~Port5

This item displays the information detected on the installed SATA drives on the particular SATA port.

Hot Plug

Set this item to **Enabled** to enable hot-plugging. The options are **Enabled** and **Disabled**.

►PCIe/PCI/PnP Configuration

This feature allows the user to set the PCI/PnP configurations for the following items:

PCI ROM Priority

In case of multiple Option ROMs (Legacy and EFI-compatible), this feature specifies what ROM to launch. The options are **Legacy ROM** and **EFI Compatible ROM**.

PCI Latency Timer

This feature sets the latency Timer of each PCI device installed on a PCI bus. Select 64 to set the PCI latency to 64 PCI clock cycles. The options are 32, **64**, 96, 128, 160, 192, 224 and 248.

PCI-E Slot 4, 5, 6, & 7 OPROM

Use this feature to enable or disable PCI slot Option ROMs. The options are Disabled and **Enabled**.

Onboard LAN Option ROM Select

This feature selects whether to load the iSCSI or PXE onboard LAN option ROM. The options are iSCSI and **PXE**.

Load Onboard LAN1 Option ROM/Load Onboard LAN2 Option ROM

This feature is to enable or disable the onboard option ROMs. The options are **Disabled** and Enabled.

Boot Graphics Adapter Priority

Use the feature to select the graphics controller to be used as the primary boot device. The options are Offboard VGA and **Onboard VGA**.

►Super IO Device Configuration**Serial Port 1 / Serial Port 2**

Select Enabled to enable the onboard serial port. The options are **Enabled** and Disabled.

Serial Port1 Settings/ Serial Port2 Settings

This option specifies the base I/O port address and the Interrupt Request address of Serial Port 1 and Serial Port 2. Select Disabled to prevent the serial port from accessing any system resources. When this option is set to Disabled, the serial port physically becomes unavailable. Select 3F8/IRQ4 to allow the serial port to use 3F8 as its I/O port address and IRQ 4 for the interrupt address. The options for Serial Port1 are Disabled, **3F8/IRQ4**, 3E8/IRQ4, 2F8/IRQ3 and 2E8/IRQ3. The options for Serial Port2 are Disabled, 3F8/IRQ4, 3E8/IRQ4, **2F8/IRQ3**, and 2E8/IRQ3.

Serial Port 2 Mode

Use this feature to configure Serial Port 2 mode. The options are **Normal**, IrDA and ASK IR. IrDA (Infrared Data) is an industry standard for remote control devices. ASK IR (Amplitude Shifted Keying Infrared) is a protocol compatible with Sharp® branded PDAs and other infrared devices.

►Remote Access Configuration

COM0/COM1/SOL Console Redirection

Use this feature to enable console redirection for COM0 and COM1 ports. The options are **Enabled** and Disabled. The default for all ports are Disabled.

►Console Redirection Settings

Configure the following options for the Console Redirection Settings. The most common settings are set as default:

Terminal Type : Select **ANSI**, VT100, VT100+, or VT-UTF8

Bits per Second (BPS): 9600, 19200, 57600, or **115200**

Data Bits: **8** or 7

Parity: **None**, Even, Odd, Mark, or Space

Stop Bits: **1** or 2

Flow Control: **None** or Hardware RTS/CTS

Recorder Mode: **Disabled** or Enabled

Resolution 100x31: **Disabled** or Enabled

Legacy OS Redirection Resolution: **80x24** or 80x25

Serial Port for Out-of-Band Management / Windows Emergency Management Services (EMS)

Use this feature to enable console redirection. The options are **Enabled** and Disabled. The default is Disabled.

►Console Redirection Settings

Configure the following options for the Console Redirection Settings. The most common settings are set as default:

Out-of-Band Mgmt Port: **COM1**, COM2, SOL, COM4

Terminal Type : Select ANSI, VT100, VT100+, or **VT-UTF8**

Bits per Second (BPS): 9600, 19200, 57600, or **115200**

Data Bits: **8** or 7

Parity: **None**, Even, Odd, Mark, or Space

Stop Bits: **1** or 2

►Hardware Health Configuration

Fan Speed Control Mode

This feature allows the user to decide how the system controls the speeds of the onboard fans. The CPU temperature and the fan speed are correlative. When the CPU on-die temperature increases, the fan speed will also increase for effective system cooling. Select "Full Speed" to allow the onboard fans to run at full speed (of 100% Pulse Width Modulation Duty Cycle) for maximum cooling. This setting is recommended for special system configuration or debugging. Select "Standard" for the onboard fans to run at 50% of the Initial PWM Cycle in order to balance the needs between system cooling and power saving. This setting is recommended for regular systems with normal hardware configurations. Select "Optimal" for the onboard fans to run at 30% of the Initial PWM Cycle for best power efficiency and maximum quietness. The options are Full Speed (@100% of PWM Cycle), **Standard** (@50% of PWM Cycle), and Optimal (@30% of PWM Cycle).

CPU Temperature Display Mode

This feature displays the CPU temperature detected by DTS (i.e., +34°C) or temperature status in text ("Low", "Medium" or "High"). The options are **Text Mode** or DTS.

If Text Mode is selected, the CPU Temperature Display Mode will show the CPU temperature status as follows:

Low – This level is considered as the 'normal' operating state. The CPU temperature is well below the CPU 'Temperature Tolerance'. The motherboard fans and CPU will run normally as configured in the BIOS (Fan Speed Control).

User intervention: No action required.

Medium – The processor is running warmer. This is a 'precautionary' level and generally means that there may be factors contributing to this condition, but the CPU is still within its normal operating state and below the CPU 'Temperature Tolerance'. The motherboard fans and CPU will run normally as configured in the BIOS. The fans may adjust to a faster speed depending on the Fan Speed Control settings.

User intervention: No action is required. However, consider checking the CPU fans and the chassis ventilation for blockage.

High – The processor is running hot. This is a 'caution' level since the CPU's 'Temperature Tolerance' has been reached (or has been exceeded) and may activate an overheat alarm:

The information provided above is for your reference only. For more information on thermal management, please refer to Intel's Web site at www.Intel.com.

Fan1 ~ Fan4, FanA Reading

This feature displays the fan speed readings from fan interfaces Fan1 through Fan4 and FanA.

12V, VDIMM, 5VCC, -12V, AVCC, 3.3VCC, VSB, VBAT

This feature displays the current voltages of the above voltage monitors.

►ACPI Configuration

Use this feature to configure Advanced Configuration and Power Interface (ACPI) power management settings for your system.

High Performance Event Timers

Select Enabled to activate the High Performance Event Timer (HPET) that produces periodic interrupts at a much higher frequency than a Real-time Clock (RTC) does in synchronizing multimedia streams, providing smooth playback and reducing the dependency on other timestamp calculation devices, such as an x86 RDTSC Instruction embedded in the CPU. The High Performance Event Timer is used to replace the 8254 Programmable Interval Timer. The options are **Enabled** and Disabled.

Suspend Mode

This setting allows you to configure the ACPI (Advanced Configuration and Power Interface) sleep state for your system when it is in the Suspend mode. The options are Suspend Disabled and **S1 (POS)**.

NUMA Support

This feature Enables the Non-Uniform Memory Access ACPI support. The options are **Enabled** and Disabled.

WHEA Support

This feature Enables the Windows Hardware Error Architecture (WHEA) support for the Windows 2008 operating system (and later versions). The options are **Enabled** and Disabled.

4-4 Event Logs

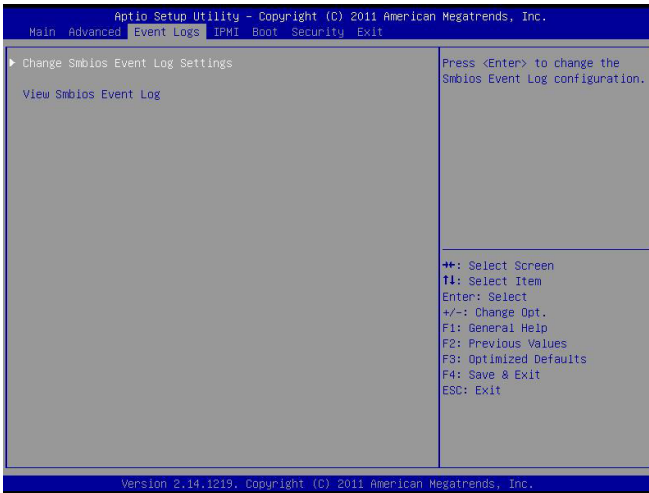

Smbios Event Log

Change this item to enable or disable all features of the Smbios Event Logging during boot. The options are **Enabled** and Disabled.

Erase Event Log

This option erases all logged events. The options are **No**, Yes, Next reset and Yes, Every reset.

When Log is Full

This option automatically clears the Event Log memory of all messages when it is full. The options are **Do Nothing** and Erase Immediately.

MECI

The Multiple Event Count Increment (MECI) counter counts the number of occurrences a duplicate event must happen before the MECI counter is incremented. This is a numeric value.

METW

The Multiple Event Time Window (METW) defines number of minutes must pass between duplicate log events before MECI is incremented. This is in minutes, from 0 to 99.

4-5 IPMI Configuration (X9SCM-F/X9SCL-F/X9SCL+-F)

Intelligent Platform Management Interface (IPMI) is a set of common interfaces that IT administrators can use to monitor system health and to manage the system as a whole. For more information on the IPMI specifications, please visit Intel's website at www.intel.com.



BMC Support

This feature enables or disables the installed Baseboard Management Controller (BMC) on the motherboard. The options are **Enabled** and Disabled.

Wait For BMC

If enabled, the system will wait for a BMC response after the AC power is turned on. It takes around 30 seconds to initialize Host to BMC interfaces. The options are **Disabled** and Enabled.

►BMC Self Test Log

This feature logs any BMC messages returned during a BMC self-test. It shows the total number of entries and will allow the viewing of each event by scrolling down.

Erase Log - Select **Yes, On every reset** or No.

When Log is Full - Select **Clear Log** or Do Not Log Anymore.

►System Event Log

This feature is used to change the Sytem Event Log (SEL) configuration.

SEL Components - Change this item to enable or disable all features of System Event Logging. The options are Enabled and Disabled. When Enabled, the following can be configured:

Erase SEL - This option erases all logged SEL events. The options are No, Yes, On Next reset and Yes, On Every reset.

When SEL Full

This option automatically clears the System Event Log memory of all messages when it is full. The options are **Do Nothing** and Erase Immediately.

Log EFI Status Codes

This option enables or disables the logging of Extensible Firmware Interface (EFI) status codes. The options are Disabled, **Both**, Error Code and Progress Code.

►View FRU Information

This is an informational item which displays the information pertaining to this motherboard (FRU - Field Replaceable Unit).

►BMC Network Configuration

Set this feature to configure the IPMI LAN adapter with a network address.

Configuration Source

This feature selects whether the IP address, Subnet Mask and Gateway Address are automatically assigned by the network's DHCP server (Dynamic Host and Configuration Protocol) "Dynamic" or manually entered by the user "Static". If Static is selected, the IP Address, Subnet Mask and Gateway Address must be manually entered below. The options are Static, Dynamic and **Do Nothing**. The following items are displayed when Static is selected:

Station IP Address - Enter the IP address for this machine. This should be in decimal and in dotted quad form (i.e., 192.168.10.253). The value of each three-digit number separated by dots should not exceed 255.

Subnet Mask - Subnet masks tell the network which subnet this machine belongs to. The value of each three-digit number separated by dots should not exceed 255.

Station MAC Address - MAC addresses are 6 two-digit hexadecimal numbers (Base 16, 0 ~ 9, A, B, C, D, E, F) separated by dots (i.e., 00.30.48.D0.D4.60).

Router IP Address - Enter the Gateway or Router address this machine will use (i.e., 192.168.10.1).

Router MAC Address - Enter the MAC address of the Router or Gateway (only if needed).

4-6 Boot Settings

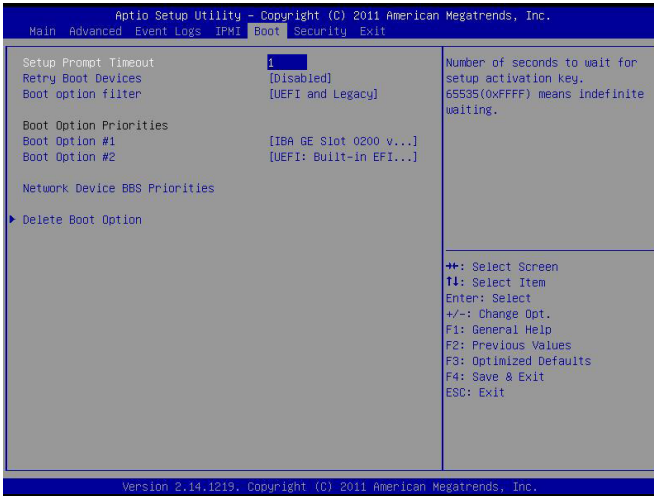

Use this feature to configure Boot Settings:

▶ Boot Options Priority

This feature allows the user to specify which devices are boot devices and the order of priority from which the systems boots from during startup.

Boot Option #1, Boot option #2, Boot Option #3, etc

The settings are **Built-in EFI Shell**, [any detected boot device] and Disabled.

▶ Delete Boot Option

This feature allows the user to delete any previously-defined boot device from the Boot Options Priority.

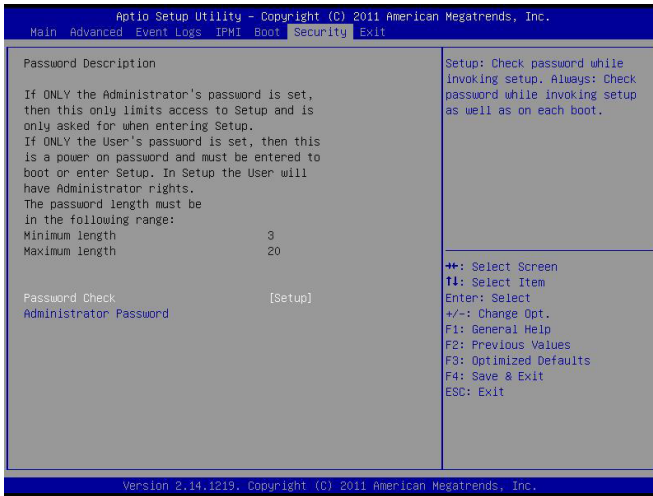

4-7 Security Settings

- If the Administrator password is defined ONLY - this controls access to the BIOS setup ONLY.
- If the User's password is defined ONLY - this password will need to be entered during each system startup or boot, and will also have Administrator rights in the setup.
- Passwords must be at least 3 and up to 20 characters long.

Administrator Password

Press Enter to create a new, or change an existing Administrator password.

User Password:

Press Enter to create a new, or change an existing User password.

Boot Sector Virus Protection

When Enabled, the BIOS displays a warning when any program (or virus) issues a Disk Format command or attempts to write to the boot sector of the hard disk drive. The options are Enabled and **Disabled**.

4-8 Exit Options

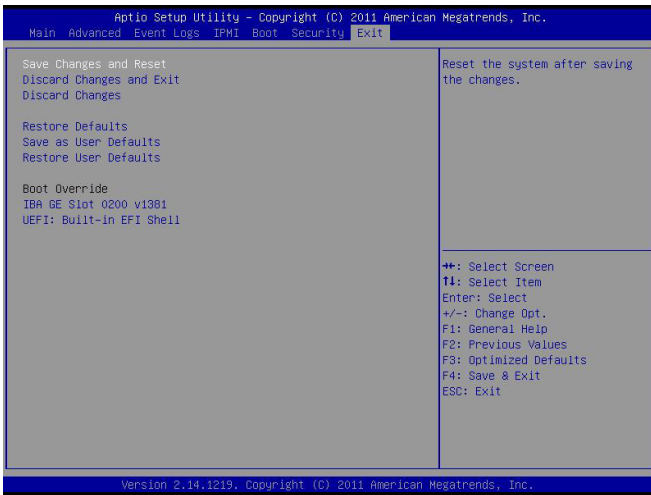

Select the Exit tab from the BIOS Setup Utility screen to enter the Exit BIOS Setup screen.

Save Changes and Exit

When you have completed the system configuration changes, select this option to leave the BIOS Setup Utility and reboot the computer, so the new system configuration parameters can take effect. Select Save Changes and Exit from the Exit menu and press <Enter>.

Discard Changes and Exit

Select this option to quit the BIOS Setup without making any permanent changes to the system configuration, and reboot the computer. Select Discard Changes and Exit from the Exit menu and press <Enter>.

Discard Changes

Select this option and press <Enter> to discard all the changes and return to the AMI BIOS Utility Program.

Restore Defaults

To set this feature, select Restore Defaults from the Exit menu and press <Enter>. These are factory settings designed for maximum system stability, but not for maximum performance.

Save As User Defaults

To set this feature, select Save as User Defaults from the Exit menu and press <Enter>. This enables the user to save any changes to the BIOS setup for future use

Restore User Defaults

To set this feature, select Restore User Defaults from the Exit menu and press <Enter>. Use this feature to retrieve user-defined settings that were saved previously.

Boot Override

Set this feature to override a previously defined boot device. The available devices will be listed below.

Notes

Appendix A

BIOS Error Beep Codes

During the POST (Power-On Self-Test) routines, which are performed each time the system is powered on, errors may occur.

Non-fatal errors are those which, in most cases, allow the system to continue with bootup. The error messages normally appear on the screen.

Fatal errors will not allow the system to continue to bootup. If a fatal error occurs, you should consult with your system manufacturer for possible repairs.

These fatal errors are usually communicated through a series of audible beeps. The numbers on the fatal error list correspond to the number of beeps for the corresponding error.

A-1 BIOS Error Beep Codes

BIOS Error Beep Codes		
Beep Code/LED	Error Message	Description
1 beep	Refresh	Circuits have been reset. (Ready to power up)
5 short beeps + 1 long beep	Memory error	No memory detected in the system
8 beeps	Display memory read/write error	Video adapter missing or with faulty memory
OH LED On	System OH	System Overheat

Notes

Appendix B

Software Installation Instructions

B-1 Installing Drivers

After you've installed the Windows Operating System, a screen as shown below will appear. You are ready to install software programs and drivers that have not yet been installed. To install these software programs and drivers, click the icons to the right of these items. (**Note:** To install the Windows Operating System, please refer to the instructions posted on our website at [http://www.supermicro.com/support/manuals/.](http://www.supermicro.com/support/manuals/))

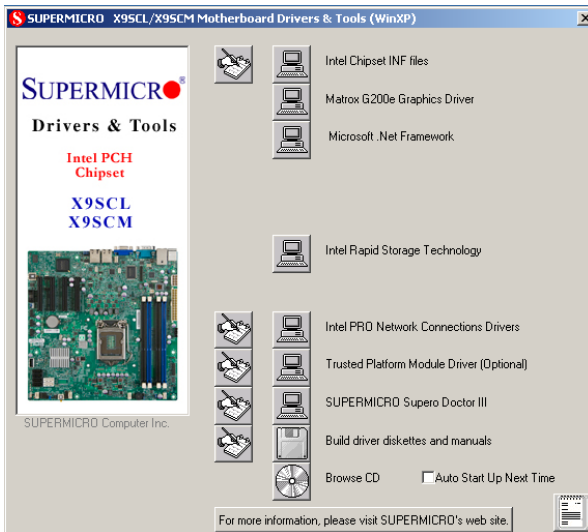

Driver/Tool Installation Display Screen



Note 1: Click the icons showing a hand writing on the paper to view the readme files for each item. Click on a computer icon to the right of an item to install this item (from top to the bottom), one at a time. After installing each item, you must reboot the system before proceeding with the next item on the list. The bottom icon with a CD on it allows you to view the entire contents of the CD.

Note 2: When making a storage driver diskette by booting into a Driver CD, please set the SATA Configuration to "Compatible Mode" and configure SATA as IDE in the BIOS Setup. After making the driver diskette, be sure to change the SATA settings back to your original settings.

B-2 Configuring SuperDoctor[®] III

The SuperDoctor[®] III program is a Web-based management tool that supports remote management capability. It includes Remote and Local Management tools. The local management tool is called the SD III Client. The SuperDoctor III program included on the CDROM that came with your motherboard allows you to monitor the environment and operations of your system. SuperDoctor III displays crucial system information such as CPU temperature, system voltages and fan status. See the Figure below for a display of the SuperDoctor III interface.



Note 1: The default user name and password are ADMIN.

Note 2: In the Windows OS environment, the SuperDoctor[®] III settings take precedence over the BIOS settings. When first installed, SuperDoctor III adopts the temperature threshold settings previously set in BIOS. Any subsequent changes to these thresholds must be made within SuperDoctor, since the settings override the BIOS settings. For the Windows OS to adopt the BIOS temperature threshold settings, please change the SD III Client settings to be the same as those set in BIOS.

SuperDoctor[®] III Interface Display Screen-I (Health Information)

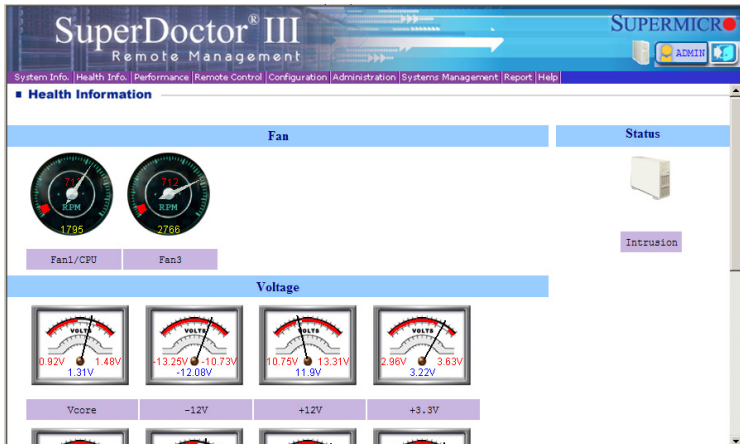

SuperDoctor® III Interface Display Screen-II (Remote Control)

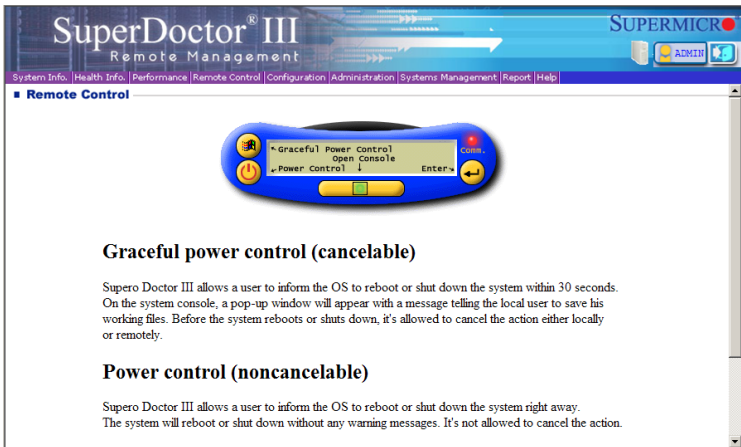

 **Note:** The SuperDoctor® III software and manual may be downloaded from our Website at:

<http://www.supermicro.com/products/accessories/software/SuperDoctorIII.cfm>.

For Linux, we still recommend that you use SuperDoctor II, this version is also available for download at the link above.

Notes

Appendix C

UEFI BIOS Recovery Instructions

Warning: Do not upgrade the BIOS unless your system has a BIOS-related issue. Flashing the wrong BIOS can cause irreparable damage to the system. In no event shall Supermicro be liable for direct, indirect, special, incidental, or consequential damages arising from a BIOS update. If you need to update the BIOS, do not shut down or reset the system while the BIOS is updating to avoid possible boot failure.

An Overview to the UEFI BIOS

The Unified Extensible Firmware Interface (UEFI) specification provides a software-based interface between the operating system and the platform firmware in the pre-boot environment. The UEFI specification supports an architecture-independent mechanism for add-on card initialization to allow the UEFI OS loader, which is stored in the add-on card, to boot up the system. UEFI offers a clean, hand-off control to a computer system at bootup.

How to Recover the UEFI BIOS Image (-the Main BIOS Block)

An AMIBIOS flash chip consists of a boot sector block and a main BIOS code block (a main BIOS image). The boot sector block contains critical BIOS codes, including memory detection and recovery codes for the user to flash a new BIOS image if the original BIOS image is corrupted. When the system power is on, the boot sector codes execute first. Once it is completed, the main BIOS code will continue with system initialization and bootup.



Note: Follow the BIOS Recovery instructions below for BIOS recovery when the main BIOS block crashes. However, when the BIOS Boot sector crashes, you will need to send the motherboard back to Supermicro for RMA repair.

To Recover the Main BIOS Block Using a USB-Attached Device

This feature allows the user to recover a BIOS image using a USB-attached device without additional utilities used. A USB flash device such as a USB Flash Drive, or

a USB CD/DVD ROM/RW device can be used for this purpose. However, a USB Hard Disk drive cannot be used for BIOS recovery at this time.

To perform UEFI BIOS recovery using a USB-attached device, follow the instructions below.

1. Using a different machine, copy the "Super.ROM" binary image file into the disc Root "\\" Directory of a USB device or a writeable CD/DVD.



Note: If you cannot locate the "Super.ROM" file in your driver disk, visit our website at www.supermicro.com to download the BIOS image into a USB flash device and rename it to "Super.ROM" for BIOS recovery use.

2. Insert the USB device that contains the new BIOS image ("Super.Rom") into your USB drive and power on the system
3. While powering on the system, keep pressing <Ctrl> and <Home> simultaneously on your PS2 or USB keyboard until your hear two short beeps. This may take from a few seconds to one minute.
4. After locating the new BIOS binary image, the system will enter the BIOS Recovery page as shown below.

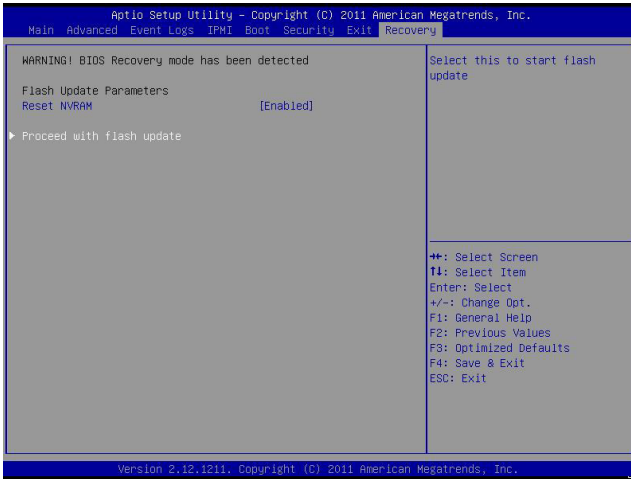

Note: At this point, you may decide if you want to start with BIOS Recovery. If you decide to proceed with BIOS Recovery, follow the procedures below.

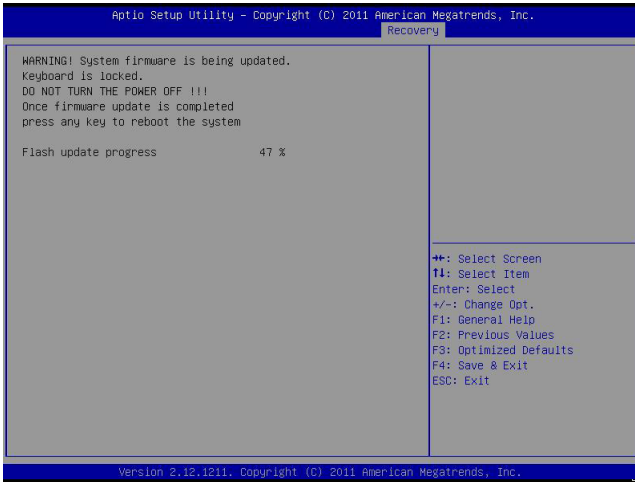

- When the screen as shown above displays, using the arrow key, select the item- "Proceed with flash update" and press the <Enter> key. You will see the progress of BIOS Recovery as shown in the screen below.

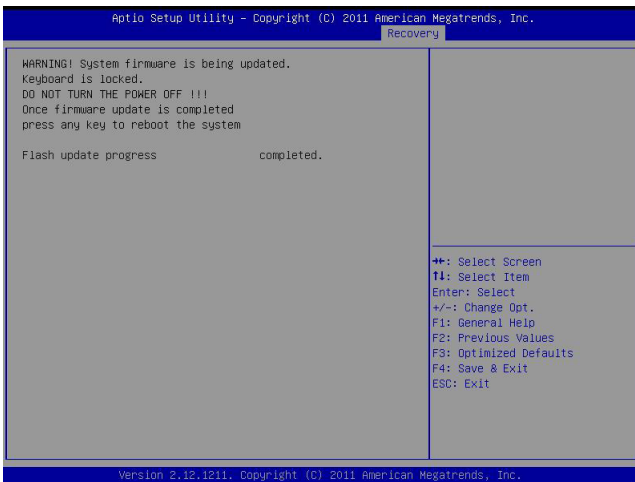

Note: *Do not interrupt* the process of BIOS flashing until it is completed. After the process of BIOS Recovery is complete, press any key to reboot the system.

- Using a different system, extract the BIOS package into a bootable USB flash drive.

7. When a DOS prompt appears, type AMI.BAT BIOSname.### at the prompt.



Note: Do not interrupt this process until BIOS flashing is completed.

8. After seeing the message that BIOS update is completed, unplug the AC power cable to clear CMOS, and then plug in the AC power cable to power on the system.

9. Press continuously to enter the BIOS Setup utility.

10. Press <F3> to load default settings.

11. After loading default settings, press <F4> to save the settings and exit the BIOS Setup utility.

(Disclaimer Continued)

The products sold by Supermicro are not intended for and will not be used in life support systems, medical equipment, nuclear facilities or systems, aircraft, aircraft devices, aircraft/emergency communication devices or other critical systems whose failure to perform be reasonably expected to result in significant injury or loss of life or catastrophic property damage. Accordingly, Supermicro disclaims any and all liability, and should buyer use or sell such products for use in such ultra-hazardous applications, it does so entirely at its own risk. Furthermore, buyer agrees to fully indemnify, defend and hold Supermicro harmless for and against any and all claims, demands, actions, litigation, and proceedings of any kind arising out of or related to such ultra-hazardous use or sale.