

# Digital HD Video Camera Recorder

## Operating Guide

Check for the latest firmware on the website below before using the camera.  
www.sony.net/SonyInfo/Support/



HDR-AS100V

## English

### Owner's Record

The model and serial numbers are located on the bottom. Record the serial number in the space provided below. Refer to these numbers whenever you call your Sony dealer regarding this product.

Model No. HDR-AS \_\_\_\_\_  
Serial No. \_\_\_\_\_

## Read this first

This manual covers basic operations. For more detailed operations, refer to the Handbook (PDF) built into this camera, by doing the following.

- 1 Insert a charged battery pack into the camera.
- 2 Connect the camera to a computer with the micro USB cable (supplied).
- 3 Press the NEXT or PREV button to power on.
- 4 Display [Computer] → [PMHOME] → [HANDBOOK] on your computer, open the Handbook (PDF) file and read it.

## Checking the bundled items

- Camera (1)  
Camera is set in the Waterproof Case. Open the cover of the case as illustrated below.
- Micro USB cable (1)  
Rechargeable battery pack (NP-BX1) (1)  
Waterproof Case (1)  
Attachment Buckle (1)  
Flat Adhesive Mount (1)  
Curved Adhesive Mount (1)  
Tripod Adaptor (1)  
Handbook  
Included in the internal memory of this camera.  
Set of printed documentation

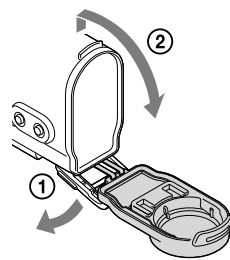

## Parts and controls

- 1 GPS sensor
- 2 REC/access/CHG (Charge) lamp
- 3 REC HOLD switch
- 4 REC (Movie/Photo) button/ENTER (Menu execute) button
- 5 Lock lever
- 6 IR remote receiver
- 7 N (N mark)  
NFC: Near Field Communication
- 8 Display panel
- 9 Speaker
- 10 PREV button
- 11 NEXT button
- 12 Microphones
- 13 Lens
- 14 REC lamp
- 15 Connector cover
- 16 Tripod adaptor attachment hole
- 17 (Mic) jack
- 18 Expansion connector
- 19 HDMI OUT jack
- 20 Connector cover (USB)
- 21 Multi/Micro USB Terminal  
Supports Micro USB compatible devices.
- 22 Battery pack/memory card cover
- 23 Memory card insertion slot
- 24 Battery ejection lever
- 25 Battery insertion slot

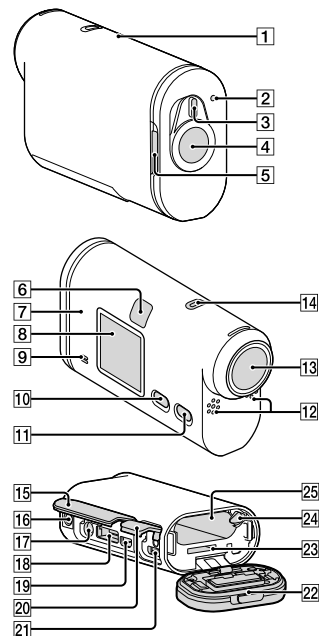

## Getting Started

### Charging the battery pack

- 1 Open the cover.
  - 1 Slide the lock lever until the yellow mark can be seen.
  - 2 Open the cover.

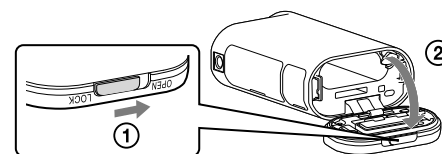

- 2 Insert the battery pack.
  - Slide the battery ejection lever.
  - Insert the battery pack, orienting its mark, as illustrated.

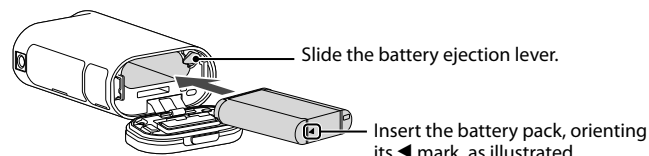

To close the cover, perform the operations in step 1 in opposite order. Close the cover properly, so as the yellow mark on the lock lever is not visible.

- 3 Confirm that the camera is turned off.  
To turn off the camera, press the NEXT button several times to display [PwOFF], then press the ENTER button.
- 4 Connect the Multi/Micro USB Terminal of the camera to a computer with the micro USB cable (supplied).

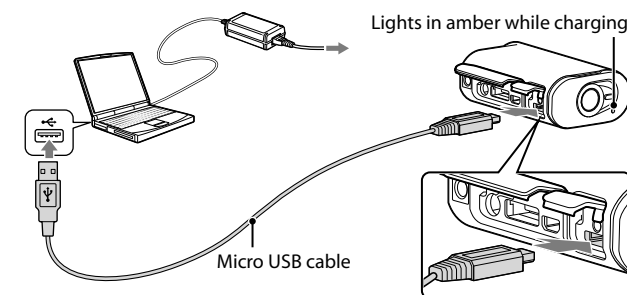

### Inserting a memory card

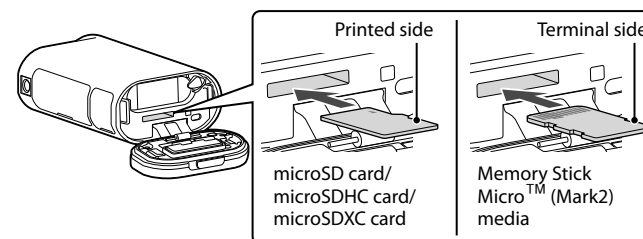

Insert the memory card properly, confirming each side is facing the correct direction.

- Notes
- Operation with all memory cards is not assured.
  - Confirm the direction of the memory card. If you forcibly insert the memory card in the wrong direction, the memory card, memory card slot, or image data may be damaged.
  - Format the memory card before use.
  - To eject the memory card, lightly push the memory card once.

### Setting the clock

Select [SETUP] → [CONFIG] → [DATE] to set the date, time and region.

## Setting

### Button operations

- NEXT: Goes to the next menu  
PREV: Goes to the previous menu  
ENTER: Executes the menu

### Menu items

#### List of modes

Display	Modes
MOVIE	Movie Mode
PHOTO	Photo Mode
INTVL	Interval Photo Recording Mode
VMODE	Image Quality Setting Mode
SETUP	Setup Mode
PLAY	Play Mode
PwOFF	Power off

For related items, see "Items you can set in SETUP."

#### Items you can set in SETUP

Display	Items
STEDY	SteadyShot
FLIP	Flip
SCENE	Scene
LAPSE	Interval Photo Recording
COLOR	Color Mode
PRO	XAVC S™
TC/UB	Time Code/User Bit
IR-RC	IR-Remote Controller
CONFIG	Configuration Settings

#### Items you can set in CONFIG

Display	Items
Wi-Fi	Wi-Fi Remote Control
GPS	GPS Log
PLANE	Airplane Mode
USBPw	USB Power Supply
A.OFF	Auto Power Off
BEEP	Beep
DATE	Date & Time Setting
DST	Daylight Saving Time (Summer Time) Setting
LANG	Language Setting
V.SYS	Switching NTSC/PAL
RESET	Resetting the Settings
FORMAT	Format

#### Notes

- Pressing the NEXT or PREV button repeatedly cycles through the respective mode/setup items.
- To return to the [SETUP] or [CONFIG] menu from each setup item, select [BACK], then press the ENTER button.
- The following operations are available when the power of the camera is turned off.
  - Press the PREV or NEXT button to turn on the camera.
  - Press the ENTER button to start recording in the shooting mode you set before turning off the power of the camera.
- The menu may change depending on the camera operating conditions.
- [TC/UB] is displayed only when [PRO] is set to [ON].

## Recording

Attach accessories to the camera, as required.

- 1 Press the NEXT or PREV button to power on.
- 2 Select a shooting mode from [MOVIE], [PHOTO] and [INTVL].
- 3 Press the REC button to start recording.

To stop movie recording/interval photo recording

Press the REC button again.

#### Notes

- Playback of images recorded with other cameras, is not assured on this camera.
- During periods of extended shooting, camera temperature may rise to a point where shooting stops automatically.

## Using the Wi-Fi function

### Installing PlayMemories Mobile™ on your smartphone



The information on the sticker (in the perforated box, below) is required when connecting the camera to a smartphone. If there is no sticker, refer to the supplied English version of the instruction manual.



## Android OS

Search for PlayMemories Mobile on Google Play, then install it.



- When using One-touch functions (NFC), Android 4.0 or later is required.

## iOS

Search for PlayMemories Mobile on App Store, then install it.



- When using iOS, One-touch functions (NFC) are not available.

### Notes

- Update PlayMemories Mobile to the latest version if you have already installed it on your smartphone.
- The Wi-Fi function described in this Operating Guide is not guaranteed to work with all smartphones and tablets.
- The operation methods and display screens for the application are subject to change without notice by future upgrades.
- For more information about PlayMemories Mobile, refer to the following website. (<http://www.sony.net/pmm/>)

## Connecting

### Android

- 1 Insert a memory card in the camera, turn on the camera, then select the shooting mode: [MOVIE], [PHOTO], [INTVL].
- 2 Start PlayMemories Mobile on the smartphone.
- 3 Select the SSID, as printed on the sticker attached to this manual.
- 4 Input the password on the same sticker (First time only).
- 5 On your smartphone, select the mode of the camera: Wi-Fi Remote Control mode or Copy mode.

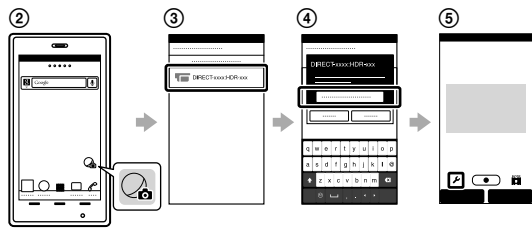

### Android (Supporting NFC)

Touch the (N mark) of the smartphone against the (N mark) of the camera. When PlayMemories Mobile starts, settings are automatically applied to establish Wi-Fi connection.

### iPhone

- 1 Insert a memory card in the camera, turn on the camera, then select the shooting mode: [MOVIE], [PHOTO], [INTVL].
- 2 Open [Settings] on the smartphone.
- 3 Select [Wi-Fi] on the smartphone.
- 4 Select the SSID, as printed on the sticker attached to this manual.
- 5 Input the password on the same sticker (First time only).
- 6 Confirm that the SSID of the camera is displayed on the smartphone.
- 7 Return to the Home screen, then start PlayMemories Mobile.
- 8 On your smartphone, select the mode of the camera: Wi-Fi Remote Control mode or Copy mode.

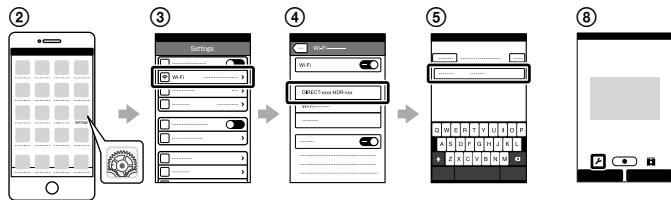

## If the sticker is lost

If the sticker is lost, you can recall your user ID and password by the following procedure.

- 1 Insert a charged battery pack into the camera.
- 2 Connect the camera to a computer with the micro USB cable (supplied).
- 3 Press the NEXT or PREV button to power on.
- 4 Display [Computer] → [PMHOME] → [INFO] → [WIFI\_INF.TXT] on your computer, then confirm your ID and password.

## Others

### Notes on long-time recording

- If the power is turned off, leave the camera for 10 minutes or longer to allow the temperature inside the camera to decrease to a safe level.
- Under high ambient temperatures, the temperature of the camera rises quickly.
- When the temperature of the camera rises, the image quality may deteriorate. It is recommended that you wait until the temperature of the camera drops before continuing to shoot.
- The surface of the camera may get hot. This is not a malfunction.

### Note on using

- When warning is displayed, entire screen flashes with the message displayed. For details, refer to the Handbook (PDF).

### About the software

You can download the image management software PlayMemories Home™ from the following URL.

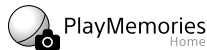

[www.sony.net/pm/](http://www.sony.net/pm/)

### Note on wireless network function

- We assume no responsibility whatsoever for any damage caused by unauthorized access to, or unauthorized use of, destinations loaded on the camera, resulting from loss or theft.

## Specifications

Signal format: NTSC color, EIA standards

HDTV 1080/60i, 1080/60p specification

PAL color, CCIR standards

HDTV 1080/50i, 1080/50p specification

Power requirements: Rechargeable battery pack, 3.6 V (NP-BX1)

USB, 5.0 V

USB charging (Multi/Micro USB Terminal): DC 5.0 V, 500 mA/800 mA

Rechargeable battery pack NP-BX1:

Maximum charge voltage: DC 4.2 V

Maximum charge current: 1.89 A

- This camera is splash-proof. The camera body has IPX4 splash-proof performance (based on our tests).
- For more specifications, refer to the Handbook (PDF).
- Design and specifications are subject to change without notice.

### On trademarks

- Memory Stick and are trademarks or registered trademarks of Sony Corporation.
- The terms HDMI and HDMI High-Definition Multimedia Interface, and the HDMI Logo are trademarks or registered trademarks of HDMI Licensing LLC in the United States and other countries.
- Mac is a registered trademark of Apple Inc. in the United States and other countries.
- iOS is a registered trademark or trademark of Cisco Systems, Inc.
- Android and Google Play are trademarks of Google Inc.
- iPhone is a trademark or a registered trademark of Apple Inc.
- Wi-Fi, the Wi-Fi logo, Wi-Fi PROTECTED SET-UP are registered trademarks of the Wi-Fi Alliance.
- The N Mark is a trademark or registered trademark of NFC Forum, Inc. in the United States and in other countries.
- Adobe, the Adobe logo, and Adobe Acrobat are either registered trademarks or trademarks of Adobe Systems Incorporated in the United States and/or other countries.
- microSDXC logo is a trademark of SD-3C, LLC.

In addition, system and product names used in this manual are, in general, trademarks or registered trademarks of their respective developers or manufacturers. However, the ™ or ® marks may not be described in this manual.

## WARNING

- To reduce the risk of fire or electric shock,**
- 1) do not expose the unit to rain or moisture.
  - 2) do not place objects filled with liquids, such as vases, on the apparatus.

**Do not expose the batteries to excessive heat such as sunshine, fire or the like.**

## CAUTION

### Battery pack

If the battery pack is mishandled, the battery pack can burst, cause a fire or even chemical burns. Observe the following cautions.

- Do not disassemble.
- Do not crush and do not expose the battery pack to any shock or force such as hammering, dropping or stepping on it.
- Do not short circuit and do not allow metal objects to come into contact with the battery terminals.
- Do not expose to high temperature above 60°C (140°F) such as in direct sunlight or in a car parked in the sun.
- Do not incinerate or dispose of in fire.
- Do not handle damaged or leaking lithium ion batteries.
- Be sure to charge the battery pack using a genuine Sony battery charger or a device that can charge the battery pack.
- Keep the battery pack out of the reach of small children.
- Keep the battery pack dry.
- Replace only with the same or equivalent type recommended by Sony.
- Dispose of used battery packs promptly as described in the instructions.

### AC Adaptor

Use the nearby wall outlet (wall socket) when using the AC Adaptor. Disconnect the AC Adaptor from the wall outlet (wall socket) immediately if any malfunction occurs while using the apparatus.

## For customers in the U.S.A. and CANADA

### RECYCLING LITHIUM-ION BATTERIES

Lithium-Ion batteries are recyclable.

You can help preserve our environment by returning your used rechargeable batteries to the collection and recycling location nearest you.



For more information regarding recycling of rechargeable batteries, call toll free

1-800-822- 8837, or visit <http://www.call2recycle.org/>

**Caution:** Do not handle damaged or leaking Lithium-Ion batteries.

### Battery pack

This device complies with Part 15 of the FCC Rules. Operation is subject to the following two conditions: (1) This device may not cause harmful interference, and (2) this device must accept any interference received, including interference that may cause undesired operation.

CAN ICES-3 B/NMB-3 B

This equipment complies with FCC/IC radiation exposure limits set forth for an uncontrolled environment and meets the FCC radio frequency (RF) Exposure Guidelines in Supplement C to OET65 and RSS-102 of the IC radio frequency (RF) Exposure rules.

This equipment has very low levels of RF energy that are deemed to comply without testing of specific absorption ratio (SAR).

## For Customers in the USA

If you have any questions about this product, you may call:

Sony Customer Information Center

1-800-222-SONY (7669)

The number below is for the FCC related matters only.

### Regulatory Information

#### Declaration of Conformity

Trade Name: SONY

Model No.: HDR-AS100V

Responsible Party: Sony Electronics Inc.

Address: 16530 Via Esprillo, San Diego, CA 92127 U.S.A.

Telephone No.: 858-942-2230

This device complies with Part 15 of the FCC Rules. Operation is subject to the following two conditions: (1) This device may not cause harmful interference, and (2) this device must accept any interference received, including interference that may cause undesired operation.

This equipment must not be co-located or operated in conjunction with any other antenna or transmitter.

### CAUTION

You are cautioned that any changes or modifications not expressly approved in this manual could void your authority to operate this equipment.

### Note

This equipment has been tested and found to comply with the limits for a Class B digital device, pursuant to Part 15 of the FCC Rules.

These limits are designed to provide reasonable protection against harmful interference in a residential installation. This equipment generates, uses, and can radiate radio frequency energy and, if not installed and used in accordance with

the instructions, may cause harmful interference to radio communications. However, there is no guarantee that interference will not occur in a particular installation. If this equipment does cause harmful interference to radio or television reception, which can be determined by turning the equipment off and on, the user is encouraged to try to correct the interference by one or more of the following measures:

- Reorient or relocate the receiving antenna.
- Increase the separation between the equipment and receiver.
- Connect the equipment into an outlet on a circuit different from that to which the receiver is connected.
- Consult the dealer or an experienced radio/TV technician for help.

The supplied interface cable must be used with the equipment in order to comply with the limits for a digital device pursuant to Subpart B of Part 15 of FCC Rules.

## For Customers in Canada

This device complies with Industry Canada licence-exempt RSS standard(s). Operation is subject to the following two conditions: (1) this device may not cause interference, and (2) this device must accept any interference, including interference that may cause undesired operation of the device.

## For Customers in Europe

### Notice for the customers in the countries applying EU Directives

Manufacturer: Sony Corporation, 1-7-1 Konan Minato-ku Tokyo, 108-0075 Japan  
For EU product compliance: Sony Deutschland GmbH, Hedelfinger Strasse 61, 70327 Stuttgart, Germany



Hereby, Sony Corporation, declares that this equipment is in compliance with the essential requirements and other relevant provisions of Directive 1999/5/EC. For details, please access the following URL: <http://www.compliance.sony.de/>

### Notice

If static electricity or electromagnetism causes data transfer to discontinue midway (fail), restart the application or disconnect and connect the communication cable (USB, etc.) again.

This product has been tested and found compliant with the limits set out in the EMC regulation for using connection cables shorter than 3 meters (9.8 feet).

The electromagnetic fields at the specific frequencies may influence the picture and sound of this unit.

### Disposal of waste batteries and electrical and electronic equipment (applicable in the European Union and other European countries with separate collection systems)



This symbol on the product, the battery or on the packaging indicates that the product and the battery shall not be treated as household waste. On certain batteries this symbol might be used in combination with a chemical symbol. The chemical symbols for mercury (Hg) or lead (Pb) are added if the battery contains more than 0.0005% mercury or 0.004% lead. By ensuring these products and batteries are disposed of correctly, you will help prevent potentially negative consequences for the environment and human health which could otherwise be caused by inappropriate waste handling. The recycling of the materials will help to conserve natural resources.

In case of products that for safety, performance or data integrity reasons require a permanent connection with an incorporated battery, this battery should be replaced by qualified service staff only. To ensure that the battery and the electrical and electronic equipment will be treated properly, hand over these products at end-of-life to the applicable collection point for the recycling of electrical and electronic equipment. For all other batteries, please view the section on how to remove the battery from the product safely. Hand the battery over to the applicable collection point for the recycling of waste batteries. For more detailed information about recycling of this product or battery, please contact your local Civic Office, your household waste disposal service or the shop where you purchased the product or battery.

## For Customers in Singapore

