

OLYMPUS[®]

DIGITAL VOICE RECORDER

DM-901

USER MANUAL

Getting started

1

Recording

2

Playback

3

Schedule

4

Menu

5

Wi-Fi Function

6

Use with a PC

7

Other information

8

Register your product on
[www.olympus-consumer.com/
register](http://www.olympus-consumer.com/register) and get additional
benefits from Olympus!

Thank you for purchasing an Olympus digital voice recorder.
Please read these instructions for information about using the product
correctly and safely.

Keep the instructions handy for future reference.

To ensure successful recording, we recommend that you test the record
function and volume before use.

EN

Table of contents

| | |
|-----------------------------|----------|
| Names of parts | 4 |
| Recorder..... | 4 |
| Display..... | 5 |

1 Getting started

| | |
|---|-----------|
| Setup | 10 |
| Inserting the battery..... | 11 |
| Charging the battery by connecting to an AC adapter with a USB connection (model AS14)..... | 12 |
| Charging the battery by connecting to a PC's USB connector..... | 13 |
| Turn the power ON..... | 15 |
| Setting the date/time..... | 15 |
| Setting the voice guidance..... | 16 |
| Batteries | 16 |
| Inserting/removing an SD card | 18 |
| Inserting an SD card..... | 18 |
| Removing an SD card..... | 19 |
| Preventing accidental operation | 21 |
| Setting HOLD mode..... | 21 |
| Releasing HOLD mode..... | 21 |
| Turning the power OFF | 22 |
| Turning the power OFF..... | 22 |
| [Home] screen operations | 23 |
| Selecting the mode..... | 23 |
| Folders | 25 |
| Folders for voice recordings..... | 25 |
| Folders for music playback..... | 25 |
| Folders for Podcast playback..... | 26 |
| Selecting folders and files | 27 |

2 Recording

| | |
|---|-----------|
| Recording | 28 |
| Basic recording procedure..... | 28 |
| Pausing/resuming recording..... | 30 |
| Monitoring while recording..... | 31 |
| Recording with an external microphone | 32 |
| Recording with an external microphone..... | 32 |
| Recording from another connected device | 33 |
| Recording audio from another device with this recorder..... | 33 |
| Recording audio from this recorder with another device..... | 33 |
| Changing the recording scene [Rec Scene] | 34 |
| Changing the recording scene..... | 34 |

3 Playback

| | |
|--|-----------|
| Playback | 36 |
| Basic playback procedure..... | 36 |
| Playback through the earphones..... | 37 |
| Fast-forwarding..... | 38 |
| Rewinding..... | 38 |
| Skipping to the beginning of a file..... | 39 |
| Changing the playback speed..... | 40 |
| ABC repeat playback..... | 41 |
| Index marks/temp marks | 44 |
| Writing an index mark/temp mark..... | 44 |
| Erasing an index mark/temp mark..... | 44 |
| Calendar Search function | 45 |
| Using the Calendar Search function to search for a file..... | 45 |
| Erasing files/folders | 46 |
| Erasing files..... | 46 |
| Erasing a folder..... | 47 |
| Partially erasing files..... | 47 |

4 Schedule

| | |
|--|-----------|
| Displaying the schedule screen | 49 |
| Operating the schedule screen..... | 49 |
| Registering a voice memo | 50 |
| Recording a voice memo on a specified date..... | 50 |
| Listening to a voice memo | 51 |
| Playing back a registered voice memo..... | 51 |
| Playing voice as an alarm | 52 |
| Setting the date and time to play back the voice memo..... | 52 |
| Erasing a voice memo | 54 |
| Erasing a voice memo..... | 54 |

5 Menu

| | |
|---|-----------|
| Setting menu items | 55 |
| Basic operation..... | 55 |
| Recording menu [Rec Menu] | 58 |
| Selecting the recording sensitivity [Rec Level]..... | 58 |
| Setting the recording mode [Rec Mode]..... | 59 |
| Selecting microphone directivity [Zoom Mic]..... | 59 |
| Reducing noise during recording [Low Cut Filter]..... | 60 |
| Setting timer recording [Timer Rec]..... | 60 |
| Changing the folder name [Folder Name]..... | 61 |
| Setting the recording monitor [Rec Monitor]..... | 61 |

Table of contents

| | |
|--|---|
| Playback menu [Play Menu]62 | Formatting a recording media [Format]88 |
| Skipping non-voice portions during playback [Voice Playback] 62 | Formatting a recording media [Format] 88 |
| Reducing noise during playback [Noise Cancel] 62 | |
| Adjusting low volume portions during playback [Voice Balancer] 62 | |
| Selecting playback modes [Play Mode].....63 | |
| Setting a skip space [Skip Space].....64 | |
| Increasing efficiency for voice transcription [Transcription Mode]65 | |
| File menu [File Menu]66 | |
| Extracting the speaking portions of files of spoken-word content [Voice Detect] 66 | |
| Preventing accidental file erasure [File Lock]..... 66 | |
| Sorting files [Sort by]..... 66 | |
| Moving/copying files [Move/Copy]..... 66 | |
| Dividing files [File Divide] 67 | |
| Displaying file or folder information [Property] 67 | |
| Erasing the content folder [Erase app data].....68 | |
| LCD/Sound menu [LCD/Sound Menu]69 | |
| Setting the backlight [Backlight].....69 | |
| Setting the LED indicator light [LED]..... 69 | |
| Turning beeping sound ON/OFF [Beep]..... 69 | |
| Changing the display language [Language]..... 70 | |
| Setting the voice guidance [Voice Guide] 70 | |
| Selecting the speaker output [Speaker] 70 | |
| Device menu [Device Menu]71 | |
| Selecting the recording media [Memory Select].....71 | |
| Setting power save mode [Power Save]..... 71 | |
| Setting the date/time [Time & Date] 71 | |
| Setting the USB connection [USB Settings]..... 72 | |
| Restoring the default settings [Reset Settings]..... 72 | |
| Formatting a recording media [Format]..... 73 | |
| Checking recording media information [Memory Info.].....73 | |
| Confirming the voice recorder information [System Info.] 74 | |
| Displaying Wi-Fi setting information [Wi-Fi].....74 | |
| Setting timer recording [Timer Rec]76 | |
| Setting timer recording [Timer Rec].....76 | |
| Extracting the speaking portions of files of spoken-word content [Voice Detect]79 | |
| Extracting the speaking portions of files of spoken-word content [Voice Detect] 79 | |
| Moving/copying files [Move/Copy]81 | |
| Moving/copying files [Move/Copy]..... 81 | |
| Dividing files [File Divide]84 | |
| Dividing files [File Divide] 84 | |
| Setting the voice guidance [Voice Guide]86 | |
| Setting the voice guidance [Voice Guide] 86 | |
| | 6 Wi-Fi Function |
| | Before using the Wi-Fi function90 |
| | About OLYMPUS Audio Controller..... 93 |
| | 7 Use with a PC |
| | PC operating environment95 |
| | PC connection/disconnection97 |
| | Connecting the voice recorder to a PC..... 97 |
| | Disconnecting the voice recorder from a PC..... 98 |
| | Functions available in Olympus Sonority100 |
| | Installing software102 |
| | Uninstalling software104 |
| | Using online help105 |
| | Upgrade function106 |
| | Loading a file to a PC108 |
| | Usage as external memory of the PC109 |
| | 8 Other information |
| | Alarm message list110 |
| | Troubleshooting112 |
| | Recorder care115 |
| | Accessories (optional)116 |
| | Copyright and trademark information118 |
| | Safety precautions121 |
| | Specifications126 |

Names of parts

Recorder

Names of parts

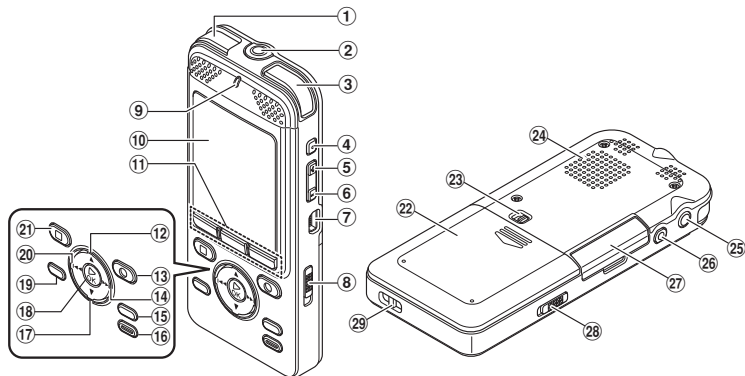

- ① Built-in stereo microphone (L)
- ② MIC (microphone) jack
- ③ Built-in stereo microphone (R)
- ④ SCENE button
- ⑤ Volume (+) button
- ⑥ Volume (-) button
- ⑦ USB connector
- ⑧ POWER/HOLD switch
- ⑨ LED indicator light (LED)
- ⑩ Display
- ⑪ F1/F2/F3 buttons
- ⑫ ▲ button
- ⑬ REC (record) (●) button
- ⑭ ►► button
- ⑮ MENU button
- ⑯ ERASE button

- ⑰ ▼ button
- ⑱ ► OK button
- ⑲ HOME button
- ⑳ ◀◀ button
- ㉑ STOP (■) button
- ㉒ Battery cover
- ㉓ Battery cover lock release lever
- ㉔ Built-in speaker
- ㉕ EAR (earphone) jack
- ㉖ Remote jack

Jack for connecting the receiving section of the optional remote control set RS30W . You can start/stop recording remotely.

- ㉗ Card cover
- ㉘ Wi-Fi ON/OFF switch
- ㉙ Strap hole

Display

■ [Home] screen

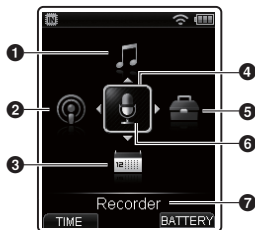

- 1 [Music] mode (☞ P.36)
- 2 [Podcast] mode (☞ P.36)
- 3 [Scheduler] mode (☞ P.49)
- 4 Cursor
- 5 [Menu] mode (☞ P.55)
- 6 [Recorder] mode (☞ P.28)
- 7 Mode currently selected

TIP

- While the voice recorder is in stop mode, you can check the current date and time by pressing the **F1 (TIME)** button on the [Home] screen. If the current date/time is set incorrectly, see "Setting the date/time [Time & Date]" (☞ P.71)

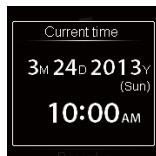

Names of parts

Display

■ [Recorder] mode

Names of parts

Folder list display

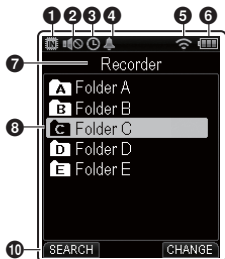

File list display

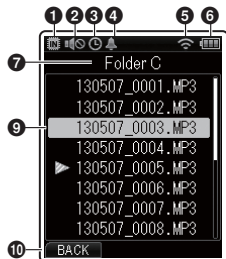

File display

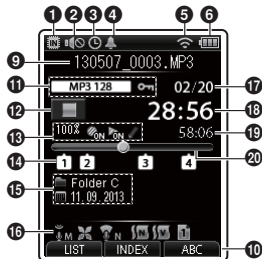

1 Recording media (☞ P.71)

- : Internal memory
- : SD card

2 Speaker (☞ P.70)

3 Timer Rec (☞ P.76)

4 Alarm (☞ P.52)

5 Wi-Fi (☞ P.74)

6 Battery (☞ P.16)

7 Current folder name

8 Folder name

9 File name

10 Function button guide

11 Recording format (☞ P.59), File lock (☞ P.66)

12 Voice recorder status indicator

- : Recording (☞ P.28)
- : Recording pause (☞ P.30)
- : Stop

: Playback (☞ P.36)

: Fast forward (☞ P.38)

: Fast rewind (☞ P.38)

: Fast playback (☞ P.40)

: Slow playback (☞ P.40)

13 Playback speed (☞ P.40),

Voice Detect (☞ P.79),

Voice Playback (☞ P.62),

Transcription Playback (☞ P.65)

14 Index (Temp) mark (☞ P.44)

15 Folder name, recording date/time

16 Indicator display area (☞ P.8)

17 Current file number in folder/Total number of recorded files in folder

18 Elapsed recording time or playback time

19 Possible recording time remaining or file length

20 Remaining memory bar, playback position bar

Names of parts

Display

■ [Music] mode

Folder list display

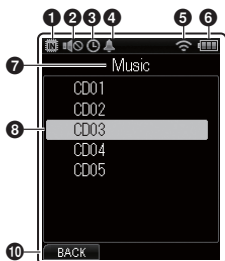

File list display

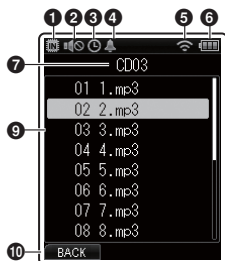

File display

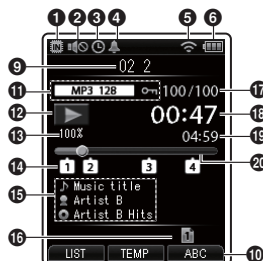

1 Recording media (☞ P.71)

- : Internal memory
- : SD card

2 Speaker (☞ P.70)

3 Timer Rec (☞ P.76)

4 Alarm (☞ P.52)

5 Wi-Fi (☞ P.74)

6 Battery (☞ P.16)

7 Current folder name

8 Folder name

9 File name

10 Function button guide

11 File format (☞ P.39), File lock (☞ P.66)

12 Voice recorder status indicator

- : Stop
- : Playback (☞ P.36)
- : Fast forward (☞ P.38)

: Fast rewind (☞ P.38)

: Fast playback (☞ P.40)

: Slow playback (☞ P.40)

13 Playback speed (☞ P.40)

14 Index (Temp) mark (☞ P.44)

15 Title, Artist, Album

16 Indicator display area (☞ P.8)

17 Current file number in folder/Total number of recorded files in folder

18 Elapsed playback time

19 File length

20 Playback position bar

Names of parts

Display

■ [Podcast] mode

Names of parts

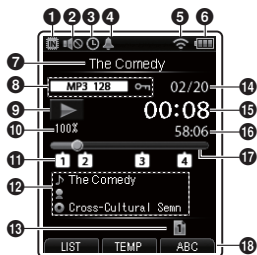

Meanings of indicators shown in indicator display area (same for all modes)

- : Rec Level
- : Low Cut Filter
- : Zoom Mic
- : Noise Cancel
- : Voice Balancer
- : Playback range
- : Repeat

1 Recording media (☞ P.71)

- : Internal memory
- : SD card

2 Speaker (☞ P.70)

3 Timer Rec (☞ P.76)

4 Alarm (☞ P.52)

5 Wi-Fi (☞ P.74)

6 Battery (☞ P.16)

7 Current file name

8 File format (☞ P.39), File lock (☞ P.66)

9 Voice recorder status indicator

- : Stop
- : Playback (☞ P.36)
- : Fast forward (☞ P.38)
- : Fast rewind (☞ P.38)
- : Fast playback (☞ P.40)
- : Slow playback (☞ P.40)

10 Playback speed (☞ P.40)

11 Index (Temp) mark (☞ P.44)

12 Title, radio station, name of program

13 Indicator display area

14 Current file number in folder/Total number of recorded files in folder

15 Elapsed playback time

16 File length

17 Playback position bar

18 Function button guide

Display

■ [Scheduler] mode

Calendar Screen

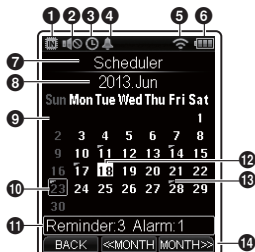

1 Recording media (☞ P.71)

: Internal memory

: SD card

2 Speaker (☞ P.70)

3 Timer Rec (☞ P.76)

4 Alarm (☞ P.52)

5 Wi-Fi (☞ P.74)

6 Battery (☞ P.16)

7 Title

8 Year and month of the calendar being displayed

9 Calendar (☞ P.45, P.49)

10 Selected date

11 Number of registered items and setting details for the selected day (Memos: 3 Alarms: 1)

12 Current date

13 Voice memo/alarm already registered

14 Function button guide

Getting started

Setup

1

After unpacking the voice recorder, follow the steps below to have it ready for use.

Setup

Step 1

Insert the battery



Step 2

Charge the recorder



Step 3

Turn the power ON



Step 4

Setting the date/time

Set the voice recorder's clock for use with file management.



Step 5

Setting the voice guidance

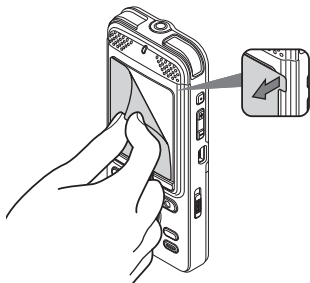

EN

Remove the screen protector on the display.

Inserting the battery

Before using the voice recorder, remove the battery from the bag and insert it in the battery compartment.

- 1 To open the battery cover, slide the battery cover lock release lever in the direction of the arrow.**

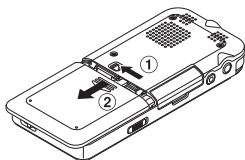

- 2 With the label on the back facing up, align the terminals on the recorder and the battery, and then press down in at (A) and set the battery into place by pressing it inward at (B).**

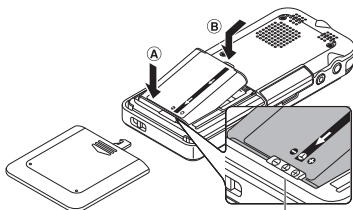
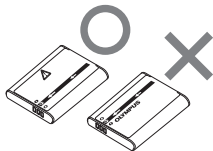

As shown, set the battery pack so that it tucks under the protruding section of the recorder.

- 3 Slide the battery cover until it is completely closed.**

NOTE

- Be sure to firmly close the battery cover (slide until the battery cover lock clicks).
- Do not close the battery cover if the battery is not completely inserted.
- Check for any metallic foreign matter or dust on the terminal of the battery.
- Do not use a battery other than that specified.

Charging the battery by connecting to an AC adapter with a USB connection (model A514)

The battery can be recharged by connecting the recorder to the provided AC adapter (A514). It is recommended to use the AC adapter when using the recorder for a long period of time, such as for long recordings.

NOTE

- Lithium-ion batteries are self-discharging. Be sure to charge the battery before you start recording.
- Before connecting the USB connector, release HOLD mode (P.21).

1 Connect the USB connection cable to the USB connector on the AC adapter.

Connect the USB cable to the AC adapter.

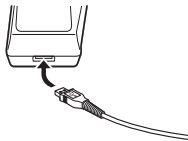

2 Connect the AC adapter to an AC power outlet.

To an AC power outlet

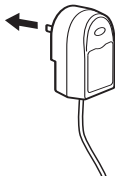

3 While the recorder is in stop mode or the recorder's power is OFF, connect the USB connection cable to the recorder's USB terminal.

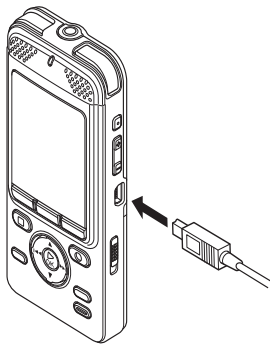

4 Press the ▲ or ▼ button to select [AC Adapter].

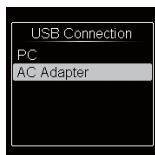
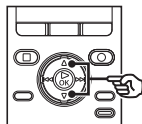

Charging the battery by connecting to an AC adapter with a USB connection (model A514)

- 5 Press the ►OK button to start charging.
- 6 Charging has finished when the battery indicator changes to .

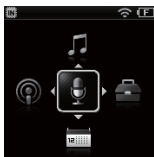

Charging time: About 3 hours*

* Approximate time needed to fully charge a completely flat battery at room temperature.

The charging time depends on the amount of remaining power and the state of the battery.

NOTE

- Use only the Olympus USB connecting AC adapter model provided (A514).

Charging the battery by connecting to a PC's USB connector

NOTE

- Before connecting the USB connector, release HOLD mode (refer P.21).

- 1 Start the PC.
- 2 Connect the USB connection cable to the USB port on the PC.

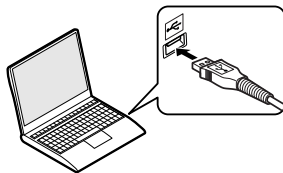

- 3 While the recorder is in stop mode or the recorder's power is OFF, connect the USB connection cable to the recorder's USB terminal.

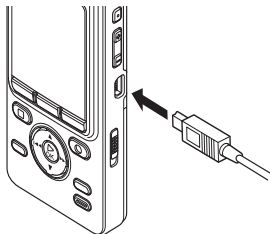

Charging the battery by connecting to a PC's USB connector

1

Setup

- 4** Press the ▲ or ▼ button to select [PC].

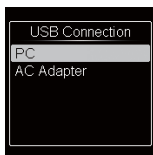
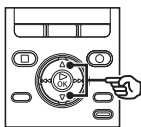

- 5** Press the ► OK button to start charging.

- 6** Charging is finished when [Battery full] appears.

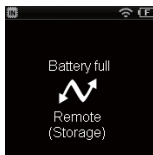

NOTE

- The power of PC must be ON to charge the battery using the USB connector. You cannot charge the battery when the power of PC is OFF, or the PC is in standby, sleep or auto power OFF mode.
- Do not use a USB hub when charging the battery by connecting to the PC.
- When [G]^{*1} or [H]^{*2} is displayed the battery cannot be charged. Charge the battery in an ambient temperature of between 5 and 35°C (41 and 95°F).
 - *1 [G]: Ambient temperature is too low.
 - *2 [H]: Ambient temperature is too high
- If battery life has become noticeably short on a full charge, replace the battery with a new one.
- Insert the USB connector securely all the way. Operation will not be normal if the connection is not made properly.
- Use only a compatible Olympus USB extension cable. Operation is not guaranteed if another manufacturer's cable is used. Only use the Olympus USB extension cable with the voice recorder and never use if a product from another manufacturer is used.
- Selecting [AC Adapter] when the AC adapter is connected will enable you to charge the battery with [USB Settings] set to [Composite] (see P.72).

Turn the power ON

- 1 While the voice recorder is turned off, slide the **POWER/HOLD** switch in the direction of the arrow.

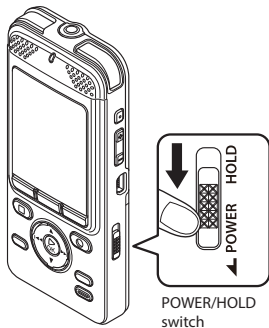

NOTE

- Always charge a rechargeable battery before using it for the first time (see P.12).

Setting the date/time

- 1 Press the **▶▶▶** or **◀◀◀** button to select the item to set.

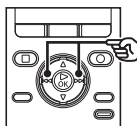

- 2 Press the **▲** or **▼** button to change the number.

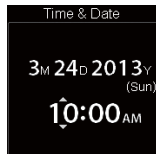

- To change the setting of another item, press the **▶▶▶** or **◀◀◀** button to move the blinking cursor, then press the **▲** or **▼** button to change the number.

- 3 Press the **▶OK** button to finalize the setting.

TIP

- If you press the **▶OK** button during the setup operation, the recorder will save the items that were set to that point.
- You can change the clock display format. See "**Setting the date/time [Time & Date]**" (see P.71) for the procedure.

Setup

1

Setup/Batteries

Setting the voice guidance

This feature gives voice announcements of recorder operating conditions.

- 1 Press the ▲ or ▼ button to select [On] or [Off].

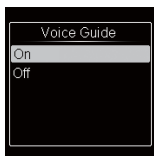
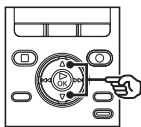

[On]: Voice guidance will be enabled.

[Off]: Guidance will be canceled.

- 2 Press the ►OK button to finalize the setting.

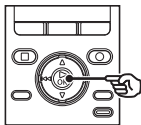

TIP

- [On/Off], [Speed], and [Volume] can be set for the voice guidance. See "Setting the voice guidance [Voice Guide]" (P.86) for the procedure.

Batteries

Rechargeable batteries

Read the information below carefully when using a lithium-ion rechargeable battery (Li-50B).

Discharging

Rechargeable batteries discharge naturally when not in use. Be sure to charge the battery before use.

Operating temperature

Rechargeable batteries are chemical-based products. Their performance can vary even when used within the recommended operating temperature range. This variation is normal.

Recommended temperature range

When powering voice recorder: 0 to 42°C (32 to 107.6°F)

When being charged: 5 to 35°C (41 to 95°F)

During long-term storage: -20 to 30°C (-4 to 86°F)

Use of a rechargeable battery outside the temperature ranges above may result in drops in battery performance or life. When not using the voice recorder for an extended period, remove the rechargeable battery before storage to prevent fluid leakage or rust.

NOTE



- Due to the nature of a lithium-ion rechargeable battery, new batteries and batteries not used for an extended period (one month or more) may not charge completely. The battery should become fully charged after charging and discharging the battery up to three times.

- Always dispose rechargeable batteries in the legally prescribed manner. Before disposing rechargeable batteries that are not fully discharged, take steps to prevent shorting such as insulating their terminals with tape.
- Always turn power off before replacing the battery. Files may be damaged if the battery is removed while the voice recorder is recording or performing an operation such as erasing a file.
- At the time of purchase, the battery cover is not attached to the device.
- You may need to reset the date/time if the battery is removed from the voice recorder for over fifteen minutes, or if the battery is quickly removed and replaced. See **“Setting the date/time [Time & Date]”** (☞ P.71) for the procedure.
- When not using the voice recorder for an extended period, always remove the battery before storage.
- When buying rechargeable batteries, always select lithium-ion rechargeable batteries (Li-50B). Operation is not guaranteed. If a battery from another manufacturer is used.
- Even if the battery indicator is , playback with the built-in speaker at some volumes may result in a drop in battery output voltage, causing the voice recorder to reset. Lower the volume in this case.
- Battery life will be shorter when using an SD card.
- The continuous battery usage time will vary depending on the performance of the battery in use (☞ P.128).
- Battery life will be shorter when using lithium-ion rechargeable battery that has been used repeatedly (☞ P.128).

Battery indicator

As the battery loses its remaining charge, the battery indicator on the display changes as follows:



-  indicates there is little remaining battery charge. Charge the battery. When the battery has run out,  and **[Battery low]** appears, operation stops.

Inserting/removing an SD card

The voice recorder has its own internal memory, and also supports standard SD cards (SD, SDHC, and SDXC) sold separately.

1

Inserting an SD card

Inserting/removing an SD card

- 1 While the voice recorder is in stop mode, open the card cover.

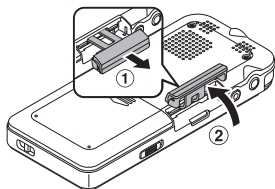

- 2 Insert an SD card, making sure it is placed correctly as shown.

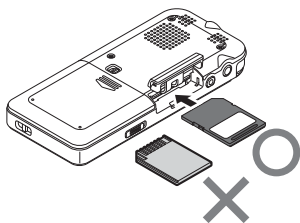

- Insert the SD card straight, avoiding crooked insertion.
- Inserting an SD card the wrong way or crookedly could damage its contact surface or cause it to jam in the slot.
- An SD card not inserted fully (until it clicks into place) might not record data.

- 3 Close the card cover.

- When you insert an SD card, the recording media selection screen will appear.

- 4 To record onto the SD card, press the **▲** or **▼** button and select [Yes].

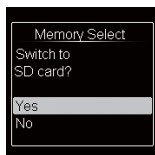
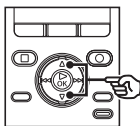

- 5 Press the **▶** OK button to finalize the setting.

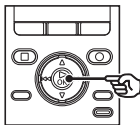

TIP

- You can also select the internal memory as the recording media (P.71).

Inserting/removing an SD card

Inserting an SD card

NOTE

- The voice recorder may not be able to recognize an SD card formatted (initialized) for a PC or other device. Before using an SD card, always initialize it on the voice recorder (P.88).

SD cards

You cannot perform recording or erasing if the write protect switch is set to the [LOCK] side.

Write protect
switch

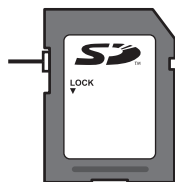

Removing an SD card

- 1 While the voice recorder is in stop mode, open the card cover.
- 2 Release the SD card by pressing it inward, then letting it slowly return.

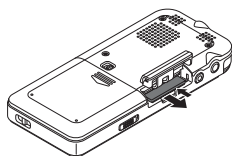

- The SD card moves outward and stops. Pull the SD card out with your fingertips.
- [Internal memory selected] is displayed after removing an SD card, if [Memory Select] was set to [SD card].



- 3 Close the card cover.

1

Inserting/removing an SD card

Inserting/removing an SD card

Removing an SD card

1

Inserting/removing an SD card

NOTE

- SD cards may pop out forcefully on removal if you flick or release your finger too quickly after pressing the SD card in.
- Depending on the card's manufacturer and type, some SD cards, SDHC cards, and SDXC cards may not be fully compatible with the voice recorder and not be recognized properly.
- For SD card compatibility under Olympus verification, please contact our customer support at:

<http://www.olympusamerica.com>
Note that our customer support will provide information on SD card manufacturers and card types for which Olympus has verified operation, but will not guarantee its performance. Also note that some cards may no longer be recognized correctly by the voice recorder in case card manufacturer changes card specifications.

- Read the operating instructions provided with the card when using an SD card.
- If an SD card is not recognized by the voice recorder, try removing and reinserting the card to have the voice recorder attempt recognition again.
- Processing speed may be low for some SD card types. Processing performance may also be reduced by writing or deleting data repeatedly from an SD card. In such a case, initialize the SD card (☞ P.88).

Preventing accidental operation

Setting the voice recorder to HOLD mode maintains the current operation and disables button operations. HOLD mode is a handy feature for preventing unintentional operation from accidental button presses when the voice recorder is carried in a bag or pocket. It is also useful for preventing the voice recorder being accidentally stopped during recording.

Setting HOLD mode

- 1 Slide the **POWER/HOLD** switch to the **[HOLD]** position.

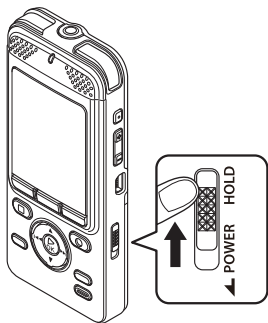

Releasing HOLD mode

- 1 Slide the **POWER/HOLD** switch to position **A** shown below.

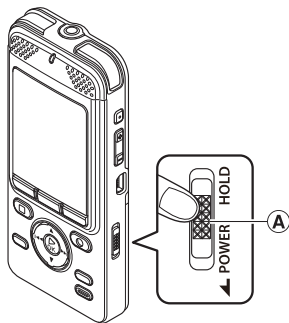

- **[Hold]** appears in the display, and the recorder enters HOLD mode.

NOTE

- If you press any button when the unit is in hold status, the LED indicator light flashes in blue but nothing happens.
- Setting HOLD mode during voice recorder playback (or recording) continues the playback (or recording) operation and prevents any other operation from being performed (the voice recorder stops when playback ends, or recording stops when there is no more available memory).

Turning the power OFF

Turning the power OFF

1

Existing data, mode settings and the clock setting are saved when the power is turned OFF.

- 1 Slide the **POWER/HOLD** switch in the direction of the arrow for at least one second.

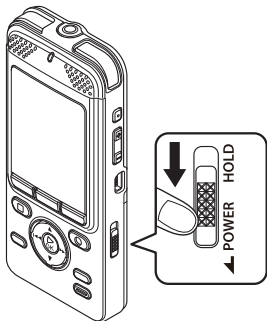

- The playback stop position at power OFF is stored in the memory.

TIP

- Turning the power OFF whenever the voice recorder is not in use minimizes battery consumption.

Power Save mode

When the voice recorder has been stopped for at least 10 minutes (default setting) after power ON, the display disappears and the voice recorder automatically enters the Power Save mode (P.71).

- To release the Power Save mode, turn the power ON again.

[Home] screen operations

Selecting the mode

The [Home] screen is displayed when the recorder power is turned ON.

The [Home] screen is how you access available functions, such as voice recorder or music player. See the reference page for each function.

- 1 Press the HOME button to display the [Home] screen.

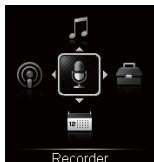

- During recording, the screen does not change to the [Home] screen.

- 2 Press the ▲/▼, ►► or ◀◀ button to select the desired mode.

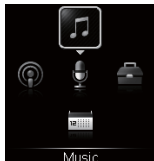
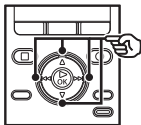

- 3 Press the ► OK button.

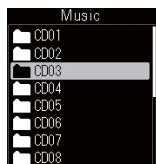
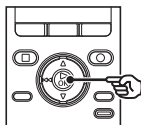

When [Recorder] is selected:

The mode changes to [Recorder] mode. In this mode can record by using the microphone or you can play files previously recorded to your voice recorder (P.28, P.36).

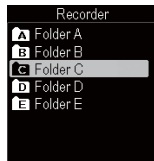

[Home] screen operations

1

[Home] screen operations

Selecting the mode

When [Music] is selected:

The mode changes to **[Music]** mode. In this mode you can play music files transferred to the voice recorder (☞ P.36).

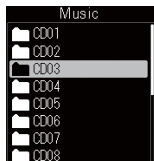

When [Scheduler] is selected:

The mode changes to **[Scheduler]** mode and voice memos can be registered on the selected date (☞ P.49).



When [Menu] is selected:

The mode changes to **[Menu]** mode and you can configure recorder functions (☞ P.55).

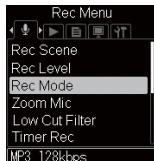

When [Podcast] is selected:

The mode changes to **[Podcast]** mode and you can play podcast content transferred to the recorder using Olympus Sonority provided (☞ P.36, P.100).

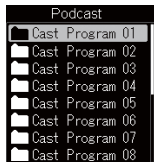

Folders

You can record data to the internal memory or SD card. Regardless of the recording media selected, voice files, music files and content files are sorted and saved in folders using a hierarchical tree structure. The saved files can be resorted in the order you prefer (P.66).

Folders for voice recordings

Sound files recorded by the voice recorder are saved in the folders labeled **[Folder A]** to **[Folder E]** in the **[Recorder]** folder. You can change the name of **[Folder A]** to **[Folder E]** (P.61).

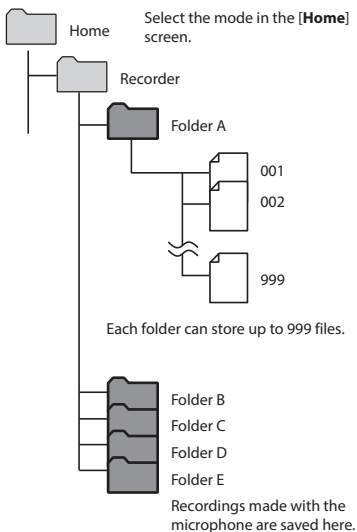

Files and folders placed directly within the **[Recorder]** folder (not within one of the sub-folders) are not displayed by the voice recorder.

Folders for music playback

When music files created using Windows Media Player are transferred to the voice recorder, folders are created automatically for them within the folder for music playback, using the hierarchical structure shown below.

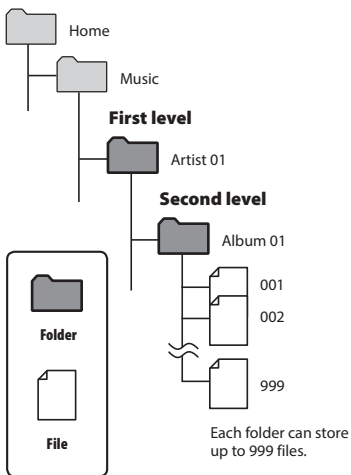

- You can save a total of 999 files and folders to the **[Music]** folder.
- You can transfer up to 6000 songs to the **[Music]** folder.

Folders for Podcast playback

The **[Podcast]** folder is provided to store files distributed by podcasts. You can listen to programs (files) transferred from Olympus Sonority to the recorder.

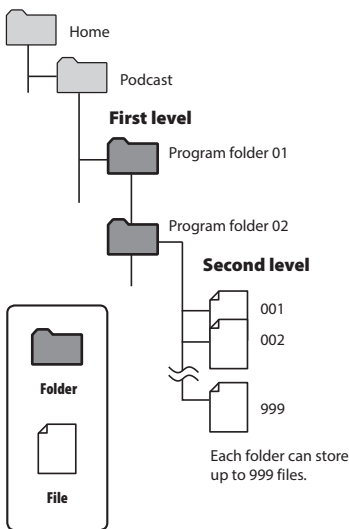

- You can save a total of 999 files and folders to the **[Podcast]** folder.
- You can transfer up to 6000 files to the **[Podcast]** folder.

Selecting folders and files

You can select a different folder while the voice recorder is in stop mode or playing a file. See “**Folders**” (P.25) for a description of the voice recorder’s hierarchical folder structure.

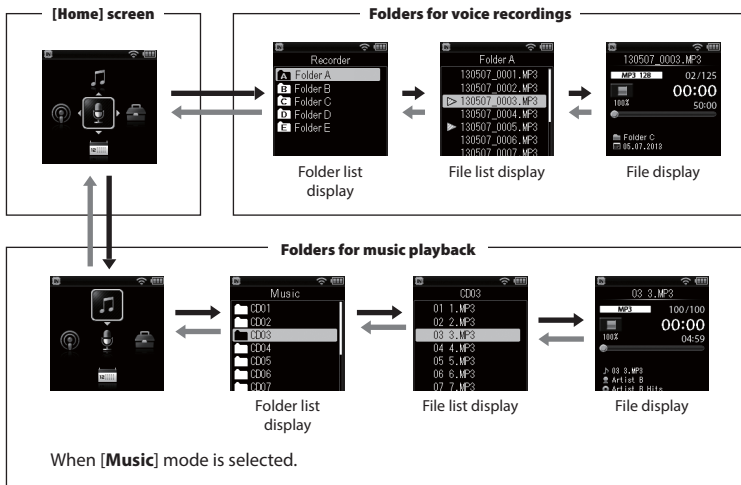

➔ Forward: ►OK button

Each press of the ►OK button opens the currently selected folder or file in the list, moving forward to the next (lower) level in the folder hierarchy. When a list is displayed, you can perform the same function by pressing the ►►I button.

◀ Return: F1 (Back/List) button

Each press of the LIST button moves back to the previous (higher) level in the folder hierarchy. When a list is displayed, you can perform the same function by pressing the I◀◀ button.

▲ or ▼ button

Used to select a folder or file.

HOME button

Return to the [Home] screen.

[Home] screen:

Used to select the voice recorder mode (P.23).

List display:

Displays the folders and files recorded in the voice recorder.

File display:

Displays the information of the selected file.

Recording

Recording

The voice recorder has five folders ([F1] to [F5]) in which recorded files can be saved. These folders provide a handy way to sort recordings into separate categories (such as business and leisure).

2

Recording

Basic recording procedure

- 1 On the [Home] screen, press the ▲, ▼, ►► or ◀◀ button, to select [Recorder], then press the ►OK button (see P.23).
- 2 Press the ▲ or ▼ button to select the desired recording folder.
 - The newly recorded sound is saved in the selected folder.
- 3 Point the built-in microphone in the direction of the sound to record.



- 4 Press the REC (●) button to start recording.

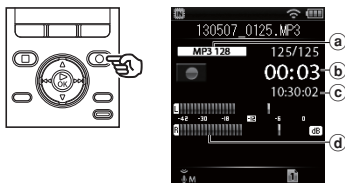

- a Rec Mode
- b Elapsed recording time
- c Remaining possible recording time
- d Level meter (changes according to recording volume and recording function setting)

- The LED indicator light lights, and  appears in the display.

- 5 Press the STOP (■) button when you want to stop recording.

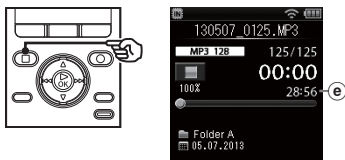

- e File length
-  appears in the display.

Sound files recorded with the voice recorder are automatically given a file name in the format below.

131001_0001.WMA

①

②

③

① Date recorded

Indicates the year, month and day the recording was made.

② File number

Appended file numbers are consecutive regardless of whether the recording media has been switched.

③ Extension

A file extension indicating the recording format the file was recorded in by the voice recorder.

- Linear PCM format: **“.WAV”**
- MP3 format: **“.MP3”**
- WMA format: **“.WMA”**

TIP

- **[Rec Mode]** must be set with the voice recorder stopped (☞ P.59).
- Pressing the **REC (●)** button while **[Recorder]** is selected on the **[Home]** screen will allow you to start recording. The recorded file will be saved to **[Folder A]**.
- You can adjust the recording level manually to match your application (☞ P.58).

NOTE

- To prevent the beginning of the recording being cut off, start recording after the LED indicator light has lit or mode indicator has appeared in the display.
- When the remaining possible recording time is 60 seconds, the LED indicator light starts flashing. It flashes more rapidly as the remaining time decreases (at the 30- and 10-second points).
- When **[Folder full]** appears, no more recording can be done. To record more, you will need to select a different folder or delete unneeded files (☞ P.46).
- If **[Memory full]** appears, the voice recorder has no more available memory space. You will need to delete unneeded files to record more (☞ P.46).
- When using an SD card in the voice recorder, be sure the desired recording media setting (**[Internal memory]** or **[SD card]**) has been selected (☞ P.71).
- If a folder other than folders **[A]** to **[E]** is selected when the **REC (●)** button is pressed, the blinking message **[Cannot record in this folder]** appears. Redo the recording operation after selecting one of folders **[A]** to **[E]**.
- It's recommended to initialize the recording media before making an important recording.
- Processing performance may be reduced when data has been repeatedly written to or deleted from the recording media. Please initialize the recording media in this case (☞ P.88).

Recording linear PCM format data over 2 GB

When recording a linear PCM format file, recording will continue even after the file size exceeds 2 GB.

- The data is divided and saved in separate files of up to 2 GB. The files are processed as multiple files during playback.
- After recording 999 files which exceed 2GB recording stops.

Pausing/resuming recording

- 1 Press the REC (●) button during recording.**

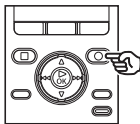

- Recording pauses, and  indicator appears in the display.
 - Recording is stopped automatically after being paused for at least 120 minutes.
- 2 Press the REC (●) button again while recording is paused.**
- Recording resumes from the position it was paused at.

Monitoring while recording

You can monitor the recording as you are making it by listening on the earphone plugged into the voice recorder's **EAR** jack. Use the +/- button to adjust the recording monitor volume.

1 Connect the earphones to the voice recorder's EAR jack.

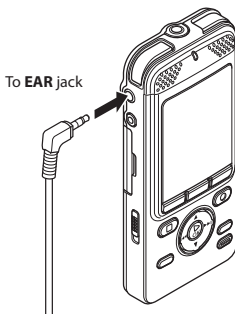

- Changing the volume will not affect the recording level.

NOTE

- To avoid unpleasantly loud sound, set the volume to [00] before plugging in the earphone.
- To prevent feedback, do not place the earphone near the microphone while recording.
- Battery life depletes quickly while recordings are monitored. To conserve battery life, leave the earphone disconnected while recording, or set **[Rec Monitor]** to **[Off]** before starting to record.

Recording settings

Various recording settings are available, letting you tailor recording to different recording conditions.

| | |
|---|--|
| [Rec Scene] (<small>☞</small> P.34) | Used to select one of multiple preregistered templates of recording settings. When selected, each template enters several settings tailored to a particular recording location or condition all in a single operation. |
| [Rec Level] (<small>☞</small> P.58) | Sets the recording sensitivity. |
| [Rec Mode] (<small>☞</small> P.59) | Sets the recording sound quality. |
| [Zoom Mic] (<small>☞</small> P.59) | Sets the built-in stereo microphone's directivity. |
| [Low Cut Filter] (<small>☞</small> P.60) | Reduces humming sounds from equipment such as air-conditioners or projectors. |
| [Timer Rec] (<small>☞</small> P.76) | Sets the content such as date and time to schedule a recording. |
| [Folder Name] (<small>☞</small> P.61) | You can change the names of Folder A to Folder E to names provided in a template beforehand. |
| [Rec Monitor] (<small>☞</small> P.61) | Selects whether or not to output the recording monitor sound from the EAR jack. |

Recording with an external microphone

Recording with an external microphone

You can record audio input using an external microphone or other device connected to the voice recorder's microphone jack. Do not plug or unplug devices into voice recorder jacks while recording.

2

Recording with an external microphone

1 Connect an external microphone to the voice recorder's MIC jack.

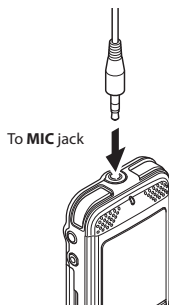

NOTE

- Connecting an external microphone to the voice recorder's **MIC** jack disables the built-in microphone.
- Microphones with plug-in power supplies can be used.
- When [**Rec Mode**] is set to stereo, recording with an external mono microphone records on the left channel only (P.59).
- When [**Rec Mode**] is set to mono, only the input from the left channel microphone is recorded when using an external stereo microphone (P.59).

2 Start recording.

- See "**Recording**" (P.28) for descriptions of recording operations.

TIP

- See "**Accessories (optional)**" (P.116) for the compatible external microphones.

Recording from another connected device

Recording audio from another device with this recorder

Audio can be recorded when you have connected the audio output terminal (earphone jack) of another device and the **MIC** jack of the recorder using the connecting cord KA333 (optional) for dubbing.

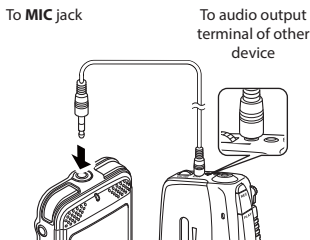

NOTE

- When recording from a connected external device, perform a test recording and adjust the output level of the connected device as needed.

Recording audio from this recorder with another device

Audio from this recorder can be recorded to another device by connecting the audio input terminal (microphone jack) of the other device and the **EAR** jack of this recorder using the connecting cord KA333 (optional).

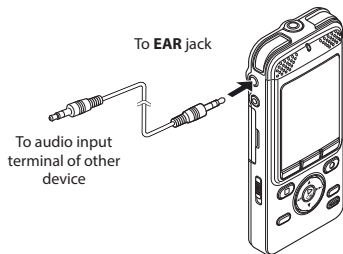

NOTE

- When you adjust various playback sound quality settings of the recorder, the signals output from the **EAR** jack change as well (P.62).

Changing the recording scene [Rec Scene]

Changing the recording scene

The voice recorder has preregistered templates of optimum settings tailored to various recording applications such as lectures and dictation. When selecting one of these templates you can enter several settings recommended for your recording application all in a single operation.

2

Changing the recording scene [Rec Scene]

- 1 While the voice recorder is in stop mode, press the **SCENE** button.

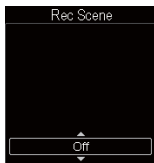
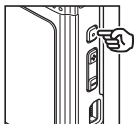

- 2 Press the **▲** or **▼** button to select the desired recording scene.

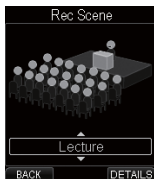
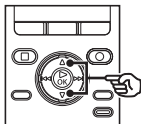

TIP

- Press the **F3 (DETAILS)** button to check the settings for the selected template. Press the **F1 (BACK)** button to return to [Rec Scene] screen.

- 3 Press the **▶ OK** button to finalize the setting.

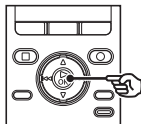

Rec Scene

- According to the setting, the setting icon is displayed.

NOTE

- When record scene is selected, you cannot change record-related menu settings. To use those functions, set the [**Rec Scene**] setting to [**Off**].

Changing the recording scene [Rec Scene]

Preregistered [Rec Scene] settings

[Lecture]:

| | |
|------------------|----------------|
| [Rec Level] | [High] |
| [Rec Mode] | [MP3 128 kbps] |
| [Zoom Mic] | [+6] |
| [Low Cut Filter] | [On] |

[Conference]:

| | |
|------------------|----------------|
| [Rec Level] | [Middle] |
| [Rec Mode] | [MP3 128 kbps] |
| [Zoom Mic] | [Off] |
| [Low Cut Filter] | [On] |

[Meeting]:

| | |
|------------------|----------------|
| [Rec Level] | [Middle] |
| [Rec Mode] | [MP3 128 kbps] |
| [Zoom Mic] | [Off] |
| [Low Cut Filter] | [Off] |

[Dictation]:

| | |
|------------------|----------------|
| [Rec Level] | [Low] |
| [Rec Mode] | [MP3 128 kbps] |
| [Zoom Mic] | [Off] |
| [Low Cut Filter] | [On] |

[DNS]:

| | |
|------------------|----------------|
| [Rec Level] | [Low] |
| [Rec Mode] | [MP3 128 kbps] |
| [Zoom Mic] | [Off] |
| [Low Cut Filter] | [Off] |

Playback

Playback

In addition to files recorded by the voice recorder, you can also play files in WAV, MP3 and WMA format transferred from a PC.

Basic playback procedure

3



Playback

- 1 Select the file to play from the folder containing it (see P.27).

TIP

- Files are saved in the locations below.

Files recorded with the built-in microphone:

[Recorder] folders (folders  to )

Music files transferred from a PC:

[Music] folder

Podcast files transferred from a PC:

[Podcast] folder

- 2 Press the  OK button to start playback.



- (a) Recording media indicator
 - (b) File name
 - (c) Elapsed playback time
 - (d) File length
 - (e) Playback position bar indicator
 - (f) Folder indicator, recording date/time
-  appears in the display.

- 3 Press the +/- button to adjust the volume to the desired level.



- The volume can be adjusted to a setting between [00] to [30]. The higher the number, the louder the volume.

- 4 Press the STOP () button to stop playback.

-  appears in the display.
- The file being played stops right away. The resume function automatically stores the playback stop position in memory. The position is retained even if the power is turned OFF. The next time the power is turned ON, playback can be resumed from the stop position stored in the memory.

Playback settings

You can select various file playback methods tailored to different applications and tastes.

| | |
|--|--|
| [Voice Playback]* (<small>ESP</small> P.62) | Only plays voice portions of a recorded audio file. |
| [Noise Cancel]* (<small>ESP</small> P.62) | A setting that makes recorded voices more discernable when muffled by projector noise or similar sounds. |
| [Voice Balancer]* (<small>ESP</small> P.62) | Compensates low-volume portions of recorded audio files during playback. |
| [Play Mode] (<small>ESP</small> P.63) | Selecting from among three playback modes. |
| [Skip Space]* (<small>ESP</small> P.64) | A handy function for quickly moving the playback position, and playing short segments repeatedly. |
| [Transcription Mode]* (<small>ESP</small> P.65) | Switches to the playback operation setting. In this setting transcription can be made while listening to recorded content. |

* Function active only in **[Recorder]** mode.

Playback through the earphones

You can connect the earphones to the voice recorder's **EAR** jack and listen to playback through them.

- 1 Connect the earphones to the voice recorder's EAR jack.**



- 2 Press the ►OK button to start playback.**

TIP

- There will be no sound from the speaker when the earphones are connected.

NOTE

- To avoid unpleasantly loud sound, set the volume to **[00]** before plugging in the earphone.
- Avoid excessive volume when listening to playback through the earphones. It may cause hearing damage or loss.

Fast-forwarding

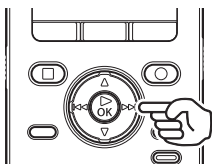

Fast-forwarding while the voice recorder is in stop mode

- 1 While the voice recorder is in stop mode, press and hold the ►► button.**

- ►► appears in the display.
- Fast-forwarding stops when you release the ►► button. Press the ►OK button to start playback from the current position.

Fast-forwarding during playback

- 1 Press and hold the ►► button during playback.**
 - Playback starts from the current position when you release the ►► button.
 - If an index mark or temp mark in the file is reached, fast-forwarding stops at the mark (☞ P.44).
 - Fast-forwarding stops when the end of the file is reached. Press and hold the ►► button again to fast-forward from the beginning of the next file.

Rewinding

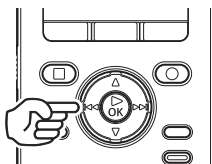

Rewinding while the voice recorder is in stop mode

- 1 While the voice recorder is in stop mode, press and hold the ◀◀ button.**

- ◀◀ appears in the display.
- Rewinding stops when you release the ◀◀ button. Press the ►OK button to start playback from the current position.

Rewinding during playback

- 1 Press and hold the ◀◀ button during playback.**
 - Playback starts from the current position when you release the ◀◀ button.
 - If an index mark or temp mark in the file is reached, rewinding stops at the mark (☞ P.44).
 - Rewinding stops when the beginning of the file is reached. Press and hold the ◀◀ button again to rewind from the end of the previous file.

Skipping to the beginning of a file

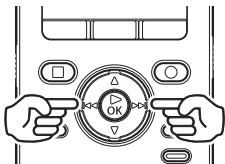

Skipping to the beginning of the next file

- 1 Press the **▶▶▶** button while the voice recorder is in stop mode, or during playback.

Skipping to the beginning of the current file

- 1 While the voice recorder is in stop mode or playing back, press the **◀◀◀** button.

Skipping to the beginning of the previous file

- 1 Press the **◀◀◀** button when the playback position is the beginning of the file.
 - To skip to the beginning of the previous file during playback, press the **◀◀◀** button twice consecutively.

NOTE

- If an index mark or temp mark is reached when skipping to the beginning of a file during playback, playback starts from the position of the mark. When skipping to the beginning of a file while the voice recorder is in stop mode, the mark is ignored (☞ P.44).

- If a setting other than **[File Skip]** is set for **[Skip Space]**, playback starts after the set amount of time has been skipped backwards or forwards. Playback does not skip to the beginning of the file.

Music files

If a music file transferred to the voice recorder is unplayable, check that its sampling rate, bit count and bit rate values are within the supported ranges. The sampling rate, bit count and bit rate combinations supported for music file playback by the voice recorder are shown below.

| File format | Sampling rate | Bit count/bit rate |
|-------------|---|--------------------|
| WAV format | 44.1 kHz, 48 kHz | 16 bits |
| MP3 format | MPEG 1 Layer 3: 32 kHz, 44.1 kHz, 48 kHz MPEG 2 Layer 3: 16 kHz, 22.05 kHz, 24 kHz | 8 to 320 kbps |
| WMA format | 8 kHz, 11 kHz, 16 kHz, 22 kHz, 32 kHz, 44.1 kHz, 48 kHz | 5 to 320 kbps |

- MP3 files with variable bit rates (bit rates converted variably in a single file) may not play normally.
- Linear PCM-format WAV files are the only WAV files the voice recorder can play. Playback of other WAV files is not supported.
- Even if the file formats is compatible for playback on this recorder, the recorder does not support every encoder.

Changing the playback speed

You can change the playback speed. Changing the playback speed is handy for speeding up conference presentations, or for slowing down parts difficult to discern when learning a language. You can set the playback speed from 50% (slow) to 100% (normal) to 600% (fast).

- 1 Press the **▶OK** button during playback.

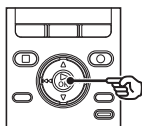

- 2 Press the **▲** or **▼** button to select the desired playback speed.

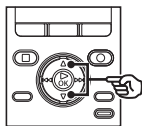

- 3 Press the **▶OK** button.

Playback speed display

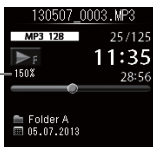

TIP

- When changing the playback speed, playback operations such as stopping playback, skipping to the beginning of a file, and writing index marks/temp marks are the same as during standard playback.

NOTE

- Altered playback speed settings are retained even after power OFF.
- During playback of a file, the **[Speed]** (P.86) setting of **[Voice Guide]** is disabled.

Fast playback restrictions

Depending on their sampling rate and bit rate, some files may not play normally. In this case you will need to reduce the playback speed in this case.

ABC repeat playback

The voice recorder has a function that lets you repeat the playback of a portion (segment) of the file being played. In addition to the A-B repeat function available from previous models, the segment to repeat can be changed during repeat playback.

ABC repeat playback

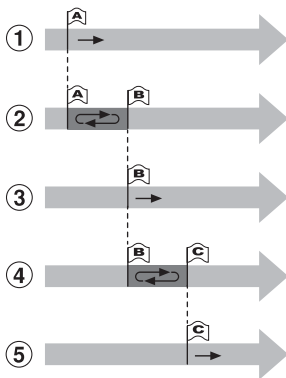

- ① Select the starting point for repeat playback (A) during playback.
- ② When the ending point (B) is selected, repeat playback starts.
- ③ When the starting point for repeat playback (A) is canceled during repeat playback, the ending point of the segment (B) becomes the new starting point and playback continues.
- ④ When the ending point (C) is selected, repeat playback starts again.
- ⑤ These steps can be repeated to re-specify a new segment to be played back repeatedly up to the end of the file.

- 1 Select a file for ABC repeat playback, and start playback.
- 2 Press the F3 (ABC) button when playback reaches the desired start position for ABC repeat playback.

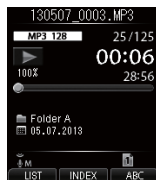

TIP

- You can change the playback speed (P.40), and fast-forward/rewind (P.38) when the [ABC] indicator is blinking.

ABC repeat playback

- If playback reaches the end of the file when the **[B]** indicator is blinking, the end of the file is treated as the segment end position, and repeat playback starts.

- 3 Press the F3 (SET B) button again when playback reaches the desired end position for ABC repeat playback.**

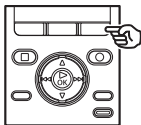

- Segment A-B is set, and ABC repeat playback starts.

To stop ABC repeat playback:

Go to Step 6

To update the repeat position:

Go to Step 4

To update the repeat position

- 4 Press the F3 (CANCEL A) button during ABC repeat playback.**

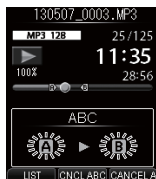
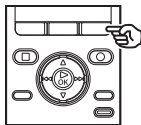

- Segment A-B is canceled. **[B]** becomes the new start position, and playback continues.
- You can change the playback speed (Ⓜ P.40), and fast-forward/rewind (Ⓜ P.38).

- 5 Press the F3 (SET C) button at the desired end position for ABC repeat playback.**

ABC repeat playback

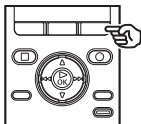

- Segment B-C is determined and ABC repeat playback starts.

TIP

- As necessary, repeat Steps 4 and 5 to change the repeated segment.

6 Press the STOP (■) button.

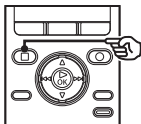

- Playback stops. The ABC repeat playback segment is not canceled.

NOTE

- You cannot change the end position of a repeat playback segment to a position before the start position.
- You cannot write index marks or temp marks during ABC repeat playback (P.44).

Canceling ABC repeat playback

1 Press the F2 (CNCL ABC) button.

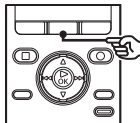

- If pressed when ABC repeat playback is stopped, cancels ABC repeat playback.
- If pressed during ABC repeat playback, cancels the playback segment setting for the function, and continues standard playback.

NOTE

- If you change the file or switch to different display screen, ABC repeat playback is canceled.

Index marks/temp marks

Writing an index mark or temp mark in a file enables you to quickly access desired position in the file with the same operations used for fast-forwarding, rewinding or skipping to the start of a file. Index marks are added to the files created using Olympus voice recorders and temp marks are added to files created using other devices. The position you wish to start listening from can be temporarily stored in a file during playback.

Writing an index mark/temp mark

- 1 At the position to add an index mark or temp mark, press the F2 (INDEX) button.

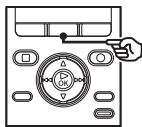

NOTE

- Temp marks are temporary markings. They are automatically erased when you select a different file, transfer the file to a PC, or move the file on a PC.
- You can write up to 99 index marks/temp marks in a single file. The message **[No more can be set]** appears if you attempt to write more than 99 marks.
- You cannot write or erase index marks/temp marks in files that have been locked by the file lock function (P.66).

Erasing an index mark/temp mark

- 1 Select a file that contains index mark/temp mark you want to erase and start playback.
- 2 Use the ►► or ◀◀ button to select the index mark/temp mark you want to erase.



- 3 When the number of the index mark/temp mark to erase is being shown (for about 2 seconds) in the display, press the ERASE button.

- Any subsequent index marks/temp marks in the file are automatically renumbered.

Calendar Search function

Using the Calendar Search function to search for a file

You can search for voice files by specifying a recording date. If you have forgotten in which folder a file has been saved, this feature lets you access it quickly by entering its recording date.

1 Press the **HOME** button to display the [Home] screen.

2 Press the **▶OK** button to enter [Recorder] mode.

3 Press the **F2 (SEARCH)** button.



4 Press the **▲, ▼, ▶▶▶** or **◀◀◀** button to select the desired date.

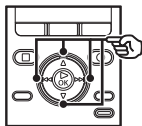

- a Year and month of the calendar being displayed
 - b Cursor
 - c Current date
 - d Number of files registered for the selected date
- Dates on which files were saved are underlined.

▲, ▼, ▶▶▶, ◀◀◀ button:

Dates on which there are no recorded files are skipped and moves to the next date that contains a recording.

F1, F3 button:

Move to the previous/next month.

- Press the **F2 (SEARCH)** button to cancel the setting and return to the [Recorder] screen.

5 Press the **▶OK** button.

6 Press the **▲** or **▼** button to select the desired file.

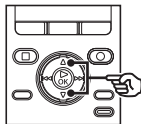

7 Press the **▶OK** button to start playback.

NOTE

- You can only search for files saved in the folder for voice recordings ([F1] to [E1]).

Erasing files/folders

This section describes how to erase a single unneeded file from a folder, erase all the files in the current folder at once, or erase a selected folder.

Erasing files

- 1 Select the file you want to erase (P.27).

- 2 When the file display screen appears, press the **ERASE** button while the voice recorder is in stop mode.



- The voice recorder returns to the stopped mode if no operation is performed for 8 seconds.

- 3 Press the **▲** or **▼** button to select **[All in folder]** or **[One file]**.

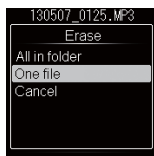
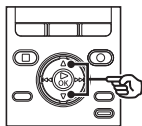

[All in folder]:

Erases all the files saved in the same folder as the selected file.

[One file]:

Erases only the selected file.

- 4 Press the **▶OK** button.

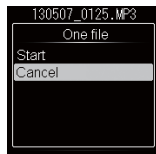

- 5 Press the **▲** button to select **[Start]**.

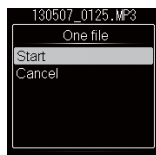
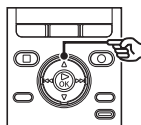

- 6 Press the **▶OK** button.



- **[Erasing!]** appears in the display, and the erasing process starts. **[Erased]** appears when the process has finished.

Erasing files/folders

Erasing a folder

- 1 Select the folder you want to erase (see P.27).
- 2 In the folder display screen, press the ERASE button while the voice recorder is in stop mode.



- The voice recorder returns to the stopped mode if no operation is performed for 8 seconds.

- 3 Press the ▲ button to select [Start].

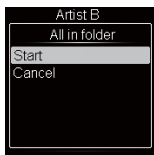
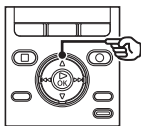

- 4 Press the ►OK button.

- [Erasing!] appears in the display, and the erasing process starts. [Erased] appears when the process has finished.

Partially erasing files

You can erase unneeded parts of a file.

 You can only partially erase PCM format files recorded using this recorder.

- 1 Play back a file you wish to partially erase.

- Advance the file to the position you wish to erase. If the file is long, use the ►| button to advance to the position where you wish to erase.

- 2 Press the ERASE button at the partial erase start position.

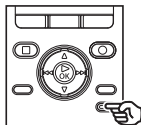

- Playback continues while [Partial Erase] is flashing and as with usual playback, fast-forward/rewind can be performed and you can quickly advance to the end position. When the end of the file is reached while the display is flashing, that position becomes the end position of erase.

Erasing files/folders

3

Erasing files/folders

Partially erasing files

- 3 Press the ERASE button again at the position where you wish to end partial erase.**

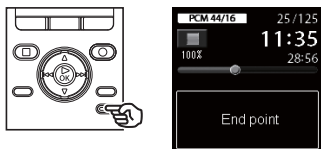

- On the display, **[Start point]** and **[End point]** flashes alternately.

- 4 Press the ERASE button.**

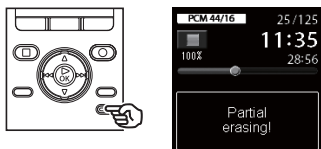

- The display changes to **[Partial erasing!]** and erasing process starts. When **[Partial erase completed]** is displayed, the procedure is completed.
- Playback stops at the position where partial erase was completed.
- If you don't press the **ERASE** button within 8 seconds, partial erase is canceled and the unit returns to playback status.

NOTE

- Files cannot be restored after being erased, so please check carefully before erasing a file.

- When the SD card is set to write-protected, **[SD Card Protected]** is displayed. To erase files, cancel SD card write protection (☞ P.19).
- When an SD card is inserted in the recorder, be sure to confirm that the recording media used is the **[Internal memory]** or **[SD card]** so there is no mistake about where files are stored (☞ P.71).
- Locked files and read-only files cannot be erased (☞ P.66).
- You cannot erase **[Recorder]** (**[Folder A]** to **[Folder E]**), **[Music]**, and **[Podcast]**, which are preset in the recorder.
- **[Music]** folder subfolders other than the **[Music]** can be erased.
- **[Podcast]** folder subfolders other than the **[Podcast]** can be erased.
- If there is a file that cannot be recognized by the recorder, the file and the folder which contains that file will not be erased. The voice recorder must be connected to a PC to erase these files and folders.
- Before erasing a file or folder, charge or replace the battery to ensure it will not run out before the process has finished. Erasing processes can take over 10 seconds to complete. To prevent the risk of damage to data, never attempt to perform any of the following processes before an erasing process has finished:
 - ① Disconnecting the AC adapter
 - ② Removing the battery
 - ③ Removing the SD card (if the recording media has been set to **[SD card]**).

EN

48

Schedule

Displaying the schedule screen

Operating the schedule screen

This recorder has a voice memo function that allows you to record a one-minute voice memo on a specified date and time.

Because the voice memo is played at a specified day and time, it can be used to help manage your schedule.

1 Press the **HOME** button to display the [Home] screen.

2 Press the **▼** button to select [Scheduler].

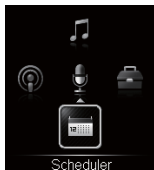

3 Press the **►** OK button.

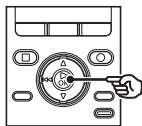

- The  mark is displayed on dates where a memo or schedule recording is registered.

4 Press the **▲**, **▼**, **►►** or **◄◄** button to move the cursor.



- a** Year and month being displayed
- b** Current date
- c** Cursor
- d** The number of memos and scheduled playback registered for the selected date

►►, ◄◄ button:

Move to the previous/next date.

▲, ▼ button:

Move to the previous/next week.

F2, F3 button:

Move to the previous/next month.

5 Press the **F1 (BACK)** button to exit the schedule screen.

Registering a voice memo

Recording a voice memo on a specified date

You can record a voice memo that is a maximum of one minute long. Up to 99 voice memos can be recorded in a day, and a total of up to 1,000 voice memos can be registered on this recorder.

- 1 Press the **HOME** button to display the [Home] screen.
- 2 Press the **▼** button to select [Scheduler].
- 3 Press the **▶OK** button.

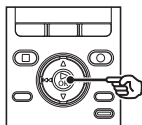

- 4 Press the **▲**, **▼**, **▶▶** or **◀◀** button to select the date on which you wish to record a voice memo.

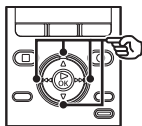

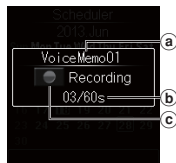
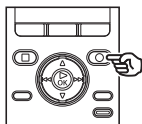

- 5 Press the **REC (●)** button to record a voice memo.

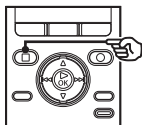

- a) File number
- b) Elapsed recording time/Possible recording time
- c) Voice recorder status indicator

- 6 Press the **STOP (■)** button when you want to stop recording.



- The calendar screen reappears, on which an  mark is added to the registered date.

Listening to a voice memo

Playing back a registered voice memo

You can play back a registered voice memo.

- 1 Press the **HOME** button to display the [Home] screen.
- 2 Press the **▼** button to select [Scheduler].
- 3 Press the **▶OK** button.



- 4 Press the **▲**, **▼**, **▶▶▶** or **◀◀◀** button to select the date on which the voice memo is registered.

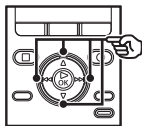

- 5 Press the **▶OK** button.

- 6 Press the **▲** or **▼** button to select the voice memo you wish to play back.

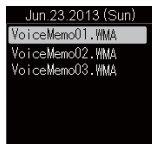
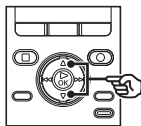

- 7 Press the **▶OK** button to play back the voice memo.

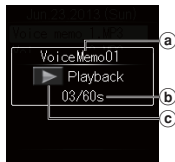
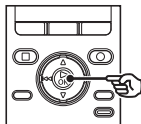

- a File number
- b Elapsed playback time/file length
- c Voice recorder status indicator

- 8 Press the **+/-** button to adjust the volume to the desired level.

Playing voice as an alarm

Setting the date and time to play back the voice memo

You can use the alarm function to play back a registered voice memo at a specified date and time.

- 1 Select the voice memo you wish to play back as an alarm (see P.51).

- 2 Press the F3 (ALARM) button.

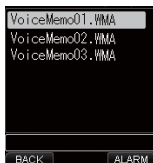
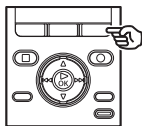

- 3 Press the >>> or <<< button to select the desired setting item.

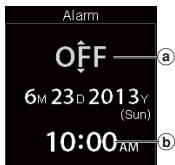

- Preset ON/OFF:**
Set whether to execute the set content.
- Preset execution time:**
Set the start time of alarm playback.

Setting ON/OFF:

- 1 Press the ▲ or ▼ button to select [ON] or [OFF].



- [ON]: Executes the set content.
[OFF]: Does not execute the set content.

Setting the execution time:

- 1 Press the ▲ or ▼ button to change the number.
- 2 Press the >>> or <<< button to move the cursor.



- 3 Repeat steps 1 and 2 to set the execution time.

Playing voice as an alarm

Setting the date and time to play back the voice memo

- 4 Press the **F3 (G0)** button to complete the setting.

Alarm playback

The alarm sounds when the set time arrives. While the alarm is sounding, press the ► **OK** button to play the preset voice memo. Press the **STOP** (■) button to stop playback.

TIP

- The alarm stops automatically in five minutes if the button is not pressed. At that time, the voice memo is not played.
- Even though the power is OFF or the unit is in HOLD mode, the alarm sounds when the set alarm time arrives. Even when in HOLD mode, pressing the ► **OK** button starts playback of the set voice memo.

NOTE

- Alarm playback does not operate if the recorder is operated at the set alarm playback time or the recorder is operating at that time.
- When the timer record and start time setting are the same, the timer recording setting takes precedence (P.76).

Erasing a voice memo

Erasing a voice memo

You can erase voice memos. You can erase voice memos one at a time or collectively.

- 1 Select the voice memo you wish to erase (P.51).

- 2 Press the ERASE button.

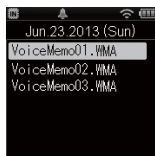

- 3 Press the ▲ or ▼ button to select the erase mode.

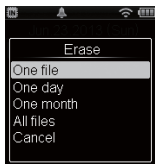
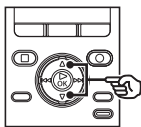

[One file]: Erases the selected voice memo.

[One day]: Erases all voice memos that are registered on the same date as the selected voice memo.

[One month]: Erases all voice memos that are registered in the same month as the selected voice memo.

[All files]: Erases all voice memos registered in the recorder.

- 4 Press the ► OK button.

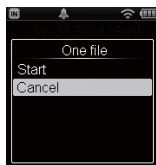
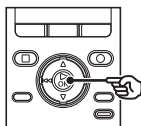

- 5 Press the ▲ button to select [Start].

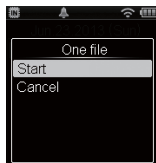
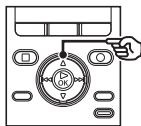

- 6 Press the ► OK button.

- **[Erased]** appears when the process has finished.

Menu

Setting menu items

Basic operation

Menu items are arranged by tabs, letting you quickly set desired items by selecting a tab and then moving to the desired item within the tab. Follow the steps below to set a menu item.

- 1 Press the **MENU** button during recording, playback or stop.

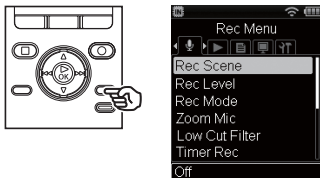

TIP

- In addition to pressing the **MENU** button, you can also enter the menu screen from the **[Home]** screen (☞ P.23).
- Some menus contain items that can be set during recording/playback (☞ P.57).

- 2 Press the **▶▶** or **◀◀** button to select the tab of the item that you wish to set.

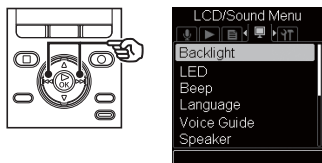

- Moving the cursor from one tab to another switches the displayed menu screen.

- 3 Press the **▲** or **▼** button to select the desired setting item.

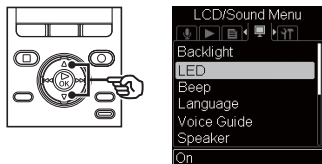

Setting menu items

Basic operation

4 Press the ►OK button.

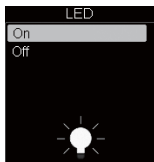

- A message indicating the setting has been entered appears.
- If you press the ◀◀ button without pressing the ►OK button, the setting is canceled and the previous screen is displayed.

7 Press the F1 (BACK) button to exit the menu screen.

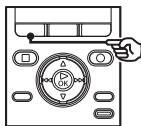

- When you enter the menu screen during recording or playback, press the **F1 (BACK)** button to return to the previous screen without interrupting recording or playback.

5

Setting menu items

- The setting of the selected item is displayed.
- You can also use the ►►I button to perform this operation.

5 Press the ▲ or ▼ button to change the setting.

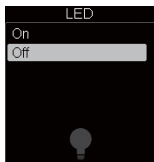
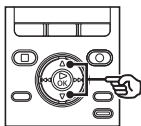

6 Press the ►OK button to finalize the setting.

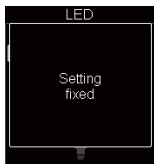

NOTE

- For menu settings done while the voice recorder is in stop mode, the voice recorder exits the menu and returns to the stopped mode if no operation is performed for 3 minutes. The selected setting item is not changed in this case.
- For menu settings done during recording/playback, the voice recorder exits the menu if no operation is performed for 8 seconds.

Basic operation

■ Menu items that can be set during recording;

- Rec Level
- Zoom Mic
- Low Cut Filter
- Folder Name
- Rec Monitor
- Backlight
- LED

■ Menu items that can be set during playback;

- Noise Cancel*¹
- Voice Balancer*¹
- Play Mode
- Skip Space*¹
- Property
- Backlight
- LED

*1 Function active only in [Recorder] mode.

Recording menu [Rec Menu]

Selecting the recording sensitivity [Rec Level]

You can change the recording level (sensitivity) as needed for your recording application.

[High]:

The highest recording sensitivity. Suited to recording lectures, large conferences and other applications with distant or quiet sound sources.

[Middle]:

Suitable for recording in a meeting with a small number of people.

[Low]:

The lowest sensitivity, this level is suitable for dictation.

[Manual]:

You can adjust the recording to any of 30 levels.

TIP

- When you wish to record a speaking voice clearly, set [Rec Level] to [Low], and place the voice recorder's built-in microphone near the speaker's mouth (5 to 10 cm away).

NOTE

- When [Rec Level] is set to [High], [Middle] or [Low], the recording level is adjusted automatically. Excessively loud sound input may generate noise regardless of whether [Rec Level] is set to [High], [Middle] or [Low].

Adjusting the recording level

- Adjust the recording level by pressing the **▶▶** or **◀◀** button during recording or when recording is paused.



- Increasing the [Rec Level] number increases the recording level and extends the level meter indicator position.

NOTE

- Setting the voice recorder to [Manual] disables the limiter function. If [OVER] is displayed, the recorded audio will be distorted. Adjust the recording level so that [OVER] is not displayed.

Recording menu [Rec Menu]

Setting the recording mode [Rec Mode]

You can prioritize sound quality or recording time. Select the recording mode that best matches your recording application.

[PCM 48kHz/16bit]
[PCM 44.1kHz/16bit]
[MP3 256kbps]
[MP3 128 kbps]
[WMA 32 kbps mono]*
[WMA 8 kbps mono]*

* Mono recording

TIP

- The [Rec Mode] screen shows the highest sound quality order, beginning from the top.
- Setting a higher recording rate increases file size. Check that you have enough remaining memory before recording.
- To record conferences and presentations clearly, it is recommended to set [Rec Mode] setting to [MP3 128kbps] or above.

NOTE

- When [Rec Mode] is set to stereo, recording with a connected mono microphone records on the left channel only.

Selecting microphone directivity [Zoom Mic]

The voice recorder's built-in stereo microphone provides directivity ranging from broad-coverage stereo recording to highly directional recording.

- 1 Press the **▲** or **▼** button to adjust the directionality of the built-in stereo microphone.

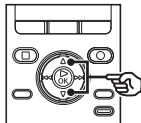

- The + button increases directivity.
- The – button enables recordings with broader-coverage stereo.
- Reducing directivity and broadening the sound pickup range gives recordings more of a stereo effect.
- You can adjust the range between [–3] and [+6].

Recording menu [Rec Menu]

Zoom mic function

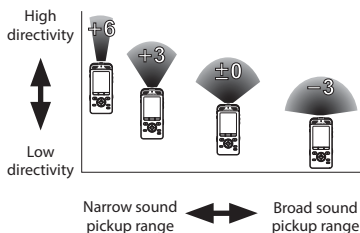

NOTE

- The **[Zoom Mic]** function is designed to demonstrate the performance by the recorder's built-in stereo microphone. Note that normal recording may no longer be possible when using a separately purchased microphone or when recording from another device using a connecting cord.
- The following function is not available when the **[Zoom Mic]** function is used.
 - **[With recording]** (P.79)

Reducing noise during recording [Low Cut Filter]

The voice recorder's low cut filter function lets you make recordings that reduce humming sounds from air-conditioners or low-frequency sounds from equipment such as projectors.

- [On]:**
Turns the low cut filter ON.
- [Off]:**
The low cut filter is disabled.

Setting timer recording [Timer Rec]

Recording starts automatically when the set time arrives.

See "**Setting timer recording [Timer Rec]**" (P.76) for the procedure.

Recording menu [Rec Menu]

Changing the folder name [Folder Name]

You can change the name [Folder A] to [Folder E] for voice recording.

- 1 Press the ▲ or ▼ button to select the folder you wish to change.

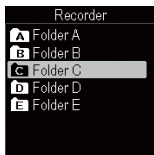
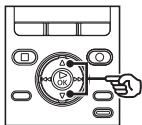

- 2 Press the ▲ or ▼ button to select the name you wish to change from the registered list.

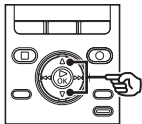

Template list

| Folder A | Folder B | Folder C | Folder D |
|---------------------|--------------|---------------|------------|
| Folder E | Car | Train | Plane |
| Work | Interview | Business trip | Conference |
| Lecture | Class | Reminder | Record |
| Telephone recording | Conversation | Hobby | Lesson |
| Language study | Music | Event | |

TIP

- In addition to navigating through the menu, you can press the **F3** button on the folder list display screen to change the folder names.

Setting the recording monitor [Rec Monitor]

Select whether or not to output audio while recording from the earphone jack (EAR).

[On]:

Enables the recording monitor function. Sound will be output from the EAR jack.

[Off]:

Disables this function. Sound will not be output from the EAR jack.

NOTE

- If the external speaker is connected while recording, there is a risk that audio feedback will occur. It is recommended that you use earphones to monitor recording, or turn [Rec Monitor] to [Off] while recording.

Playback menu [Play Menu]

Skipping non-voice portions during playback [Voice Playback]

The [Voice Playback] function lets you only play the speaking portions of a recorded file of spoken-word content.

NOTE

- The speaking portions of the file must be extracted beforehand (☞ P.79).

[On]:
Automatically skips the non-voice portions of the file and plays only the speaking portions.

[Off]:
The voice playback function is disabled.

NOTE

- The [Voice Playback] function is only enabled in [Recorder] mode.

Reducing noise during playback [Noise Cancel]

Use the [Noise Cancel] function to reduce noise when a recorded voice is difficult to discern.

[High] [Low]:
Reduces surrounding noise to play back clearer sound quality.

[Off]: The noise cancel function is disabled.

NOTE

- The [Noise Cancel] function is only in [Recorder] mode.

Adjusting low volume portions during playback [Voice Balancer]

The [Voice Balancer] function adjusts low-volume portions of recorded audio files to make them louder.

[On]:
Adjusts low-volume portions of audio files during playback, making them louder.

[Off]:
The voice balancer function is disabled.

NOTE

- The [Voice Balancer] function is only enabled in [Recorder] mode.

Selecting playback modes [Play Mode]

Select the playback mode according to your preference.

1 Press the ▲ or ▼ button to select [Playback range] or [Repeat].

[Playback range]:

Specifies the range of file playback.

[Repeat]:

Repeats playback of the set range.

2 Press the ▲ or ▼ button to select the setting.

When [Playback range] was selected:

[File] [Folder] [All]:

Specify the range of file playback.

When [Repeat] was selected:

[On]:

Repeats playback of the playback range.

[Off]:

Cancels repeat playback.

NOTE

- When you set [Playback range] to [File], [End] blinks in the display for 2 seconds after the last file in the folder has been played, then playback stops at the start position of the last file.
- While [Playback range] is set to [Folder], [End] blinks in the display for 2 seconds after the last file in the folder has been played, then playback stops at the start position of the first file in the folder.
- When [Playback range] is set to [All], after the last file in the current folder has been played, the first file in the next folder is being played. When playback reaches the end of the last file in the voice recorder, [End] flashes in the display for 2 seconds, then playback stops at the start position of the first file in the voice recorder.

Playback menu [Play Menu]

Setting a skip space [Skip Space]

This function skips (forward) or reverse skips (rewinds) the file being played back for a set amount of time and it is a convenient way to move the playback position or repeat playing a short phrase.

1 Press the ▲ or ▼ button to select [Forward Skip] or [Reverse Skip].

[Forward Skip]:

Starts playback after moving the playback position forward by the set amount.

[Reverse Skip]:

Rewinds the set amount of time and starts playback.

2 Press the ▲ or ▼ button to select the setting.

When [Forward Skip] was selected:

[File Skip], [10 sec. Skip], [30 sec. Skip],
[1 min. Skip], [5 min. Skip]

When [Reverse Skip] was selected:

[File Skip], [3 sec. Skip], [5 sec. Skip],
[10 sec. Skip], [30 sec. Skip], [1 min.
Skip], [5 min. Skip]

NOTE

- Forward/reverse skip operations over a skip space that contains an index mark/temp mark or the starting position of a file will stop at that mark or at the start position.
- The [Skip Space] function is only enabled in [Recorder] mode.

Forward/reverse skip playback

1 Press the ►OK button to start playback.

2 Press the ►►| or |◀◀ button during playback.

- Playback starts after skipping forward or backward by the set amount.

Playback menu [Play Menu]

Increasing efficiency for voice transcription [Transcription Mode]

Changes the operations assigned to the voice recorder's buttons to operations tailored to transcription.

[On]:

You can change operation of buttons to the setting for transcription.

[Off]:

The operation of buttons becomes normal.

| | |
|------------------|----------------------|
| [STOP (■)] | [Back Space (3 sec)] |
| [▶▶ (CUE)] | [600% Playback] |
| [◀◀ (REV)] | [REW] |
| [▶▶ (SKIP)] | [10 sec. Skip] |
| [◀◀ (SKIP)] | [3 sec. Skip] |
| [Voice Balancer] | [On] |

NOTE

- The [Transcription Mode] function is only enabled in [Recorder] mode.

File menu [File Menu]

5

File menu [File Menu]

Extracting the speaking portions of files of spoken-word content [Voice Detect]

The function extracts the speech portions of a voice file or a file being recorded by the voice recorder.

See “**Extracting the speaking portions of files of spoken-word content [Voice Detect]**” (P.79) for the procedure.

Preventing accidental file erasure [File Lock]

The file lock feature lets you lock important files to prevent them being accidentally erased. Once locked, a file is not erased even if the operation for erasing all the files in its folder is performed (P.46).

1 Select the file you want to lock (P.27).

[On]:

Locks the file.

[Off]:

File lock is canceled.

Sorting files [Sort by]

You can collectively change the playback order of files saved in the voice recorder.

[File name]:

Sorts files automatically by name.

[Date ascending]:

Automatically sorts the files by date (recording date/time) from oldest to newest files.

[Date descending]:

Automatically sorts the files by date (recording date/time) from newest to oldest files.

NOTE

- When [File name] is selected, files are listed in order of file name based on the character code.

Moving/copying files [Move/Copy]

Files saved in the internal memory or on an SD card can be moved or copied within memory.

See “**Moving/copying files [Move/Copy]**” (P.81) for the procedure.

Dividing files [File Divide]

Large files or files with long recording times can be divided for easier management and editing.

See “**Dividing files [File Divide]**” (P.84) for the procedure.

Displaying file or folder information [Property]

You can display the information of a file or folder from a menu screen.

File information

1 Press the ▲ or ▼ button to switch the screen.

- [Name] [Date] [Size] [Bit Rate]^{*1} [Artist]^{*2} [Album]^{*2} are displayed.

*1 When a linear PCM format file is selected, the sampling rate and bit count are displayed in the [Bit Rate] field.

*2 If there is no tag information in the file, [UNKNOWN_ARTIST] and [UNKNOWN_ALBUM] are displayed.

Folder information

1 Press the ▲ or ▼ button to switch the screen.

- [Name] [Folder] and [File] are displayed.
- In [Recorder] mode, [Folder] is not displayed.
- Displayed numbers of files do not include files in formats that are unrecognizable to the voice recorder.

File menu [File Menu]

Erasing the content folder [Erase app data]

Use the smartphone application (☞ P.93) to delete the content folders transferred to the voice recorder.

- 1 Press the ▲ or ▼ button to select the folder you wish to erase.

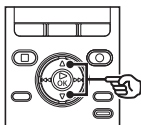

- 2 Press the ▲ or ▼ button to select [Start].

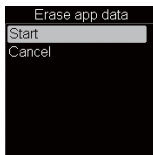
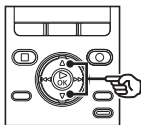

NOTE

- You cannot use the voice recorder to check the files in the content folder.

LCD/Sound menu [LCD/Sound Menu]

Setting the backlight [Backlight]

The display backlights are switched on for a preset amount of time when a button operation is performed.

- 1 Press the ▲ or ▼ button to select [Lighting Time], [Dim light time] or [Brightness].

[Lighting Time]:

Set the time between when the backlight is turned ON and the screen display becomes dim.

[Dim light time]:

Set the time between when the screen becomes dim and the screen is turned OFF.

[Brightness]:

Set the brightness of the backlight.

- 2 Press the ▲ or ▼ button to select the setting.

When [Lighting Time] is selected:

[5 sec.] [10 sec.] [30 sec.] [1 min.]

[Always ON]

When [Dim Light time] is selected:

[30 sec.] [1 min.] [2 min.] [5 min.]

[Always ON]

When [Brightness] is selected:

[01] [02] [03]

Setting the LED indicator light [LED]

You can set the unit so that the LED indicator light does not light.

[On]:

LED indicator light is switched on.

[Off]:

The LED indicator does not light.

Turning beeping sound ON/OFF [Beep]

The voice recorder makes beeping sounds when buttons are pressed, or to warn in case of operation errors. You can select whether the voice recorder makes these beeping sounds.

- Select from [5] to [0].
- As greater the number, the louder the beep sound.

LCD/Sound menu [LCD/Sound Menu]

Changing the display language [Language]

You can select the language used in the voice recorder's displays.

- [English] [Español] [Français].

TIP

- The language selections vary depending on where the voice recorder was purchased.

Setting the voice guidance [Voice Guide]

This feature gives voice announcements of recorder operating conditions.

See "**Setting the voice guidance [Voice Guide]**" (P.86) for the procedure.

Selecting the speaker output [Speaker]

You can set the built-in speaker to be ON or OFF when the earphones are not connected.

[On]:

When the earphone is connected, sound is output from the earphone and when the earphone is disconnected, sound is output from the built-in speaker.

[Off]:

Sound is not output from the built-in speaker even though the earphone is disconnected.

Device menu [Device Menu]

Selecting the recording media [Memory Select]

When there is an SD card in the voice recorder, you can select whether to record on the internal memory or on the SD card (see P.18).

[Internal memory]:
Records to internal memory.

[SD card]:
Records to the SD card.

Setting power save mode [Power Save]

The voice recorder turns OFF automatically when a preset amount of time has elapsed while the voice recorder is in stop mode after power ON.

[5 min.] [10 min.] [30 min.] [1 hr.] [2 hr.] [3 hr.]:

Select the desired amount of time.

[Off]:
Disables power save mode. Note that leaving the voice recorder On will quickly deplete the battery.

Setting the date/time [Time & Date]

Set the date and time beforehand to enable easier management of recorded files.

- 1 Press the ►► or ◀◀ button to select the desired setting item.

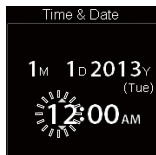
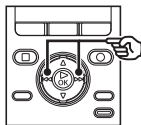

- 2 Press the ▲ or ▼ button to change the number.

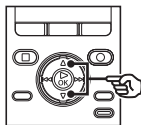

- To change another item, use the ►► or ◀◀ button to move flashing position and use the ▲ or ▼ button to change the number.

- 3 Press the ►OK button to finalize the setting.

TIP

- When setting hours and minutes, each time the **F3** button is pressed, the display changes between 12 hour and 24 hour display.

Example: 10:38 PM

10:38 PM
(default format) ←→ 22:38

- When setting the year, month, and day, each time the **F3** button is pressed, the display order changes.

Example: March 24, 2013

3M 24D 2013Y
(default format)
↓
24D 3M 2013Y
↓
2013Y 3M 24D

NOTE

- Even if the voice recorder is not used for a long period of time, when the battery is used up, the date and time must be re-entered.

Setting the USB connection [USB Settings]

When connecting the voice recorder to a PC, you can use the voice recorder as a USB storage device.

[Storage Class]:

The PC side recognizes the voice recorder as an external storage device.

[Composite]:

When connected to a PC, select to use the voice recorder as an external storage device, USB speaker and microphone.

Restoring the default settings [Reset Settings]

This setting is used to return various functions to the factory default settings (factory default). The clock setting, file numbers, and folder names are retained.

1 Press the ▲ button to select [Start].

Rec Menu:

Rec Scene: Off
Rec Level: Middle
Rec Mode: MP3 128kbps
Zoom Mic: Off
Low Cut Filter: Off
Timer Rec: Off
Folder Name: Initial setting
Rec Monitor: On

Play Menu:

- Voice Playback: Off
- Noise Cancel: Off
- Voice Balancer: Off
- Play Mode:
 - Playback range: File
 - Repeat: Off
- Skip Space:
 - Forward Skip: File Skip
 - Reverse Skip: File Skip
- Transcription Mode: Off

LCD/Sound Menu:

- Backlight:
 - Lighting Time: 10 sec.
 - Dim light time: 30 sec.
 - Brightness: 2
- LED: On
- Beep: 3
- Language: English
- Voice Guide:
 - On/Off: On
 - Speed: 100
 - Volume: 3
- Speaker: On

Device Menu:

- Memory Select: Internal memory
- Power Save: 10 min.
- USB Settings: Storage Class

Formatting a recording media [Format]

Formatting a recording media erases all existing files saved on it. Be sure to transfer all important files to a PC before formatting.

See "**Formatting a recording media [Format]**" (P.88) for the procedure.

Checking recording media information [Memory Info.]

You can display the capacity and remaining memory space of the recording media from a menu screen.

NOTE

- Some recording media memory capacity is used as a management area, so the actual usable capacity will always be slightly less than the displayed capacity.

Confirming the voice recorder information [System Info.]

You can display voice recorder information from a menu screen.

- Displays system information about the voice recorder, such as **[Model]**, **[Version]**, and **[Serial No.]**.

Displaying Wi-Fi setting information [Wi-Fi]

Displays information related to Wi-Fi connections with the voice recorder. You can use the voice recorder as an Wi-Fi access point only.

- 1 Press the **▲** or **▼** button to select **[Wi-Fi connection]** or **[Change password]**.

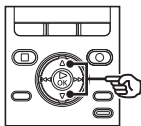

[Wi-Fi connection]:

Displays the SSID (network name) and password required to use a smartphone to connect to the voice recorder over Wi-Fi. At the same time, displays the QR code that is generated by the displayed SSID and password. To use QR codes, you must install a special application beforehand.

[Change password]:

Select to change the password. Each time it is executed, a different password is automatically generated. For security reasons, we recommend that you change the password periodically. Running **[Reset Settings]** (☞ P.72) restores the password back to default.

To check the default password, use the **[Wi-Fi connection]** function after using **[Reset Settings]**.

When [Wi-Fi connection] is selected:



Ⓐ QR code

Ⓑ SSID

Ⓒ Password

- The QR code, SSID and password are displayed on the screen.

When [Change password] is selected:

- 1 Press the ▲ or ▼ button to select [Start].



- 2 Press the ►OK button.
 - When [Password changed] is displayed, the procedure is completed.

Connecting a device to the voice recorder

- 1 Turn ON the Wi-Fi ON/OFF switch of the voice recorder.

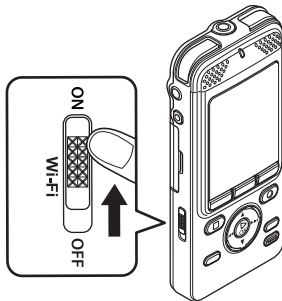

- 2 Operate the voice recorder to display the SSID and password on the screen.

- 3 Change the configuration of the device to be connected.

When configuring a smartphone:

Use the QR* code or SSID and password displayed using the [Wi-Fi connection] function to configure the smartphone. For details, see the instruction manual for your smartphone.

- * To use QR codes, you must install a special application beforehand.

TIP

- A special application is provided for smartphones. If the special application is installed on your smartphone, you can easily use QR codes to configure the phone (☞ P.93).

NOTE

- While the Wi-Fi ON/OFF switch is turned ON, the [Power Save] function is disabled. If the voice recorder is left in this state, battery life will be consumed quickly.
- While the Wi-Fi ON/OFF switch is turned ON, [Change password] is not available. To perform [Change password], turn OFF the Wi-Fi ON/OFF switch.
- When Wi-Fi is connected, battery life is shorter. If the battery runs out during data transfer, the data may be damaged. Therefore, when using a Wi-Fi connection we recommend that you use the AC adapter included with the voice recorder.
- Operation of the Wi-Fi ON/OFF switch is disabled during recording. Perform switch operations while recording is stopped.

Setting timer recording [Timer Rec]

Setting timer recording [Timer Rec]

Recording starts automatically when the set time arrives. Timer recording allows you to record at a set date and time and also record at regular intervals based on a set date and time. You can register up to three preset items.

5

Setting timer recording [Timer Rec]

- Check beforehand that the voice recorder clock matches the current date and time. Use [Time & Date] to match the date and time (P.71).
- Check that there is sufficient battery life.
- Check that there is sufficient memory space.
- Timer recording operates with the content set in the voice recorder. Complete necessary recording settings beforehand, such as [Rec Level].
- The recorded file is automatically saved in [Folder A]. Note that if there are 999 files in [Folder A], timer recording is not performed.
- The timer recording date can be set within one year interval from the current date.
- Timer recording may start a few seconds after the set time arrives.

- 1 While the voice recorder is in stop mode, press the MENU button.
- 2 Press the ▲ or ▼ button to select [Timer Rec].
- 3 Press the ►OK button.

- 4 Press the ▲ or ▼ button to select the desired preset number.
- 5 Press the ►OK button.
- 6 Press the ►▶| or |◀◀ button to select the desired setting item.

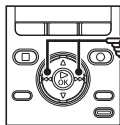

- a Timer recording date:
Set the timer recording date.
- b Start time:
Set the timer recording start time.
- c End time:
Set the timer recording end time.
- d Repeat:
Set the number of times timer recording is repeated.

Setting timer recording [Timer Rec]

Setting timer recording [Timer Rec]

Set the timer recording date:

- 1 Press the ▲ or ▼ button to change the date and time.
- 2 Press the ►► or ◀◀ button to move the cursor.



- 3 Repeat steps 1 and 2 to set the timer recording date.

Set the start and end times:

- 1 Press the ▲ or ▼ button to change the number.
- 2 Press the ►► or ◀◀ button to move the cursor.



- 3 Repeat steps 1 and 2 to set the time.

Set the repeat count:

- 1 Press the ▲ or ▼ button to select [One Time], [Every Week] or [Everyday].



[One Time]: Records at the specified date and time and ends.

[Every Week]: After recording on the specified date and time, repeats recording at the same time each week.

[Everyday]: After recording on the specified date and time, repeats recording at the same time every day.

7 Press the F3 (G0) button to complete the setting.

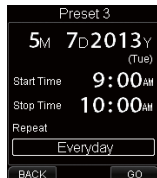
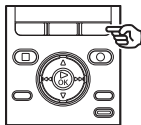

Setting timer recording [Timer Rec]

Setting timer recording [Timer Rec]

Turning preset recording On/Off

- 1 While the voice recorder is in stop mode, press the MENU button.
- 2 Press the ▲ or ▼ button to select [Timer Rec].
- 3 Press the ►OK button.
- 4 Press the ▲ or ▼ button to select the desired preset number.
- 5 Press the F3 (ON/OFF) button.

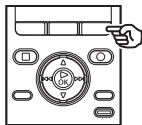

- Each time the **F3 (ON/OFF)** button is pressed, the preset will be switched on or off.

TIP

- Even though the power is Off or on hold, when the specified [Timer Rec] time arrives, recording starts.
- If the [Start Time] settings are the same, [Preset 1] has the highest priority and [Preset 3] has the lowest priority.
- If [Start Time] of [Timer Rec] and [Alarm] (Ⓢ P.52) are set to the same time, [Timer Rec] takes priority.

NOTE

- Check the [Current time] and if it is incorrect, adjust the date and time of the voice recorder (Ⓢ P.71).
- If voice recording is in progress or the unit is in use when the [Timer Rec] start time arrives, [Timer Rec] starts after the operation is finished.
- Because the battery can run out during timer recording and in such a case recording will be suspended, check the remaining battery level.

Extracting the speaking portions of files of spoken-word content [Voice Detect]

Extracting the speaking portions of files of spoken-word content [Voice Detect]

The function extracts the speech portions of a voice file or a file being recorded by the voice recorder.

NOTE

- The [Voice Detect] function can only be used in [Recorder] mode.
- To extract the speech portion from saved files, select a folder from [F1] to [F6] in the [Recorder] folder beforehand.

- 1 While the voice recorder is in stop mode, press the MENU button.
- 2 Press the ►► or ◀◀ button to select the [File Menu] tab.
- 3 Press the ►OK button.

- 4 Press the ▲ or ▼ button to select [File select] or [With recording].

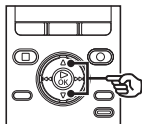

[File select]:

Select a file for which you want to extract the speech portion.

[With recording]:

Extract the speech portion while recording.

- 5 Press the ►OK button to move to the respective setting.

Extracting the speaking portions of files of spoken-word content [Voice Detect]

When [File select] is selected:

- 1 Press the ▲ or ▼ button to select the file from which you wish to extract the speech portion.

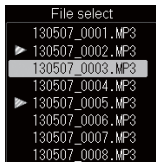

- 2 Press the ►OK button.
 - When [Voice Detection completed] is displayed, the procedure is completed.

When [With recording] is selected:

- 1 Press the ▲ or ▼ button to select [On] or [Off].



[On]:
Extract the speech portion while recording.

[Off]:
Restores standard recording.

- 2 Press the ►OK button.
 - When [Setting fixed] is displayed, the procedure is completed.

TIP

- When extraction of the speech portion is completed, the [Voice Playback] setting in the [Play Menu] is switched to [On] (Ⓧ P.62).

NOTE

- If you select a folder that does not contain any files, [No file] is displayed. You must select a folder containing a file before you can perform the process.
- The speech portion may not be extracted correctly from a file that contains non-spoken word content such as recorded musical performances.
- If the voice volume is faint during recording (level meter is -12 dB or less), or depending on the surrounding noise, it may not be possible to extract the speech portion correctly.
- The time needed for the extraction process will increase in proportion to the size of the recorded file. Before processing, charge the battery to ensure it will not run out before the process is completed.
- The following function is not available when the [With recording] function is used.
 - [Zoom Mic] (Ⓧ P.59)

Moving/copying files [Move/Copy]

Moving/copying files [Move/Copy]

Files saved in the internal memory or on an SD card can be moved or copied within memory.

- 1 Before performing the move/copy operation, first select the folder containing the file you want to move or copy (P.27).**
- 2 While the voice recorder is in stop mode, press the MENU button.**
- 3 Press the ►►► or ◀◀◀ button to select the [File Menu] tab.**
- 4 Press the ▲ or ▼ button to select [Move/Copy].**
- 5 Press the ►OK button.**

- 6 Press the ▲ or ▼ button to select the file move or copy method.**

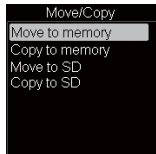
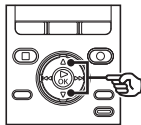

[Move to memory]:

Move a file from the internal memory or SD card to another folder within the internal memory.

[Copy to memory]:

Copy a file from the internal memory or SD card to another folder within the internal memory.

[Move to SD]:

Move a file from the internal memory or SD card to another folder within the SD card.

[Copy to SD]:

Copy a file from the internal memory or SD card to another folder within the SD card.

- 7 Press the ►OK button.**

Moving/copying files [Move/Copy]

- 8** Press the ▲ or ▼ button to select the number of files to move or copy.

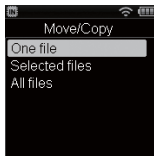
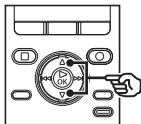

[One file]:

Selects only the specified file.

[Selected files]:

Lets you select multiple files.

[All files]:

Selects all the files in the folder.

- 9** Press the ►OK button to move to the respective setting.

When [One file] is selected:

- ① Press the ▲ or ▼ button to select a file to move or copy and then press the ►OK button.

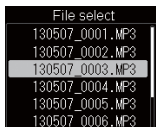

When [Selected files] is selected:

- ① Press the ▲ or ▼ button to select the files to move or copy and then press the ►OK button.

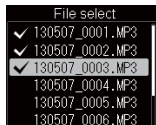

TIP

- You can deselect a previously selected file by selecting it and pressing the ►OK button.

- ② When repeating step ① to select files to move or copy, press the **F3 (GO)** button.

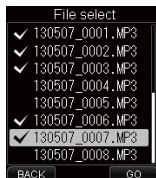

When [All files] is selected:

All the files in the current folder are selected automatically, and the display switches to the **[Destination]** screen.

Moving/copying files [Move/Copy]

Moving/copying files [Move/Copy]

- 10** Press the ▲, ▼, ►► or ◀◀ button to select the destination folder for files to be moved or copied.

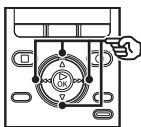

- Files cannot be moved or copied directly within the **[Recorder]** folder. Select a folder from **[A]** to **[E]** folder in the **[Recorder]** folder.

- 11** Press the **F3 (GO)** button.

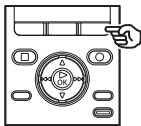

- [File move completed]** or **[File copy completed]** appears when the process has finished.

TIP

- Locked files (P.66) remain locked after being moved or copied.

NOTE

- Files cannot be copied if there is insufficient remaining memory.
- Files cannot be moved or copied if there are over 999 files.
- To prevent the risk of data damage, never remove the battery while moving or copying a file.
- Files cannot be moved or copied within the same folder.
- When a file moving or copying process is canceled before completion, the files that completed the process will have been moved or copied, and process is canceled for the other files.
- Files with DRM cannot be moved or copied.

Dividing files [File Divide]

Dividing files [File Divide]

Large files or files with long recording times can be divided for easier management and editing.

NOTE

Only MP3-format and PCM-format files recorded on the voice recorder can be divided.

- 1 Play the file to divide, and stop playback at the desired division point.**
 - Press and hold the **▶▶** or **◀◀** button to fast-forward/rewind.
 - Writing an index mark/temp mark at the division point beforehand is handy.
- 2 While the voice recorder is in stop mode, press the MENU button.**
- 3 Press the **▶▶** or **◀◀** button to select the [File Menu] tab.**
- 4 Press the **▲** or **▼** button to select [File Divide].**
- 5 Press the **▶** OK button.**

- 6 Press the **▲** button to select [Start].**

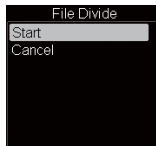
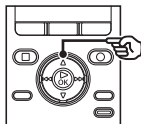

- 7 Press the **▶** OK button.**

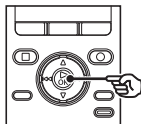

- **[Dividing!]** appears in the display, and the file dividing process starts.
[File divide completed] appears when the process has finished.

Dividing files [File Divide]

Dividing files [File Divide]

TIP

- The file names after division become “**File name_1**” for the first half and “**File name_2**” for the latter half.

NOTE

- [File Divide] can be performed only when the file list is displayed.
- The recorder cannot divide files when the number of files in the folder exceeds 999.
- Locked files (Ⓜ P.66) cannot be divided.
- It may not be possible to divide some MP3 or PCM files with extremely short recording times.
- To prevent the risk of data damage, never attempt to remove the battery during dividing a file.

Setting the voice guidance [Voice Guide]

Setting the voice guidance [Voice Guide]

This feature gives voice announcements of recorder operating conditions. You can set voice announcement On/Off, speed and volume.

- 1** While the voice recorder is in stop mode, press the **MENU** button.
- 2** Press the **▶▶|** or **|◀◀** button to select the **[LCD/Sound Menu]** tab.
- 3** Press the **▲** or **▼** button to select **[Voice Guide]**.
- 4** Press the **▶OK** button.
- 5** Press the **▲** or **▼** button to select **[On/Off]**, **[Speed]** and **[Volume]**.

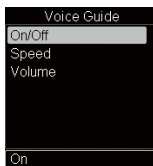
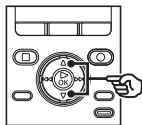

[On/Off]:
Switches voice guidance On/Off.

[Speed]:
Sets the voice guidance speed.

[Volume]:
Sets the voice guidance volume.

- 6** Press the **▶OK** button to move to the respective setting.

When **[On/Off]** is selected:

- ① Press the **▲** or **▼** button to select **[On]** or **[Off]**.

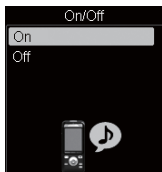

[On]: Voice guidance will be enabled.

[Off]: Guidance will be canceled.

- ② Press the **▶OK** button to finalize the setting.

Setting the voice guidance [Voice Guide]

Setting the voice guidance [Voice Guide]

When [Speed] is selected:

- 1 Press the ▲ or ▼ button to select the voice speed.

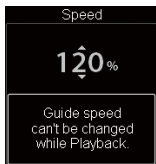

[50%] to [200%] in 10-step increments.

[200%] to [400%] in 20-step increments.

- The greater the number, the faster the speed. Normal playback is performed at 100%.
- 2 Press the ►OK button to finalize the setting.

When [Volume] is selected:

- 1 Press the ▲ or ▼ button to select the voice volume.

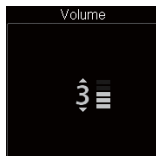

- Select from [5] to [0].
 - As greater the number, the louder the beep sound.
- 2 Press the ►OK button to finalize the setting.

NOTE

- The starting tune/closing tune when the power is turned On/Off (P.15, P.22) can be canceled if you set [Voice Guide] to [Off].
- The volume of the startup sound/ending sound is controlled by the [Volume] setting of [Voice Guide].
- During playback of a file, the [Speed] setting of [Voice Guide] is disabled.

Formatting a recording media [Format]

Formatting a recording media [Format]

Formatting a recording media erases all existing files saved on it. Be sure to transfer all important files to a PC before formatting.

1 While the voice recorder is in stop mode, press the **MENU** button.

2 Press the **▶▶** or **◀◀** button to select the **[Device Menu]** tab.

3 Press the **▲** or **▼** button to select **[Format]**.

4 Press the **▶OK** button.

5 Press the **▲** or **▼** button to select the recording media to be formatted.

6 Press the **▶OK** button.

7 Press the **▲** button to select **[Start]**.

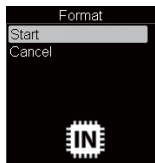
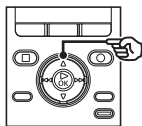

8 Press the **▶OK** button.

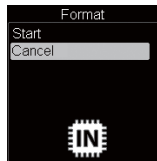
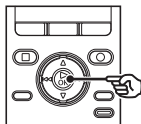

9 Press the **▲** button again to select **[Start]**.

10 Press the **▶OK** button.

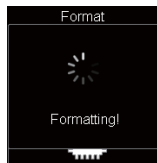
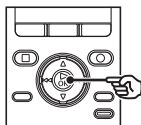

- **[Formatting!]** is displayed when formatting starts.
- When **[Format done]** is displayed, formatting is completed.

TIP

- Perform **[Reset Settings]** to return various functions to the factory default (P.72).

Formatting a recording media [Format]

NOTE

- Never format the voice recorder from a PC.
 - Formatting erases all the existing data, including locked files and read-only files.
 - When the SD card is set to write-protected, [**SD Card Protected**] is displayed. To perform formatting, cancel SD card write protection (☞ P.19).
 - When an SD card is inserted in the recorder, be sure to confirm which recording media is to be formatted, [**Internal memory**] or [**SD card**], so there is no mistake (☞ P.71).
 - Before formatting, charge or replace the battery to ensure it will not run out before the process is finished. The formatting process can sometimes take over 10 seconds to complete. To prevent the risk of damage to data, never attempt to perform any of the following processes before a formatting process has finished: Doing so may damage the data.
 - ① Disconnecting the USB-connection AC adapter.
 - ② Removing the battery.
 - ③ Removing the SD card (if the recording media has been set to [**SD card**]).
- Even when formatting or erasing (☞ P.46) is performed, only the file management information of the internal memory and/or SD card is updated and the recorded data is not completely erased. When disposing of an SD card, be sure to destroy the card, format the card and record silence until the recording time runs out, or perform a similar operation in order to prevent the leakage of personal information.

Wi-Fi Function

Before using the Wi-Fi function

The voice recorder is equipped with a Wi-Fi function. Wi-Fi devices are certified by an organization known as Wi-Fi Alliance that certifies that wireless LAN devices can be mutually connected. In this manual, the wireless LAN functions are described collectively as “Wi-Fi”. Smartphones can be connected to the voice recorder using radio signals. Because of wireless, as long as the radio signal can reach the unit, flexible connection is possible. Radio signals extend a certain range and can penetrate obstacles (wood, glass, etc.), thus even if the voice recorder is placed another room, connection is possible. Using a special application for smartphones, you can play back files recorded by the voice recorder. Also, the voice recorder can be operated from a distance, as long as it is within the reach of the radio signal. For details, see our website.

What can you do with the Wi-Fi function?

- Use your smartphone to operate the voice recorder.
- Create content files in which voice and images are synchronized.

To perform the above functions, you need to install the special application for smartphones beforehand (☞P.93).

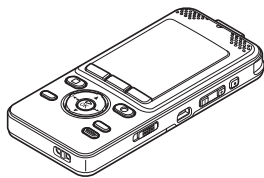

Recorder

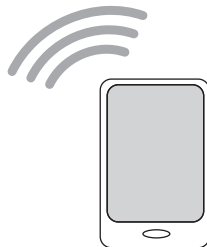

Smartphone

Before using the Wi-Fi function

NOTE

- The Wi-Fi function of the voice recorder is designed to be used in the following regions.

America:

United states, Canada

Do not use the Wi-Fi function of the voice recorder in regions than the above. Using the function could violate the radio signal restrictions in that country. We will assume no responsibility whatsoever for the use of this technology.

- Communication may be affected if there is reinforced structures, metal or concrete between the voice recorder and the Wi-Fi access point.
- Do not use the Wi-Fi function of the voice recorder in a hospital and airplane where its use is prohibited.
- Near a microwave, cordless telephone set, or device that uses the 2.4GHz frequency band, if the voice recorder is used at the same time with such a device, communication performance may be affected. When using the voice recorder, keep a sufficient distance away from such devices.
- If multiple Wi-Fi access points nearby use the same channel, the voice recorder may not be detected correctly.
- To the extent possible, try not to use the voice recorder near mobile phones, televisions, or radios.
Mobile phones, PHS, TV sets, and radios use different frequencies than the voice recorder but electromagnetic waves generated from Wi-Fi products including this voice recorder could generate noise in audio or video images.
- When using the Wi-Fi function, battery life is consumed quickly. If the battery runs out during data transfer, the data may be damaged. Therefore, when using a Wi-Fi connection we recommend that you use the AC adapter included with the voice recorder.

Before using the Wi-Fi function

Notes on security when using Wi-Fi products

- With a Wi-Fi connection, information is exchanged wirelessly between a smartphone and the voice recorder and as long as radio signals reach the unit, flexible connection is possible. However, because radio signals can penetrate through obstacles (wood, glass, etc.), if there is no security-related setting, the following problems could occur.
 - A malicious third party intentionally intercepts radio signals to spy on communication content.
 - Unauthorized intrusion causes the leaking of personal information.
 - Intercepted communication contents are rewritten and transmitted.
 - Destructive computer viruses are released that can destroy data or systems.

For security protection, we recommend the password be changed periodically using the **[Wi-Fi]** function of the voice recorder (☎ P.74).

- Should a problem occur for an inevitable reason due to the specifications of the Wi-Fi connection, we assume no responsibility whatsoever for any damage incurred.

6

Before using the Wi-Fi function

TIP

SSID (Service Set Identifier): SSID is the ID (network name) required for Wi-Fi connection.

Access point (Wireless LAN access point): A device that receives radio signals to connect client to the network over a wireless LAN. Or, the name used when a device is used as only a radio transmitting function.

Before using the Wi-Fi function

About OLYMPUS Audio Controller



The OLYMPUS Audio Controller application for smartphones is required to use your smartphone to operate the voice recorder from a distance.

How to obtain the application

Supported OS (as of November 2013)

- For Android™: Android 2.3.3 to 4.2
- For iOS: iOS 5.0 to iOS 6.0

Use the following method to obtain the application.

1 Connect your smartphone to the network.

2 Search for the application.

For Android™:

Using “**Google Play™ (formerly called Android Market™)**”, search for “**OLYMPUS Audio Controller**”.

For iOS™:

Using “**App Store SM**”, search for “**OLYMPUS Audio Controller**”.

3 Select “**OLYMPUS Audio Controller**” and download and install.

- An icon  is added to the smartphone apps menu.

What the application can do

Installing the application on your smartphone allows you to:

You can use the QR code to configure the SSID and password:

Use [Wi-Fi] of the voice recorder to display the QR code (P.74). If you use OLYMPUS Audio Controller installed in a smartphone to read the QR code, the SSID and password will be entered automatically.

Use your smartphone to operate the voice recorder:

Use the Wi-Fi function to operate the voice recorder (recording, playback) from a distance.

Create content files in which voice and images are synchronized:

You can create content files that automatically display captured images according to the elapsed time of the voice file.

Before using the Wi-Fi function

TIP

- The created content file is transferred to the voice recorder in one folder for each file.
- The created content file can only be played back using smartphone application.
- You can operate the voice recorder to delete unnecessary content folders (P.68).

NOTE

- For details about the application, see our webpage.
- When you download the application using a mobile phone line such as 3G, depending on your particular contract, you may incur packet communication fees.

Use with a PC

Connecting the voice recorder to a PC lets you:

- You can use Olympus Sonority to transfer voice files recorded by the voice recorder and play them back or manage them on PC. The optional Olympus Sonority Plus upgrade and optional Music Editing Plugin provide a variety of functions (☞ P.106).
- Using the voice recorder, you can enjoy language content or music files in WMA, MP3 and WAV format stored on your PC.
- The voice recorder can be used as external storage to save or load data to/from your PC (☞ P.109).

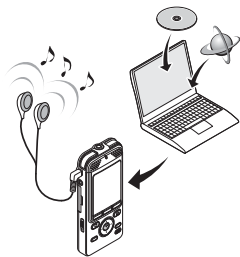

PC operating environment

Windows

OS (Operating system):

Microsoft® Windows® XP Service Pack 2 3
Microsoft® Windows® XP Professional x64
Edition Service Pack 2
Microsoft® Windows Vista®, Service Pack 1,
2 (32-bit/64-bit)
Microsoft® Windows® 7 (32-bit/64-bit)
Microsoft® Windows® 8 (32-bit/64-bit)

CPU: 1 GHz or more 32bit (x86) or 64bit (x64)
processor

RAM capacity: 512MB or more

Hard disk space:

Olympus Sonority installation: 300MB or
more

Drive: CD-ROM or CD-R, CD-RW, DVD-ROM
drive

Browser:

Microsoft Internet Explorer 6.0 or later

Display: 1024 x 768 dots, 65,536 colors
or more (16,770,000 colors or more
recommended)

USB port: One or more available

Other:

- Audio device
- An environment with Internet access
- Even when the requirements for the operating environment are satisfied, updated versions, multiboot environments, self-modified PCs and other compatible machines will not be covered under the operational warranty.

PC operating environment

Macintosh

OS (Operating system):

MacOS-X 10.5 -10.9

CPU: PowerPC® G5 or Intel multi-core processor 1.5GHz or higher

RAM capacity: 512MB or more

Hard disk space:

Olympus Sonority installation: 300MB or more

Drive: CD-ROM or CD-R, CD-RW, DVD-ROM drive

Browser: Safari 2.0 or later

Display: 1024 x 768 dots, 32000 colors or more (16,770,000 colors or more recommended)

USB: One or more ports available

Other:

- Audio device
- Quick Time 7.2 or later with Internet access recommended

NOTE

- Some Olympus Sonority functions require Quick Time 7.2 or higher. You can obtain the latest Quick Time version from Apple Software Update.

7

PC connection precautions

- When uploading or downloading a file to or from the voice recorder, data transfer will continue as long as the voice recorder's LED indicator light is flashing, even if the PC data communication screen disappears. Never disconnect the USB connector before data communication has finished. Always use the procedure on P.98 to disconnect the USB connector. Data may not be transferred correctly if you disconnect the connector before the drive has stopped.
- Do not format (initialize) the voice recorder's drive from a PC. Formatting done from a PC will not be done correctly. To perform formatting, use the **[Format]** menu of the voice recorder (P.88).
- Voice recorder folders or files that are moved or renamed in a Windows or Macintosh file management screen may be reordered or become unrecognizable.
- Note that it will still be possible to read and write data on the voice recorder after setting the attribute of the voice recorder's drive to 'Read only' on a PC.
- To prevent nearby electronic devices being affected by noise, disconnect the external microphone and earphones when connecting the voice recorder to a PC.

PC connection/disconnection

Connecting the voice recorder to a PC

- 1 Start the PC.
- 2 Connect the USB connection cable to the USB port on the PC.

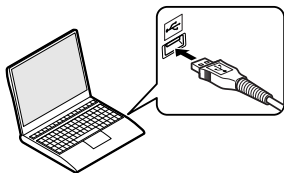

- 3 Check that the voice recorder is in stop mode, then connect the USB connection cable.

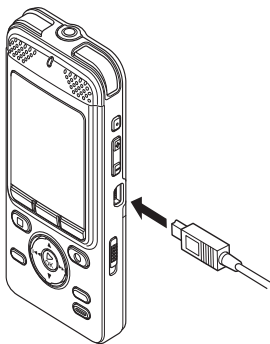

- 4 Press the **▲** or **▼** button to select **[PC]**.

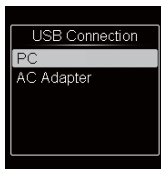
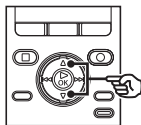

- 5 Press the **▶OK** button.

- While connected to USB, **[Remote]** is displayed on the voice recorder.
- The recorder does not establish a connection with a PC if **[AC Adapter]** is selected in the USB connection setting. Set the USB connection setting to **[PC]**.

TIP

- Windows: The voice recorder is recognized and displayed in the **[My Computer]** folder with the model name as the drive name. If there is an SD card in the voice recorder, it can be used as the **[Removable Disk]**.
- Macintosh: The voice recorder is recognized and displayed on the desktop with the model name as the drive name. If an SD card is inserted, **[Untitled]** is displayed.
- For information on the PC's USB port, see the PC's user manual.

Connecting the voice recorder to a PC

NOTE

- The voice recorder must not be in HOLD mode.
- Insert the USB connector securely all the way. Operation will not be normal if the connection is not made properly.
- Connecting the voice recorder through a USB hub may result in unstable operation. Do not use a USB hub if operation is unstable.
- Use only a compatible Olympus USB extension cable. Operation is not guaranteed if another manufacturer's cable is used. Also, never use this dedicated cable with any other company's products.

Disconnecting the voice recorder from a PC

Windows

- 1 Click [] on the task bar in the lower right hand corner of the screen and click [Safely remove USB Mass Storage Device].**



- The letter used to identify the drive will vary according to your PC.
 - When the window indicating it is safe to remove hardware appears, close the window.
- 2 Check that the LED indicator light of the voice recorder is OFF and then disconnect the USB cable.**

Disconnecting the voice recorder from a PC

Macintosh

- 1 Drag-and-drop the removable disk icon for the voice recorder shown on the desktop to the trash can icon.**

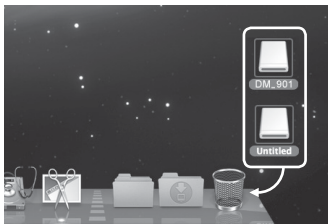

- 2 Check that the LED indicator light of the voice recorder is OFF and then disconnect the USB cable.**

NOTE

- To prevent the risk of data damage, never disconnect the voice recorder from the USB port while the LED indicator light is flashing.

Functions available in Olympus Sonority

Olympus Sonority provides various functions that can be used to manage and edit files. For information on operating procedures and detailed settings, please refer to the respective items on online help (P.105).

Waveform editing function

Using the Waveform Editing Function Tab, you can easily process the voice data. In the Waveform Editing Mode, you can also delete unnecessary parts, paste and re-save the data.

One-touch effect function

Using the One-touch Effect Function, you can easily apply special effects to the voice file and carry out noise reduction in any specified area.

Sending files by email

Voice files are stored in the [Message] folder on the hard disk. You can send voice files as attachments to email.

Changing a folder name

You can change a folder name. Up to 62 characters can be entered but the single byte characters of `¥/!*?<>` cannot be used.

If folder names are changed in OS of some other language than the languages supported by the voice recorder, the folder name may become garbled.

Editing file comments

You can use Olympus Sonority to add comments to files downloaded from the voice recorder. A maximum of 50 double-byte characters (100 single-byte characters) can be entered.

Changing a file format to another format*

The current saved file format can be changed to other formats.

Functions available in Olympus Sonority

Combining files

You can specify multiple voice files and combine them into one file.

Dividing a file

You can divide a specified voice file into two files.

Using Olympus Sonority to load content

You can load podcast content obtained from the Internet on your PC.

* To write files in MP3 format, you need to upgrade to Olympus Sonority Plus (P.106).

Installing software

Before you connect the recorder to your PC and use it, you must first install the “Olympus Sonority” software from the included Software CD.

Be sure to confirm the following before installation:

- Exit all running applications.
- You need to log on as Administrator.

Windows

1 Insert “Olympus Sonority” into the CD-ROM drive.

- The installation program will start automatically. Once the program starts, go to step 4. If it does not, follow the procedures in steps 2 and 3.

2 Open the contents of the CD-ROM with [Explorer].

3 Double-click [Setup] in the root of the CD-ROM.

- The “Olympus Sonority” launch screen is displayed.



4 Click on the language you want to install.

5 Click [Olympus Sonority Setup].

- The Installer will open. Follow the Installer Wizard instructions.

6 Accept the terms of the Licensing Agreement.

- You must accept the terms of the Licensing Agreement to install “Olympus Sonority”. After checking the [Agree] box, click [Next].

7 Register the User Registration Information.

- Please enter your name, company name and the serial number listed on the separate sheet. Click [Next] after entering.

8 Select the software setup type.

- The installation destination can be changed. Click [Next] if you do not want to change it (Select [Custom] if you want to change).

9 Click [Install] to start the installation.

- Do not carry out other operations before the installation is completed and the [Complete] screen is displayed.
- When the installation is completed, the [Install Shield] screen will be displayed.
- To connect the recorder to a PC, See “Connecting the voice recorder to a PC” (E3 P.97) for the procedure.

Macintosh

- 1 Insert “Olympus Sonority” into the CD-ROM drive.**
 - Proceed to step 3 if the content of CD-ROM is displayed, or go to step 2 if nothing is displayed.
- 2 Open the contents of the CD-ROM with [Finder].**
- 3 Double-click [Setup] in the root of the CD-ROM.**
 - The “Olympus Sonority” launch screen is displayed.
- 4 Click on the language you want to install.**
- 5 Click [Olympus Sonority Setup].**
 - The Installer will open. Follow the Installer Wizard instructions.
- 6 Accept the terms of the Licensing Agreement.**
 - You must accept the terms of the Licensing Agreement to install “Olympus Sonority”. After checking the [Agree] box, click [Next].
- 7 Set the Installation destination.**
 - Click [Next] if you do not want to change it (Select [Change Installation Destination] if you want to change).

8 Click [Install] to start the installation.

- Do not carry out other operations before the installation is completed and the [Complete] screen is displayed.
- When the installation is completed, the [Installer] screen will be displayed.
- To connect the recorder to a PC, See “Connecting the voice recorder to a PC” (P.97) for the procedure.
- After starting up the “Olympus Sonority”, the serial number entry dialog box will appear. Enter the serial number listed on the separate sheet.

Uninstalling software

To uninstall any of the software component of the “Olympus Sonority” software installed on your PC, follow the steps below.

Windows

- 1 Exit “Olympus Sonority”.**
- 2 Select [Start] from the [Control Panel] menu.**
- 3 Click [Add/Remove programs].**
 - The list of installed applications is displayed.
- 4 Click [Olympus Sonority].**
- 5 Click [Change/Remove].**
- 6 Click [OK] to start uninstalling.**
 - An additional message may appear, if so, read it carefully and follow the instructions given.
 - When the uninstallation is completed, [Maintenance Complete] screen is displayed.
- 7 Click [Finish] to complete uninstalling.**

Macintosh

- 1 Exit “Olympus Sonority”.**
- 2 Open [Finder].**
- 3 Double-click the [SonorityUninstaller.pkg] in the application folder.**
 - The Uninstaller will open. Follow the wizard instructions.
 - When the administrator password is asked, enter the password then click [OK].
 - When the uninstallation is completed, [Successful] screen is displayed.
- 4 Click [Close].**

Files left after uninstallation

The voice files you made are stored in the [MESSAGE] folder. If you don't need them, delete them.

You can confirm the location of the [MESSAGE] folder by clicking [Options] in the [Tools] menu before uninstalling.

Using online help

To open Online Help, you have the following options.

- With Olympus Sonority running, from the [Help] menu, select [Olympus Sonority Help].

Search by Contents

- 1 Display the online help and click the table of contents tab.**
- 2 Double-click the [] of the item you wish to search for.**
 - An explanation of the topic is displayed.
- 3 Double-click the [] of the item you wish to search for.**
 - An explanation of the topic is displayed.

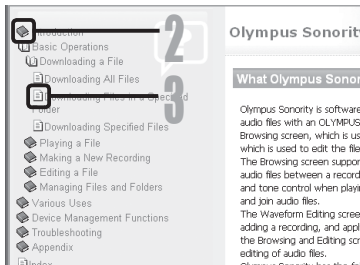

Search by Keyword

- 1 Display the online help and click the [Index] item.**
 - Matching keywords are located automatically.
- 2 Click a keyword.**
 - An explanation of the topic is displayed.

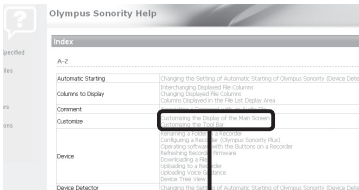
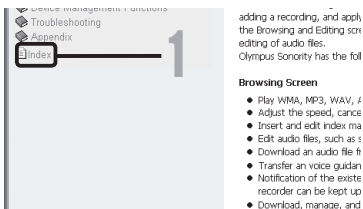

NOTE

- This document explains basic operation of Olympus Sonority. For more information on menus and operations, refer to Online Help. Online help becomes available after installing Olympus Sonority.

Upgrade function

By upgrading Olympus Sonority to the optional Plus version, you can use more advanced functions. Also, with Olympus Sonority Plus, if you purchase the Music Editing Plug-in you can enjoy advanced effects editing. To add the Music Editing Plug-in, you need to upgrade to Olympus Sonority Plus.

Purchase and upgrade

Use the following procedure to upgrade Olympus Sonority by purchasing Olympus Sonority Plus.

1 Start Olympus Sonority.

2 From the [Help] menu, select [Purchase Olympus Sonority Plus] or click the button on the Tool Bar.

- The web browser will start and the purchase site of the “Olympus Sonority Plus” will be displayed. Please operate according to guidance on the screen. When the purchase procedure is completed, the Upgrade Key will be issued by mail.

3 From the [Help] menu, select [Upgrade to Olympus Sonority Plus].

- The [Upgrade to Olympus Sonority Plus] dialog will be displayed.

4 Register the upgrade key.

- When starting the application next time, “Olympus Sonority” will be upgraded to “Olympus Sonority Plus”.

Confirming your upgrade to Olympus Sonority Plus

Click the root of the Main Treeview, [Olympus Sonority], in the Browse Screen to display the Information Screen. You can confirm that the upgrade key is registered. Or, from the [Help] menu, if you select Version Information, the registered Olympus Sonority Plus upgrade key is displayed. The Music Editing Plug-in includes more than 20 types of effect functions and spectrum analyzer functions. For details, please refer to the Online Help (P.105).

NOTE

- To purchase the Upgrade Key, it requires an environment where the Internet can be utilized. If the upgrade key cannot be used, contact the Olympus Customer Support Center.
- For details about how to purchase an upgrade key, see Olympus Sonority Online Help (P.105).

Upgrade function

Functions available in Olympus Sonority Plus

In addition to the functions available with Olympus Sonority, Olympus Sonority Plus provides various editing functions for music files. For information on operating procedures and detailed settings, please refer to the respective items on the Online Help (P.105).

Editing MP3

Edit and write MP3 files and tags.

Create music CDs

Create music CDs using voice files registered in the CD write folder.

Functions available with the music editing plug-in

If you purchase the Music Editing Plug-in for Olympus Sonority Plus, you can add advanced functionality that widens the range of music editing capabilities available. For detailed purchasing method and operating procedures, please refer to the Online Help (P.105).

Effect functions

You can edit music files using more than 20 advanced effect functions.

Spectrum analyzer

Displays in the Waveform Display Screen the waveform distribution of an voice file being played in the real time.

Besides unrestricted track editing

It also removes the restriction on the number of tracks that can be edited.

Loading a file to a PC

The five folders for voice recording are displayed as **[FOLDER_A]**, **[FOLDER_B]**, **[FOLDER_C]**, **[FOLDER_D]**, **[FOLDER_E]** respectively on the PC and contain recorded voice files. You can copy voice recorder files to any folder on the PC.

■ Voice recorder drive name and folder names on the PC

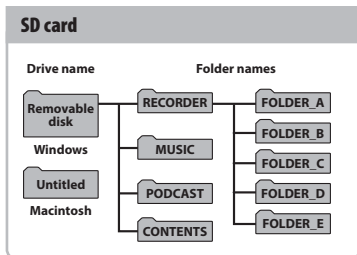
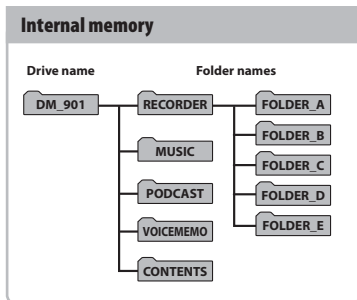

- With this voice recorder, content in the **[CONTENTS]** folder cannot be checked.
- If you delete or change files in the **[VOICEMEMO]** folder or **[CONTENTS]** folder, the voice recorder may not operate correctly.

NOTE

- To prevent the risk of data damage, never disconnect the voice recorder from the USB port while the LED indicator light is flashing.
- WMA-format files cannot be played in the standard Macintosh operating system.

Usage as external memory of the PC

Connecting the voice recorder to a PC lets you transfer voice recorder data to save in the PC, and vice-versa.

Windows

- 1 **Connect the voice recorder to the PC** (P.97).
- 2 **Open Windows Explorer.**
 - When you open **[My Computer]**, the voice recorder is recognized by the drive letter that includes the product name.
- 3 **Click on the folder labeled with your voice recorder's model name.**
- 4 **Copy the desired data to the PC.**
- 5 **Disconnect the voice recorder from the PC** (P.98).

Macintosh

- 1 **Connect the voice recorder to the PC** (P.97).
 - When connected to a Mac OS, the voice recorder is recognized on the desktop by the drive letter that includes the product name.
- 2 **Double-click the removable disk icon labeled with your voice recorder's model name.**
- 3 **Copy the desired data to the PC.**
- 4 **Disconnect the voice recorder from the PC** (P.99).

NOTE

- During data communication, **[Busy]** appears in the voice recorder's display and the LED indicator light flashes. To prevent the risk of data damage, never disconnect the voice recorder from the USB port while the LED indicator light is flashing.

Other information

Alarm message list

| Message | Meaning | Action required |
|-------------------------------------|---|---|
| Battery low | The remaining battery power is low. | Charge the battery (P.12, P.16). If the battery runs out soon even though it was charged, the battery may be expired. Replace it with a new one (P.11). |
| File locked | An attempt was made to erase a locked file. | You must unlock the file before you can erase it (P.66). |
| Cannot record in this folder | An attempt was made to record when not in [Recorder] mode. | Before recording, select [Recorder] mode and one of the folders from [Folder A] to [Folder E] (P.23, P.27). |
| No more can be set | The maximum number of index marks (99) have been written in the file. | Erase unneeded index marks (P.44). |
| | The maximum number of temp marks (99) have been written in the file. | Erase unneeded temp marks (P.44). |
| Folder full | The maximum number of files (999) have been saved in the folder. | Erase unneeded files (P.46). |
| Memory error | An internal memory error occurred. | Contact the Olympus Customer Support Center (back cover). |
| Card error | The SD card was not recognized correctly. | Remove and insert the SD card again (P.18, P.19). |
| Illegally copied file | The music file was copied illegally. | Erase the music file (P.46). |
| Memory full | There is no remaining memory. | Erase unneeded files (P.46). |
| SD Card Protected | The SD card is write protected. | Cancel SD card write protection and then attempt to use again (P.19). |
| No file | There are no files in the folder. | Select another folder (P.25, P.27). |

Alarm message list

| Message | Meaning | Action required |
|---|---|---|
| Format error | A formatting problem occurred. | Format the memory again (☞ P.88). |
| Can't create the system file. Connect to PC and erase unnecessary file | The voice recorder is unable to create a management file due to low remaining memory. | Connect the voice recorder to a PC and erase unneeded files. |
| Cannot play this file | The file's format is not supported. | Select a file that can be played by the voice recorder (☞ P.39). |
| Select a file | No file has been selected. | You must select a file before you can perform the operation (☞ P.25, P.27). |
| Same folder can't be moved (copied) | An attempt was made to move (copy) a file to the same folder. | Select another folder. |
| Some files can't be moved (copied) | A file with the same name as a file being moved (copied) exists in the destination folder. | Select another file. |
| This file can't be divided. | An attempt was made to divide a file that is not an MP3- or WAV-format file recorded by the voice recorder. | Select another file. |

Troubleshooting

| Problem | Possible cause | Solution |
|---|---|---|
| The display is blank. | The battery is not inserted properly. | Check the orientation of the battery (☞ P.11). |
| | The remaining battery power is low. | Charge the battery (☞ P.12, P.16). |
| | The power is OFF. | Turn the power ON (☞ P.15). |
| Unable to operate the voice recorder | The remaining battery power is low. | Charge the battery (☞ P.12, P.16). |
| | The power is OFF. | Turn the power ON (☞ P.15). |
| | The voice recorder is in HOLD mode. | Release HOLD mode (☞ P.21). |
| Unable to record | There is no remaining memory. | Erase unneeded files (☞ P.46). |
| | The maximum number of recordable files has been reached. | Select another folder (☞ P.25, P.27). |
| Playback is inaudible. | The earphones are connected to the EAR jack. | To output the playback through the built-in speaker, disconnect the earphones. |
| | [Off] has been selected for [Speaker]. | To output the playback through the built-in speaker, select [On] for [Speaker] (☞ P.70). |
| | The volume is set to [00]. | Adjust the volume (☞ P.36). |
| The recording is too quiet. | The recording level hasn't been adjusted. | Redo recording after adjusting the recording level (☞ P.58). |
| | A low recording level has been set. | Redo recording after setting the recording level to [High] or [Middle] (☞ P.58). |
| | The output level of the connected external device may be too low. | Adjust the output level of the external device. |
| Audio file sound is distorted. | The recording level hasn't been adjusted. | Redo recording after adjusting the recording level (☞ P.58). |
| | The voice recorder's recording level, or the output level of the connected external device may be too high. | If the problem continues after adjusting the voice recorder's recording level (☞ P.58), adjust the output level of the external device. |

Troubleshooting

| Problem | Possible cause | Solution |
|---|--|--|
| An audio file is not recorded in stereo. | The connected external microphone is a mono microphone. | Sound recorded by a connected external mono microphone is recorded on the left channel only. |
| | [Rec Mode] is set to a mono recording format. | Set [Rec Mode] to a stereo recording format (☞ P.59). |
| | A positive (+) value has been selected for [Zoom Mic] . | Select [Off] for [Zoom Mic] (☞ P.59). |
| Missing audio file | The file was recorded in a different folder. | Select another folder (☞ P.25, P.27). |
| Noise during playback | Objects brushed against the voice recorder while recording. | _____ |
| | The voice recorder was placed near a mobile phone or fluorescent light during recording or playback. | Redo the operation with the voice recorder in a different location. |
| Non-voice portions are not skipped during playback. | The [Voice Detect] process has not been performed. | Use the [Voice Detect] function to extract the speech portions (☞ P.79). |
| | [Off] has been selected for [Voice Playback]. | Select [On] for [Voice Playback] (☞ P.62). |
| Unable to erase a file | The file is locked. | You must unlock the file before you can erase it (☞ P.66). |
| | The file is a read-only file. | Unlock the file, or undo the read-only setting on a PC. |
| Unable to erase a folder | The folder contains a file that the voice recorder cannot recognize. | Connect the voice recorder to a PC to erase the folder (☞ P.97). |
| Noise when monitoring a recording | Feedback is being caused. | Connecting a speaker with a built-in amplifier may cause feedback during recording. It is recommended that you use earphones to monitor recording, or set [Rec Monitor] to [Off] before starting recording (☞ P.61). |
| | | Adjust the recording setup such as by moving the earphones and microphone farther apart, or ensuring the microphone is not facing the earphones. |

Troubleshooting

| Problem | Possible cause | Solution |
|--|--|--|
| Unable to hear any sound from the earphone through the recording monitor | [Off] has been selected for [Rec Monitor]. | Select [On] for [Rec Monitor] (☞ P.61). |
| Unable to write index marks/temp marks | The maximum number of marks (99) has been reached. | Erase unneeded marks (☞ P.44). |
| | The file is locked. | You must unlock the file before you can erase it (☞ P.66). |
| | The file is a read-only file. | Unlock the file, or undo the read-only setting on a PC. |
| Unable to charge the battery | Other than the specified battery is used. | Use the specified battery (LI-50B) |
| | The [USB Settings] is set to [Composite]. | Set the [USB Settings] to [Storage Class] (☞ P.72). |
| The PC is unable to recognize the voice recorder. | When connecting to the PC, [AC Adapter] was selected. | When transferring data to the PC, select [PC] (☞ P.97). |
| Button operations are abnormal. | The [Transcription Mode] setting is [On]. | Set the [Transcription Mode] setting to [Off] (☞ P.65). |
| Wi-Fi cannot be connected. | The voice recorder is not turned ON. | Turn the power ON (☞ P.15). |
| | The Wi-Fi ON/OFF switch of the voice recording is set to OFF. | Turn ON the Wi-Fi ON/OFF switch on the voice recorder (☞ P.74). |
| | The Wi-Fi setting on the connected device is incorrect. | In the [Wi-Fi] setting, select [Wi-Fi connection]. Check the SSID and password (☞ P.74). |
| | The voice recorder is in a location that radio signals cannot reach. | Check for obstacles between the voice recorder and access point. |
| Unable to select [Change password]. | The Wi-Fi ON/OFF switch of the voice recorder is set to ON. | Turn OFF the Wi-Fi ON/OFF switch on the voice recorder (☞ P.74). |

Recorder care

- **Exterior**

Wipe gently with a soft cloth. If the recorder is very dirty, soak the cloth in mild soapy water and wring well. Wipe the recorder with the damp cloth and then wipe it with a dry cloth.

- **Monitor**

Wipe gently with a soft cloth.

NOTE

- Do not use benzene, alcohol or other strong solvents, or chemical cleaning cloths.

Accessories (optional)

Accessories for Olympus voice recorders can be purchased directly from the Online Shop on the Olympus website. Availability of accessories differs depending on the country.

ME51SW stereo microphone

Has a large-diameter built-in microphone for sensitive stereo recording.

ME30W two-channel microphone (omnidirectional)

Two ME30 monaural microphones come in a set with a miniature tripod and a connection adapter. These highly sensitive omni-directional microphones are supported by plug-in power and are well-suited to recording musical performances.

ME31 compact gun microphone (unidirectional)

A directional gun microphone handy for outdoor recording of wild birds singing and other highly directional applications. The metal body provides a highly rigid body.

ME34 compact gun microphone (unidirectional)

Comes with an integrated tripod ideal for table placement when recording events from a distance, such as conferences or lectures.

ME33 boundary microphone

A microphone for recording conferences that enables connection of up to three left- and three right-channel units. Cascade connection enables the left/right channel connections to be extended up to about 12 meters, to capture sound from a broad range.

ME52W mono microphone (unidirectional)

Designed to record sound from a distance while minimizing the impact of surrounding noise.

ME15 mono tie clip microphone (omnidirectional)

A small, unobtrusive microphone that comes with a tie-clip.

TP8 telephone pickup microphone

An earphone microphone that can be worn in the ear during phone calls. Clearly captures voices and conversations during phone calls.

A514 USB-connection AC adapter

A USB-connected AC adapter that provides 5-volt DC output. (AC100-240V 50/60Hz)

Accessories (optional)

KA333 connecting cord

A resistive connection cord with stereo mini-plugs (3.5 mm diameter) on both ends. Used to connect the earphone jack output to the line input when recording. Comes with plug adapters (PA331/PA231) that adapt to mono mini plugs (3.5 mm diameter) or mono mini mini plugs (2.5 mm diameter).

RS30W special remote control set

By attaching a receiver to the **REMOTE** jack, you can perform recording/stop operation of the voice recorder remotely. The reception position can be adjusted, and the voice recorder can be operated in any direction you like.

LI-50B lithium-ion battery

Rechargeable lithium-ion battery made by Olympus. This battery can be used with the UC-50 charger.

Carrying case: CS147

Copyright and trademark information

- The information in this document is subject to change in future without prior notice. Contact Olympus Customer Support Center for the latest product names, model numbers and other information.
- The display and illustrations of the voice recorder used in this manual may differ from the actual product. While every precaution has been taken to ensure the accuracy of the information in this manual, errors may occasionally arise. Any questions or concerns regarding doubtful information, or possible errors or omissions should be directed to the Olympus Customer Support Center.
- Olympus Corporation and Olympus Imaging Corp. are the copyright holders of this manual. Copyright law prohibits unauthorized reproduction of this manual, or unauthorized distribution of reproductions thereof.
- Note that Olympus will assume no liability in the event of damages, lost earnings, or any claims from third parties resulting from improper use of the product.

Trademarks and registered trademarks

- IBM and PC/AT are trademarks or registered trademarks of International Business Machines Corporation.
- Microsoft, Windows and Windows Media are registered trademarks of Microsoft Corporation.
- SD, SDHC, and SDXC are trademarks of SD Card Association.
- Macintosh and iTunes are trademarks of Apple Inc.
- The product uses MP3 audio coding technology licensed from Fraunhofer IIS and Thomson.
- The product uses noise-canceling technology licensed from NEC Corporation.
- The product uses voice activity detection technology licensed from NTT Electronics Corporation.
- The product uses directivity control technology licensed from Kyoei Engineering Corporation.
- Android and Google Play are trademarks or registered trademarks of Google Inc.
- App Store is a service mark of Apple Inc.
- QR code is a registered trademark of DENSO WAVE INCORPORATED.

Copyright and trademark information

- IOS is a trademark or registered trademark of Cisco in the USA or other countries and is used based on the license.
- Wi-Fi is a registered trademark of the Wi-Fi Alliance.
The Wi-Fi CERTIFIED logo is a certification mark of the Wi-Fi Alliance.

All other brand or product names in this manual are the trademarks or registered trademarks of their respective owners.



Notes



WARNING

- **Turn OFF the voice recorder in a hospital or near medical electric devices.**
Electric waves from the voice recorder could affect electric medical devices and could cause accidents due to malfunction.
- **Keep a distance of at least 22cm from persons who have a pacemaker.**
Electric waves from this voice recorder could affect the operation of a pacemaker.
- **Turn OFF the voice recorder power when on airplane.**
Security of the service could be affected.

Copyright and trademark information

The software in this product includes third party software. Any third party software is subject to the terms and conditions, imposed by the owners or licensors of that software, under which such software is provided to you. Those terms and conditions are shown below.

Copyright (C) 2003-2005, Jouni Malinen <jkmaline@cc.hut.fi>
Copyright (C) 2006-2007, Marvell International Ltd. and its affiliates
All rights reserved.

1. Redistributions in binary form must reproduce the above copyright notice, this list of conditions and the following disclaimer in the documentation and/or other materials provided with the distribution.
2. Neither the name of Jouni Malinen, Marvell nor the names of its contributors may be used to endorse or promote products derived from this software without specific prior written permission.

@author Vincent Rijmen <vincent.rijmen@esat.kuleuven.ac.be>
@author Antoo Bosselaers <antoo.bosselaers@esat.kuleuven.ac.be>
@author Paulo Barreto <paulo.barreto@terra.com.br>

THIS SOFTWARE IS PROVIDED BY THE COPYRIGHT HOLDERS AND CONTRIBUTORS "AS IS" AND ANY EXPRESS OR IMPLIED WARRANTIES, INCLUDING, BUT NOT LIMITED TO, THE IMPLIED WARRANTIES OF MERCHANTABILITY AND FITNESS FOR A PARTICULAR PURPOSE ARE DISCLAIMED. IN NO EVENT SHALL THE COPYRIGHT OWNER OR CONTRIBUTORS BE LIABLE FOR ANY DIRECT, INDIRECT, INCIDENTAL, SPECIAL, EXEMPLARY, OR CONSEQUENTIAL DAMAGES (INCLUDING, BUT NOT LIMITED TO, PROCUREMENT OF SUBSTITUTE GOODS OR SERVICES; LOSS OF USE, DATA, OR PROFITS; OR BUSINESS INTERRUPTION) HOWEVER CAUSED AND ON ANY THEORY OF LIABILITY, WHETHER IN CONTRACT, STRICT LIABILITY, OR TORT (INCLUDING NEGLIGENCE OR OTHERWISE) ARISING IN ANY WAY OUT OF THE USE OF THIS SOFTWARE, EVEN IF ADVISED OF THE POSSIBILITY OF SUCH DAMAGE.

8

Copyright (c) 2002-2007, Jouni Malinen <j@w1.fi> and contributors
All Rights Reserved.

Redistribution and use in source and binary forms, with or without modification, are permitted provided that the following conditions are met:

Redistributions of source code must retain the above copyright notice, this list of conditions and the following disclaimer.

Redistributions in binary form must reproduce the above copyright notice, this list of conditions and the following disclaimer in the documentation and/or other materials provided with the distribution.

THIS SOFTWARE IS PROVIDED BY THE COPYRIGHT HOLDERS AND CONTRIBUTORS "AS IS" AND ANY EXPRESS OR IMPLIED WARRANTIES, INCLUDING, BUT NOT LIMITED TO, THE IMPLIED WARRANTIES OF MERCHANTABILITY AND FITNESS FOR A PARTICULAR PURPOSE ARE DISCLAIMED. IN NO EVENT SHALL THE COPYRIGHT HOLDER OR CONTRIBUTORS BE LIABLE FOR ANY DIRECT, INDIRECT, INCIDENTAL, SPECIAL, EXEMPLARY, OR CONSEQUENTIAL DAMAGES (INCLUDING, BUT NOT LIMITED TO, PROCUREMENT OF SUBSTITUTE GOODS OR SERVICES; LOSS OF USE, DATA, OR PROFITS; OR BUSINESS INTERRUPTION) HOWEVER CAUSED AND ON ANY THEORY OF LIABILITY, WHETHER IN CONTRACT, STRICT LIABILITY, OR TORT (INCLUDING NEGLIGENCE OR OTHERWISE) ARISING IN ANY WAY OUT OF THE USE OF THIS SOFTWARE, EVEN IF ADVISED OF THE POSSIBILITY OF SUCH DAMAGE.

Safety precautions

Before using the voice recorder, read this manual to ensure correct and safe operation. After reading this manual, be sure to keep it on hand for ready reference whenever needed.

Important safety precautions

- Important items about safety are indicated by the following display and sentences. Always follow these precautions to prevent harming yourself or others, or causing damage to property.
- The meaning of each precaution type is given below.



DANGER

A precaution about an imminent danger that is expected to result in death or serious injury if equipment is handled incorrectly.



WARNING

A precaution about a situation that is expected to potentially result in death or serious injury if equipment is handled incorrectly.



CAUTION

A precaution about a situation that is expected to potentially result in injury, or is expected to result only in property damage, if equipment is handled incorrectly.

Voice recorder safety precautions



WARNING

- **Do not use the voice recorder in an atmosphere that might contain flammable or explosive gases.**
It may cause fire or explosion.
- **Do not attempt to disassemble, repair or modify the voice recorder.**
It may cause electric shock or injury.
- **Do not operate the voice recorder while operating a vehicle (such as a bicycle, motorcycle or car).**
It may cause traffic accidents.
- **Do not leave the voice recorder in a location accessible to an infant or child.**

Pay attention when using the voice recorder near an infant or child, taking care not to leave it unattended. Infants and children are unable to understand voice recorder safety precautions, and are at risk of accidents such as:

- Strangulation caused by accidental entanglement of the earphone cord around the neck.
- Operation errors resulting in injury or electric shock.

- **Use SD/SDHC/SDXC memory cards only. Never place other types of cards in the voice recorder.**

If another card type is placed in the voice recorder by accident, do not try to pull it out by force. Contact an Olympus repair center or service center.

Safety precautions

- **If the voice recorder is dropped in water or, if water, metal or combustible foreign matter gets inside:**

- ① Remove the battery immediately.
- ② Contact your place of purchase or an Olympus service center for repair. Continued use may result in fire or electric shock.

- **Do not use the voice recorder or use it only as directed in airplanes, hospitals or other locations where use of electronic devices is restricted.**

- **Stop using the voice recorder if you notice unusual odor, noise, or smoke coming from it.**

It may cause fire or burns. Remove the battery immediately, taking care not to burn yourself. Contact your place of purchase or an Olympus repair center or service center. (Do not touch the battery with bare hands when removing it. Remove the battery outdoors, and away from flammable objects.)

- **When carrying the voice recorder by its strap, take care to prevent it becoming caught on other items.**
- **Do not touch for an extended period of time an energized AC adapter or battery while it is charging.**

The temperature of the AC adapter or battery being charged rises. Low-temperature burns may result if your skin touches the AC adapter or battery being charged for extended period of time

- **Use only Olympus' special lithium-ion battery, charger, and AC adapter.**

Attempting to use other equipment could cause fire or electric shock due to heating, deformation, etc. Also, the power of the voice recorder could fail or an unexpected accident could occur. We assume not responsibility for problems as a result of using other than specified products.

CAUTION

- **Do not raise the volume before performing an operation.**
Hearing damage or loss may result.

Batteries

DANGER

- **Do not place the battery near ignition sources.**
- **Do not incinerate, heat or disassemble the battery. Do not short-circuit the battery's positive and negative electrodes.**
It may cause fire, ruptures, combustion or overheating.
- **Do not solder connections directly onto the battery. Do not deform, modify or disassemble the battery.**
- **Do not connect the battery's positive and negative terminals.**
It may cause overheating, electric shock or fire.
- **When carrying or storing the battery, always place it in the case to protect its terminals. Do not carry or store the battery together with precious metal items such as key rings.**
It may cause overheating, electric shock or fire.

Safety precautions

- **Do not connect the battery directly to a power outlet or car cigarette lighter.**
- **Do not use or leave the battery in a hot location such as in direct sunlight, inside a vehicle on a hot day, or near a room heater.**

It may cause fire, burns or injuries from leaking, overheating or ruptures.



WARNING

- **Do not touch or hold the battery with wet hands.**
It may cause electric shock or malfunctions.
- **Do not use a battery with a scratched or damaged case.**
It may cause ruptures or overheating.
- **Do not insert the battery with its positive/negative terminals in the opposite direction.**
It may cause leaking, overheating, combustion or ruptures.
 - Do not use a battery with a torn casing seal (insulating covering).
 - Always remove the battery when the voice recorder will not be used for an long period.
 - When disposing used batteries, insulate their contacts with tape and discard them as general waste in the manner prescribed by the local authority.
 - Remove the battery from the voice recorder as soon as the battery becomes unusable. It may cause leakage.
- **Battery fluid in the eyes may cause blindness. If battery fluid gets in eyes, do not rub the eyes. Instead, rinse them thoroughly with tap water or other clean water right away. Go to doctor immediately.**
- **Keep the battery out of the reach of infants and children.**
The battery could be swallowed by an infant or child. If swallowed, go to doctor immediately.
- **If you notice abnormal sound, heat, burning odor or smoke from the voice recorder during use:**
 - ① Remove the battery immediately, taking care not to injure yourself.
 - ② Have the voice recorder repaired by your place of purchase or an Olympus service center. Continued use may result in fire or burns.
- **Do not submerge the battery in freshwater or saltwater, or allow its terminals to become wet.**
- **Discontinue use of the battery if it develops a problem such as leaking, discoloration or deformation.**
- **Stop charging the rechargeable battery if charging has not finished after the specified amount of charging time.**
- **Battery fluid on clothing or skin may damage the skin, so rinse the battery fluid off right away with tap water or other clean water.**

Safety precautions



CAUTION

- **Do not throw the battery around, or subject it to strong shocks.**
- **Always charge the rechargeable battery before use when using it for the first time or if it has not been used for a long time.**
- **There is a risk of explosion if the battery is replaced with the incorrect battery type. Dispose of the used battery following the instructions.**
 - Please recycle batteries to help save our planet's resources. When you throw away dead batteries, be sure to cover their terminals and always observe local laws and regulations.
- **Rechargeable batteries have a limited life. When the recorders operating time becomes shorter after recharging under the specified condition, please consider that battery is expired and replace it with a new one.**

Disposing the rechargeable battery

- **Recycling batteries helps saving resources. When disposing a used battery, always cover its terminals and observe local laws and regulations.**

Operating precautions

- Do not leave the voice recorder in hot or humid locations such as in direct sunlight inside a vehicle, or on a beach during summer.
- Do not store the voice recorder in humid

or dusty locations.

- If the voice recorder becomes wet or damp, wipe off the moisture right away with a dry cloth. Contact with salt water should be particularly avoided.
- Do not place the voice recorder on top of or near a TV, refrigerator or other electrical appliance.
- Prevent sand or mud from getting on the voice recorder. It may cause product not to be repairable.
- Do not subject the voice recorder to intense vibrations or shocks.
- Do not use the voice recorder in humid locations.
- Placing a magnetic card (such as a bank cash card) near the speaker or earphones may cause errors in the data stored on the magnetic card.

AC adapter



WARNING

- **Do not attempt to disassemble, repair or modify the AC adapter in any way.**

It may cause electric shock or other injury.
- **Do not use the AC adapter in the vicinity of flammable gas (including gasoline, benzene and lacquer thinner).**

It may cause explosion, fire, or burns.
- **Do not short circuit the ⊕ and ⊖ at the plug end.**

It may cause fire, burns or electric shock.

- **If internal material is exposed due to dropping or damage:**
 - ① Never touch exposed internal material. Doing so could cause electric shock, burns or other injury.

Safety precautions

- ② Immediately disconnect the power supply plug from the power outlet, and;
- ③ Call your dealer or local Olympus representative for servicing. Continued use may result in fire or burns.

● If the voice recorder is submerged in water or, if water, metal or combustible foreign matter gets inside:

- ① Disconnect the power plug from the outlet.
- ② Call your dealer or local Olympus representative for servicing. Continued use may result in fire or electric shock.

● If you notice abnormal sound, heat, burning odor or smoke from the voice recorder during use:

- ① Remove the battery immediately, taking care not to injure yourself.
- ② Call your dealer or local Olympus representative for servicing. Continued use may result in fire or burns.



CAUTION

- **Do not moisten the AC adapter or touch it with a wet hand.**
Doing so could cause electric shock or other injury.
- **Never use the voice recorder with other than the specified power supply voltage.**
- **Do not attempt to insert a power plug with dust adhering into an outlet.**
- **Do not use the AC adapter if the power plug is damaged or the plug is not completely connected to the outlet.**
- **Unplug the AC adapter from AC outlet when not using.**

● Do not damage the power cord.

- Make sure to hold the plug when removing the power plug from the outlet.
- Do not place heavy objects on the cord.
- Do not bring the cord near heating equipment.
- It may cause fire or electric shock.

LCD monitor

- **The LCD used for the monitor is made with high-precision technology. However, black spots or bright spots of light may appear constantly on the LCD Monitor. Due to its characteristics or the angle at which you are viewing the monitor, the spot may not be uniform in color and brightness. This is not a malfunction.**

Software



WARNING

- **Do not use a music CD player to play back the included CD-ROM.**

It may damage the speaker and headphones or hearing loss may result.

<Data loss precautions>

- Recorded content in the internal memory and SD card may be destroyed or lost due to reasons such as operating errors, device failure or repair.
- Also, when content is saved in the memory for long period of time or is used repeatedly, operations such as writing to, reading from, or erasing of contents may not be possible.
- Making a backup of important recorded information and saving it on a PC's hard disk or other recording media is recommended.

Safety precautions

- Note that Olympus will assume no liability for damages or lost earnings resulting from recorded data damage or loss, regardless of the nature or cause thereof.

<Recorded file precautions>

- Note that Olympus will assume no liability for recorded files being erased or becoming unplayable due to voice recorder or PC failure.
- Recording of copyrighted material is permitted when the recording is for your personal use only. Any other type of use without the permission of the copyright owner is prohibited by copyright law.

<Voice recorder and SD cards disposal precautions>

- Even when data is formatted (P.88) or erased (P.46), only the management information of the file is updated and the data that was recorded on the SD card or internal memory is not completely erased. When disposing of an SD card, be sure to destroy the card, format the card and record silence until the recording time runs out, or perform a similar operation in order to prevent the leakage of personal information.

Specifications

General items

■ Recording formats

Linear PCM (pulse-code modulation) format

MP3 (MPEG-1 Audio Layer 3) format

WMA (Windows Media Audio) format

■ Sampling frequency

Linear PCM format

| | |
|------------------|----------|
| 48.0 kHz/16 bits | 48.0 kHz |
| 44.1 kHz/16 bits | 44.1 kHz |

MP3 format

| | |
|----------|----------|
| 256 kbps | 44.1 kHz |
| 128 kbps | 44.1 kHz |

WMA format

| | |
|--------------|----------|
| 32 kbps mono | 44.1 kHz |
| 8 kbps mono | 8 kHz |

■ Maximum working output

150 mW (8Ω speaker)

■ Maximum headphone output

≤ 150 mV (conforms to EN 50332-2)

■ Wide band characteristic headphone output

75 mV ≤ (conforms to EN 50332-2)

■ Recording media*

Internal NAND FLASH memory: 4 GB

SD card: Supports 512 MB to 2 GB

SDHC card: Supports 4 GB to 32 GB

SDXC card: Supports 64 GB

* Some recording media memory capacity is used as a management area, so the actual usable capacity will always be slightly less than the displayed capacity.

Specifications

■ Wireless standards

Complies with IEEE802.11b/g
Supports IEEE802.11n* technology

* Only the 2.4 GHz band

- The communication speed and distance may vary depending on ambient conditions such as the radio environment, obstacles and installation environment.

■ Transmission scheme

OFDM modulation scheme
(IEEE802.11g/n)

DSSS modulation scheme (IEEE802.11b)

■ Wireless communication mode

Infrastructure mode (AP mode)

■ Security

WPA2-PSK (AES/TKIP)

■ Speaker

Built-in ø20 mm round dynamic speaker

■ MIC jack

ø3.5 mm impedance 2.2kΩ

■ EAR jack

ø3.5 mm impedance 8Ω or more

■ Power source

Standard voltage: 3.7V

Battery: Lithium-ion battery

External power supply: USB connection,
AC adapter (A514) (DC5V)

■ External dimensions

115 mm×51 mm×17.9 mm

(Not including largest projection)

■ Weight

105 g (including battery)

■ Operating temperature

0 to 42°C (32 to 107.6°F)

Frequency response

■ When recording from MIC jack

Linear PCM format

| | |
|------------------|-----------------|
| 48.0 kHz/16 bits | 40 Hz to 23 kHz |
| 44.1 kHz/16 bits | 40 Hz to 21 kHz |

MP3 format

| | |
|----------|-----------------|
| 256 kbps | 40 Hz to 20 kHz |
| 128 kbps | 40 Hz to 17 kHz |

WMA format

| | |
|--------------|-----------------|
| 32 kbps mono | 40 Hz to 13 kHz |
| 8 kbps mono | 40 Hz to 3 kHz |

■ When recording with built-in stereo microphone

70 Hz to 20 kHz (frequency response upper limit is set by recording mode during MP3/WMA-format recording)

■ During playback

20 Hz to 20 kHz

Battery life

The figures below are guideline values.

■ When recording with built-in stereo microphone (using internal memory)

| Recording mode | | Battery life | | |
|-------------------|------------------|-----------------------------------|------------------------------------|--|
| | | When [Rec Monitor] is set to [On] | When [Rec Monitor] is set to [Off] | When the Wi-Fi ON/OFF switch is set to ON* |
| Linear PCM format | 44.1 kHz/16 bits | 20 hours (approx.) | 29 hours (approx.) | — |
| MP3 format | 128 kbps | 19 hours (approx.) | 29 hours (approx.) | 11 hours (approx.) |
| WMA format | 8 kbps mono | 16 hours (approx.) | 23 hours (approx.) | — |

* When [Rec Monitor] is set to [Off].

■ During audio file playback (all playback modes)

During speaker playback

| Recording mode | | Battery life |
|-------------------|------------------|--------------------|
| Linear PCM format | 44.1 kHz/16 bits | 23 hours (approx.) |
| MP3 format | 128 kbps | 21 hours (approx.) |
| WMA format | 8 kbps mono | 22 hours (approx.) |

During earphone playback

| Recording mode | | Battery life |
|-------------------|------------------|--------------------|
| Linear PCM format | 44.1 kHz/16 bits | 29 hours (approx.) |
| MP3 format | 128 kbps | 26 hours (approx.) |
| WMA format | 8 kbps mono | 27 hours (approx.) |

NOTE

- The battery life figures shown here were determined using an Olympus test method. Actual battery life figures will vary greatly according to the battery used and usage conditions (Changing the playback speed, or using the [Rec Monitor], [Zoom Mic], [Voice Detect], [Noise Cancel], [Voice Balancer], [Transcription Mode] and [Wi-Fi] functions may affect the battery life.)
- Battery life will be shorter when using an SD card.

Specifications

Recording time

The figures below are guideline values.

■ Linear PCM format

| Recording media | | Recording mode | |
|-----------------|-------|--------------------------------|--------------------------------|
| | | 48.0 kHz/16 bits | 44.1 kHz/16 bits |
| Internal memory | 4 GB | 4 hours, 35 minutes (approx.) | 5 hours (approx.) |
| SD card | 64 GB | 89 hours, 30 minutes (approx.) | 97 hours, 25 minutes (approx.) |
| | 32 GB | 44 hours, 45 minutes (approx.) | 48 hours, 40 minutes (approx.) |
| | 16 GB | 22 hours, 20 minutes (approx.) | 24 hours, 15 minutes (approx.) |
| | 8 GB | 11 hours, 5 minutes (approx.) | 12 hours, 5 minutes (approx.) |

■ MP3 format

| Recording media | | Recording mode | |
|-----------------|-------|--------------------------------|-----------------------|
| | | 256 kbps | 128 kbps |
| Internal memory | 4 GB | 27 hours, 30 minutes (approx.) | 55 hours (approx.) |
| SD card | 64 GB | 535 hours (approx.) | 1,070 hours (approx.) |
| | 32 GB | 268 hours (approx.) | 535 hours (approx.) |
| | 16 GB | 134 hours (approx.) | 268 hours (approx.) |
| | 8 GB | 66 hours (approx.) | 133 hours (approx.) |

■ WMA format

| Recording media | | Recording mode | |
|-----------------|-------|-----------------------|------------------------|
| | | 32 kbps | 8 kbps |
| Internal memory | 4 GB | 218 hours (approx.) | 850 hours (approx.) |
| SD card | 64 GB | 4,200 hours (approx.) | 16,420 hours (approx.) |
| | 32 GB | 2,100 hours (approx.) | 8,200 hours (approx.) |
| | 16 GB | 1,040 hours (approx.) | 4,090 hours (approx.) |
| | 8 GB | 520 hours (approx.) | 2,040 hours (approx.) |

Specifications

NOTE

- Actual available recording times may be shorter than the figures shown here when making short recordings repeatedly (Equipment displays of available/elapsed recording times should be considered guideline values).
- Available recording time will also vary due to differences in the available memory capacity of different SD cards.

Maximum recording time per file

- The maximum file size is limited to about 4 GB in the WMA and MP3 formats, and to about 2 GB in the linear PCM (WAV) format.
- Regardless of the amount of remaining memory, the maximum recording time per file is restricted to the following values.

■ Linear PCM format

| Recording mode | Recording time |
|------------------|-------------------------------|
| 48.0 kHz/16 bits | 3 hours (approx.) |
| 44.1 kHz/16 bits | 3 hours, 20 minutes (approx.) |

■ MP3 format

| Recording mode | Recording time |
|----------------|--------------------------------|
| 256 kbps | 37 hours, 10 minutes (approx.) |
| 128 kbps | 74 hours, 30 minutes (approx.) |

■ WMA format

| Recording mode | Recording time |
|----------------|-----------------------------------|
| 32 kbps mono | 291 hours, 30 minutes (approx.) |
| 8 kbps mono | 1,139 hours, 20 minutes (approx.) |

Number of music tracks (songs) that can be recorded

The figures below are guideline values.

| | |
|------|----------------------|
| 4 GB | 800 tracks (approx.) |
|------|----------------------|

(At 128 kbps, 4 minutes per track)

Note that voice recorder specifications and appearance are subject to change without prior notice for performance improvements or other upgrading.

FCC Notice

- This equipment has been tested and found to comply with the limits for a Class B digital device, pursuant to Part 15 of the FCC Rules. These limits are designed to provide reasonable protection against harmful interference in a residential installation.
- This equipment generates, uses, and can radiate radio frequency energy and, if not installed and used in accordance with the instructions, may cause harmful interference to radio communications.
- However, there is no guarantee that interference will not occur in a particular installation. If this equipment does cause harmful interference to radio or television reception, which can be determined by turning the equipment off and on, the user is encouraged to try to correct the interference by one or more of the following measures:
 - Adjust or relocate the receiving antenna.
 - Increase the distance between the equipment and receiver.
 - Connect the equipment to an outlet on a circuit different from that to which the receiver is connected.
 - Consult your dealer or an experienced radio/TV technician for help. Only the OLYMPUS-supplied USB cable should be used to connect the equipment to USB enabled personal computers (PC).

Any unauthorized changes or modifications to this equipment would void the user's authority to operate it.

DM-901 is equipped with WLAN device with IC and FCC ID:

- FCC ID: RYYWYAAVDX7,
- IC: 4389B-WYAAVDX7

The available scientific evidence does not show that any health problems are associated with using low power wireless devices. There is no proof, however, that these low power wireless devices are absolutely safe. Low power Wireless devices emit low levels of radio frequency energy (RF) in the microwave range while being used. Whereas high levels of RF can produce health effects (by heating tissue), exposure of low-level RF that does not produce heating effects causes no known adverse health effects. Many studies of low-level RF exposures have not found any biological effects. Some studies have suggested that some biological effects might occur, but such findings have not been confirmed by additional research. DM-901 has been tested and found to comply with FCC/IC radiation exposure limits set forth for an uncontrolled environment and meets the FCC radio frequency (RF) Exposure Guidelines in Supplement C to OET65 and RSS-102 of the IC radio frequency (RF) Exposure rules. SAR testing has been done at a distance of 0 cm from the body.

Les connaissances scientifiques dont nous disposons n'ont mis en évidence aucun problème de santé associé à l'usage des appareils sans fil à faible puissance. Nous ne sommes cependant pas en mesure de prouver que ces appareils sans fil à faible puissance sont entièrement sans danger. Les appareils sans fil à faible puissance émettent une énergie radioélectrique (RF) très faible dans le spectre des micro-ondes lorsqu'ils sont utilisés. Alors qu'une dose élevée de RF peut avoir des effets sur la santé (en chauffant les tissus), l'exposition à de faibles RF qui ne produisent pas de chaleur n'a pas de mauvais effets connus sur la santé. De nombreuses études ont été menées sur les expositions aux RF faibles et n'ont découvert aucun effet biologique. Certaines études ont suggéré qu'il pouvait y avoir certains effets biologiques, mais ces résultats n'ont pas été confirmés par des recherches supplémentaires. DM-901 a été testé et jugé conforme aux limites d'exposition aux rayonnements énoncées pour un environnement non contrôlé et respecte les règles des radioélectriques (RF) de la FCC lignes directrices d'exposition dans le Supplément C à OET65 et d'exposition aux fréquences radioélectriques (RF) CNR-102 de l'IC. Le test SAR a été fait à distance de 0cm du corps.

For customers in North America

■ For customers in USA

Declaration of Conformity

Model Number: DM-901

Trade Name: DIGITAL VOICE RECORDER

Responsible Party: OLYMPUS IMAGING AMERICA INC.

Address: 3500 Corporate Parkway, P.O. Box 610, Center Valley, PA 18034-0610, U.S.A.

Telephone Number: 484-896-5000

Tested To Comply With FCC Standards

FOR HOME OR OFFICE USE

This device complies with Part 15 of the FCC rules and Industry Canada License - exempt RSS standard(s). Operation is subject to the following two conditions:

- (1) This device may not cause harmful interference.
- (2) This device must accept any interference received, including interference that may cause undesired operation.

■ For customers in CANADA

CAN ICES-3 (B) / NMB-3 (B)

Cet appareil est conforme aux normes de la Section 15 des directives FCC et Licence Industry Canada - exemption norme(s) RSS. Son utilisation est soumise aux deux conditions suivantes:

- (1) Cet appareil ne doit pas causer de brouillage radioélectrique.
- (2) Cet appareil doit pouvoir résister à toutes les interférences, y compris celles susceptibles d'entraver son bon fonctionnement.

FCC CAUTION

Changes or modifications not expressly approved by the party responsible for compliance could void the user's authority to operate the equipment.

This transmitter must not be co-located or operated in conjunction with any other antenna or transmitter.

To maintain compliance with FCC's RF exposure guidelines, use only the supplied antenna. Unauthorized antenna, modification, or attachments could damage the transmitter and may violate FCC regulations.

OLYMPUS®

OLYMPUS IMAGING CORP.

2951 Ishikawa-machi, Hachioji-shi, Tokyo 192-8507, Japan.

OLYMPUS IMAGING AMERICA INC.

3500 Corporate Parkway, P.O. Box 610, Center Valley, PA 18034-0610, U.S.A.

Tel. 484-896-5000

Technical Support (USA):

24/7 online automated help:

[http://www.olympusamerica.com/
support](http://www.olympusamerica.com/support)

Phone customer support:

Tel.: 1-888-553-4448 (Toll-free)

Our phone customer support is available from 9 am to 9 pm (Monday to Friday) ET
[http://www.olympusamerica.com/
contactus](http://www.olympusamerica.com/contactus)

Olympus software updates can be obtained at:

<http://www.olympusamerica.com/digital>