

# NETGEAR Installation Guide

Connect with Innovation™

## ProSafe 8-Port Switch with 4-Port PoE FS108P

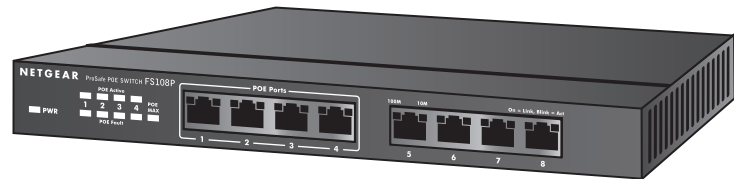

### Step 1. Connect equipment

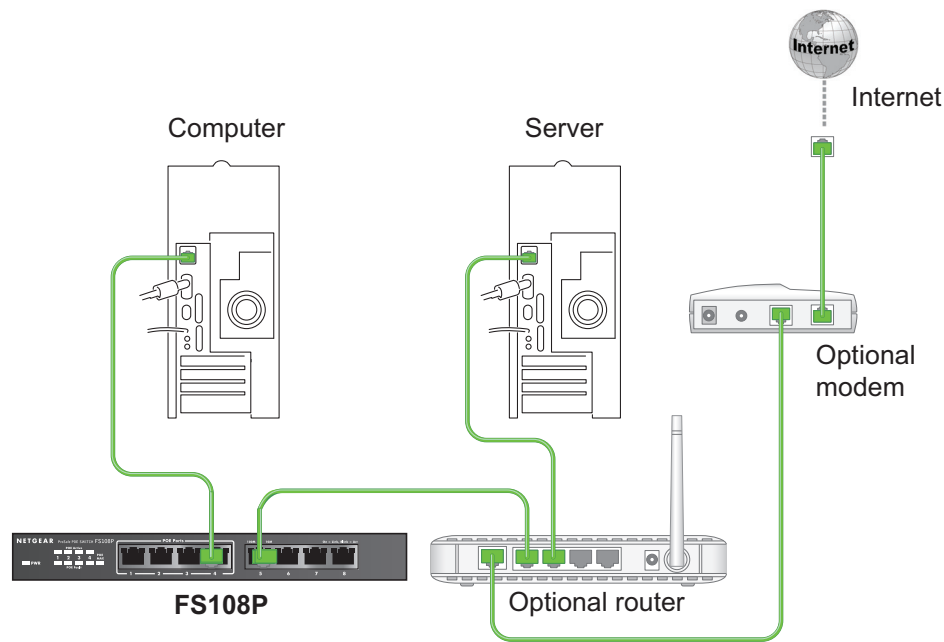

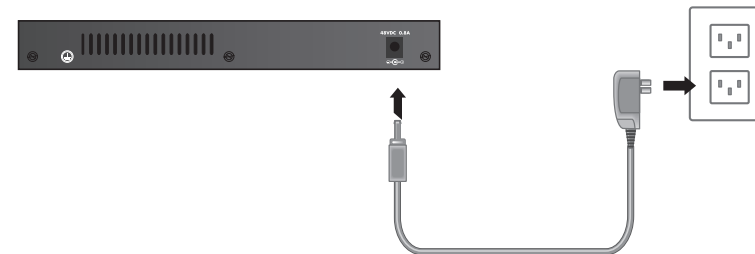

### Step 2. Connect power



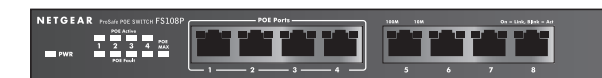

### Step 3. Check status



#### Power LED

-  On
-  Off



#### PoE LEDs

-  PoE Active
-  No PoE use (off)





#### PoE Fault LED

-  PoE fault

#### PoE Max. LED

-  Less than 7W of PoE power is available
-  PoE MAX LED was active in the previous 2 minutes (blinking)
-  PoE ports are working normally (off)

#### Port LEDs

-  100 Mbps link (left LED)
-  10 Mbps link (right LED)
-  Activity (blinking)
-  No link (off)

## Specifications

Specification	Description
Network interface	10/100Mbps Auto-Uplink RJ45 ports with PoE enabled (ports 1 - 4) 10/100Mbps Auto-Uplink RJ45 ports (port 5 - 8)
Network cable	Category 5 (Cat 5) or better Ethernet cable
Ports	8
Power adapter	48V @ 1.25A DC input
PoE Power consumption	53W max (all PoE ports, ports 1 to 4), 15.4W max per PoE port
Weight	0.74 kg (1.7 lbs)
Dimensions (W x D x H)	235 mm x103 mm x 27 mm 9.3 in. x 4.1 in.x 1.1 in.
Operating temperature	0 to 40 C (32 to 104 F)
Operating humidity	10% to 90% relative humidity, non-condensing
Electromagnetic compliance	CE Class B; FCC Class B; VCCI Class B; C-Tick Class B, CCC
Safety agency approvals	CE/LVD, CCC



201-16171-01



September 2012

For the complete EU Declaration of Conformity, visit  
[http://support.netgear.com/app/answers/detail/a\\_id/11621/](http://support.netgear.com/app/answers/detail/a_id/11621/).

**Statement of Conditions:** In the interest of improving internal design, operational function, and/or reliability, NETGEAR reserves the right to make changes to the products described in this document without notice. NETGEAR does not assume any liability that may occur due to the use or application of the product(s) or circuit layout(s) described herein.

## Technical Support

After installing your device, locate the serial number on the label of your product and use it to register your product at <https://my.netgear.com>.

You must register your product before you can use NETGEAR telephone support. NETGEAR recommends registering your product through the NETGEAR web site. For product updates and web support, visit <http://support.netgear.com>.



This symbol appears in accordance with the European Union Directive 2002/96 on the Waste Electrical and Electronic Equipment (the WEEE directive). If you dispose of this product in the European Union, treat and recycle it in accordance with your jurisdiction's laws that implement the WEEE directive.

NETGEAR, the NETGEAR logo, and Connect with Innovation are trademarks and/or registered trademarks of NETGEAR, Inc. and/or its subsidiaries in the United States and/or other countries. Information is subject to change without notice. Other brand and product names are registered trademarks or trademarks of their respective holders. © NETGEAR, Inc. All rights reserved.  
For indoor use only in all EU countries and Switzerland.