

Acer Aspire 4820T

Service Guide

Service guide files and updates are available on the ACER/CSD web; for more information, please refer to <http://csd.acer.com.tw>

PRINTED IN TAIWAN

Revision History

Please refer to the table below for the updates made on this service guides.

Date	Chapter	Updates

Copyright

Copyright © 2010 by Acer Incorporated. All rights reserved. No part of this publication may be reproduced, transmitted, transcribed, stored in a retrieval system, or translated into any language or computer language, in any form or by any means, electronic, mechanical, magnetic, optical, chemical, manual or otherwise, without the prior written permission of Acer Incorporated.

Disclaimer

The information in this guide is subject to change without notice.

Acer Incorporated makes no representations or warranties, either expressed or implied, with respect to the contents hereof and specifically disclaims any warranties of merchantability or fitness for any particular purpose. Any Acer Incorporated software described in this manual is sold or licensed "as is". Should the programs prove defective following their purchase, the buyer (and not Acer Incorporated, its distributor, or its dealer) assumes the entire cost of all necessary servicing, repair, and any incidental or consequential damages resulting from any defect in the software.

Acer is a registered trademark of Acer Corporation.

Intel is a registered trademark of Intel Corporation.

Other brand and product names are trademarks and/or registered trademarks of their respective holders.

Conventions

The following conventions are used in this manual:

SCREEN MESSAGES	Denotes actual messages that appear on screen.
NOTE	Gives bits and pieces of additional information related to the current topic.
WARNING	Alerts you to any damage that might result from doing or not doing specific actions.
CAUTION	Gives precautionary measures to avoid possible hardware or software problems.
IMPORTANT	Reminds you to do specific actions relevant to the accomplishment of procedures.

Preface

Before using this information and the product it supports, please read the following general information.

1. This Service Guide provides you with all technical information relating to the BASIC CONFIGURATION decided for Acer's "global" product offering. To better fit local market requirements and enhance product competitiveness, your regional office MAY have decided to extend the functionality of a machine (e.g. add-on card, modem, or extra memory capability). These LOCALIZED FEATURES will NOT be covered in this generic service guide. In such cases, please contact your regional offices or the responsible personnel/channel to provide you with further technical details.
2. Please note WHEN ORDERING FRU PARTS, that you should check the most up-to-date information available on your regional web or channel. If, for whatever reason, a part number change is made, it will not be noted in the printed Service Guide. For ACER-AUTHORIZED SERVICE PROVIDERS, your Acer office may have a DIFFERENT part number code to those given in the FRU list of this printed Service Guide. You MUST use the list provided by your regional Acer office to order FRU parts for repair and service of customer machines.

System Specifications	1
Features	1
System Block Diagram	4
Your Acer Notebook tour	5
Front View	5
Left View	6
Right View	7
Rear View	7
Bottom View	7
Indicators	8
TouchPad Basics	9
Using the Keyboard	10
Lock Keys and embedded numeric keypad	10
Windows Keys	11
Hot Keys	12
Hardware Specifications and Configurations	13
.....	18
 System Utilities	 19
BIOS Setup Utility	19
Navigating the BIOS Utility	19
TBD Intel BIOS	20
Information	20
Main	21
Security	22
Boot	25
Exit	26
BIOS Flash Utilities	27
DOS Flash Utility	28
WinFlash Utility	30
Remove HDD/BIOS Password Utilities	31
 Machine Disassembly and Replacement	 37
Disassembly Requirements	37
General Information	38
Pre-disassembly Instructions	38
Disassembly Process	38
External Module Disassembly Process	39
External Modules Disassembly Flowchart	39
Removing the Battery Pack	40
Removing the SD dummy card	41
Removing the Lower Cover	42
Removing the Optical Drive Module	43
Removing the DIMM Modules	45
Removing the WLAN Module	46
Removing the Hard Disk Drive Module	47
Main Unit Disassembly Process	48
Main Unit Disassembly Flowchart	48
Removing the Keyboard	49
Removing the Upper Cover	51
Removing the LED Board	54
Removing the Switch Board	55
Removing the Left Speaker Module	56
Removing the USB Board	57

Table of Contents

Removing the Bluetooth Module	59
Removing the Mainboard	61
Removing the Thermal Module	63
Removing the CPU	64
Removing the RTC Battery	65
Removing the WiFi Antenna Cable	65
Removing the Right Speaker	66
Removing the LCD Module	67
Removing the DC-In Cable	68
LCD Module Disassembly Process	69
LCD Module Disassembly Flowchart	69
Removing the LCD Bezel	70
Removing the Camera Module	71
Removing the LCD Panel	72
Removing the FPC Cable	73
Removing the Microphone Module	74
Removing the Hinges	74
Removing the Antennas	75
LCD Module Reassembly Procedure	77
Replacing the MIC and Antennas	77
Replacing the Microphone Module	78
Replacing the FPC Cable	79
Replacing the LCD Panel	79
Replacing the Webcam	80
Replacing the LCD Bezel	81
Main Module Reassembly Procedure	83
Replacing the DC-In Cable	83
Replacing the LCD Module	84
Replacing the Right Speaker	84
Replacing the RTC Battery	85
Replacing the CPU	86
Replacing the Thermal Module	86
Replacing the Mainboard	88
Replacing the Bluetooth Module	90
Replacing the USB Board	91
Replacing the TouchPad Bracket	91
Replacing the Left Speaker Module	92
Replacing the Switch Board	93
Replacing the LED Board	93
Replacing the Upper Cover	94
Replacing the Keyboard	97
Replacing the Hard Disk Drive Module	97
Replacing the WLAN Board	99
Replacing the DIMM Modules	99
Replacing the ODD Module	100
Replacing the Lower Covers	101
Replacing the Dummy Cards	102
Replacing the Battery Pack	102

Troubleshooting

103

Common Problems	103
Power On Issue	104
No Display Issue	105
Random Loss of BIOS Settings	106
LCD Failure	107

Table of Contents

Built-In Keyboard Failure	107
TouchPad Failure	108
Internal Speaker Failure	108
HDD Not Operating Correctly	110
ODD Failure	111
Wireless Function Failure	114
Thermal Unit Failure	114
External Mouse Failure	115
Other Failures	115
Intermittent Problems	116
Undetermined Problems	116
Post Codes	117
Jumper and Connector Locations	119
Top View	119
Bottom View	119
Clearing Password Check and BIOS Recovery	120
Clearing Password Check	120
BIOS Recovery by Crisis Disk	121
FRU (Field Replaceable Unit) List	123
Acer TBD Exploded Diagrams	124
LCD Assembly	124
Acer TBD FRU List	125
Screw List	125
Model Definition and Configuration	126
Acer TBD Series	126
Test Compatible Components	127
Microsoft® Windows® 7 Environment Test	128
Online Support Information	129
Index	131

Table of Contents

System Specifications

Features

Below is a brief summary of the computer's many features:

NOTE: Items denoted with an (*) are only available for selected models.

Operating System

- Genuine Windows® 7 Home Premium 64-bit*
- Genuine Windows® 7 Home Basic 64-bit*

Platform

- Intel® Core™ i7-620M processor (4 MB L3 cache, 2.66 GHz with Turbo Boost up to 3.33 GHz, DDR3 1066 MHz, 35 W), supporting Intel® 64 architecture, Intel® Smart Cache
- Intel® Core™ i5-430M/i5-520M/i5-540M processor (3 MB L3 cache, 2.26/2.40/2.53 GHz with Turbo Boost up to 2.53/2.93/3.06 GHz, DDR3 1066 MHz, 35 W) supporting Intel® 64 architecture, Intel® Smart Cache
- Intel® Core™ i3-330M/i3-350M processor (3 MB L3 cache, 2.13/2.26 GHz, DDR3 1066 MHz, 35 W) supporting Intel® 64 architecture, Intel® Smart Cache
- Mobile Intel® HM55 Express Chipset

System Memory

- Dual-channel DDR3 SDRAM support:
 - Up to 4 GB of DDR3 1066 MHz memory, upgradeable to 8 GB using two soDIMM modules

Display

- 14" HD 1366 x 768 pixel resolution, high-brightness (200-nit) Acer CineCrystal™ LED-backlit TFT LCD, supporting simultaneous multi-window viewing via Acer GridVista™
- 16:9 aspect ratio
- Super-slim design

Graphics

- Intel® HD Graphics with 128 MB of dedicated system memory, supporting Microsoft® DirectX® 10
- Dual independent display support
- 16.7 million colors
- External resolution / refresh rates:
 - VGA port up to 2560 x 1600: 60 Hz
 - HDMI™ port up to 1920 x 1200: 60 Hz
- MPEG-2/DVD decoding
- WMV9 (VC-1) and H.264 (AVC) decoding

-
- HDMI™ (High-Definition Multimedia Interface) 1.3 with HDCP (High-bandwidth Digital Content Protection) support
 - 1.65Gbps resolution
 - 1920*180p

Mini Card

- 2* Mini PCIE card
- 2 Mini PCIE card slot [1 for 3G (full size) and 1 for WLAN(half size)]

Audio

- Optimized 3rd Generation Dolby® Home Theater® audio enhancement, featuring Dolby® Digital Live, Dolby® Pro Logic® IIx, Dolby® Headphone, Dolby® Natural Bass, Dolby® Sound Space Expander, Dolby® Inverse Filtering, Dolby® High Frequency Enhancer technologies
- High-definition audio support
- S/PDIF (Sony/Philips Digital Interface)8 support for digital speakers
- MS-Sound compatible
- Built-in microphone

Storage

- 160/250/320/500/640 GB or larger hard disk drive
- Multi-in-1 card reader, supporting Secure Digital™ (SD), MultiMediaCard™ (MMC), Memory Stick® (MS), Memory Stick PRO™ (MS PRO), xD-Picture Card™ (xD)

Optical Drive

- 8X DVD-Super Multi double-layer drive:
 - Read: 24X CD-ROM, 24X CD-R, 24X CD-RW, 8X DVD-ROM, 8X DVD-R, 8X DVD+R, 6X DVD-ROM DL, 6X DVD-R DL, 6X DVD+R DL, 6X DVD-RW, 6X DVD+RW, 5X DVD-RAM
 - Write: 24X CD-R, 16X CD-RW, 8X DVD-R, 8X DVD+R, 4X DVD-R DL, 4X DVD+R DL, 6X DVD-RW, 8X DVD+RW, 5X DVD-RAM

Communication

- Acer video conferencing solution¹, featuring:
 - Acer Crystal Eye high-definition webcam with 1280 x 1024 resolution
- WLAN:
 - Acer InviLink™ Nplify™ 802.11 b/g/n Wi-Fi CERTIFIED™
 - Acer InviLink™ 802.11b/g Wi-Fi CERTIFIED™
 - Supporting Acer SignalUp™ wireless technology
- WPAN: Bluetooth® 2.1+EDR
- WWAN², 10, 12: UMTS/HSPA at 850/900/1900/2100 MHz and quad-band GSM/GPRS/EDGE(850/900/1800/1900 MHz), upgradeable to 7.2 Mb/s HSDPA and 5.7 Mb/s HSUPA, supporting receiver diversity and equalizing at 2100 MHz
- LAN: Gigabit Ethernet, Wake-on-LAN ready

Privacy control

- BIOS user, supervisor, HDD passwords
- Kensington lock slot

Dimensions and weight

- 342 (W) x 245 (D) x 19.4/25.4 (H) mm (13.46 x 9.64 x 0.76/0.99 inches)
- 2.2 kg (4.85 lbs.) with 6-cell battery

Power subsystem

- ACPI 3.0 CPU power management standard: supports Standby and Hibernation power-saving modes
- Acer PowerSmart 3-pin 65 W AC adapter
 - 95 (W) x 50 (D) x 25.4 (H) mm (3.74 x 1.96 x 1 inches)
 - 216 g (0.47 lbs) with 180 cm DC cable
- 66.6 W 6000 mAh 6-cell Li-ion standard battery pack
- Estimated battery life: Up to 8 hours
- ENERGY STAR®

Special keys and controls

- 86-/87-/91-key keyboard with inverted "T" cursor layout
- Multi-gesture touchpad pointing device supporting scroll, pinch, rotate, flip
- 10 function keys, four cursor keys, two Windows® keys, hotkey controls, independent standard numeric keypad, international language support
- Acer Programming key
- Easy-launch keys: Communication®
- Media control keys (printed on keyboard): play/pause, stop, previous, next

I/O interface

- Multi-in-1 card reader (SD™, MMC, MS, MS PRO, xD)
- Four USB 2.0 ports
- HDMI™ port with HDCP support
- External display (VGA) port
- Headphone/speaker jack with S/PDIF support
- Microphone-in jack
- Ethernet (RJ-45) port
- DC-in jack for AC adapter

Software

- Productivity
 - Acer Backup Manager
 - Acer ePower Management
 - Acer eRecovery Management

-
- Adobe® Flash® Player 10
 - Adobe® Reader® 9.1
 - eSobi™
 - Google™ Setup
 - Google Toolbar™
 - Microsoft® Office Personal 2007 (Service Pack 2) (Japan only, subject to customer request)
 - Microsoft® Office Trial (Service Pack 2)
 - Microsoft® Works SE 9
 - Microsoft® Works 9
 - Microsoft® Works 8.5
 - Norton™ Online Backup
 - Security
 - McAfee® Internet Security Suite 2009 Trial
 - McAfee® Virus Definitions
 - MyWinLocker
 - Multimedia
 - Acer Arcade™ Deluxe
 - NTI Media Maker™
 - Gaming
 - Oberon GameZone Acer Edition1
 - WildTangent® Acer Edition1
 - Communication and ISP
 - Acer Video Conference Manager
 - Microsoft® Silverlight™
 - Windows Live™ Essentials - Wave 3.2 (Mail, Photo Gallery, Live™ Messenger, Movie Maker, Writer)
 - Utilities and tools
 - Acer Accessory Store
 - Acer Assist
 - Acer Identity Card
 - Acer Registration
 - Acer Updater
 - eBay® shortcut 2009
 - Netflix shortcut1

Optional Items

- Acer Media Center remote control
- 1 GB / 2 GB / 4 GB DDR3 1066 MHz soDIMM module
- 9-cell Li-ion battery pack
- 3-pin 90 W AC adapter

-
- External USB floppy disk drive
 - External USB 56K modem

Warranty

- One-year International Travellers Warranty (ITW)

Environment

- Temperature:
 - Operating: 5 °C to 35 °C
 - Non-operating: -20 °C to 65 °C
- Humidity (non-condensing):
 - Operating: 20% to 80%
 - Non-operating: 20% to 80%

System Block Diagram

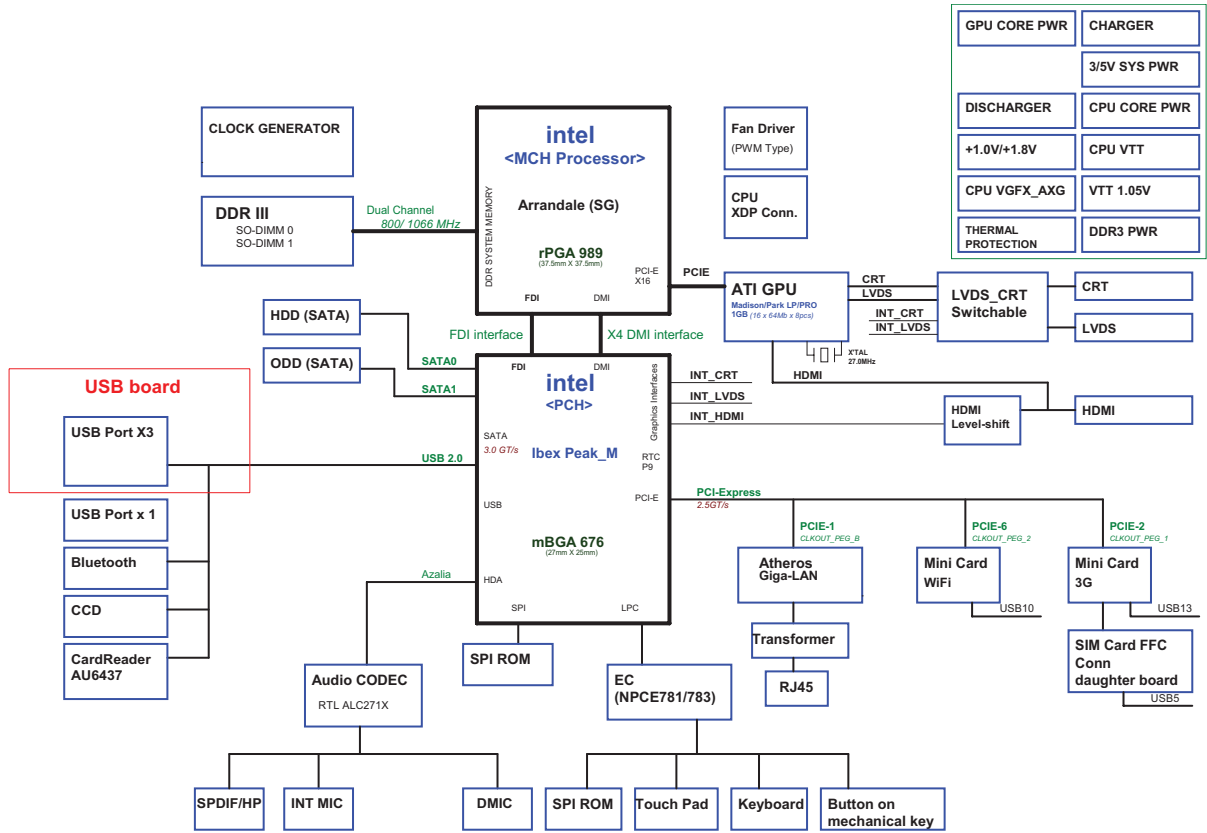











Your Acer Notebook tour

After knowing your computer features, let us show you around your new computer.

Front View



No.	Icon	Item	Description
1		Acer Crystal Eye webcam	Web camera for video communication (for selected models).
2		Microphone	Internal microphone for recording sound.
3		Display screen	Also called Liquid-Crystal Display (LCD), displays computer output.

No.	Icon	Item	Description
4		HDD	Indicates when the hard disk drive is active.
		Num Lock indicator	Lights up when Num Lock is activated.
		Caps Lock indicator	Lights up when Caps Lock is activated.
5		Power button	Turns the computer on and off.
6		Keyboard	For entering data into your computer.
7		TouchPad	Touch-sensitive pointing device which functions like a computer mouse.
8		Power Indicator	Indicates the computer's power status.
		Battery Indicator	Indicates the computer's battery status. 1. Charging: The light shows amber when the battery is charging. 2. Fully charged: The light shows blue when in AC mode.
		Communication indicator	Indicates the computer's wireless connectivity device status.
9		Click buttons (left and right)	The left and right buttons function like the left and right mouse buttons.
10		Palmrest	Comfortable support area for your hands when you use the computer.
11		Speakers	Left and right speakers deliver stereo audio output.
12		Optical drive eject button	Ejects the optical disk from the drive.
13		Programmable key	User-programmable. (only for certain models)
		PowerSmart key	Puts your computer into power-saving mode. (only for certain models)

Closed Front View





No.	Icon	Item	Description
1		Multi-in-1 card reader	Accepts Secure Digital (SD), MultiMediaCard (MMC), Memory Stick (MS), Memory Stick PRO (MS PRO), xD-Picture Card (xD). Note: Push to remove/install the card. Only one card can operate at any given time.

Left View





No.	Icon	Item	Description
1		Kensington lock slot	Connects to a Kensington-compatible computer security lock.
2		Ventilation slots	Enable the computer to stay cool, even after prolonged use.
3		External display (VGA) port	Connects to a display device (e.g. external monitor, LCD projector).
4		HDMI	Connect to HDMI devices
5		Ethernet (RJ-45) port	Connects to an Ethernet 10/100/1000-based network.
6		USB 2.0 ports	Connect to USB 2.0 devices (e.g. USB mouse, USB camera).

No.	Icon	Item	Description
7		Microphone-in jack	Accepts input from external microphones.
		Headphones/speaker/line-out jack	Connects to audio line-out devices (e.g. speakers, headphones).





Right View

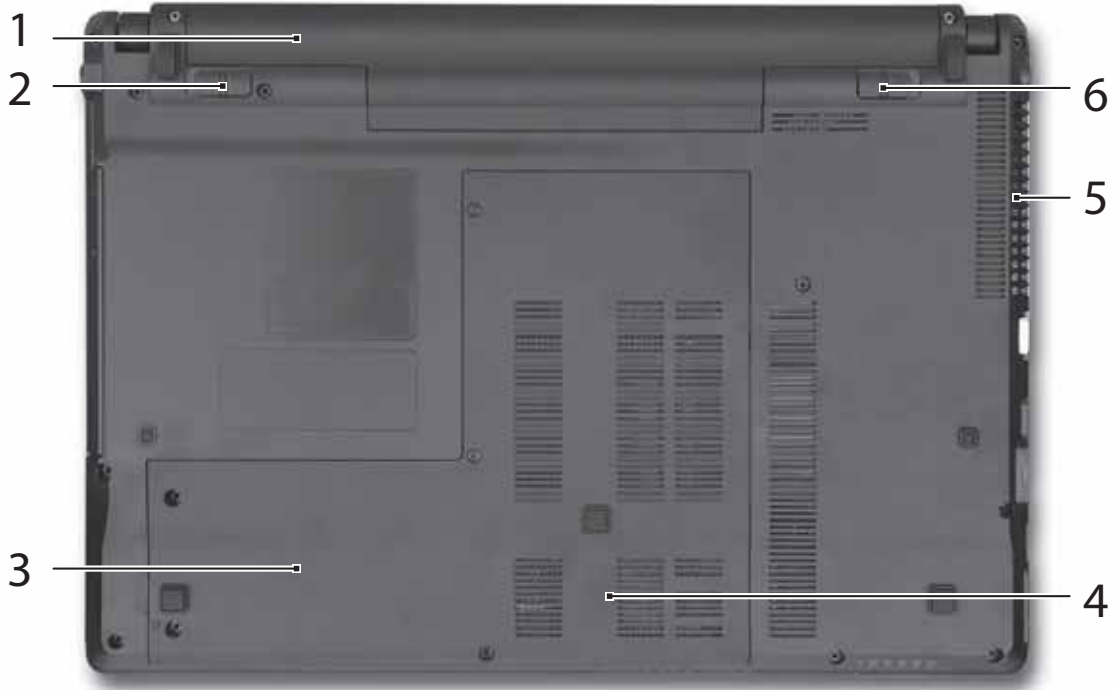

No.	Icon	Item	Description
1		USB 2.0 ports	Connect to USB 2.0 devices (e.g. USB mouse, USB camera).
2		Optical drive	Internal optical drive; accepts CDs or DVDs.
3		Optical disk access indicator	Lights up when the optical drive is active.
4		Emergency eject hole	Ejects the optical drive tray when the computer is turned off. Note: Insert a paper clip into the emergency eject hole to eject the optical drive tray when the computer is off.
6		DC-in jack	Connects to an AC adapter.

Bottom View





No.	Icon	Item	Description
1		Battery bay	Houses the computer's battery pack.
2		Battery lock	Locks the battery in position.
3		Hard disk bay	Houses the computer's hard disk (secured with screws).
4		Memory compartment	Houses the computer's main memory.
5		Ventilation slots and cooling fan	Enable the computer to stay cool, even after prolonged use. Note: Do not cover or obstruct the fan opening.
6		Battery release latch	Releases the battery for removal.

Indicators

The computer has several easy-to-read status indicators.

Icon	Function	Description
	Power	Indicates the computer's power status.

Icon	Function	Description
	Battery	Indicates the computer's battery status. NOTE: 1. Charging: The light shows amber when the battery is charging. 2. Fully charged: The light shows green when in AC mode.
	HDD	Indicates when the hard disk drive is active.
	Communication indicator	Indicates the computer's wireless connectivity device status.

TouchPad Basics

The following items show you how to use the TouchPad:

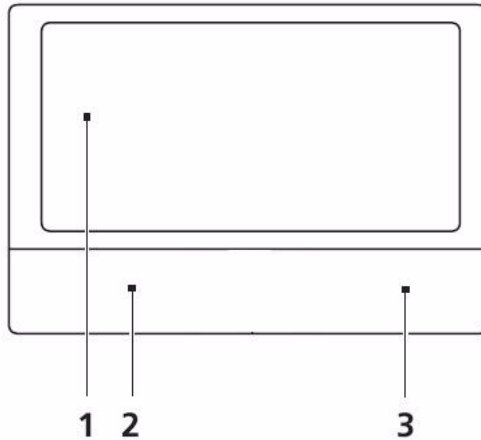

- Move your finger across the TouchPad (1) to move the cursor.
- Press the left (2) and right (3) buttons located beneath the TouchPad to perform selection and execution functions. These two buttons are similar to the left and right buttons on a mouse. Tapping on the TouchPad is the same as clicking the left button.

Function	Left Button (2)	Right Button (3)	Main TouchPad (1)
Execute	Quickly click twice.		Tap twice (at the same speed as double-clicking a mouse button).
Select	Click once.		Tap once.
Drag	Click and hold, then use finger on the TouchPad to drag the cursor.		Tap twice (at the same speed as double-clicking a mouse button); rest your finger on the TouchPad on the second tap and drag the cursor.
Access context menu		Click once.	

NOTE: When using the TouchPad, keep it - and your fingers - dry and clean. The TouchPad is sensitive to finger movement; hence, the lighter the touch, the better the response. Tapping too hard will not increase the TouchPad's responsiveness.

Using the Keyboard

The keyboard has full-sized keys and an embedded numeric keypad, separate cursor, lock, Windows, function and special keys.





















Lock Keys and embedded numeric keypad

The keyboard has two lock keys which you can toggle on and off.

Lock key	Description
Caps Lock	When Caps Lock is on, all alphabetic characters typed are in uppercase.
Num Lock	When Num Lock is on, the embedded keypad is in numeric mode.

Windows Keys

The keyboard has two keys that perform Windows-specific functions.

Key	Description
 Windows key	<p>Pressed alone, this key has the same effect as clicking on the Windows Start button; it launches the Start menu. It can also be used with other keys to provide a variety of functions:</p> <ul style="list-style-type: none"><  >: Open or close the Start menu<  > + <D>: Display the desktop<  > + <E>: Open Windows Explore<  > + <F>: Search for a file or folder<  > + <G>: Cycle through Sidebar gadgets<  > + <L>: Lock your computer (if you are connected to a network domain), or switch users (if you're not connected to a network domain)<  > + <M>: Minimizes all windows<  > + <R>: Open the Run dialog box<  > + <T>: Cycle through programs on the taskbar<  > + <U>: Open Ease of Access Center<  > + <X>: Open Windows Mobility Center<  > + <BREAK>: Display the System Properties dialog box<  > + <SHIFT+M>: Restore minimized windows to the desktop<  > + <TAB>: Cycle through programs on the taskbar by using Windows Flip 3-D<  > + <SPACEBAR>: Bring all gadgets to the front and select Windows Sidebar<CTRL> + <  > + <F>: Search for computers (if you are on a network)<CTRL> + <  > + <TAB>: Use the arrow keys to cycle through programs on the taskbar by using Windows Flip 3-D <p>Note: Depending on your edition of Windows, some shortcuts may not function as described.</p>

Hot Keys

The computer employs hotkeys or key combinations to access most of the computer's controls like screen brightness, volume output and the BIOS utility.

To activate hot keys, press and hold the <Fn> key before pressing the other key in the hotkey combination.



Hotkey	Icon	Function	Description
<Fn> + <F3>		Communication key	Enables / disables the computer's communication devices. (Communication devices may vary by configuration.)
<Fn> + <F4>		Sleep	Puts the computer in Sleep mode.
<Fn> + <F5>		Display toggle	Switches display output between the display screen, external monitor (if connected) and both.
<Fn> + <F6>		Display Off	Turns the display screen backlight off to save power. Press any key to return.
<Fn> + <F7>		Touchpad toggle	Turns the internal touchpad on and off.
<Fn> + <F8>		Speaker toggle	Turns the speakers on and off.
<Fn> + <F11>		NumLk	Turns the embedded numeric keypad on or off.
<Fn> + <D>		Brightness up	Increases the screen brightness.
<Fn> + <Q>		Brightness down	Decreases the screen brightness.
<Fn> + <V>		Volume up	Increases the sound volume.
<Fn> + <N>		Volume down	Decreases the sound volume.
<Fn> + <Home>		Play/Pause	Play or pause a selected media file.
<Fn> + <Pg Up>		Stop	Stop playing the selected media file.
<Fn> + <Pg Dn>		Previous	Return to the previous media file.

Hardware Specifications and Configurations

CPU

Item	Specification
CPU	Intel Mobile Calpella
Graphics	Integrated VGA for Arrandale
CPU Package	rPGA988A
Power	4M (Arrandale) L3 shared among all cores
On-die Cache	32KB L1 & 256K L2 for each core

Processor Specifications

Item	CPU Speed	Cores	Bus Speed	Cache Size	Package	Core Voltage	Acer P/N
Ci3330M	2.13	2	330 M	3 MB	PGA988	35W	KC.33001.DMP
Ci3350M	2.26	2	350 M	3 MB	PGA988	35W	KC.35001.DMP
Ci5430M	2.26	2	430 M	3 MB	PGA988	35W	KC.43001.DMP
Ci5520M	2.24	2	520 M	3 MB	PGA988P	35W	KC.52001.DMP
Ci5540M	2.53	2	540 M	3 MB	PGA988	35W	KC.54001.DMP
Ci7620M	2.66	2	620 M	4 MB	PGA988P	35W	KC.62001.DMP

CPU Fan True Value Table (Tj = 100)

CPU Temp (°C)	Fan Speed (rpm)	SPL Spec (dBA)
45	2500	31
55	3100	34
65	3500	38
75	3900	40
85	4200	

- OS Shutdown: 105°C
- H/W Shutdown: 110°C

CPU Fan True Value Table (Tj = 90)

CPU Temp (°C)	Fan Speed (rpm)	SPL Spec (dBA)
45	2500	31
55	3100	34
65	3500	38
75	3900	40
85	4200	

- OS Shutdown: 95°C
- H/W Shutdown: 100°C

BIOS

Item	Specification
BIOS vendor	Insyde BIOS
BIOS Version	1.00
BIOS ROM type	Flash

Item	Specification
Features	<ul style="list-style-type: none"> Flash ROM 4MB Support ISIPP Support Acer UI Support multi-boot Suspend to RAM (S3)/Disk (S4) Various hot-keys for system control Support SMBIOS 2.3, PCI2.2. Refer to Acer BIOS specification. DMI utility for BIOS serial number configurable/asset tag Support PXE Support Y2K solution Support WinFlash Wake on LAN from S3 Wake on LAN form S4 in AC mode System information

System Memory

Item	Specification
Memory size	8GB maximum
DIMM socket number	2
Supports memory size per socket	4GB
Supports DIMM type	204-pin +1.5V DDRIII
Supports DIMM Speed	400/533/667 MHz
Supports DIMM voltage	1.5V

Memory Combinations

Slot 1	Slot 2	Total Memory
0MB	1024MB	1024MB
0MB	2048MB	2048MB
0MB	4096MB	4096MB
1024MB	0MB	1024MB
1024MB	512MB	1536MB
1024MB	1024MB	2048MB
1024MB	2048MB	3072MB
2048MB	0MB	2048MB
2048MB	512MB	2560MB
2048MB	1024MB	3072MB
2048MB	2048MB	4096MB
2048MB	4096MB	6144MB
4096MB	4096MB	8192MB

NOTE: Above table lists some system memory configurations. You may combine DIMMs with various capacities to form other combinations. On above table, the configuration of slot 1 and slot 2 could be reversed.

Wireless Module

Item	Specification
Manufacturer	<ul style="list-style-type: none"> Intel® WiFi Link 1000

Item	Specification
Specifications	<ul style="list-style-type: none"> • IEEE 802.11b/g and Draft-N1 compliant • Advanced security via 802.11i • Industry-leading power consumption • Includes Wi-Fi PAN – Intel® My WiFi Technology • Easy to use Intel® PROSet v12.5 WLAN Software • Advanced IT capabilities with Intel® PROSet Software4 • Support for Cisco Compatible Extensions* v4 • Connect with Intel® Centrino® program eligible

LAN Module

Item	Specification
Chipset	<ul style="list-style-type: none"> • Atheros AR8151L GbE LAN Controller with Integrated Transceiver
Specifications	<ul style="list-style-type: none"> • Integrated PHY for 10/100/1000 Mbps • Supports automatic MDI/MDIX functions • PCI Express base 1.1 compliant • Wake on LAN support • 256 byte memory (using eFuse) embedded on chip • Supports up to 25% over-clocking without requiring BIOS support • Supports Energy Star 5.0 • Small footprint 40-pin QFN (5 x 5 mm) package with dramatically improved thermal and electrical characteristics over LQFP packaging

Bluetooth

Item	Specification
Chipset	T60H928.33 miniUSB module
Features	<ul style="list-style-type: none"> • Bluetooth 1.2 qualified Embedded USB Module • Bluetooth 2.1 available in the 2.4GHz (ISM) band - supports Enhanced Data Rate (EDR) • USB 2.0 full-speed compliant interface • Support Enhanced data rate (EDR) • Support for A2DP
Specifications	<ul style="list-style-type: none"> • Radio Technology FHSS • Operating Frequency 2.402GHz ~ 2.480GHz • Channel Numbers 79 channels with 1MHz BW • Transmitter Output Power -6~-4dBm output power for BT class 2 operation • Coverage 10m (Varies depending on operating environment) • Receiver Sensitivity -75dBm, BER<0.1% • Maximum Receiver Signal -10dBm • Interface USB2.0 with 8 pin narrow pitch connector

Hard Disk Drive Interface

Item	Specification			
Vendor & Model Name	Seagate	HGST	Toshiba	Western Digital
Capacity (MB)	160, 250, 320, 500	160, 250, 320, 500	160, 250, 320, 500	160, 250, 320, 500, 640
Bytes per sector	512			
Data heads	2-4			
Drive Format				
Disks	1-2			
Spindle speed (RPM)	5400			
Performance Specifications				
Buffer size	8 MB			
Interface	SATA			
DC Power Requirements				
Voltage tolerance	5V \pm 5%	5V \pm 5%	5V \pm 5%	5V \pm 5%

Super-Multi Drive Module

Item	Specification			
Vendor & model name	HLDS GT20N		Sony AD7580S	
Performance Specification	With CD Diskette	With DVD Diskette	With CD Diskette	With DVD Diskette
Transfer rate (MB/sec)	Sustained: 3,600 KB/s (24x) max.	Sustained: 11.08 Mbytes/s (8x) max.	Sustained: 1,571 (typical)	Sustained: 10,993 (typical)
Buffer Memory	2 MB			
Interface	SATA			

Item	Specification	
Applicable disc formats	DVD-ROM: 4.7GB (Single Layer) 8.5GB (Dual Layer) DVD-R: 3.95GB (Ver. 1.0: read only) 4.7GB (Ver. 2.0 for Authoring: read only) 4.7GB (Ver. 2.1 for General: read & write) (DL) 8.5GB (Ver. 3.0) DVD-RW: 4.7GB (Ver. 1.2/ Rev 1.0, 2.0, 3.0) DVD-RAM: 1.46GB/side, 4.7GB/side (Ver. 2.2) DVD+R: 4.7GB (Ver. 1.3) (DL) 8.5GB (Ver. 1.1) DVD+RW: 4.7GB (Vol.1 Ver.1.3) CD-ROM Mode-1 data disc CD-ROM Mode-2 data disc CD-ROM XA, CD-I, Photo-CD Multi-Session, Video CD CD-Audio Disc Mixed mode CD-ROM disc (data and audio) CD-Extra CD-Text CD-R (Conforming to "Orange Book Part 2": read & write) CD-RW (Conforming to "Orange Book Part 3": read & write)	DVD Read: DVD-ROM (DVD-5, DVD-9, DVD-10, DVD-18), DVD-Video, DVD-Audio, SACD (Hybrid), UDF DVD, DVD-R, DVD-R DL, DVD-R 3.95 GB, DVD-R Authoring, DVD-R Multi-Border, DVD-RW, DVD+R, DVD+R DL, DVD+R Multi-Session, DVD+RW, DVD-RAM V1.0, DVDRAM V2.0 & 2.1 & 2.2. CD Read: CD-DA, CD-ROM Mode-1, CD-ROM/XA Mode-2 Form-1 and Mode-2 Form-2, CD-i, CD-i Bridge, Video-CD (MPEG-1), Karaoke CD, Photo-CD, Enhanced CD, CD Plus, CD Extra, itrax CD, CD-Text, UDF CD, CD-R, and CD-RW DVD Write: DVD Data & Video CD Read: CD-DA, CD-ROM Mode-1, CD-ROM/XA Mode-2 Form-1 and Mode-2 Form-2, CD-i, Video-CD, CD-Text
Loading mechanism	Drawer (Solenoid Open) Tact SW (Open) Emergency Release (draw open hole)	
Power Requirement		
Input Voltage	DC 5 V +/- 5%	

Audio Interface

Item	Specification
Chipset	Realtek ALC271X high definition audio codec with embedded class-D speaker amplifier

Item	Specification
Features	<ul style="list-style-type: none"> • 98dB Signal-to-Noise Ratio (A-weighting) for DAC output • 90dB Signal-to-Noise Ratio (A-weighting) for ADC input Internal Digital • Power support: 3.3V digital core power; 1.5V~3.3V digital IO power for HDA link; 3.0V~5.0V analog power; 3.0V~5.0V power stage voltage • Microphone Acoustic Echo Cancellation (AEC), Noise Suppression (NS), and Beam Forming (BF) technology for voice application • Stereo Bridge-Tied Load Class-D amplifier at port-D has 2Watt (rms)/4amps per channel output • Analog Microphone • Headphone with SPDIF jack • 48-pin QFN 'Green' package

Power and Keyboard Controller

Item	Specification
Controller	ACPI 2.0
Total number of keypads	99-/100-/103-key keyboard
Windows logo key	Yes
Hotkeys	See "Hot Keys" on page 16.

Battery

Item	Specification
	6 Cell
Vendor & model name	SANYO/SONY/PANASONIC/SAMSUNG/SIMPLO AS2009A
Battery Type	Li-ion
Pack capacity	4400 mAh
Normal Voltage	2.2 Ah
Package configuration	3S2P

LCD

Item	Specification
Vendor/model name	AUO/CPT/CMO/Samsung/LCD/INL
Screen Diagonal (in)	14"
Display resolution (pixels)	1366 x 768 WXGA Clare
Pixel Pitch	0.204 x 0.204
Display Mode	Normal
Typical White Luminance (cd/m ²) (also called Brightness)	220
Contrast Ratio	500 typical
Response Time (Optical Rise Time/Fall Time) msec	8
Luminance Uniformity	1.25 max
Electrical Interface	LVDS
Support Color	262K
Viewing Angle (up/down/right/left)	15/35/45/45

Item	Specification
Temperature Range (°C) Operating Storage (shipping)	0 to +50 -20 to +60

Card Reader

Item	Specification
Part Name	RealTek RT5160
Package	5-in-1 card reader
General Features	<ul style="list-style-type: none">• PCI-E interface• Push-push type• Dummy card

System Utilities

BIOS Setup Utility

The BIOS Setup Utility is a hardware configuration program built into your computer's BIOS (Basic Input/Output System).

Your computer is already properly configured and optimized, and you do not need to run this utility. However, if you encounter configuration problems, you may need to run Setup. Please also refer to Chapter 4 Troubleshooting when problem arises.

To activate the BIOS Utility, press **F2** during POST (when "Press <F2> to enter Setup" message is prompted on the bottom of screen).

The default parameter of F12 Boot Menu is set to "disabled". If you want to change boot device without entering BIOS Setup Utility, please set the parameter to "enabled".

Press <F12> during POST to enter multi-boot menu. In this menu, user can change boot device without entering BIOS SETUP Utility.

Navigating the BIOS Utility

There are six menu options: Information, Main, Advanced, Security, Boot, and Exit.

Follow these instructions:

- To choose a menu, use the left and right arrow keys.
- To choose an item, use the up and down arrow keys.
- To change the value of a parameter, press **F5** or **F6**.
- A plus sign (+) indicates the item has sub-items. Press **Enter** to expand this item.
- Press **Esc** while you are in any of the menu options to go to the Exit menu.
- In any menu, you can load default settings by pressing **F9**. You can also press **F10** to save any changes made and exit the BIOS Setup Utility.

NOTE: You can change the value of a parameter if it is enclosed in square brackets. Navigation keys for a particular menu are shown on the bottom of the screen. Help for parameters are found in the Item Specific Help part of the screen. Read this carefully when making changes to parameter values. **Please note that system information varies with different models.**

Aspire 4820T BIOS

Information

The Information screen displays a summary of your computer hardware information.

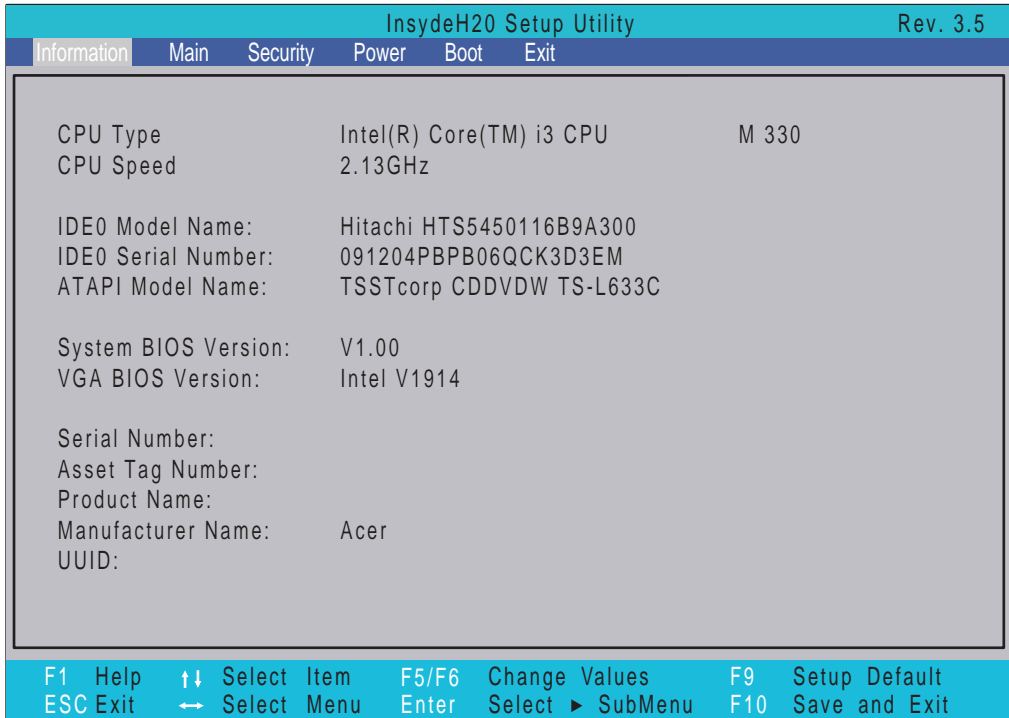

NOTE: The screen above is for your reference only. Actual values may differ according to model.

The table below describes the parameters in this screen.

Parameter	Description
CPU Type	This field shows the CPU type and speed of the system.
CPU Speed	This field shows the speed of the CPU.
HDD Model Name	This field shows the model name of HDD installed on primary IDE master.
HDD Serial Number	This field displays the serial number of HDD installed on primary IDE master.
ATAPI Model Name	This field shows the model name of the Optical device installed in the system.
System BIOS Version	Displays system BIOS version.
VGA BIOS Version	This field displays the VGA firmware version of the system.
Serial Number	This field displays the serial number of this unit.
Asset Tag Number	This field displays the asset tag number of the system.
Product Name	This field shows product name of the system.
Manufacturer Name	This field displays the manufacturer of this system.
UUID	Universally Unique Identifier (UUID) is an identifier standard used in software construction, standardized by the Open Software Foundation (OSF) as part of the Distributed Computing Environment (DCE).

Main

The Main screen allows the user to set the system time and date as well as enable and disable boot option and recovery.

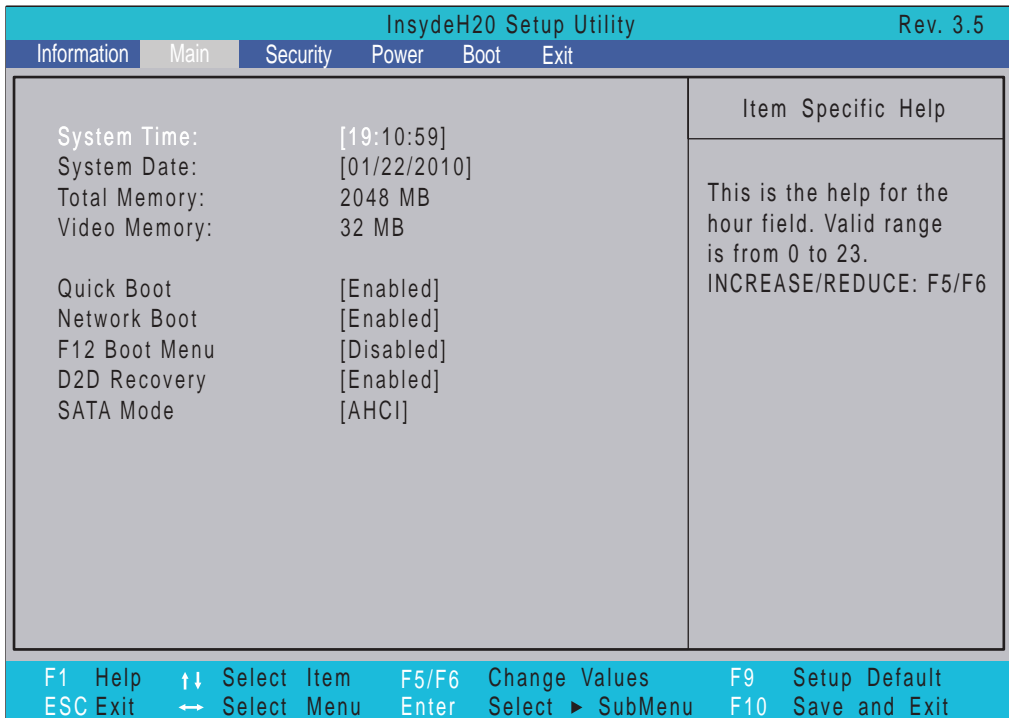

NOTE: The screen above is for your reference only. Actual values may differ.

The table below describes the parameters in this screen.

Parameter	Description	Format/Option
System Time	Sets the system time. The hours are displayed with 24-hour format.	Format: HH:MM:SS (hour:minute:second)
System Date	Sets the system date.	Format MM/DD/YYYY (month/day/year)
Total Memory	Displays the total memory available.	N/A
Video Memory	Displays the available memory for Video.	N/A
Quick Boot	Allows startup to skip certain tests while booting, decreasing the time needed to boot the system.	Option: Enabled or Disabled
Network Boot	Enables, disables the system boot from LAN (remote server).	Option: Enabled or Disabled
F12 Boot Menu	Enables, disables Boot Menu during POST.	Option: Enabled or Enabled
D2D Recovery	Enables, disables D2D Recovery function. The function allows the user to create a hidden partition on hard disc drive to store operation system and restore the system to factory defaults.	Option: Enabled or Disabled
SATA Mode	Control the mode in which the SATA controller should operate.	Option: AHCI or IDE

Security

The Security screen contains parameters that help safeguard and protect your computer from unauthorized use.

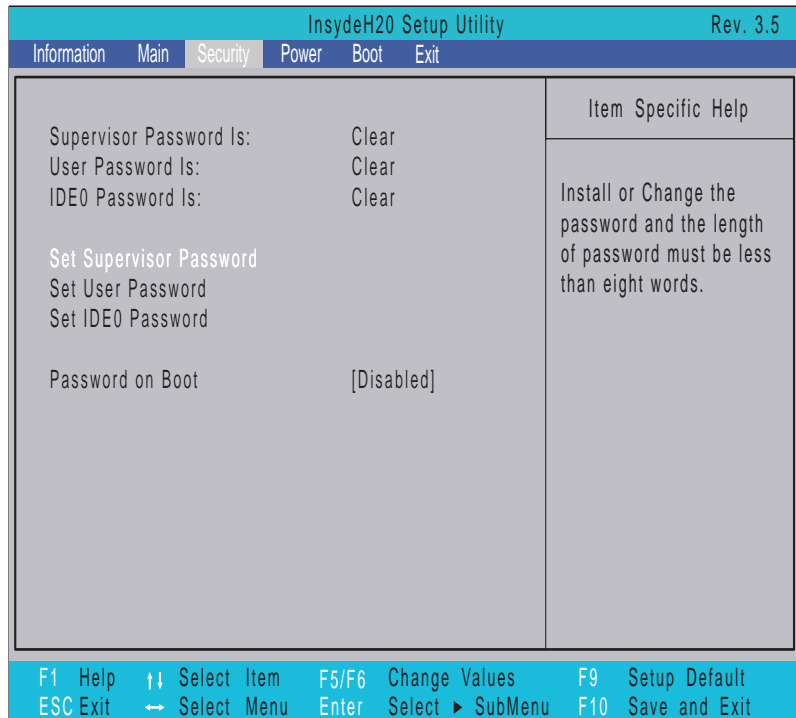

The table below describes the parameters in this screen. Settings in **boldface** are the default and suggested parameter settings.

Parameter	Description	Option
Supervisor Password Is	Shows the setting of the Supervisor password	Clear or Set
User Password Is	Shows the setting of the user password.	Clear or Set
HDD Password Is	Shows the setting of the hard disk password.	Clear or Set
Set Supervisor Password	Press Enter to set the supervisor password. When set, this password protects the BIOS Setup Utility from unauthorized access. The user can not either enter the Setup menu nor change the value of parameters.	N/A
Set User Password	Press Enter to set the user password. When user password is set, this password protects the BIOS Setup Utility from unauthorized access. The user can enter Setup menu only and does not have right to change the value of parameters.	N/A
Set HDD Password	Enter HDD Password.	N/A
Password on Boot	Defines whether a password is required or not while the events defined in this group happened. The following sub-options are all requires the Supervisor password for changes and should be grayed out if the user password was used to enter setup.	Disabled or Enabled

NOTE: When you are prompted to enter a password, you have three tries before the system halts. Don't forget your password. If you forget your password, you may have to return your notebook computer to your dealer to reset it.

Setting a Password

Follow these steps as you set the user or the supervisor password:

1. Use the ↑ and ↓ keys to highlight the Set Supervisor Password parameter and press the **Enter** key. The Set Supervisor Password box appears:

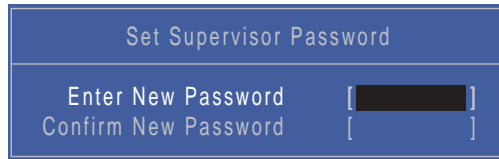

The screenshot shows a blue-bordered window titled "Set Supervisor Password". Inside the window, there are two input fields: "Enter New Password" and "Confirm New Password". Both fields are currently empty and have a black cursor in the first position.

2. Type a password in the "Enter New Password" field. The password length can not exceed 8 alphanumeric characters (A-Z, a-z, 0-9, not case sensitive). Retype the password in the "Confirm New Password" field.

IMPORTANT: Be very careful when typing your password because the characters do not appear on the screen.

3. Press **Enter**. After setting the password, the computer sets the User Password parameter to "Set".
4. If desired, you can opt to enable the Password on boot parameter.
5. When you are done, press F10 to save the changes and exit the BIOS Setup Utility.

Removing a Password

Follow these steps:

1. Use the ↑ and ↓ keys to highlight the Set Supervisor Password parameter and press the **Enter** key. The Set Password box appears:



The screenshot shows a blue-bordered window titled "Set Supervisor Password". Inside the window, there are three input fields: "Enter Current Password", "Enter New Password", and "Confirm New Password". The "Enter Current Password" field is currently empty and has a black cursor in the first position. The "Enter New Password" and "Confirm New Password" fields are also empty.

2. Type the current password in the Enter Current Password field and press **Enter**.
3. Press **Enter** twice **without** typing anything in the Enter New Password and Confirm New Password fields. The computer then sets the Supervisor Password parameter to "Clear".
4. When you have changed the settings, press u to save the changes and exit the BIOS Setup Utility.

Changing a Password

1. Use the ↑ and ↓ keys to highlight the Set Supervisor Password parameter and press the **Enter** key. The Set Password box appears.



The screenshot shows a blue-themed BIOS screen titled "Set Supervisor Password". It contains three input fields, each with a cursor and a pair of square brackets: "Enter Current Password", "Enter New Password", and "Confirm New Password".

2. Type the current password in the Enter Current Password field and press **Enter**.
3. Type a password in the Enter New Password field. Retype the password in the Confirm New Password field.
4. Press **Enter**. After setting the password, the computer sets the User Password parameter to "Set".
5. If desired, you can enable the Password on boot parameter.
6. When you are done, press F10 to save the changes and exit the BIOS Setup Utility.

If the verification is OK, the screen will display as following.

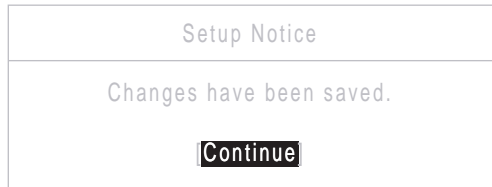

The screenshot shows a white BIOS screen titled "Setup Notice". The text "Changes have been saved." is displayed in the center. Below the text is a black button with the word "Continue" in white.

The password setting is complete after the user presses **Enter**.

If the current password entered does not match the actual current password, the screen will show you the Setup Warning.



The screenshot shows a white BIOS screen titled "Setup Warning" in red text. Below the title, the text "Invalid Password." is displayed in red. At the bottom center is a black button with the word "Continue" in white.

If the new password and confirm new password strings do not match, the screen will display the following message.



The screenshot shows a white BIOS screen titled "Setup Warning" in red text. Below the title, the text "Passwords do not match. Re-enter password." is displayed in red. At the bottom center is a black button with the word "Continue" in white.

Boot

This menu allows the user to decide the order of boot devices to load the operating system. Bootable devices includes the USB diskette drives, the onboard hard disk drive and the DVD drive in the module bay.

Select Boot Devices to select specific devices to support boot.

InsydeH20 Setup Utility				Rev. 3.5	
Information	Main	Security	Power	Boot	Exit
Boot priority order:				Item Specific Help	
1. IDE0 : Hitachi HTS545016B9A300				Use <↑> or <↓> to select a device, then press <F5> to move it down the list, or <F6> to move it up the list. Press <Esc> to escape the menu	
2. IDE1 : TSSTcorp CDDVDW TS-L633C					
3. USB FDD :					
4. Network Boot : Atheros Boot Agent					
5. USB HDD :					
6. USB CDROM :					
F1 Help	↑↓ Select Item	F5/F6 Change Values	F9 Setup Default		
ESC Exit	←→ Select Menu	Enter Select ► SubMenu	F10 Save and Exit		

Exit

The Exit screen allows you to save or discard any changes you made and quit the BIOS Utility.

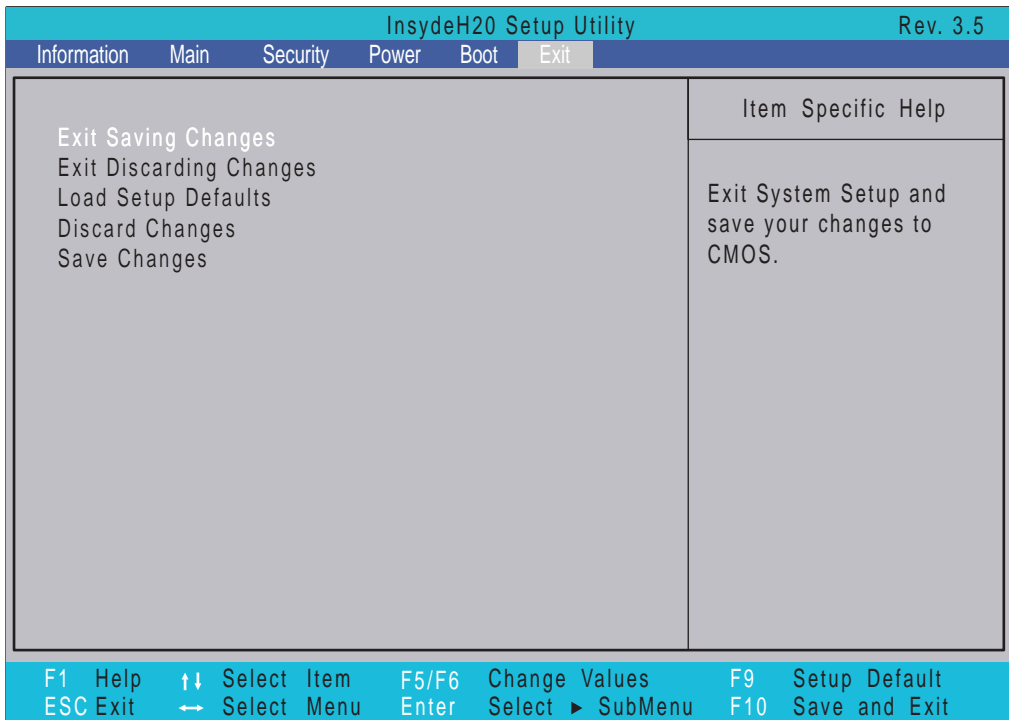

The table below describes the parameters in this screen.

Parameter	Description
Exit Saving Changes	Exit System Setup and save your changes to CMOS.
Exit Discarding Changes	Exit utility without saving setup data to CMOS.
Load Setup Default	Load default values for all SETUP item.
Discard Changes	Load previous values from CMOS for all SETUP items.
Save Changes	Save Setup Data to CMOS.

BIOS Flash Utilities

The BIOS flash memory update is required for the following conditions:

- New versions of system programs
- New features or options
- Restore a BIOS when it becomes corrupted.

Use the Flash utility to update the system BIOS flash ROM.

NOTE: If you do not have a crisis recovery diskette at hand, then you should create a **Crisis Recovery Diskette** before you use the Flash utility.

NOTE: Do not install memory-related drivers (XMS, EMS, DPMI) when you use the Flash.

NOTE: Please use the AC adaptor power supply when you run the Flash utility. If the battery pack does not contain enough power to finish BIOS flash, you may not boot the system because the BIOS is not completely loaded.

Follow the steps below to run the Flash.

1. Prepare a bootable diskette.
2. Copy the flash utilities to the bootable diskette.
3. Then boot the system from the bootable diskette. The flash utility has auto-execution function.

DOS Flash Utility

Perform the following steps to use the DOS Flash Utility:

1. Press F2 during boot to enter the Setup Menu.
2. Select **Boot Menu** to modify the boot priority order, for example, if using USB HDD to Update BIOS, move USB HDD to position 1.

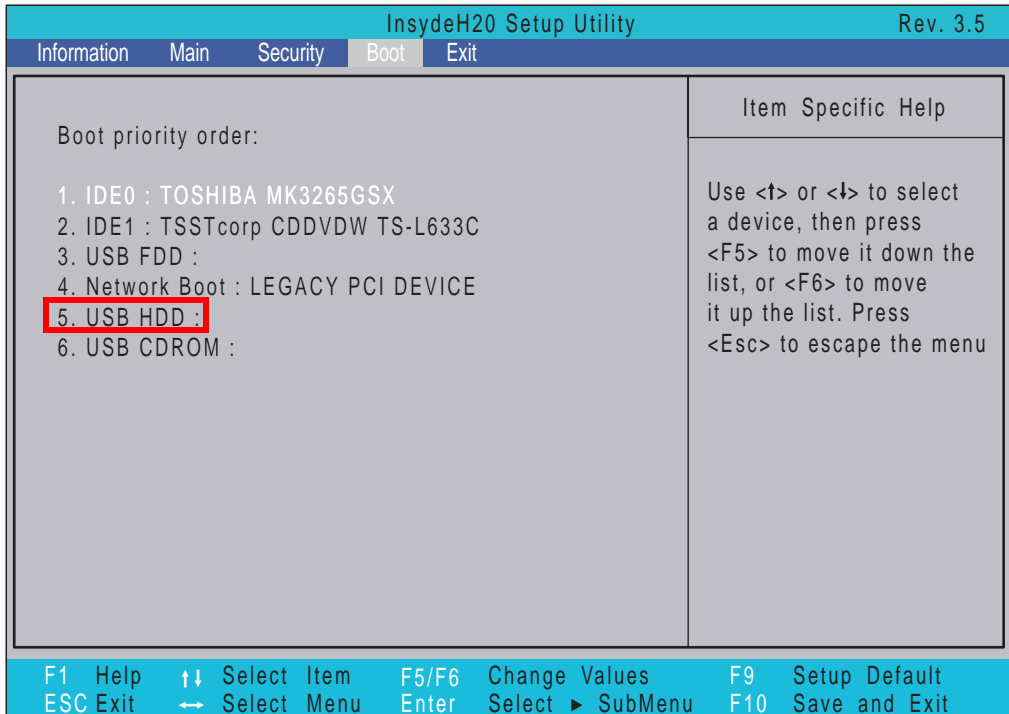

3. Execute the **BIOS.BAT** batch file to update BIOS.

The flash process begins as shown.



4. In flash BIOS, the message **Please do not remove AC Power Source** displays.

NOTE: If the AC power is not connected, the following message displays.



Plug in the AC power to continue.

5. Flash is complete when the message Flash programming complete displays.

WinFlash Utility

Perform the following steps to use the WinFlash Utility:

1. Double-click the WinFlash executable.
2. Click **OK** to begin the update. A progress screen displays.

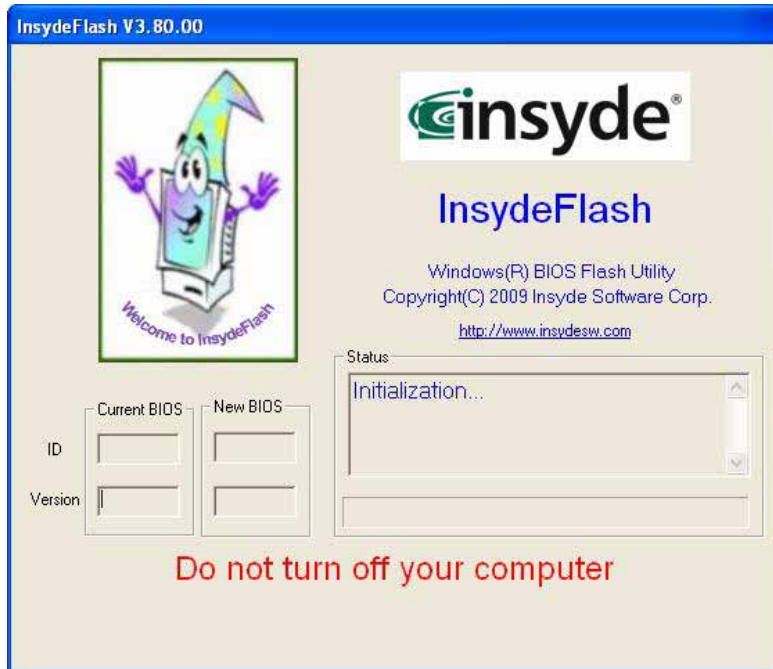

Remove HDD/BIOS Password Utilities

This section provides you with details about removing HDD/BIOS password:

Remove HDD Password:

If you key in the wrong HDD password three times, an error is generated.



To reset the HDD password, perform the following steps:

1. On another computer, run HDD_PW.exe.
2. Enter "hdd_pw 15494 0"
3. Chose one (1) or the generated passwords.



4. Reboot the locked computer and key in one of the passwords from number 3 above.



Removing BIOS Passwords:

To clear the User or Supervisor passwords, open the DIMM door and use a metal instrument to short the **J1** and **J2** points.

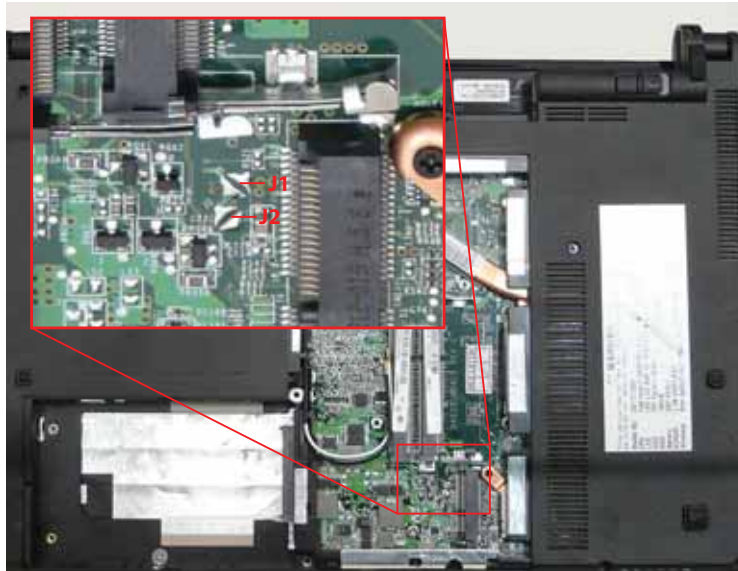

Cleaning BIOS Passwords

To clean the User or Supervisor passwords, perform the following steps:

1. From a DOS prompt, execute **clnpwd.exe**
2. Press **1** or **2** to clean the desired password shown on the screen.

```
d:\Clnpwd>clnpwd
ACER Clean Password Utility V1.00
Press 1 or 2 to clean any password shown as below
  1.User Password
  2.Supervisor Password

Clean User Password Successfully!
```

The onscreen message determines whether the function is successful or not.

Using Boot Sequence Selector

The Boot Sequence Selector allows the boot order to be changed without accessing the BIOS. To use Boot Sequence Selector, perform the following steps:

1. Enter into DOS.
2. Execute **BS.exe** to display the usage screen.

```
d:\BOOTSEQ>bs

*** Boot Sequence Selector Version 0.03 ***
Create by Rockwell Chuang 10/01/2005.

Usage:
      BS [ 1 | 2 | 3 | 4 ]

BS 1 : [ Floppy ] => [ HardDisk ] => [ CD-ROM ] => [ LAN ]
BS 2 : [ HardDisk ] => [ CD-ROM ] => [ LAN ] => [ Floppy ]
BS 3 : [ CD-ROM ] => [ HardDisk ] => [ LAN ] => [ Floppy ]
BS 4 : [ LAN ] => [ Floppy ] => [ HardDisk ] => [ CD-ROM ]

d:\BOOTSEQ>
```

3. Select the desired boot sequence by entering the corresponding sequence. For example, enter **BS2** to change the boot sequence to HDD | CD ROM | LAN | Floppy.

Using DMITools

The DMI (Desktop Management Interface) Tool copies BIOS information to EEPROM to be used in the DMI pool for hardware management.

When the BIOS displays **Verifying DMI pool data** it is checking that the table correlates with the hardware before sending to the operating system (Windows, etc.).

To update the DMI Pool, perform the following steps:

1. Boot into DOS.
2. Execute **dmitools**. The following messages report to screen to confirm completion:
 - `dmitools /r ==>` Read dmi string from bios
 - `dmitools /wm xxxx ==>` Write manufacturer name to eeprom (max. 16 characters)
 - `dmitools /wp xxxx ==>` Write product name to eeprom (max. 16 characters)
 - `dmitools /ws xxxx ==>` Write serial number to eeprom (max. 22 characters)
 - `dmitools /wu xxxx ==>` Write uuid to eeprom
 - `dmitools /wa xxxx ==>` Write asset tag to eeprom (max. 32 characters)

The following examples show the commands and the corresponding output information.

Read DMI Information from Memory

Input:

```
dmitools /r
```

Output:

```
Manufacturer (Type1, Offset04h): Acer
Product Name (Type1, Offset05h): TravelMate xxxxx
Serial Number (Type1, Offset07h): 01234567890123456789
UUID String (Type1, Offset08h): xxxxxxxx-xxxx-xxxx-xxxx-xxxxxxxxxxxx
Asset Tag (Type3, Offset04h): Acet Asstag
```

Write Product Name to EEPROM

Input:

```
dmitools /wp Acer
```

Write Serial Number to EEPROM

Input:

```
dmitools /ws 01234567890123456789
```

3. Write UUID to EEPROM (Create UUID from Intel WFM20.pdf)

Input:

```
dmitools /wu
```

4. Write Asset Tag to EEPROM

Input:

```
dmitools /wa Acet Asstag
```

NOTE: When using any of the Write options, restart the system to make the new DMI data effective.

Using the LAN MAC EEPROM Utility

You can use the MAC.BAT utility to write the MAC.CFG file to the EEPROM in DOS mode.

1. Use a text editor to open the MAC.CFG file. You can see the MAC.CFG contents as shown:



```
MAC.CFG - 記事本
檔案(F) 編輯(E) 格式(O) 檢視(V) 說明(H)
Title= MAC Address byte
WriteData='001122334455'
StartAddr=7A
WriteLeng=6
KeepByte=0
```

WriteData = '001122334455'	MAC value
StartAddr=7A	MAC address
WriteLeng=6	MAC value length
KeepByte=0	don't care

2. In DOS mode, run the **MAC.BAT** file to write MAC values to eeprom.

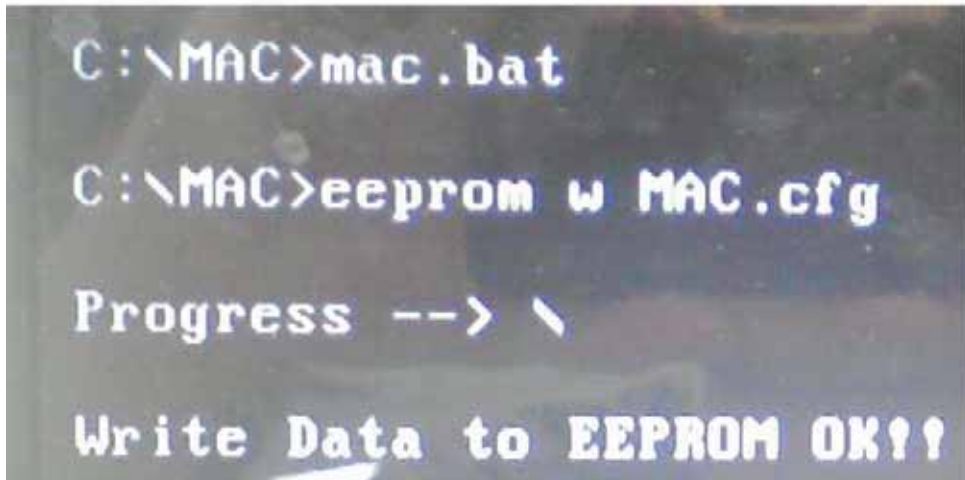

```
C:\MAC>mac.bat
C:\MAC>eeprom w MAC.cfg
Progress --> \
Write Data to EEPROM OK!!
```

Machine Disassembly and Replacement

IMPORTANT: The outside housing and color may vary from the mass produced model.

This chapter contains step-by-step procedures on how to disassemble the notebook computer for maintenance and troubleshooting.

Disassembly Requirements

To disassemble the computer, you need the following tools:

- Wrist grounding strap and conductive mat for preventing electrostatic discharge
- Flat screwdriver
- Philips screwdriver
- Plastic flat screwdriver
- Plastic tweezers

NOTE: The screws for the different components vary in size. During the disassembly process, group the screws with the corresponding components to avoid mismatch when putting back the components.

General Information

Pre-disassembly Instructions

Before proceeding with the disassembly procedure, make sure that you do the following:

1. Turn off the power to the system and all peripherals.
2. Unplug the AC adapter and all power and signal cables from the system.



3. Place the system on a flat, stable surface.
4. Remove the battery pack.

Disassembly Process

The disassembly process is divided into the following stages:

- External module disassembly
- Main unit disassembly

The flowcharts provided in the succeeding disassembly sections illustrate the entire disassembly sequence. Observe the order of the sequence to avoid damage to any of the hardware components. For example, if you want to remove the mainboard, you must first remove the keyboard, then disassemble the inside assembly frame in that order.

Main Screw List

Screw	Quantity	Part Number
M2.5*3	4	86.TPK07.003
M2.0*3L	6	86.PSR07.003
M2.5*2L	1	86.PSR07.002
M2.0*3	5	86.ARE07.002
M2.5*6.5	14	86.ARE07.001
M2.5*4L	15	86.PSR07.001
M3.0*4L	2	86.N1407.007
M2.0*3widehead	6	86.W4107.002

External Module Disassembly Process

IMPORTANT:The outside housing and color may vary from the mass produced model.

External Modules Disassembly Flowchart

The flowchart below gives you a graphic representation on the entire disassembly sequence and instructs you on the components that need to be removed during servicing. For example, if you want to remove the main board, you must first remove the keyboard, then disassemble the inside assembly frame in that order.

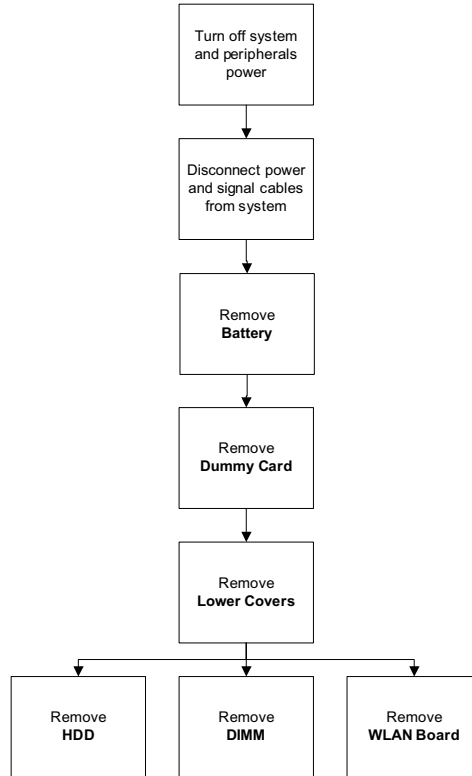

Screw List

Step	Screw	Quantity	Part No.
ODD Module	M2.5*4L	1	86.PSR07.001
ODD Bracket	M2.0*3L	2	86.PSR07.003
WLAN Module	M2.0*3L	1	86.PSR07.003
HDD Carrier	M3.0*4L	2	86.N1407.007

Removing the Battery Pack

1. Turn computer over. Slide the battery lock in the direction shown.



2. Slide and hold the battery release latch to the release position (1), then lift out the battery pack from the main unit (2).



Please detach the battery and follow local regulations for disposal.

Removing the SD dummy card

1. Push the SD dummy card all the way in to eject it.



2. Pull it out from the slot.



Removing the SIM card

1. Push the 3G card all the way in to eject it.



2. Pull it out from the slot.



Removing the Lower Cover

1. See "Removing the Battery Pack" on page 46.
2. Loosen the five (5) captive screws from the lower cover.



3. Remove the lower cover as shown.



Removing the Optical Drive Module

1. See "Removing the Lower Cover" on page 49.
2. Remove the screw securing the ODD module.



Step	Size	Quantity	Screw Type
ODD Module	M2.5*4L	1	

3. Using your fingers, pull the optical drive module out from the chassis.



4. Remove the two screws securing the ODD bracket and remove the ODD bracket from the optical disk drive module.



Step	Size	Quantity	Screw Type
ODD Bracket	M2.0*3L	2	

5. Remove the ODD bezel by rotating the top edge downward and pulling it clear of the module.



Removing the DIMM Modules

1. See "Removing the Lower Cover" on page 49.
2. Push out the release latches on both sides of the DIMM socket to release the DIMM module.

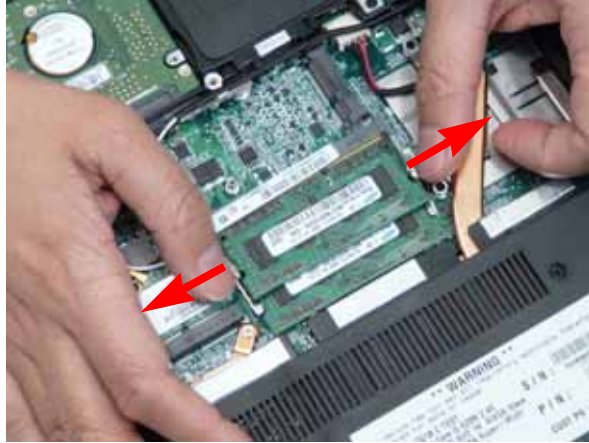

3. Remove the DIMM module.



4. Repeat steps for the second DIMM module if present.

Removing the WLAN Module

1. See "Removing the Lower Cover" on page 49.
2. Disconnect the two (2) antenna cables from the WLAN Board and remove the one (1) screw to release the WLAN Board.



NOTE: Cable placement is **Black** to the **TR1** terminal (left) and **White** to the **TR2** terminal (right).

Step	Size	Quantity	Screw Type
WLAN Board	M2.0*3	1	

3. Detach and remove the WLAN Board from the WLAN socket.



Removing the Hard Disk Drive Module

1. See "Removing the Lower Cover" on page 49.
2. Using the pull-tab, slide the HDD Module in the direction of the arrow to disconnect the interface.



3. Lift the HDD Module clear of the HDD bay.



4. Remove the two (2) screws from the carrier.

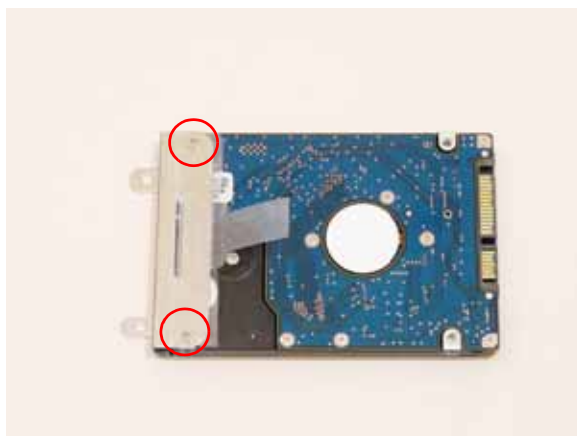

Step	Size	Quantity	Screw Type
HDD Carrier	M3.0*4L	2	

5. Remove the carrier from the HDD.

Main Unit Disassembly Process

Main Unit Disassembly Flowchart



Screw List



Step	Screw	Quantity	Part No.
LCD Module	M2.5*4	2	86.PSR07.001
	M2.0*3	4	86.PSR07.003
	M2.5*3	4	86.PSR07.001
Upper Cover	M2.5*4L	5	86.PSR07.001
	M2.0*3L	3	86.PSR07.001
L. Speaker Module	M2.5*4L	1	86.PSR07.001
L. Speaker Module	M2.0*3widehead	2	86.W4107.002
Switch Board	M2.0*3widehead	2	86.W4107.002
LED Board	M2.0*3widehead	2	86.W4107.002
USB Board	M2.5*4L	1	86.PSR07.001
Mainboard	M2.5*4L	1	86.PSR07.001

Removing the Keyboard

CAUTION: Using metal tools to remove the Keyboard may cause damage to the outer casing. It is recommended that you only use your fingers to remove the Keyboard.

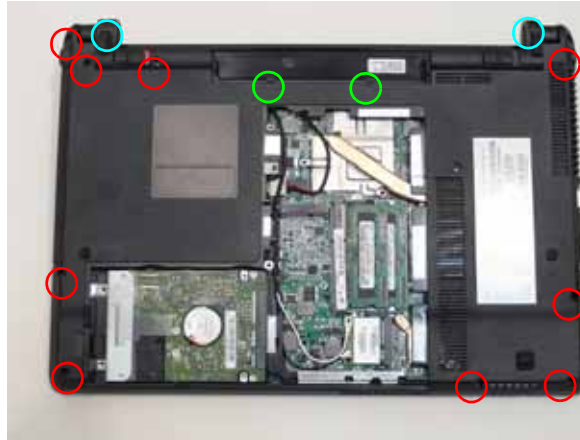
1. See "Removing the Battery Pack" on page 46.
2. Remove the 14 securing screws from the lower cover.



Step	Size	Quantity	Screw Type
Keyboard (red callout)	M2.5*6.5	10	
Keyboard (green callout)	M2.5*4L	2	
Keyboard (blue callout)	M2.0*6L	2	

3. Turn the computer over and fully open the lid. There are five (5) securing clips that must be released in order to remove the keyboard.



4. Release each clip, working from one side to the other.



5. Using both hands, gently pry up the cover as shown and turn it over.



6. Open the locking latch on the FFC, and disconnect the cable as shown.



7. Lift the keyboard clear of the chassis.

Removing the Upper Cover

1. See "Removing the Keyboard" on page 56.
2. Turn the computer over. Disconnect the following four cables from the Mainboard:
 - a. Left speaker cable
 - b. Touchpad FFC
 - c. Power Switch FFC
 - d. Switch Board FFC

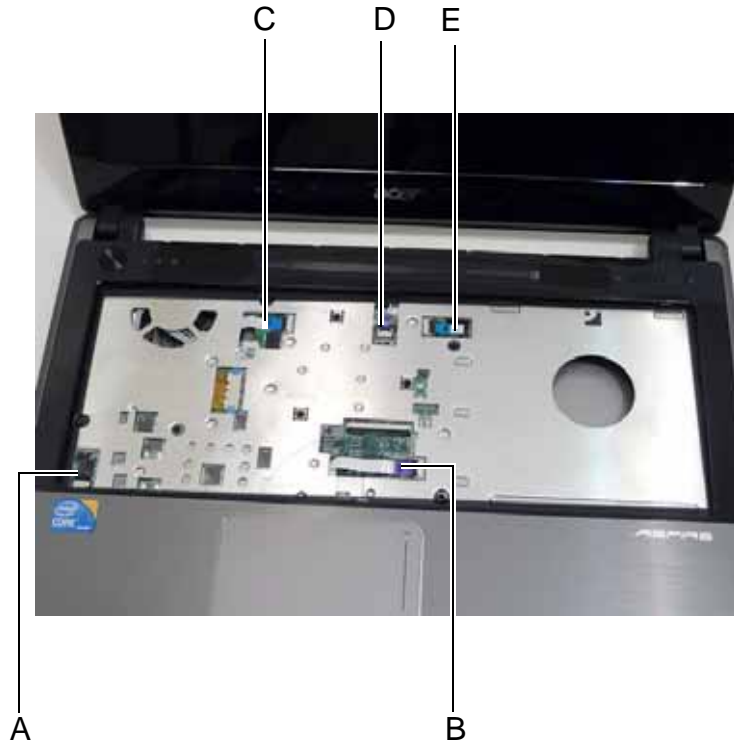

3. Disconnect A as shown.



4. Release the locking latch and remove B as shown.



5. Release the locking latch and remove C as shown.

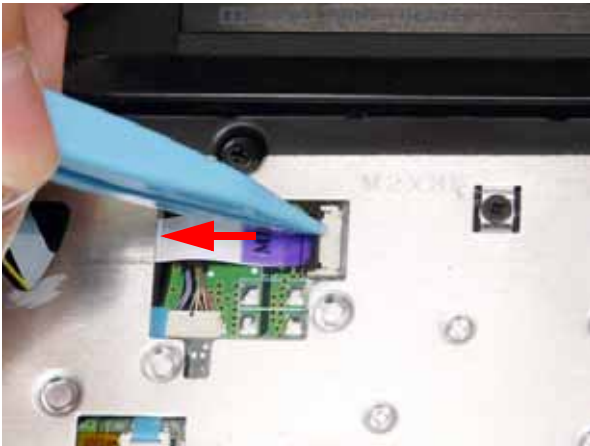

6. Release the locking latch and remove D as shown.



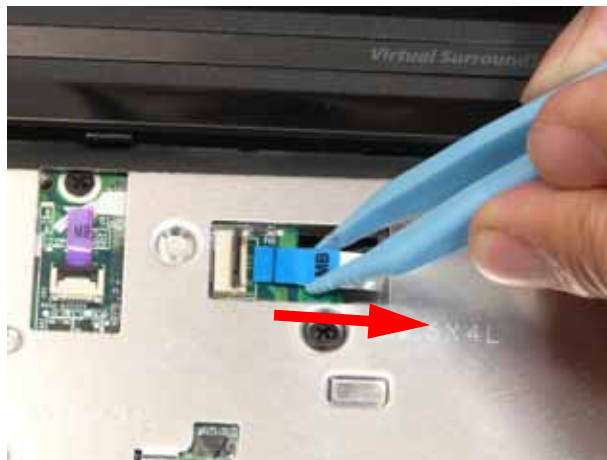

7. Release the locking latch and remove E as shown.



NOTE: Avoid pulling on cables directly to prevent damage to the connectors. Use the pull-tabs on FFC cables whenever available.

8. Remove the eight (8) screws from the top cover.



Step	Size	Quantity	Screw Type
Upper Cover (red callout)	M2.5*3L	3	
Upper Cover (blue callout)	M2.5*4L	5	

9. Remove the Upper Cover by lifting directly upward from the front as shown.



Removing the LED Board

1. See "Removing the Upper Cover" on page 58.
2. Locate the LED Board in the Upper Cover.



3. Release the securing latch holding the LED Board FFC and remove.



4. Remove the two (2) screws and lift the LED Board clear of the Upper Cover.

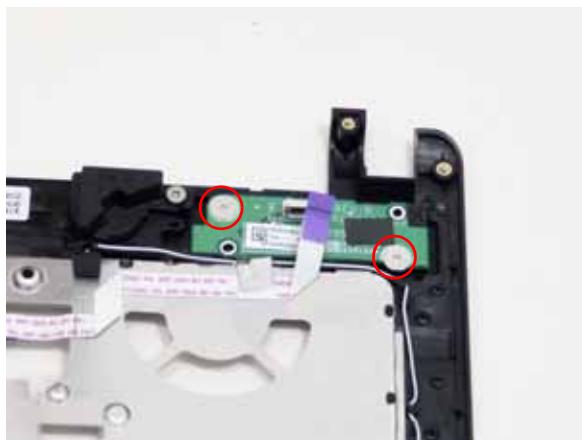

Step	Size	Quantity	Screw Type
LED Board	M2.0*3widehead	2	

Removing the Switch Board

1. See "Removing the Upper Cover" on page 58.
2. Locate the Switch Board in the Upper Cover and remove the two (2) screws attaching it to the upper cover.



Step	Size	Quantity	Screw Type
Switch Board	M2.0*3widehead	2	

3. Lift the Switch Board away from the Upper Cover but do not remove it completely.



4. Turn the Switch board over. Release the securing latch holding the Switch Board FFC and remove.

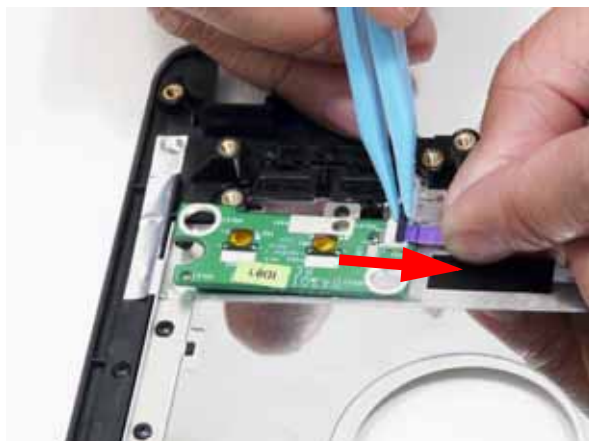

Removing the Left Speaker Module

1. See "Removing the Upper Cover" on page 58.
2. Remove the speaker cable from it's guides.



3. Remove the adhesive foil tab covering the speaker cable and remove the one (1) securing screws from the Speaker Module.



Step	Size	Quantity	Screw Type
Speaker Module	M2.5*4L	1	

4. Lift the Speaker Module clear of the Upper Cover.

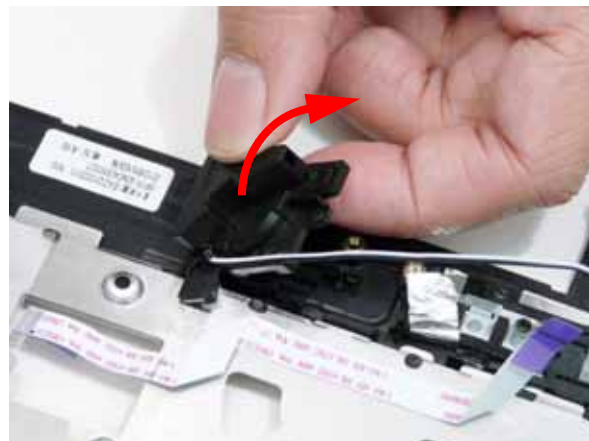

Removing the USB Board

1. See See "Removing the Upper Cover" on page 58.
2. Remove the single securing screw from the USB Board.



Step	Size	Quantity	Screw Type
USB Board	M2.5*4L	1	

3. Release the FFC latch and remove the FFC cable from the mainboard connector.

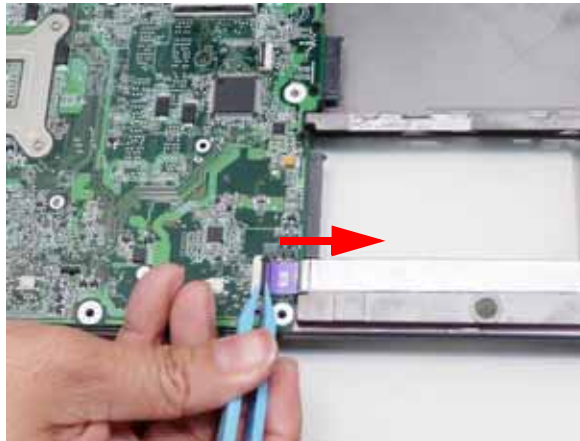

4. Release the FFC latch and remove the FFC cable from the USB connector.



5. Lift the USB Board upward away from the chassis.

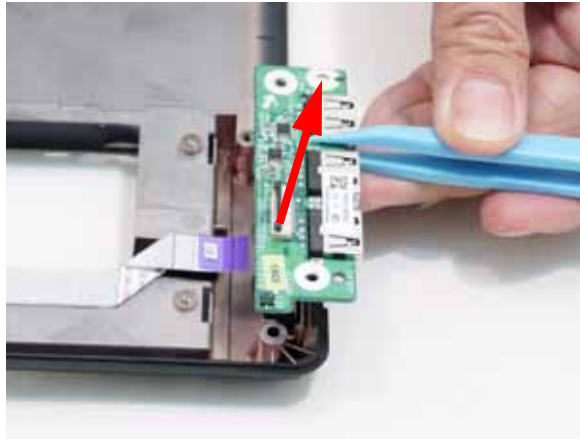

Removing the 3G Module

1. See "Removing the Upper Cover" on page 58.
2. Release the securing latch holding the LED Board FFC and remove.

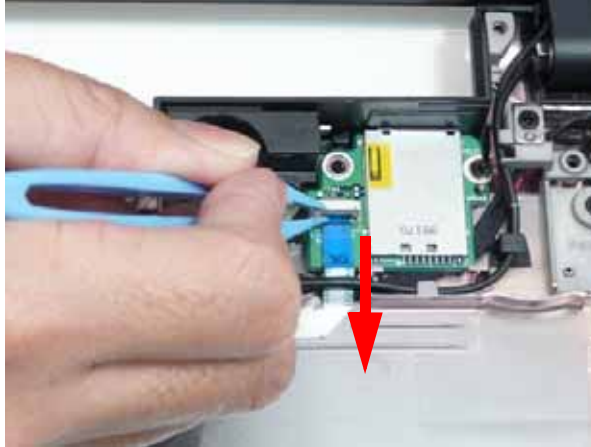

3. Remove the two (2) screws and lift the LED Board clear of the Upper Cover.



Step	Size	Quantity	Screw Type
3G Module	M2.5*4L	1	

Removing the Bluetooth Module

1. See "Removing the Upper Cover" on page 58.
2. Remove the single securing screw from the Bluetooth board.



Step	Size	Quantity	Screw Type
Bluetooth Board	M2.3*3L	1	

3. Disconnect the cable from the Mainboard and lift the Bluetooth Module off the mainboard.



4. Disconnect the cable from the Bluetooth Module.

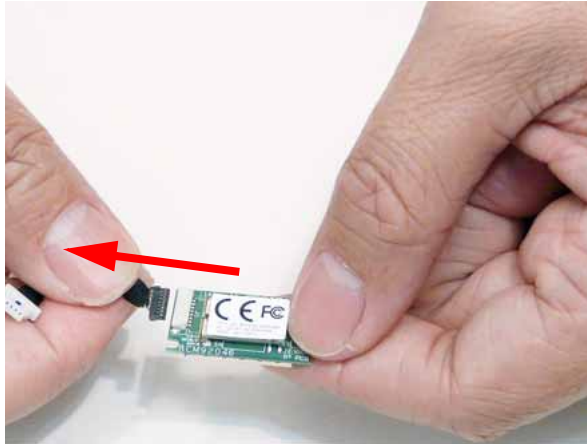

Removing the Mainboard

1. See "Removing the USB Board" on page 64.
2. See "Removing the Bluetooth Module" on page 67.
3. Disconnect the right speaker cable.



4. Remove the adhesive tape holding the LCD cable.



5. Push the side locks to release the cable from the mainboard. Remove LCD cable from fan module.

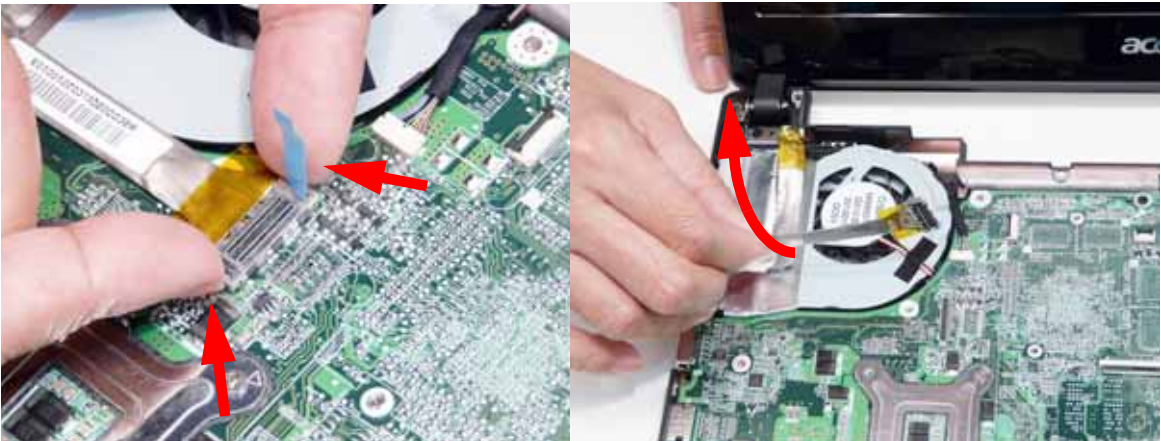

6. Unlock the microphone cable and remove. Release it from the clasp on the cooling fan.

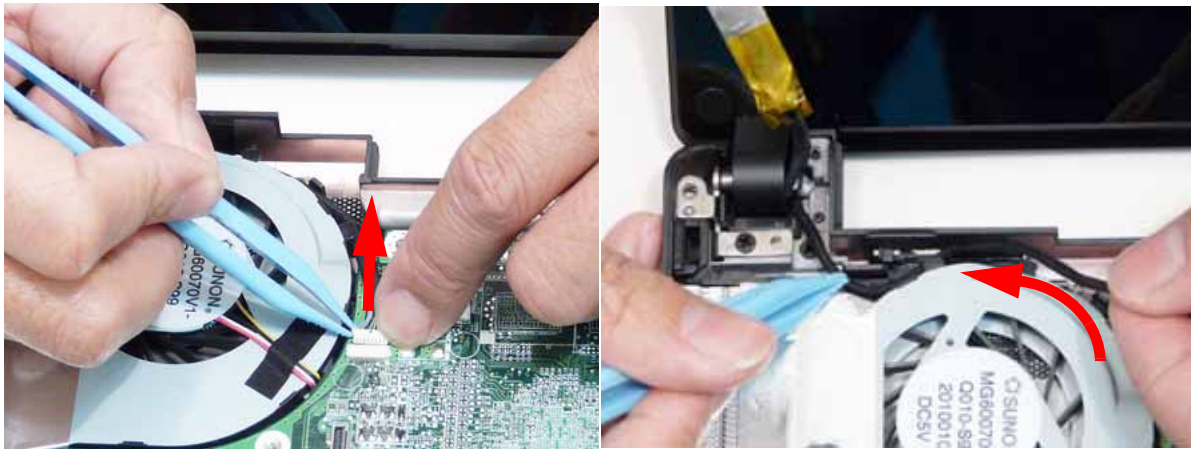

7. Turn the computer over and remove the DC-In cable.



8. Remove the one (1) securing screws from the Mainboard.



Step	Size	Quantity	Screw Type
Mainboard	M2.5*4L	1	

9. Lift the Mainboard right side first and remove it from the Lower Cover.



Please detach the mainboard and follow local regulations for disposal.

Removing the Thermal Module

1. See “Removing the Mainboard” on page 69.
2. Turn the Mainboard over and disconnect the Fan cable as shown.

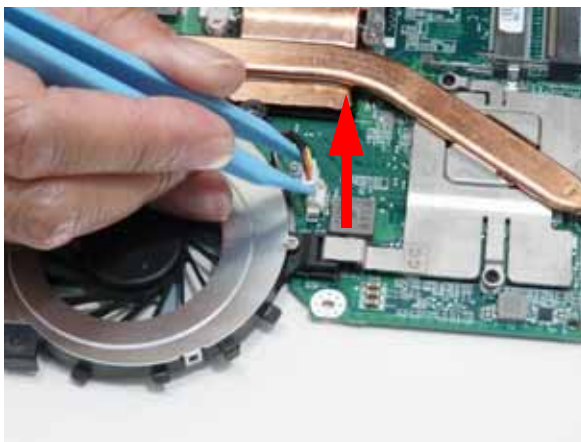

3. Loosen the four captive screws (in numerical order from 1 to 7) from the CPU Thermal Module.

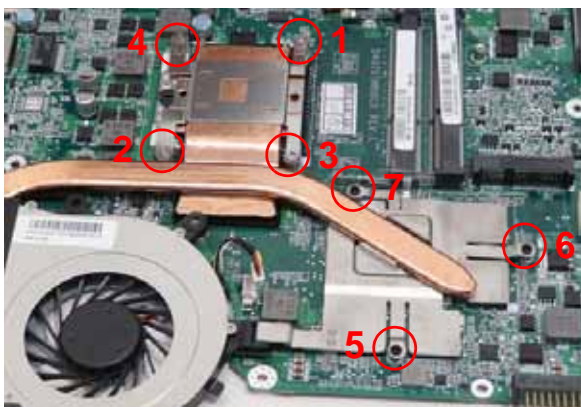

- Using both hands, lift the Thermal Module clear of the Mainboard.

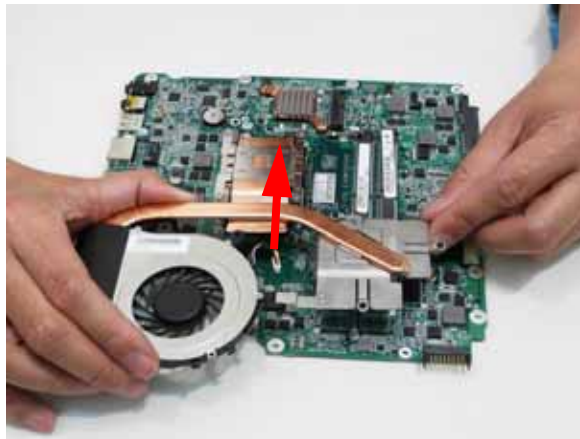

Removing the CPU

- See "Removing the Thermal Module" on page 71.
- Using a phillips screw driver, rotate the CPU locking screw 180° counter-clockwise as shown.

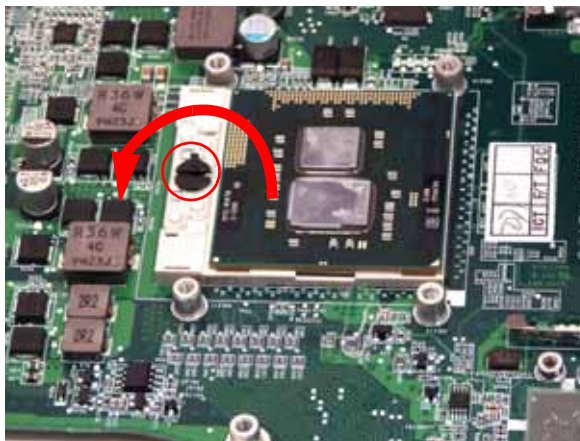

- Lift the CPU clear of the socket as shown.

IMPORTANT:The pins on the underside of the CPU are very delicate. If they are damaged, the CPU may malfunction. Place the CPU on a clean, dry surface when it is not installed.

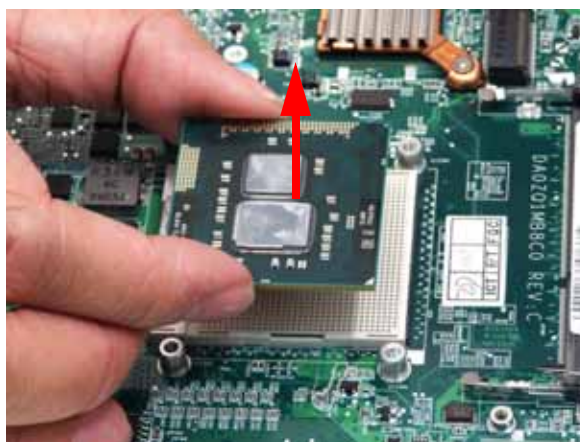

Removing the RTC Battery

1. See “Removing the Mainboard” on page 69.
2. Pry the RTC battery from the mainboard.

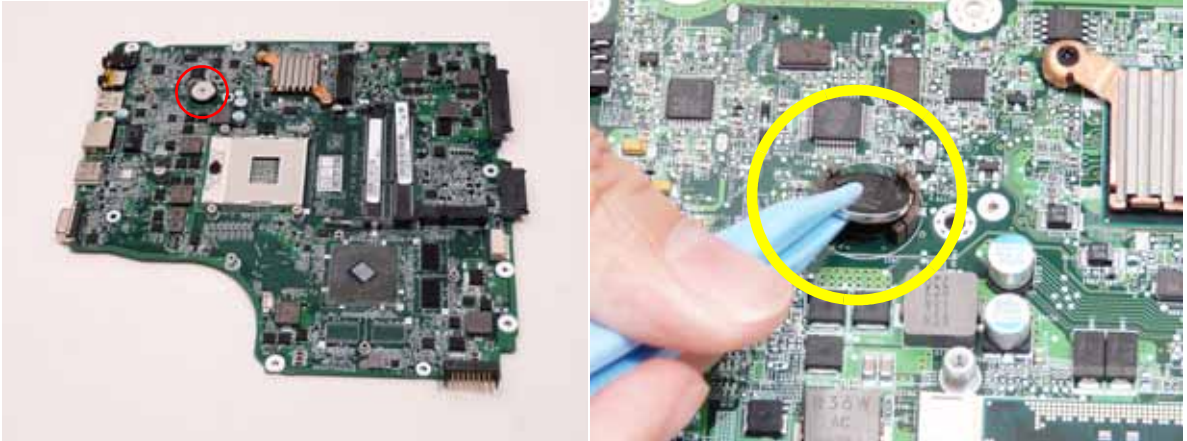

Please detach the RTC battery and follow local regulations for disposal.

Removing the WiFi Antenna Cable

1. See “Removing the Mainboard” on page 69.
2. Free the WiFi antennas from the guides on the bottom cover.



3. Turn the computer over. Pass the antenna through the lower cover, free it from all cable clips.

Removing the Right Speaker

1. See See "Removing the Mainboard" on page 69.
2. Disengage the Right speaker cable from the chassis as shown.

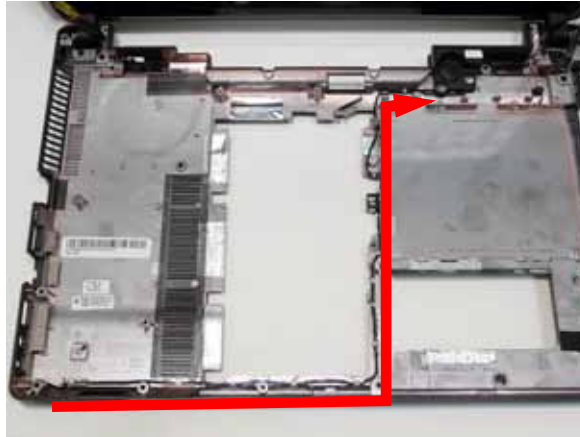

3. Remove the two (2) screws holding the right speaker in place.

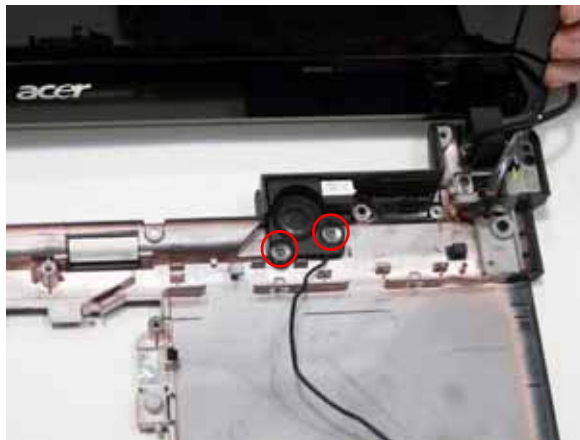

Step	Size	Quantity	Screw Type
Right Speaker Module	2.0*3widehead	2	

4. Remove the right speaker from the chassis.



Removing the LCD Module

1. See "Removing the WLAN Module" on page 53.
2. Remove the four securing screws (two each side) from the LCD module.



Step	Size	Quantity	Screw Type
LCD Module	M2.5*6.5	4	

3. Ensure that all cables entering the LCD are free of the chassis and remove the LCD module from the chassis.

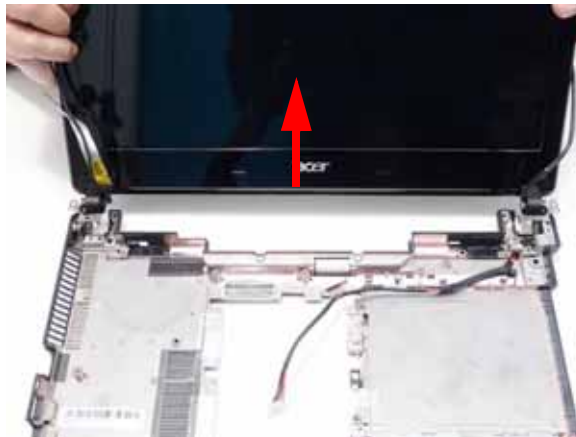

Removing the DC-In Cable

1. See "Removing the LCD Module" on page 75.
2. Remove one (1) screw from the right hinge bracket.



Step	Size	Quantity	Screw Type
DC-In Cable	M2.5*4	1	

3. Remove the right hinge bracket.

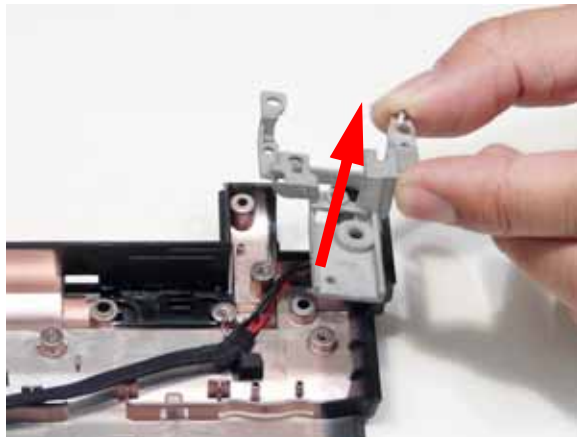

4. Lift the DC-In jack from the chassis.

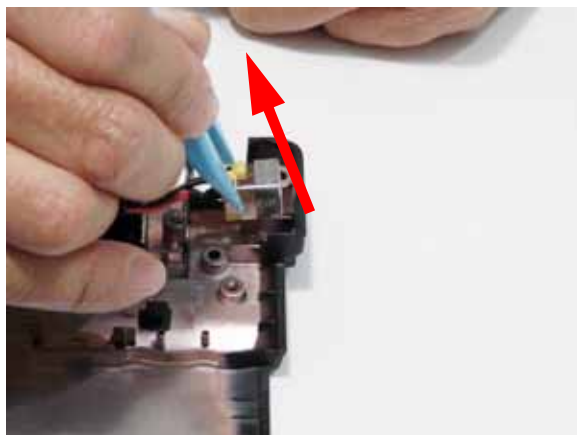

LCD Module Disassembly Process

LCD Module Disassembly Flowchart

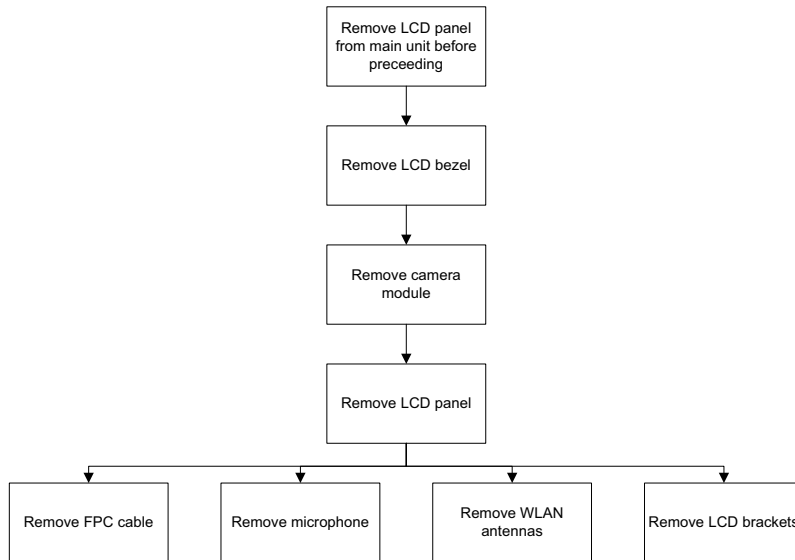

Screw List

Step	Screw	Quantity	Part No.
LCD Bezel	M2.5*4	2	86.PSR07.001
LCD Panel	M2.0*3	4	86.ARE07.002
LCD Brackets	M2.5*3	4	86.TPK07.003

Removing the LCD Bezel

- 1. See "Removing the LCD Module" on page 75.
- 2. Remove the two lower bezel screw caps and screws.



Step	Size	Quantity	Screw Type
LCD Bezel	M2.5*4	2	

- 3. Starting from the top-left corner of the bezel, pry the bezel upwards and away from the panel. Move along the top and left until all sides of the bezel are removed.



4. Lift the Bezel clear of the LCD Module.



Removing the Camera Module

1. See "Removing the LCD Bezel" on page 78.
2. Remove the Camera from the module.



3. Disconnect the camera cable.



Removing the LCD Panel

1. See "Removing the Camera Module" on page 79.
2. Disengage the various cables from the hinges.
3. Remove the four (4) securing screws from the LCD Panel.



Step	Size	Quantity	Screw Type
LCD Panel	M2.3*3	4	

4. Lift the LCD Panel clear of the module as shown.



Removing the FPC Cable

1. See "Removing the LCD Panel" on page 80.
2. Turn the LCD panel over to expose the rear. Remove the adhesive strip securing it in place.



3. Lift the adhesive protector and disconnect the cable from the LCD Panel.

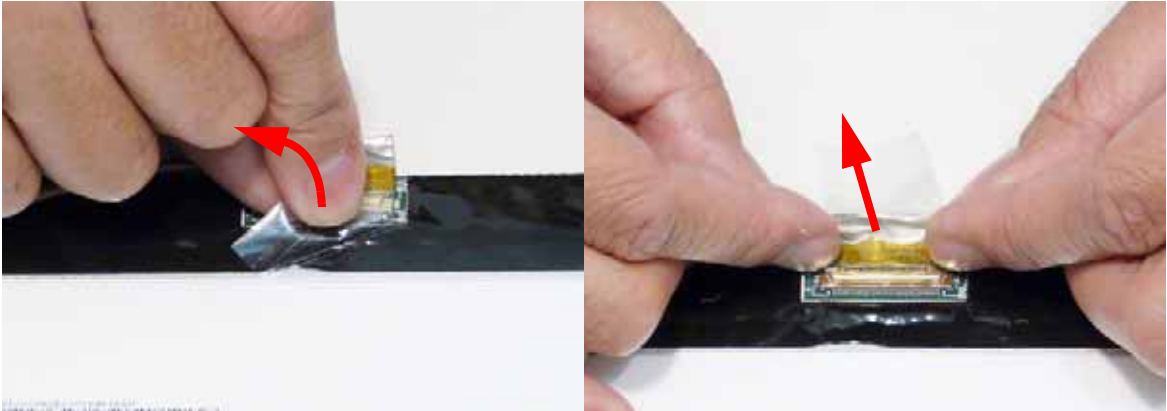

4. Lift the FPC cable from the panel.

Removing the Microphone Module

1. See "Removing the LCD Panel" on page 80.
2. Disengage the cable from the cable guides.

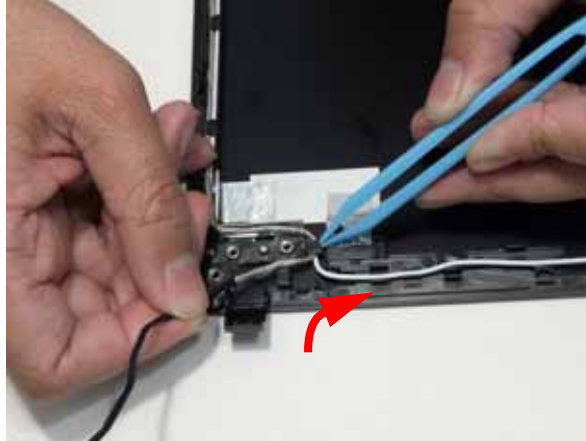

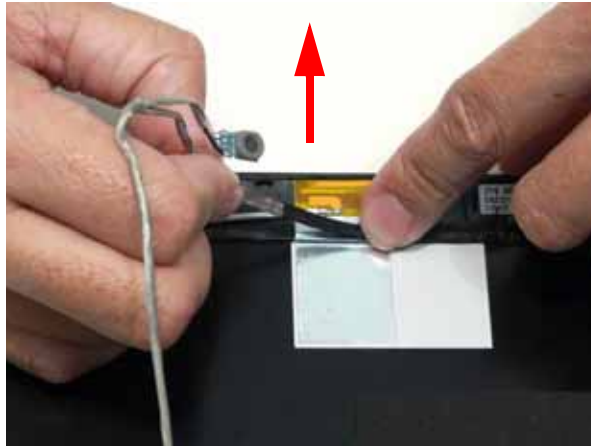

3. Lift the Microphone Module clear of the cover.

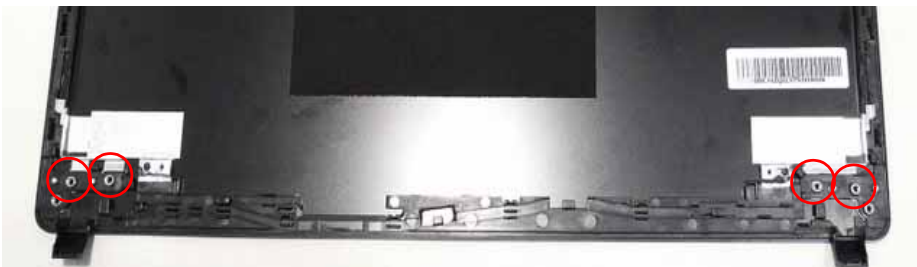

Removing the Hinges

1. See "Removing the LCD Panel" on page 80.
2. Remove the four (4) screws from the hinges



Step	Size	Quantity	Screw Type
LCD Hinges	M2.5*3	4	

3. Ensure all cables are free from the hinges and remove them from the LCD cover.

Removing the Antennas

1. See "Removing the LCD Panel" on page 80.
2. Disengage the left antenna cable from the guides.



3. Remove the adhesive tape and lift the left side antenna from the LCD module as shown.



4. Disengage the right antenna cable from the guides.



5. Remove the adhesive tape and lift the right side antenna from the LCD module as shown.

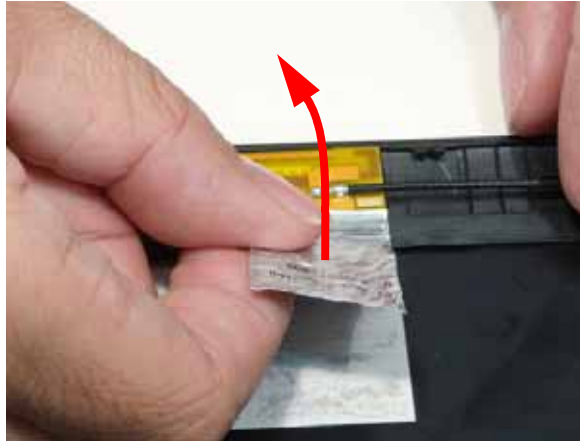

LCD Module Reassembly Procedure

Replacing the MIC and WiFi Antennas

1. Place the Microphone Module in the LCD Module as shown.
2. Run the cable as shown and secure it using the adhesive tabs.

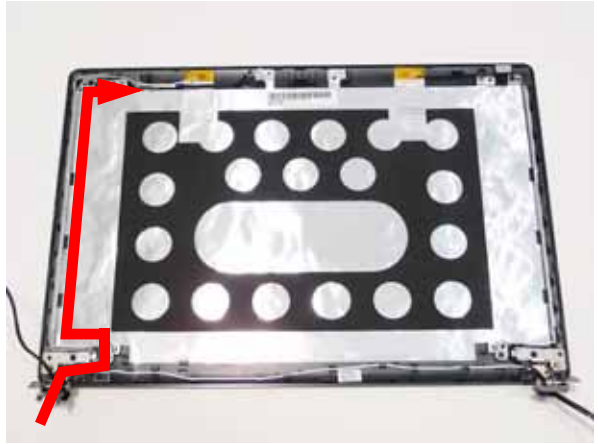
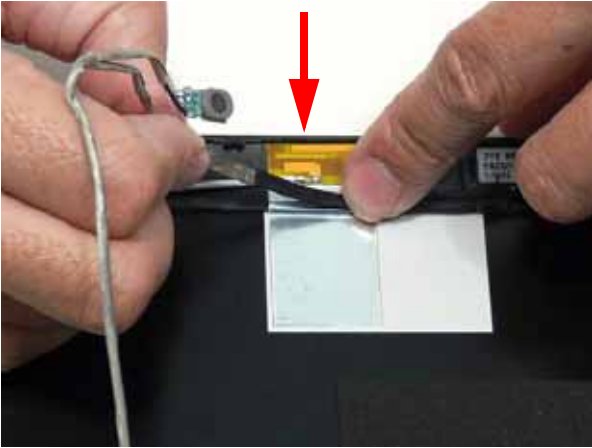

3. Replace the left and right antennas as shown. Press down on the adhesive pads to secure the antennas in place.

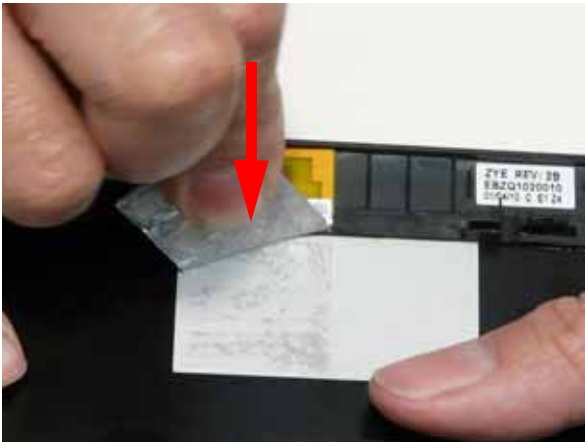

4. Replace the left antenna cable (white) as shown. Ensure that the cable is inserted along the cable channel as shown.
5. Replace the right antenna cables (black) as shown. Ensure that the cables are secured in the cable guides.

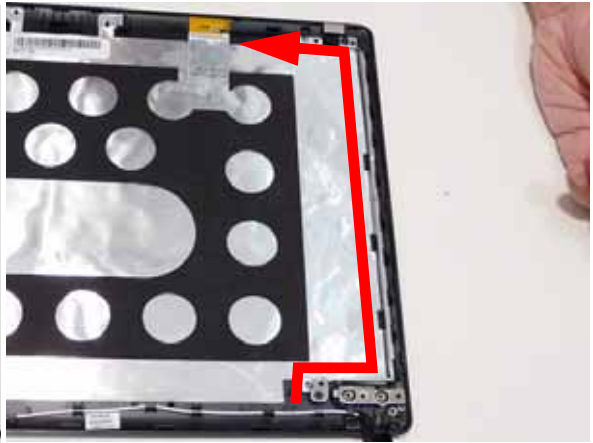

-
6. Ensure the antenna cables pass through the hinge well as shown.



Replacing the Microphone Module

1. Replace the Microphone Module into the top cover.

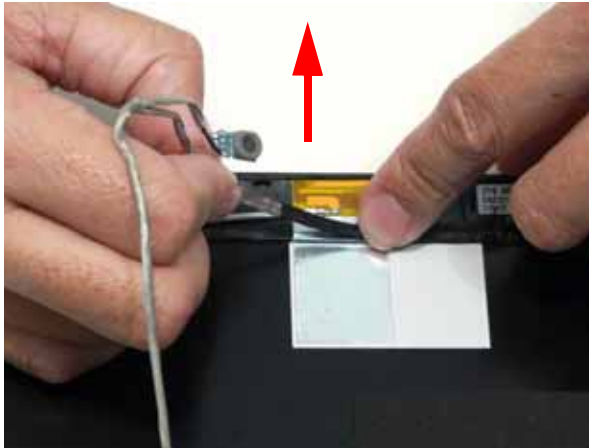

2. Replace the cable into the cable guides as shown.

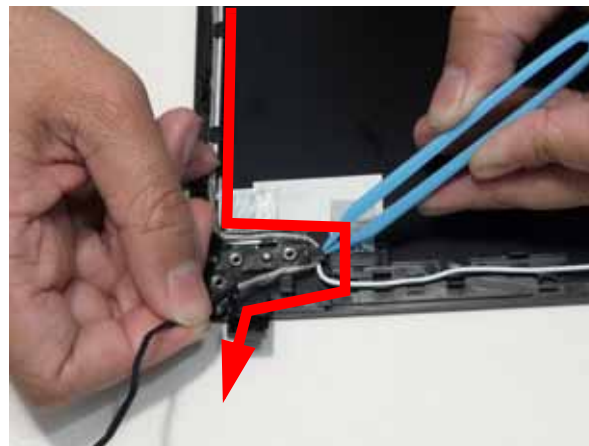

Replacing the FPC Cable

1. Attach the FPC cable to the LCD panel and attach the adhesive protector.



Replacing the LCD Panel

2. Place the LCD Panel into the module as shown.



3. Replace the six (6) securing screws from the LCD Panel.



Replacing the Webcam

4. Connect the cable to the camera module.



1. Place the camera in the LCD Module.



Replacing the LCD Bezel

1. Locate the bezel bottom edge first and press down until there are no gaps between the bezel and the LCD Module.

IMPORTANT: Ensure that the LCD cables pass through the hinge wells and are not trapped by the bezel.



2. Press down around the hinges and entire perimeter of the bezel until there are no gaps between the bezel and the LCD Module.

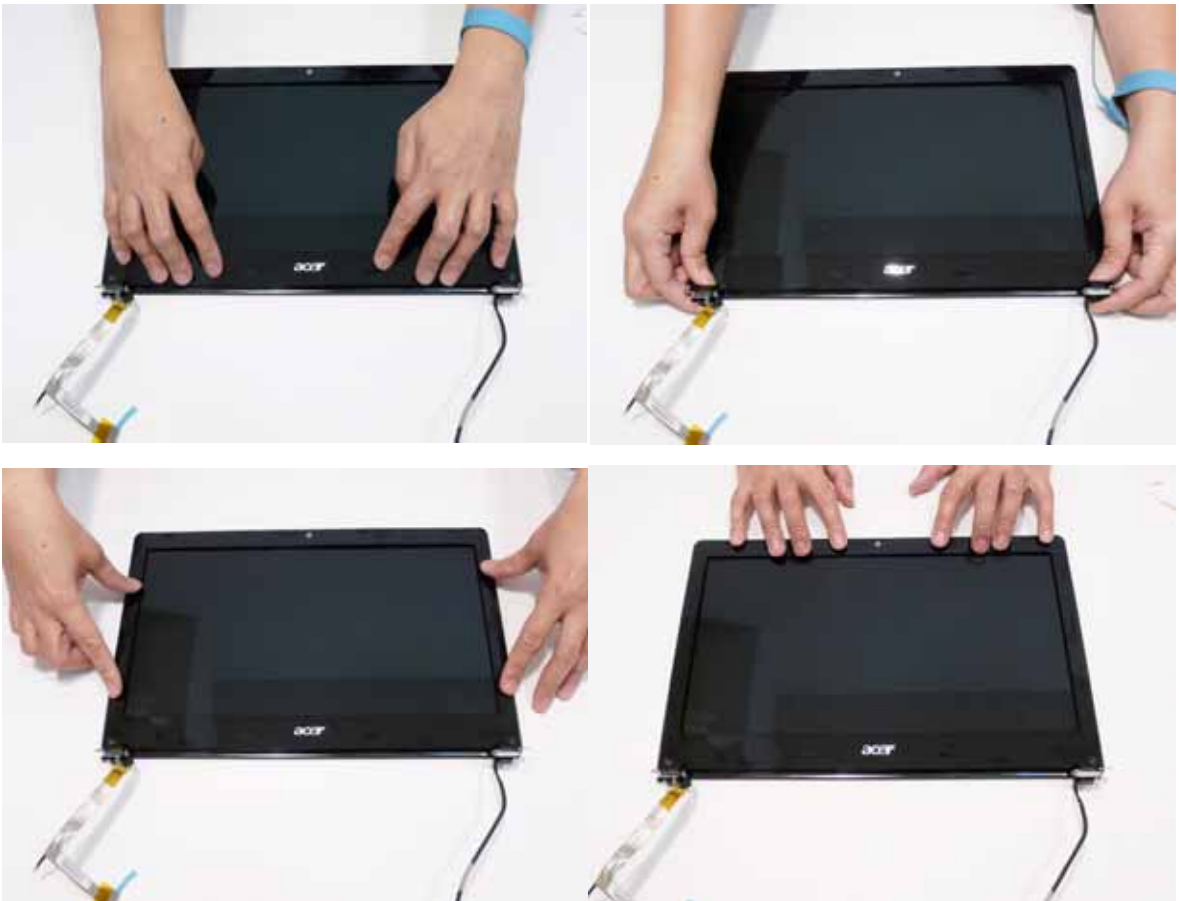

3. Replace the two screws and screw caps as shown.



Main Module Reassembly Procedure

Replacing the DC-In Cable

4. Place the DC-In jack back into the chassis.

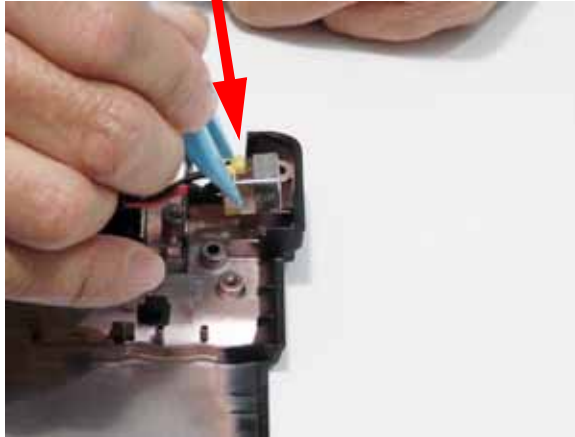

5. Replace the right hinge bracket.

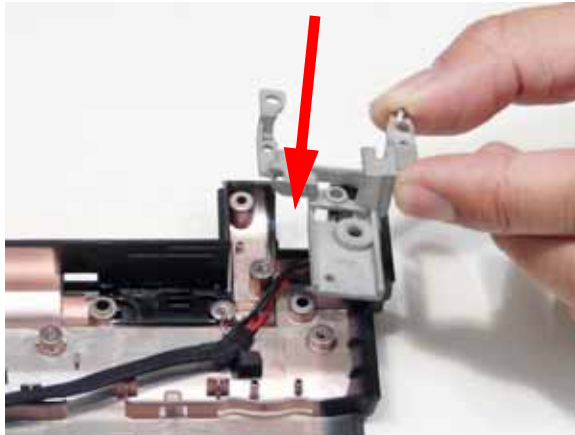

6. Replace the one(1) screw to the right hinge bracket as shown.



Replacing the LCD Module

1. Replace the LCD module onto the chassis.

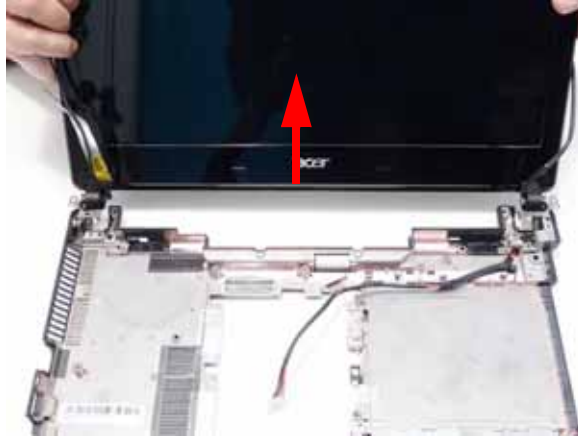

2. Replace the four securing screws (two each side) to the LCD module.



Replacing the Right Speaker

1. Place the right speaker in to the chassis.

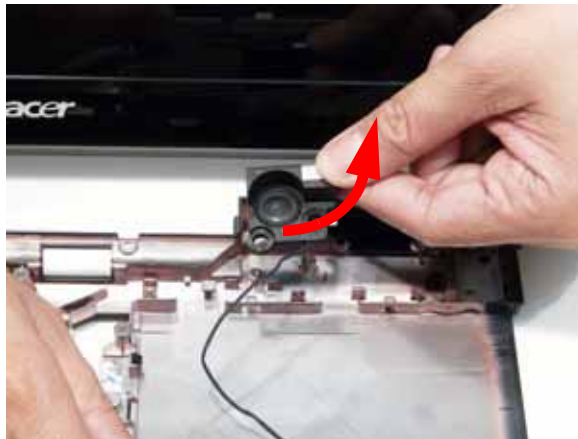

2. Replace the two (2) screws to secure the right speaker in place.

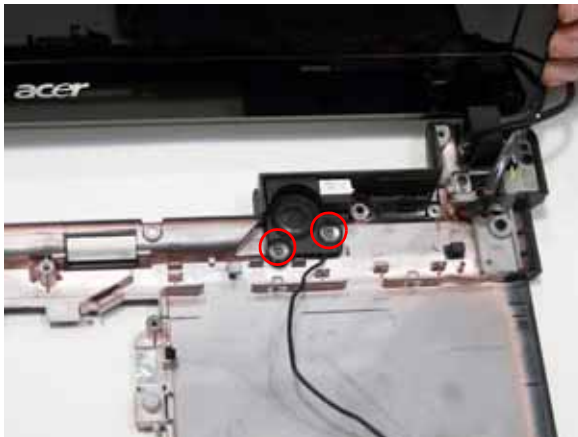

3. Replace the right speaker cable in to the chassis as shown.

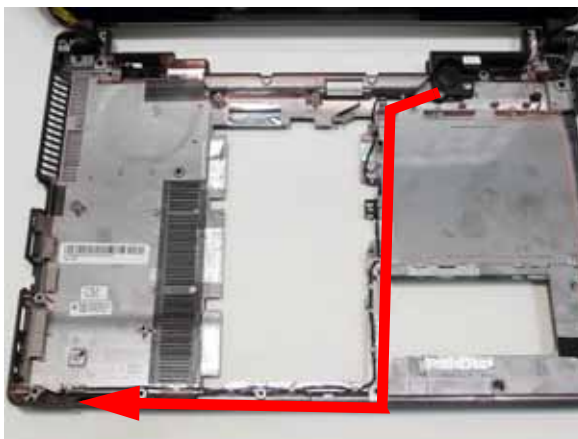

Replacing the RTC Battery

1. Snap the RTC battery into it's socket as shown.

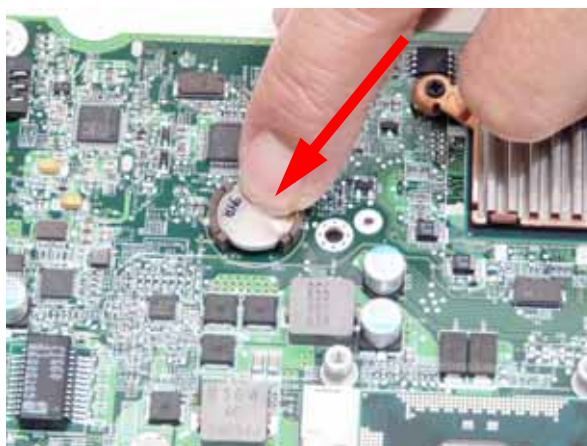

Replacing the CPU

IMPORTANT:The CPU has a Pin1 locator that must be positioned corresponding to the marker on the CPU socket.

1. Place the CPU into the CPU socket as shown, taking note of the Pin1 locator.

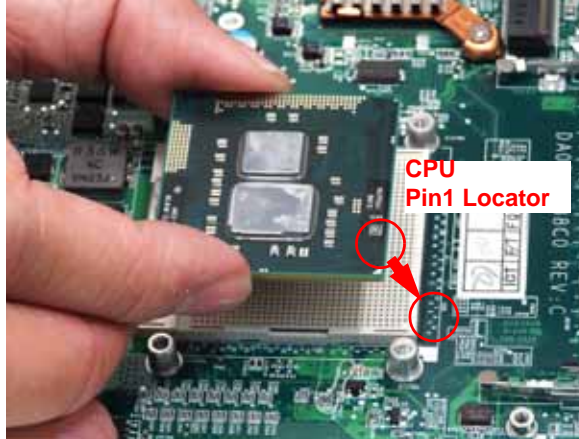

2. Using a flat-bladed screw driver, rotate the CPU locking screw 180° clockwise to secure the CPU in place.

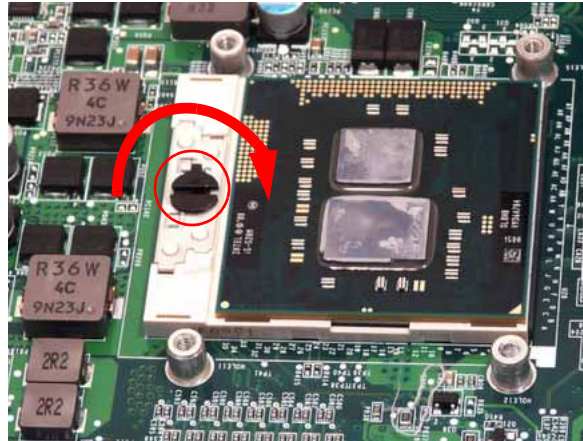

Replacing the Thermal Module

IMPORTANT:Apply a suitable thermal grease and ensure all heat pads are in place before replacing the Thermal Module.

The following thermal grease types are approved for use:

- Silmore GP50
- Honeywell PCM45F-SP
- ShinEtsu 7762

The following thermal pads are approved for use:

- Eapus XR-PE
1. Remove all traces of thermal grease from the CPU using a lint-free cloth or cotton swab and Isopropyl Alcohol, Acetone, or other approved cleaning agent.
 2. Apply a small amount of thermal grease to the centre of the CPU—there is no need to spread the grease manually, the force used during the installation of the Thermal Module is sufficient.

3. Align the screw holes on the Thermal Module and Mainboard then replace the module. Keep the module as level as possible to spread the thermal grease evenly.
4. Replace the seven securing screws (in numerical order from screw 1 to screw 7) to secure the Thermal Module in place.

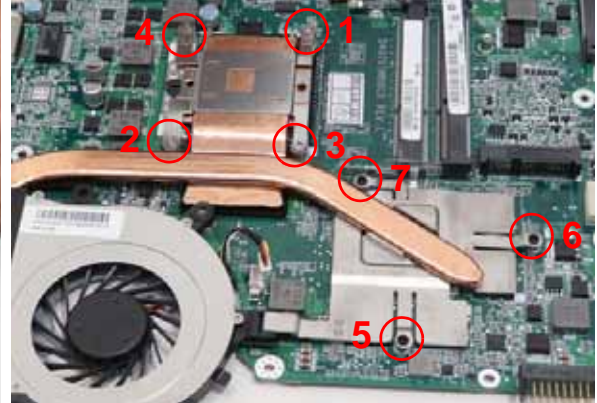
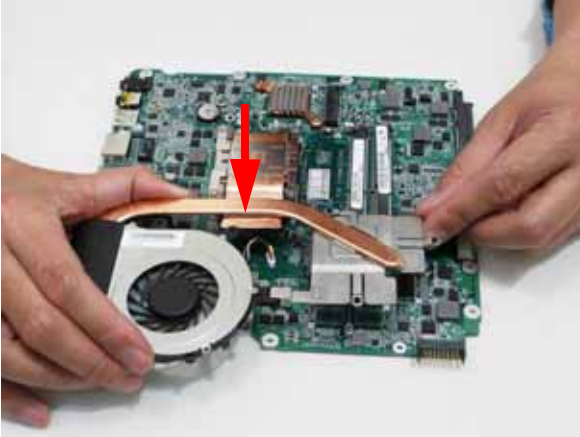

5. Connect the fan cable to the Mainboard.



Replacing the Mainboard

6. Place the Mainboard in the chassis, left edge first (1), then rotate it downward into position (2).
7. Replace the one (1) securing screws in the mainboard.

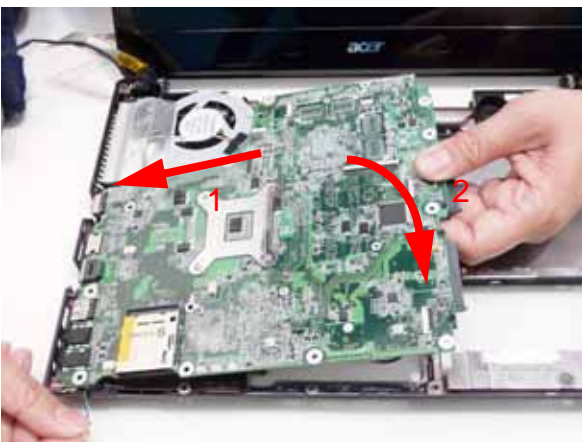

NOTE: Ensure the left side I/O ports are positioned correctly through the casing.

8. Turn the computer over and replace the DC-In cable.



9. Turn the computer over. Feed the microphone cable through the guides on the fan.



10. Reattach the microphone cable.

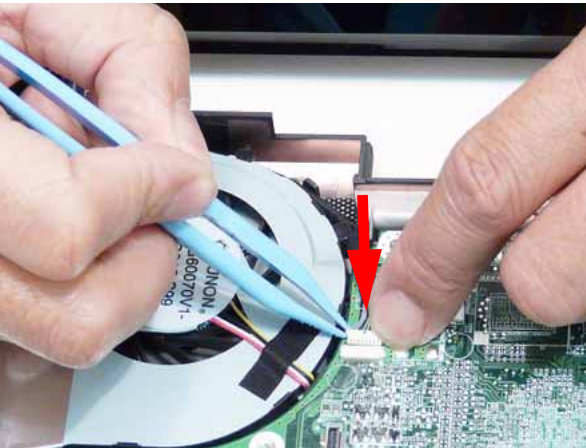

11.

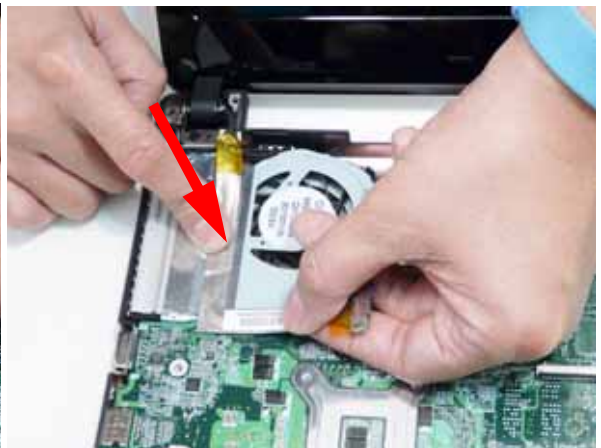

12. Snap the FPC cable into place.

13.

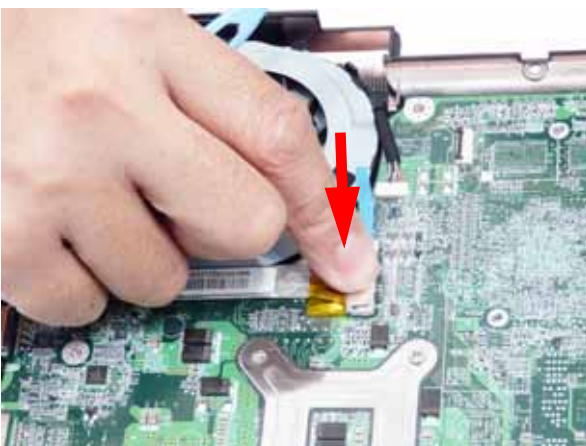

14. Reattach the adhesive covering the FPC cable connector.

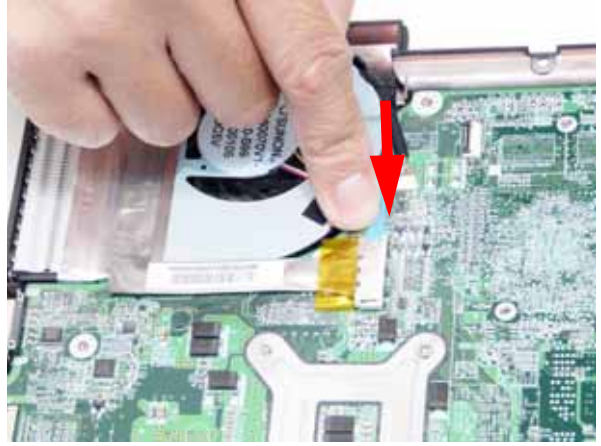

15. Connect the right speaker cable.



Replacing the Bluetooth Module

NOTE: The Bluetooth Module and USB Board can be replaced independently and in any order.

1. Connect the smaller end of the Bluetooth cable to the Bluetooth Module as shown.
2. Secure the Bluetooth cable in place using the one (1) screw.

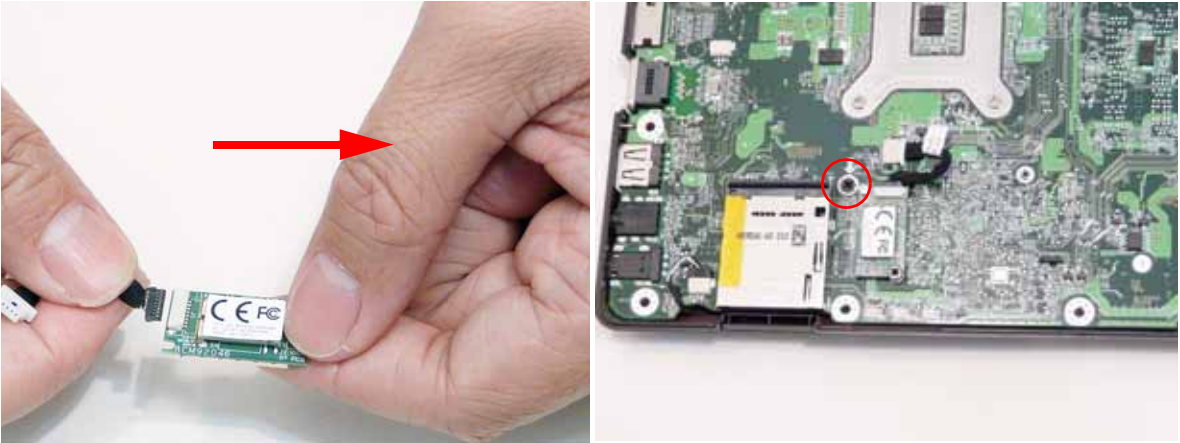

Connect the Bluetooth cable to the Mainboard.

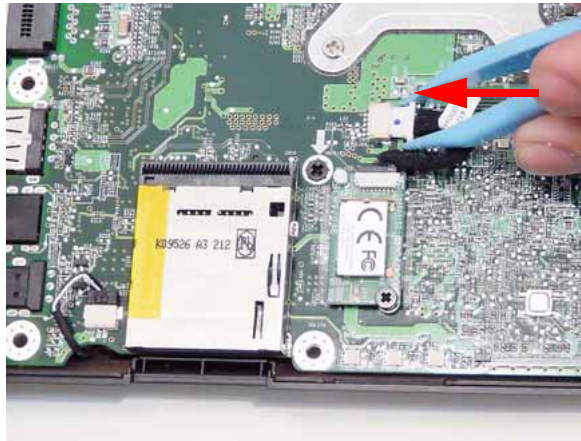

Replacing the 3G Module

1. Replace the one (1) screw and replace the LED Board in to the Upper Cover.



-
- e. Replace the 3G Module FFC and lock the latch into place.

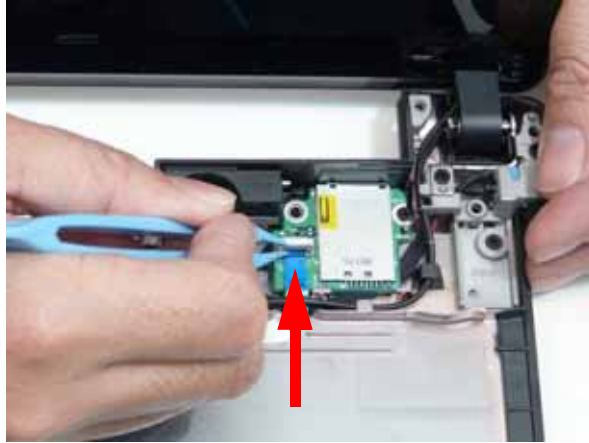

Replacing the USB Board

1. Replace the USB Board in the Lower Cover.
2. Insert the FFC cable in to the connector on the Mainboard and secure the locking latch.

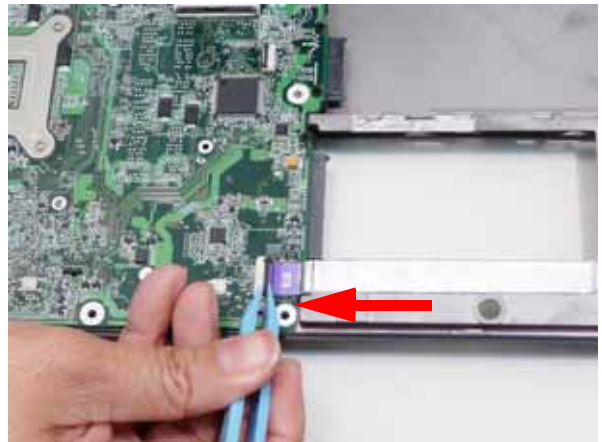
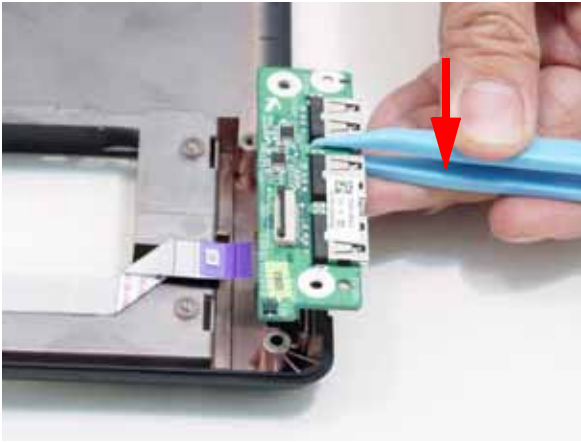

3. Replace the single securing screw.

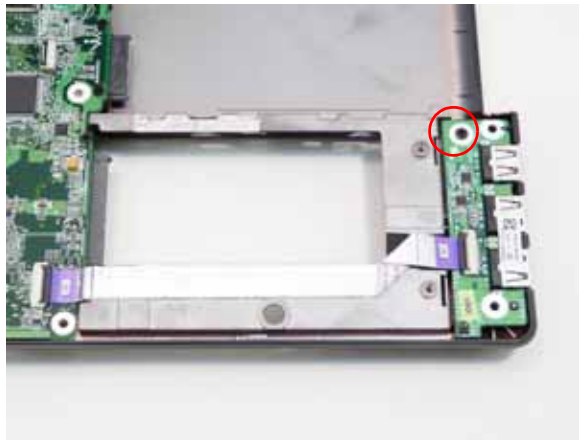

Replacing the Left Speaker Module

1. Place the Speaker Module on the Upper Cover as shown.
2. Replace the one (1) securing screw.



3. Lay the speaker cable into its guides.



Replacing the Switch Board

1. Replace the Switch Board FFC and lock it into place.
2. Place the Switch Board in to the Upper Cover as shown and replace the two (2) screws.



Replacing the LED Board

1. Place the LED Board in to the Upper Cover as shown and replace the two (2) screws.
2. Replace the LED Board FFC and lock it into place.

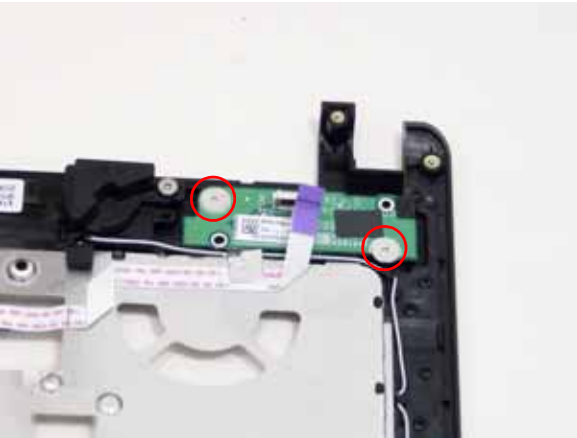

Replacing the Upper Cover

1. Place the Upper Cover on the Lower Cover back edge first.
2. Lower the cover into position and press down the sides as shown.



3. Continue pressing around the edges of the casing until there are no gaps between the Upper and Lower Covers.



4. Connect the four cables to the Mainboard as shown.

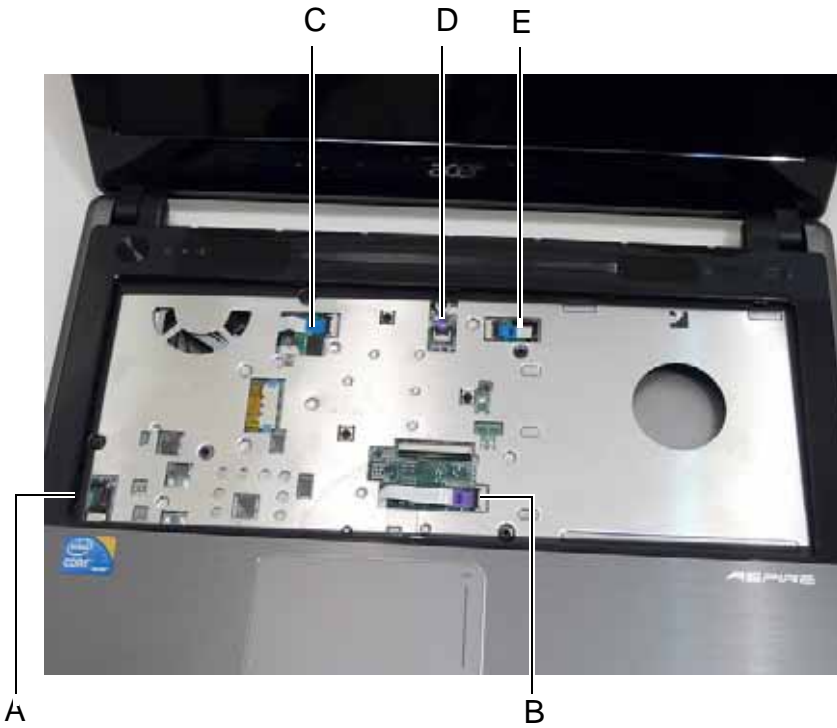

5. Connect A as shown.



6. Insert B as shown and close the locking latch.



7. Insert C as shown and close the locking latch.



8. Insert D as shown and close the locking latch.



9. Insert E as shown and close the locking latch.



10. Turn the computer over and replace the fourteen screws as shown.

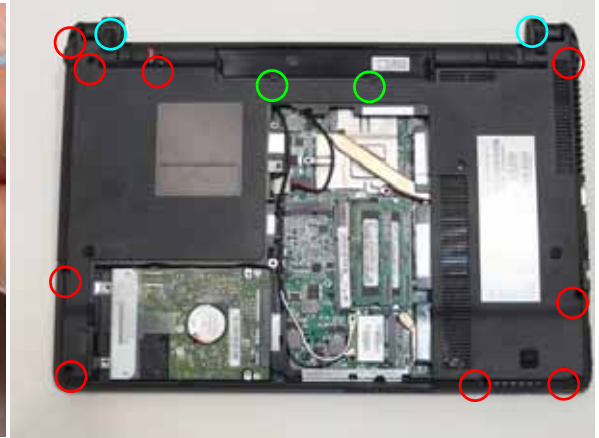

Replacing the Keyboard

1. Place the keyboard face down on the Upper Cover. Reconnect keyboard FFCs to the mainboard, and secure the locking latch.

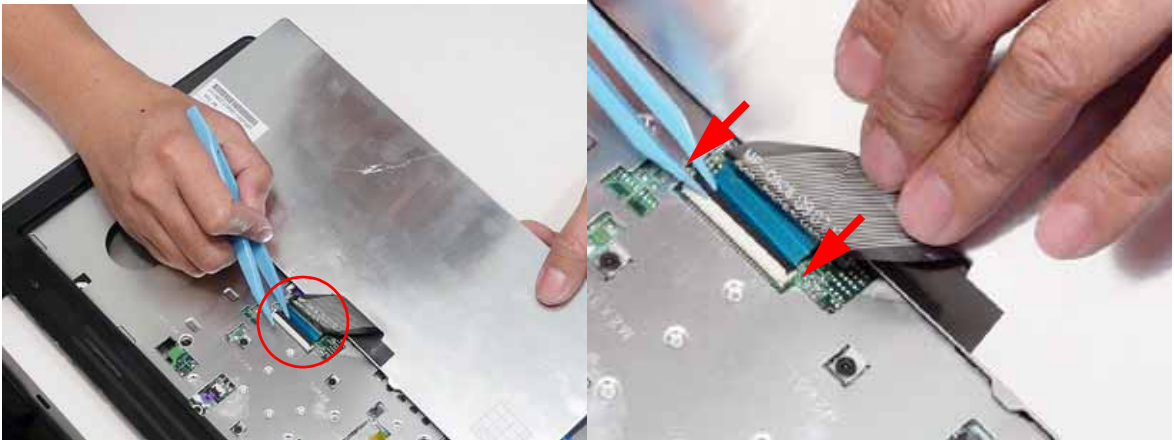

2. Slide the Keyboard front edge first into the Upper Cover, ensuring that the four locating tabs are correctly seated.
3. Press down as indicated to secure the Keyboard in place.



Replacing the Hard Disk Drive Module

1. Place the HDD in the HDD carrier replace the two (2) screws to secure the carrier.

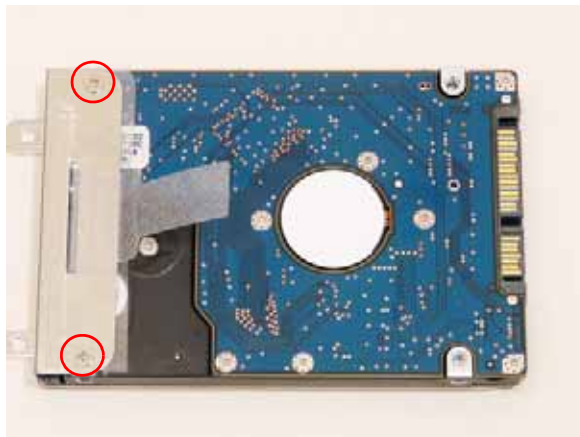

2. Insert the HDD, left side first, and lower it into place.



3. Slide the HDD to the left to connect the interface.



Replacing the WLAN Board

1. Insert the WLAN board into the WLAN socket.
2. Replace the one (1) screw to secure the module.



3. Connect the two (2) antenna cables to the module.

NOTE: Cable placement is **Black** to the **TR1** terminal (left), and **White** to the **TR2** terminal (right).



Replacing the DIMM Modules

1. Insert the DIMM Module in place.
2. Press down to lock the DIMM module in place.

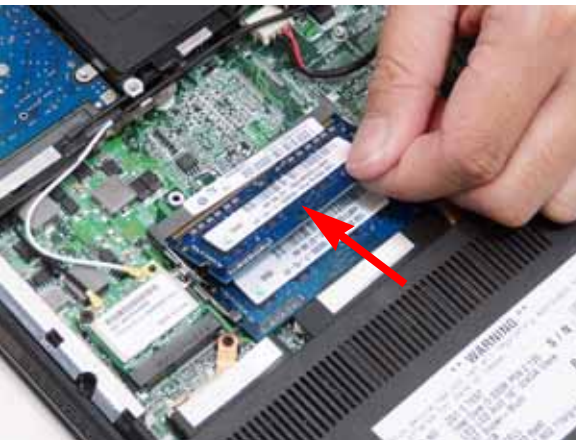

3. Repeat with the second DIMM module if present.

Replacing the ODD Module

1. Press the bezel into the tray, bottom edge first, to secure it to the ODD Module.
2. Secure the ODD bracket with the two screws.



3. Push the ODD Module into the ODD bay until it is flush with the casing.
4. Replace the single screw to secure the Module.

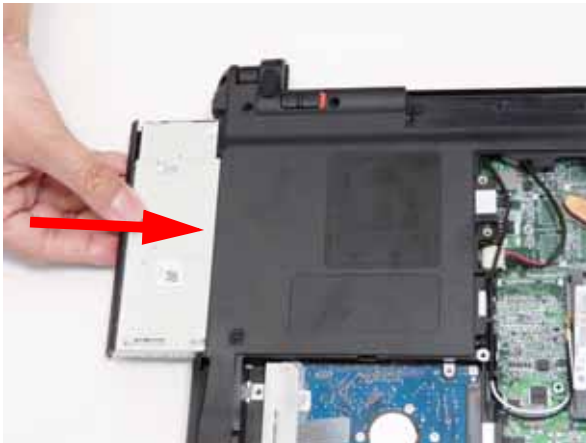

Replacing the Lower Covers

1. Replace the Lower Cover as shown.



IMPORTANT: Press down around the perimeter of the cover to ensure that all the securing tabs are snapped correctly.

2. Secure the five captive screws to hold the cover in place.



Replacing the Dummy Card

1. Insert the SD Dummy Card into the slot and push until the card clicks into place and is flush with the casing.



Replacing the SIM card

1. Push the 3G card all the way in to snap it in place.



Replacing the Battery Pack

1. Slide the batter pack into place.
2. Slide the battery lock in the direction shown to secure the battery in place.



Troubleshooting

Common Problems

Use the following procedure as a guide for computer problems.

NOTE: The diagnostic tests are intended to test only Acer products. Non-Acer products, prototype cards, or modified options can give false errors and invalid system responses.

1. Obtain the failing symptoms in as much detail as possible.
2. Verify the symptoms by attempting to re-create the failure by running the diagnostic test or by repeating the same operation.
3. Use the following table with the verified symptom to determine which page to go to.

Symptoms (Verified)	Go To
Power On Issue	Page 114
No Display Issue	Page 115
LCD Failure	Page 117
Internal Keyboard Failure	Page 117
TouchPad Failure	Page 118
Internal Speaker Failure	Page 118
ODD Failure	Page 121
WLAN Failure	Page 124
Thermal Unit Failure	Page 124
Other Functions Failure	Page 125
Intermittent Failures	Page 126
Undermined Failures	Page 126

4. If the Issue is still not resolved, see "Online Support Information" on page 243.

Power On Issue

If the system doesn't power on, perform the following actions one at a time to correct the problem. Do not replace a non-defective FRUs:

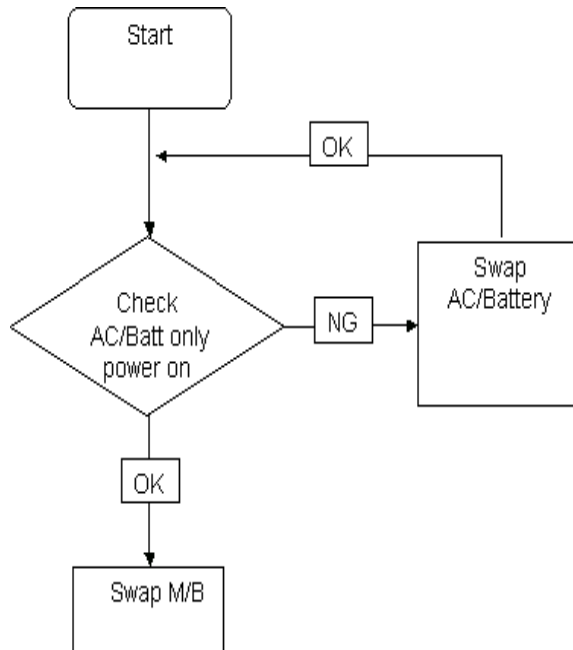

Computer Shutdown Intermittently

If the system powers off at intervals, perform the following actions one at a time to correct the problem.

1. Check the power cable is properly connected to the computer and the electrical outlet.
2. Remove any extension cables between the computer and the outlet.
3. Remove any surge protectors between the computer and the electrical outlet. Plug the computer directly into a known good electrical outlet.
4. Disconnect the power and open the casing to check the Thermal Unit (see "Thermal Unit Failure" on page 124) and fan airways are free of obstructions.
5. Remove all external and non-essential hardware connected to the computer that are not necessary to boot the computer to the failure point.
6. Remove any recently installed software.
7. If the Issue is still not resolved, see "Online Support Information" on page 243.

No Display Issue

If the **Display** doesn't work, perform the following actions one at a time to correct the problem. Do not replace a non-defective FRUs:

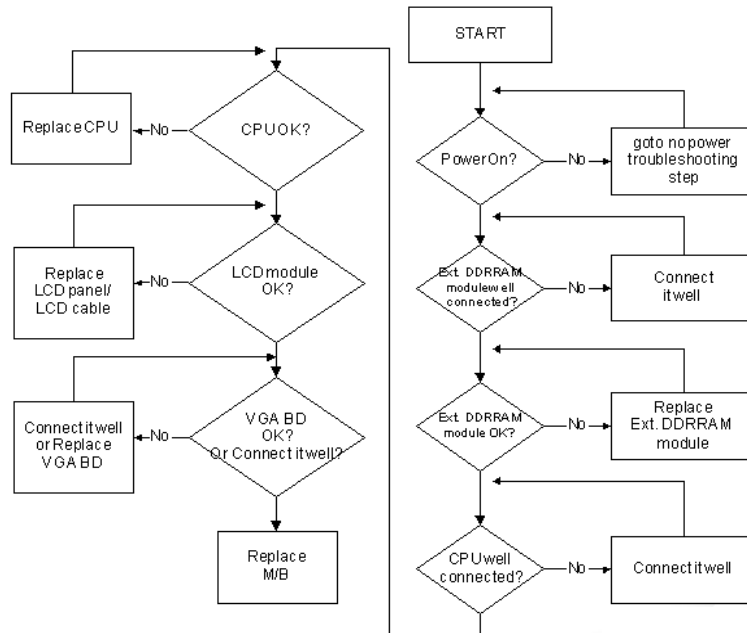

No POST or Video

If the POST or video doesn't display, perform the following actions one at a time to correct the problem.

1. Make sure that the internal display is selected. On this notebook model, switching between the internal display and the external display is done by pressing **Fn+F5**. Reference Product pages for specific model procedures.
2. Make sure the computer has power by checking at least one of the following occurs:
 - Fans start up
 - Status LEDs light up

If there is no power, see "Power On Issue" on page 114.

3. Drain any stored power by removing the power cable and battery and holding down the power button for 10 seconds. Reconnect the power and reboot the computer.
4. Connect an external monitor to the computer and switch between the internal display and the external display is by pressing **Fn+F5** (on this model).

If the POST or video appears on the external display, see "LCD Failure" on page 117.

5. Disconnect power and all external devices including port replicators or docking stations. Remove any memory cards and CD/DVD discs. Restart the computer.

If the computer boots correctly, add the devices one by one until the failure point is discovered.

6. Reseat the memory modules.
7. Remove the drives (see "Disassembly Process" on page 41).
8. If the Issue is still not resolved, see "Online Support Information" on page 243.

Abnormal Video Display

If video displays abnormally, perform the following actions one at a time to correct the problem.

1. Reboot the computer.
2. If permanent vertical/horizontal lines or dark spots display in the same location, the LCD is faulty and should be replaced. See “Disassembly Process” on page 41.
3. If extensive pixel damage is present (different colored spots in the same locations on the screen), the LCD is faulty and should be replaced. See “Disassembly Process” on page 41.
4. Adjust the brightness to its highest level. See the User Manual for instructions on adjusting settings.
NOTE: Ensure that the computer is not running on battery alone as this may reduce display brightness.
If the display is too dim at the highest brightness setting, the LCD is faulty and should be replaced. See “Disassembly Process” on page 41.
5. Check the display resolution is correctly configured:
 - a. Minimize or close all Windows.
 - b. If display size is only abnormal in an application, check the view settings and control/mouse wheel zoom feature in the application.
 - c. If desktop display resolution is not normal, right-click on the desktop and select **Personalize**→ **Display Settings**.
 - d. Click and drag the Resolution slider to the desired resolution.
 - e. Click **Apply** and check the display. Readjust if necessary.
6. Roll back the video driver to the previous version if updated.
7. Remove and reinstall the video driver.
8. Check the Device Manager to determine that:
 - The device is properly installed. There are no red Xs or yellow exclamation marks.
 - There are no device conflicts.
 - No hardware is listed under Other Devices.
9. If the Issue is still not resolved, see “Online Support Information” on page 243.
10. Run the Windows Memory Diagnostic from the operating system DVD and follow the onscreen prompts.
11. If the Issue is still not resolved, see “Online Support Information” on page 243.

Random Loss of BIOS Settings

If the computer is experiencing intermittent loss of BIOS information, perform the following actions one at a time to correct the problem.

1. If the computer is more than one year old, replace the CMOS battery.
2. Run a complete virus scan using up-to-date software to ensure the computer is virus free.
3. If the computer is experiencing HDD or ODD BIOS information loss, disconnect and reconnect the power and data cables between devices.
If the BIOS settings are still lost, replace the cables.
4. If HDD information is missing from the BIOS, the drive may be defective and should be replaced.
5. Replace the Motherboard.
6. If the Issue is still not resolved, see “Online Support Information” on page 243.

LCD Failure

If the **LCD** fails, perform the following actions one at a time to correct the problem. Do not replace a non-defective FRUs:

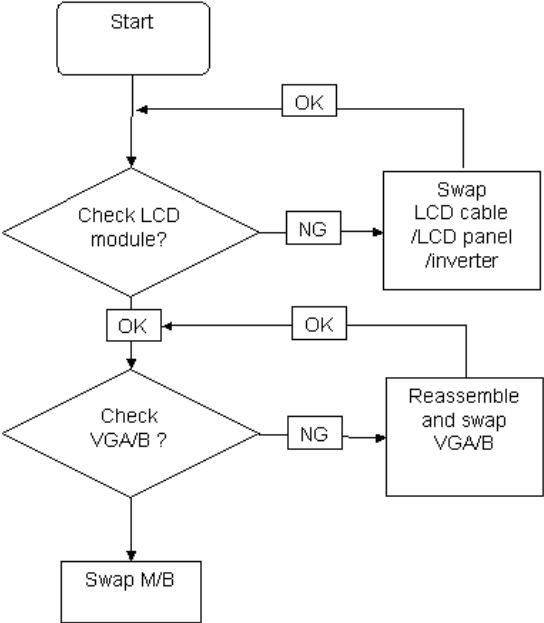

Built-In Keyboard Failure

If the built-in **Keyboard** fails, perform the following actions one at a time to correct the problem. Do not replace a non-defective FRUs:

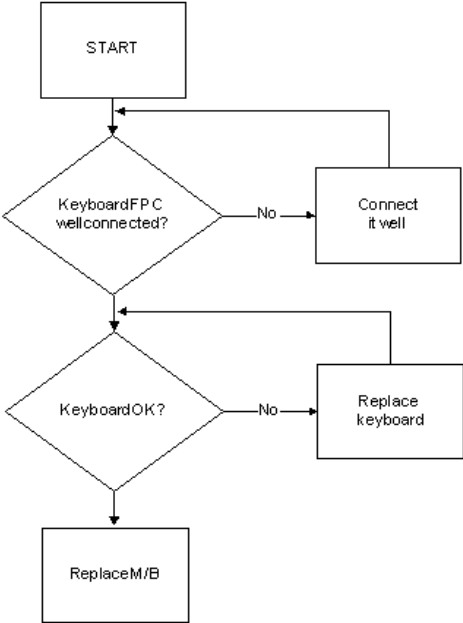

TouchPad Failure

If the **TouchPad** doesn't work, perform the following actions one at a time to correct the problem. Do not replace a non-defective FRUs:

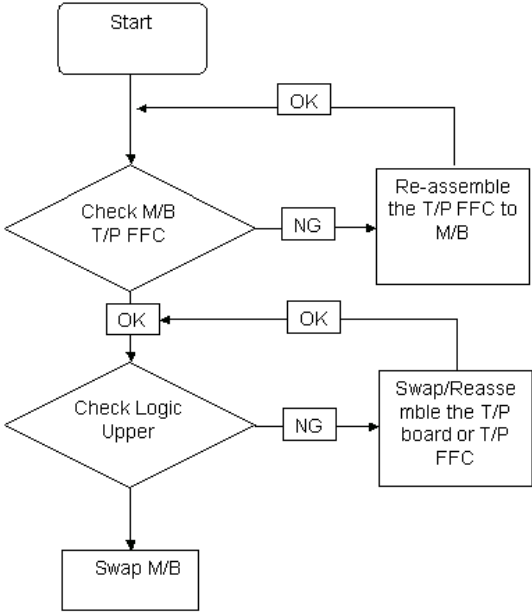

Internal Speaker Failure

If the internal **Speakers** fail, perform the following actions one at a time to correct the problem. Do not replace a non-defective FRUs:

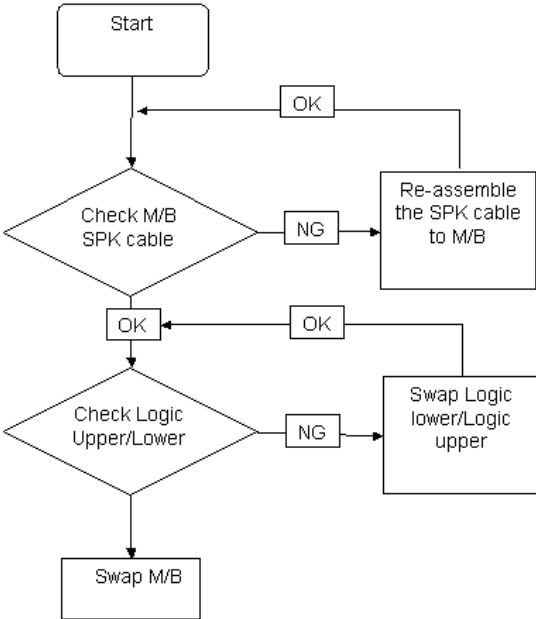

Sound Problems

If sound problems are experienced, perform the following actions one at a time to correct the problem.

1. Reboot the computer.
2. Navigate to **Start**→ **Control Panel**→ **System and Maintenance**→ **System**→ **Device Manager**. Check the Device Manager to determine that:
 - The device is properly installed.
 - There are no red Xs or yellow exclamation marks.
 - There are no device conflicts.
 - No hardware is listed under Other Devices.
3. Roll back the audio driver to the previous version, if updated recently.
4. Remove and reinstall the audio driver.
5. Ensure that all volume controls are set mid range:
 - a. Click the volume icon on the taskbar and drag the slider to 50. Ensure that the volume is not muted.
 - b. Click Mixer to verify that other audio applications are set to 50 and not muted.
6. Navigate to **Start**→ **Control Panel**→ **Hardware and Sound**→ **Sound**. Ensure that Speakers are selected as the default audio device (green check mark).

NOTE: If Speakers does not show, right-click on the **Playback** tab and select **Show Disabled Devices** (clear by default).
7. Select Speakers and click **Configure** to start **Speaker Setup**. Follow the onscreen prompts to configure the speakers.
8. Remove and recently installed hardware or software.
9. Restore system and file settings from a known good date using **System Restore**.

If the issue is not fixed, repeat the preceding steps and select an earlier time and date.
10. Reinstall the Operating System.
11. If the Issue is still not resolved, see “Online Support Information” on page 243.

Microphone Problems

If internal or external **Microphones** do not operate correctly, perform the following actions one at a time to correct the problem.

1. Check that the microphone is enabled. Navigate to **Start**→ **Control Panel**→ **Hardware and Sound**→ **Sound** and select the **Recording** tab.
2. Right-click on the **Recording** tab and select **Show Disabled Devices** (clear by default).
3. The microphone appears on the **Recording** tab.
4. Right-click on the microphone and select **Enable**.
5. Select the microphone then click **Properties**. Select the **Levels** tab.
6. Increase the volume to the maximum setting and click **OK**.
7. Test the microphone hardware:
 - a. Select the microphone and click **Configure**.
 - b. Select **Set up microphone**.
 - c. Select the microphone type from the list and click **Next**.
 - d. Follow the onscreen prompts to complete the test.
8. If the Issue is still not resolved, see “Online Support Information” on page 243.

HDD Not Operating Correctly

If the **HDD** does not operate correctly, perform the following actions one at a time to correct the problem.

1. Disconnect all external devices.
2. Run a complete virus scan using up-to-date software to ensure the computer is virus free.
3. Run the Windows 7 Startup Repair Utility:
 - a. insert the Windows 7 Operating System DVD in the ODD and restart the computer.
 - b. When prompted, press any key to start to the operating system DVD.
 - c. The **Install Windows** screen displays. Click **Next**.
 - d. Select **Repair your computer**.
 - e. The **System Recovery Options** screen displays. Click **Next**.
 - f. Select the appropriate operating system, and click **Next**.

NOTE: Click **Load Drivers** if controller drives are required.

- g. Select **Startup Repair**.
- h. Startup Repair attempts to locate and resolve issues with the computer.
- i. When complete, click **Finish**.

If an issue is discovered, follow the onscreen information to resolve the problem.

4. Run the Windows Memory Diagnostic Tool. For more information see Windows Help and Support.
5. Restart the computer and press F2 to enter the BIOS Utility. Check the BIOS settings are correct and that CD/DVD drive is set as the first boot device on the Boot menu.
6. Ensure all cables and jumpers on the HDD and ODD are set correctly.
7. Remove any recently added hardware and associated software.
8. Run the Windows Disk Defragmenter. For more information see Windows Help and Support.
9. Run Windows Check Disk by entering **chkdsk /r** from a command prompt. For more information see Windows Help and Support.
10. Restore system and file settings from a known good date using **System Restore**.

If the issue is not fixed, repeat the preceding steps and select an earlier time and date.
11. Replace the HDD. See "Disassembly Process" on page 41.

ODD Failure

If the **ODD** fails, perform the following actions one at a time to correct the problem. Do not replace a non-defective FRUs:

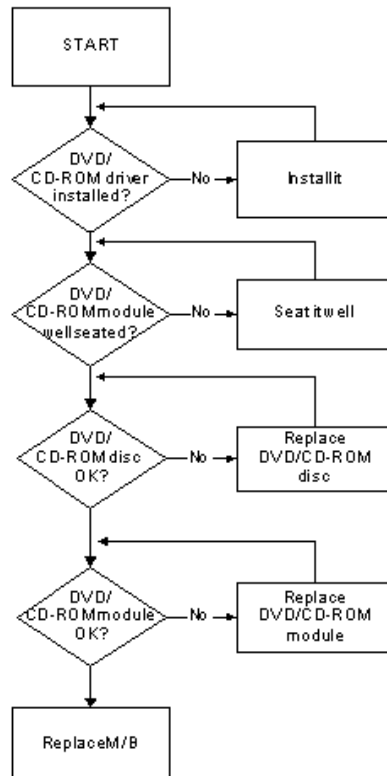

ODD Not Operating Correctly

If the **ODD** exhibits any of the following symptoms it may be faulty:

- Audio CDs do not play when loaded
- DVDs do not play when loaded
- Blank discs do not burn correctly
- DVD or CD play breaks up or jumps
- Optical drive not found or not active:
 - Not shown in My Computer or the BIOS setup
 - LED does not flash when the computer starts up
 - The tray does not eject
- Access failure screen displays
- The ODD is noisy

Perform the following general solutions one at a time to correct the problem.

1. Reboot the computer and retry the operation.
2. Try an alternate disc.
3. Navigate to **Start** → **Computer**. Check that the ODD device is displayed in the **Devices with Removable Storage** panel.
4. Navigate to **Start** → **Control Panel** → **System and Maintenance** → **System** → **Device Manager**.

-
- a. Double-click **IDE ATA/ATAPI controllers**. If a device displays a down arrow, right-click on the device and click **Enable**.
 - b. Double-click **DVD/CD-ROM drives**. If the device displays a down arrow, right-click on the device and click **Enable**.
 - c. Check that there are no yellow exclamation marks against the items in **IDE ATA/ATAPI controllers**. If a device has an exclamation mark, right-click on the device and uninstall and reinstall the driver.
 - d. Check that there are no yellow exclamation marks against the items in **DVD/CD-ROM drives**. If a device has an exclamation mark, right-click on the device and uninstall and reinstall the driver.
 - e. If the exclamation marker is not removed from the item in the lists, try removing any recently installed software and retrying the operation.

Discs Do Not Play

If discs do not play when inserted in the drive, perform the following actions one at a time to correct the problem.

1. Check that the disc is correctly seated in the drive tray and that the label on the disc is visible.
2. Check that the media is clean and scratch free.
3. Try an alternate disc in the drive.
4. Ensure that **AutoPlay** is enabled:
 - a. Navigate to **Start** → **Control Panel** → **Hardware and Sound** → **AutoPlay**.
 - b. Select **Use AutoPlay for all media and devices**.
 - c. In the Audio CD and DVD Movie fields, select the desired player from the drop down menu.
5. Check that the Regional Code is correct for the selected media:

IMPORTANT:Region can only be changed a limited number of times. After Changes remaining reaches zero, the region cannot be changed even Windows is reinstalled or the drive is moved to another computer.

- a. Navigate to **Start** → **Control Panel** → **System and Maintenance** → **System** → **Device Manager**.
- b. Double-click **DVD/CD-ROM drives**.
- c. Right-click **DVD drive** and click **Properties**, then click the **DVD Region** tab.
- d. Select the region suitable for the media inserted in the drive.

Discs Do Not Burn Properly

If discs can not be burned, perform the following actions one at a time to correct the problem.

1. Ensure that the default drive is record enabled:
 - a. Navigate to **Start** → **Computer** and right-click the writable ODD icon. Click **Properties**.
 - b. Select the **Recording** tab. In the **Desktop disc recording** panel, select the writable ODD from the drop down list.
 - c. Click **OK**.
2. Ensure that the software used for burning discs is the factory default. If using different software, refer to the software's user manual.

Playback is Choppy

If playback is choppy or jumps, perform the following actions one at a time to correct the problem.

1. Check that system resources are not running low:
 - a. Try closing some applications.
 - b. Reboot and try the operation again.
2. Check that the ODD controller transfer mode is set to DMA:
 - a. Navigate to **Start** → **Control Panel** → **System and Maintenance** → **System** → **Device Manager**.

-
- b. Double-click **IDE ATA/ATAPI controllers**, then right-click ATA Device 0.
 - c. Click **Properties** and select the **Advanced Settings** tab. Ensure that the **Enable DMA** box is checked and click **OK**.
 - d. Repeat for the other ATA Devices shown if applicable.

Drive Not Detected

If Windows cannot detect the drive, perform the following actions one at a time to correct the problem.

1. Restart the computer and press F2 to enter the BIOS Utility.
2. Check that the drive is detected in the **ATAPI Model Name** field on the Information page.
NOTE: Check that the entry is identical to one of the ODDs specified in “Hardware Specifications and Configurations” on page 14.
3. Turn off the power and remove the cover to inspect the connections to the ODD. See “Disassembly Process” on page 41.
 - a. Check for broken connectors on the drive, motherboard, and cables.
 - b. Check for bent or broken pins on the drive, motherboard, and cable connections.
 - c. Try an alternate cable, if available. If the drive works with the new cable, the original cable should be replaced.
4. Reseat the drive ensuring and all cables are connected correctly.
5. Replace the ODD. See “Disassembly Process” on page 41.

Drive Read Failure

If discs cannot be read when inserted in the drive, perform the following actions one at a time to correct the problem.

1. Remove and clean the failed disc.
2. Retry reading the CD or DVD.
 - d. Test the drive using other discs.
 - e. Play a DVD movie
 - f. Listen to a music CD

If the ODD works properly with alternate discs, the original disc is probably defective and should be replaced.

3. Turn off the power and remove the cover to inspect the connections to the ODD. See “Disassembly Process” on page 41.
 - a. Check for broken connectors on the drive, motherboard, and cables.
 - b. Check for bent or broken pins on the drive, motherboard, and cable connections.
 - c. Try an alternate cable, if available. If the drive works with the new cable, the original cable should be replaced.
4. Replace the ODD. See “Disassembly Process” on page 41.

Wireless Function Failure

If the **WLAN** fails, perform the following actions one at a time to correct the problem. Do not replace a non-defective FRUs:

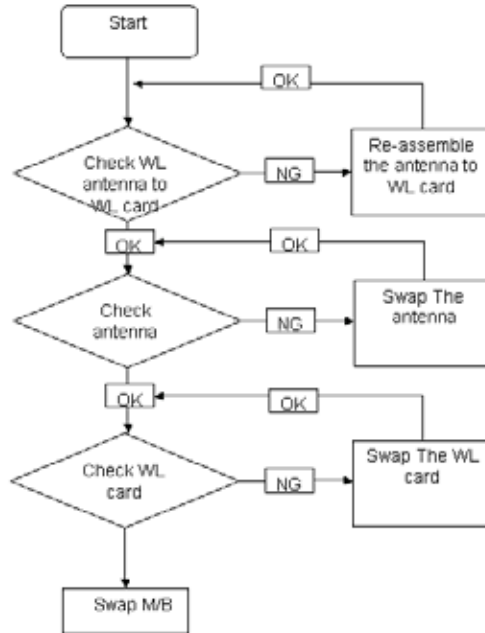

Thermal Unit Failure

If the **Thermal Unit** fails, perform the following actions one at a time to correct the problem. Do not replace a non-defective FRUs:

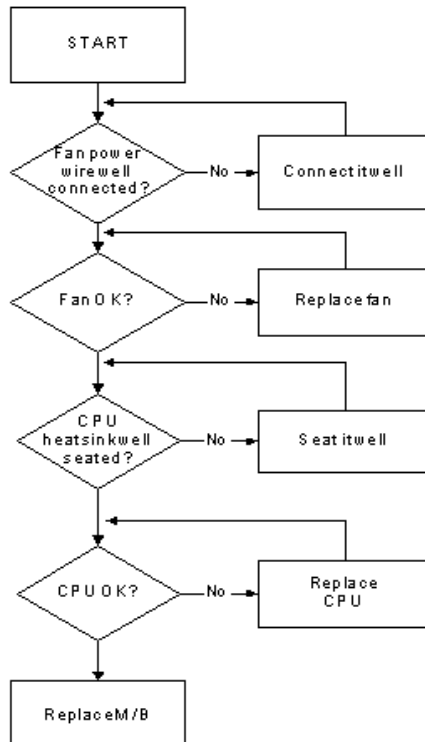

External Mouse Failure

If an external **Mouse** fails, perform the following actions one at a time to correct the problem.

1. Try an alternative mouse.
2. If the mouse uses a wireless connection, insert new batteries and confirm there is a good connection. See the mouse user manual.
3. If the mouse uses a USB connection, try an alternate USB port.
4. Try an alternative program to verify mouse operation. Reinstall the program experiencing mouse failure.
5. Restart the computer.
6. Remove any recently added hardware and associated software.
7. Remove any recently added software and reboot.
8. Restore system and file settings from a known good date using **System Restore**.

If the issue is not fixed, repeat the preceding steps and select an earlier time and date.

9. Run the Event Viewer to check the events log for errors. For more information see Windows Help and Support.
10. Roll back the mouse driver to the previous version if updated recently.
11. Remove and reinstall the mouse driver.
12. Check the Device Manager to determine that:
 - The device is properly installed. There are no red Xs or yellow exclamation marks.
 - There are no device conflicts.
 - No hardware is listed under Other Devices.
13. If the Issue is still not resolved, see "Online Support Information" on page 243.

Other Failures

If the CRT Switch, Dock, LAN Port, external MIC or Speakers, PCI Express Card, 5-in-1 Card Reader or Volume Wheel fail, perform the following general steps to correct the problem. Do not replace a non-defective FRUs:

1. Check Drive whether is OK.
2. Check Test Fixture is ok.
3. Swap M/B to Try.

Intermittent Problems

Intermittent system hang problems can be caused by a variety of reasons that have nothing to do with a hardware defect, such as: cosmic radiation, electrostatic discharge, or software errors. FRU replacement should be considered only when a recurring problem exists.

When analyzing an intermittent problem, do the following:

1. Run the advanced diagnostic test for the system board in loop mode at least 10 times.
2. If no error is detected, do not replace any FRU.
3. If any error is detected, replace the FRU. Rerun the test to verify that there are no more errors.

Undetermined Problems

The diagnostic problems does not identify which adapter or device failed, which installed devices are incorrect, whether a short circuit is suspected, or whether the system is inoperative.

Follow these procedures to isolate the failing FRU (do not isolate non-defective FRU).

NOTE: Verify that all attached devices are supported by the computer.

NOTE: Verify that the power supply being used at the time of the failure is operating correctly. (See “Power On Issue” on page 114.):

1. Power-off the computer.
2. Visually check them for damage. If any problems are found, replace the FRU.
3. Remove or disconnect all of the following devices:
 - Non-Acer devices
 - Printer, mouse, and other external devices
 - Battery pack
 - Hard disk drive
 - DIMM
 - CD-ROM/Diskette drive Module
 - PC Cards
4. Power-on the computer.
5. Determine if the problem has changed.
6. If the problem does not recur, reconnect the removed devices one at a time until you find the failing FRU.
7. If the problem remains, replace the following FRU one at a time. Do not replace a non-defective FRU:
 - System board
 - LCD assembly

Post Codes

These tables describe the POST codes and descriptions during the POST.

Post Code Range

Phase	POST Code Range
SEC	0x01 - 0x0F
PEI	0x70 - 0x9F
DXE	0x40 - 0x6F
BDS	0x10 - 0x3F
SMM	0xA0 - 0xBF
S3	0xC0 - 0xCF
ASL	0x51 – 0x55
	0xE1 – 0xE4
PostBDS	0xF9 – 0xFE
InsydeH2ODDT™ Reserve	0xD0 – 0xD7
OEM Reserve	0xE8 – 0xEB
Reserved	0xD8 – 0xE0
	0xE5 – 0xE7
	0xEC – 0xF8

SEC Phase POST Code Table

Functionality Name (Include\ PostCode.h)	Phase	Post Code	Description
SEC_SYSTEM_POWER_ON	SEC	1	CPU power on and switch to Protected mode
SEC_BEFORE_MICROCODE_PATCH	SEC	2	Patching CPU microcode
SEC_AFTER_MICROCODE_PATCH	SEC	3	Setup Cache as RAM
SEC_ACCESS_CSR	SEC	4	PCIE MMIO Base Address initial
SEC_GENERIC_MSRINIT	SEC	5	CPU Generic MSR initialization
SEC_CPU_SPEEDCFG	SEC	6	Setup CPU speed
SEC_SETUP_CAR_OK	SEC	7	Cache as RAM test
SEC_FORCE_MAX_RATIO	SEC	8	Tune CPU frequency ratio to maximum level
SEC_GO_TO_SECSTARTUP	SEC	9	Setup BIOS ROM cache
SEC_GO_TO_PEICORE	SEC	0A	Enter Boot Firmware Volume

PEI Phase POST Code Table:

Functionality Name (Include\ PostCode.h)	Phase	Post Code	Description
PEI_SIO_INIT	PEI	70	Super I/O Initialization
PEI_CPU_REG_INIT	PEI	71	CPU Early Initialization
PEI_PCIE_MMIO_INIT	PEI	74	PCIE MMIO BAR Initialization
PEI_NB_REG_INIT	PEI	75	North Bridge Early Initialization
PEI_SB_REG_INIT	PEI	76	South Bridge Early Initialization
PEI_TPM_INIT	PEI	78	TPM Initialization
PEI_SMBUS_INIT	PEI	79	SMBUS Early Initialization

Functionality Name (Include PostCode.h)	Phase	Post Code	Description
PEI_PROGRAM_CLOCK_GEN	PEI	7A	Clock Generator Initialization
PEI_IGD_EARLY_INITIAL	PEI	7B	Internal Graphic device early Initialization
PEI_HECI_INIT	PEI	7C	HECI Initialization
PEI_WATCHDOG_INIT	PEI	7D	Watchdog timer Initialization
PEI_MEMORY_INIT	PEI	7E	Memory Initial for Normal boot.
PEI_MEMORY_INIT_FOR_CRISIS	PEI	7F	Memory Initial for Crisis Recovery
PEI_MEMORY_INSTALL	PEI	80	Simple Memory test
PEI_TXTPEI	PEI	81	TXT function early Initialization
PEI_SWITCH_STACK	PEI	82	Start to use Memory
PEI_MEMORY_CALLBACK	PEI	83	Set cache for physical memory
PEI_ENTER_RECOVERY_MODE	PEI	84	Recovery device Initialization
PEI_RECOVERY_MEDIA_FOUND	PEI	85	Found Recovery image
PEI_RECOVERY_MEDIA_NOT_FOUND	PEI	86	Recovery image not found
PEI_RECOVERY_LOAD_FILE_DONE	PEI	87	Load Recovery Image completed
PEI_RECOVERY_START_FLASH	PEI	88	Start Flash BIOS with Recovery image
PEI_ENTER_DXEIPL	PEI	89	Loading BIOS image to RAM
PEI_FINDING_DXE_CORE	PEI	8A	Loading DXE core
PEI_GO_TO_DXE_CORE	PEI	8B	Enter DXE core

DXE Phase POST Code Table:

Functionality Name (Include PostCode.h)	Phase	PostCode	Description
DXE_TCGDXE	DXE	40	TPM initial in DXE
DXE_SB_SPI_INIT	DXE	41	South bridge SPI initialization
DXE_CF9_RESET	DXE	42	Setup Reset service
DXE_SB_SERIAL_GPIO_INIT	DXE	43	South bridge Serial GPIO initialization
DXE_SMMACCESS	DXE	44	Setup SMM ACCE SS service
DXE_SIO_INIT	DXE	46	Super I/O DXE initialization
DXE_LEGACY_REGION	DXE	47	Setup Legacy Region service
DXE_IDENTIFY_FLASH_DEVICE	DXE	49	Identify Flash device
DXE_FTW_INIT	DXE	4A	Fault Tolerant Write verification
DXE_VARIABLE_INIT	DXE	4B	Variable Service initialization
DXE_VARIABLE_INIT_FAIL	DXE	4C	Fail to initial Variable Service
DXE_MTC_INIT	DXE	4D	MTC Initial
DXE_CPU_INIT	DXE	4E	CPU Middle Initialization
DXE_MP_CPU_INIT	DXE	4F	Multi-processor MiddleInitialization
DXE_SMBUS_INIT	DXE	50	SMBUS Driver Initialization
DXE_SMART_TIMER_INIT	DXE	51	8259 Initialization
DXE_PCRTC_INIT	DXE	52	RTC Initialization
DXE_SATA_INIT	DXE	53	SATA Controller earlyInitialization

Functionality Name (Include PostCode.h)	Phase	PostCode	Description
DXE_SMM_CONTROLLER_INIT	DXE	54	Setup SMM Control service
DXE_LEGACY_INTERRUPT	DXE	55	Setup Legacy Interrupt service
DXE_RELOCATE_SMBASE	DXE	56	Relocate SMM BASE
DXE_FIRST_SMI	DXE	57	SMI test
DXE_VTD_INIT	DXE	58	VTD Initial
DXE_BEFORE_CSM16_INIT	DXE	59	Legacy BIOS Initialization
DXE_AFTER_CSM16_INIT	DXE	5A	Legacy interrupt function Initialization
DXE_LOAD_ACPI_TABLE	DXE	5B	ACPI Table Initialization
DXE_SB_DISPATCH	DXE	5C	Setup SB SMM Dispatcher service
DXE_SB_IOTRAP_INIT	DXE	5D	Setup SB IOTRAP Service
DXE_SUBCLASS_DRIVER	DXE	5E	Build AMT Table
DXE_PPM_INIT	DXE	5F	PPM Initialization
DXE_HECIDRV_INIT	DXE	60	HECIDRV Initialization

BDS Phase POST Code Table:

Functionality Name (Include PostCode.h)	Phase	Post Code	Description
BDS_ENTER_BDS	BDS	10	Enter BDS entry
BDS_INSTALL_HOTKEY	BDS	11	Install Hotkey service
BDS_ASF_INIT	BDS	12	ASF Initialization
BDS_PCI_ENUMERATION_START	BDS	13	PCI enumeration
BDS_BEFORE_PCIIO_INSTALL	BDS	14	PCI resource assign complete
BDS_PCI_ENUMERATION_END	BDS	15	PCI enumeration complete
BDS_CONNECT_CONSOLE_IN	BDS	16	Keyboard Controller, Keyboard and Mouse initialization
BDS_CONNECT_CONSOLE_OUT	BDS	17	Video device initialization
BDS_CONNECT_STD_ERR	BDS	18	Error report device initialization
BDS_CONNECT_USB_HC	BDS	19	USB host controller initialization
BDS_CONNECT_USB_BUS	BDS	1A	USB BUS driver initialization
BDS_CONNECT_USB_DEVICE	BDS	1B	USB device driver initialization
BDS_NO_CONSOLE_ACTION	BDS	1C	Console device initial fail
BDS_DISPLAY_LOGO_SYSTEM_INFO	BDS	1D	Display logo or system information
BDS_START_IDE_CONTROLLER	BDS	1E	IDE controller initialization
BDS_START_SATA_CONTROLLER	BDS	1F	SATA controller initialization
BDS_START_ISA_ACPI_CONTROLLER	BDS	20	SIO controller initialization
BDS_START_ISA_BUS	BDS	21	ISA BUS driver initialization
BDS_START_ISA_FDD	BDS	22	Floppy device initialization
BDS_START_ISA_SEIRAL	BDS	23	Serial device initialization
BDS_START_IDE_BUS	BDS	24	IDE device initialization
BDS_START_AHCI_BUS	BDS	25	AHCI device initialization
BDS_CONNECT_LEGACY_ROM	BDS	26	Dispatch option ROMs

Functionality Name (Include\ PostCode.h)	Phase	Post Code	Description
BDS_ENUMERATE_ALL_BOOT_OPTION	BDS	27	Get boot device information
BDS_END_OF_BOOT_SELECTION	BDS	28	End of boot selection
BDS_ENTER_SETUP	BDS	29	Enter Setup Menu
BDS_ENTER_BOOT_MANAGER	BDS	2A	Enter Boot manager
BDS_BOOT_DEVICE_SELECT	BDS	2B	Try to boot system to OS
BDS_EFI64_SHADOW_ALL_LEGACY_ROM	BDS	2C	Shadow Misc Option ROM
BDS_ACPI_S3SAVE	BDS	2D	Save S3 resume required data in RAM
BDS_READY_TO_BOOT_EVENT	BDS	2E	Last Chipset initial before boot to OS
BDS_GO_LEGACY_BOOT	BDS	2F	Start to boot Legacy OS
BDS_GO_UEFI_BOOT	BDS	30	Start to boot UEFI OS
BDS_LEGACY16_PREPARE_TO_BOOT	BDS	31	Prepare to Boot to Legacy OS
BDS_EXIT_BOOT_SERVICES	BDS	32	Send END of POST Message to ME via HECI
BDS_LEGACY_BOOT_EVENT	BDS	33	Last Chipset initial before boot to Legacy OS.
BDS_ENTER_LEGACY_16_BOOT	BDS	34	Ready to Boot Legacy OS.
BDS_RECOVERY_START_FLASH	BDS	35	Fast Recovery Start Flash.

PostBDS POST Code Table

Functionality Name (Include\ PostCode.h)	Phase	Post Code	Description
POST_BDS_NO_BOOT_DEVICE	POST_BDS	F9	No Boot Device
POST_BDS_START_IMAGE	POST_BDS	FB	UEFI Boot Start Image
POST_BDS_ENTER_INT19	POST_BDS	FD	Legacy 16 boot entry
POST_BDS_JUMP_BOOT_SECTOR	POST_BDS	FE	Try to Boot with INT 19

S3 Functions POST Code Table

Functionality Name (Include\ PostCode.h)	Phase	Post Code	Description
POST_BDS_NO_BOOT_DEVICE	POST_BDS	F9	No Boot Device
POST_BDS_START_IMAGE	POST_BDS	FB	UEFI Boot Start Image
POST_BDS_ENTER_INT19	POST_BDS	FD	Legacy 16 boot entry
POST_BDS_JUMP_BOOT_SECTOR	POST_BDS	FE	Try to Boot with INT 19

ACPI Functions POST Code Table

Functionality Name (Include\ PostCode.h)	Phase	Post Code	Description
ASL_ENTER_S1	ASL	51	Prepare to enter S1
ASL_ENTER_S3	ASL	53	Prepare to enter S3
ASL_ENTER_S4	ASL	54	Prepare to enter S4
ASL_ENTER_S5	ASL	55	Prepare to enter S5
ASL_WAKEUP_S1	ASL	E1	System wakeup from S1
ASL_WAKEUP_S3	ASL	E3	System wakeup from S3

Functionality Name (Include\ PostCode.h)	Phase	Post Code	Description
ASL_WAKEUP_S4	ASL	E4	System wakeup from S4

SMM Functions POST Code Table

Functionality Name (Include\ PostCode.h)	Phase	Post Code	Description
SMM_IDENTIFY_FLASH_DEVICE	SMM	0xA0	Identify Flash device in SMM
SMM_SMM_PLATFORM_INIT	SMM	0xA2	SMM service initial
SMM_ACPI_ENABLE_START	SMM	0xA6	OS call ACPI enable function
SMM_ACPI_ENABLE_END	SMM	0xA7	ACPI enable function complete
SMM_S1_SLEEP_CALLBACK	SMM	0xA1	Enter S1
SMM_S3_SLEEP_CALLBACK	SMM	0xA3	Enter S3
SMM_S4_SLEEP_CALLBACK	SMM	0xA4	Enter S4
SMM_S5_SLEEP_CALLBACK	SMM	0xA5	Enter S5
SMM_ACPI_DISABLE_START	SMM	0xA8	OS call ACPI disable function
SMM_ACPI_DISABLE_END	SMM	0xA9	ACPI disable function complete

InsydeH2ODDT Debugger POST Code Table

Functionality Name (Include\ PostCode.h)	PostCode	Description
Used by Insyde debugger	0x0D	Waiting for device connect
Used by Insyde debugger	0xD0	Waiting for device connect
Used by Insyde debugger	0xD1	InsydeH2ODDT Ready
Used by Insyde debugger	0xD2	EHCI not found
Used by Insyde debugger	0xD3	Debug port connect low speed device
Used by Insyde debugger	0xD4	DDT Cable become low speed device
Used by Insyde debugger	0xD5	DDT Cable Transmission Error (Get descriptor fail)
Used by Insyde debugger	0xD6	DDT Cable Transmission Error (Set Debug mode fail)
Used by Insyde debugger	0xD7	DDT Cable Transmission Error (Set address fail)

Jumper and Connector Locations

Top View

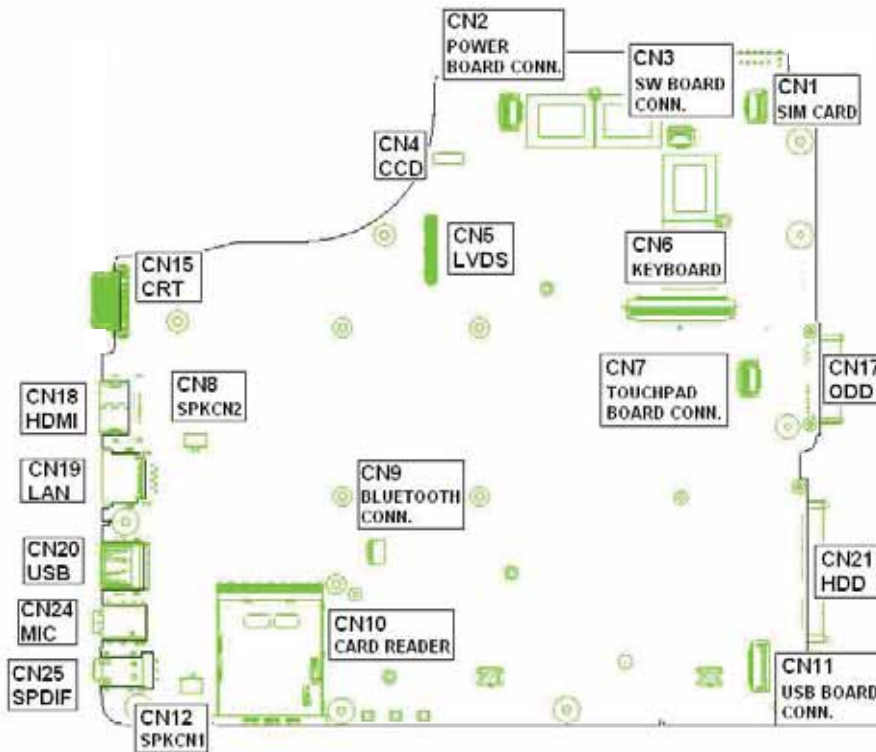

Bottom View

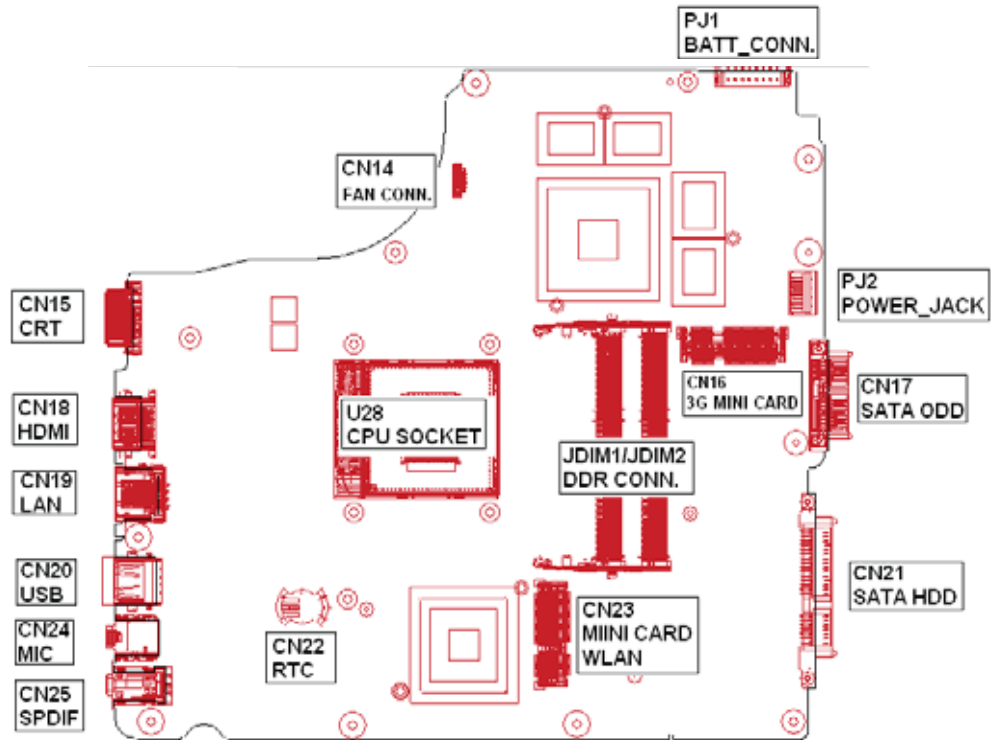

Clearing Password Check and BIOS Recovery

This section provide you the standard operating procedures of clearing password and BIOS recovery. Acer Aspire 480T provides one Hardware Open Gap on the main board for clearing password check, and one Hotkey for enabling BIOS Recovery.

Clearing Password Check

Hardware Open Gap Description is as follows:

Item	Description	Location
J1 / J2	Clear CMOS Jumpers	WiFi Bay

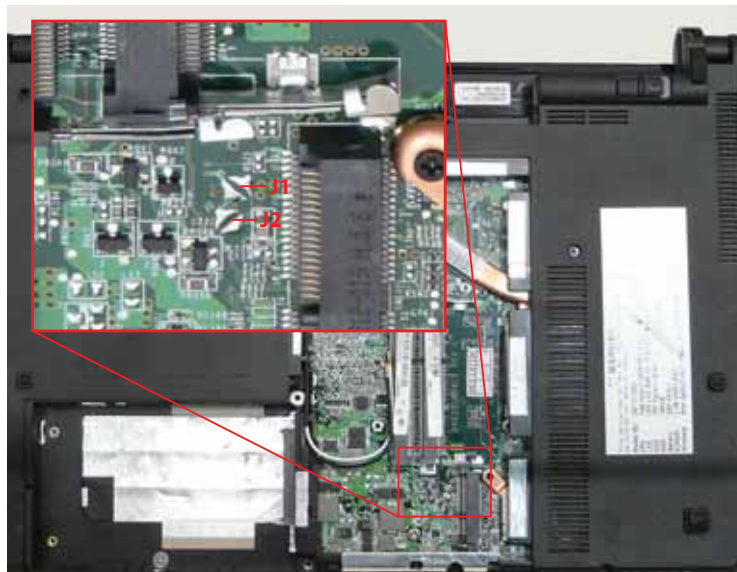

Steps for Clearing BIOS Password Check

If users set BIOS Password (Supervisor Password and/or User Password) for a security reason, BIOS will ask the password during systems POST or when systems enter to BIOS Setup menu. However, once it is necessary to bypass the password check, users need to short the HW Gap to clear the password by the following steps:

1. Power Off the system, and remove HDD, AC and Battery from the machine.
2. Open the Memory Cover of the machine and locate the J1 and J2 jumpers.
3. Use an electric conductivity tool to short the two points of the HW Gap.
4. Plug in AC, keep the short condition on the HW Gap, and press Power Button to power on the system till BIOS POST finish. Then remove the tool from the HW Gap.
5. Restart system. Press **F2** key to enter BIOS Setup menu.
6. If there is no Password request, BIOS Password is cleared. Otherwise, please follow the steps and try again.

NOTE: These steps are only for clearing BIOS Password (Supervisor Password and User Password).

BIOS Recovery by Crisis Disk

BIOS Recovery Boot Block:

BIOS Recovery Boot Block is a special block of BIOS. It is used to boot up the system with minimum BIOS initialization. Users can enable this feature to restore the BIOS firmware to a successful one once the previous BIOS flashing process failed.

BIOS Recovery Hotkey:

The system provides a function hotkey: **Fn+Esc**, for enable BIOS Recovery process when system is powered on during BIOS POST. To use this function, it is strongly recommended to have the AC adapter and Battery present. If this function is enabled, the system will force the BIOS to enter a special BIOS block, called Boot Block.

Steps for BIOS Recovery from USB Storage:

Before doing this, prepare the Crisis USB key. The Crisis USB key could be made by executing the Crisis Disk program in another system with Windows XP OS.

Follow the steps below:

1. Format the USB storage disk using the Fast Format option.
2. Save ROM file (file name: **NEW70x64.fd**) to the root directory of USB storage. Make sure that there is no other BIOS file saved in the same directory.
3. Plug USB storage into USB port.
4. Press **Fn + ESC** button then plug in AC power.
The Power button flashes once.
5. Press **Power** button to initiate system CRISIS mode.
When CRISIS is complete, the system auto restarts with a workable BIOS.
6. Update the latest version BIOS for this machine by regular BIOS flashing process.

FRU (Field Replaceable Unit) List

This chapter gives you the FRU (Field Replaceable Unit) listing in global configurations of Acer Aspire 4820T. Refer to this chapter whenever ordering for parts to repair or for RMA (Return Merchandise Authorization).

Please note that WHEN ORDERING FRU PARTS, you should check the most up-to-date information available on your regional web or channel. For whatever reasons a part number change is made, it will not be noted on the printed Service Guide. For ACER AUTHORIZED SERVICE PROVIDERS, your Acer office may have a DIFFERENT part number code from those given in the FRU list of this printed Service Guide. You MUST use the local FRU list provided by your regional Acer office to order FRU parts for repair and service of customer machines.

NOTE: To scrap or to return the defective parts, you should follow the local government ordinance or regulations on how to dispose it properly, or follow the rules set by your regional Acer office on how to return it.

Acer Aspire 4820T Exploded Diagrams

LCD Assembly

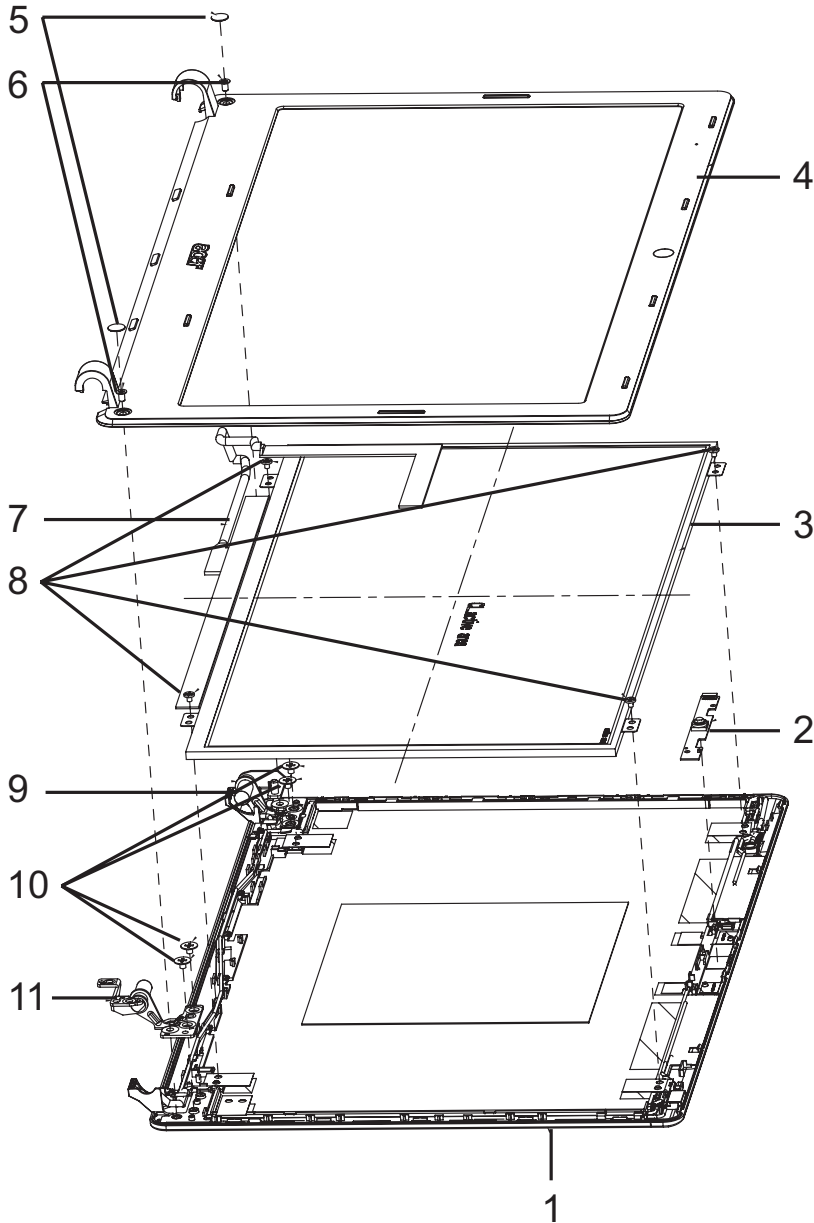

No.	Description	Acer P/N	No.	Description	Acer P/N
1	ZQ1 LCD COVER SUB ASSY (AL/3G)	60.PSR07.003	7	CABLE ASSY ZQ1LCD(19V,40/30P,WXGA,1A)FOX	50.PSR07.002
2	CAMERA CNF915721004970LH(CMOS, 1.3M, SXGA)	AM.21400.067	8	SCREW M2.0*3.0-I(BKAG)(NYLOK) IRON	86.ARE07.002
3	LCD AUO 14" WXGA	LK.14005.011	9	HINGE L SZS ZQ1	33.PSR07.002

No.	Description	Acer P/N	No.	Description	Acer P/N
4	ZQ1 LCD BEZEL SUB ASSY	60.PSR07.004	10	SCREW M2.5*3.0(ZN)(NYLOK) IRON T=0.5'	86.PSR07.002
5	LCD SCREW MYLAR ZQ1	47.PSR07.004	11	HINGE R SZS ZQ1	33.PSR07.003
6	SCREW M2.5*3.0-I(ZN)(NYLOK)IRON T=0.5	86.PSR07.003			

Chassis Assembly

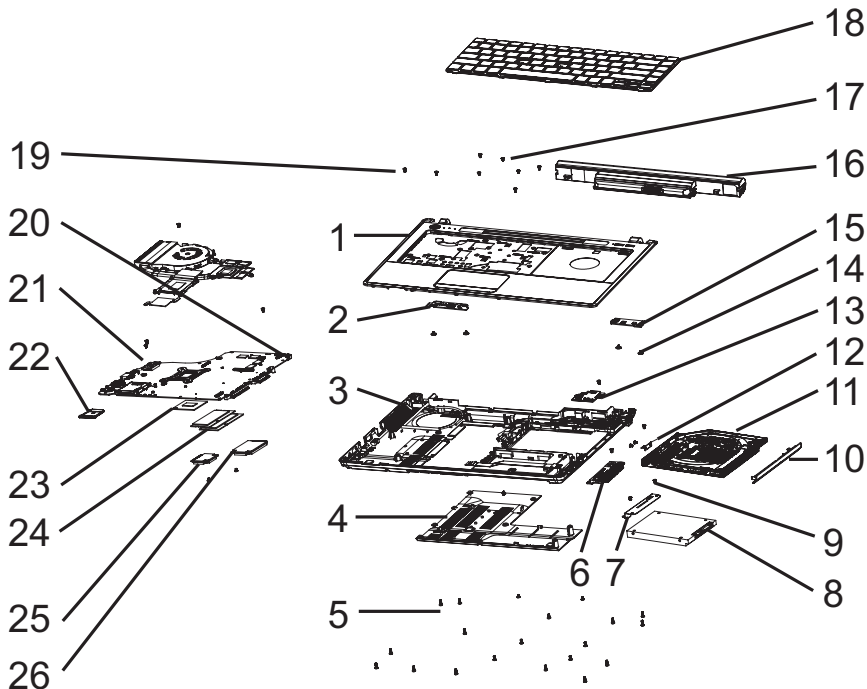







No.	Description	Acer P/N	No.	Description	Acer P/N
1	ZQ1 TOP SUB ASSY	60.PSR07.001	15	PCB ZQ1 SW/ B(4L,44*14,REVD)	
2	PCB ZQ1 POWER SW/ B(4L,59*22,REVD)	55.PSR07.001	16	BATT LI,AS10B6E 3S2P 6.0A(B) STN BSQ	BT.00606.007
3	ZQ1 BASE SUB ASSY (JM/65W)	60.PSR07.002	17	SCREW M2.0*3.0-I(BKAG)(NYLOK) IRON	86.ARE07.002
4	ZQ1 BASE DOOR ASSY (JM/CP)	42.PSR07.001	18	K/ B(UI)ZQ1(AEZQ1R00, 3A)API	
5	SCREW M2.5*6.5-I(BZN)(NYLOK-RED)D4.4 T0.8	86.ARE07.001	14	SCREW M2.5*2-I (NI,NYLOK)IRON	86.EDM07.002
6	ZQ1 USB/B ASSY	55.PSR07.002	19	SCREW M2.5*4.0-I(BKAG)(NYLOK)IRO N	86.PSR07.001

No.	Description	Acer P/N	No.	Description	Acer P/N
7	HDD-BKT ZR6(FBZR6004,REV 3A)	33.EDM07.001	20	ZQ1 MB(SG,PARK,SAM,BT ,WO CPU)ASSY	
8	HDD(160G)WD1600 BEVT-22A23T0 STN BSQ	KH.16008.027	21	WWAN MINICARD EM770W FW:11.126.07.02.00	
9	33ZQ1UB0000		22	CARD READER DUMMY CARD ZR7(EBZR7009,R3A)	42.PSR07.002
10	3GZR7CRTN10		23	CPU(988P)I5-520M 2.4G SLBNB(PGA)STN BSQ	KC.54001.DMP
11	DVD/RW/RAM TS- U633F F/W:AC00 STN BSQ	KU.0080E.027	24	RAM(2GB)DDR3 EBJ21UE8BDS0-AE-F STN BSQ	KN.2GB09.006
12	ODD BKT ZQ1(FBZQ1016,RE V3A)	33.PSR07.001	25	W/L 802.11BGN 112BN.HMWG 1X2 STN BSQ	NI.23600.047
13	ZQ1 3G/B ASSY	55.PSR07.004	26	WWAN MINICARD EM770W FW:11.126.07.02.00	

Acer Aspire 4820T FRU List

CATEGORY	DESCRIPTION	ACERPARTNO.
ADAPTER		
	Z06 ADP 19V 3.42A ADP-65JH DBA S.P	AP.06501.026
	Z06 ADP 19V 3.42A PA-1650-22 AC S.P	AP.06503.024
	Z06 ADP 19V 3.42AHP-A0652R3B1LF S.P	AP.0650A.012
	ZK6 ADP 19V 4.74A ADP-90CD DBA S.P	AP.09001.027
	ZK6 ADP 19V 4.74A PA-1900-34AR S.P	AP.09003.021
	ZK6 ADP 19V 4.74AHP-A0904A3B1LF S.P	AP.0900A.005
BATTERY		
	ZQ1 BATT LI,AS10B6E 3S2P 6.0A(B) S.P	BT.00606.009
	ZQ1 BATT LI,AS10B7E 3S2P 6.0A(B) S.P	BT.00607.128
	ZQ1 BATT LI,AS10B5E 3S2P 6.0A(B) S.P	BT.00605.063
BOARD		
	ZA8 W/L MINICARD 802.11BGN S.P	NI.23600.047
	ZY6 W/L 802.11 B/G/N H MINI(T77H047.31) S.P	NI.23600.046
	ZH8 W/L 802.11ABGN 112BN.HMWG 1X2 S.P	KI.CPH01.001
	ZH7 W/L 802.11ABG 112BG.HMWG 1X2 S.P	KI.CPH01.002
	ZQ1 WLAN 802.11ABGN 622AN.HMWG.QS(2X2) S.P	KI.PPH01.002
	ZY9 BLUETOOTH T60H928.33 S.P	BH.21100.004
	ZQ1 POWER SW/B S.P	55.PSR07.001
	ZQ1 USB/B S.P	55.PSR07.002
	ZQ1 SW/B S.P	55.PSR07.003
	ZQ1 3G/B S.P	55.PSR07.004
CABLE		
	ZR1 PWR CORD V943B30001218008 DANISH S/P	27.A03V7.006
	ZR1 PWR CORD(ISR)1.8M 3PBLK S/P	27.TATV7.005
	ZR1 PWR CORD V50CB3T3012180QD TW S/P	27.A99V7.002
	ZR1 POWER CORD(SWI)1.8M 3PBLACK S/P	27.A99V7.004
	ZR1 POWER CORD(IT) 1.8M 3P S/P	27.A99V7.005
	ZR1 POWER CORD(S.A) 1.8M 3BLACK S/P	27.T48V7.001
	ZB1 PWR CORD US S/P	27.TAXV7.001
	ZR1 POWER CORD(EU) 1.8M 3PBLACK S/P	27.TATV7.001
	BL3 POWER CORD BRAZIL 3P S/P	27.S0607.001
	ET2S POWER CORD S/P-UK	27.A03V7.004
	ZQ1 BLUETOOTH CABLE ASSY(5P/8P,1A)S.P	50.PSR07.001

CATEGORY	DESCRIPTION	ACERPARTNO.
CASE/COVER/BRACKET ASSEMBLY		
	ZQ1B TOP SUB (JM) S.P	60.PSN07.001
	ZQ1B BASE SUB (JM/65W W/3G) S.P	60.PVK07.001
	ZQ1B BASE SUB (JM/65W/WO3G) S.P	60.PSN07.002
	ZQ1B BASE SUB (JM/90W W/3G) S.P	60.PVL07.001
	ZQ1B BASE SUB (JM/90W/WO3G) S.P	60.PSG07.001
	ZQ1B BASE DOOR (JM/CP) S.P	42.PSN07.001
	ZQ1 READER DUMMY CARD S.P	42.PSR07.002
CPU/PROCESSOR		
	ZY9 CPU(988P)I3-330M 2.13G SLBMD(PGA)S.P	KC.33001.DMP
	ZY9 CPU(988P)I3-350M 2.26G SLBPK(PGA)S.P	KC.35001.DMP
	ZY9 CPU(988P)I5-430M 2.26G SLBPN(PGA)S.P	KC.43001.DMP
	ZY9 CPU(988P)I5-520M 2.4G SLBNB(PGA)S.P	KC.52001.DMP
	ZY9 CPU(988P)I5-540M 2.53G SLBPG(PGA)S.P	KC.54001.DMP
	ZY9 CPU(988P)I7-620M 2.66G SLBPD(PGA)S.P	KC.62001.DMP
DVD RW DRIVE		
	ODD SUPER MULTI 9.5mm MODULE ASSY 8X	6M.PSN07.001
	ZQ1B DVD/RW/RAM TS-U633F F/W:AC00 S.P	KU.00801.034
		KU.00801.037
	ZQ1B DVD+/-RW/RAM UJ892ABAA-M S.P	KU.00807.068
	ZQ1B DVD+/-RW/RAM GU10N S.P	KU.0080D.049
	ZR7 ODD BEZEL SUPER MULTI S.P	42.PSN07.002
	ZQ1 ODD BKT (FBZQ1016,REV3A) S.P	33.PSR07.001

CATEGORY	DESCRIPTION	ACERPARTNO.
HDD/HARD DISK DRIVE		
	ZQ1 HDD(160G)WD1600BEVT-22A23T0 S.P	KH.16008.027
	ZH7 HDD(160G)ST9160314AS 9HH13C-188 STN BSQ	KH.16001.042
	ZQ1 HDD(160G) MK1665GSX-EUL S.P	KH.16004.008
	ZH7 HDD(160G) HTS545016B9A300 S.P	KH.16007.026
	ZQ1 HDD(250G)WD2500BEVT-22A23T0 S.P	KH.25008.025
	Z06 HDD(250G)ST9250315AS 9HH132-188 S.P	KH.25001.016
	ZQ1 HDD(250G) MK2565GSX-EUL S.P	KH.25004.005
	ZH7 HDD(250G)HTS545025B9A300 S.P	KH.25007.016
	ZQ1 HDD(320G)WD3200BEVT-22A23T0 S.P	KH.32008.019
	ZH7 HDD(320G)ST9320325AS 9HH13E-188 S.P	KH.32001.017
	ZQ1 HDD(320G) MK3265GSX-EUL S.P	KH.32004.004
	ZH7 HDD(320G) HTS545032B9A300 S.P	KH.32007.008
	ZQ1 HDD(500G)WD5000BEVT-22A0RT0 S.P	KH.50008.017
	ZK2 HDD(500G) ST9500325AS S.P	KH.50001.011
	ZQ1 HDD(500G) MK5065GSX-EUL S.P	KH.50004.002
	ZH7 HDD(500G) HTS545050B9A300 S.P	KH.50007.010
	ZY9 HDD(640GB)WD6400BEVT-22A0RT0 S.P	KH.64008.004
	ZR6 HDD-BKT S.P	33.EDM07.001

CATEGORY	DESCRIPTION	ACERPARTNO.
KEYBOARD		
	ZQ1 K/B(ARAB-EN) S.P	KB.I140A.204
	ZQ1 K/B(BELGIUM) S.P	KB.I140A.205
	ZQ1 K/B(BRAZIL) S.P	KB.I140A.206
	ZQ1 K/B(CZ-SLOVAK) S.P	KB.I140A.207
	ZQ1 K/B(TAIWAN) S.P	KB.I140A.208
	ZQ1 K/B(DANISH) S.P	KB.I140A.209
	ZQ1 K/B(ARAB-FR) S.P	KB.I140A.210
	ZQ1 K/B(FRENCH) S.P	KB.I140A.211
	ZQ1 K/B(GERMAN) S.P	KB.I140A.212
	ZQ1 K/B(GREEK) S.P	KB.I140A.213
	ZQ1 K/B(HUNGARIAN) S.P	KB.I140A.214
	ZQ1 K/B(ITALIAN) S.P	KB.I140A.215
	ZQ1 K/B(JAPAN) S.P	KB.I140A.216
	ZQ1 K/B(KOREA) S.P	KB.I140A.217
	ZQ1 K/B(NORDICS) S.P	KB.I140A.218
	ZQ1 K/B(NORWEGIAN) S.P	KB.I140A.219
	ZQ1 K/B(PORTUGUESE) S.P	KB.I140A.220
	ZQ1 K/B(RUSSIAN) S.P	KB.I140A.221
	ZQ1 K/B(CROATIAN) S.P	KB.I140A.222
	ZQ1 K/B(SPANISH) S.P	KB.I140A.223
	ZQ1 K/B(SWEDISH) S.P	KB.I140A.224
	ZQ1 K/B(SWISS) S.P	KB.I140A.225
	ZQ1 K/B(THAI) S.P	KB.I140A.226
	ZQ1 K/B(TURKISH) S.P	KB.I140A.227
ZQ1 K/B(UK) S.P	KB.I140A.228	
ZQ1 K/B(UI) S.P	KB.I140A.229	
ZQ1 K/B(HEBREW) S.P	KB.I140A.230	
ZQ1 K/B(US-FR-CAN) S.P	KB.I140A.231	
LCD MODULE		
	LCD MODULE 14 IN. ASSY AL W/ANTENNA *2	6M.PSN07.002
	ZQ1 LCD 14" HD B140XW03 V0 (0A) S.P	LK.14005.011
	ZQ1 LCD 14" HD LP140WH2-TLL1 S.P	LK.14008.006
	ZQ1 LCD 14" HD N140B6-L24 S.P	LK.1400D.007
	ZQ1 LCD 14" HD LTN140AT12-A01 S.P	LK.14006.012
	ZQ1 LCD CABLE(19V,40/30P,WXGA,1A) S.P	50.PSR07.002
	ZQ1B LCD COVER SUB (AL/WO3G) S.P	60.PSN07.003

CATEGORY	DESCRIPTION	ACERPARTNO.
	ZQ1 LCD BEZEL SUB S.P	60.PSR07.004
	ZQ1 HINGE L (FBZQ1006,REV3A)S.P	33.PSR07.002
	ZQ1 HINGE R (FBZQ1009,REV3A)S.P	33.PSR07.003
CCD 	ZQ1 CAMERA 09P2BF127 S.P	AM.21400.068
	ZQ1 CAMERA CNF915721004970LH S.P	AM.21400.067
	ZQ1 CAMERA 09P2SF119 S.P	AM.21400.069
	ZQ1 CAMERA 09P2BF127 S.P	AM.21400.070
LCD MODULE		
	LCD MODULE 14 IN. ASSY AL W/ANTENNA *3 FOR 3G	6M.PVK07.001
	ZQ1 LCD 14" HD B140XW03 V0 (0A) S.P	LK.14005.011
	ZQ1 LCD 14" HD LP140WH2-TLL1 S.P	LK.14008.006
	ZQ1 LCD 14" HD N140B6-L24 S.P	LK.1400D.007
	ZQ1 LCD 14" HD LTN140AT12-A01 S.P	LK.14006.012
	ZQ1 LCD CABLE(19V,40/30P,WXGA,1A) S.P	50.PSR07.002
	ZQ1B LCD COVER SUB (AL/3G) S.P	60.PVK07.002
	ZQ1 LCD BEZEL SUB S.P	60.PSR07.004
	ZQ1 HINGE L (FBZQ1006,REV3A)S.P	33.PSR07.002
	ZQ1 HINGE R (FBZQ1009,REV3A)S.P	33.PSR07.003
	ZQ1 CAMERA 09P2BF127 S.P	AM.21400.068
	ZQ1 CAMERA CNF915721004970LH S.P	AM.21400.067
	ZQ1 CAMERA 09P2SF119 S.P	AM.21400.069
	ZQ1 CAMERA 09P2BF127 S.P	AM.21400.070
MAINBOARD		
	ZQ1B MB (UMA,BT,3G,WO CPU)S.P	MB.PSN06.001
	ZQ1B MB(SG,MADS,SAM,BT,WO 3G/CPU)S.P	MB.PSE06.001
	MAINBOARD HM55 SG PARK_XT512 W/CARD READER WO/CPU RAM	MB.PSG06.001
MEMORY		

CATEGORY	DESCRIPTION	ACERPARTNO.
	ZE8 RAM(1GB)DDR3 EBJ10UE8BDS0-AE-F S.P	KN.1GB09.012
	ZR6 RAM(1G)DDR3 M471B2873EH1-CF8 S.P	KN.1GB0B.028
	ZE9 RAM(1GB)DDR3 HMT112S6BFR6C N0 LF S.P	KN.1GB0G.025
	ZQ1 RAM(1GB)DDR3 EBJ10UE8BDS0-DJ-F S.P	KN.1GB09.015
	ZQ1 RAM(1GB)DDR3 M471B2873FHS-CH9 S.P	KN.1GB0B.035
	ZE8 RAM(2GB)DDR3 EBJ21UE8BDS0-AE-F S.P	KN.2GB09.006
	ZR6 RAM(2GB)DDR3 M471B5673EH1-CF8 S.P	KN.2GB0B.012
	ZK6 RAM(2GB)DDR3 HMT125S6BFR8C-G7 S,P	KN.2GB0G.014
	ZQ1 RAM(2GB)DDR3 EBJ21UE8BDS0-DJ-F S.P	KN.2GB09.007
	ZQ1 RAM(2GB)DDR3 M471B5673FH0-CH9 S.P	KN.2GB0B.023
	ZQ1 RAM(4GB)DDR3 EBJ41UF8BAS0-DJ-F S.P	KN.4GB09.001
HEATSINK		
	ZQ1 THERMAL MODULE ASSY 35W UMA S.P	60.PSR07.005
	ZQ1 THERMAL MODULE ASSY 35W DIS S.P	60.PSM07.002
	ZQ1 HEAT SINK PCH(FBZQ1024,REV3A)S.P	60.PSR07.006
SPEAKER		
	ZQ1B SPK ASSY(WITH L) S.P	23.PSN07.001
	ZQ1B SPK ASSY(WITH R) S.P	23.PSN07.002
MISCELLANEOUS		
	ZQ1 BASE FOOT RUBBER F S.P	47.PSR07.001
	ZQ1 BASE FOOT RUBBER M S.P	47.PSR07.002
	ZQ1 BASE FOOT RUBBER REAR S.P	47.PSR07.003
	ZQ1 LCD RUBBER-1 S.P	47.PSR07.004
	ZQ1 LCD RUBBER-2 S.P	47.PSR07.005
	ZQ1 DOOR FOOT RUBBER-1 S.P	47.PSR07.006
	ZQ1 HDD RUBBER-1 S.P	47.PSR07.008
	ZQ1 HDD RUBBER-2 S.P	47.PSR07.009
	ZQ1 TOP HDD RUBBER-1 S.P	47.PSR07.010

Screw List

CATEGORY	DESCRIPTION	ACERPARTNO.
SCREW		
	ZY6 SCREW M2.0*3.0-I(BKAG)(NYLOK IRONS.P	86.ARE07.002
	TE1 SCREW M2.0*6.0-I SP	86.S6507.001
	SCREW M2.5*4.0-I(BKAG)(NYLOK)IRON	86.PSR07.001
	ZY2 SCREW M2.5*6.5-I(BZN(NYLOK-RED) S.P	86.ARE07.001
	ZR6 SCREW M2.5*2-I (NI,NYLOK)IRON S.P	86.EDM07.002
	ZY5D SCREW M3*0.5+3.5I S.P	86.N1407.007
	ZY2 SCREW M2.5*3.0-I(BZN) S.P	86.TPK07.003
	AJ2 SCREW M2-0.4*2-I(BNI)(NYLOK)IRON S.P	86.W4107.002
	ZQ1 SCREW M2.5*3.0-I(ZN) T=0.5 S.P	86.PSR07.002
	ZA3 SCREW M2.0*3.0-I(BKAG)(NYLOK)IRON SP	86.PSR07.003

Model Definition and Configuration

Acer Aspire 4820T Series

Country	Acer Part No	RO	Description
China	LX.PSE 02.098	CHINA	AS4820TG-432G32Mn W7HP64SCATCN1 MC MADISON_PRO1GBCKs_3V3 1*2G/320/BT/6L3.0/5R/ cb_bgn_1.3C_AL_SC14
China	LX.PSE 02.127	CHINA	AS4820TG-332G32Mn W7HP64SCATCN1 MC MADISON_PRO1GBCKs_3V3 1*2G/320/BT/6L3.0/5R/ cb_bgn_1.3C_AL_SC14
Switzerland	LX.PSE 02.118	EMEA	AS4820TG-434G50Mn W7HP64ATCH1 MC MADISON_PRO1GBCKs_3V3 2*2G/500_L/BT/6L3.0/5R/ cb_bgn_1.3C_AL_IT41
GCTWN	LX.PSE 02.111	TWN	AS4820TG-524G64Mn W7HP64ATTW1 MC MADISON_PRO1GBCKs_3V3 2*2G/640/BT/6L3.0/5R/ cb_bgn_1.3C_AL_TC11
Germany	LX.PSE 02.177	EMEA	AS4820TG-434G50Mn W7HP64ATDE1 MC MADISON_PRO1GBCKs_3V3 2*2G/500_L/BT/6L3.0/5R/ cb_bgn_1.3C_AL_DE11
South Africa	LX.PSE 02.169	EMEA	AS4820TG-434G50Mn EM W7HP64EMATZA1 MC MADISON_PRO1GBCKs_3V3 2*2G/500_L/BT/6L3.0/5R/ cb_bgn_1.3C_AL_ES81
Middle East	LX.PSE 02.167	EMEA	AS4820TG-434G50Mn EM W7HP64EMATME2 MC MADISON_PRO1GBCKs_3V3 2*2G/500_L/BT/6L3.0/5R/ cb_bgn_1.3C_AL_AR11
Middle East	LX.PSE 02.168	EMEA	AS4820TG-434G50Mn EM W7HP64EMATME4 MC MADISON_PRO1GBCKs_3V3 2*2G/500_L/BT/6L3.0/5R/ cb_bgn_1.3C_AL_ES61
Middle East	LX.PSE 02.166	EMEA	AS4820TG-434G50Mn EM W7HP64EMATME3 MC MADISON_PRO1GBCKs_3V3 2*2G/500_L/BT/6L3.0/5R/ cb_bgn_1.3C_AL_ES81
Middle East	LX.PSE 02.165	EMEA	AS4820TG-434G50Mn EM W7HP64EMATME6 MC MADISON_PRO1GBCKs_3V3 2*2G/500_L/BT/6L3.0/5R/ cb_bgn_1.3C_AL_ES61
South Africa	LX.PSE 02.164	EMEA	AS4820TG-434G50Mn EM W7HP64EMATZA4 MC MADISON_PRO1GBCKs_3V3 2*2G/500_L/BT/6L3.0/5R/ cb_bgn_1.3C_AL_ES61
Poland	LX.PSE 02.163	EMEA	AS4820TG-434G50Mn W7HP64ATPL1 MC MADISON_PRO1GBCKs_3V3 2*2G/500_L/BT/6L3.0/5R/ cb_bgn_1.3C_AL_PL11
Baltic	LX.PSE 02.162	EMEA	AS4820TG-434G50Mn W7HP64ATBC5 MC MADISON_PRO1GBCKs_3V3 2*2G/500_L/BT/6L3.0/5R/ cb_bgn_1.3C_AL_LT11
Holland	LX.PSE 02.161	EMEA	AS4820TG-434G50Mn W7HP64ATNL1 MC MADISON_PRO1GBCKs_3V3 2*2G/500_L/BT/6L3.0/5R/ cb_bgn_1.3C_AL_NL11

Country	Acer Part No	RO	Description
Luxembourg	LX.PSE 02.159	EMEA	AS4820TG-434G50Mn W7HP64ATLU3 MC MADISON_PRO1GBCKs_3V3 2*2G/500_L/BT/6L3.0/5R/ cb_bgn_1.3C_AL_IT41
Belgium	LX.PSE 02.160	EMEA	AS4820TG-434G50Mn W7HP64ATBE1 MC MADISON_PRO1GBCKs_3V3 2*2G/500_L/BT/6L3.0/5R/ cb_bgn_1.3C_AL_NL11
Latvia	LX.PSE 02.158	EMEA	AS4820TG-434G50Mn W7HP64ATLV1 MC MADISON_PRO1GBCKs_3V3 2*2G/500_L/BT/6L3.0/5R/ cb_bgn_1.3C_AL_LT11
Latvia	LX.PSE 02.157	EMEA	AS4820TG-434G50Mn W7HP64ATLV1 MC MADISON_PRO1GBCKs_3V3 2*2G/500_L/BT/6L3.0/5R/ cb_bgn_1.3C_AL_RU22
UK	LX.PSE 02.156	EMEA	AS4820TG-434G50Mn W7HP64ATGB1 MC MADISON_PRO1GBCKs_3V3 2*2G/500_L/BT/6L3.0/5R/ cb_bgn_1.3C_AL_EN11
Eastern Europe	LX.PSE 02.155	EMEA	AS4820TG-434G50Mn W7HP64ATEU5 MC MADISON_PRO1GBCKs_3V3 2*2G/500_L/BT/6L3.0/5R/ cb_bgn_1.3C_AL_RO11
Czech	LX.PSE 02.153	EMEA	AS4820TG-434G50Mn W7HP64ATCZ2 MC MADISON_PRO1GBCKs_3V3 2*2G/500_L/BT/6L3.0/5R/ cb_bgn_1.3C_AL_SK11
Eastern Europe	LX.PSE 02.154	EMEA	AS4820TG-434G50Mn W7HP64ATEU5 MC MADISON_PRO1GBCKs_3V3 2*2G/500_L/BT/6L3.0/5R/ cb_bgn_1.3C_AL_PL71
Hungary	LX.PSE 02.152	EMEA	AS4820TG-434G50Mn W7HP64ATHU1 MC MADISON_PRO1GBCKs_3V3 2*2G/500_L/BT/6L3.0/5R/ cb_bgn_1.3C_AL_HU11
Israel	LX.PSE 02.151	EMEA	AS4820TG-434G50Mn W7HP64ATIL1 MC MADISON_PRO1GBCKs_3V3 2*2G/500_L/BT/6L3.0/5R/ cb_bgn_1.3C_AL_HE11
Baltic	LX.PSE 02.150	EMEA	AS4820TG-434G50Mn W7HP64ATBC4 MC MADISON_PRO1GBCKs_3V3 2*2G/500_L/BT/6L3.0/5R/ cb_bgn_1.3C_AL_LT11
Portugal	LX.PSE 02.149	EMEA	AS4820TG-434G50Mn W7HP64ATPT1 MC MADISON_PRO1GBCKs_3V3 2*2G/500_L/BT/6L3.0/5R/ cb_bgn_1.3C_AL_PT11
Cyprus	LX.PSE 02.148	EMEA	AS4820TG-434G50Mn W7HP64ATCY1 MC MADISON_PRO1GBCKs_3V3 2*2G/500_L/BT/6L3.0/5R/ cb_bgn_1.3C_AL_ES61
Baltic	LX.PSE 02.147	EMEA	AS4820TG-434G50Mn W7HP64ATBC3 MC MADISON_PRO1GBCKs_3V3 2*2G/500_L/BT/6L3.0/5R/ cb_bgn_1.3C_AL_SV21
Serbia/ Macedonia	LX.PSE 02.146	EMEA	AS4820TG-434G50Mn W7HP64ATCS1 MC MADISON_PRO1GBCKs_3V3 2*2G/500_L/BT/6L3.0/5R/ cb_bgn_1.3C_AL_SL11
Italy	LX.PSE 02.145	EMEA	AS4820TG-434G50Mn W7HP64ATIT1 MC MADISON_PRO1GBCKs_3V3 2*2G/500_L/BT/6L3.0/5R/ cb_bgn_1.3C_AL_IT11
Spain	LX.PSE 02.144	EMEA	AS4820TG-434G50Mn W7HP64ATES1 MC MADISON_PRO1GBCKs_3V3 2*2G/500_L/BT/6L3.0/5R/ cb_bgn_1.3C_AL_ES51

Country	Acer Part No	RO	Description
Denmark	LX.PSE 02.143	EMEA	AS4820TG-434G50Mn W7HP64ATDK2 MC MADISON_PRO1GBCKs_3V3 2*2G/500_L/BT/6L3.0/5R/ cb_bgn_1.3C_AL_ENS1
Eastern Europe	LX.PSE 02.142	EMEA	AS4820TG-434G50Mn W7HP64ATEU7 MC MADISON_PRO1GBCKs_3V3 2*2G/500_L/BT/6L3.0/5R/ cb_bgn_1.3C_AL_ENQ1
Eastern Europe	LX.PSE 02.141	EMEA	AS4820TG-434G50Mn W7HP64ATEU4 MC MADISON_PRO1GBCKs_3V3 2*2G/500_L/BT/6L3.0/5R/ cb_bgn_1.3C_AL_SV21
Austria	LX.PSE 02.139	EMEA	AS4820TG-434G50Mn W7HP64ATAT1 MC MADISON_PRO1GBCKs_3V3 2*2G/500_L/BT/6L3.0/5R/ cb_bgn_1.3C_AL_DE61
Greece	LX.PSE 02.140	EMEA	AS4820TG-434G50Mn W7HP64ATGR1 MC MADISON_PRO1GBCKs_3V3 2*2G/500_L/BT/6L3.0/5R/ cb_bgn_1.3C_AL_EL31
France	LX.PSE 02.138	EMEA	AS4820TG-434G50Mn W7HP64ATFR1 MC MADISON_PRO1GBCKs_3V3 2*2G/500_L/BT/6L3.0/5R/ cb_bgn_1.3C_AL_FR21
Eastern Europe	LX.PSE 02.137	EMEA	AS4820TG-434G50Mn W7HP64ATEU7 MC MADISON_PRO1GBCKs_3V3 2*2G/500_L/BT/6L3.0/5R/ cb_bgn_1.3C_AL_SL11
Ukraine	LX.PSE 02.136	EMEA	AS4820TG-434G50Mn W7HP64RUATUK1 MC MADISON_PRO1GBCKs_3V3 2*2G/500_L/BT/6L3.0/5R/ cb_bgn_1.3C_AL_RU61
Middle East	LX.PSE 02.135	EMEA	AS4820TG-434G50Mn EM W7HP64EMATME4 MC MADISON_PRO1GBCKs_3V3 2*2G/500_L/BT/6L3.0/5R/ cb_bgn_1.3C_AL_RU61
Middle East	LX.PSE 02.134	EMEA	AS4820TG-434G50Mn EM W7HP64EMATME2 MC MADISON_PRO1GBCKs_3V3 2*2G/500_L/BT/6L3.0/5R/ cb_bgn_1.3C_AL_ES61
South Africa	LX.PSE 02.133	EMEA	AS4820TG-434G50Mn EM W7HP64EMATZA2 MC MADISON_PRO1GBCKs_3V3 2*2G/500_L/BT/6L3.0/5R/ cb_bgn_1.3C_AL_ES61
Middle East	LX.PSE 02.132	EMEA	AS4820TG-434G50Mn EM W7HP64EMATMEB MC MADISON_PRO1GBCKs_3V3 2*2G/500_L/BT/6L3.0/5R/ cb_bgn_1.3C_AL_ARA1
Middle East	LX.PSE 02.131	EMEA	AS4820TG-434G50Mn EM W7HP64EMATME2 MC MADISON_PRO1GBCKs_3V3 2*2G/500_L/BT/6L3.0/5R/ cb_bgn_1.3C_AL_AR21
South Africa	LX.PSE 02.130	EMEA	AS4820TG-434G50Mn EM W7HP64EMATZA5 MC MADISON_PRO1GBCKs_3V3 2*2G/500_L/BT/6L3.0/5R/ cb_bgn_1.3C_AL_ES61
Middle East	LX.PSE 02.129	EMEA	AS4820TG-434G50Mn EM W7HP64EMATME9 MC MADISON_PRO1GBCKs_3V3 2*2G/500_L/BT/6L3.0/5R/ cb_bgn_1.3C_AL_ES81
Algeria	LX.PSE 02.128	EMEA	AS4820TG-434G50Mn EM W7HP64EMATDZ1 MC MADISON_PRO1GBCKs_3V3 2*2G/500_L/BT/6L3.0/5R/ cb_bgn_1.3C_AL_ES81
Middle East	LX.PSE 02.126	EMEA	AS4820TG-434G50Mn EM W7HP64EMATME2 MC MADISON_PRO1GBCKs_3V3 2*2G/500_L/BT/9L3.0/5R/ cb_bgn_1.3C_AL_AR21

Country	Acer Part No	RO	Description
Thailand	LX.PSE 02.122	AAP	AS4820TG-432G50Mn EM W7HP64EMATTH1 MC MADISON_PRO1GBCKs_3V3 1*2G/500_L/BT/9L3.0/5R/ cb_bgn_1.3C_AL_TH41
Middle East	LX.PSE 02.125	EMEA	AS4820TG-434G32Mn EM W7HP64EMATME2 MC MADISON_PRO1GBCKs_3V3 2*2G/320/BT/9L3.0/5R/ cb_bgn_1.3C_AL_AR21
France	LX.PSE 02.117	EMEA	AS4820TG-434G50Mn W7HP64ATFR1 MC MADISON_PRO1GBCKs_3V3 2*2G/500_L/6L3.0/5R/ cb_bgn_1.3C_AL_FR21
GCTWN	LX.PSE 02.124	TWN	AS4820TG-624G64Mn W7HP64ATTW1 MC MADISON_PRO1GBCKs_3V3 2*2G/640/BT/9L3.0/5R/ cb_bgn_1.3C_AL_TC11
Thailand	LX.PSE 02.123	AAP	AS4820TG-432G50Mn EM W7HP64EMATTH1 MC MADISON_PRO1GBCKs_3V3 1*2G/500_L/BT/6L3.0/5R/ cb_bgn_1.3C_AL_TH41
Denmark	LX.PSE 02.022	EMEA	AS4820TG-434G64Mn W7HP64ATDK2 MC MADISON_PRO1GBCKs_3V3 2*2G/640/BT/6L3.0/5R/ cb_bgn_1.3C_AL_ENS1
Germany	LX.PSE 02.082	EMEA	AS4820TG-436G64Mn W7HP64ATDE1 MC MADISON_PRO1GBCKs_3V3 4G+2G/640/BT/9L3.0/5R/ cb_bgn_1.3C_AL_DE11
WW	S2.PSE 02.005	WW	AS4820TG-434G32Mn W7HP64AWW1 MC MADISON_PRO1GBCKs_3V3 2*2G/320/6L3.0/5R/ cb_bgn_1.3C_AL_ES62
Russia	LX.PSE 02.121	EMEA	AS4820TG-434G50Mi W7HP64RUATRU1 MC MADISON_PRO1GBCKs_3V3 2*2G/500_L/BT/6L3.0/5R/ cb_bg_1.3C_AL_RU11
Turkey	LX.PSE 02.120	EMEA	AS4820TG-434G50Mn EM W7HP64EMATTR1 MC MADISON_PRO1GBCKs_3V3 2*2G/500_L/BT/6L3.0/5R/ cb_bgn_1.3C_AL_TR31
Turkey	LX.PSE 02.119	EMEA	AS4820TG-353G32Mn EM W7HP64EMATTR1 MC MADISON_PRO1GBCKs_3V3 2G+1G/320/BT/6L3.0/5R/ cb_bgn_1.3C_AL_TR31
France	LX.PSE 02.116	EMEA	AS4820TG-334G50Mn W7HP64ATFR1 MC MADISON_PRO1GBCKs_3V3 2*2G/500_L/6L3.0/5R/ cb_bgn_1.3C_AL_FR21
France	LX.PSE 02.115	EMEA	AS4820TG-624G50Mn W7HP64ATFR1 MC MADISON_PRO1GBCKs_3V3 2*2G/500_L/6L3.0/5R/ cb_bgn_1.3C_AL_FR21
Singapore	LX.PSE 02.104	AAP	AS4820TG-624G64Mn W7HP64ATSG1 MC MADISON_PRO1GBCKs_3V3 2*2G/640/BT/6L3.0/5R/ cb_bgn_1.3C_AL_ZH31
Malaysia	LX.PSE 02.114	AAP	AS4820TG-524G50Mn EM W7HP64EMATMY1 MC MADISON_PRO1GBCKs_3V3 2*2G/500_L/BT/6L3.0/5R/ cb_bgn_1.3C_AL_ES61
GCTWN	LX.PSE 02.113	TWN	AS4820TG-432G50Mn W7HP64ATTW1 MC MADISON_PRO1GBCKs_3V3 1*2G/500_L/BT/6L3.0/5R/ cb_bgn_1.3C_AL_TC11
GCTWN	LX.PSE 02.112	TWN	AS4820TG-524G64Mn W7HP64ATTW1 MC MADISON_PRO1GBCKs_3V3 2*2G/640/BT/9L3.0/5R/ cb_bgn_1.3C_AL_TC11

Country	Acer Part No	RO	Description
GCTWN	LX.PSE 02.110	TWN	AS4820TG-432G64Mn W7HP64ATTW1 MC MADISON_PRO1GBCKs_3V3 1*2G/640/BT/9L3.0/5R/ cb_bgn_1.3C_AL_TC11
Indonesia	LX.PSE 02.109	AAP	AS4820TG-524G50Mn EM W7HP64EMATID1 MC MADISON_PRO1GBCKs_3V3 2*2G/500_L/BT/9L3.0/5R/ cb_bgn_1.3C_AL_ID21
Indonesia	LX.PSE 02.108	AAP	AS4820TG-524G50Mn EM W7HP64EMATID1 MC MADISON_PRO1GBCKs_3V3 2*2G/500_L/BT/6L3.0/5R/ cb_bgn_1.3C_AL_ID21
GCTWN	LX.PSE 02.107	TWN	AS4820TG-432G64Mn W7HP64ATTW1 MC MADISON_PRO1GBCKs_3V3 1*2G/640/BT/6L3.0/5R/ cb_bgn_1.3C_AL_TC11
GCTWN	LX.PSE 02.106	TWN	AS4820TG-332G64Mn W7HP64ATTW1 MC MADISON_PRO1GBCKs_3V3 1*2G/640/BT/6L3.0/5R/ cb_bgn_1.3C_AL_TC11
Singapore	LX.PSE 02.105	AAP	AS4820TG-524G50Mn W7HP64ATSG1 MC MADISON_PRO1GBCKs_3V3 2*2G/500_L/BT/6L3.0/5R/ cb_bgn_1.3C_AL_ZH31
Singapore	LX.PSE 02.103	AAP	AS4820TG-544G64Mn W7HP64ATSG1 MC MADISON_PRO1GBCKs_3V3 2*2G/640/BT/6L3.0/5R/ cb_bgn_1.3C_AL_ZH31
Singapore	LX.PSE 02.102	AAP	AS4820TG-524G64Mn W7HP64ATSG1 MC MADISON_PRO1GBCKs_3V3 2*2G/640/BT/6L3.0/5R/ cb_bgn_1.3C_AL_ZH31
WW	S2.PSE 02.003	WW	AS4820TG-438G32Mn W7HP64AWW1 MC MADISON_PRO1GBCKs_3V3 2*4G/320/6L3.0/5R/ cb_bgn_1.3C_AL_ES62
Thailand	LX.PSE 02.101	AAP	AS4820TG-524G64Mn EM W7HP64EMATTH1 MC MADISON_PRO1GBCKs_3V3 1*4G/640/BT/6L3.0/5R/ cb_bgn_1.3C_AL_TH41
Thailand	LX.PSE 02.099	AAP	AS4820TG-434G50Mn EM W7HP64EMATTH1 MC MADISON_PRO1GBCKs_3V3 1*4G/500_L/BT/6L3.0/5R/ cb_bgn_1.3C_AL_TH41
South Africa	LX.PSE 02.097	EMEA	AS4820TG-436G64Mn EM W7HP64EMATZA2 MC MADISON_PRO1GBCKs_3V3 4G+2G/640/BT/9L3.0/5R/ cb_bgn_1.3C_AL_ES61
Middle East	LX.PSE 02.096	EMEA	AS4820TG-436G64Mn EM W7HP64EMATME4 MC MADISON_PRO1GBCKs_3V3 4G+2G/640/BT/9L3.0/5R/ cb_bgn_1.3C_AL_RU61
Middle East	LX.PSE 02.095	EMEA	AS4820TG-436G64Mn EM W7HP64EMATME2 MC MADISON_PRO1GBCKs_3V3 4G+2G/640/BT/9L3.0/5R/ cb_bgn_1.3C_AL_ES61
Turkey	LX.PSE 02.094	EMEA	AS4820TG-436G64Mn EM W7HP64EMATTR1 MC MADISON_PRO1GBCKs_3V3 4G+2G/640/BT/9L3.0/5R/ cb_bgn_1.3C_AL_TR31
Middle East	LX.PSE 02.093	EMEA	AS4820TG-436G64Mn EM W7HP64EMATME2 MC MADISON_PRO1GBCKs_3V3 4G+2G/640/BT/9L3.0/5R/ cb_bgn_1.3C_AL_AR21
Middle East	LX.PSE 02.092	EMEA	AS4820TG-436G64Mn EM W7HP64EMATMEB MC MADISON_PRO1GBCKs_3V3 4G+2G/640/BT/9L3.0/5R/ cb_bgn_1.3C_AL_ARA1

Country	Acer Part No	RO	Description
South Africa	LX.PSE 02.091	EMEA	AS4820TG-436G64Mn EM W7HP64EMATZA1 MC MADISON_PRO1GBCKs_3V3 4G+2G/640/BT/9L3.0/5R/ cb_bgn_1.3C_AL_ES81
Middle East	LX.PSE 02.090	EMEA	AS4820TG-436G64Mn EM W7HP64EMATME9 MC MADISON_PRO1GBCKs_3V3 4G+2G/640/BT/9L3.0/5R/ cb_bgn_1.3C_AL_ES81
Algeria	LX.PSE 02.089	EMEA	AS4820TG-436G64Mn EM W7HP64EMATDZ1 MC MADISON_PRO1GBCKs_3V3 4G+2G/640/BT/9L3.0/5R/ cb_bgn_1.3C_AL_ES81
Middle East	LX.PSE 02.088	EMEA	AS4820TG-436G64Mn EM W7HP64EMATME4 MC MADISON_PRO1GBCKs_3V3 4G+2G/640/BT/9L3.0/5R/ cb_bgn_1.3C_AL_ES61
Middle East	LX.PSE 02.087	EMEA	AS4820TG-436G64Mn EM W7HP64EMATME2 MC MADISON_PRO1GBCKs_3V3 4G+2G/640/BT/9L3.0/5R/ cb_bgn_1.3C_AL_AR11
South Africa	LX.PSE 02.086	EMEA	AS4820TG-436G64Mn EM W7HP64EMATZA4 MC MADISON_PRO1GBCKs_3V3 4G+2G/640/BT/9L3.0/5R/ cb_bgn_1.3C_AL_ES61
Middle East	LX.PSE 02.085	EMEA	AS4820TG-436G64Mn EM W7HP64EMATME3 MC MADISON_PRO1GBCKs_3V3 4G+2G/640/BT/9L3.0/5R/ cb_bgn_1.3C_AL_ES81
Middle East	LX.PSE 02.084	EMEA	AS4820TG-436G64Mn EM W7HP64EMATME6 MC MADISON_PRO1GBCKs_3V3 4G+2G/640/BT/9L3.0/5R/ cb_bgn_1.3C_AL_ES61
Poland	LX.PSE 02.083	EMEA	AS4820TG-436G64Mn W7HP64ATPL1 MC MADISON_PRO1GBCKs_3V3 4G+2G/640/BT/9L3.0/5R/ cb_bgn_1.3C_AL_PL11
Holland	LX.PSE 02.080	EMEA	AS4820TG-436G64Mn W7HP64ATNL1 MC MADISON_PRO1GBCKs_3V3 4G+2G/640/BT/9L3.0/5R/ cb_bgn_1.3C_AL_NL11
Luxembourg	LX.PSE 02.081	EMEA	AS4820TG-436G64Mn W7HP64ATLU3 MC MADISON_PRO1GBCKs_3V3 4G+2G/640/BT/9L3.0/5R/ cb_bgn_1.3C_AL_IT41
Belgium	LX.PSE 02.079	EMEA	AS4820TG-436G64Mn W7HP64ATBE1 MC MADISON_PRO1GBCKs_3V3 4G+2G/640/BT/9L3.0/5R/ cb_bgn_1.3C_AL_NL11
Switzerland	LX.PSE 02.078	EMEA	AS4820TG-436G64Mn W7HP64ATCH1 MC MADISON_PRO1GBCKs_3V3 4G+2G/640/BT/9L3.0/5R/ cb_bgn_1.3C_AL_IT41
Baltic	LX.PSE 02.077	EMEA	AS4820TG-436G64Mn W7HP64ATBC5 MC MADISON_PRO1GBCKs_3V3 4G+2G/640/BT/9L3.0/5R/ cb_bgn_1.3C_AL_LT11
UK	LX.PSE 02.076	EMEA	AS4820TG-436G64Mn W7HP64ATGB1 MC MADISON_PRO1GBCKs_3V3 4G+2G/640/BT/9L3.0/5R/ cb_bgn_1.3C_AL_EN11
Eastern Europe	LX.PSE 02.074	EMEA	AS4820TG-436G64Mn W7HP64ATEU5 MC MADISON_PRO1GBCKs_3V3 4G+2G/640/BT/9L3.0/5R/ cb_bgn_1.3C_AL_PL71
Eastern Europe	LX.PSE 02.075	EMEA	AS4820TG-436G64Mn W7HP64ATEU5 MC MADISON_PRO1GBCKs_3V3 4G+2G/640/BT/9L3.0/5R/ cb_bgn_1.3C_AL_RO11

Country	Acer Part No	RO	Description
Latvia	LX.PSE 02.073	EMEA	AS4820TG-436G64Mn W7HP64ATLV1 MC MADISON_PRO1GBCKs_3V3 4G+2G/640/BT/9L3.0/5R/ cb_bgn_1.3C_AL_RU22
Latvia	LX.PSE 02.072	EMEA	AS4820TG-436G64Mn W7HP64ATLV1 MC MADISON_PRO1GBCKs_3V3 4G+2G/640/BT/9L3.0/5R/ cb_bgn_1.3C_AL_LT11
Hungary	LX.PSE 02.071	EMEA	AS4820TG-436G64Mn W7HP64ATHU1 MC MADISON_PRO1GBCKs_3V3 4G+2G/640/BT/9L3.0/5R/ cb_bgn_1.3C_AL_HU11
Israel	LX.PSE 02.070	EMEA	AS4820TG-436G64Mn W7HP64ATIL1 MC MADISON_PRO1GBCKs_3V3 4G+2G/640/BT/9L3.0/5R/ cb_bgn_1.3C_AL_HE11
Czech	LX.PSE 02.069	EMEA	AS4820TG-436G64Mn W7HP64ATCZ2 MC MADISON_PRO1GBCKs_3V3 4G+2G/640/BT/9L3.0/5R/ cb_bgn_1.3C_AL_SK11
Cyprus	LX.PSE 02.068	EMEA	AS4820TG-436G64Mn W7HP64ATCY1 MC MADISON_PRO1GBCKs_3V3 4G+2G/640/BT/9L3.0/5R/ cb_bgn_1.3C_AL_ES61
Portugal	LX.PSE 02.067	EMEA	AS4820TG-436G64Mn W7HP64ATPT1 MC MADISON_PRO1GBCKs_3V3 4G+2G/640/BT/9L3.0/5R/ cb_bgn_1.3C_AL_PT11
Baltic	LX.PSE 02.066	EMEA	AS4820TG-436G64Mn W7HP64ATBC4 MC MADISON_PRO1GBCKs_3V3 4G+2G/640/BT/9L3.0/5R/ cb_bgn_1.3C_AL_LT11
Denmark	LX.PSE 02.065	EMEA	AS4820TG-436G64Mn W7HP64ATDK2 MC MADISON_PRO1GBCKs_3V3 4G+2G/640/BT/9L3.0/5R/ cb_bgn_1.3C_AL_ENS1
Eastern Europe	LX.PSE 02.064	EMEA	AS4820TG-436G64Mn W7HP64ATEU7 MC MADISON_PRO1GBCKs_3V3 4G+2G/640/BT/9L3.0/5R/ cb_bgn_1.3C_AL_ENQ1
Italy	LX.PSE 02.063	EMEA	AS4820TG-436G64Mn W7HP64ATIT1 MC MADISON_PRO1GBCKs_3V3 4G+2G/640/BT/9L3.0/5R/ cb_bgn_1.3C_AL_IT11
Spain	LX.PSE 02.062	EMEA	AS4820TG-436G64Mn W7HP64ATES1 MC MADISON_PRO1GBCKs_3V3 4G+2G/640/BT/9L3.0/5R/ cb_bgn_1.3C_AL_ES51
Eastern Europe	LX.PSE 02.061	EMEA	AS4820TG-436G64Mn W7HP64ATEU4 MC MADISON_PRO1GBCKs_3V3 4G+2G/640/BT/9L3.0/5R/ cb_bgn_1.3C_AL_SV21
Serbia/ Macedonia	LX.PSE 02.060	EMEA	AS4820TG-436G64Mn W7HP64ATCS1 MC MADISON_PRO1GBCKs_3V3 4G+2G/640/BT/9L3.0/5R/ cb_bgn_1.3C_AL_SL11
Baltic	LX.PSE 02.059	EMEA	AS4820TG-436G64Mn W7HP64ATBC3 MC MADISON_PRO1GBCKs_3V3 4G+2G/640/BT/9L3.0/5R/ cb_bgn_1.3C_AL_SV21
Austria	LX.PSE 02.058	EMEA	AS4820TG-436G64Mn W7HP64ATAT1 MC MADISON_PRO1GBCKs_3V3 4G+2G/640/BT/9L3.0/5R/ cb_bgn_1.3C_AL_DE61
Greece	LX.PSE 02.057	EMEA	AS4820TG-436G64Mn W7HP64ATGR1 MC MADISON_PRO1GBCKs_3V3 4G+2G/640/BT/9L3.0/5R/ cb_bgn_1.3C_AL_EL31

Country	Acer Part No	RO	Description
Eastern Europe	LX.PSE 02.056	EMEA	AS4820TG-436G64Mn W7HP64ATEU7 MC MADISON_PRO1GBCKs_3V3 4G+2G/640/BT/9L3.0/5R/ cb_bgn_1.3C_AL_SL11
France	LX.PSE 02.055	EMEA	AS4820TG-436G64Mn W7HP64ATFR1 MC MADISON_PRO1GBCKs_3V3 4G+2G/640/BT/9L3.0/5R/ cb_bgn_1.3C_AL_FR21
South Africa	LX.PSE 02.054	EMEA	AS4820TG-434G64Mn EM W7HP64EMATZA2 MC MADISON_PRO1GBCKs_3V3 2*2G/640/BT/6L3.0/5R/ cb_bgn_1.3C_AL_ES61
Middle East	LX.PSE 02.053	EMEA	AS4820TG-434G64Mn EM W7HP64EMATME4 MC MADISON_PRO1GBCKs_3V3 2*2G/640/BT/6L3.0/5R/ cb_bgn_1.3C_AL_RU61
Middle East	LX.PSE 02.052	EMEA	AS4820TG-434G64Mn EM W7HP64EMATME2 MC MADISON_PRO1GBCKs_3V3 2*2G/640/BT/6L3.0/5R/ cb_bgn_1.3C_AL_ES61
Turkey	LX.PSE 02.051	EMEA	AS4820TG-434G64Mn EM W7HP64EMATTR1 MC MADISON_PRO1GBCKs_3V3 2*2G/640/BT/6L3.0/5R/ cb_bgn_1.3C_AL_TR31
Middle East	LX.PSE 02.050	EMEA	AS4820TG-434G64Mn EM W7HP64EMATME2 MC MADISON_PRO1GBCKs_3V3 2*2G/640/BT/6L3.0/5R/ cb_bgn_1.3C_AL_AR21
Middle East	LX.PSE 02.049	EMEA	AS4820TG-434G64Mn EM W7HP64EMATMEB MC MADISON_PRO1GBCKs_3V3 2*2G/640/BT/6L3.0/5R/ cb_bgn_1.3C_AL_ARA1
South Africa	LX.PSE 02.048	EMEA	AS4820TG-434G64Mn EM W7HP64EMATZA1 MC MADISON_PRO1GBCKs_3V3 2*2G/640/BT/6L3.0/5R/ cb_bgn_1.3C_AL_ES81
Middle East	LX.PSE 02.047	EMEA	AS4820TG-434G64Mn EM W7HP64EMATME9 MC MADISON_PRO1GBCKs_3V3 2*2G/640/BT/6L3.0/5R/ cb_bgn_1.3C_AL_ES81
Algeria	LX.PSE 02.046	EMEA	AS4820TG-434G64Mn EM W7HP64EMATDZ1 MC MADISON_PRO1GBCKs_3V3 2*2G/640/BT/6L3.0/5R/ cb_bgn_1.3C_AL_ES81
Middle East	LX.PSE 02.045	EMEA	AS4820TG-434G64Mn EM W7HP64EMATME4 MC MADISON_PRO1GBCKs_3V3 2*2G/640/BT/6L3.0/5R/ cb_bgn_1.3C_AL_ES61
Middle East	LX.PSE 02.044	EMEA	AS4820TG-434G64Mn EM W7HP64EMATME2 MC MADISON_PRO1GBCKs_3V3 2*2G/640/BT/6L3.0/5R/ cb_bgn_1.3C_AL_AR11
South Africa	LX.PSE 02.043	EMEA	AS4820TG-434G64Mn EM W7HP64EMATZA4 MC MADISON_PRO1GBCKs_3V3 2*2G/640/BT/6L3.0/5R/ cb_bgn_1.3C_AL_ES61
Middle East	LX.PSE 02.042	EMEA	AS4820TG-434G64Mn EM W7HP64EMATME3 MC MADISON_PRO1GBCKs_3V3 2*2G/640/BT/6L3.0/5R/ cb_bgn_1.3C_AL_ES81
Middle East	LX.PSE 02.041	EMEA	AS4820TG-434G64Mn EM W7HP64EMATME6 MC MADISON_PRO1GBCKs_3V3 2*2G/640/BT/6L3.0/5R/ cb_bgn_1.3C_AL_ES61
Poland	LX.PSE 02.040	EMEA	AS4820TG-434G64Mn W7HP64ATPL1 MC MADISON_PRO1GBCKs_3V3 2*2G/640/BT/6L3.0/5R/ cb_bgn_1.3C_AL_PL11

Country	Acer Part No	RO	Description
Germany	LX.PSE 02.039	EMEA	AS4820TG-434G64Mn W7HP64ATDE1 MC MADISON_PRO1GBCKs_3V3 2*2G/640/BT/6L3.0/5R/ cb_bgn_1.3C_AL_DE11
Eastern Europe	LX.PSE 02.038	EMEA	AS4820TG-434G64Mn W7HP64ATEU5 MC MADISON_PRO1GBCKs_3V3 2*2G/640/BT/6L3.0/5R/ cb_bgn_1.3C_AL_PL71
Latvia	LX.PSE 02.037	EMEA	AS4820TG-434G64Mn W7HP64ATLV1 MC MADISON_PRO1GBCKs_3V3 2*2G/640/BT/6L3.0/5R/ cb_bgn_1.3C_AL_RU22
Latvia	LX.PSE 02.036	EMEA	AS4820TG-434G64Mn W7HP64ATLV1 MC MADISON_PRO1GBCKs_3V3 2*2G/640/BT/6L3.0/5R/ cb_bgn_1.3C_AL_LT11
Hungary	LX.PSE 02.035	EMEA	AS4820TG-434G64Mn W7HP64ATHU1 MC MADISON_PRO1GBCKs_3V3 2*2G/640/BT/6L3.0/5R/ cb_bgn_1.3C_AL_HU11
Israel	LX.PSE 02.034	EMEA	AS4820TG-434G64Mn W7HP64ATIL1 MC MADISON_PRO1GBCKs_3V3 2*2G/640/BT/6L3.0/5R/ cb_bgn_1.3C_AL_HE11
Czech	LX.PSE 02.033	EMEA	AS4820TG-434G64Mn W7HP64ATCZ2 MC MADISON_PRO1GBCKs_3V3 2*2G/640/BT/6L3.0/5R/ cb_bgn_1.3C_AL_SK11
Cyprus	LX.PSE 02.032	EMEA	AS4820TG-434G64Mn W7HP64ATCY1 MC MADISON_PRO1GBCKs_3V3 2*2G/640/BT/6L3.0/5R/ cb_bgn_1.3C_AL_ES61
Portugal	LX.PSE 02.031	EMEA	AS4820TG-434G64Mn W7HP64ATPT1 MC MADISON_PRO1GBCKs_3V3 2*2G/640/BT/6L3.0/5R/ cb_bgn_1.3C_AL_PT11
Luxembourg	LX.PSE 02.030	EMEA	AS4820TG-434G64Mn W7HP64ATLU3 MC MADISON_PRO1GBCKs_3V3 2*2G/640/BT/6L3.0/5R/ cb_bgn_1.3C_AL_IT41
Holland	LX.PSE 02.029	EMEA	AS4820TG-434G64Mn W7HP64ATNL1 MC MADISON_PRO1GBCKs_3V3 2*2G/640/BT/6L3.0/5R/ cb_bgn_1.3C_AL_NL11
Belgium	LX.PSE 02.028	EMEA	AS4820TG-434G64Mn W7HP64ATBE1 MC MADISON_PRO1GBCKs_3V3 2*2G/640/BT/6L3.0/5R/ cb_bgn_1.3C_AL_NL11
Switzerland	LX.PSE 02.027	EMEA	AS4820TG-434G64Mn W7HP64ATCH1 MC MADISON_PRO1GBCKs_3V3 2*2G/640/BT/6L3.0/5R/ cb_bgn_1.3C_AL_IT41
Baltic	LX.PSE 02.026	EMEA	AS4820TG-434G64Mn W7HP64ATBC5 MC MADISON_PRO1GBCKs_3V3 2*2G/640/BT/6L3.0/5R/ cb_bgn_1.3C_AL_LT11
UK	LX.PSE 02.025	EMEA	AS4820TG-434G64Mn W7HP64ATGB1 MC MADISON_PRO1GBCKs_3V3 2*2G/640/BT/6L3.0/5R/ cb_bgn_1.3C_AL_EN11
Eastern Europe	LX.PSE 02.024	EMEA	AS4820TG-434G64Mn W7HP64ATEU5 MC MADISON_PRO1GBCKs_3V3 2*2G/640/BT/6L3.0/5R/ cb_bgn_1.3C_AL_RO11
Baltic	LX.PSE 02.023	EMEA	AS4820TG-434G64Mn W7HP64ATBC4 MC MADISON_PRO1GBCKs_3V3 2*2G/640/BT/6L3.0/5R/ cb_bgn_1.3C_AL_LT11

Country	Acer Part No	RO	Description
Eastern Europe	LX.PSE 02.021	EMEA	AS4820TG-434G64Mn W7HP64ATEU7 MC MADISON_PRO1GBCKs_3V3 2*2G/640/BT/6L3.0/5R/ cb_bgn_1.3C_AL_ENQ1
Spain	LX.PSE 02.019	EMEA	AS4820TG-434G64Mn W7HP64ATES1 MC MADISON_PRO1GBCKs_3V3 2*2G/640/BT/6L3.0/5R/ cb_bgn_1.3C_AL_ES51
Italy	LX.PSE 02.020	EMEA	AS4820TG-434G64Mn W7HP64ATIT1 MC MADISON_PRO1GBCKs_3V3 2*2G/640/BT/6L3.0/5R/ cb_bgn_1.3C_AL_IT11
Eastern Europe	LX.PSE 02.018	EMEA	AS4820TG-434G64Mn W7HP64ATEU4 MC MADISON_PRO1GBCKs_3V3 2*2G/640/BT/6L3.0/5R/ cb_bgn_1.3C_AL_SV21
Serbia/ Macedonia	LX.PSE 02.017	EMEA	AS4820TG-434G64Mn W7HP64ATCS1 MC MADISON_PRO1GBCKs_3V3 2*2G/640/BT/6L3.0/5R/ cb_bgn_1.3C_AL_SL11
Baltic	LX.PSE 02.016	EMEA	AS4820TG-434G64Mn W7HP64ATBC3 MC MADISON_PRO1GBCKs_3V3 2*2G/640/BT/6L3.0/5R/ cb_bgn_1.3C_AL_SV21
Austria	LX.PSE 02.015	EMEA	AS4820TG-434G64Mn W7HP64ATAT1 MC MADISON_PRO1GBCKs_3V3 2*2G/640/BT/6L3.0/5R/ cb_bgn_1.3C_AL_DE61
Greece	LX.PSE 02.014	EMEA	AS4820TG-434G64Mn W7HP64ATGR1 MC MADISON_PRO1GBCKs_3V3 2*2G/640/BT/6L3.0/5R/ cb_bgn_1.3C_AL_EL31
Eastern Europe	LX.PSE 02.013	EMEA	AS4820TG-434G64Mn W7HP64ATEU7 MC MADISON_PRO1GBCKs_3V3 2*2G/640/BT/6L3.0/5R/ cb_bgn_1.3C_AL_SL11
France	LX.PSE 02.012	EMEA	AS4820TG-434G64Mn W7HP64ATFR1 MC MADISON_PRO1GBCKs_3V3 2*2G/640/BT/6L3.0/5R/ cb_bgn_1.3C_AL_FR21
Hong Kong	LX.PSE 02.011	CHINA	AS4820TG-522G64Mn W7HP64ATHK2 MC MADISON_PRO1GBCKs_3V3 1*2G/640/BT/6L3.0/5R/ cb_bgn_1.3C_AL_ZH34
Hong Kong	LX.PSE 02.010	CHINA	AS4820TG-432G50Mn W7HP64ATHK2 MC MADISON_PRO1GBCKs_3V3 1*2G/500_L/BT/6L3.0/5R/ cb_bgn_1.3C_AL_ZH34
UK	LX.PSE 02.009	EMEA	AS4820TG-524G50Mn W7HP64ATGB1 MC MADISON_PRO1GBCKs_3V3 2*2G/500_L/BT/9L3.0/5R/ cb_bgn_1.3C_AL_EN11
WW	S2.PSE 02.004	WW	AS4820TG-438G32Mn W7HP64AWW1 MC MADISON_PRO1GBCKs_3V3 2*4G/320/6L3.0/5R/ cb_bgn_1.3C_F33-900_AL_ES62
Singapore	LX.PSE 02.004	AAP	AS4820TG-624G64Mn W7HP64ATSG1 MC MADISON_PRO1GBCKs_3V3 2*2G/640/BT/6L3.0/5R/ cb_bgn_1.3C_AL_ES61
Singapore	LX.PSE 02.003	AAP	AS4820TG-626G64Mn W7HP64ATSG1 MC MADISON_PRO1GBCKs_3V3 4G+2G/640/BT/6L3.0/5R/ cb_bgn_1.3C_AL_ES61
Singapore	LX.PSE 02.002	AAP	AS4820TG-524G64Mn W7HP64ATSG1 MC MADISON_PRO1GBCKs_3V3 2*2G/640/BT/6L3.0/5R/ cb_bgn_1.3C_AL_ES61

Country	Acer Part No	RO	Description
Singapore	LX.PSE 02.001	AAP	AS4820TG-526G64Mn W7HP64ATSG1 MC MADISON_PRO1GBCKs_3V3 4G+2G/640/BT/6L3.0/5R/ cb_bgn_1.3C_AL_ES61
WW	S2.PSE 02.002	WW	AS4820TG-528G64Mn W7HP64ATWW4 MC MADISON_PRO1GBCKk_3V3 2*4G/640/6L3.0/5R/ cb_bgn_1.3C_AL_IT91
WW	S2.PSE 02.001	WW	AS4820T-522G16Mn W7HP64ATWW4 MC MADISON_PRO1GBCKk_3V3 1*2G/160/6L2.2/5R/ cb_bgn_1.3C_AL_IT91
Thailand	LX.PVL 02.007	AAP	AS4820TG-524G64Mn EM W7HP64EMATTH1 MC MADISON_PRO1GBGCKs_3V3 2*2G/640/BT/9L3.0/5R/ cb_bgn_1.3C_E77W_AL_TH41
Thailand	LX.PVL 02.008	AAP	AS4820TG-624G64Mn EM W7HP64EMATTH1 MC MADISON_PRO1GBGCKs_3V3 2*2G/640/BT/9L3.0/5R/ cb_bgn_1.3C_E77W_AL_TH41
Thailand	LX.PVL 02.004	AAP	AS4820TG-624G64Mn EM W7HP64EMATTH1 MC MADISON_PRO1GBGCKs_3V3 1*4G/640/BT/9L3.0/5R/ cb_bgn_1.3C_E77W_AL_TH41
Thailand	LX.PVL 02.003	AAP	AS4820TG-624G64Mn EM W7HP64EMATTH1 MC MADISON_PRO1GBGCKs_3V3 1*4G/640/BT/6L3.0/5R/ cb_bgn_1.3C_E77W_AL_TH41
Thailand	LX.PVL 02.002	AAP	AS4820TG-524G50Mn EM W7HP64EMATTH1 MC MADISON_PRO1GBGCKs_3V3 1*4G/500_L/BT/9L3.0/5R/ cb_bgn_1.3C_E77W_AL_TH41
Thailand	LX.PVL 02.001	AAP	AS4820TG-524G50Mn EM W7HP64EMATTH1 MC MADISON_PRO1GBGCKs_3V3 1*4G/500_L/BT/6L3.0/5R/ cb_bgn_1.3C_E77W_AL_TH41
WW	S2.PVL 02.001	WW	AS4820TG-334G16Mn W7HP64AWW1 MC MADISON_PRO1GBGCKs_3V3 2*2G/160/6L3.0/5R/ cb_bgn_1.3C_E77W_AL_ES62
Indonesia	LX.PSG 02.128	AAP	AS4820TG-433G64Mn EM W7HP64EMATID1 MC PARK_XT512Cks_3V3 2G+1G/640/BT/9L3.0/5R/ cb_bgn_1.3C_AL_ID21
Middle East	LX.PSG 0C.004	EMEA	AS4820TG-334G50Mn LINPUSAME2 PARK_XT512Cks_3V3 2*2G/500_L/BT/6L3.0/5R/cb_bgn_1.3C_AL_EN13
China	LX.PSG 02.073	CHINA	AS4820TG-332G32Mn W7HP64SCATCN1 MC PARK_XT512Cks_3V3 1*2G/320/BT/6L3.0/5R/ cb_bgn_1.3C_AL_SC14
Germany	LX.PSG 02.127	EMEA	AS4820TG-334G50Mn W7HP64ATDE1 MC PARK_XT512Cks_3V3 2*2G/500_L/BT/6L3.0/5R/ cb_bgn_1.3C_AL_DE11
Middle East	LX.PSG 02.119	EMEA	AS4820TG-433G32Mn EM W7HP64EMATME4 MC PARK_XT512Cks_3V3 2G+1G/320/BT/6L3.0/5R/ cb_bgn_1.3C_AL_RU61
Middle East	LX.PSG 02.118	EMEA	AS4820TG-433G32Mn EM W7HP64EMATME2 MC PARK_XT512Cks_3V3 2G+1G/320/BT/6L3.0/5R/ cb_bgn_1.3C_AL_ES61
South Africa	LX.PSG 02.117	EMEA	AS4820TG-433G32Mn EM W7HP64EMATZA2 MC PARK_XT512Cks_3V3 2G+1G/320/BT/6L3.0/5R/ cb_bgn_1.3C_AL_ES61

Country	Acer Part No	RO	Description
Turkey	LX.PSG 02.116	EMEA	AS4820TG-433G32Mn EM W7HP64EMATTR1 MC PARK_XT512Cks_3V3 2G+1G/320/BT/6L3.0/5R/ cb_bgn_1.3C_AL_TR31
Middle East	LX.PSG 02.115	EMEA	AS4820TG-433G32Mn EM W7HP64EMATMEB MC PARK_XT512Cks_3V3 2G+1G/320/BT/6L3.0/5R/ cb_bgn_1.3C_AL_ARA1
South Africa	LX.PSG 02.114	EMEA	AS4820TG-433G32Mn EM W7HP64EMATZA5 MC PARK_XT512Cks_3V3 2G+1G/320/BT/6L3.0/5R/ cb_bgn_1.3C_AL_ES61
Middle East	LX.PSG 02.113	EMEA	AS4820TG-433G32Mn EM W7HP64EMATME9 MC PARK_XT512Cks_3V3 2G+1G/320/BT/6L3.0/5R/ cb_bgn_1.3C_AL_ES81
Algeria	LX.PSG 02.112	EMEA	AS4820TG-433G32Mn EM W7HP64EMATDZ1 MC PARK_XT512Cks_3V3 2G+1G/320/BT/6L3.0/5R/ cb_bgn_1.3C_AL_ES81
South Africa	LX.PSG 02.111	EMEA	AS4820TG-433G32Mn EM W7HP64EMATZA1 MC PARK_XT512Cks_3V3 2G+1G/320/BT/6L3.0/5R/ cb_bgn_1.3C_AL_ES81
Middle East	LX.PSG 02.110	EMEA	AS4820TG-433G32Mn EM W7HP64EMATME4 MC PARK_XT512Cks_3V3 2G+1G/320/BT/6L3.0/5R/ cb_bgn_1.3C_AL_ES61
Middle East	LX.PSG 02.109	EMEA	AS4820TG-433G32Mn EM W7HP64EMATME2 MC PARK_XT512Cks_3V3 2G+1G/320/BT/6L3.0/5R/ cb_bgn_1.3C_AL_AR11
Middle East	LX.PSG 02.108	EMEA	AS4820TG-433G32Mn EM W7HP64EMATME3 MC PARK_XT512Cks_3V3 2G+1G/320/BT/6L3.0/5R/ cb_bgn_1.3C_AL_ES81
Middle East	LX.PSG 02.107	EMEA	AS4820TG-433G32Mn EM W7HP64EMATME6 MC PARK_XT512Cks_3V3 2G+1G/320/BT/6L3.0/5R/ cb_bgn_1.3C_AL_ES61
South Africa	LX.PSG 02.106	EMEA	AS4820TG-433G32Mn EM W7HP64EMATZA4 MC PARK_XT512Cks_3V3 2G+1G/320/BT/6L3.0/5R/ cb_bgn_1.3C_AL_ES61
Ukraine	LX.PSG 02.105	EMEA	AS4820TG-433G32Mn W7HP64RUATUK1 MC PARK_XT512Cks_3V3 2G+1G/320/BT/6L3.0/5R/ cb_bgn_1.3C_AL_RU61
Russia	LX.PSG 02.104	EMEA	AS4820TG-433G32Mi W7HP64RUATRU1 MC PARK_XT512Cks_3V3 2G+1G/320/BT/6L3.0/5R/ cb_bgn_1.3C_AL_RU11
Germany	LX.PSG 02.103	EMEA	AS4820TG-433G32Mn W7HP64ATDE1 MC PARK_XT512Cks_3V3 2G+1G/320/BT/6L3.0/5R/ cb_bgn_1.3C_AL_DE11
Poland	LX.PSG 02.102	EMEA	AS4820TG-433G32Mn W7HP64ATPL1 MC PARK_XT512Cks_3V3 2G+1G/320/BT/6L3.0/5R/ cb_bgn_1.3C_AL_PL11
Baltic	LX.PSG 02.101	EMEA	AS4820TG-433G32Mn W7HP64ATBC5 MC PARK_XT512Cks_3V3 2G+1G/320/BT/6L3.0/5R/ cb_bgn_1.3C_AL_LT11
Holland	LX.PSG 02.099	EMEA	AS4820TG-433G32Mn W7HP64ATNL1 MC PARK_XT512Cks_3V3 2G+1G/320/BT/6L3.0/5R/ cb_bgn_1.3C_AL_NL11

Country	Acer Part No	RO	Description
Belgium	LX.PSG 02.098	EMEA	AS4820TG-433G32Mn W7HP64ATBE1 MC PARK_XT512Cks_3V3 2G+1G/320/BT/6L3.0/5R/ cb_bgn_1.3C_AL_NL11
Switzerland	LX.PSG 02.097	EMEA	AS4820TG-433G32Mn W7HP64ATCH1 MC PARK_XT512Cks_3V3 2G+1G/320/BT/6L3.0/5R/ cb_bgn_1.3C_AL_IT41
Luxembourg	LX.PSG 02.096	EMEA	AS4820TG-433G32Mn W7HP64ATLU3 MC PARK_XT512Cks_3V3 2G+1G/320/BT/6L3.0/5R/ cb_bgn_1.3C_AL_IT41
Latvia	LX.PSG 02.095	EMEA	AS4820TG-433G32Mn W7HP64ATLV1 MC PARK_XT512Cks_3V3 2G+1G/320/BT/6L3.0/5R/ cb_bgn_1.3C_AL_LT11
Latvia	LX.PSG 02.094	EMEA	AS4820TG-433G32Mn W7HP64ATLV1 MC PARK_XT512Cks_3V3 2G+1G/320/BT/6L3.0/5R/ cb_bgn_1.3C_AL_RU22
UK	LX.PSG 02.093	EMEA	AS4820TG-433G32Mn W7HP64ATGB1 MC PARK_XT512Cks_3V3 2G+1G/320/BT/6L3.0/5R/ cb_bgn_1.3C_AL_EN11
Eastern Europe	LX.PSG 02.092	EMEA	AS4820TG-433G32Mn W7HP64ATEU5 MC PARK_XT512Cks_3V3 2G+1G/320/BT/6L3.0/5R/ cb_bgn_1.3C_AL_RO11
Eastern Europe	LX.PSG 02.091	EMEA	AS4820TG-433G32Mn W7HP64ATEU5 MC PARK_XT512Cks_3V3 2G+1G/320/BT/6L3.0/5R/ cb_bgn_1.3C_AL_PL71
Czech	LX.PSG 02.090	EMEA	AS4820TG-433G32Mn W7HP64ATCZ2 MC PARK_XT512Cks_3V3 2G+1G/320/BT/6L3.0/5R/ cb_bgn_1.3C_AL_SK11
Hungary	LX.PSG 02.089	EMEA	AS4820TG-433G32Mn W7HP64ATHU1 MC PARK_XT512Cks_3V3 2G+1G/320/BT/6L3.0/5R/ cb_bgn_1.3C_AL_HU11
Israel	LX.PSG 02.088	EMEA	AS4820TG-433G32Mn W7HP64ATIL1 MC PARK_XT512Cks_3V3 2G+1G/320/BT/6L3.0/5R/ cb_bgn_1.3C_AL_HE11
Baltic	LX.PSG 02.087	EMEA	AS4820TG-433G32Mn W7HP64ATBC4 MC PARK_XT512Cks_3V3 2G+1G/320/BT/6L3.0/5R/ cb_bgn_1.3C_AL_LT11
Portugal	LX.PSG 02.086	EMEA	AS4820TG-433G32Mn W7HP64ATPT1 MC PARK_XT512Cks_3V3 2G+1G/320/BT/6L3.0/5R/ cb_bgn_1.3C_AL_PT11
Cyprus	LX.PSG 02.085	EMEA	AS4820TG-433G32Mn W7HP64ATCY1 MC PARK_XT512Cks_3V3 2G+1G/320/BT/6L3.0/5R/ cb_bgn_1.3C_AL_ES61
Baltic	LX.PSG 02.084	EMEA	AS4820TG-433G32Mn W7HP64ATBC3 MC PARK_XT512Cks_3V3 2G+1G/320/BT/6L3.0/5R/ cb_bgn_1.3C_AL_SV21
Serbia/ Macedonia	LX.PSG 02.083	EMEA	AS4820TG-433G32Mn W7HP64ATCS1 MC PARK_XT512Cks_3V3 2G+1G/320/BT/6L3.0/5R/ cb_bgn_1.3C_AL_SL11
Italy	LX.PSG 02.082	EMEA	AS4820TG-433G32Mn W7HP64ATIT1 MC PARK_XT512Cks_3V3 2G+1G/320/BT/6L3.0/5R/ cb_bgn_1.3C_AL_IT11

Country	Acer Part No	RO	Description
Spain	LX.PSG 02.081	EMEA	AS4820TG-433G32Mn W7HP64ATES1 MC PARK_XT512Cks_3V3 2G+1G/320/BT/6L3.0/5R/ cb_bgn_1.3C_AL_ES51
Denmark	LX.PSG 02.080	EMEA	AS4820TG-433G32Mn W7HP64ATDK2 MC PARK_XT512Cks_3V3 2G+1G/320/BT/6L3.0/5R/ cb_bgn_1.3C_AL_ENS1
Eastern Europe	LX.PSG 02.079	EMEA	AS4820TG-433G32Mn W7HP64ATEU7 MC PARK_XT512Cks_3V3 2G+1G/320/BT/6L3.0/5R/ cb_bgn_1.3C_AL_ENQ1
Eastern Europe	LX.PSG 02.078	EMEA	AS4820TG-433G32Mn W7HP64ATEU4 MC PARK_XT512Cks_3V3 2G+1G/320/BT/6L3.0/5R/ cb_bgn_1.3C_AL_SV21
Greece	LX.PSG 02.077	EMEA	AS4820TG-433G32Mn W7HP64ATGR1 MC PARK_XT512Cks_3V3 2G+1G/320/BT/6L3.0/5R/ cb_bgn_1.3C_AL_EL31
Austria	LX.PSG 02.076	EMEA	AS4820TG-433G32Mn W7HP64ATAT1 MC PARK_XT512Cks_3V3 2G+1G/320/BT/6L3.0/5R/ cb_bgn_1.3C_AL_DE61
Eastern Europe	LX.PSG 02.074	EMEA	AS4820TG-433G32Mn W7HP64ATEU7 MC PARK_XT512Cks_3V3 2G+1G/320/BT/6L3.0/5R/ cb_bgn_1.3C_AL_SL11
France	LX.PSG 02.075	EMEA	AS4820TG-433G32Mn W7HP64ATFR1 MC PARK_XT512Cks_3V3 2G+1G/320/BT/6L3.0/5R/ cb_bgn_1.3C_AL_FR21
Middle East	LX.PSG 02.072	EMEA	AS4820TG-333G32Mn EM W7HP64EMATME2 MC PARK_XT512Cks_3V3 2G+1G/320/BT/6L3.0/5R/ cb_bgn_1.3C_AL_AR21
Middle East	LX.PSG 02.071	EMEA	AS4820TG-433G32Mn EM W7HP64EMATME2 MC PARK_XT512Cks_3V3 2G+1G/320/BT/6L3.0/5R/ cb_bgn_1.3C_AL_AR21
Italy	LX.PSG 02.057	EMEA	AS4820TG-434G50Mn W7HP64ATIT1 MC PARK_XT512Cks_3V3 2*2G/500_L/6L3.0/5R/ cb_bgn_1.3C_AL_IT11
Eastern Europe	LX.PSG 02.028	EMEA	AS4820TG-434G50Mn W7HP64ATEU5 MC PARK_XT512Cks_3V3 2*2G/500_L/BT/6L3.0/5R/ cb_bgn_1.3C_AL_RO11
France	LX.PSG 02.058	EMEA	AS4820TG-334G32Mn W7HP64ATFR1 MC PARK_XT512Cks_3V3 2*2G/320/6L3.0/5R/ cb_bgn_1.3C_AL_FR21
Turkey	LX.PSG 02.070	EMEA	AS4820TG-332G32Mn EM W7HP64EMATTR1 MC PARK_XT512Cks_3V3 1*2G/320/BT/6L3.0/5R/ cb_bgn_1.3C_AL_TR31
Turkey	LX.PSG 02.069	EMEA	AS4820TG-522G32Mn EM W7HP64EMATTR1 MC PARK_XT512Cks_3V3 1*2G/320/BT/6L3.0/5R/ cb_bgn_1.3C_AL_TR31
Thailand	LX.PSG 02.068	AAP	AS4820TG-432G50Mn EM W7HP64EMATTH1 MC PARK_XT512Cks_3V3 1*2G/500_L/BT/9L3.0/5R/ cb_bgn_1.3C_AL_TH41
Thailand	LX.PSG 02.067	AAP	AS4820TG-432G50Mn EM W7HP64EMATTH1 MC PARK_XT512Cks_3V3 1*2G/500_L/BT/6L3.0/5R/ cb_bgn_1.3C_AL_TH41

Country	Acer Part No	RO	Description
GCTWN	LX.PSG 02.055	TWN	AS4820TG-432G50Mn W7HP64ATTW1 MC PARK_XT512Cks_3V3 1*2G/500_L/BT/6L3.0/5R/ cb_bgn_1.3C_AL_TC11
Malaysia	LX.PSG 02.066	AAP	AS4820TG-432G50Mn EM W7HP64EMATMY1 MC PARK_XT512Cks_3V3 1*2G/500_L/BT/6L3.0/5R/ cb_bgn_1.3C_AL_ES61
Denmark	LX.PSG 02.018	EMEA	AS4820TG-434G50Mn W7HP64ATDK2 MC PARK_XT512Cks_3V3 2*2G/500_L/BT/6L3.0/5R/ cb_bgn_1.3C_AL_ENS1
Vietnam	LX.PSG 0C.003	AAP	AS4820TG-432G32Mn LIMPUSAVN1 PARK_XT512Cks_3V3 1*2G/320/BT/6L3.0/5R/cb_bgn_1.3C_AL_EN11
Vietnam	LX.PSG 0C.002	AAP	AS4820TG-332G32Mn LIMPUSAVN1 PARK_XT512Cks_3V3 1*2G/320/BT/6L3.0/5R/cb_bgn_1.3C_AL_EN11
Middle East	LX.PSG 02.065	EMEA	AS4820TG-434G64Mn EM W7HP64EMATME2 MC PARK_XT512Cks_3V3 2*2G/640/BT/6L3.0/5R/ cb_bgn_1.3C_AL_AR21
Greece	LX.PSG 02.064	EMEA	AS4820TG-524G32Mn W7HP64ATGR1 MC PARK_XT512Cks_3V3 2*2G/320/6L3.0/5R/ cb_bgn_1.3C_AL_EL31
Middle East	LX.PSG 02.063	EMEA	AS4820TG-334G50Mn EM W7HP64EMATME2 MC PARK_XT512Cks_3V3 2*2G/500_L/BT/6L3.0/5R/ cb_bgn_1.3C_AL_AR21
Russia	LX.PSG 02.062	EMEA	AS4820TG-333G25Mi W7HP64RUATRU1 MC PARK_XT512Cks_3V3 2G+1G/250/BT/6L3.0/5R/ cb_bg_1.3C_AL_RU11
Turkey	LX.PSG 02.060	EMEA	AS4820TG-352G25Mn EM W7HP64EMATTR1 MC PARK_XT512Cks_3V3 1*2G/250/BT/6L3.0/5R/ cb_bgn_1.3C_AL_TR31
Turkey	LX.PSG 02.061	EMEA	AS4820TG-353G32Mn EM W7HP64EMATTR1 MC PARK_XT512Cks_3V3 2G+1G/320/BT/6L3.0/5R/ cb_bgn_1.3C_AL_TR31
Turkey	LX.PSG 02.059	EMEA	AS4820TG-332G25Mn EM W7HP64EMATTR1 MC PARK_XT512Cks_3V3 1*2G/250/6L3.0/5R/ cb_bgn_1.3C_AL_TR31
Malaysia	LX.PSG 02.056	AAP	AS4820TG-522G50Mn EM W7HP64EMATMY1 MC PARK_XT512Cks_3V3 1*2G/500_L/BT/6L3.0/5R/ cb_bgn_1.3C_AL_ES61
GCTWN	LX.PSG 02.054	TWN	AS4820TG-524G64Mn W7HP64ATTW1 MC PARK_XT512Cks_3V3 2*2G/640/BT/6L3.0/5R/ cb_bgn_1.3C_AL_TC11
GCTWN	LX.PSG 02.053	TWN	AS4820TG-432G64Mn W7HP64ATTW1 MC PARK_XT512Cks_3V3 1*2G/640/BT/6L3.0/5R/ cb_bgn_1.3C_AL_TC11
Thailand	LX.PSG 0C.001	AAP	AS4820TG-434G32Mn LIMPUSATH1 PARK_XT512Cks_3V3 2*2G/320/BT/6L3.0/5R/cb_bgn_1.3C_AL_TH51
Thailand	LX.PSG 02.052	AAP	AS4820TG-334G32Mn EM W7HP64EMATTH1 MC PARK_XT512Cks_3V3 1*4G/320/BT/6L3.0/5R/ cb_bgn_1.3C_AL_TH41
China	LX.PSG 02.051	CHINA	AS4820TG-432G32Mn W7HP64SCATCN1 MC PARK_XT512Cks_3V3 1*2G/320/BT/6L3.0/5R/ cb_bgn_1.3C_AL_SC14

Country	Acer Part No	RO	Description
South Africa	LX.PSG 02.050	EMEA	AS4820TG-434G50Mn EM W7HP64EMATZA2 MC PARK_XT512Cks_3V3 2*2G/500_L/BT/6L3.0/5R/ cb_bgn_1.3C_AL_ES61
Middle East	LX.PSG 02.049	EMEA	AS4820TG-434G50Mn EM W7HP64EMATME4 MC PARK_XT512Cks_3V3 2*2G/500_L/BT/6L3.0/5R/ cb_bgn_1.3C_AL_RU61
Middle East	LX.PSG 02.048	EMEA	AS4820TG-434G50Mn EM W7HP64EMATME2 MC PARK_XT512Cks_3V3 2*2G/500_L/BT/6L3.0/5R/ cb_bgn_1.3C_AL_ES61
Turkey	LX.PSG 02.047	EMEA	AS4820TG-434G50Mn EM W7HP64EMATTR1 MC PARK_XT512Cks_3V3 2*2G/500_L/BT/6L3.0/5R/ cb_bgn_1.3C_AL_TR31
Middle East	LX.PSG 02.046	EMEA	AS4820TG-434G50Mn EM W7HP64EMATME2 MC PARK_XT512Cks_3V3 2*2G/500_L/BT/6L3.0/5R/ cb_bgn_1.3C_AL_AR21
Middle East	LX.PSG 02.045	EMEA	AS4820TG-434G50Mn EM W7HP64EMATMEB MC PARK_XT512Cks_3V3 2*2G/500_L/BT/6L3.0/5R/ cb_bgn_1.3C_AL_ARA1
South Africa	LX.PSG 02.044	EMEA	AS4820TG-434G50Mn EM W7HP64EMATZA1 MC PARK_XT512Cks_3V3 2*2G/500_L/BT/6L3.0/5R/ cb_bgn_1.3C_AL_ES81
Middle East	LX.PSG 02.043	EMEA	AS4820TG-434G50Mn EM W7HP64EMATME9 MC PARK_XT512Cks_3V3 2*2G/500_L/BT/6L3.0/5R/ cb_bgn_1.3C_AL_ES81
Algeria	LX.PSG 02.042	EMEA	AS4820TG-434G50Mn EM W7HP64EMATDZ1 MC PARK_XT512Cks_3V3 2*2G/500_L/BT/6L3.0/5R/ cb_bgn_1.3C_AL_ES81
Middle East	LX.PSG 02.041	EMEA	AS4820TG-434G50Mn EM W7HP64EMATME4 MC PARK_XT512Cks_3V3 2*2G/500_L/BT/6L3.0/5R/ cb_bgn_1.3C_AL_ES61
South Africa	LX.PSG 02.039	EMEA	AS4820TG-434G50Mn EM W7HP64EMATZA4 MC PARK_XT512Cks_3V3 2*2G/500_L/BT/6L3.0/5R/ cb_bgn_1.3C_AL_ES61
Middle East	LX.PSG 02.040	EMEA	AS4820TG-434G50Mn EM W7HP64EMATME2 MC PARK_XT512Cks_3V3 2*2G/500_L/BT/6L3.0/5R/ cb_bgn_1.3C_AL_AR11
Middle East	LX.PSG 02.038	EMEA	AS4820TG-434G50Mn EM W7HP64EMATME3 MC PARK_XT512Cks_3V3 2*2G/500_L/BT/6L3.0/5R/ cb_bgn_1.3C_AL_ES81
Middle East	LX.PSG 02.037	EMEA	AS4820TG-434G50Mn EM W7HP64EMATME6 MC PARK_XT512Cks_3V3 2*2G/500_L/BT/6L3.0/5R/ cb_bgn_1.3C_AL_ES61
Poland	LX.PSG 02.036	EMEA	AS4820TG-434G50Mn W7HP64ATPL1 MC PARK_XT512Cks_3V3 2*2G/500_L/BT/6L3.0/5R/ cb_bgn_1.3C_AL_PL11
Germany	LX.PSG 02.035	EMEA	AS4820TG-434G50Mn W7HP64ATDE1 MC PARK_XT512Cks_3V3 2*2G/500_L/BT/6L3.0/5R/ cb_bgn_1.3C_AL_DE11
Luxembourg	LX.PSG 02.034	EMEA	AS4820TG-434G50Mn W7HP64ATLU3 MC PARK_XT512Cks_3V3 2*2G/500_L/BT/6L3.0/5R/ cb_bgn_1.3C_AL_IT41

Country	Acer Part No	RO	Description
Holland	LX.PSG 02.033	EMEA	AS4820TG-434G50Mn W7HP64ATNL1 MC PARK_XT512Cks_3V3 2*2G/500_L/BT/6L3.0/5R/ cb_bgn_1.3C_AL_NL11
Belgium	LX.PSG 02.032	EMEA	AS4820TG-434G50Mn W7HP64ATBE1 MC PARK_XT512Cks_3V3 2*2G/500_L/BT/6L3.0/5R/ cb_bgn_1.3C_AL_NL11
Switzerland	LX.PSG 02.031	EMEA	AS4820TG-434G50Mn W7HP64ATCH1 MC PARK_XT512Cks_3V3 2*2G/500_L/BT/6L3.0/5R/ cb_bgn_1.3C_AL_IT41
Baltic	LX.PSG 02.030	EMEA	AS4820TG-434G50Mn W7HP64ATBC5 MC PARK_XT512Cks_3V3 2*2G/500_L/BT/6L3.0/5R/ cb_bgn_1.3C_AL_LT11
UK	LX.PSG 02.029	EMEA	AS4820TG-434G50Mn W7HP64ATGB1 MC PARK_XT512Cks_3V3 2*2G/500_L/BT/6L3.0/5R/ cb_bgn_1.3C_AL_EN11
Eastern Europe	LX.PSG 02.027	EMEA	AS4820TG-434G50Mn W7HP64ATEU5 MC PARK_XT512Cks_3V3 2*2G/500_L/BT/6L3.0/5R/ cb_bgn_1.3C_AL_PL71
Latvia	LX.PSG 02.026	EMEA	AS4820TG-434G50Mn W7HP64ATLV1 MC PARK_XT512Cks_3V3 2*2G/500_L/BT/6L3.0/5R/ cb_bgn_1.3C_AL_RU22
Latvia	LX.PSG 02.025	EMEA	AS4820TG-434G50Mn W7HP64ATLV1 MC PARK_XT512Cks_3V3 2*2G/500_L/BT/6L3.0/5R/ cb_bgn_1.3C_AL_LT11
Hungary	LX.PSG 02.024	EMEA	AS4820TG-434G50Mn W7HP64ATHU1 MC PARK_XT512Cks_3V3 2*2G/500_L/BT/6L3.0/5R/ cb_bgn_1.3C_AL_HU11
Israel	LX.PSG 02.023	EMEA	AS4820TG-434G50Mn W7HP64ATIL1 MC PARK_XT512Cks_3V3 2*2G/500_L/BT/6L3.0/5R/ cb_bgn_1.3C_AL_HE11
Czech	LX.PSG 02.022	EMEA	AS4820TG-434G50Mn W7HP64ATCZ2 MC PARK_XT512Cks_3V3 2*2G/500_L/BT/6L3.0/5R/ cb_bgn_1.3C_AL_SK11
Cyprus	LX.PSG 02.021	EMEA	AS4820TG-434G50Mn W7HP64ATCY1 MC PARK_XT512Cks_3V3 2*2G/500_L/BT/6L3.0/5R/ cb_bgn_1.3C_AL_ES61
Portugal	LX.PSG 02.020	EMEA	AS4820TG-434G50Mn W7HP64ATPT1 MC PARK_XT512Cks_3V3 2*2G/500_L/BT/6L3.0/5R/ cb_bgn_1.3C_AL_PT11
Baltic	LX.PSG 02.019	EMEA	AS4820TG-434G50Mn W7HP64ATBC4 MC PARK_XT512Cks_3V3 2*2G/500_L/BT/6L3.0/5R/ cb_bgn_1.3C_AL_LT11
Eastern Europe	LX.PSG 02.017	EMEA	AS4820TG-434G50Mn W7HP64ATEU7 MC PARK_XT512Cks_3V3 2*2G/500_L/BT/6L3.0/5R/ cb_bgn_1.3C_AL_ENQ1
Italy	LX.PSG 02.016	EMEA	AS4820TG-434G50Mn W7HP64ATIT1 MC PARK_XT512Cks_3V3 2*2G/500_L/BT/6L3.0/5R/ cb_bgn_1.3C_AL_IT11
Spain	LX.PSG 02.015	EMEA	AS4820TG-434G50Mn W7HP64ATES1 MC PARK_XT512Cks_3V3 2*2G/500_L/BT/6L3.0/5R/ cb_bgn_1.3C_AL_ES51

Country	Acer Part No	RO	Description
Eastern Europe	LX.PSG 02.014	EMEA	AS4820TG-434G50Mn W7HP64ATEU4 MC PARK_XT512Cks_3V3 2*2G/500_L/BT/6L3.0/5R/ cb_bgn_1.3C_AL_SV21
Serbia/ Macedonia	LX.PSG 02.013	EMEA	AS4820TG-434G50Mn W7HP64ATCS1 MC PARK_XT512Cks_3V3 2*2G/500_L/BT/6L3.0/5R/ cb_bgn_1.3C_AL_SL11
Baltic	LX.PSG 02.012	EMEA	AS4820TG-434G50Mn W7HP64ATBC3 MC PARK_XT512Cks_3V3 2*2G/500_L/BT/6L3.0/5R/ cb_bgn_1.3C_AL_SV21
Austria	LX.PSG 02.011	EMEA	AS4820TG-434G50Mn W7HP64ATAT1 MC PARK_XT512Cks_3V3 2*2G/500_L/BT/6L3.0/5R/ cb_bgn_1.3C_AL_DE61
Greece	LX.PSG 02.010	EMEA	AS4820TG-434G50Mn W7HP64ATGR1 MC PARK_XT512Cks_3V3 2*2G/500_L/BT/6L3.0/5R/ cb_bgn_1.3C_AL_EL31
Eastern Europe	LX.PSG 02.009	EMEA	AS4820TG-434G50Mn W7HP64ATEU7 MC PARK_XT512Cks_3V3 2*2G/500_L/BT/6L3.0/5R/ cb_bgn_1.3C_AL_SL11
France	LX.PSG 02.008	EMEA	AS4820TG-434G50Mn W7HP64ATFR1 MC PARK_XT512Cks_3V3 2*2G/500_L/BT/6L3.0/5R/ cb_bgn_1.3C_AL_FR21
UK	LX.PSG 02.007	EMEA	AS4820TG-434G50Mn W7HP64ATGB1 MC PARK_XT512Cks_3V3 2*2G/500_L/BT/9L3.0/5R/ cb_bgn_1.3C_AL_EN11
WW	S2.PSG 02.003	WW	AS4820TG-522G50Mn W7HP64AWW1 MC PARK_XT512Cks_3V3 2*1G/500_L/6L3.0/5R/ cb_bgn_1.3C_AL_ES62
Singapore	LX.PSG 02.003	AAP	AS4820TG-624G64Mn W7HP64ATSG1 MC PARK_XT512Cks_3V3 2*2G/640/BT/6L3.0/5R/ cb_bgn_1.3C_AL_ES61
Singapore	LX.PSG 02.002	AAP	AS4820TG-524G64Mn W7HP64ATSG1 MC PARK_XT512Cks_3V3 2*2G/640/BT/6L3.0/5R/ cb_bgn_1.3C_AL_ES61
Singapore	LX.PSG 02.001	AAP	AS4820TG-434G50Mn W7HP64ATSG1 MC PARK_XT512Cks_3V3 2*2G/500_L/BT/6L3.0/5R/ cb_bgn_1.3C_AL_ES61
WW	S2.PSG 02.002	WW	AS4820TG-522G50Mn W7HP64ATWW4 MC PARK_XT512Cck_3V3 2*1G/500_L/6L2.2/5R/ cb_bgn_1.3C_AL_IT91
WW	S2.PSG 02.001	WW	AS4820T-522G16Mn W7HP64ATWW4 MC PARK_XT512Cck_3V3 1*2G/160/6L2.2/5R/ cb_bgn_1.3C_AL_IT91
WW	S2.PVM 02.001	WW	AS4820TG-332G16Mn W7HP64AWW1 MC PARK_XT512Gcks_3V3 2*1G/160/6L3.0/5R/ cb_bgn_1.3C_E77W_AL_ES62
Singapore	LX.PSN 02.107	AAP	AS4820T-432G50Mn W7HP64ATSG1 MC UMACKs_3 1*2G/ 500_L/BT/6L3.0/5R/cb_bgn_1.3C_AL_ZH31
Chile	LX.PSN 02.112	PA	AS4820T-354G32Mn EM W7HP64EMATCL3 MC UMACKs_3 2*2G/320/6L3.0/5R/cb_bgn_1.3C_AL_ES51
ACLA- Spanish	LX.PSN 02.111	PA	AS4820T-354G32Mn EM W7HP64EMATEA4 MC UMACKs_3 2*2G/320/6L3.0/5R/cb_bgn_1.3C_AL_EN31

Country	Acer Part No	RO	Description
ACLA-Spanish	LX.PSN 02.110	PA	AS4820T-354G32Mn EM W7HP64EMATEA1 MC UMACKs_3 2*2G/320/6L3.0/5R/cb_bgn_1.3C_AL_ES51
ACLA-Spanish	LX.PSN 02.109	PA	AS4820T-354G32Mn EM W7HP64EMATEA3 MC UMACKs_3 2*2G/320/6L3.0/5R/cb_bgn_1.3C_AL_ES51
ACLA-Portuguese	LX.PSN 02.108	PA	AS4820T-354G32Mn EM W7HP64EMATXC3 MC UMACKs_3 2*2G/320/6L3.0/5R/cb_bgn_1.3C_AL_EN61
China	LX.PSN 0C.005	CHINA	AS4820T-432G50Mn LINPUSACN1 UMACKs_3 1*2G/500_L/BT/6L3.0/5R/cb_bgn_1.3C_AL_EN91
Ukraine	LX.PSN 02.106	EMEA	AS4820T-333G32Mn W7HP64RUATUK1 MC UMACKs_3 2G+1G/320/BT/6L3.0/5R/cb_bgn_1.3C_AL_RU61
Russia	LX.PSN 02.105	EMEA	AS4820T-333G32Mi W7HP64RUATRU1 MC UMACKs_3 2G+1G/320/BT/6L3.0/5R/cb_bg_1.3C_AL_RU11
Middle East	LX.PSN 02.104	EMEA	AS4820T-333G32Mn EM W7HP64EMATME4 MC UMACKs_3 2G+1G/320/BT/6L3.0/5R/cb_bgn_1.3C_AL_RU61
Middle East	LX.PSN 02.103	EMEA	AS4820T-333G32Mn EM W7HP64EMATME2 MC UMACKs_3 2G+1G/320/BT/6L3.0/5R/cb_bgn_1.3C_AL_ES61
South Africa	LX.PSN 02.102	EMEA	AS4820T-333G32Mn EM W7HP64EMATZA2 MC UMACKs_3 2G+1G/320/BT/6L3.0/5R/cb_bgn_1.3C_AL_ES61
Turkey	LX.PSN 02.101	EMEA	AS4820T-333G32Mn EM W7HP64EMATTR1 MC UMACKs_3 2G+1G/320/BT/6L3.0/5R/cb_bgn_1.3C_AL_TR31
Middle East	LX.PSN 02.099	EMEA	AS4820T-333G32Mn EM W7HP64EMATMEB MC UMACKs_3 2G+1G/320/BT/6L3.0/5R/cb_bgn_1.3C_AL_ARA1
Middle East	LX.PSN 02.098	EMEA	AS4820T-333G32Mn EM W7HP64EMATME2 MC UMACKs_3 2G+1G/320/BT/6L3.0/5R/cb_bgn_1.3C_AL_AR21
South Africa	LX.PSN 02.097	EMEA	AS4820T-333G32Mn EM W7HP64EMATZA5 MC UMACKs_3 2G+1G/320/BT/6L3.0/5R/cb_bgn_1.3C_AL_ES61
Middle East	LX.PSN 02.096	EMEA	AS4820T-333G32Mn EM W7HP64EMATME9 MC UMACKs_3 2G+1G/320/BT/6L3.0/5R/cb_bgn_1.3C_AL_ES81
Algeria	LX.PSN 02.095	EMEA	AS4820T-333G32Mn EM W7HP64EMATDZ1 MC UMACKs_3 2G+1G/320/BT/6L3.0/5R/cb_bgn_1.3C_AL_ES81
South Africa	LX.PSN 02.094	EMEA	AS4820T-333G32Mn EM W7HP64EMATZA1 MC UMACKs_3 2G+1G/320/BT/6L3.0/5R/cb_bgn_1.3C_AL_ES81
Middle East	LX.PSN 02.093	EMEA	AS4820T-333G32Mn EM W7HP64EMATME4 MC UMACKs_3 2G+1G/320/BT/6L3.0/5R/cb_bgn_1.3C_AL_ES61
Middle East	LX.PSN 02.092	EMEA	AS4820T-333G32Mn EM W7HP64EMATME2 MC UMACKs_3 2G+1G/320/BT/6L3.0/5R/cb_bgn_1.3C_AL_AR11
Middle East	LX.PSN 02.090	EMEA	AS4820T-333G32Mn EM W7HP64EMATME6 MC UMACKs_3 2G+1G/320/BT/6L3.0/5R/cb_bgn_1.3C_AL_ES61
Middle East	LX.PSN 02.091	EMEA	AS4820T-333G32Mn EM W7HP64EMATME3 MC UMACKs_3 2G+1G/320/BT/6L3.0/5R/cb_bgn_1.3C_AL_ES81
South Africa	LX.PSN 02.089	EMEA	AS4820T-333G32Mn EM W7HP64EMATZA4 MC UMACKs_3 2G+1G/320/BT/6L3.0/5R/cb_bgn_1.3C_AL_ES61
Germany	LX.PSN 02.088	EMEA	AS4820T-333G32Mn W7HP64ATDE1 MC UMACKs_3 2G+1G/320/BT/6L3.0/5R/cb_bgn_1.3C_AL_DE11
Poland	LX.PSN 02.087	EMEA	AS4820T-333G32Mn W7HP64ATPL1 MC UMACKs_3 2G+1G/320/BT/6L3.0/5R/cb_bgn_1.3C_AL_PL11
Baltic	LX.PSN 02.086	EMEA	AS4820T-333G32Mn W7HP64ATBC5 MC UMACKs_3 2G+1G/320/BT/6L3.0/5R/cb_bgn_1.3C_AL_LT11

Country	Acer Part No	RO	Description
Holland	LX.PSN 02.085	EMEA	AS4820T-333G32Mn W7HP64ATNL1 MC UMACKs_3 2G+1G/ 320/BT/6L3.0/5R/cb_bgn_1.3C_AL_NL11
Belgium	LX.PSN 02.084	EMEA	AS4820T-333G32Mn W7HP64ATBE1 MC UMACKs_3 2G+1G/ 320/BT/6L3.0/5R/cb_bgn_1.3C_AL_NL11
Switzerland	LX.PSN 02.083	EMEA	AS4820T-333G32Mn W7HP64ATCH1 MC UMACKs_3 2G+1G/ 320/BT/6L3.0/5R/cb_bgn_1.3C_AL_IT41
Luxembourg	LX.PSN 02.082	EMEA	AS4820T-333G32Mn W7HP64ATLU3 MC UMACKs_3 2G+1G/ 320/BT/6L3.0/5R/cb_bgn_1.3C_AL_IT41
Latvia	LX.PSN 02.081	EMEA	AS4820T-333G32Mn W7HP64ATLV1 MC UMACKs_3 2G+1G/ 320/BT/6L3.0/5R/cb_bgn_1.3C_AL_LT11
Latvia	LX.PSN 02.080	EMEA	AS4820T-333G32Mn W7HP64ATLV1 MC UMACKs_3 2G+1G/ 320/BT/6L3.0/5R/cb_bgn_1.3C_AL_RU22
UK	LX.PSN 02.079	EMEA	AS4820T-333G32Mn W7HP64ATGB1 MC UMACKs_3 2G+1G/ 320/BT/6L3.0/5R/cb_bgn_1.3C_AL_EN11
Eastern Europe	LX.PSN 02.078	EMEA	AS4820T-333G32Mn W7HP64ATEU5 MC UMACKs_3 2G+1G/ 320/BT/6L3.0/5R/cb_bgn_1.3C_AL_RO11
Eastern Europe	LX.PSN 02.077	EMEA	AS4820T-333G32Mn W7HP64ATEU5 MC UMACKs_3 2G+1G/ 320/BT/6L3.0/5R/cb_bgn_1.3C_AL_PL71
Czech	LX.PSN 02.076	EMEA	AS4820T-333G32Mn W7HP64ATCZ2 MC UMACKs_3 2G+1G/ 320/BT/6L3.0/5R/cb_bgn_1.3C_AL_SK11
Israel	LX.PSN 02.074	EMEA	AS4820T-333G32Mn W7HP64ATIL1 MC UMACKs_3 2G+1G/ 320/BT/6L3.0/5R/cb_bgn_1.3C_AL_HE11
Hungary	LX.PSN 02.075	EMEA	AS4820T-333G32Mn W7HP64ATHU1 MC UMACKs_3 2G+1G/ 320/BT/6L3.0/5R/cb_bgn_1.3C_AL_HU11
Baltic	LX.PSN 02.073	EMEA	AS4820T-333G32Mn W7HP64ATBC4 MC UMACKs_3 2G+1G/ 320/BT/6L3.0/5R/cb_bgn_1.3C_AL_LT11
Portugal	LX.PSN 02.072	EMEA	AS4820T-333G32Mn W7HP64ATPT1 MC UMACKs_3 2G+1G/ 320/BT/6L3.0/5R/cb_bgn_1.3C_AL_PT11
Cyprus	LX.PSN 02.071	EMEA	AS4820T-333G32Mn W7HP64ATCY1 MC UMACKs_3 2G+1G/ 320/BT/6L3.0/5R/cb_bgn_1.3C_AL_ES61
Baltic	LX.PSN 02.070	EMEA	AS4820T-333G32Mn W7HP64ATBC3 MC UMACKs_3 2G+1G/ 320/BT/6L3.0/5R/cb_bgn_1.3C_AL_SV21
Serbia/ Macedonia	LX.PSN 02.069	EMEA	AS4820T-333G32Mn W7HP64ATCS1 MC UMACKs_3 2G+1G/ 320/BT/6L3.0/5R/cb_bgn_1.3C_AL_SL11
Italy	LX.PSN 02.068	EMEA	AS4820T-333G32Mn W7HP64ATIT1 MC UMACKs_3 2G+1G/ 320/BT/6L3.0/5R/cb_bgn_1.3C_AL_IT11
Spain	LX.PSN 02.067	EMEA	AS4820T-333G32Mn W7HP64ATES1 MC UMACKs_3 2G+1G/ 320/BT/6L3.0/5R/cb_bgn_1.3C_AL_ES51
Denmark	LX.PSN 02.066	EMEA	AS4820T-333G32Mn W7HP64ATDK2 MC UMACKs_3 2G+1G/ 320/BT/6L3.0/5R/cb_bgn_1.3C_AL_ENS1
Eastern Europe	LX.PSN 02.065	EMEA	AS4820T-333G32Mn W7HP64ATEU7 MC UMACKs_3 2G+1G/ 320/BT/6L3.0/5R/cb_bgn_1.3C_AL_ENQ1
Eastern Europe	LX.PSN 02.064	EMEA	AS4820T-333G32Mn W7HP64ATEU4 MC UMACKs_3 2G+1G/ 320/BT/6L3.0/5R/cb_bgn_1.3C_AL_SV21
Greece	LX.PSN 02.063	EMEA	AS4820T-333G32Mn W7HP64ATGR1 MC UMACKs_3 2G+1G/ 320/BT/6L3.0/5R/cb_bgn_1.3C_AL_EL31
Austria	LX.PSN 02.062	EMEA	AS4820T-333G32Mn W7HP64ATAT1 MC UMACKs_3 2G+1G/ 320/BT/6L3.0/5R/cb_bgn_1.3C_AL_DE61

Country	Acer Part No	RO	Description
France	LX.PSN 02.061	EMEA	AS4820T-333G32Mn W7HP64ATFR1 MC UMACKs_3 2G+1G/ 320/BT/6L3.0/5R/cb_bgn_1.3C_AL_FR21
Eastern Europe	LX.PSN 02.060	EMEA	AS4820T-333G32Mn W7HP64ATEU7 MC UMACKs_3 2G+1G/ 320/BT/6L3.0/5R/cb_bgn_1.3C_AL_SL11
Malaysia	LX.PSN 0C.004	AAP	AS4820T-331G32Mn LINPUSAMY1 UMACKs_3 1*1G/320/BT/ 6L3.0/5R/cb_bgn_1.3C_AL_EN11
Vietnam	LX.PSN 0C.003	AAP	AS4820T-432G32Mn LINPUSAVN1 UMACKs_3 1*2G/320/BT/ 6L3.0/5R/cb_bgn_1.3C_AL_EN11
Vietnam	LX.PSN 0C.002	AAP	AS4820T-332G32Mn LINPUSAVN1 UMACKs_3 1*2G/320/BT/ 6L3.0/5R/cb_bgn_1.3C_AL_EN11
Malaysia	LX.PSN 02.059	AAP	AS4820T-332G32Mn EM W7HP64EMATMY1 MC UMACKs_3 1*2G/320/BT/6L3.0/5R/cb_bgn_1.3C_AL_ES61
Italy	LX.PSN 02.058	EMEA	AS4820T-333G50Mn W7HP64ATIT1 MC UMACKs_3 2G+1G/ 500_L/6L3.0/5R/cb_bgn_1.3C_AL_IT11
Philippines	LX.PSN 02.057	AAP	AS4820T-522G50Mn EM W7HP64EMATPH1 MC UMACKs_3 1*2G/500_L/BT/6L3.0/5R/cb_bgn_1.3C_AL_ES61
Italy	LX.PSN 02.056	EMEA	AS4820T-333G32Mn W7HP64ATIT1 MC UMACKs_3 2G+1G/ 320/6L3.0/5R/cb_bgn_1.3C_AL_IT11
Malaysia	LX.PSN 02.055	AAP	AS4820T-432G32Mn EM W7HP64EMATMY1 MC UMACKs_3 1*2G/320/BT/6L3.0/5R/cb_bgn_1.3C_AL_ES61
Malaysia	LX.PSN 0C.001	AAP	AS4820T-432G32Mn LINPUSAMY1 UMACKs_3 1*2G/320/BT/ 6L3.0/5R/cb_bgn_1.3C_AL_EN11
Thailand	LX.PSN 02.054	AAP	AS4820T-432G32Mn EM W7HP64EMATTH1 MC UMACKs_3 1*2G/320/BT/6L3.0/5R/cb_bgn_1.3C_AL_TH41
Thailand	LX.PSN 02.053	AAP	AS4820T-332G32Mn EM W7HP64EMATTH1 MC UMACKs_3 1*2G/320/BT/6L3.0/5R/cb_bgn_1.3C_AL_TH41
China	LX.PSN 02.052	CHINA	AS4820T-332G25Mn W7HP64SCATCN1 MC UMACKs_3 1*2G/ 250/BT/6L3.0/5R/cb_bgn_1.3C_AL_SC14
South Africa	LX.PSN 02.051	EMEA	AS4820T-334G32Mn EM W7HP64EMATZA2 MC UMACKs_3 2*2G/320/BT/6L3.0/5R/cb_bgn_1.3C_AL_ES61
Middle East	LX.PSN 02.050	EMEA	AS4820T-334G32Mn EM W7HP64EMATME4 MC UMACKs_3 2*2G/320/BT/6L3.0/5R/cb_bgn_1.3C_AL_RU61
Middle East	LX.PSN 02.049	EMEA	AS4820T-334G32Mn EM W7HP64EMATME2 MC UMACKs_3 2*2G/320/BT/6L3.0/5R/cb_bgn_1.3C_AL_ES61
Turkey	LX.PSN 02.048	EMEA	AS4820T-334G32Mn EM W7HP64EMATTR1 MC UMACKs_3 2*2G/320/BT/6L3.0/5R/cb_bgn_1.3C_AL_TR31
Middle East	LX.PSN 02.047	EMEA	AS4820T-334G32Mn EM W7HP64EMATME2 MC UMACKs_3 2*2G/320/BT/6L3.0/5R/cb_bgn_1.3C_AL_AR21
Middle East	LX.PSN 02.046	EMEA	AS4820T-334G32Mn EM W7HP64EMATMEB MC UMACKs_3 2*2G/320/BT/6L3.0/5R/cb_bgn_1.3C_AL_ARA1
South Africa	LX.PSN 02.045	EMEA	AS4820T-334G32Mn EM W7HP64EMATZA1 MC UMACKs_3 2*2G/320/BT/6L3.0/5R/cb_bgn_1.3C_AL_ES81
Middle East	LX.PSN 02.044	EMEA	AS4820T-334G32Mn EM W7HP64EMATME9 MC UMACKs_3 2*2G/320/BT/6L3.0/5R/cb_bgn_1.3C_AL_ES81
Algeria	LX.PSN 02.043	EMEA	AS4820T-334G32Mn EM W7HP64EMATDZ1 MC UMACKs_3 2*2G/320/BT/6L3.0/5R/cb_bgn_1.3C_AL_ES81
Middle East	LX.PSN 02.042	EMEA	AS4820T-334G32Mn EM W7HP64EMATME4 MC UMACKs_3 2*2G/320/BT/6L3.0/5R/cb_bgn_1.3C_AL_ES61

Country	Acer Part No	RO	Description
Middle East	LX.PSN 02.041	EMEA	AS4820T-334G32Mn EM W7HP64EMATME2 MC UMACKs_3 2*2G/320/BT/6L3.0/5R/cb_bgn_1.3C_AL_AR11
South Africa	LX.PSN 02.040	EMEA	AS4820T-334G32Mn EM W7HP64EMATZA4 MC UMACKs_3 2*2G/320/BT/6L3.0/5R/cb_bgn_1.3C_AL_ES61
Middle East	LX.PSN 02.039	EMEA	AS4820T-334G32Mn EM W7HP64EMATME3 MC UMACKs_3 2*2G/320/BT/6L3.0/5R/cb_bgn_1.3C_AL_ES81
Middle East	LX.PSN 02.038	EMEA	AS4820T-334G32Mn EM W7HP64EMATME6 MC UMACKs_3 2*2G/320/BT/6L3.0/5R/cb_bgn_1.3C_AL_ES61
Poland	LX.PSN 02.037	EMEA	AS4820T-334G32Mn W7HP64ATPL1 MC UMACKs_3 2*2G/320/BT/6L3.0/5R/cb_bgn_1.3C_AL_PL11
Germany	LX.PSN 02.036	EMEA	AS4820T-334G32Mn W7HP64ATDE1 MC UMACKs_3 2*2G/320/BT/6L3.0/5R/cb_bgn_1.3C_AL_DE11
Luxembourg	LX.PSN 02.035	EMEA	AS4820T-334G32Mn W7HP64ATLU3 MC UMACKs_3 2*2G/320/BT/6L3.0/5R/cb_bgn_1.3C_AL_IT41
Eastern Europe	LX.PSN 02.034	EMEA	AS4820T-334G32Mn W7HP64ATEU5 MC UMACKs_3 2*2G/320/BT/6L3.0/5R/cb_bgn_1.3C_AL_PL71
Latvia	LX.PSN 02.033	EMEA	AS4820T-334G32Mn W7HP64ATLV1 MC UMACKs_3 2*2G/320/BT/6L3.0/5R/cb_bgn_1.3C_AL_RU22
Latvia	LX.PSN 02.032	EMEA	AS4820T-334G32Mn W7HP64ATLV1 MC UMACKs_3 2*2G/320/BT/6L3.0/5R/cb_bgn_1.3C_AL_LT11
Hungary	LX.PSN 02.031	EMEA	AS4820T-334G32Mn W7HP64ATHU1 MC UMACKs_3 2*2G/320/BT/6L3.0/5R/cb_bgn_1.3C_AL_HU11
Israel	LX.PSN 02.030	EMEA	AS4820T-334G32Mn W7HP64ATIL1 MC UMACKs_3 2*2G/320/BT/6L3.0/5R/cb_bgn_1.3C_AL_HE11
Czech	LX.PSN 02.029	EMEA	AS4820T-334G32Mn W7HP64ATCZ2 MC UMACKs_3 2*2G/320/BT/6L3.0/5R/cb_bgn_1.3C_AL_SK11
Cyprus	LX.PSN 02.028	EMEA	AS4820T-334G32Mn W7HP64ATCY1 MC UMACKs_3 2*2G/320/BT/6L3.0/5R/cb_bgn_1.3C_AL_ES61
Portugal	LX.PSN 02.027	EMEA	AS4820T-334G32Mn W7HP64ATPT1 MC UMACKs_3 2*2G/320/BT/6L3.0/5R/cb_bgn_1.3C_AL_PT11
Holland	LX.PSN 02.026	EMEA	AS4820T-334G32Mn W7HP64ATNL1 MC UMACKs_3 2*2G/320/BT/6L3.0/5R/cb_bgn_1.3C_AL_NL11
Belgium	LX.PSN 02.025	EMEA	AS4820T-334G32Mn W7HP64ATBE1 MC UMACKs_3 2*2G/320/BT/6L3.0/5R/cb_bgn_1.3C_AL_NL11
Switzerland	LX.PSN 02.024	EMEA	AS4820T-334G32Mn W7HP64ATCH1 MC UMACKs_3 2*2G/320/BT/6L3.0/5R/cb_bgn_1.3C_AL_IT41
Baltic	LX.PSN 02.023	EMEA	AS4820T-334G32Mn W7HP64ATBC5 MC UMACKs_3 2*2G/320/BT/6L3.0/5R/cb_bgn_1.3C_AL_LT11
UK	LX.PSN 02.022	EMEA	AS4820T-334G32Mn W7HP64ATGB1 MC UMACKs_3 2*2G/320/BT/6L3.0/5R/cb_bgn_1.3C_AL_EN11
Eastern Europe	LX.PSN 02.021	EMEA	AS4820T-334G32Mn W7HP64ATEU5 MC UMACKs_3 2*2G/320/BT/6L3.0/5R/cb_bgn_1.3C_AL_RO11
Baltic	LX.PSN 02.020	EMEA	AS4820T-334G32Mn W7HP64ATBC4 MC UMACKs_3 2*2G/320/BT/6L3.0/5R/cb_bgn_1.3C_AL_LT11
Denmark	LX.PSN 02.019	EMEA	AS4820T-334G32Mn W7HP64ATDK2 MC UMACKs_3 2*2G/320/BT/6L3.0/5R/cb_bgn_1.3C_AL_ENS1
Eastern Europe	LX.PSN 02.018	EMEA	AS4820T-334G32Mn W7HP64ATEU7 MC UMACKs_3 2*2G/320/BT/6L3.0/5R/cb_bgn_1.3C_AL_ENQ1

Country	Acer Part No	RO	Description
Italy	LX.PSN 02.017	EMEA	AS4820T-334G32Mn W7HP64ATIT1 MC UMACKs_3 2*2G/320/BT/6L3.0/5R/cb_bgn_1.3C_AL_IT11
Spain	LX.PSN 02.016	EMEA	AS4820T-334G32Mn W7HP64ATES1 MC UMACKs_3 2*2G/320/BT/6L3.0/5R/cb_bgn_1.3C_AL_ES51
Eastern Europe	LX.PSN 02.015	EMEA	AS4820T-334G32Mn W7HP64ATEU4 MC UMACKs_3 2*2G/320/BT/6L3.0/5R/cb_bgn_1.3C_AL_SV21
Serbia/ Macedonia	LX.PSN 02.014	EMEA	AS4820T-334G32Mn W7HP64ATCS1 MC UMACKs_3 2*2G/320/BT/6L3.0/5R/cb_bgn_1.3C_AL_SL11
Baltic	LX.PSN 02.013	EMEA	AS4820T-334G32Mn W7HP64ATBC3 MC UMACKs_3 2*2G/320/BT/6L3.0/5R/cb_bgn_1.3C_AL_SV21
Austria	LX.PSN 02.012	EMEA	AS4820T-334G32Mn W7HP64ATAT1 MC UMACKs_3 2*2G/320/BT/6L3.0/5R/cb_bgn_1.3C_AL_DE61
Greece	LX.PSN 02.011	EMEA	AS4820T-334G32Mn W7HP64ATGR1 MC UMACKs_3 2*2G/320/BT/6L3.0/5R/cb_bgn_1.3C_AL_EL31
Eastern Europe	LX.PSN 02.010	EMEA	AS4820T-334G32Mn W7HP64ATEU7 MC UMACKs_3 2*2G/320/BT/6L3.0/5R/cb_bgn_1.3C_AL_SL11
France	LX.PSN 02.009	EMEA	AS4820T-334G32Mn W7HP64ATFR1 MC UMACKs_3 2*2G/320/BT/6L3.0/5R/cb_bgn_1.3C_AL_FR21
UK	LX.PSN 02.008	EMEA	AS4820T-434G32Mn W7HP64ATGB1 MC UMACKs_3 2*2G/320/6L3.0/5R/cb_bgn_1.3C_AL_EN11
UK	LX.PSN 02.007	EMEA	AS4820T-333G25Mn W7HP64ATGB1 MC UMACKs_3 2G+1G/250/6L3.0/5R/cb_bgn_1.3C_AL_EN11
WW	S2.PSN 02.004	WW	AS4820T-334G25Mn W7HP64AWW1 MC UMACKs_3 2*2G/250/6L3.0/5R/cb_bgn_1.3C_F33-900_AL_ES62
WW	S2.PSN 02.003	WW	AS4820T-334G25Mn W7HP64AWW1 MC UMACKs_3 2*2G/250/6L3.0/5R/cb_bgn_1.3C_AL_ES62
Singapore	LX.PSN 02.003	AAP	AS4820T-332G32Mn W7HP64ATSG1 MC UMACKs_3 1*2G/320/BT/6L3.0/5R/cb_bgn_1.3C_AL_ES61
Singapore	LX.PSN 02.002	AAP	AS4820T-434G32Mn W7HP64ATSG1 MC UMACKs_3 2*2G/320/BT/6L3.0/5R/cb_bgn_1.3C_AL_ES61
Singapore	LX.PSN 02.001	AAP	AS4820T-334G32Mn W7HP64ATSG1 MC UMACKs_3 2*2G/320/BT/6L3.0/5R/cb_bgn_1.3C_AL_ES61
WW	S2.PSN 02.002	WW	AS4820T-524G25Mn W7HP64ATWW4 MC UMACKk 2*2G/250/6L2.2/5R/cb_bgn_1.3C_AL_IT91
WW	S2.PSN 02.001	WW	AS4820T-522G16Mn W7HP64ATWW4 MC UMACKk_3 1*2G/160/6L2.2/5R/cb_bgn_1.3C_AL_IT91
WW	S2.PVK 02.001	WW	AS4820T-334G25Mn W7HP64AWW1 MC UMAGCks_3 2*2G/250/6L3.0/5R/cb_bgn_1.3C_E77W_AL_ES62

Model	Country	Acer Part No	BOM Name	CPU	VGA Chip	VRAM 1
AS4820TG-432G32Mn	China	LX.PSE 02.098	AS4820TG_MADISO_N_PRO1GBCKs_3V3	Ci5430M	MADISON_PRO	1G-DDR3 (64*16*8)
AS4820TG-332G32Mn	China	LX.PSE 02.127	AS4820TG_MADISO_N_PRO1GBCKs_3V3	Ci3330M	MADISON_PRO	1G-DDR3 (64*16*8)
AS4820TG-434G50Mn	Switzerland	LX.PSE 02.118	AS4820TG_MADISO_N_PRO1GBCKs_3V3	Ci5430M	MADISON_PRO	1G-DDR3 (64*16*8)

Model	Country	Acer Part No	BOM Name	CPU	VGA Chip	VRAM 1
AS4820TG-524G64Mn	GCTWN	LX.PSE 02.111	AS4820TG_MADISO N_PRO1GBCKs_3V3	Ci5520M	MADISON _PRO	1G-DDR3 (64*16*8)
AS4820TG-434G50Mn	Germany	LX.PSE 02.177	AS4820TG_MADISO N_PRO1GBCKs_3V3	Ci5430M	MADISON _PRO	1G-DDR3 (64*16*8)
AS4820TG-434G50Mn	South Africa	LX.PSE 02.169	AS4820TG_MADISO N_PRO1GBCKs_3V3	Ci5430M	MADISON _PRO	1G-DDR3 (64*16*8)
AS4820TG-434G50Mn	Middle East	LX.PSE 02.167	AS4820TG_MADISO N_PRO1GBCKs_3V3	Ci5430M	MADISON _PRO	1G-DDR3 (64*16*8)
AS4820TG-434G50Mn	Middle East	LX.PSE 02.168	AS4820TG_MADISO N_PRO1GBCKs_3V3	Ci5430M	MADISON _PRO	1G-DDR3 (64*16*8)
AS4820TG-434G50Mn	Middle East	LX.PSE 02.166	AS4820TG_MADISO N_PRO1GBCKs_3V3	Ci5430M	MADISON _PRO	1G-DDR3 (64*16*8)
AS4820TG-434G50Mn	Middle East	LX.PSE 02.165	AS4820TG_MADISO N_PRO1GBCKs_3V3	Ci5430M	MADISON _PRO	1G-DDR3 (64*16*8)
AS4820TG-434G50Mn	South Africa	LX.PSE 02.164	AS4820TG_MADISO N_PRO1GBCKs_3V3	Ci5430M	MADISON _PRO	1G-DDR3 (64*16*8)
AS4820TG-434G50Mn	Poland	LX.PSE 02.163	AS4820TG_MADISO N_PRO1GBCKs_3V3	Ci5430M	MADISON _PRO	1G-DDR3 (64*16*8)
AS4820TG-434G50Mn	Baltic	LX.PSE 02.162	AS4820TG_MADISO N_PRO1GBCKs_3V3	Ci5430M	MADISON _PRO	1G-DDR3 (64*16*8)
AS4820TG-434G50Mn	Holland	LX.PSE 02.161	AS4820TG_MADISO N_PRO1GBCKs_3V3	Ci5430M	MADISON _PRO	1G-DDR3 (64*16*8)
AS4820TG-434G50Mn	Luxembourg	LX.PSE 02.159	AS4820TG_MADISO N_PRO1GBCKs_3V3	Ci5430M	MADISON _PRO	1G-DDR3 (64*16*8)
AS4820TG-434G50Mn	Belgium	LX.PSE 02.160	AS4820TG_MADISO N_PRO1GBCKs_3V3	Ci5430M	MADISON _PRO	1G-DDR3 (64*16*8)
AS4820TG-434G50Mn	Latvia	LX.PSE 02.158	AS4820TG_MADISO N_PRO1GBCKs_3V3	Ci5430M	MADISON _PRO	1G-DDR3 (64*16*8)
AS4820TG-434G50Mn	Latvia	LX.PSE 02.157	AS4820TG_MADISO N_PRO1GBCKs_3V3	Ci5430M	MADISON _PRO	1G-DDR3 (64*16*8)
AS4820TG-434G50Mn	UK	LX.PSE 02.156	AS4820TG_MADISO N_PRO1GBCKs_3V3	Ci5430M	MADISON _PRO	1G-DDR3 (64*16*8)
AS4820TG-434G50Mn	Eastern Europe	LX.PSE 02.155	AS4820TG_MADISO N_PRO1GBCKs_3V3	Ci5430M	MADISON _PRO	1G-DDR3 (64*16*8)
AS4820TG-434G50Mn	Czech	LX.PSE 02.153	AS4820TG_MADISO N_PRO1GBCKs_3V3	Ci5430M	MADISON _PRO	1G-DDR3 (64*16*8)
AS4820TG-434G50Mn	Eastern Europe	LX.PSE 02.154	AS4820TG_MADISO N_PRO1GBCKs_3V3	Ci5430M	MADISON _PRO	1G-DDR3 (64*16*8)
AS4820TG-434G50Mn	Hungary	LX.PSE 02.152	AS4820TG_MADISO N_PRO1GBCKs_3V3	Ci5430M	MADISON _PRO	1G-DDR3 (64*16*8)
AS4820TG-434G50Mn	Israel	LX.PSE 02.151	AS4820TG_MADISO N_PRO1GBCKs_3V3	Ci5430M	MADISON _PRO	1G-DDR3 (64*16*8)
AS4820TG-434G50Mn	Baltic	LX.PSE 02.150	AS4820TG_MADISO N_PRO1GBCKs_3V3	Ci5430M	MADISON _PRO	1G-DDR3 (64*16*8)
AS4820TG-434G50Mn	Portugal	LX.PSE 02.149	AS4820TG_MADISO N_PRO1GBCKs_3V3	Ci5430M	MADISON _PRO	1G-DDR3 (64*16*8)
AS4820TG-434G50Mn	Cyprus	LX.PSE 02.148	AS4820TG_MADISO N_PRO1GBCKs_3V3	Ci5430M	MADISON _PRO	1G-DDR3 (64*16*8)

Model	Country	Acer Part No	BOM Name	CPU	VGA Chip	VRAM 1
AS4820TG-434G50Mn	Baltic	LX.PSE 02.147	AS4820TG_MADISO N_PRO1GBCKs_3V3	Ci5430M	MADISON _PRO	1G-DDR3 (64*16*8)
AS4820TG-434G50Mn	Serbia/ Macedonia	LX.PSE 02.146	AS4820TG_MADISO N_PRO1GBCKs_3V3	Ci5430M	MADISON _PRO	1G-DDR3 (64*16*8)
AS4820TG-434G50Mn	Italy	LX.PSE 02.145	AS4820TG_MADISO N_PRO1GBCKs_3V3	Ci5430M	MADISON _PRO	1G-DDR3 (64*16*8)
AS4820TG-434G50Mn	Spain	LX.PSE 02.144	AS4820TG_MADISO N_PRO1GBCKs_3V3	Ci5430M	MADISON _PRO	1G-DDR3 (64*16*8)
AS4820TG-434G50Mn	Denmark	LX.PSE 02.143	AS4820TG_MADISO N_PRO1GBCKs_3V3	Ci5430M	MADISON _PRO	1G-DDR3 (64*16*8)
AS4820TG-434G50Mn	Eastern Europe	LX.PSE 02.142	AS4820TG_MADISO N_PRO1GBCKs_3V3	Ci5430M	MADISON _PRO	1G-DDR3 (64*16*8)
AS4820TG-434G50Mn	Eastern Europe	LX.PSE 02.141	AS4820TG_MADISO N_PRO1GBCKs_3V3	Ci5430M	MADISON _PRO	1G-DDR3 (64*16*8)
AS4820TG-434G50Mn	Austria	LX.PSE 02.139	AS4820TG_MADISO N_PRO1GBCKs_3V3	Ci5430M	MADISON _PRO	1G-DDR3 (64*16*8)
AS4820TG-434G50Mn	Greece	LX.PSE 02.140	AS4820TG_MADISO N_PRO1GBCKs_3V3	Ci5430M	MADISON _PRO	1G-DDR3 (64*16*8)
AS4820TG-434G50Mn	France	LX.PSE 02.138	AS4820TG_MADISO N_PRO1GBCKs_3V3	Ci5430M	MADISON _PRO	1G-DDR3 (64*16*8)
AS4820TG-434G50Mn	Eastern Europe	LX.PSE 02.137	AS4820TG_MADISO N_PRO1GBCKs_3V3	Ci5430M	MADISON _PRO	1G-DDR3 (64*16*8)
AS4820TG-434G50Mn	Ukraine	LX.PSE 02.136	AS4820TG_MADISO N_PRO1GBCKs_3V3	Ci5430M	MADISON _PRO	1G-DDR3 (64*16*8)
AS4820TG-434G50Mn	Middle East	LX.PSE 02.135	AS4820TG_MADISO N_PRO1GBCKs_3V3	Ci5430M	MADISON _PRO	1G-DDR3 (64*16*8)
AS4820TG-434G50Mn	Middle East	LX.PSE 02.134	AS4820TG_MADISO N_PRO1GBCKs_3V3	Ci5430M	MADISON _PRO	1G-DDR3 (64*16*8)
AS4820TG-434G50Mn	South Africa	LX.PSE 02.133	AS4820TG_MADISO N_PRO1GBCKs_3V3	Ci5430M	MADISON _PRO	1G-DDR3 (64*16*8)
AS4820TG-434G50Mn	Middle East	LX.PSE 02.132	AS4820TG_MADISO N_PRO1GBCKs_3V3	Ci5430M	MADISON _PRO	1G-DDR3 (64*16*8)
AS4820TG-434G50Mn	Middle East	LX.PSE 02.131	AS4820TG_MADISO N_PRO1GBCKs_3V3	Ci5430M	MADISON _PRO	1G-DDR3 (64*16*8)
AS4820TG-434G50Mn	South Africa	LX.PSE 02.130	AS4820TG_MADISO N_PRO1GBCKs_3V3	Ci5430M	MADISON _PRO	1G-DDR3 (64*16*8)
AS4820TG-434G50Mn	Middle East	LX.PSE 02.129	AS4820TG_MADISO N_PRO1GBCKs_3V3	Ci5430M	MADISON _PRO	1G-DDR3 (64*16*8)
AS4820TG-434G50Mn	Algeria	LX.PSE 02.128	AS4820TG_MADISO N_PRO1GBCKs_3V3	Ci5430M	MADISON _PRO	1G-DDR3 (64*16*8)
AS4820TG-434G50Mn	Middle East	LX.PSE 02.126	AS4820TG_MADISO N_PRO1GBCKs_3V3	Ci5430M	MADISON _PRO	1G-DDR3 (64*16*8)
AS4820TG-432G50Mn	Thailand	LX.PSE 02.122	AS4820TG_MADISO N_PRO1GBCKs_3V3	Ci5430M	MADISON _PRO	1G-DDR3 (64*16*8)
AS4820TG-434G32Mn	Middle East	LX.PSE 02.125	AS4820TG_MADISO N_PRO1GBCKs_3V3	Ci5430M	MADISON _PRO	1G-DDR3 (64*16*8)
AS4820TG-434G50Mn	France	LX.PSE 02.117	AS4820TG_MADISO N_PRO1GBCKs_3V3	Ci5430M	MADISON _PRO	1G-DDR3 (64*16*8)

Model	Country	Acer Part No	BOM Name	CPU	VGA Chip	VRAM 1
AS4820TG-624G64Mn	GCTWN	LX.PSE 02.124	AS4820TG_MADISO N_PRO1GBCKs_3V3	Ci7620M	MADISON _PRO	1G-DDR3 (64*16*8)
AS4820TG-432G50Mn	Thailand	LX.PSE 02.123	AS4820TG_MADISO N_PRO1GBCKs_3V3	Ci5430M	MADISON _PRO	1G-DDR3 (64*16*8)
AS4820TG-434G64Mn	Denmark	LX.PSE 02.022	AS4820TG_MADISO N_PRO1GBCKs_3V3	Ci5430M	MADISON _PRO	1G-DDR3 (64*16*8)
AS4820TG-436G64Mn	Germany	LX.PSE 02.082	AS4820TG_MADISO N_PRO1GBCKs_3V3	Ci5430M	MADISON _PRO	1G-DDR3 (64*16*8)
AS4820TG-434G32Mn	WW	S2.PSE 02.005	AS4820TG_MADISO N_PRO1GBCKs_3V3	Ci5430M	MADISON _PRO	1G-DDR3 (64*16*8)
AS4820TG-434G50Mi	Russia	LX.PSE 02.121	AS4820TG_MADISO N_PRO1GBCKs_3V3	Ci5430M	MADISON _PRO	1G-DDR3 (64*16*8)
AS4820TG-434G50Mn	Turkey	LX.PSE 02.120	AS4820TG_MADISO N_PRO1GBCKs_3V3	Ci5430M	MADISON _PRO	1G-DDR3 (64*16*8)
AS4820TG-353G32Mn	Turkey	LX.PSE 02.119	AS4820TG_MADISO N_PRO1GBCKs_3V3	Ci3350M	MADISON _PRO	1G-DDR3 (64*16*8)
AS4820TG-334G50Mn	France	LX.PSE 02.116	AS4820TG_MADISO N_PRO1GBCKs_3V3	Ci3330M	MADISON _PRO	1G-DDR3 (64*16*8)
AS4820TG-624G50Mn	France	LX.PSE 02.115	AS4820TG_MADISO N_PRO1GBCKs_3V3	Ci7620M	MADISON _PRO	1G-DDR3 (64*16*8)
AS4820TG-624G64Mn	Singapore	LX.PSE 02.104	AS4820TG_MADISO N_PRO1GBCKs_3V3	Ci7620M	MADISON _PRO	1G-DDR3 (64*16*8)
AS4820TG-524G50Mn	Malaysia	LX.PSE 02.114	AS4820TG_MADISO N_PRO1GBCKs_3V3	Ci5520M	MADISON _PRO	1G-DDR3 (64*16*8)
AS4820TG-432G50Mn	GCTWN	LX.PSE 02.113	AS4820TG_MADISO N_PRO1GBCKs_3V3	Ci5430M	MADISON _PRO	1G-DDR3 (64*16*8)
AS4820TG-524G64Mn	GCTWN	LX.PSE 02.112	AS4820TG_MADISO N_PRO1GBCKs_3V3	Ci5520M	MADISON _PRO	1G-DDR3 (64*16*8)
AS4820TG-432G64Mn	GCTWN	LX.PSE 02.110	AS4820TG_MADISO N_PRO1GBCKs_3V3	Ci5430M	MADISON _PRO	1G-DDR3 (64*16*8)
AS4820TG-524G50Mn	Indonesia	LX.PSE 02.109	AS4820TG_MADISO N_PRO1GBCKs_3V3	Ci5520M	MADISON _PRO	1G-DDR3 (64*16*8)
AS4820TG-524G50Mn	Indonesia	LX.PSE 02.108	AS4820TG_MADISO N_PRO1GBCKs_3V3	Ci5520M	MADISON _PRO	1G-DDR3 (64*16*8)
AS4820TG-432G64Mn	GCTWN	LX.PSE 02.107	AS4820TG_MADISO N_PRO1GBCKs_3V3	Ci5430M	MADISON _PRO	1G-DDR3 (64*16*8)
AS4820TG-332G64Mn	GCTWN	LX.PSE 02.106	AS4820TG_MADISO N_PRO1GBCKs_3V3	Ci3330M	MADISON _PRO	1G-DDR3 (64*16*8)
AS4820TG-524G50Mn	Singapore	LX.PSE 02.105	AS4820TG_MADISO N_PRO1GBCKs_3V3	Ci5520M	MADISON _PRO	1G-DDR3 (64*16*8)
AS4820TG-544G64Mn	Singapore	LX.PSE 02.103	AS4820TG_MADISO N_PRO1GBCKs_3V3	Ci5540M	MADISON _PRO	1G-DDR3 (64*16*8)
AS4820TG-524G64Mn	Singapore	LX.PSE 02.102	AS4820TG_MADISO N_PRO1GBCKs_3V3	Ci5520M	MADISON _PRO	1G-DDR3 (64*16*8)
AS4820TG-438G32Mn	WW	S2.PSE 02.003	AS4820TG_MADISO N_PRO1GBCKs_3V3	Ci5430M	MADISON _PRO	1G-DDR3 (64*16*8)
AS4820TG-524G64Mn	Thailand	LX.PSE 02.101	AS4820TG_MADISO N_PRO1GBCKs_3V3	Ci5520M	MADISON _PRO	1G-DDR3 (64*16*8)

Model	Country	Acer Part No	BOM Name	CPU	VGA Chip	VRAM 1
AS4820TG-434G50Mn	Thailand	LX.PSE 02.099	AS4820TG_MADISON_PRO1GBCKs_3V3	Ci5430M	MADISON_PRO	1G-DDR3 (64*16*8)
AS4820TG-436G64Mn	South Africa	LX.PSE 02.097	AS4820TG_MADISON_PRO1GBCKs_3V3	Ci5430M	MADISON_PRO	1G-DDR3 (64*16*8)
AS4820TG-436G64Mn	Middle East	LX.PSE 02.096	AS4820TG_MADISON_PRO1GBCKs_3V3	Ci5430M	MADISON_PRO	1G-DDR3 (64*16*8)
AS4820TG-436G64Mn	Middle East	LX.PSE 02.095	AS4820TG_MADISON_PRO1GBCKs_3V3	Ci5430M	MADISON_PRO	1G-DDR3 (64*16*8)
AS4820TG-436G64Mn	Turkey	LX.PSE 02.094	AS4820TG_MADISON_PRO1GBCKs_3V3	Ci5430M	MADISON_PRO	1G-DDR3 (64*16*8)
AS4820TG-436G64Mn	Middle East	LX.PSE 02.093	AS4820TG_MADISON_PRO1GBCKs_3V3	Ci5430M	MADISON_PRO	1G-DDR3 (64*16*8)
AS4820TG-436G64Mn	Middle East	LX.PSE 02.092	AS4820TG_MADISON_PRO1GBCKs_3V3	Ci5430M	MADISON_PRO	1G-DDR3 (64*16*8)
AS4820TG-436G64Mn	South Africa	LX.PSE 02.091	AS4820TG_MADISON_PRO1GBCKs_3V3	Ci5430M	MADISON_PRO	1G-DDR3 (64*16*8)
AS4820TG-436G64Mn	Middle East	LX.PSE 02.090	AS4820TG_MADISON_PRO1GBCKs_3V3	Ci5430M	MADISON_PRO	1G-DDR3 (64*16*8)
AS4820TG-436G64Mn	Algeria	LX.PSE 02.089	AS4820TG_MADISON_PRO1GBCKs_3V3	Ci5430M	MADISON_PRO	1G-DDR3 (64*16*8)
AS4820TG-436G64Mn	Middle East	LX.PSE 02.088	AS4820TG_MADISON_PRO1GBCKs_3V3	Ci5430M	MADISON_PRO	1G-DDR3 (64*16*8)
AS4820TG-436G64Mn	Middle East	LX.PSE 02.087	AS4820TG_MADISON_PRO1GBCKs_3V3	Ci5430M	MADISON_PRO	1G-DDR3 (64*16*8)
AS4820TG-436G64Mn	South Africa	LX.PSE 02.086	AS4820TG_MADISON_PRO1GBCKs_3V3	Ci5430M	MADISON_PRO	1G-DDR3 (64*16*8)
AS4820TG-436G64Mn	Middle East	LX.PSE 02.085	AS4820TG_MADISON_PRO1GBCKs_3V3	Ci5430M	MADISON_PRO	1G-DDR3 (64*16*8)
AS4820TG-436G64Mn	Middle East	LX.PSE 02.084	AS4820TG_MADISON_PRO1GBCKs_3V3	Ci5430M	MADISON_PRO	1G-DDR3 (64*16*8)
AS4820TG-436G64Mn	Poland	LX.PSE 02.083	AS4820TG_MADISON_PRO1GBCKs_3V3	Ci5430M	MADISON_PRO	1G-DDR3 (64*16*8)
AS4820TG-436G64Mn	Holland	LX.PSE 02.080	AS4820TG_MADISON_PRO1GBCKs_3V3	Ci5430M	MADISON_PRO	1G-DDR3 (64*16*8)
AS4820TG-436G64Mn	Luxembourg	LX.PSE 02.081	AS4820TG_MADISON_PRO1GBCKs_3V3	Ci5430M	MADISON_PRO	1G-DDR3 (64*16*8)
AS4820TG-436G64Mn	Belgium	LX.PSE 02.079	AS4820TG_MADISON_PRO1GBCKs_3V3	Ci5430M	MADISON_PRO	1G-DDR3 (64*16*8)
AS4820TG-436G64Mn	Switzerland	LX.PSE 02.078	AS4820TG_MADISON_PRO1GBCKs_3V3	Ci5430M	MADISON_PRO	1G-DDR3 (64*16*8)
AS4820TG-436G64Mn	Baltic	LX.PSE 02.077	AS4820TG_MADISON_PRO1GBCKs_3V3	Ci5430M	MADISON_PRO	1G-DDR3 (64*16*8)
AS4820TG-436G64Mn	UK	LX.PSE 02.076	AS4820TG_MADISON_PRO1GBCKs_3V3	Ci5430M	MADISON_PRO	1G-DDR3 (64*16*8)
AS4820TG-436G64Mn	Eastern Europe	LX.PSE 02.074	AS4820TG_MADISON_PRO1GBCKs_3V3	Ci5430M	MADISON_PRO	1G-DDR3 (64*16*8)
AS4820TG-436G64Mn	Eastern Europe	LX.PSE 02.075	AS4820TG_MADISON_PRO1GBCKs_3V3	Ci5430M	MADISON_PRO	1G-DDR3 (64*16*8)

Model	Country	Acer Part No	BOM Name	CPU	VGA Chip	VRAM 1
AS4820TG-436G64Mn	Latvia	LX.PSE 02.073	AS4820TG_MADISO N_PRO1GBCKs_3V3	Ci5430M	MADISON _PRO	1G-DDR3 (64*16*8)
AS4820TG-436G64Mn	Latvia	LX.PSE 02.072	AS4820TG_MADISO N_PRO1GBCKs_3V3	Ci5430M	MADISON _PRO	1G-DDR3 (64*16*8)
AS4820TG-436G64Mn	Hungary	LX.PSE 02.071	AS4820TG_MADISO N_PRO1GBCKs_3V3	Ci5430M	MADISON _PRO	1G-DDR3 (64*16*8)
AS4820TG-436G64Mn	Israel	LX.PSE 02.070	AS4820TG_MADISO N_PRO1GBCKs_3V3	Ci5430M	MADISON _PRO	1G-DDR3 (64*16*8)
AS4820TG-436G64Mn	Czech	LX.PSE 02.069	AS4820TG_MADISO N_PRO1GBCKs_3V3	Ci5430M	MADISON _PRO	1G-DDR3 (64*16*8)
AS4820TG-436G64Mn	Cyprus	LX.PSE 02.068	AS4820TG_MADISO N_PRO1GBCKs_3V3	Ci5430M	MADISON _PRO	1G-DDR3 (64*16*8)
AS4820TG-436G64Mn	Portugal	LX.PSE 02.067	AS4820TG_MADISO N_PRO1GBCKs_3V3	Ci5430M	MADISON _PRO	1G-DDR3 (64*16*8)
AS4820TG-436G64Mn	Baltic	LX.PSE 02.066	AS4820TG_MADISO N_PRO1GBCKs_3V3	Ci5430M	MADISON _PRO	1G-DDR3 (64*16*8)
AS4820TG-436G64Mn	Denmark	LX.PSE 02.065	AS4820TG_MADISO N_PRO1GBCKs_3V3	Ci5430M	MADISON _PRO	1G-DDR3 (64*16*8)
AS4820TG-436G64Mn	Eastern Europe	LX.PSE 02.064	AS4820TG_MADISO N_PRO1GBCKs_3V3	Ci5430M	MADISON _PRO	1G-DDR3 (64*16*8)
AS4820TG-436G64Mn	Italy	LX.PSE 02.063	AS4820TG_MADISO N_PRO1GBCKs_3V3	Ci5430M	MADISON _PRO	1G-DDR3 (64*16*8)
AS4820TG-436G64Mn	Spain	LX.PSE 02.062	AS4820TG_MADISO N_PRO1GBCKs_3V3	Ci5430M	MADISON _PRO	1G-DDR3 (64*16*8)
AS4820TG-436G64Mn	Eastern Europe	LX.PSE 02.061	AS4820TG_MADISO N_PRO1GBCKs_3V3	Ci5430M	MADISON _PRO	1G-DDR3 (64*16*8)
AS4820TG-436G64Mn	Serbia/ Macedonia	LX.PSE 02.060	AS4820TG_MADISO N_PRO1GBCKs_3V3	Ci5430M	MADISON _PRO	1G-DDR3 (64*16*8)
AS4820TG-436G64Mn	Baltic	LX.PSE 02.059	AS4820TG_MADISO N_PRO1GBCKs_3V3	Ci5430M	MADISON _PRO	1G-DDR3 (64*16*8)
AS4820TG-436G64Mn	Austria	LX.PSE 02.058	AS4820TG_MADISO N_PRO1GBCKs_3V3	Ci5430M	MADISON _PRO	1G-DDR3 (64*16*8)
AS4820TG-436G64Mn	Greece	LX.PSE 02.057	AS4820TG_MADISO N_PRO1GBCKs_3V3	Ci5430M	MADISON _PRO	1G-DDR3 (64*16*8)
AS4820TG-436G64Mn	Eastern Europe	LX.PSE 02.056	AS4820TG_MADISO N_PRO1GBCKs_3V3	Ci5430M	MADISON _PRO	1G-DDR3 (64*16*8)
AS4820TG-436G64Mn	France	LX.PSE 02.055	AS4820TG_MADISO N_PRO1GBCKs_3V3	Ci5430M	MADISON _PRO	1G-DDR3 (64*16*8)
AS4820TG-434G64Mn	South Africa	LX.PSE 02.054	AS4820TG_MADISO N_PRO1GBCKs_3V3	Ci5430M	MADISON _PRO	1G-DDR3 (64*16*8)
AS4820TG-434G64Mn	Middle East	LX.PSE 02.053	AS4820TG_MADISO N_PRO1GBCKs_3V3	Ci5430M	MADISON _PRO	1G-DDR3 (64*16*8)
AS4820TG-434G64Mn	Middle East	LX.PSE 02.052	AS4820TG_MADISO N_PRO1GBCKs_3V3	Ci5430M	MADISON _PRO	1G-DDR3 (64*16*8)
AS4820TG-434G64Mn	Turkey	LX.PSE 02.051	AS4820TG_MADISO N_PRO1GBCKs_3V3	Ci5430M	MADISON _PRO	1G-DDR3 (64*16*8)
AS4820TG-434G64Mn	Middle East	LX.PSE 02.050	AS4820TG_MADISO N_PRO1GBCKs_3V3	Ci5430M	MADISON _PRO	1G-DDR3 (64*16*8)

Model	Country	Acer Part No	BOM Name	CPU	VGA Chip	VRAM 1
AS4820TG-434G64Mn	Middle East	LX.PSE 02.049	AS4820TG_MADISON_PRO1GBCKs_3V3	Ci5430M	MADISON_PRO	1G-DDR3 (64*16*8)
AS4820TG-434G64Mn	South Africa	LX.PSE 02.048	AS4820TG_MADISON_PRO1GBCKs_3V3	Ci5430M	MADISON_PRO	1G-DDR3 (64*16*8)
AS4820TG-434G64Mn	Middle East	LX.PSE 02.047	AS4820TG_MADISON_PRO1GBCKs_3V3	Ci5430M	MADISON_PRO	1G-DDR3 (64*16*8)
AS4820TG-434G64Mn	Algeria	LX.PSE 02.046	AS4820TG_MADISON_PRO1GBCKs_3V3	Ci5430M	MADISON_PRO	1G-DDR3 (64*16*8)
AS4820TG-434G64Mn	Middle East	LX.PSE 02.045	AS4820TG_MADISON_PRO1GBCKs_3V3	Ci5430M	MADISON_PRO	1G-DDR3 (64*16*8)
AS4820TG-434G64Mn	Middle East	LX.PSE 02.044	AS4820TG_MADISON_PRO1GBCKs_3V3	Ci5430M	MADISON_PRO	1G-DDR3 (64*16*8)
AS4820TG-434G64Mn	South Africa	LX.PSE 02.043	AS4820TG_MADISON_PRO1GBCKs_3V3	Ci5430M	MADISON_PRO	1G-DDR3 (64*16*8)
AS4820TG-434G64Mn	Middle East	LX.PSE 02.042	AS4820TG_MADISON_PRO1GBCKs_3V3	Ci5430M	MADISON_PRO	1G-DDR3 (64*16*8)
AS4820TG-434G64Mn	Middle East	LX.PSE 02.041	AS4820TG_MADISON_PRO1GBCKs_3V3	Ci5430M	MADISON_PRO	1G-DDR3 (64*16*8)
AS4820TG-434G64Mn	Poland	LX.PSE 02.040	AS4820TG_MADISON_PRO1GBCKs_3V3	Ci5430M	MADISON_PRO	1G-DDR3 (64*16*8)
AS4820TG-434G64Mn	Germany	LX.PSE 02.039	AS4820TG_MADISON_PRO1GBCKs_3V3	Ci5430M	MADISON_PRO	1G-DDR3 (64*16*8)
AS4820TG-434G64Mn	Eastern Europe	LX.PSE 02.038	AS4820TG_MADISON_PRO1GBCKs_3V3	Ci5430M	MADISON_PRO	1G-DDR3 (64*16*8)
AS4820TG-434G64Mn	Latvia	LX.PSE 02.037	AS4820TG_MADISON_PRO1GBCKs_3V3	Ci5430M	MADISON_PRO	1G-DDR3 (64*16*8)
AS4820TG-434G64Mn	Latvia	LX.PSE 02.036	AS4820TG_MADISON_PRO1GBCKs_3V3	Ci5430M	MADISON_PRO	1G-DDR3 (64*16*8)
AS4820TG-434G64Mn	Hungary	LX.PSE 02.035	AS4820TG_MADISON_PRO1GBCKs_3V3	Ci5430M	MADISON_PRO	1G-DDR3 (64*16*8)
AS4820TG-434G64Mn	Israel	LX.PSE 02.034	AS4820TG_MADISON_PRO1GBCKs_3V3	Ci5430M	MADISON_PRO	1G-DDR3 (64*16*8)
AS4820TG-434G64Mn	Czech	LX.PSE 02.033	AS4820TG_MADISON_PRO1GBCKs_3V3	Ci5430M	MADISON_PRO	1G-DDR3 (64*16*8)
AS4820TG-434G64Mn	Cyprus	LX.PSE 02.032	AS4820TG_MADISON_PRO1GBCKs_3V3	Ci5430M	MADISON_PRO	1G-DDR3 (64*16*8)
AS4820TG-434G64Mn	Portugal	LX.PSE 02.031	AS4820TG_MADISON_PRO1GBCKs_3V3	Ci5430M	MADISON_PRO	1G-DDR3 (64*16*8)
AS4820TG-434G64Mn	Luxembourg	LX.PSE 02.030	AS4820TG_MADISON_PRO1GBCKs_3V3	Ci5430M	MADISON_PRO	1G-DDR3 (64*16*8)
AS4820TG-434G64Mn	Holland	LX.PSE 02.029	AS4820TG_MADISON_PRO1GBCKs_3V3	Ci5430M	MADISON_PRO	1G-DDR3 (64*16*8)
AS4820TG-434G64Mn	Belgium	LX.PSE 02.028	AS4820TG_MADISON_PRO1GBCKs_3V3	Ci5430M	MADISON_PRO	1G-DDR3 (64*16*8)
AS4820TG-434G64Mn	Switzerland	LX.PSE 02.027	AS4820TG_MADISON_PRO1GBCKs_3V3	Ci5430M	MADISON_PRO	1G-DDR3 (64*16*8)
AS4820TG-434G64Mn	Baltic	LX.PSE 02.026	AS4820TG_MADISON_PRO1GBCKs_3V3	Ci5430M	MADISON_PRO	1G-DDR3 (64*16*8)

Model	Country	Acer Part No	BOM Name	CPU	VGA Chip	VRAM 1
AS4820TG-434G64Mn	UK	LX.PSE 02.025	AS4820TG_MADISO N_PRO1GBCKs_3V3	Ci5430M	MADISON _PRO	1G-DDR3 (64*16*8)
AS4820TG-434G64Mn	Eastern Europe	LX.PSE 02.024	AS4820TG_MADISO N_PRO1GBCKs_3V3	Ci5430M	MADISON _PRO	1G-DDR3 (64*16*8)
AS4820TG-434G64Mn	Baltic	LX.PSE 02.023	AS4820TG_MADISO N_PRO1GBCKs_3V3	Ci5430M	MADISON _PRO	1G-DDR3 (64*16*8)
AS4820TG-434G64Mn	Eastern Europe	LX.PSE 02.021	AS4820TG_MADISO N_PRO1GBCKs_3V3	Ci5430M	MADISON _PRO	1G-DDR3 (64*16*8)
AS4820TG-434G64Mn	Spain	LX.PSE 02.019	AS4820TG_MADISO N_PRO1GBCKs_3V3	Ci5430M	MADISON _PRO	1G-DDR3 (64*16*8)
AS4820TG-434G64Mn	Italy	LX.PSE 02.020	AS4820TG_MADISO N_PRO1GBCKs_3V3	Ci5430M	MADISON _PRO	1G-DDR3 (64*16*8)
AS4820TG-434G64Mn	Eastern Europe	LX.PSE 02.018	AS4820TG_MADISO N_PRO1GBCKs_3V3	Ci5430M	MADISON _PRO	1G-DDR3 (64*16*8)
AS4820TG-434G64Mn	Serbia/ Macedonia	LX.PSE 02.017	AS4820TG_MADISO N_PRO1GBCKs_3V3	Ci5430M	MADISON _PRO	1G-DDR3 (64*16*8)
AS4820TG-434G64Mn	Baltic	LX.PSE 02.016	AS4820TG_MADISO N_PRO1GBCKs_3V3	Ci5430M	MADISON _PRO	1G-DDR3 (64*16*8)
AS4820TG-434G64Mn	Austria	LX.PSE 02.015	AS4820TG_MADISO N_PRO1GBCKs_3V3	Ci5430M	MADISON _PRO	1G-DDR3 (64*16*8)
AS4820TG-434G64Mn	Greece	LX.PSE 02.014	AS4820TG_MADISO N_PRO1GBCKs_3V3	Ci5430M	MADISON _PRO	1G-DDR3 (64*16*8)
AS4820TG-434G64Mn	Eastern Europe	LX.PSE 02.013	AS4820TG_MADISO N_PRO1GBCKs_3V3	Ci5430M	MADISON _PRO	1G-DDR3 (64*16*8)
AS4820TG-434G64Mn	France	LX.PSE 02.012	AS4820TG_MADISO N_PRO1GBCKs_3V3	Ci5430M	MADISON _PRO	1G-DDR3 (64*16*8)
AS4820TG-522G64Mn	Hong Kong	LX.PSE 02.011	AS4820TG_MADISO N_PRO1GBCKs_3V3	Ci5520M	MADISON _PRO	1G-DDR3 (64*16*8)
AS4820TG-432G50Mn	Hong Kong	LX.PSE 02.010	AS4820TG_MADISO N_PRO1GBCKs_3V3	Ci5430M	MADISON _PRO	1G-DDR3 (64*16*8)
AS4820TG-524G50Mn	UK	LX.PSE 02.009	AS4820TG_MADISO N_PRO1GBCKs_3V3	Ci5520M	MADISON _PRO	1G-DDR3 (64*16*8)
AS4820TG-438G32Mn	WW	S2.PSE 02.004	AS4820TG_MADISO N_PRO1GBCKs_3V3	Ci5430M	MADISON _PRO	1G-DDR3 (64*16*8)
AS4820TG-624G64Mn	Singapore	LX.PSE 02.004	AS4820TG_MADISO N_PRO1GBCKs_3V3	Ci7620M	MADISON _PRO	1G-DDR3 (64*16*8)
AS4820TG-626G64Mn	Singapore	LX.PSE 02.003	AS4820TG_MADISO N_PRO1GBCKs_3V3	Ci7620M	MADISON _PRO	1G-DDR3 (64*16*8)
AS4820TG-524G64Mn	Singapore	LX.PSE 02.002	AS4820TG_MADISO N_PRO1GBCKs_3V3	Ci5520M	MADISON _PRO	1G-DDR3 (64*16*8)
AS4820TG-526G64Mn	Singapore	LX.PSE 02.001	AS4820TG_MADISO N_PRO1GBCKs_3V3	Ci5520M	MADISON _PRO	1G-DDR3 (64*16*8)
AS4820TG-528G64Mn	WW	S2.PSE 02.002	AS4820TG_MADISO N_PRO1GBCKs_3V3	Ci5520M	MADISON _PRO	1G-DDR3 (64*16*8)
AS4820T-522G16Mn	WW	S2.PSE 02.001	AS4820TG_MADISO N_PRO1GBCKs_3V3	Ci5520M	MADISON _PRO	1G-DDR3 (64*16*8)
AS4820TG-524G64Mn	Thailand	LX.PVL 02.007	AS4820TG_MADISO N_PRO1GBGCKs_3 V3	Ci5520M	MADISON _PRO	1G-DDR3 (64*16*8)

Model	Country	Acer Part No	BOM Name	CPU	VGA Chip	VRAM 1
AS4820TG-624G64Mn	Thailand	LX.PVL 02.008	AS4820TG_MADISON_PRO1GBGcks_3V3	Ci7620M	MADISON_PRO	1G-DDR3 (64*16*8)
AS4820TG-624G64Mn	Thailand	LX.PVL 02.004	AS4820TG_MADISON_PRO1GBGcks_3V3	Ci7620M	MADISON_PRO	1G-DDR3 (64*16*8)
AS4820TG-624G64Mn	Thailand	LX.PVL 02.003	AS4820TG_MADISON_PRO1GBGcks_3V3	Ci7620M	MADISON_PRO	1G-DDR3 (64*16*8)
AS4820TG-524G50Mn	Thailand	LX.PVL 02.002	AS4820TG_MADISON_PRO1GBGcks_3V3	Ci5520M	MADISON_PRO	1G-DDR3 (64*16*8)
AS4820TG-524G50Mn	Thailand	LX.PVL 02.001	AS4820TG_MADISON_PRO1GBGcks_3V3	Ci5520M	MADISON_PRO	1G-DDR3 (64*16*8)
AS4820TG-334G16Mn	WW	S2.PVL 02.001	AS4820TG_MADISON_PRO1GBGcks_3V3	Ci3330M	MADISON_PRO	1G-DDR3 (64*16*8)
AS4820TG-433G64Mn	Indonesia	LX.PS G02.128	AS4820TG_PARK_X T512Cks_3V3	Ci5430M	PARK_XT	512M-DDR3 (64*16*4)
AS4820TG-334G50Mn	Middle East	LX.PS G0C.004	AS4820TG_PARK_X T512Cks_3V3	Ci3330M	PARK_XT	512M-DDR3 (64*16*4)
AS4820TG-332G32Mn	China	LX.PS G02.073	AS4820TG_PARK_X T512Cks_3V3	Ci3330M	PARK_XT	512M-DDR3 (64*16*4)
AS4820TG-334G50Mn	Germany	LX.PS G02.127	AS4820TG_PARK_X T512Cks_3V3	Ci3330M	PARK_XT	512M-DDR3 (64*16*4)
AS4820TG-433G32Mn	Middle East	LX.PS G02.119	AS4820TG_PARK_X T512Cks_3V3	Ci5430M	PARK_XT	512M-DDR3 (64*16*4)
AS4820TG-433G32Mn	Middle East	LX.PS G02.118	AS4820TG_PARK_X T512Cks_3V3	Ci5430M	PARK_XT	512M-DDR3 (64*16*4)
AS4820TG-433G32Mn	South Africa	LX.PS G02.117	AS4820TG_PARK_X T512Cks_3V3	Ci5430M	PARK_XT	512M-DDR3 (64*16*4)
AS4820TG-433G32Mn	Turkey	LX.PS G02.116	AS4820TG_PARK_X T512Cks_3V3	Ci5430M	PARK_XT	512M-DDR3 (64*16*4)
AS4820TG-433G32Mn	Middle East	LX.PS G02.115	AS4820TG_PARK_X T512Cks_3V3	Ci5430M	PARK_XT	512M-DDR3 (64*16*4)
AS4820TG-433G32Mn	South Africa	LX.PS G02.114	AS4820TG_PARK_X T512Cks_3V3	Ci5430M	PARK_XT	512M-DDR3 (64*16*4)
AS4820TG-433G32Mn	Middle East	LX.PS G02.113	AS4820TG_PARK_X T512Cks_3V3	Ci5430M	PARK_XT	512M-DDR3 (64*16*4)

Model	Country	Acer Part No	BOM Name	CPU	VGA Chip	VRAM 1
AS4820TG-433G32Mn	Algeria	LX.PS G02.11 2	AS4820TG_PARK_X T512Cks_3V3	Ci5430M	PARK_XT	512M- DDR3 (64*16*4)
AS4820TG-433G32Mn	South Africa	LX.PS G02.11 1	AS4820TG_PARK_X T512Cks_3V3	Ci5430M	PARK_XT	512M- DDR3 (64*16*4)
AS4820TG-433G32Mn	Middle East	LX.PS G02.11 0	AS4820TG_PARK_X T512Cks_3V3	Ci5430M	PARK_XT	512M- DDR3 (64*16*4)
AS4820TG-433G32Mn	Middle East	LX.PS G02.10 9	AS4820TG_PARK_X T512Cks_3V3	Ci5430M	PARK_XT	512M- DDR3 (64*16*4)
AS4820TG-433G32Mn	Middle East	LX.PS G02.10 8	AS4820TG_PARK_X T512Cks_3V3	Ci5430M	PARK_XT	512M- DDR3 (64*16*4)
AS4820TG-433G32Mn	Middle East	LX.PS G02.10 7	AS4820TG_PARK_X T512Cks_3V3	Ci5430M	PARK_XT	512M- DDR3 (64*16*4)
AS4820TG-433G32Mn	South Africa	LX.PS G02.10 6	AS4820TG_PARK_X T512Cks_3V3	Ci5430M	PARK_XT	512M- DDR3 (64*16*4)
AS4820TG-433G32Mn	Ukraine	LX.PS G02.10 5	AS4820TG_PARK_X T512Cks_3V3	Ci5430M	PARK_XT	512M- DDR3 (64*16*4)
AS4820TG-433G32Mi	Russia	LX.PS G02.10 4	AS4820TG_PARK_X T512Cks_3V3	Ci5430M	PARK_XT	512M- DDR3 (64*16*4)
AS4820TG-433G32Mn	Germany	LX.PS G02.10 3	AS4820TG_PARK_X T512Cks_3V3	Ci5430M	PARK_XT	512M- DDR3 (64*16*4)
AS4820TG-433G32Mn	Poland	LX.PS G02.10 2	AS4820TG_PARK_X T512Cks_3V3	Ci5430M	PARK_XT	512M- DDR3 (64*16*4)
AS4820TG-433G32Mn	Baltic	LX.PS G02.10 1	AS4820TG_PARK_X T512Cks_3V3	Ci5430M	PARK_XT	512M- DDR3 (64*16*4)
AS4820TG-433G32Mn	Holland	LX.PS G02.09 9	AS4820TG_PARK_X T512Cks_3V3	Ci5430M	PARK_XT	512M- DDR3 (64*16*4)
AS4820TG-433G32Mn	Belgium	LX.PS G02.09 8	AS4820TG_PARK_X T512Cks_3V3	Ci5430M	PARK_XT	512M- DDR3 (64*16*4)
AS4820TG-433G32Mn	Switzerland	LX.PS G02.09 7	AS4820TG_PARK_X T512Cks_3V3	Ci5430M	PARK_XT	512M- DDR3 (64*16*4)
AS4820TG-433G32Mn	Luxembourg	LX.PS G02.09 6	AS4820TG_PARK_X T512Cks_3V3	Ci5430M	PARK_XT	512M- DDR3 (64*16*4)
AS4820TG-433G32Mn	Latvia	LX.PS G02.09 5	AS4820TG_PARK_X T512Cks_3V3	Ci5430M	PARK_XT	512M- DDR3 (64*16*4)

Model	Country	Acer Part No	BOM Name	CPU	VGA Chip	VRAM 1
AS4820TG-433G32Mn	Latvia	LX.PS G02.09 4	AS4820TG_PARK_X T512Cks_3V3	Ci5430M	PARK_XT	512M- DDR3 (64*16*4)
AS4820TG-433G32Mn	UK	LX.PS G02.09 3	AS4820TG_PARK_X T512Cks_3V3	Ci5430M	PARK_XT	512M- DDR3 (64*16*4)
AS4820TG-433G32Mn	Eastern Europe	LX.PS G02.09 2	AS4820TG_PARK_X T512Cks_3V3	Ci5430M	PARK_XT	512M- DDR3 (64*16*4)
AS4820TG-433G32Mn	Eastern Europe	LX.PS G02.09 1	AS4820TG_PARK_X T512Cks_3V3	Ci5430M	PARK_XT	512M- DDR3 (64*16*4)
AS4820TG-433G32Mn	Czech	LX.PS G02.09 0	AS4820TG_PARK_X T512Cks_3V3	Ci5430M	PARK_XT	512M- DDR3 (64*16*4)
AS4820TG-433G32Mn	Hungary	LX.PS G02.08 9	AS4820TG_PARK_X T512Cks_3V3	Ci5430M	PARK_XT	512M- DDR3 (64*16*4)
AS4820TG-433G32Mn	Israel	LX.PS G02.08 8	AS4820TG_PARK_X T512Cks_3V3	Ci5430M	PARK_XT	512M- DDR3 (64*16*4)
AS4820TG-433G32Mn	Baltic	LX.PS G02.08 7	AS4820TG_PARK_X T512Cks_3V3	Ci5430M	PARK_XT	512M- DDR3 (64*16*4)
AS4820TG-433G32Mn	Portugal	LX.PS G02.08 6	AS4820TG_PARK_X T512Cks_3V3	Ci5430M	PARK_XT	512M- DDR3 (64*16*4)
AS4820TG-433G32Mn	Cyprus	LX.PS G02.08 5	AS4820TG_PARK_X T512Cks_3V3	Ci5430M	PARK_XT	512M- DDR3 (64*16*4)
AS4820TG-433G32Mn	Baltic	LX.PS G02.08 4	AS4820TG_PARK_X T512Cks_3V3	Ci5430M	PARK_XT	512M- DDR3 (64*16*4)
AS4820TG-433G32Mn	Serbia/ Macedonia	LX.PS G02.08 3	AS4820TG_PARK_X T512Cks_3V3	Ci5430M	PARK_XT	512M- DDR3 (64*16*4)
AS4820TG-433G32Mn	Italy	LX.PS G02.08 2	AS4820TG_PARK_X T512Cks_3V3	Ci5430M	PARK_XT	512M- DDR3 (64*16*4)
AS4820TG-433G32Mn	Spain	LX.PS G02.08 1	AS4820TG_PARK_X T512Cks_3V3	Ci5430M	PARK_XT	512M- DDR3 (64*16*4)
AS4820TG-433G32Mn	Denmark	LX.PS G02.08 0	AS4820TG_PARK_X T512Cks_3V3	Ci5430M	PARK_XT	512M- DDR3 (64*16*4)
AS4820TG-433G32Mn	Eastern Europe	LX.PS G02.07 9	AS4820TG_PARK_X T512Cks_3V3	Ci5430M	PARK_XT	512M- DDR3 (64*16*4)
AS4820TG-433G32Mn	Eastern Europe	LX.PS G02.07 8	AS4820TG_PARK_X T512Cks_3V3	Ci5430M	PARK_XT	512M- DDR3 (64*16*4)

Model	Country	Acer Part No	BOM Name	CPU	VGA Chip	VRAM 1
AS4820TG-433G32Mn	Greece	LX.PS G02.07 7	AS4820TG_PARK_X T512Cks_3V3	Ci5430M	PARK_XT	512M- DDR3 (64*16*4)
AS4820TG-433G32Mn	Austria	LX.PS G02.07 6	AS4820TG_PARK_X T512Cks_3V3	Ci5430M	PARK_XT	512M- DDR3 (64*16*4)
AS4820TG-433G32Mn	Eastern Europe	LX.PS G02.07 4	AS4820TG_PARK_X T512Cks_3V3	Ci5430M	PARK_XT	512M- DDR3 (64*16*4)
AS4820TG-433G32Mn	France	LX.PS G02.07 5	AS4820TG_PARK_X T512Cks_3V3	Ci5430M	PARK_XT	512M- DDR3 (64*16*4)
AS4820TG-333G32Mn	Middle East	LX.PS G02.07 2	AS4820TG_PARK_X T512Cks_3V3	Ci3330M	PARK_XT	512M- DDR3 (64*16*4)
AS4820TG-433G32Mn	Middle East	LX.PS G02.07 1	AS4820TG_PARK_X T512Cks_3V3	Ci5430M	PARK_XT	512M- DDR3 (64*16*4)
AS4820TG-434G50Mn	Italy	LX.PS G02.05 7	AS4820TG_PARK_X T512Cks_3V3	Ci5430M	PARK_XT	512M- DDR3 (64*16*4)
AS4820TG-434G50Mn	Eastern Europe	LX.PS G02.02 8	AS4820TG_PARK_X T512Cks_3V3	Ci5430M	PARK_XT	512M- DDR3 (64*16*4)
AS4820TG-334G32Mn	France	LX.PS G02.05 8	AS4820TG_PARK_X T512Cks_3V3	Ci3330M	PARK_XT	512M- DDR3 (64*16*4)
AS4820TG-332G32Mn	Turkey	LX.PS G02.07 0	AS4820TG_PARK_X T512Cks_3V3	Ci3330M	PARK_XT	512M- DDR3 (64*16*4)
AS4820TG-522G32Mn	Turkey	LX.PS G02.06 9	AS4820TG_PARK_X T512Cks_3V3	Ci5520M	PARK_XT	512M- DDR3 (64*16*4)
AS4820TG-432G50Mn	Thailand	LX.PS G02.06 8	AS4820TG_PARK_X T512Cks_3V3	Ci5430M	PARK_XT	512M- DDR3 (64*16*4)
AS4820TG-432G50Mn	Thailand	LX.PS G02.06 7	AS4820TG_PARK_X T512Cks_3V3	Ci5430M	PARK_XT	512M- DDR3 (64*16*4)
AS4820TG-432G50Mn	GCTWN	LX.PS G02.05 5	AS4820TG_PARK_X T512Cks_3V3	Ci5430M	PARK_XT	512M- DDR3 (64*16*4)
AS4820TG-432G50Mn	Malaysia	LX.PS G02.06 6	AS4820TG_PARK_X T512Cks_3V3	Ci5430M	PARK_XT	512M- DDR3 (64*16*4)
AS4820TG-434G50Mn	Denmark	LX.PS G02.01 8	AS4820TG_PARK_X T512Cks_3V3	Ci5430M	PARK_XT	512M- DDR3 (64*16*4)
AS4820TG-432G32Mn	Vietnam	LX.PS G0C.00 3	AS4820TG_PARK_X T512Cks_3V3	Ci5430M	PARK_XT	512M- DDR3 (64*16*4)

Model	Country	Acer Part No	BOM Name	CPU	VGA Chip	VRAM 1
AS4820TG-332G32Mn	Vietnam	LX.PS G0C.00 2	AS4820TG_PARK_X T512Cks_3V3	Ci3330M	PARK_XT	512M- DDR3 (64*16*4)
AS4820TG-434G64Mn	Middle East	LX.PS G02.06 5	AS4820TG_PARK_X T512Cks_3V3	Ci5430M	PARK_XT	512M- DDR3 (64*16*4)
AS4820TG-524G32Mn	Greece	LX.PS G02.06 4	AS4820TG_PARK_X T512Cks_3V3	Ci5520M	PARK_XT	512M- DDR3 (64*16*4)
AS4820TG-334G50Mn	Middle East	LX.PS G02.06 3	AS4820TG_PARK_X T512Cks_3V3	Ci3330M	PARK_XT	512M- DDR3 (64*16*4)
AS4820TG-333G25Mi	Russia	LX.PS G02.06 2	AS4820TG_PARK_X T512Cks_3V3	Ci3330M	PARK_XT	512M- DDR3 (64*16*4)
AS4820TG-352G25Mn	Turkey	LX.PS G02.06 0	AS4820TG_PARK_X T512Cks_3V3	Ci3350M	PARK_XT	512M- DDR3 (64*16*4)
AS4820TG-353G32Mn	Turkey	LX.PS G02.06 1	AS4820TG_PARK_X T512Cks_3V3	Ci3350M	PARK_XT	512M- DDR3 (64*16*4)
AS4820TG-332G25Mn	Turkey	LX.PS G02.05 9	AS4820TG_PARK_X T512Cks_3V3	Ci3330M	PARK_XT	512M- DDR3 (64*16*4)
AS4820TG-522G50Mn	Malaysia	LX.PS G02.05 6	AS4820TG_PARK_X T512Cks_3V3	Ci5520M	PARK_XT	512M- DDR3 (64*16*4)
AS4820TG-524G64Mn	GCTWN	LX.PS G02.05 4	AS4820TG_PARK_X T512Cks_3V3	Ci5520M	PARK_XT	512M- DDR3 (64*16*4)
AS4820TG-432G64Mn	GCTWN	LX.PS G02.05 3	AS4820TG_PARK_X T512Cks_3V3	Ci5430M	PARK_XT	512M- DDR3 (64*16*4)
AS4820TG-434G32Mn	Thailand	LX.PS G0C.00 1	AS4820TG_PARK_X T512Cks_3V3	Ci5430M	PARK_XT	512M- DDR3 (64*16*4)
AS4820TG-334G32Mn	Thailand	LX.PS G02.05 2	AS4820TG_PARK_X T512Cks_3V3	Ci3330M	PARK_XT	512M- DDR3 (64*16*4)
AS4820TG-432G32Mn	China	LX.PS G02.05 1	AS4820TG_PARK_X T512Cks_3V3	Ci5430M	PARK_XT	512M- DDR3 (64*16*4)
AS4820TG-434G50Mn	South Africa	LX.PS G02.05 0	AS4820TG_PARK_X T512Cks_3V3	Ci5430M	PARK_XT	512M- DDR3 (64*16*4)
AS4820TG-434G50Mn	Middle East	LX.PS G02.04 9	AS4820TG_PARK_X T512Cks_3V3	Ci5430M	PARK_XT	512M- DDR3 (64*16*4)
AS4820TG-434G50Mn	Middle East	LX.PS G02.04 8	AS4820TG_PARK_X T512Cks_3V3	Ci5430M	PARK_XT	512M- DDR3 (64*16*4)

Model	Country	Acer Part No	BOM Name	CPU	VGA Chip	VRAM 1
AS4820TG-434G50Mn	Turkey	LX.PS G02.04 7	AS4820TG_PARK_X T512Cks_3V3	Ci5430M	PARK_XT	512M- DDR3 (64*16*4)
AS4820TG-434G50Mn	Middle East	LX.PS G02.04 6	AS4820TG_PARK_X T512Cks_3V3	Ci5430M	PARK_XT	512M- DDR3 (64*16*4)
AS4820TG-434G50Mn	Middle East	LX.PS G02.04 5	AS4820TG_PARK_X T512Cks_3V3	Ci5430M	PARK_XT	512M- DDR3 (64*16*4)
AS4820TG-434G50Mn	South Africa	LX.PS G02.04 4	AS4820TG_PARK_X T512Cks_3V3	Ci5430M	PARK_XT	512M- DDR3 (64*16*4)
AS4820TG-434G50Mn	Middle East	LX.PS G02.04 3	AS4820TG_PARK_X T512Cks_3V3	Ci5430M	PARK_XT	512M- DDR3 (64*16*4)
AS4820TG-434G50Mn	Algeria	LX.PS G02.04 2	AS4820TG_PARK_X T512Cks_3V3	Ci5430M	PARK_XT	512M- DDR3 (64*16*4)
AS4820TG-434G50Mn	Middle East	LX.PS G02.04 1	AS4820TG_PARK_X T512Cks_3V3	Ci5430M	PARK_XT	512M- DDR3 (64*16*4)
AS4820TG-434G50Mn	South Africa	LX.PS G02.03 9	AS4820TG_PARK_X T512Cks_3V3	Ci5430M	PARK_XT	512M- DDR3 (64*16*4)
AS4820TG-434G50Mn	Middle East	LX.PS G02.04 0	AS4820TG_PARK_X T512Cks_3V3	Ci5430M	PARK_XT	512M- DDR3 (64*16*4)
AS4820TG-434G50Mn	Middle East	LX.PS G02.03 8	AS4820TG_PARK_X T512Cks_3V3	Ci5430M	PARK_XT	512M- DDR3 (64*16*4)
AS4820TG-434G50Mn	Middle East	LX.PS G02.03 7	AS4820TG_PARK_X T512Cks_3V3	Ci5430M	PARK_XT	512M- DDR3 (64*16*4)
AS4820TG-434G50Mn	Poland	LX.PS G02.03 6	AS4820TG_PARK_X T512Cks_3V3	Ci5430M	PARK_XT	512M- DDR3 (64*16*4)
AS4820TG-434G50Mn	Germany	LX.PS G02.03 5	AS4820TG_PARK_X T512Cks_3V3	Ci5430M	PARK_XT	512M- DDR3 (64*16*4)
AS4820TG-434G50Mn	Luxembourg	LX.PS G02.03 4	AS4820TG_PARK_X T512Cks_3V3	Ci5430M	PARK_XT	512M- DDR3 (64*16*4)
AS4820TG-434G50Mn	Holland	LX.PS G02.03 3	AS4820TG_PARK_X T512Cks_3V3	Ci5430M	PARK_XT	512M- DDR3 (64*16*4)
AS4820TG-434G50Mn	Belgium	LX.PS G02.03 2	AS4820TG_PARK_X T512Cks_3V3	Ci5430M	PARK_XT	512M- DDR3 (64*16*4)
AS4820TG-434G50Mn	Switzerland	LX.PS G02.03 1	AS4820TG_PARK_X T512Cks_3V3	Ci5430M	PARK_XT	512M- DDR3 (64*16*4)

Model	Country	Acer Part No	BOM Name	CPU	VGA Chip	VRAM 1
AS4820TG-434G50Mn	Baltic	LX.PS G02.03 0	AS4820TG_PARK_X T512Cks_3V3	Ci5430M	PARK_XT	512M- DDR3 (64*16*4)
AS4820TG-434G50Mn	UK	LX.PS G02.02 9	AS4820TG_PARK_X T512Cks_3V3	Ci5430M	PARK_XT	512M- DDR3 (64*16*4)
AS4820TG-434G50Mn	Eastern Europe	LX.PS G02.02 7	AS4820TG_PARK_X T512Cks_3V3	Ci5430M	PARK_XT	512M- DDR3 (64*16*4)
AS4820TG-434G50Mn	Latvia	LX.PS G02.02 6	AS4820TG_PARK_X T512Cks_3V3	Ci5430M	PARK_XT	512M- DDR3 (64*16*4)
AS4820TG-434G50Mn	Latvia	LX.PS G02.02 5	AS4820TG_PARK_X T512Cks_3V3	Ci5430M	PARK_XT	512M- DDR3 (64*16*4)
AS4820TG-434G50Mn	Hungary	LX.PS G02.02 4	AS4820TG_PARK_X T512Cks_3V3	Ci5430M	PARK_XT	512M- DDR3 (64*16*4)
AS4820TG-434G50Mn	Israel	LX.PS G02.02 3	AS4820TG_PARK_X T512Cks_3V3	Ci5430M	PARK_XT	512M- DDR3 (64*16*4)
AS4820TG-434G50Mn	Czech	LX.PS G02.02 2	AS4820TG_PARK_X T512Cks_3V3	Ci5430M	PARK_XT	512M- DDR3 (64*16*4)
AS4820TG-434G50Mn	Cyprus	LX.PS G02.02 1	AS4820TG_PARK_X T512Cks_3V3	Ci5430M	PARK_XT	512M- DDR3 (64*16*4)
AS4820TG-434G50Mn	Portugal	LX.PS G02.02 0	AS4820TG_PARK_X T512Cks_3V3	Ci5430M	PARK_XT	512M- DDR3 (64*16*4)
AS4820TG-434G50Mn	Baltic	LX.PS G02.01 9	AS4820TG_PARK_X T512Cks_3V3	Ci5430M	PARK_XT	512M- DDR3 (64*16*4)
AS4820TG-434G50Mn	Eastern Europe	LX.PS G02.01 7	AS4820TG_PARK_X T512Cks_3V3	Ci5430M	PARK_XT	512M- DDR3 (64*16*4)
AS4820TG-434G50Mn	Italy	LX.PS G02.01 6	AS4820TG_PARK_X T512Cks_3V3	Ci5430M	PARK_XT	512M- DDR3 (64*16*4)
AS4820TG-434G50Mn	Spain	LX.PS G02.01 5	AS4820TG_PARK_X T512Cks_3V3	Ci5430M	PARK_XT	512M- DDR3 (64*16*4)
AS4820TG-434G50Mn	Eastern Europe	LX.PS G02.01 4	AS4820TG_PARK_X T512Cks_3V3	Ci5430M	PARK_XT	512M- DDR3 (64*16*4)
AS4820TG-434G50Mn	Serbia/ Macedonia	LX.PS G02.01 3	AS4820TG_PARK_X T512Cks_3V3	Ci5430M	PARK_XT	512M- DDR3 (64*16*4)
AS4820TG-434G50Mn	Baltic	LX.PS G02.01 2	AS4820TG_PARK_X T512Cks_3V3	Ci5430M	PARK_XT	512M- DDR3 (64*16*4)

Model	Country	Acer Part No	BOM Name	CPU	VGA Chip	VRAM 1
AS4820TG-434G50Mn	Austria	LX.PS G02.01 1	AS4820TG_PARK_X T512Cks_3V3	Ci5430M	PARK_XT	512M- DDR3 (64*16*4)
AS4820TG-434G50Mn	Greece	LX.PS G02.01 0	AS4820TG_PARK_X T512Cks_3V3	Ci5430M	PARK_XT	512M- DDR3 (64*16*4)
AS4820TG-434G50Mn	Eastern Europe	LX.PS G02.00 9	AS4820TG_PARK_X T512Cks_3V3	Ci5430M	PARK_XT	512M- DDR3 (64*16*4)
AS4820TG-434G50Mn	France	LX.PS G02.00 8	AS4820TG_PARK_X T512Cks_3V3	Ci5430M	PARK_XT	512M- DDR3 (64*16*4)
AS4820TG-434G50Mn	UK	LX.PS G02.00 7	AS4820TG_PARK_X T512Cks_3V3	Ci5430M	PARK_XT	512M- DDR3 (64*16*4)
AS4820TG-522G50Mn	WW	S2.PS G02.00 3	AS4820TG_PARK_X T512Cks_3V3	Ci5520M	PARK_XT	512M- DDR3 (64*16*4)
AS4820TG-624G64Mn	Singapore	LX.PS G02.00 3	AS4820TG_PARK_X T512Cks_3V3	Ci7620M	PARK_XT	512M- DDR3 (64*16*4)
AS4820TG-524G64Mn	Singapore	LX.PS G02.00 2	AS4820TG_PARK_X T512Cks_3V3	Ci5520M	PARK_XT	512M- DDR3 (64*16*4)
AS4820TG-434G50Mn	Singapore	LX.PS G02.00 1	AS4820TG_PARK_X T512Cks_3V3	Ci5430M	PARK_XT	512M- DDR3 (64*16*4)
AS4820TG-522G50Mn	WW	S2.PS G02.00 2	AS4820TG_PARK_X T512Cks_3V3	Ci5520M	PARK_XT	512M- DDR3 (64*16*4)
AS4820T-522G16Mn	WW	S2.PS G02.00 1	AS4820TG_PARK_X T512Cks_3V3	Ci5520M	PARK_XT	512M- DDR3 (64*16*4)
AS4820TG-332G16Mn	WW	S2.PV M02.00 1	AS4820TG_PARK_X T512Gcks_3V3	Ci3330M	PARK_XT	512M- DDR3 (64*16*4)
AS4820T-432G50Mn	Singapore	LX.PS N02.10 7	AS4820T_UMACKs_ 3	Ci5430M	UMA	N
AS4820T-354G32Mn	Chile	LX.PS N02.11 2	AS4820T_UMACKs_ 3	Ci3350M	UMA	N
AS4820T-354G32Mn	ACLA- Spanish	LX.PS N02.11 1	AS4820T_UMACKs_ 3	Ci3350M	UMA	N
AS4820T-354G32Mn	ACLA- Spanish	LX.PS N02.11 0	AS4820T_UMACKs_ 3	Ci3350M	UMA	N
AS4820T-354G32Mn	ACLA- Spanish	LX.PS N02.10 9	AS4820T_UMACKs_ 3	Ci3350M	UMA	N

Model	Country	Acer Part No	BOM Name	CPU	VGA Chip	VRAM 1
AS4820T-354G32Mn	ACLA-Portuguese	LX.PS N02.10 8	AS4820T_UMACKs_3	Ci3350M	UMA	N
AS4820T-432G50Mn	China	LX.PS N0C.00 5	AS4820T_UMACKs_3	Ci5430M	UMA	N
AS4820T-333G32Mn	Ukraine	LX.PS N02.10 6	AS4820T_UMACKs_3	Ci3330M	UMA	N
AS4820T-333G32Mi	Russia	LX.PS N02.10 5	AS4820T_UMACKs_3	Ci3330M	UMA	N
AS4820T-333G32Mn	Middle East	LX.PS N02.10 4	AS4820T_UMACKs_3	Ci3330M	UMA	N
AS4820T-333G32Mn	Middle East	LX.PS N02.10 3	AS4820T_UMACKs_3	Ci3330M	UMA	N
AS4820T-333G32Mn	South Africa	LX.PS N02.10 2	AS4820T_UMACKs_3	Ci3330M	UMA	N
AS4820T-333G32Mn	Turkey	LX.PS N02.10 1	AS4820T_UMACKs_3	Ci3330M	UMA	N
AS4820T-333G32Mn	Middle East	LX.PS N02.09 9	AS4820T_UMACKs_3	Ci3330M	UMA	N
AS4820T-333G32Mn	Middle East	LX.PS N02.09 8	AS4820T_UMACKs_3	Ci3330M	UMA	N
AS4820T-333G32Mn	South Africa	LX.PS N02.09 7	AS4820T_UMACKs_3	Ci3330M	UMA	N
AS4820T-333G32Mn	Middle East	LX.PS N02.09 6	AS4820T_UMACKs_3	Ci3330M	UMA	N
AS4820T-333G32Mn	Algeria	LX.PS N02.09 5	AS4820T_UMACKs_3	Ci3330M	UMA	N
AS4820T-333G32Mn	South Africa	LX.PS N02.09 4	AS4820T_UMACKs_3	Ci3330M	UMA	N
AS4820T-333G32Mn	Middle East	LX.PS N02.09 3	AS4820T_UMACKs_3	Ci3330M	UMA	N
AS4820T-333G32Mn	Middle East	LX.PS N02.09 2	AS4820T_UMACKs_3	Ci3330M	UMA	N
AS4820T-333G32Mn	Middle East	LX.PS N02.09 0	AS4820T_UMACKs_3	Ci3330M	UMA	N

Model	Country	Acer Part No	BOM Name	CPU	VGA Chip	VRAM 1
AS4820T-333G32Mn	Middle East	LX.PS N02.09 1	AS4820T_UMACKs_3	Ci3330M	UMA	N
AS4820T-333G32Mn	South Africa	LX.PS N02.08 9	AS4820T_UMACKs_3	Ci3330M	UMA	N
AS4820T-333G32Mn	Germany	LX.PS N02.08 8	AS4820T_UMACKs_3	Ci3330M	UMA	N
AS4820T-333G32Mn	Poland	LX.PS N02.08 7	AS4820T_UMACKs_3	Ci3330M	UMA	N
AS4820T-333G32Mn	Baltic	LX.PS N02.08 6	AS4820T_UMACKs_3	Ci3330M	UMA	N
AS4820T-333G32Mn	Holland	LX.PS N02.08 5	AS4820T_UMACKs_3	Ci3330M	UMA	N
AS4820T-333G32Mn	Belgium	LX.PS N02.08 4	AS4820T_UMACKs_3	Ci3330M	UMA	N
AS4820T-333G32Mn	Switzerland	LX.PS N02.08 3	AS4820T_UMACKs_3	Ci3330M	UMA	N
AS4820T-333G32Mn	Luxembourg	LX.PS N02.08 2	AS4820T_UMACKs_3	Ci3330M	UMA	N
AS4820T-333G32Mn	Latvia	LX.PS N02.08 1	AS4820T_UMACKs_3	Ci3330M	UMA	N
AS4820T-333G32Mn	Latvia	LX.PS N02.08 0	AS4820T_UMACKs_3	Ci3330M	UMA	N
AS4820T-333G32Mn	UK	LX.PS N02.07 9	AS4820T_UMACKs_3	Ci3330M	UMA	N
AS4820T-333G32Mn	Eastern Europe	LX.PS N02.07 8	AS4820T_UMACKs_3	Ci3330M	UMA	N
AS4820T-333G32Mn	Eastern Europe	LX.PS N02.07 7	AS4820T_UMACKs_3	Ci3330M	UMA	N
AS4820T-333G32Mn	Czech	LX.PS N02.07 6	AS4820T_UMACKs_3	Ci3330M	UMA	N
AS4820T-333G32Mn	Israel	LX.PS N02.07 4	AS4820T_UMACKs_3	Ci3330M	UMA	N
AS4820T-333G32Mn	Hungary	LX.PS N02.07 5	AS4820T_UMACKs_3	Ci3330M	UMA	N

Model	Country	Acer Part No	BOM Name	CPU	VGA Chip	VRAM 1
AS4820T-333G32Mn	Baltic	LX.PS N02.07 3	AS4820T_UMACKs_ 3	Ci3330M	UMA	N
AS4820T-333G32Mn	Portugal	LX.PS N02.07 2	AS4820T_UMACKs_ 3	Ci3330M	UMA	N
AS4820T-333G32Mn	Cyprus	LX.PS N02.07 1	AS4820T_UMACKs_ 3	Ci3330M	UMA	N
AS4820T-333G32Mn	Baltic	LX.PS N02.07 0	AS4820T_UMACKs_ 3	Ci3330M	UMA	N
AS4820T-333G32Mn	Serbia/ Macedonia	LX.PS N02.06 9	AS4820T_UMACKs_ 3	Ci3330M	UMA	N
AS4820T-333G32Mn	Italy	LX.PS N02.06 8	AS4820T_UMACKs_ 3	Ci3330M	UMA	N
AS4820T-333G32Mn	Spain	LX.PS N02.06 7	AS4820T_UMACKs_ 3	Ci3330M	UMA	N
AS4820T-333G32Mn	Denmark	LX.PS N02.06 6	AS4820T_UMACKs_ 3	Ci3330M	UMA	N
AS4820T-333G32Mn	Eastern Europe	LX.PS N02.06 5	AS4820T_UMACKs_ 3	Ci3330M	UMA	N
AS4820T-333G32Mn	Eastern Europe	LX.PS N02.06 4	AS4820T_UMACKs_ 3	Ci3330M	UMA	N
AS4820T-333G32Mn	Greece	LX.PS N02.06 3	AS4820T_UMACKs_ 3	Ci3330M	UMA	N
AS4820T-333G32Mn	Austria	LX.PS N02.06 2	AS4820T_UMACKs_ 3	Ci3330M	UMA	N
AS4820T-333G32Mn	France	LX.PS N02.06 1	AS4820T_UMACKs_ 3	Ci3330M	UMA	N
AS4820T-333G32Mn	Eastern Europe	LX.PS N02.06 0	AS4820T_UMACKs_ 3	Ci3330M	UMA	N
AS4820T-331G32Mn	Malaysia	LX.PS N0C.00 4	AS4820T_UMACKs_ 3	Ci3330M	UMA	N
AS4820T-432G32Mn	Vietnam	LX.PS N0C.00 3	AS4820T_UMACKs_ 3	Ci5430M	UMA	N
AS4820T-332G32Mn	Vietnam	LX.PS N0C.00 2	AS4820T_UMACKs_ 3	Ci3330M	UMA	N

Model	Country	Acer Part No	BOM Name	CPU	VGA Chip	VRAM 1
AS4820T-332G32Mn	Malaysia	LX.PS N02.05 9	AS4820T_UMACks_3	Ci3330M	UMA	N
AS4820T-333G50Mn	Italy	LX.PS N02.05 8	AS4820T_UMACks_3	Ci3330M	UMA	N
AS4820T-522G50Mn	Philippines	LX.PS N02.05 7	AS4820T_UMACks_3	Ci5520M	UMA	N
AS4820T-333G32Mn	Italy	LX.PS N02.05 6	AS4820T_UMACks_3	Ci3330M	UMA	N
AS4820T-432G32Mn	Malaysia	LX.PS N02.05 5	AS4820T_UMACks_3	Ci5430M	UMA	N
AS4820T-432G32Mn	Malaysia	LX.PS N0C.00 1	AS4820T_UMACks_3	Ci5430M	UMA	N
AS4820T-432G32Mn	Thailand	LX.PS N02.05 4	AS4820T_UMACks_3	Ci5430M	UMA	N
AS4820T-332G32Mn	Thailand	LX.PS N02.05 3	AS4820T_UMACks_3	Ci3330M	UMA	N
AS4820T-332G25Mn	China	LX.PS N02.05 2	AS4820T_UMACks_3	Ci3330M	UMA	N
AS4820T-334G32Mn	South Africa	LX.PS N02.05 1	AS4820T_UMACks_3	Ci3330M	UMA	N
AS4820T-334G32Mn	Middle East	LX.PS N02.05 0	AS4820T_UMACks_3	Ci3330M	UMA	N
AS4820T-334G32Mn	Middle East	LX.PS N02.04 9	AS4820T_UMACks_3	Ci3330M	UMA	N
AS4820T-334G32Mn	Turkey	LX.PS N02.04 8	AS4820T_UMACks_3	Ci3330M	UMA	N
AS4820T-334G32Mn	Middle East	LX.PS N02.04 7	AS4820T_UMACks_3	Ci3330M	UMA	N
AS4820T-334G32Mn	Middle East	LX.PS N02.04 6	AS4820T_UMACks_3	Ci3330M	UMA	N
AS4820T-334G32Mn	South Africa	LX.PS N02.04 5	AS4820T_UMACks_3	Ci3330M	UMA	N
AS4820T-334G32Mn	Middle East	LX.PS N02.04 4	AS4820T_UMACks_3	Ci3330M	UMA	N

Model	Country	Acer Part No	BOM Name	CPU	VGA Chip	VRAM 1
AS4820T-334G32Mn	Algeria	LX.PS N02.04 3	AS4820T_UMACks_ 3	Ci3330M	UMA	N
AS4820T-334G32Mn	Middle East	LX.PS N02.04 2	AS4820T_UMACks_ 3	Ci3330M	UMA	N
AS4820T-334G32Mn	Middle East	LX.PS N02.04 1	AS4820T_UMACks_ 3	Ci3330M	UMA	N
AS4820T-334G32Mn	South Africa	LX.PS N02.04 0	AS4820T_UMACks_ 3	Ci3330M	UMA	N
AS4820T-334G32Mn	Middle East	LX.PS N02.03 9	AS4820T_UMACks_ 3	Ci3330M	UMA	N
AS4820T-334G32Mn	Middle East	LX.PS N02.03 8	AS4820T_UMACks_ 3	Ci3330M	UMA	N
AS4820T-334G32Mn	Poland	LX.PS N02.03 7	AS4820T_UMACks_ 3	Ci3330M	UMA	N
AS4820T-334G32Mn	Germany	LX.PS N02.03 6	AS4820T_UMACks_ 3	Ci3330M	UMA	N
AS4820T-334G32Mn	Luxembourg	LX.PS N02.03 5	AS4820T_UMACks_ 3	Ci3330M	UMA	N
AS4820T-334G32Mn	Eastern Europe	LX.PS N02.03 4	AS4820T_UMACks_ 3	Ci3330M	UMA	N
AS4820T-334G32Mn	Latvia	LX.PS N02.03 3	AS4820T_UMACks_ 3	Ci3330M	UMA	N
AS4820T-334G32Mn	Latvia	LX.PS N02.03 2	AS4820T_UMACks_ 3	Ci3330M	UMA	N
AS4820T-334G32Mn	Hungary	LX.PS N02.03 1	AS4820T_UMACks_ 3	Ci3330M	UMA	N
AS4820T-334G32Mn	Israel	LX.PS N02.03 0	AS4820T_UMACks_ 3	Ci3330M	UMA	N
AS4820T-334G32Mn	Czech	LX.PS N02.02 9	AS4820T_UMACks_ 3	Ci3330M	UMA	N
AS4820T-334G32Mn	Cyprus	LX.PS N02.02 8	AS4820T_UMACks_ 3	Ci3330M	UMA	N
AS4820T-334G32Mn	Portugal	LX.PS N02.02 7	AS4820T_UMACks_ 3	Ci3330M	UMA	N

Model	Country	Acer Part No	BOM Name	CPU	VGA Chip	VRAM 1
AS4820T-334G32Mn	Holland	LX.PS N02.02 6	AS4820T_UMACks_3	Ci3330M	UMA	N
AS4820T-334G32Mn	Belgium	LX.PS N02.02 5	AS4820T_UMACks_3	Ci3330M	UMA	N
AS4820T-334G32Mn	Switzerland	LX.PS N02.02 4	AS4820T_UMACks_3	Ci3330M	UMA	N
AS4820T-334G32Mn	Baltic	LX.PS N02.02 3	AS4820T_UMACks_3	Ci3330M	UMA	N
AS4820T-334G32Mn	UK	LX.PS N02.02 2	AS4820T_UMACks_3	Ci3330M	UMA	N
AS4820T-334G32Mn	Eastern Europe	LX.PS N02.02 1	AS4820T_UMACks_3	Ci3330M	UMA	N
AS4820T-334G32Mn	Baltic	LX.PS N02.02 0	AS4820T_UMACks_3	Ci3330M	UMA	N
AS4820T-334G32Mn	Denmark	LX.PS N02.01 9	AS4820T_UMACks_3	Ci3330M	UMA	N
AS4820T-334G32Mn	Eastern Europe	LX.PS N02.01 8	AS4820T_UMACks_3	Ci3330M	UMA	N
AS4820T-334G32Mn	Italy	LX.PS N02.01 7	AS4820T_UMACks_3	Ci3330M	UMA	N
AS4820T-334G32Mn	Spain	LX.PS N02.01 6	AS4820T_UMACks_3	Ci3330M	UMA	N
AS4820T-334G32Mn	Eastern Europe	LX.PS N02.01 5	AS4820T_UMACks_3	Ci3330M	UMA	N
AS4820T-334G32Mn	Serbia/ Macedonia	LX.PS N02.01 4	AS4820T_UMACks_3	Ci3330M	UMA	N
AS4820T-334G32Mn	Baltic	LX.PS N02.01 3	AS4820T_UMACks_3	Ci3330M	UMA	N
AS4820T-334G32Mn	Austria	LX.PS N02.01 2	AS4820T_UMACks_3	Ci3330M	UMA	N
AS4820T-334G32Mn	Greece	LX.PS N02.01 1	AS4820T_UMACks_3	Ci3330M	UMA	N
AS4820T-334G32Mn	Eastern Europe	LX.PS N02.01 0	AS4820T_UMACks_3	Ci3330M	UMA	N

Model	Country	Acer Part No	BOM Name	CPU	VGA Chip	VRAM 1
AS4820T-334G32Mn	France	LX.PS N02.00 9	AS4820T_UMACks_3	Ci3330M	UMA	N
AS4820T-434G32Mn	UK	LX.PS N02.00 8	AS4820T_UMACks_3	Ci5430M	UMA	N
AS4820T-333G25Mn	UK	LX.PS N02.00 7	AS4820T_UMACks_3	Ci3330M	UMA	N
AS4820T-334G25Mn	WW	S2.PS N02.00 4	AS4820T_UMACks_3	Ci3330M	UMA	N
AS4820T-334G25Mn	WW	S2.PS N02.00 3	AS4820T_UMACks_3	Ci3330M	UMA	N
AS4820T-332G32Mn	Singapore	LX.PS N02.00 3	AS4820T_UMACks_3	Ci3330M	UMA	N
AS4820T-434G32Mn	Singapore	LX.PS N02.00 2	AS4820T_UMACks_3	Ci5430M	UMA	N
AS4820T-334G32Mn	Singapore	LX.PS N02.00 1	AS4820T_UMACks_3	Ci3330M	UMA	N
AS4820T-524G25Mn	WW	S2.PS N02.00 2	AS4820T_UMACks_3	Ci5520M	UMA	N
AS4820T-522G16Mn	WW	S2.PS N02.00 1	AS4820T_UMACks_3	Ci5520M	UMA	N
AS4820T-334G25Mn	WW	S2.PVK 02.001	AS4820T_UMAGCks_3	Ci3330M	UMA	N

Model	Country	Acer Part No	Memory 1	Memory 2	HDD 1(GB)
AS4820TG-432G32Mn	China	LX.PSE02.098	SO2GBIII10	N	N320GB5.4KS
AS4820TG-332G32Mn	China	LX.PSE02.127	SO2GBIII10	N	N320GB5.4KS
AS4820TG-434G50Mn	Switzerland	LX.PSE02.118	SO2GBIII10	SO2GBIII10	N500GB5.4KS
AS4820TG-524G64Mn	GCTWN	LX.PSE02.111	SO2GBIII10	SO2GBIII10	N640GB5.4KS
AS4820TG-434G50Mn	Germany	LX.PSE02.177	SO2GBIII10	SO2GBIII10	N500GB5.4KS
AS4820TG-434G50Mn	South Africa	LX.PSE02.169	SO2GBIII10	SO2GBIII10	N500GB5.4KS
AS4820TG-434G50Mn	Middle East	LX.PSE02.167	SO2GBIII10	SO2GBIII10	N500GB5.4KS
AS4820TG-434G50Mn	Middle East	LX.PSE02.168	SO2GBIII10	SO2GBIII10	N500GB5.4KS

Model	Country	Acer Part No	Memory 1	Memory 2	HDD 1(GB)
AS4820TG-434G50Mn	Middle East	LX.PSE02.166	SO2GBIII10	SO2GBIII10	N500GB5.4KS
AS4820TG-434G50Mn	Middle East	LX.PSE02.165	SO2GBIII10	SO2GBIII10	N500GB5.4KS
AS4820TG-434G50Mn	South Africa	LX.PSE02.164	SO2GBIII10	SO2GBIII10	N500GB5.4KS
AS4820TG-434G50Mn	Poland	LX.PSE02.163	SO2GBIII10	SO2GBIII10	N500GB5.4KS
AS4820TG-434G50Mn	Baltic	LX.PSE02.162	SO2GBIII10	SO2GBIII10	N500GB5.4KS
AS4820TG-434G50Mn	Holland	LX.PSE02.161	SO2GBIII10	SO2GBIII10	N500GB5.4KS
AS4820TG-434G50Mn	Luxembourg	LX.PSE02.159	SO2GBIII10	SO2GBIII10	N500GB5.4KS
AS4820TG-434G50Mn	Belgium	LX.PSE02.160	SO2GBIII10	SO2GBIII10	N500GB5.4KS
AS4820TG-434G50Mn	Latvia	LX.PSE02.158	SO2GBIII10	SO2GBIII10	N500GB5.4KS
AS4820TG-434G50Mn	Latvia	LX.PSE02.157	SO2GBIII10	SO2GBIII10	N500GB5.4KS
AS4820TG-434G50Mn	UK	LX.PSE02.156	SO2GBIII10	SO2GBIII10	N500GB5.4KS
AS4820TG-434G50Mn	Eastern Europe	LX.PSE02.155	SO2GBIII10	SO2GBIII10	N500GB5.4KS
AS4820TG-434G50Mn	Czech	LX.PSE02.153	SO2GBIII10	SO2GBIII10	N500GB5.4KS
AS4820TG-434G50Mn	Eastern Europe	LX.PSE02.154	SO2GBIII10	SO2GBIII10	N500GB5.4KS
AS4820TG-434G50Mn	Hungary	LX.PSE02.152	SO2GBIII10	SO2GBIII10	N500GB5.4KS
AS4820TG-434G50Mn	Israel	LX.PSE02.151	SO2GBIII10	SO2GBIII10	N500GB5.4KS
AS4820TG-434G50Mn	Baltic	LX.PSE02.150	SO2GBIII10	SO2GBIII10	N500GB5.4KS
AS4820TG-434G50Mn	Portugal	LX.PSE02.149	SO2GBIII10	SO2GBIII10	N500GB5.4KS
AS4820TG-434G50Mn	Cyprus	LX.PSE02.148	SO2GBIII10	SO2GBIII10	N500GB5.4KS
AS4820TG-434G50Mn	Baltic	LX.PSE02.147	SO2GBIII10	SO2GBIII10	N500GB5.4KS
AS4820TG-434G50Mn	Serbia/ Macedonia	LX.PSE02.146	SO2GBIII10	SO2GBIII10	N500GB5.4KS
AS4820TG-434G50Mn	Italy	LX.PSE02.145	SO2GBIII10	SO2GBIII10	N500GB5.4KS
AS4820TG-434G50Mn	Spain	LX.PSE02.144	SO2GBIII10	SO2GBIII10	N500GB5.4KS
AS4820TG-434G50Mn	Denmark	LX.PSE02.143	SO2GBIII10	SO2GBIII10	N500GB5.4KS
AS4820TG-434G50Mn	Eastern Europe	LX.PSE02.142	SO2GBIII10	SO2GBIII10	N500GB5.4KS

Model	Country	Acer Part No	Memory 1	Memory 2	HDD 1(GB)
AS4820TG-434G50Mn	Eastern Europe	LX.PSE02.141	SO2GBIII10	SO2GBIII10	N500GB5.4KS
AS4820TG-434G50Mn	Austria	LX.PSE02.139	SO2GBIII10	SO2GBIII10	N500GB5.4KS
AS4820TG-434G50Mn	Greece	LX.PSE02.140	SO2GBIII10	SO2GBIII10	N500GB5.4KS
AS4820TG-434G50Mn	France	LX.PSE02.138	SO2GBIII10	SO2GBIII10	N500GB5.4KS
AS4820TG-434G50Mn	Eastern Europe	LX.PSE02.137	SO2GBIII10	SO2GBIII10	N500GB5.4KS
AS4820TG-434G50Mn	Ukraine	LX.PSE02.136	SO2GBIII10	SO2GBIII10	N500GB5.4KS
AS4820TG-434G50Mn	Middle East	LX.PSE02.135	SO2GBIII10	SO2GBIII10	N500GB5.4KS
AS4820TG-434G50Mn	Middle East	LX.PSE02.134	SO2GBIII10	SO2GBIII10	N500GB5.4KS
AS4820TG-434G50Mn	South Africa	LX.PSE02.133	SO2GBIII10	SO2GBIII10	N500GB5.4KS
AS4820TG-434G50Mn	Middle East	LX.PSE02.132	SO2GBIII10	SO2GBIII10	N500GB5.4KS
AS4820TG-434G50Mn	Middle East	LX.PSE02.131	SO2GBIII10	SO2GBIII10	N500GB5.4KS
AS4820TG-434G50Mn	South Africa	LX.PSE02.130	SO2GBIII10	SO2GBIII10	N500GB5.4KS
AS4820TG-434G50Mn	Middle East	LX.PSE02.129	SO2GBIII10	SO2GBIII10	N500GB5.4KS
AS4820TG-434G50Mn	Algeria	LX.PSE02.128	SO2GBIII10	SO2GBIII10	N500GB5.4KS
AS4820TG-434G50Mn	Middle East	LX.PSE02.126	SO2GBIII10	SO2GBIII10	N500GB5.4KS
AS4820TG-432G50Mn	Thailand	LX.PSE02.122	SO2GBIII10	N	N500GB5.4KS
AS4820TG-434G32Mn	Middle East	LX.PSE02.125	SO2GBIII10	SO2GBIII10	N320GB5.4KS
AS4820TG-434G50Mn	France	LX.PSE02.117	SO2GBIII10	SO2GBIII10	N500GB5.4KS
AS4820TG-624G64Mn	GCTWN	LX.PSE02.124	SO2GBIII10	SO2GBIII10	N640GB5.4KS
AS4820TG-432G50Mn	Thailand	LX.PSE02.123	SO2GBIII10	N	N500GB5.4KS
AS4820TG-434G64Mn	Denmark	LX.PSE02.022	SO2GBIII10	SO2GBIII10	N640GB5.4KS
AS4820TG-436G64Mn	Germany	LX.PSE02.082	SO4GBIII10	SO2GBIII10	N640GB5.4KS
AS4820TG-434G32Mn	WW	S2.PSE02.005	SO2GBIII10	SO2GBIII10	N320GB5.4KS
AS4820TG-434G50Mi	Russia	LX.PSE02.121	SO2GBIII10	SO2GBIII10	N500GB5.4KS
AS4820TG-434G50Mn	Turkey	LX.PSE02.120	SO2GBIII10	SO2GBIII10	N500GB5.4KS

Model	Country	Acer Part No	Memory 1	Memory 2	HDD 1(GB)
AS4820TG-353G32Mn	Turkey	LX.PSE02.119	SO2GBIII10	SO1GBIII10	N320GB5.4KS
AS4820TG-334G50Mn	France	LX.PSE02.116	SO2GBIII10	SO2GBIII10	N500GB5.4KS
AS4820TG-624G50Mn	France	LX.PSE02.115	SO2GBIII10	SO2GBIII10	N500GB5.4KS
AS4820TG-624G64Mn	Singapore	LX.PSE02.104	SO2GBIII10	SO2GBIII10	N640GB5.4KS
AS4820TG-524G50Mn	Malaysia	LX.PSE02.114	SO2GBIII10	SO2GBIII10	N500GB5.4KS
AS4820TG-432G50Mn	GCTWN	LX.PSE02.113	SO2GBIII10	N	N500GB5.4KS
AS4820TG-524G64Mn	GCTWN	LX.PSE02.112	SO2GBIII10	SO2GBIII10	N640GB5.4KS
AS4820TG-432G64Mn	GCTWN	LX.PSE02.110	SO2GBIII10	N	N640GB5.4KS
AS4820TG-524G50Mn	Indonesia	LX.PSE02.109	SO2GBIII10	SO2GBIII10	N500GB5.4KS
AS4820TG-524G50Mn	Indonesia	LX.PSE02.108	SO2GBIII10	SO2GBIII10	N500GB5.4KS
AS4820TG-432G64Mn	GCTWN	LX.PSE02.107	SO2GBIII10	N	N640GB5.4KS
AS4820TG-332G64Mn	GCTWN	LX.PSE02.106	SO2GBIII10	N	N640GB5.4KS
AS4820TG-524G50Mn	Singapore	LX.PSE02.105	SO2GBIII10	SO2GBIII10	N500GB5.4KS
AS4820TG-544G64Mn	Singapore	LX.PSE02.103	SO2GBIII10	SO2GBIII10	N640GB5.4KS
AS4820TG-524G64Mn	Singapore	LX.PSE02.102	SO2GBIII10	SO2GBIII10	N640GB5.4KS
AS4820TG-438G32Mn	WW	S2.PSE02.003	SO4GBIII10	SO4GBIII10	N320GB5.4KS
AS4820TG-524G64Mn	Thailand	LX.PSE02.101	SO4GBIII10	N	N640GB5.4KS
AS4820TG-434G50Mn	Thailand	LX.PSE02.099	SO4GBIII10	N	N500GB5.4KS
AS4820TG-436G64Mn	South Africa	LX.PSE02.097	SO4GBIII10	SO2GBIII10	N640GB5.4KS
AS4820TG-436G64Mn	Middle East	LX.PSE02.096	SO4GBIII10	SO2GBIII10	N640GB5.4KS
AS4820TG-436G64Mn	Middle East	LX.PSE02.095	SO4GBIII10	SO2GBIII10	N640GB5.4KS
AS4820TG-436G64Mn	Turkey	LX.PSE02.094	SO4GBIII10	SO2GBIII10	N640GB5.4KS
AS4820TG-436G64Mn	Middle East	LX.PSE02.093	SO4GBIII10	SO2GBIII10	N640GB5.4KS
AS4820TG-436G64Mn	Middle East	LX.PSE02.092	SO4GBIII10	SO2GBIII10	N640GB5.4KS
AS4820TG-436G64Mn	South Africa	LX.PSE02.091	SO4GBIII10	SO2GBIII10	N640GB5.4KS

Model	Country	Acer Part No	Memory 1	Memory 2	HDD 1(GB)
AS4820TG-436G64Mn	Middle East	LX.PSE02.090	SO4GBIII10	SO2GBIII10	N640GB5.4KS
AS4820TG-436G64Mn	Algeria	LX.PSE02.089	SO4GBIII10	SO2GBIII10	N640GB5.4KS
AS4820TG-436G64Mn	Middle East	LX.PSE02.088	SO4GBIII10	SO2GBIII10	N640GB5.4KS
AS4820TG-436G64Mn	Middle East	LX.PSE02.087	SO4GBIII10	SO2GBIII10	N640GB5.4KS
AS4820TG-436G64Mn	South Africa	LX.PSE02.086	SO4GBIII10	SO2GBIII10	N640GB5.4KS
AS4820TG-436G64Mn	Middle East	LX.PSE02.085	SO4GBIII10	SO2GBIII10	N640GB5.4KS
AS4820TG-436G64Mn	Middle East	LX.PSE02.084	SO4GBIII10	SO2GBIII10	N640GB5.4KS
AS4820TG-436G64Mn	Poland	LX.PSE02.083	SO4GBIII10	SO2GBIII10	N640GB5.4KS
AS4820TG-436G64Mn	Holland	LX.PSE02.080	SO4GBIII10	SO2GBIII10	N640GB5.4KS
AS4820TG-436G64Mn	Luxembourg	LX.PSE02.081	SO4GBIII10	SO2GBIII10	N640GB5.4KS
AS4820TG-436G64Mn	Belgium	LX.PSE02.079	SO4GBIII10	SO2GBIII10	N640GB5.4KS
AS4820TG-436G64Mn	Switzerland	LX.PSE02.078	SO4GBIII10	SO2GBIII10	N640GB5.4KS
AS4820TG-436G64Mn	Baltic	LX.PSE02.077	SO4GBIII10	SO2GBIII10	N640GB5.4KS
AS4820TG-436G64Mn	UK	LX.PSE02.076	SO4GBIII10	SO2GBIII10	N640GB5.4KS
AS4820TG-436G64Mn	Eastern Europe	LX.PSE02.074	SO4GBIII10	SO2GBIII10	N640GB5.4KS
AS4820TG-436G64Mn	Eastern Europe	LX.PSE02.075	SO4GBIII10	SO2GBIII10	N640GB5.4KS
AS4820TG-436G64Mn	Latvia	LX.PSE02.073	SO4GBIII10	SO2GBIII10	N640GB5.4KS
AS4820TG-436G64Mn	Latvia	LX.PSE02.072	SO4GBIII10	SO2GBIII10	N640GB5.4KS
AS4820TG-436G64Mn	Hungary	LX.PSE02.071	SO4GBIII10	SO2GBIII10	N640GB5.4KS
AS4820TG-436G64Mn	Israel	LX.PSE02.070	SO4GBIII10	SO2GBIII10	N640GB5.4KS
AS4820TG-436G64Mn	Czech	LX.PSE02.069	SO4GBIII10	SO2GBIII10	N640GB5.4KS
AS4820TG-436G64Mn	Cyprus	LX.PSE02.068	SO4GBIII10	SO2GBIII10	N640GB5.4KS
AS4820TG-436G64Mn	Portugal	LX.PSE02.067	SO4GBIII10	SO2GBIII10	N640GB5.4KS
AS4820TG-436G64Mn	Baltic	LX.PSE02.066	SO4GBIII10	SO2GBIII10	N640GB5.4KS
AS4820TG-436G64Mn	Denmark	LX.PSE02.065	SO4GBIII10	SO2GBIII10	N640GB5.4KS

Model	Country	Acer Part No	Memory 1	Memory 2	HDD 1(GB)
AS4820TG-436G64Mn	Eastern Europe	LX.PSE02.064	SO4GBIII10	SO2GBIII10	N640GB5.4KS
AS4820TG-436G64Mn	Italy	LX.PSE02.063	SO4GBIII10	SO2GBIII10	N640GB5.4KS
AS4820TG-436G64Mn	Spain	LX.PSE02.062	SO4GBIII10	SO2GBIII10	N640GB5.4KS
AS4820TG-436G64Mn	Eastern Europe	LX.PSE02.061	SO4GBIII10	SO2GBIII10	N640GB5.4KS
AS4820TG-436G64Mn	Serbia/ Macedonia	LX.PSE02.060	SO4GBIII10	SO2GBIII10	N640GB5.4KS
AS4820TG-436G64Mn	Baltic	LX.PSE02.059	SO4GBIII10	SO2GBIII10	N640GB5.4KS
AS4820TG-436G64Mn	Austria	LX.PSE02.058	SO4GBIII10	SO2GBIII10	N640GB5.4KS
AS4820TG-436G64Mn	Greece	LX.PSE02.057	SO4GBIII10	SO2GBIII10	N640GB5.4KS
AS4820TG-436G64Mn	Eastern Europe	LX.PSE02.056	SO4GBIII10	SO2GBIII10	N640GB5.4KS
AS4820TG-436G64Mn	France	LX.PSE02.055	SO4GBIII10	SO2GBIII10	N640GB5.4KS
AS4820TG-434G64Mn	South Africa	LX.PSE02.054	SO2GBIII10	SO2GBIII10	N640GB5.4KS
AS4820TG-434G64Mn	Middle East	LX.PSE02.053	SO2GBIII10	SO2GBIII10	N640GB5.4KS
AS4820TG-434G64Mn	Middle East	LX.PSE02.052	SO2GBIII10	SO2GBIII10	N640GB5.4KS
AS4820TG-434G64Mn	Turkey	LX.PSE02.051	SO2GBIII10	SO2GBIII10	N640GB5.4KS
AS4820TG-434G64Mn	Middle East	LX.PSE02.050	SO2GBIII10	SO2GBIII10	N640GB5.4KS
AS4820TG-434G64Mn	Middle East	LX.PSE02.049	SO2GBIII10	SO2GBIII10	N640GB5.4KS
AS4820TG-434G64Mn	South Africa	LX.PSE02.048	SO2GBIII10	SO2GBIII10	N640GB5.4KS
AS4820TG-434G64Mn	Middle East	LX.PSE02.047	SO2GBIII10	SO2GBIII10	N640GB5.4KS
AS4820TG-434G64Mn	Algeria	LX.PSE02.046	SO2GBIII10	SO2GBIII10	N640GB5.4KS
AS4820TG-434G64Mn	Middle East	LX.PSE02.045	SO2GBIII10	SO2GBIII10	N640GB5.4KS
AS4820TG-434G64Mn	Middle East	LX.PSE02.044	SO2GBIII10	SO2GBIII10	N640GB5.4KS
AS4820TG-434G64Mn	South Africa	LX.PSE02.043	SO2GBIII10	SO2GBIII10	N640GB5.4KS
AS4820TG-434G64Mn	Middle East	LX.PSE02.042	SO2GBIII10	SO2GBIII10	N640GB5.4KS
AS4820TG-434G64Mn	Middle East	LX.PSE02.041	SO2GBIII10	SO2GBIII10	N640GB5.4KS
AS4820TG-434G64Mn	Poland	LX.PSE02.040	SO2GBIII10	SO2GBIII10	N640GB5.4KS

Model	Country	Acer Part No	Memory 1	Memory 2	HDD 1(GB)
AS4820TG-434G64Mn	Germany	LX.PSE02.039	SO2GBIII10	SO2GBIII10	N640GB5.4KS
AS4820TG-434G64Mn	Eastern Europe	LX.PSE02.038	SO2GBIII10	SO2GBIII10	N640GB5.4KS
AS4820TG-434G64Mn	Latvia	LX.PSE02.037	SO2GBIII10	SO2GBIII10	N640GB5.4KS
AS4820TG-434G64Mn	Latvia	LX.PSE02.036	SO2GBIII10	SO2GBIII10	N640GB5.4KS
AS4820TG-434G64Mn	Hungary	LX.PSE02.035	SO2GBIII10	SO2GBIII10	N640GB5.4KS
AS4820TG-434G64Mn	Israel	LX.PSE02.034	SO2GBIII10	SO2GBIII10	N640GB5.4KS
AS4820TG-434G64Mn	Czech	LX.PSE02.033	SO2GBIII10	SO2GBIII10	N640GB5.4KS
AS4820TG-434G64Mn	Cyprus	LX.PSE02.032	SO2GBIII10	SO2GBIII10	N640GB5.4KS
AS4820TG-434G64Mn	Portugal	LX.PSE02.031	SO2GBIII10	SO2GBIII10	N640GB5.4KS
AS4820TG-434G64Mn	Luxembourg	LX.PSE02.030	SO2GBIII10	SO2GBIII10	N640GB5.4KS
AS4820TG-434G64Mn	Holland	LX.PSE02.029	SO2GBIII10	SO2GBIII10	N640GB5.4KS
AS4820TG-434G64Mn	Belgium	LX.PSE02.028	SO2GBIII10	SO2GBIII10	N640GB5.4KS
AS4820TG-434G64Mn	Switzerland	LX.PSE02.027	SO2GBIII10	SO2GBIII10	N640GB5.4KS
AS4820TG-434G64Mn	Baltic	LX.PSE02.026	SO2GBIII10	SO2GBIII10	N640GB5.4KS
AS4820TG-434G64Mn	UK	LX.PSE02.025	SO2GBIII10	SO2GBIII10	N640GB5.4KS
AS4820TG-434G64Mn	Eastern Europe	LX.PSE02.024	SO2GBIII10	SO2GBIII10	N640GB5.4KS
AS4820TG-434G64Mn	Baltic	LX.PSE02.023	SO2GBIII10	SO2GBIII10	N640GB5.4KS
AS4820TG-434G64Mn	Eastern Europe	LX.PSE02.021	SO2GBIII10	SO2GBIII10	N640GB5.4KS
AS4820TG-434G64Mn	Spain	LX.PSE02.019	SO2GBIII10	SO2GBIII10	N640GB5.4KS
AS4820TG-434G64Mn	Italy	LX.PSE02.020	SO2GBIII10	SO2GBIII10	N640GB5.4KS
AS4820TG-434G64Mn	Eastern Europe	LX.PSE02.018	SO2GBIII10	SO2GBIII10	N640GB5.4KS
AS4820TG-434G64Mn	Serbia/Macedonia	LX.PSE02.017	SO2GBIII10	SO2GBIII10	N640GB5.4KS
AS4820TG-434G64Mn	Baltic	LX.PSE02.016	SO2GBIII10	SO2GBIII10	N640GB5.4KS
AS4820TG-434G64Mn	Austria	LX.PSE02.015	SO2GBIII10	SO2GBIII10	N640GB5.4KS
AS4820TG-434G64Mn	Greece	LX.PSE02.014	SO2GBIII10	SO2GBIII10	N640GB5.4KS

Model	Country	Acer Part No	Memory 1	Memory 2	HDD 1(GB)
AS4820TG-434G64Mn	Eastern Europe	LX.PSE02.013	SO2GBIII10	SO2GBIII10	N640GB5.4KS
AS4820TG-434G64Mn	France	LX.PSE02.012	SO2GBIII10	SO2GBIII10	N640GB5.4KS
AS4820TG-522G64Mn	Hong Kong	LX.PSE02.011	SO2GBIII10	N	N640GB5.4KS
AS4820TG-432G50Mn	Hong Kong	LX.PSE02.010	SO2GBIII10	N	N500GB5.4KS
AS4820TG-524G50Mn	UK	LX.PSE02.009	SO2GBIII10	SO2GBIII10	N500GB5.4KS
AS4820TG-438G32Mn	WW	S2.PSE02.004	SO4GBIII10	SO4GBIII10	N320GB5.4KS
AS4820TG-624G64Mn	Singapore	LX.PSE02.004	SO2GBIII10	SO2GBIII10	N640GB5.4KS
AS4820TG-626G64Mn	Singapore	LX.PSE02.003	SO4GBIII10	SO2GBIII10	N640GB5.4KS
AS4820TG-524G64Mn	Singapore	LX.PSE02.002	SO2GBIII10	SO2GBIII10	N640GB5.4KS
AS4820TG-526G64Mn	Singapore	LX.PSE02.001	SO4GBIII10	SO2GBIII10	N640GB5.4KS
AS4820TG-528G64Mn	WW	S2.PSE02.002	SO4GBIII10	SO4GBIII10	N640GB5.4KS
AS4820T-522G16Mn	WW	S2.PSE02.001	SO2GBIII10	N	N160GB5.4KS
AS4820TG-524G64Mn	Thailand	LX.PVL02.007	SO2GBIII10	SO2GBIII10	N640GB5.4KS
AS4820TG-624G64Mn	Thailand	LX.PVL02.008	SO2GBIII10	SO2GBIII10	N640GB5.4KS
AS4820TG-624G64Mn	Thailand	LX.PVL02.004	SO4GBIII10	N	N640GB5.4KS
AS4820TG-624G64Mn	Thailand	LX.PVL02.003	SO4GBIII10	N	N640GB5.4KS
AS4820TG-524G50Mn	Thailand	LX.PVL02.002	SO4GBIII10	N	N500GB5.4KS
AS4820TG-524G50Mn	Thailand	LX.PVL02.001	SO4GBIII10	N	N500GB5.4KS
AS4820TG-334G16Mn	WW	S2.PVL02.001	SO2GBIII10	SO2GBIII10	N160GB5.4KS
AS4820TG-433G64Mn	Indonesia	LX.PSG02.128	SO2GBIII10	SO1GBIII10	N640GB5.4KS
AS4820TG-334G50Mn	Middle East	LX.PSG0C.004	SO2GBIII10	SO2GBIII10	N500GB5.4KS
AS4820TG-332G32Mn	China	LX.PSG02.073	SO2GBIII10	N	N320GB5.4KS
AS4820TG-334G50Mn	Germany	LX.PSG02.127	SO2GBIII10	SO2GBIII10	N500GB5.4KS
AS4820TG-433G32Mn	Middle East	LX.PSG02.119	SO2GBIII10	SO1GBIII10	N320GB5.4KS
AS4820TG-433G32Mn	Middle East	LX.PSG02.118	SO2GBIII10	SO1GBIII10	N320GB5.4KS

Model	Country	Acer Part No	Memory 1	Memory 2	HDD 1(GB)
AS4820TG-433G32Mn	South Africa	LX.PSG02.117	SO2GBIII10	SO1GBIII10	N320GB5.4KS
AS4820TG-433G32Mn	Turkey	LX.PSG02.116	SO2GBIII10	SO1GBIII10	N320GB5.4KS
AS4820TG-433G32Mn	Middle East	LX.PSG02.115	SO2GBIII10	SO1GBIII10	N320GB5.4KS
AS4820TG-433G32Mn	South Africa	LX.PSG02.114	SO2GBIII10	SO1GBIII10	N320GB5.4KS
AS4820TG-433G32Mn	Middle East	LX.PSG02.113	SO2GBIII10	SO1GBIII10	N320GB5.4KS
AS4820TG-433G32Mn	Algeria	LX.PSG02.112	SO2GBIII10	SO1GBIII10	N320GB5.4KS
AS4820TG-433G32Mn	South Africa	LX.PSG02.111	SO2GBIII10	SO1GBIII10	N320GB5.4KS
AS4820TG-433G32Mn	Middle East	LX.PSG02.110	SO2GBIII10	SO1GBIII10	N320GB5.4KS
AS4820TG-433G32Mn	Middle East	LX.PSG02.109	SO2GBIII10	SO1GBIII10	N320GB5.4KS
AS4820TG-433G32Mn	Middle East	LX.PSG02.108	SO2GBIII10	SO1GBIII10	N320GB5.4KS
AS4820TG-433G32Mn	Middle East	LX.PSG02.107	SO2GBIII10	SO1GBIII10	N320GB5.4KS
AS4820TG-433G32Mn	South Africa	LX.PSG02.106	SO2GBIII10	SO1GBIII10	N320GB5.4KS
AS4820TG-433G32Mn	Ukraine	LX.PSG02.105	SO2GBIII10	SO1GBIII10	N320GB5.4KS
AS4820TG-433G32Mi	Russia	LX.PSG02.104	SO2GBIII10	SO1GBIII10	N320GB5.4KS
AS4820TG-433G32Mn	Germany	LX.PSG02.103	SO2GBIII10	SO1GBIII10	N320GB5.4KS
AS4820TG-433G32Mn	Poland	LX.PSG02.102	SO2GBIII10	SO1GBIII10	N320GB5.4KS
AS4820TG-433G32Mn	Baltic	LX.PSG02.101	SO2GBIII10	SO1GBIII10	N320GB5.4KS
AS4820TG-433G32Mn	Holland	LX.PSG02.099	SO2GBIII10	SO1GBIII10	N320GB5.4KS
AS4820TG-433G32Mn	Belgium	LX.PSG02.098	SO2GBIII10	SO1GBIII10	N320GB5.4KS
AS4820TG-433G32Mn	Switzerland	LX.PSG02.097	SO2GBIII10	SO1GBIII10	N320GB5.4KS
AS4820TG-433G32Mn	Luxembourg	LX.PSG02.096	SO2GBIII10	SO1GBIII10	N320GB5.4KS
AS4820TG-433G32Mn	Latvia	LX.PSG02.095	SO2GBIII10	SO1GBIII10	N320GB5.4KS
AS4820TG-433G32Mn	Latvia	LX.PSG02.094	SO2GBIII10	SO1GBIII10	N320GB5.4KS
AS4820TG-433G32Mn	UK	LX.PSG02.093	SO2GBIII10	SO1GBIII10	N320GB5.4KS
AS4820TG-433G32Mn	Eastern Europe	LX.PSG02.092	SO2GBIII10	SO1GBIII10	N320GB5.4KS

Model	Country	Acer Part No	Memory 1	Memory 2	HDD 1(GB)
AS4820TG-433G32Mn	Eastern Europe	LX.PSG02.091	SO2GBIII10	SO1GBIII10	N320GB5.4KS
AS4820TG-433G32Mn	Czech	LX.PSG02.090	SO2GBIII10	SO1GBIII10	N320GB5.4KS
AS4820TG-433G32Mn	Hungary	LX.PSG02.089	SO2GBIII10	SO1GBIII10	N320GB5.4KS
AS4820TG-433G32Mn	Israel	LX.PSG02.088	SO2GBIII10	SO1GBIII10	N320GB5.4KS
AS4820TG-433G32Mn	Baltic	LX.PSG02.087	SO2GBIII10	SO1GBIII10	N320GB5.4KS
AS4820TG-433G32Mn	Portugal	LX.PSG02.086	SO2GBIII10	SO1GBIII10	N320GB5.4KS
AS4820TG-433G32Mn	Cyprus	LX.PSG02.085	SO2GBIII10	SO1GBIII10	N320GB5.4KS
AS4820TG-433G32Mn	Baltic	LX.PSG02.084	SO2GBIII10	SO1GBIII10	N320GB5.4KS
AS4820TG-433G32Mn	Serbia/ Macedonia	LX.PSG02.083	SO2GBIII10	SO1GBIII10	N320GB5.4KS
AS4820TG-433G32Mn	Italy	LX.PSG02.082	SO2GBIII10	SO1GBIII10	N320GB5.4KS
AS4820TG-433G32Mn	Spain	LX.PSG02.081	SO2GBIII10	SO1GBIII10	N320GB5.4KS
AS4820TG-433G32Mn	Denmark	LX.PSG02.080	SO2GBIII10	SO1GBIII10	N320GB5.4KS
AS4820TG-433G32Mn	Eastern Europe	LX.PSG02.079	SO2GBIII10	SO1GBIII10	N320GB5.4KS
AS4820TG-433G32Mn	Eastern Europe	LX.PSG02.078	SO2GBIII10	SO1GBIII10	N320GB5.4KS
AS4820TG-433G32Mn	Greece	LX.PSG02.077	SO2GBIII10	SO1GBIII10	N320GB5.4KS
AS4820TG-433G32Mn	Austria	LX.PSG02.076	SO2GBIII10	SO1GBIII10	N320GB5.4KS
AS4820TG-433G32Mn	Eastern Europe	LX.PSG02.074	SO2GBIII10	SO1GBIII10	N320GB5.4KS
AS4820TG-433G32Mn	France	LX.PSG02.075	SO2GBIII10	SO1GBIII10	N320GB5.4KS
AS4820TG-333G32Mn	Middle East	LX.PSG02.072	SO2GBIII10	SO1GBIII10	N320GB5.4KS
AS4820TG-433G32Mn	Middle East	LX.PSG02.071	SO2GBIII10	SO1GBIII10	N320GB5.4KS
AS4820TG-434G50Mn	Italy	LX.PSG02.057	SO2GBIII10	SO2GBIII10	N500GB5.4KS
AS4820TG-434G50Mn	Eastern Europe	LX.PSG02.028	SO2GBIII10	SO2GBIII10	N500GB5.4KS
AS4820TG-334G32Mn	France	LX.PSG02.058	SO2GBIII10	SO2GBIII10	N320GB5.4KS
AS4820TG-332G32Mn	Turkey	LX.PSG02.070	SO2GBIII10	N	N320GB5.4KS
AS4820TG-522G32Mn	Turkey	LX.PSG02.069	SO2GBIII10	N	N320GB5.4KS

Model	Country	Acer Part No	Memory 1	Memory 2	HDD 1(GB)
AS4820TG-432G50Mn	Thailand	LX.PSG02.068	SO2GBIII10	N	N500GB5.4KS
AS4820TG-432G50Mn	Thailand	LX.PSG02.067	SO2GBIII10	N	N500GB5.4KS
AS4820TG-432G50Mn	GCTWN	LX.PSG02.055	SO2GBIII10	N	N500GB5.4KS
AS4820TG-432G50Mn	Malaysia	LX.PSG02.066	SO2GBIII10	N	N500GB5.4KS
AS4820TG-434G50Mn	Denmark	LX.PSG02.018	SO2GBIII10	SO2GBIII10	N500GB5.4KS
AS4820TG-432G32Mn	Vietnam	LX.PSG0C.003	SO2GBIII10	N	N320GB5.4KS
AS4820TG-332G32Mn	Vietnam	LX.PSG0C.002	SO2GBIII10	N	N320GB5.4KS
AS4820TG-434G64Mn	Middle East	LX.PSG02.065	SO2GBIII10	SO2GBIII10	N640GB5.4KS
AS4820TG-524G32Mn	Greece	LX.PSG02.064	SO2GBIII10	SO2GBIII10	N320GB5.4KS
AS4820TG-334G50Mn	Middle East	LX.PSG02.063	SO2GBIII10	SO2GBIII10	N500GB5.4KS
AS4820TG-333G25Mi	Russia	LX.PSG02.062	SO2GBIII10	SO1GBIII10	N250GB5.4KS
AS4820TG-352G25Mn	Turkey	LX.PSG02.060	SO2GBIII10	N	N250GB5.4KS
AS4820TG-353G32Mn	Turkey	LX.PSG02.061	SO2GBIII10	SO1GBIII10	N320GB5.4KS
AS4820TG-332G25Mn	Turkey	LX.PSG02.059	SO2GBIII10	N	N250GB5.4KS
AS4820TG-522G50Mn	Malaysia	LX.PSG02.056	SO2GBIII10	N	N500GB5.4KS
AS4820TG-524G64Mn	GCTWN	LX.PSG02.054	SO2GBIII10	SO2GBIII10	N640GB5.4KS
AS4820TG-432G64Mn	GCTWN	LX.PSG02.053	SO2GBIII10	N	N640GB5.4KS
AS4820TG-434G32Mn	Thailand	LX.PSG0C.001	SO2GBIII10	SO2GBIII10	N320GB5.4KS
AS4820TG-334G32Mn	Thailand	LX.PSG02.052	SO4GBIII10	N	N320GB5.4KS
AS4820TG-432G32Mn	China	LX.PSG02.051	SO2GBIII10	N	N320GB5.4KS
AS4820TG-434G50Mn	South Africa	LX.PSG02.050	SO2GBIII10	SO2GBIII10	N500GB5.4KS
AS4820TG-434G50Mn	Middle East	LX.PSG02.049	SO2GBIII10	SO2GBIII10	N500GB5.4KS
AS4820TG-434G50Mn	Middle East	LX.PSG02.048	SO2GBIII10	SO2GBIII10	N500GB5.4KS
AS4820TG-434G50Mn	Turkey	LX.PSG02.047	SO2GBIII10	SO2GBIII10	N500GB5.4KS
AS4820TG-434G50Mn	Middle East	LX.PSG02.046	SO2GBIII10	SO2GBIII10	N500GB5.4KS

Model	Country	Acer Part No	Memory 1	Memory 2	HDD 1(GB)
AS4820TG-434G50Mn	Middle East	LX.PSG02.045	SO2GBIII10	SO2GBIII10	N500GB5.4KS
AS4820TG-434G50Mn	South Africa	LX.PSG02.044	SO2GBIII10	SO2GBIII10	N500GB5.4KS
AS4820TG-434G50Mn	Middle East	LX.PSG02.043	SO2GBIII10	SO2GBIII10	N500GB5.4KS
AS4820TG-434G50Mn	Algeria	LX.PSG02.042	SO2GBIII10	SO2GBIII10	N500GB5.4KS
AS4820TG-434G50Mn	Middle East	LX.PSG02.041	SO2GBIII10	SO2GBIII10	N500GB5.4KS
AS4820TG-434G50Mn	South Africa	LX.PSG02.039	SO2GBIII10	SO2GBIII10	N500GB5.4KS
AS4820TG-434G50Mn	Middle East	LX.PSG02.040	SO2GBIII10	SO2GBIII10	N500GB5.4KS
AS4820TG-434G50Mn	Middle East	LX.PSG02.038	SO2GBIII10	SO2GBIII10	N500GB5.4KS
AS4820TG-434G50Mn	Middle East	LX.PSG02.037	SO2GBIII10	SO2GBIII10	N500GB5.4KS
AS4820TG-434G50Mn	Poland	LX.PSG02.036	SO2GBIII10	SO2GBIII10	N500GB5.4KS
AS4820TG-434G50Mn	Germany	LX.PSG02.035	SO2GBIII10	SO2GBIII10	N500GB5.4KS
AS4820TG-434G50Mn	Luxembourg	LX.PSG02.034	SO2GBIII10	SO2GBIII10	N500GB5.4KS
AS4820TG-434G50Mn	Holland	LX.PSG02.033	SO2GBIII10	SO2GBIII10	N500GB5.4KS
AS4820TG-434G50Mn	Belgium	LX.PSG02.032	SO2GBIII10	SO2GBIII10	N500GB5.4KS
AS4820TG-434G50Mn	Switzerland	LX.PSG02.031	SO2GBIII10	SO2GBIII10	N500GB5.4KS
AS4820TG-434G50Mn	Baltic	LX.PSG02.030	SO2GBIII10	SO2GBIII10	N500GB5.4KS
AS4820TG-434G50Mn	UK	LX.PSG02.029	SO2GBIII10	SO2GBIII10	N500GB5.4KS
AS4820TG-434G50Mn	Eastern Europe	LX.PSG02.027	SO2GBIII10	SO2GBIII10	N500GB5.4KS
AS4820TG-434G50Mn	Latvia	LX.PSG02.026	SO2GBIII10	SO2GBIII10	N500GB5.4KS
AS4820TG-434G50Mn	Latvia	LX.PSG02.025	SO2GBIII10	SO2GBIII10	N500GB5.4KS
AS4820TG-434G50Mn	Hungary	LX.PSG02.024	SO2GBIII10	SO2GBIII10	N500GB5.4KS
AS4820TG-434G50Mn	Israel	LX.PSG02.023	SO2GBIII10	SO2GBIII10	N500GB5.4KS
AS4820TG-434G50Mn	Czech	LX.PSG02.022	SO2GBIII10	SO2GBIII10	N500GB5.4KS
AS4820TG-434G50Mn	Cyprus	LX.PSG02.021	SO2GBIII10	SO2GBIII10	N500GB5.4KS
AS4820TG-434G50Mn	Portugal	LX.PSG02.020	SO2GBIII10	SO2GBIII10	N500GB5.4KS

Model	Country	Acer Part No	Memory 1	Memory 2	HDD 1(GB)
AS4820TG-434G50Mn	Baltic	LX.PSG02.019	SO2GBIII10	SO2GBIII10	N500GB5.4KS
AS4820TG-434G50Mn	Eastern Europe	LX.PSG02.017	SO2GBIII10	SO2GBIII10	N500GB5.4KS
AS4820TG-434G50Mn	Italy	LX.PSG02.016	SO2GBIII10	SO2GBIII10	N500GB5.4KS
AS4820TG-434G50Mn	Spain	LX.PSG02.015	SO2GBIII10	SO2GBIII10	N500GB5.4KS
AS4820TG-434G50Mn	Eastern Europe	LX.PSG02.014	SO2GBIII10	SO2GBIII10	N500GB5.4KS
AS4820TG-434G50Mn	Serbia/ Macedonia	LX.PSG02.013	SO2GBIII10	SO2GBIII10	N500GB5.4KS
AS4820TG-434G50Mn	Baltic	LX.PSG02.012	SO2GBIII10	SO2GBIII10	N500GB5.4KS
AS4820TG-434G50Mn	Austria	LX.PSG02.011	SO2GBIII10	SO2GBIII10	N500GB5.4KS
AS4820TG-434G50Mn	Greece	LX.PSG02.010	SO2GBIII10	SO2GBIII10	N500GB5.4KS
AS4820TG-434G50Mn	Eastern Europe	LX.PSG02.009	SO2GBIII10	SO2GBIII10	N500GB5.4KS
AS4820TG-434G50Mn	France	LX.PSG02.008	SO2GBIII10	SO2GBIII10	N500GB5.4KS
AS4820TG-434G50Mn	UK	LX.PSG02.007	SO2GBIII10	SO2GBIII10	N500GB5.4KS
AS4820TG-522G50Mn	WW	S2.PSG02.003	SO1GBIII10	SO1GBIII10	N500GB5.4KS
AS4820TG-624G64Mn	Singapore	LX.PSG02.003	SO2GBIII10	SO2GBIII10	N640GB5.4KS
AS4820TG-524G64Mn	Singapore	LX.PSG02.002	SO2GBIII10	SO2GBIII10	N640GB5.4KS
AS4820TG-434G50Mn	Singapore	LX.PSG02.001	SO2GBIII10	SO2GBIII10	N500GB5.4KS
AS4820TG-522G50Mn	WW	S2.PSG02.002	SO1GBIII10	SO1GBIII10	N500GB5.4KS
AS4820T-522G16Mn	WW	S2.PSG02.001	SO2GBIII10	N	N160GB5.4KS
AS4820TG-332G16Mn	WW	S2.PVM02.001	SO1GBIII10	SO1GBIII10	N160GB5.4KS
AS4820T-432G50Mn	Singapore	LX.PSN02.107	SO2GBIII10	N	N500GB5.4KS
AS4820T-354G32Mn	Chile	LX.PSN02.112	SO2GBIII10	SO2GBIII10	N320GB5.4KS
AS4820T-354G32Mn	ACLA-Spanish	LX.PSN02.111	SO2GBIII10	SO2GBIII10	N320GB5.4KS
AS4820T-354G32Mn	ACLA-Spanish	LX.PSN02.110	SO2GBIII10	SO2GBIII10	N320GB5.4KS
AS4820T-354G32Mn	ACLA-Spanish	LX.PSN02.109	SO2GBIII10	SO2GBIII10	N320GB5.4KS
AS4820T-354G32Mn	ACLA-Portuguese	LX.PSN02.108	SO2GBIII10	SO2GBIII10	N320GB5.4KS

Model	Country	Acer Part No	Memory 1	Memory 2	HDD 1(GB)
AS4820T-432G50Mn	China	LX.PSN0C.005	SO2GBIII10	N	N500GB5.4KS
AS4820T-333G32Mn	Ukraine	LX.PSN02.106	SO2GBIII10	SO1GBIII10	N320GB5.4KS
AS4820T-333G32Mi	Russia	LX.PSN02.105	SO2GBIII10	SO1GBIII10	N320GB5.4KS
AS4820T-333G32Mn	Middle East	LX.PSN02.104	SO2GBIII10	SO1GBIII10	N320GB5.4KS
AS4820T-333G32Mn	Middle East	LX.PSN02.103	SO2GBIII10	SO1GBIII10	N320GB5.4KS
AS4820T-333G32Mn	South Africa	LX.PSN02.102	SO2GBIII10	SO1GBIII10	N320GB5.4KS
AS4820T-333G32Mn	Turkey	LX.PSN02.101	SO2GBIII10	SO1GBIII10	N320GB5.4KS
AS4820T-333G32Mn	Middle East	LX.PSN02.099	SO2GBIII10	SO1GBIII10	N320GB5.4KS
AS4820T-333G32Mn	Middle East	LX.PSN02.098	SO2GBIII10	SO1GBIII10	N320GB5.4KS
AS4820T-333G32Mn	South Africa	LX.PSN02.097	SO2GBIII10	SO1GBIII10	N320GB5.4KS
AS4820T-333G32Mn	Middle East	LX.PSN02.096	SO2GBIII10	SO1GBIII10	N320GB5.4KS
AS4820T-333G32Mn	Algeria	LX.PSN02.095	SO2GBIII10	SO1GBIII10	N320GB5.4KS
AS4820T-333G32Mn	South Africa	LX.PSN02.094	SO2GBIII10	SO1GBIII10	N320GB5.4KS
AS4820T-333G32Mn	Middle East	LX.PSN02.093	SO2GBIII10	SO1GBIII10	N320GB5.4KS
AS4820T-333G32Mn	Middle East	LX.PSN02.092	SO2GBIII10	SO1GBIII10	N320GB5.4KS
AS4820T-333G32Mn	Middle East	LX.PSN02.090	SO2GBIII10	SO1GBIII10	N320GB5.4KS
AS4820T-333G32Mn	Middle East	LX.PSN02.091	SO2GBIII10	SO1GBIII10	N320GB5.4KS
AS4820T-333G32Mn	South Africa	LX.PSN02.089	SO2GBIII10	SO1GBIII10	N320GB5.4KS
AS4820T-333G32Mn	Germany	LX.PSN02.088	SO2GBIII10	SO1GBIII10	N320GB5.4KS
AS4820T-333G32Mn	Poland	LX.PSN02.087	SO2GBIII10	SO1GBIII10	N320GB5.4KS
AS4820T-333G32Mn	Baltic	LX.PSN02.086	SO2GBIII10	SO1GBIII10	N320GB5.4KS
AS4820T-333G32Mn	Holland	LX.PSN02.085	SO2GBIII10	SO1GBIII10	N320GB5.4KS
AS4820T-333G32Mn	Belgium	LX.PSN02.084	SO2GBIII10	SO1GBIII10	N320GB5.4KS
AS4820T-333G32Mn	Switzerland	LX.PSN02.083	SO2GBIII10	SO1GBIII10	N320GB5.4KS
AS4820T-333G32Mn	Luxembourg	LX.PSN02.082	SO2GBIII10	SO1GBIII10	N320GB5.4KS

Model	Country	Acer Part No	Memory 1	Memory 2	HDD 1(GB)
AS4820T-333G32Mn	Latvia	LX.PSN02.081	SO2GBIII10	SO1GBIII10	N320GB5.4KS
AS4820T-333G32Mn	Latvia	LX.PSN02.080	SO2GBIII10	SO1GBIII10	N320GB5.4KS
AS4820T-333G32Mn	UK	LX.PSN02.079	SO2GBIII10	SO1GBIII10	N320GB5.4KS
AS4820T-333G32Mn	Eastern Europe	LX.PSN02.078	SO2GBIII10	SO1GBIII10	N320GB5.4KS
AS4820T-333G32Mn	Eastern Europe	LX.PSN02.077	SO2GBIII10	SO1GBIII10	N320GB5.4KS
AS4820T-333G32Mn	Czech	LX.PSN02.076	SO2GBIII10	SO1GBIII10	N320GB5.4KS
AS4820T-333G32Mn	Israel	LX.PSN02.074	SO2GBIII10	SO1GBIII10	N320GB5.4KS
AS4820T-333G32Mn	Hungary	LX.PSN02.075	SO2GBIII10	SO1GBIII10	N320GB5.4KS
AS4820T-333G32Mn	Baltic	LX.PSN02.073	SO2GBIII10	SO1GBIII10	N320GB5.4KS
AS4820T-333G32Mn	Portugal	LX.PSN02.072	SO2GBIII10	SO1GBIII10	N320GB5.4KS
AS4820T-333G32Mn	Cyprus	LX.PSN02.071	SO2GBIII10	SO1GBIII10	N320GB5.4KS
AS4820T-333G32Mn	Baltic	LX.PSN02.070	SO2GBIII10	SO1GBIII10	N320GB5.4KS
AS4820T-333G32Mn	Serbia/ Macedonia	LX.PSN02.069	SO2GBIII10	SO1GBIII10	N320GB5.4KS
AS4820T-333G32Mn	Italy	LX.PSN02.068	SO2GBIII10	SO1GBIII10	N320GB5.4KS
AS4820T-333G32Mn	Spain	LX.PSN02.067	SO2GBIII10	SO1GBIII10	N320GB5.4KS
AS4820T-333G32Mn	Denmark	LX.PSN02.066	SO2GBIII10	SO1GBIII10	N320GB5.4KS
AS4820T-333G32Mn	Eastern Europe	LX.PSN02.065	SO2GBIII10	SO1GBIII10	N320GB5.4KS
AS4820T-333G32Mn	Eastern Europe	LX.PSN02.064	SO2GBIII10	SO1GBIII10	N320GB5.4KS
AS4820T-333G32Mn	Greece	LX.PSN02.063	SO2GBIII10	SO1GBIII10	N320GB5.4KS
AS4820T-333G32Mn	Austria	LX.PSN02.062	SO2GBIII10	SO1GBIII10	N320GB5.4KS
AS4820T-333G32Mn	France	LX.PSN02.061	SO2GBIII10	SO1GBIII10	N320GB5.4KS
AS4820T-333G32Mn	Eastern Europe	LX.PSN02.060	SO2GBIII10	SO1GBIII10	N320GB5.4KS
AS4820T-331G32Mn	Malaysia	LX.PSN0C.004	SO1GBIII10	N	N320GB5.4KS
AS4820T-432G32Mn	Vietnam	LX.PSN0C.003	SO2GBIII10	N	N320GB5.4KS
AS4820T-332G32Mn	Vietnam	LX.PSN0C.002	SO2GBIII10	N	N320GB5.4KS

Model	Country	Acer Part No	Memory 1	Memory 2	HDD 1(GB)
AS4820T-332G32Mn	Malaysia	LX.PSN02.059	SO2GBIII10	N	N320GB5.4KS
AS4820T-333G50Mn	Italy	LX.PSN02.058	SO2GBIII10	SO1GBIII10	N500GB5.4KS
AS4820T-522G50Mn	Philippines	LX.PSN02.057	SO2GBIII10	N	N500GB5.4KS
AS4820T-333G32Mn	Italy	LX.PSN02.056	SO2GBIII10	SO1GBIII10	N320GB5.4KS
AS4820T-432G32Mn	Malaysia	LX.PSN02.055	SO2GBIII10	N	N320GB5.4KS
AS4820T-432G32Mn	Malaysia	LX.PSN0C.001	SO2GBIII10	N	N320GB5.4KS
AS4820T-432G32Mn	Thailand	LX.PSN02.054	SO2GBIII10	N	N320GB5.4KS
AS4820T-332G32Mn	Thailand	LX.PSN02.053	SO2GBIII10	N	N320GB5.4KS
AS4820T-332G25Mn	China	LX.PSN02.052	SO2GBIII10	N	N250GB5.4KS
AS4820T-334G32Mn	South Africa	LX.PSN02.051	SO2GBIII10	SO2GBIII10	N320GB5.4KS
AS4820T-334G32Mn	Middle East	LX.PSN02.050	SO2GBIII10	SO2GBIII10	N320GB5.4KS
AS4820T-334G32Mn	Middle East	LX.PSN02.049	SO2GBIII10	SO2GBIII10	N320GB5.4KS
AS4820T-334G32Mn	Turkey	LX.PSN02.048	SO2GBIII10	SO2GBIII10	N320GB5.4KS
AS4820T-334G32Mn	Middle East	LX.PSN02.047	SO2GBIII10	SO2GBIII10	N320GB5.4KS
AS4820T-334G32Mn	Middle East	LX.PSN02.046	SO2GBIII10	SO2GBIII10	N320GB5.4KS
AS4820T-334G32Mn	South Africa	LX.PSN02.045	SO2GBIII10	SO2GBIII10	N320GB5.4KS
AS4820T-334G32Mn	Middle East	LX.PSN02.044	SO2GBIII10	SO2GBIII10	N320GB5.4KS
AS4820T-334G32Mn	Algeria	LX.PSN02.043	SO2GBIII10	SO2GBIII10	N320GB5.4KS
AS4820T-334G32Mn	Middle East	LX.PSN02.042	SO2GBIII10	SO2GBIII10	N320GB5.4KS
AS4820T-334G32Mn	Middle East	LX.PSN02.041	SO2GBIII10	SO2GBIII10	N320GB5.4KS
AS4820T-334G32Mn	South Africa	LX.PSN02.040	SO2GBIII10	SO2GBIII10	N320GB5.4KS
AS4820T-334G32Mn	Middle East	LX.PSN02.039	SO2GBIII10	SO2GBIII10	N320GB5.4KS
AS4820T-334G32Mn	Middle East	LX.PSN02.038	SO2GBIII10	SO2GBIII10	N320GB5.4KS
AS4820T-334G32Mn	Poland	LX.PSN02.037	SO2GBIII10	SO2GBIII10	N320GB5.4KS
AS4820T-334G32Mn	Germany	LX.PSN02.036	SO2GBIII10	SO2GBIII10	N320GB5.4KS

Model	Country	Acer Part No	Memory 1	Memory 2	HDD 1(GB)
AS4820T-334G32Mn	Luxembourg	LX.PSN02.035	SO2GBIII10	SO2GBIII10	N320GB5.4KS
AS4820T-334G32Mn	Eastern Europe	LX.PSN02.034	SO2GBIII10	SO2GBIII10	N320GB5.4KS
AS4820T-334G32Mn	Latvia	LX.PSN02.033	SO2GBIII10	SO2GBIII10	N320GB5.4KS
AS4820T-334G32Mn	Latvia	LX.PSN02.032	SO2GBIII10	SO2GBIII10	N320GB5.4KS
AS4820T-334G32Mn	Hungary	LX.PSN02.031	SO2GBIII10	SO2GBIII10	N320GB5.4KS
AS4820T-334G32Mn	Israel	LX.PSN02.030	SO2GBIII10	SO2GBIII10	N320GB5.4KS
AS4820T-334G32Mn	Czech	LX.PSN02.029	SO2GBIII10	SO2GBIII10	N320GB5.4KS
AS4820T-334G32Mn	Cyprus	LX.PSN02.028	SO2GBIII10	SO2GBIII10	N320GB5.4KS
AS4820T-334G32Mn	Portugal	LX.PSN02.027	SO2GBIII10	SO2GBIII10	N320GB5.4KS
AS4820T-334G32Mn	Holland	LX.PSN02.026	SO2GBIII10	SO2GBIII10	N320GB5.4KS
AS4820T-334G32Mn	Belgium	LX.PSN02.025	SO2GBIII10	SO2GBIII10	N320GB5.4KS
AS4820T-334G32Mn	Switzerland	LX.PSN02.024	SO2GBIII10	SO2GBIII10	N320GB5.4KS
AS4820T-334G32Mn	Baltic	LX.PSN02.023	SO2GBIII10	SO2GBIII10	N320GB5.4KS
AS4820T-334G32Mn	UK	LX.PSN02.022	SO2GBIII10	SO2GBIII10	N320GB5.4KS
AS4820T-334G32Mn	Eastern Europe	LX.PSN02.021	SO2GBIII10	SO2GBIII10	N320GB5.4KS
AS4820T-334G32Mn	Baltic	LX.PSN02.020	SO2GBIII10	SO2GBIII10	N320GB5.4KS
AS4820T-334G32Mn	Denmark	LX.PSN02.019	SO2GBIII10	SO2GBIII10	N320GB5.4KS
AS4820T-334G32Mn	Eastern Europe	LX.PSN02.018	SO2GBIII10	SO2GBIII10	N320GB5.4KS
AS4820T-334G32Mn	Italy	LX.PSN02.017	SO2GBIII10	SO2GBIII10	N320GB5.4KS
AS4820T-334G32Mn	Spain	LX.PSN02.016	SO2GBIII10	SO2GBIII10	N320GB5.4KS
AS4820T-334G32Mn	Eastern Europe	LX.PSN02.015	SO2GBIII10	SO2GBIII10	N320GB5.4KS
AS4820T-334G32Mn	Serbia/ Macedonia	LX.PSN02.014	SO2GBIII10	SO2GBIII10	N320GB5.4KS
AS4820T-334G32Mn	Baltic	LX.PSN02.013	SO2GBIII10	SO2GBIII10	N320GB5.4KS
AS4820T-334G32Mn	Austria	LX.PSN02.012	SO2GBIII10	SO2GBIII10	N320GB5.4KS
AS4820T-334G32Mn	Greece	LX.PSN02.011	SO2GBIII10	SO2GBIII10	N320GB5.4KS

Model	Country	Acer Part No	Memory 1	Memory 2	HDD 1(GB)
AS4820T-334G32Mn	Eastern Europe	LX.PSN02.010	SO2GBIII10	SO2GBIII10	N320GB5.4KS
AS4820T-334G32Mn	France	LX.PSN02.009	SO2GBIII10	SO2GBIII10	N320GB5.4KS
AS4820T-434G32Mn	UK	LX.PSN02.008	SO2GBIII10	SO2GBIII10	N320GB5.4KS
AS4820T-333G25Mn	UK	LX.PSN02.007	SO2GBIII10	SO1GBIII10	N250GB5.4KS
AS4820T-334G25Mn	WW	S2.PSN02.004	SO2GBIII10	SO2GBIII10	N250GB5.4KS
AS4820T-334G25Mn	WW	S2.PSN02.003	SO2GBIII10	SO2GBIII10	N250GB5.4KS
AS4820T-332G32Mn	Singapore	LX.PSN02.003	SO2GBIII10	N	N320GB5.4KS
AS4820T-434G32Mn	Singapore	LX.PSN02.002	SO2GBIII10	SO2GBIII10	N320GB5.4KS
AS4820T-334G32Mn	Singapore	LX.PSN02.001	SO2GBIII10	SO2GBIII10	N320GB5.4KS
AS4820T-524G25Mn	WW	S2.PSN02.002	SO2GBIII10	SO2GBIII10	N250GB5.4KS
AS4820T-522G16Mn	WW	S2.PSN02.001	SO2GBIII10	N	N160GB5.4KS
AS4820T-334G25Mn	WW	S2.PVK02.001	SO2GBIII10	SO2GBIII10	N250GB5.4KS

Test Compatible Components

This computer's compatibility is tested and verified by Acer's internal testing department. All of its system functions are tested under Windows® 7 with backwards compatibility to Windows® XP.

Refer to the following lists for components, adapter cards, and peripherals which have passed these tests. Regarding configuration, combination and test procedures, please refer to the Acer Aspire 4820T Compatibility Test Report released by the Acer Mobile System Testing Department.

Microsoft® Windows® 7 Environment Test

Online Support Information

This section describes online technical support services available to help you repair your Acer Systems.

If you are a distributor, dealer, ASP or TPM, please refer your technical queries to your local Acer branch office. Acer Branch Offices and Regional Business Units may access our website. However some information sources will require a user i.d. and password. These can be obtained directly from Acer CSD Taiwan.

Acer's Website offers you convenient and valuable support resources whenever you need them.

In the Technical Information section you can download information on all of Acer's Notebook, Desktop and Server models including:

- Service guides for all models
- User's manuals
- Bios updates
- Software utilities
- Spare parts lists
- TABs (Technical Announcement Bulletin)

For these purposes, we have included an Acrobat File to facilitate the problem-free downloading of our technical material.

Also contained on this website are:

- Detailed information on Acer's International Traveler's Warranty (ITW)
- Returned material authorization procedures
- An overview of all the support services we offer, accompanied by a list of telephone, fax and email contacts for all your technical queries.

We are always looking for ways to optimize and improve our services, so if you have any suggestions or comments, please do not hesitate to communicate these to us.

A

AFLASH Utility 27
Antennas 75

B

Battery Pack 40
BIOS
 ROM type 13
 vendor 13
 Version 13
BIOS Utility 19–27
 Advanced 22
 Boot 25
 Exit 26
 Navigating 19
 Onboard Device Configuration 23
 Power 25
 Save and Exit 26
 Security 22
 System Security 26
Board Layout
 Top View 119
brightness
 hotkeys 12

C

Camera Module 71
Common Problems 104
computer
 on indicator 8

D

DIMM Module 45
Display 4
display
 hotkeys 12

E

EasyTouch Failure 114
External Module Disassembly
 Flowchart 39

F

Features 1
Flash Utility 27
FPC Cable 73
FRU (Field Replaceable Unit) List 123

H

Hard Disk Drive Module 47
HDTV Switch Failure 115
Hibernation mode
 hotkey 12
Hot Keys 10

I

Intermittent Problems 116
Internal Microphone Failure 109
Internal Speaker Failure 108

J

Jumper and Connector Locations 119

K

Keyboard Failure 107

L

LCD Bezel 70
LCD Failure 107
LCD Module Disassembly
 Flowchart 69
LCD Panel 72
lower cover 42

M

Main Unit Disassembly
 Flowchart 48
Mainboard 61
media access
 on indicator 8
Memory Check 104
Model Definition 126

N

No Display Issue 105

BIOS 19–27

O

ODD Failure 111

Online Support Information 129

optical drive module 43

P

Panel 5

Bottom 7
left 5

Power On Failure 104

R

RTC Battery 65

S

SD Card 41

Speaker Module 56

System

Block Diagram 4

T

Test Compatible Components 127

Thermal Module 63

Thermal Unit Failure 114

TouchPad Failure 108

Troubleshooting

Built-in KB Failure 107
EasyTouch Buttons 114
HDTV Switch 115
Internal Microphone 109
Internal Speakers 108
LCD Failure 107
No Display 105
ODD 111
Other Failures 115
Power On 104
Thermal Unit 114
TouchPad 108
WLAN 114

U

Undetermined Problems 116

USB Board 57

utility

W

Windows 2000 Environment Test 128

Wireless Function Failure 114

WLAN Board 46