



# Grandstream Networks, Inc.

---

GXP1100/GXP1105

Small Business IP Phone



# GXP1100/GXP1105 User Manual

## Index

<b>GUI INTERFACE EXAMPLES.....</b>	<b>5</b>
<b>GNU GPL INFORMATION.....</b>	<b>6</b>
<b>CHANGE LOG .....</b>	<b>7</b>
FIRMWARE VERSION 1.0.5.58 .....	7
FIRMWARE VERSION 1.0.5.32 .....	7
FIRMWARE VERSION 1.0.5.26 .....	7
FIRMWARE VERSION 1.0.5.15 .....	7
FIRMWARE VERSION 1.0.4.23 .....	7
FIRMWARE VERSION 1.0.4.9 .....	8
<b>WELCOME.....</b>	<b>9</b>
<b>PRODUCT OVERVIEW.....</b>	<b>10</b>
FEATURE HIGHLIGHTS .....	10
GXP1100/GXP1105 TECHNICAL SPECIFICATIONS .....	10
<b>INSTALLATION.....</b>	<b>12</b>
EQUIPMENT PACKAGING .....	12
CONNECTING YOUR PHONE .....	12
SAFETY COMPLIANCES.....	13
WARRANTY.....	14
<b>USING THE GXP1100/GXP1105.....</b>	<b>15</b>
GETTING FAMILAR WITH THE KEYPAD.....	15
MAKING PHONE CALLS.....	16
<i>2 CALLS WITH 1 SIP ACCOUNT.....</i>	<i>16</i>
<i>COMPLETING CALLS.....</i>	<i>16</i>
<i>MAKING CALLS USING IP ADDRESSES .....</i>	<i>17</i>
ANSWERING PHONE CALLS .....	18
<i>RECEIVING CALLS.....</i>	<i>18</i>
DURING A PHONE CALL.....	18
<i>CALL WAITING/CALL HOLD .....</i>	<i>18</i>
<i>MUTE.....</i>	<i>19</i>

CALL TRANSFER .....	19
3-WAY CONFERENCING .....	20
VOICE MESSAGES (MESSAGE WAITING INDICATOR) .....	22
CALL FEATURES .....	22
<b>CONFIGURATION GUIDE.....</b>	<b>25</b>
CONFIGURATION VIA IVR MENU .....	25
CONFIGURATION VIA WEB BROWSER .....	26
DEFINITIONS .....	27
STATUS PAGE DEFINITIONS .....	28
ACCOUNT PAGE DEFINITIONS .....	29
SETTINGS PAGE DEFINITIONS .....	37
NETWORK PAGE DEFINITIONS.....	39
MAINTENANCE PAGE DEFINITIONS.....	41
NAT SETTINGS .....	44
CLICK-TO-DIAL .....	44
<b>UPGRADING AND PROVISIONING .....</b>	<b>46</b>
UPGRADE VIA IVR MENU .....	46
UPGRAGE VIA WEB GUI.....	46
NO LOCAL TFTP/HTTP SERVERS .....	47
CONFIGURATION FILE DOWNLOAD .....	48
<b>RESTORE FACTORY DEFAULT SETTINGS .....</b>	<b>49</b>
<b>EXPERIENCING THE GXP1100/GXP1105 .....</b>	<b>50</b>

**Table of Tables**  
**GXP1100/GXP1105 User Manual**

Table 1: GXP1100/GXP1105 TECHNICAL SPECIFICATIONS.....	10
Table 2: GXP1100/GXP1105 EQUIPMENT PACKAGING .....	12
Table 3: GXP1100/GXP1105 CONNECTORS .....	12
Table 4: GXP1100/GXP1105 KEYPAD DEFINITIONS .....	15
Table 5: CALL FEATURES.....	22
Table 6: GXP1100/GXP1105 IVR MENU .....	25

**Table of Figures**  
**GXP1100/GXP1105 User Manual**

Figure 1: GXP1100/GXP1105 Ports.....	12
Figure 2: GXP1100/GXP1105 Pin-out.....	13
Figure 3: GXP1100/GXP1105 Multi Purpose Key - 3 way Conference .....	20
Figure 4: Click-to-Dial.....	45

## GUI INTERFACE EXAMPLES

[http://www.grandstream.com/products/gxp\\_series/general/documents/gxp21xx\\_gui.zip](http://www.grandstream.com/products/gxp_series/general/documents/gxp21xx_gui.zip)

1. Screenshot of Configuration Login Page
2. Screenshot of Status Page
3. Screenshot of Basic Setting Configuration Page
4. Screenshot of Advanced User Configuration Page
5. Screenshot of SIP Account Configuration Page
6. Screenshot of Saved Configuration Changes Page
7. Screenshot of Reboot Page

## GNU GPL INFORMATION

GXP1100/GXP1105 firmware contains third-party software licensed under the GNU General Public License (GPL). Grandstream uses software under the specific terms of the GPL. Please see the GNU General Public License (GPL) for the exact terms and conditions of the license.

Grandstream GNU GPL related source code can be downloaded from Grandstream web site from:  
[http://www.grandstream.com/support/faq/gnu\\_gpl](http://www.grandstream.com/support/faq/gnu_gpl).

## CHANGE LOG

This section documents significant changes from previous versions of GXP1100/GXP1105 user manuals. Only major new features or major document updates are listed here. Minor updates for corrections or editing are not documented here.

### FIRMWARE VERSION 1.0.5.58

- Added “3CX Auto Provision” under Maintenance. [MAINTENANCE PAGE DEFINITIONS]
- Added “Second Dial Tone” under Settings. [SETTINGS PAGE DEFINITIONS]
- Added “Hold Method” under Account setting. [SETTINGS PAGE DEFINITIONS]
- Added “Crypto Life Time” under Account setting.[ACCOUNT PAGE DEFINITIONS]

### FIRMWARE VERSION 1.0.5.32

- Added “Web Access Mode” under Security setting. [SECURITY]
- Replaced “Disable Telnet” under Web Access by “Disable SSH” under Security setting page. [SECURITY]

### FIRMWARE VERSION 1.0.5.26

- Updated TFTP server download link for 1.0.5.26, [NO LOCAL HTTP/TFTP SERVERS]
- Added “Blink message LED on ringing” feature in Call Features. [CALL FEATURES]

### FIRMWARE VERSION 1.0.5.15

- Updated Web GUI interface examples with new screenshots for 1.0.5.15. [GUI INTERFACE EXAMPLES]
- Added pin-out information. [CONNECTING YOUR PHONE]
- Updated Auto Attended Transfer information. [CALL TRANSFER]
- Updated Click-To-Dial feature information. [CLICK-TO-DIAL]
- Updated Web GUI options. [DEFINITIONS]

### FIRMWARE VERSION 1.0.4.23

- Updated generic config file cfg.xml information. [CONFIGURATION FILE DOWNLOAD]
- Added "Use Privacy Header" and "Use P-Preferred-Identity Header" options in web GUI. [ACCOUNT PAGE DEFINITIONS]

- Added NAT Settings information. [NAT SETTINGS]
- Added Click-to-Dial feature. [CLICK-TO-DIAL]

### **FIRMWARE VERSION 1.0.4.9**

- Added instructions for connecting the phone. [CONNECTING YOUR PHONE]
- Added Multi Purpose Key options VMsg, Transfer, Intercom. [SETTINGS PAGE]
- Added IPv6 configuration options. [SETTINGS PAGE]
- Added Matching Incoming Caller ID function in Account Setting. [ACCOUNT PAGE DEFINITIONS]
- Added GNU GPL information. [GNU GPL INFORMATION]
- Added Change Log for this user manual. [CHANGE LOG]



## WELCOME

Thank you for purchasing Grandstream GXP1100/GXP1105 Small Business IP Phone. GXP1100/GXP1105 is a next generation small business IP phone that features up to 2 calls with 1 SIP account, 4 programmable keys, single network port, integrated PoE (GXP1105 only). The GXP1100/GXP1105 delivers superior HD audio quality, leading edge telephony features, automated provisioning for easy deployment, advanced security protection for privacy, and broad interoperability with most 3rd party SIP devices and leading SIP/NGN/IMS platforms. It is a perfect choice for small business, lobby, and hotel applications looking for a high quality, basic IP phone with attractive cost.

**Caution:**

Changes or modifications to this product not expressly approved by Grandstream, or operation of this product in any way other than as detailed by this User Manual, could void your manufacturer warranty.

**Warning:**

Please do not use a different power adaptor with the GXP1100 as it may cause damage to the products and void the manufacturer warranty.

This document is subject to change without notice. The latest electronic version of this user manual is available for download here:

<http://www.grandstream.com/support>

Reproduction or transmittal of the entire or any part, in any form or by any means, electronic or print, for any purpose without the express written permission of Grandstream Networks, Inc. is not permitted.

## PRODUCT OVERVIEW

### FEATURE HIGHLIGHTS

- Single SIP Account, up to 2 calls, 4 programmable keys
- HD handset with support for wideband audio
- Single 10/100Mbps network port, integrated PoE (GXP1105 only)
- 7 dedicated function keys for Hold, Flash/Call Waiting, Transfer, Message, Mute, Volume, Send/Redial
- Automated provisioning using TR-069 or AES encrypted XML configuration file, SRTP and TLS for advanced security and privacy protection, LLDP, IPv6

### GXP1100/GXP1105 TECHNICAL SPECIFICATIONS

Table 1: GXP1100/GXP1105 TECHNICAL SPECIFICATIONS

<b>Protocols and Standards</b>	SIP RFC3261, TCP/IP/UDP, RTP/RTCP, HTTP/HTTPS, ARP, ICMP, DNS (A record, SRV, NAPTR), DHCP, PPPoE, SSH, TFTP, NTP, STUN, TR-069, 802.1x, LLDP, LLDP-MED, IPv6, TLS, SRTP
<b>Network Interfaces</b>	Single 10/100Mbps port, integrated PoE (GXP1105 only)
<b>Graphic Display</b>	N/A
<b>Feature Keys</b>	4 programmable keys, 7 dedicated function keys for HOLD, FLASH, TRANSFER, MUTE, VOLUME, SEND/REDIAL and MESSAGE (with LED indicator)
<b>Voice Codec</b>	Support for G.723.1, G.729A/B, G.711u/a, G.726-32, G.722 (wide-band), iLBC, in-band and out-of-band DTMF (in audio, RFC2833, SIP INFO)
<b>Telephony Features</b>	Hold, transfer, forward, 3-way conference, call waiting, off-hook auto dial, click-to-dial, flexible dial plan, personalized music ringtones, server redundancy and fail-over
<b>HD Audio</b>	Yes, HD handset with support for wideband audio
<b>Headset Jack</b>	N/A
<b>Base Stand</b>	Yes, 1 angle position available
<b>Wall Mountable</b>	Yes
<b>QoS</b>	Layer 2 (802.1Q, 802.1p) and Layer 3 (ToS, DiffServ, MPLS) QoS
<b>Security</b>	User and administrator level passwords, MD5 and MD5-sess based authentication, 256-bit AES encrypted configuration file, TLS, SRTP, 802.1x media access control
<b>Multi-language</b>	English, German, Italian, French, Spanish, Portuguese, Russian, Croatian,

	Simplified Chinese, traditional Chinese, Korean, Japanese, and etc supported in web configuration interface
<b>Upgrade and Provisioning</b>	Firmware upgrade via TFTP/HTTP/HTTPS, mass provisioning using TR-069 or AES encrypted XML configuration file
<b>Power and Green Energy Efficiency</b>	Universal power adapter: Input: 100-240VAC 50-60Hz; Output: 5VDC, 800mA Integrated Power-over-Ethernet (802.3af, GXP1105 only) Typical power consumption under 1W (power adapter) or under 1.5W (PoE)
<b>Physical</b>	Unit dimension: 201mm (W) x 154mm (H) x 78mm (D) Unit weight: 0.6kg Package weight: 1.0kg
<b>Operating Temperature and Humidity</b>	32-104 °F / 0-40 °C, 10-90% (non-condensing)
<b>Package Content</b>	GXP1100/GXP1105 phone, handset with cord, base stand, universal power supply, network cable, quick start guide
<b>Compliance</b>	FCC Part 15 (CFR 47) Class B; EN55022 Class B, EN55024, EN61000-3-2, EN61000-3-3, EN60950-1; AS/NZS CISPR 22 Class B, AS/NZS CISPR 24, RoHS; UL 60950 (power adapter)

## INSTALLATION

### EQUIPMENT PACKAGING

Table 2: GXP1100/GXP1105 EQUIPMENT PACKAGING

<b>Main Case</b>	Yes	1
<b>Handset</b>	Yes	1
<b>Phone Cord</b>	Yes	1
<b>Power Adaptor</b>	Yes	1
<b>Ethernet Cable</b>	Yes	1
<b>Phone Stand</b>	Yes	1
<b>Quick Start Guide</b>	Yes	1

### CONNECTING YOUR PHONE

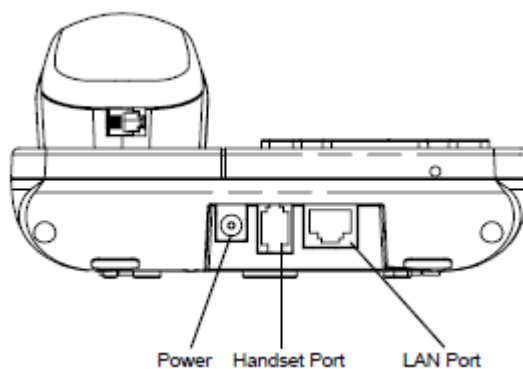

Figure 1: GXP1100/GXP1105 Ports

Table 3: GXP1100/GXP1105 CONNECTORS

<b>Handset Port</b>	RJ9 handset connector port
<b>LAN Port</b>	10/100Mbps RJ-45 port connecting to Ethernet, integrated PoE (GXP1105 only)
<b>Power Jack</b>	5V DC Power connector port

To set up the GXP1100/GXP1105, follow the steps below:

1. Attach the phone stand to the back of the phone where there is a slot for the phone stand;
2. Connect the handset and main phone case with the phone cord;
3. Connect the LAN port of the phone to the RJ-45 socket of a hub/switch or a router (LAN side of the router) using the Ethernet cable;
4. Connect the 5V DC output plug to the power jack on the phone; plug the power adapter into an electrical outlet. If PoE switch is used on GXP1105 in step 3, this step could be skipped;
5. The LED on the up right corner will light up in red during the booting up/provisioning/upgrading process. Before continuing, please wait for the LED turn off;
6. Pick up the handset and the dial tone will be heard. Press \*\*\* to use the IVR menu and enter menu options to hear the corresponding voice prompt. For example, dial 02 in the IVR menu will hear the IP address. You can further configure the phone using the web GUI by entering GXP1100/GXP1105's IP address.

Please see below the pin-out information for GXP1100/GXP1105.

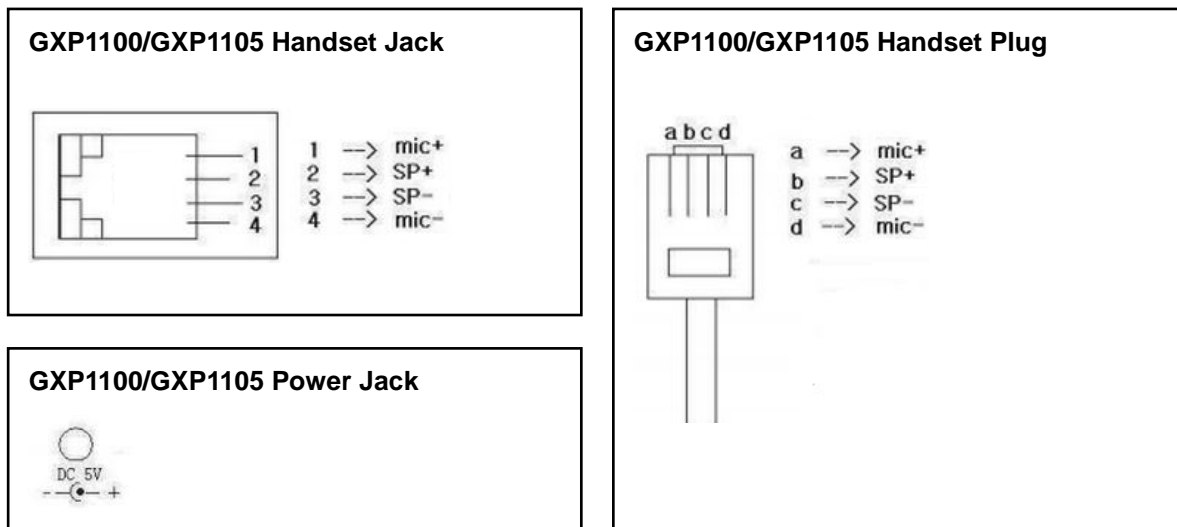

Figure 2: GXP1100/GXP1105 Pin-out

## SAFETY COMPLIANCES

The GXP1100/GXP1105 phone complies with FCC/CE and various safety standards. The GXP1100/GXP1105 power adapter is compliant with the UL standard. Use the universal power adapter provided with the GXP1100/GXP1105 package only. The manufacturer's warranty does not cover damages to the phone caused by unsupported power adapters.

## WARRANTY

If the GXP1100/GXP1105 phone was purchased from a reseller, please contact the company where the phone was purchased for replacement, repair or refund. If the phone was purchased directly from Grandstream, contact the Grandstream Support for a RMA (Return Materials Authorization) number before the product is returned. Grandstream reserves the right to remedy warranty policy without prior notification.

### **Warning:**









Use the power adapter provided with the phone. Do not use a different power adapter as this may damage the phone. This type of damage is not covered under warranty.

## USING THE GXP1100/GXP1105

### GETTING FAMILAR WITH THE KEYPAD

The following table describes the buttons used on the GXP1100/GXP1105 keypad.

**Table 4: GXP1100/GXP1105 KEYPAD DEFINITIONS**

	<b>Hold.</b> Place active call on hold, or resume the call on hold.
	<p><b>Flash.</b> Flash key can be used for multiple purposes.</p> <ul style="list-style-type: none"> <li>• Call waiting. Bring up a new line; or answer the second incoming call.</li> <li>• 3-way Conference. Establish 3-way conference when FLASH key is configured as CONF. Before using the Flash key for 3-way conference, "Enable Flash key as CONF" option has to be set to "Yes" under web GUI-&gt;Advanced Settings.</li> </ul>
	<b>Transfer.</b> Transfer an active call to another number.
	<b>Message.</b> Retrieve voicemail messages.
	<b>Programmable hard key.</b> It can be configured for multiple purposes: Speed dial, Dial DTMF, VMsg, Call Return, 3-way Conference, Transfer, Intercom.
	<b>Mute.</b> Press to mute/unmute an active call.
	<p><b>Send.</b> It can be used as Send or Redial.</p> <ul style="list-style-type: none"> <li>• Send. Enter the digits and then press Send to dial out the number.</li> <li>• Redial. Redial when there is a previously dialed call.</li> </ul>
	<b>Volume.</b> Press "-" or "+" to adjust the volume.
0 - 9, *, #	<b>Standard phone keypad.</b>

## MAKING PHONE CALLS

### 2 CALLS WITH 1 SIP ACCOUNT

GXP1100/GXP1105 can support up to two lines “virtually” mapped to one SIP account. By picking up the handset, the GXP1100/GXP1105 will be in off hook state and the dial tone will be heard. To make a call, dial out the number with the current line.

During the call, users can press the FLASH key to hold the current call and make/answer another call. If they are 2 calls established, users can switch the two lines by pressing the FLASH key.

### COMPLETING CALLS

The GXP1100/GXP1105 allows you to make phone calls after picking up the handset. There are four ways to complete calls.

- **Dial.** Enter the number and send out.
  - Take handset off hook. You shall hear dial tone from the handset;
  - Enter the number;
  - Press SEND key or # to dial out.
  
- **Redial.** Redial the last dialed number.
  - Take handset off hook. You shall hear dial tone from the handset;
  - Press SEND key.
  
- **Speed Dial.** Dial the number configured as Speed Dial on Multi Purpose Key.
  - Go to GXP1100/GXP1105 **Web GUI->Settings->Programmable Keys**, configure the Multi-Purpose Key's Key Mode as Speed Dial. Enter the Description and Value (the number to be dialed out) for the Multi-Purpose Key. Click on "Save and Apply" at the bottom of the Web GUI page;
  - Take handset off hook. You shall hear dial tone from the handset;
  - Press the configured Speed Dial key.
  
- **Call Return.** Dial the last answered call.
  - Go to GXP1100/GXP1105 **Web GUI->Settings->Programmable Keys**, configure the Multi Purpose Key's Key Mode as Call Return. No Value has to be set on the Multi Purpose Key for Call Return;
  - Take handset off hook. You shall hear dial tone from the handset;
  - Press the configured Call Return key to dial out.



**Note:**

- After entering the number, the phone waits for the No Key Entry Timeout (Default timeout is 4 seconds, configurable via Web GUI) before dialing out. Press SEND or # key to override the No Key Entry Timeout;
- If digits have been entered after handset is off hook, the SEND key will work as SEND instead of REDIAL;
- By default, # can be used as SEND to dial the number out. Users could disable it by setting "User # as Dial Key" to "No" from Web GUI->Account->Call Settings.

## MAKING CALLS USING IP ADDRESSES

Direct IP Call allows two phones to talk to each other in an ad-hoc fashion without a SIP proxy. VoIP calls can be made between two phones if:

- Both phones have public IP addresses; or
- Both phones are on the same LAN/VPN using private or public IP addresses; or
- Both phones can be connected through a router using public or private IP addresses (with necessary port forwarding or DMZ).

To make a direct IP call, please follow the steps below:

- Take handset off hook. You shall hear dial tone from the handset;
- Press \*\*\* to enter the GXP1100/GXP1105 IVR menu;
- Enter 47 for Direct IP Call. After hearing "Direct IP Calling", the dial tone will be heard again;
- Enter the target IP address to dial (Please see example below).

**For example:**

If the target IP address is 192.168.1.60 and the port is 5062 (i.e., 192.168.1.60:5062), input the following: 192\*168\*1\*60#5062. The \* key represents the dot (.), the # key represents colon (:). Wait for about 4 seconds and the phone will initiate the call.

**Quick IP Call Mode:**

The GXP1100/GXP1105 also supports Quick IP Call mode. This enables the phone to make direct IP calls using only the last few digits (last octet) of the target phone's IP address. This is possible only if both

phones are under the same LAN/VPN. This simulates a PBX function using the CSMA/CD without a SIP server. Controlled static IP usage is recommended.

To enable Quick IP Call Mode, go to GXP1100/GXP1105 Web GUI->Settings->Call Features, set "Use Quick IP Call Mode" to "Yes". Then take the handset off hook and dial #xxx where x is 0-9 and xxx<255. Press # or SEND and a direct IP call to aaa.bbb.ccc.XXX will be completed. "aaa.bbb.ccc" is from the local IP address regardless of subnet mask. The number #xx or #x are also valid. The leading 0 is not required (but it's OK).

**For example:**

- 192.168.0.2 calling 192.168.0.3 -- dial #3 followed by # or "SEND";
- 192.168.0.2 calling 192.168.0.23 -- dial #23 followed by # "SEND";
- 192.168.0.2 calling 192.168.0.123 -- dial #123 followed by # "SEND";
- 192.168.0.2: dial #3 and #03 and #003 results in the same call -- call 192.168.0.3.

**Note:**

- The # will represent colon ":" in direct IP call rather than SEND key as in normal phone call;
- If you have a SIP server configured, direct IP call still works. If you are using STUN, direct IP call will also use STUN;
- Configure the "User Random Port" to "No" when completing direct IP calls.

## ANSWERING PHONE CALLS

### RECEIVING CALLS

- **Single incoming call.** Phone rings with selected ring tone. Answer call by taking handset off hook;
- **Multiple incoming calls.** When another call comes in while having an active call, the phone will produce a Call Waiting tone (stutter tone). Answer the incoming call by pressing the FLASH key. The current active call will be put on hold.

## DURING A PHONE CALL

### CALL WAITING/CALL HOLD

- **Hold.** Place a call on hold by pressing the HOLD key;
- **Resume.** Press the HOLD key again to resume;

- **Multiple calls.** Automatically place active call on hold or switch between two calls by pressing the FLASH key. Call waiting tone (stutter tone) will be audible when the line is in use.

**Note:**

If users hang up the current call while there is a call on hold in the other line, there will be an audible ring tone indicating a call is on hold while your handset is put on hook. Pick up the handset so users can resume with the call on hold.

## MUTE

During an active call, press the MUTE key to mute/unmute the microphone.

## CALL TRANSFER

GXP1100/GXP1105 supports Blind Transfer, Attended Transfer and Auto-Attended Transfer.

- **Blind Transfer.**
  - During the first active call, press TRAN key and dial the number to transfer to;
  - Press SEND key or # to complete transfer of active call.
- **Attended Transfer.**
  - During the first active call, press FLASH key. The first call will be put on hold;
  - Enter the number for the second call and establish the call;
  - Press TRAN key;
  - Press FLASH key to transfer the call.
- **Auto-Attended Transfer.**
  - Set "Auto-Attended Transfer" to "Yes" under Web GUI->Settings->Call Features. And then click "Save and Apply" on the bottom of the page;
  - Establish one call first;
  - During the call, press TRAN key. A new line will be brought up and the first call will be automatically placed on hold;

- Enter the number and press SEND key or # to make a second call;
- Press TRAN key again. The call will be transferred.

**Note:**

- To transfer calls across SIP domains, SIP service providers must support transfer across SIP domains.
- When two lines are active, GXP110x can only do attended transfer because the phone supports at most two lines simultaneously.

### 3-WAY CONFERENCING

GXP1100/GXP1105 can host 3-way conference call (PCMU/PCMA) by using Multi Purpose Key or FLASH key.

- **To use Multi-Purpose Key to establish 3-way conference call**, go to GXP1100/GXP1105 Web GUI->Settings->Programmable Keys, configure the 3-way conference as the Multi Purpose Key mode. Click "Save and Apply" on the bottom of the page. Then follow the steps below for 3-way conferencing.

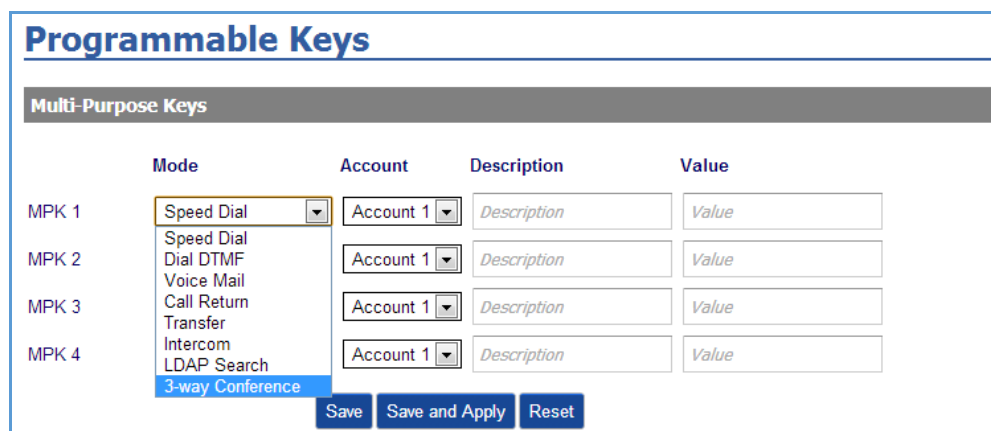

Programmable Keys				
Multi-Purpose Keys				
	Mode	Account	Description	Value
MPK 1	Speed Dial	Account 1	Description	Value
MPK 2	Speed Dial	Account 1	Description	Value
MPK 3	Dial DTMF	Account 1	Description	Value
MPK 4	Voice Mail	Account 1	Description	Value
	Call Return	Account 1	Description	Value
	Transfer	Account 1	Description	Value
	Intercom	Account 1	Description	Value
	LDAP Search	Account 1	Description	Value
	3-way Conference	Account 1	Description	Value

Save Save and Apply Reset

Figure 3: GXP1100/GXP1105 Multi Purpose Key - 3 way Conference

**1. Initiate a conference call.**

- Establish two active calls with two parties respectively;
- Press the Multi Purpose Key previously configured as "3-way Conference" in Web GUI;
- 3-way conference will be established.

## 2. Split call in conference.

- During the 3-way conference, press HOLD key. The conference call will be split and both calls will be put on hold separately;
- Press HOLD key again and it will resume the 2-way conversation with the line when establishing the conference call;
- Press FLASH key to toggle between the 2 lines;
- Users could re-establish conference call by pressing the Multi Purpose Key again.

## 3. End Conference.

- Press HOLD key to split the conference call. The conference call will be ended with both calls on hold; Or
- Users could simply hang up the call to terminate the conference call.

- **To use Flash key to establish 3-way conference call**, go to GXP1100/GXP1105 Web GUI->Settings->Call Features, set "Enable FLASH key as CONF" to "Yes". Click on "Save and Apply" on the bottom of the Web GUI page. Follow the steps below to host the 3-way conference.

### 1. Initiate a conference call.

- Initiate and establish two active calls with two parties from GXP1100/GXP1105;
- Press the FLASH Key;
- 3-way conference will be established.

### 2. Split call in conference.

- During the 3-way conference, press HOLD key. The conference call will be split and both calls will be put on hold separately;
- Press HOLD key again and it will resume the 2-way conversation with the line when establishing the conference call;
- Users could re-establish conference call by pressing the Multi-Purpose Key again.

### 3. End Conference.

- Press HOLD key to split the conference call. The conference call will be ended with both calls on hold; Or
- Users could simply hang up the call to terminate the conference call.

**Note:**

- The party that starts the conference call has to remain in the conference for its entire duration, you can put the party on mute but it must remain in the conversation. Also, this is not applicable when the feature "Transfer on Conference Hangup" is turned on.
- The option "Disable Conference" has to be set to "No" to establish conference on GXP110x.

## VOICE MESSAGES (MESSAGE WAITING INDICATOR)

A blinking red MWI (Message Waiting Indicator) indicates a message is waiting. Dial into the voicemail box to retrieve the message by entering the voice mail number of the server or pressing the MSG key (Voice Mail User ID has to be properly configured as the voice mail number under Web GUI->Account->General Settings page). An IVR will prompt the user through the process of message retrieval.

**Note:**

- Users can press \*\*\* to the IVR menu and then enter 86 to hear the number of new voice messages.
- When the feature "Blink message LED on ringing" is enabled, the message LED will blink for both incoming call and new messages in mailbox.

## CALL FEATURES

The GXP1100/GXP1105 supports traditional and advanced telephony features including caller ID, caller ID with caller Name, call forward and etc.

**Table 5: CALL FEATURES**

<b>*30</b>	<p><b>Block Caller ID</b> (for all subsequent calls)</p> <ul style="list-style-type: none"> <li>• Off hook the phone;</li> <li>• Dial *30.</li> </ul>
<b>*31</b>	<p><b>Send Caller ID</b> (for all subsequent calls)</p> <ul style="list-style-type: none"> <li>• Off hook the phone;</li> <li>• Dial *31.</li> </ul>
<b>*67</b>	<p><b>Block Caller ID</b> (per call)</p> <ul style="list-style-type: none"> <li>• Off hook the phone;</li> <li>• Dial *67 and then enter the number to dial out.</li> </ul>
<b>*82</b>	<p><b>Send Caller ID</b> (per call)</p>

	<ul style="list-style-type: none"> <li>• Off hook the phone;</li> <li>• Dial *82 and then enter the number to dial out.</li> </ul>
<b>*70</b>	<p><b>Disable Call Waiting (per Call)</b></p> <ul style="list-style-type: none"> <li>• Off hook the phone;</li> <li>• Dial *70 and then enter the number to dial out.</li> </ul>
<b>*71</b>	<p><b>Enable Call Waiting (per Call)</b></p> <ul style="list-style-type: none"> <li>• Off hook the phone;</li> <li>• Dial *71 and then enter the number to dial out.</li> </ul>
<b>*72</b>	<p><b>Unconditional Call Forward.</b> To set up unconditional call forward:</p> <ul style="list-style-type: none"> <li>• Pick up the handset;</li> <li>• Dial *72. A dial tone will be heard;</li> <li>• Enter the forwarding number;</li> <li>• Press # or SEND key;</li> <li>• The call will hang up automatically with unconditional call forward set up.</li> </ul>
<b>*73</b>	<p><b>Cancel Unconditional Call Forward.</b> To cancel the unconditional call forward:</p> <ul style="list-style-type: none"> <li>• Pick up the handset;</li> <li>• Dial *73. A short tone will be heard;</li> <li>• Wait for the call to hang up. The unconditional call forward is cancelled.</li> </ul>
<b>*90</b>	<p><b>Busy Call Forward.</b> To set up busy call forward:</p> <ul style="list-style-type: none"> <li>• Pick up the handset;</li> <li>• Dial *90 followed by forwarding number;</li> <li>• Press # or SEND key;</li> <li>• The call will hang up automatically with busy call forward set up.</li> </ul>
<b>*91</b>	<p><b>Cancel Busy Call Forward.</b> To cancel the busy call forward:</p> <ul style="list-style-type: none"> <li>• Pick up the handset;</li> <li>• Dial *91. A short tone will be heard;</li> <li>• Wait for the call to hang up. The busy call forward is cancelled.</li> </ul>
<b>*92</b>	<p><b>Delayed Call Forward.</b> To set up delayed call forward:</p> <ul style="list-style-type: none"> <li>• Pick up the handset;</li> <li>• Dial *92 followed by forwarding number;</li> <li>• Press # or SEND key;</li> </ul>

	<ul style="list-style-type: none"><li>• The call will hang up automatically with delayed call forward set up.</li></ul>
<b>*93</b>	<p><b>Cancel Delayed Call Forward.</b> To cancel the delayed call forward:</p> <ul style="list-style-type: none"><li>• Pick up the handset;</li><li>• Dial *93. A short tone will be heard;</li><li>• Wait for the call to hang up. The delayed call forward is cancelled.</li></ul>



## CONFIGURATION GUIDE

The GXP1100/GXP1105 can be configured via two ways:

- IVR Menu using the phone's keypad;
- Web GUI embedded on the phone using PC's web browser.

### CONFIGURATION VIA IVR MENU

GXP1100/GXP1105 has a built-in voice prompt menu for simple device configuration. Pick up the handset and dial \*\*\* to use the IVR menu.

Table 6: GXP1100/GXP1105 IVR MENU

Menu	Voice Prompt	Options
<b>Main Menu</b>	"Enter a Menu Option"	Press * for the next menu option. Press # to return to the main menu. Enter 01 – 05, 07, 10 - 17, 47, 86 or 99 for Menu option.
<b>01</b>	"DHCP Mode" "PPPoE Mode" "Static IP Mode"	Enter 9 to toggle the selection. If "Static IP Mode" is selected, users need configure all the IP address information through menu 02 to 05 as below. If "Dynamic IP Mode" is selected, the device will retrieve all IP address information from DHCP server automatically after user reboots the device.
<b>02</b>	"IP Address" + IP address	The current WAN IP address is announced. Enter 12-digit new IP address if in Static IP Mode.
<b>03</b>	"Subnet" + IP address	Same as Menu option 02.
<b>04</b>	"Gateway" + IP address	Same as Menu option 02.
<b>05</b>	"DNS Server" + IP address	Same as Menu option 02.
<b>07</b>	"Preferred Vocoder"	Enter 9 to go to the next selection in the list: <ul style="list-style-type: none"> <li>• PCMU</li> <li>• PCMA</li> <li>• iLBC</li> <li>• G-726</li> </ul>

		<ul style="list-style-type: none"> <li>• G-723</li> <li>• G-729</li> </ul>
<b>10</b>	"MAC Address"	Announces the MAC address of the unit.
<b>13</b>	"Firmware Server IP Address"	Announces current Firmware Server IP address. Enter 12 digit new IP address.
<b>14</b>	"Configuration Server IP Address"	Announces current Config Server Path IP address. Enter 12 digit new IP address.
<b>15</b>	"Upgrade Protocol"	Upgrade Protocol for firmware and configuration update. Enter 9 to toggle between <b>HTTP</b> , <b>TFTP</b> and <b>HTTPS</b> .
<b>16</b>	"Firmware Version"	Firmware version information.
<b>17</b>	"Firmware Upgrade"	Firmware upgrade mode. Enter 9 to toggle among the following three options: <ul style="list-style-type: none"> <li>• always check</li> <li>• check when pre/suffix changes</li> <li>• never upgrade</li> </ul>
<b>47</b>	"Direct IP Calling"	Enter the target IP address to make a direct IP call, after dial tone. (See <b>Make a Direct IP Call</b> section)
<b>86</b>	"Voice Mail"	Announces number of voice mails.
<b>99</b>	"RESET"	Enter MAC address to restore factory default setting. (See <b>Restore Factory Default Setting</b> section) Press <b>9</b> to reboot the device.
<b>Others</b>	"Invalid Entry"	Automatically returns to Main Menu.

## CONFIGURATION VIA WEB BROWSER

The GXP1100/GXP1105 embedded Web server responds to HTTP/HTTPS GET/POST requests. Embedded HTML pages allow a user to configure the IP phone through a Web browser such as Microsoft's IE, Mozilla Firefox and Google Chrome.

To access the GXP1100/GXP1105 Web GUI:

1. Connect the computer to the same network as the phone;
2. Make sure the phone is turned on and wait until the indicator on the top right corner turns from RED to OFF;
3. Take the handset off hook. Enter \*\*\* and then press 02 to hear the IP address;
4. Open a Web browser on your computer;

5. Enter the phone's IP address in the address bar of the browser;
6. Enter the administrator's login and password to access the Web Configuration Menu.

**Note:**

- The computer has to be connected to the same sub-network as the phone. This can be easily done by connecting the computer to the same hub or switch as the phone connected to. In absence of a hub/switch (or free ports on the hub/switch), please connect the computer directly to the PC port on the back of the phone;
- If the phone is properly connected to a working Internet connection, the IP address of the phone can be obtained from IVR Menu option 02. This address has the format: xxx.xxx.xxx.xxx, where xxx stands for a number from 0-255. Users will need this number to access the Web GUI. For example, if the phone has IP address 192.168.40.154, please enter "http://192.168.40.154" in the address bar of the browser;
- There are two default passwords for the login page:

User Level	Password	Web Pages Allowed
End User Level	123	Only Status and Basic Settings
Administrator Level	admin	Browse all pages

The password is case sensitive with maximum length of 25 characters.

- When changing any settings, always SUBMIT them by pressing the "Save" or "Save and Apply" button on the bottom of the page. If the change is saved only but not applied, after making all the changes, click on the "APPLY" button on top of the page to submit. After submitting the changes in all the Web GUI pages, reboot the phone to have the changes take effect if necessary (All the options under "Accounts" page and "Phonebook" page do not require reboot. Most of the options under "Settings" page do not require reboot).

## DEFINITIONS

This section describes the options in the GXP1100/GXP1105 Web GUI. As mentioned, you can log in as an administrator or an end user.

- **Status:** Displays the Account status, Network status, and System Info of the phone;
- **Account:** To configure the SIP account;
- **Network:** To configure network settings;
- **Settings:** To configure call features, ring tone, programmable keys and etc;
- **Maintenance:** To configure web access, upgrading and provisioning, language settings, TR-069, security and etc.

- **Phonebook:** To manage Phonebook and LDAP.

## STATUS PAGE DEFINITIONS

Status -> Account Status	
SIP User ID	Displays the configured SIP User ID.
SIP Server	Displays the configured SIP Server address.
SIP Registration	Displays SIP registration status YES/NO.
Status -> Network Status	
MAC Address	Global unique ID of device, in HEX format. The MAC address will be used for provisioning and can be found on the label coming with original box and on the label located on the back of the device.
IP Setting	DHCP, Static IP or PPPoE.
IPv4 Address	The IPv4 address obtained on the phone.
IPv6 Address	The IPv6 address obtained on the phone.
Subnet Mask	The subnet mask obtained on the phone.
Gateway	The gateway address obtained on the phone.
DNS Server 1	The DNS server address 1.
DNS Server 2	The DNS server address 2.
NTP Server	The NTP server phone uses to sync up time.
PPPoE Link Up	PPPoE connection status.
802.1q/802.1p(LLDP)	The 802.1q/802.p status.
802.1q/VLAN Tag	The assigned VLAN tag on phone.
802.1q Priority	The assigned 802.1q priority on phone.
NAT Traversal	NAT traversal status for each account.
Status -> System Info	
Product Model	Product model of the phone.
Part Number	Product part number.
Software Version	<ul style="list-style-type: none"> <li>• Boot: boot version number;</li> <li>• Core: core version number;</li> <li>• Base: base version number;</li> <li>• Prog: program version number. This is the main firmware release number, which is always used for identifying the software system of the phone;</li> </ul>

	<ul style="list-style-type: none"> <li>• Aux: Aux version number;</li> <li>• Dsp: DSP version number.</li> </ul>
System Up Time	System up time since the last reboot.
System Time	Current system time on the phone system.
Service Status	GUI and Phone service status.
Core Dump	Core dump file that could be downloaded for troubleshooting purpose.

## ACCOUNT PAGE DEFINITIONS

### Account 1 -> General Settings

Account Active	Activates/deactivates account. The default setting is "Yes".
Account Name	The name associated with the SIP account.
SIP Server	The URL or IP address, and port of the SIP server. This is provided by your VoIP service provider (ITSP).
Secondary SIP Server	The URL or IP address, and port of the SIP server. This will be used when the primary SIP server fails.
Outbound Proxy	IP address or Domain name of the Primary Outbound Proxy, Media Gateway, or Session Border Controller. It's used by the phone for Firewall or NAT penetration in different network environments. If a symmetric NAT is detected, STUN will not work and ONLY an Outbound Proxy can provide a solution.
SIP User ID	User account information, provided by your VoIP service provider (ITSP). It's usually in the form of digits similar to phone number or actually a phone number.
Authenticate ID	SIP service subscriber's Authenticate ID used for authentication. It can be identical to or different from the SIP User ID.
Authenticate Password	The account password required for the phone to authenticate with the ITSP (SIP) server before the account can be registered. After it is saved, this will appear as hidden for security purpose.
Name	The SIP server subscriber's name (optional) that will be used for Caller ID display.
Voice Mail User ID	Allows you to access voice messages by pressing the MESSAGE button on the phone. This ID is usually the VM portal access number. For example, in Asterisk server, 8500 could be used.

### Account 1 -> Network Settings

DNS Mode	This parameter controls how the Search Appliance looks up IP addresses for hostnames. There are four modes: A Record, SRV, NATPTR/SRV, Use
----------	--

	<p>Configured IP. The default setting is "A Record". If the user wishes to locate the server by DNS SRV, the user may select "SRV" or "NATPTR/SRV". If "Use Configured IP" is selected, please fill in the three fields below:</p> <ul style="list-style-type: none"> <li>• <b>Primary IP:</b> The primary IP address where the phone sends DNS query to;</li> <li>• <b>Backup IP 1;</b></li> <li>• <b>Backup IP 2.</b></li> </ul> <p>If SIP server is configured as domain name, phone will not send DNS query, but use "Primary IP" or "Backup IP x" to send SIP message if at least one of them are not empty. Phone will try to use "Primary IP" first. After 3 tries without any response, it will switch to "Backup IP x", and then it will switch back to "Primary IP" after 3 re-tries.</p> <p>If SIP server is already an IP address, phone will use it directly even "User Configured IP" is selected.</p>
NAT Traversal	<p>This parameter configures whether the NAT traversal mechanism is activated. Users could select the mechanism from No, STUN, Keep-Alive, UPnP, Auto or VPN. If set to "STUN" and STUN server is configured, the phone will route according to the STUN server. If NAT type is Full Cone, Restricted Cone or Port-Restricted Cone, the phone will try to use public IP addresses and port number in all the SIP&amp;SDP messages. The phone will send empty SDP packet to the SIP server periodically to keep the NAT port open if it is configured to be "Keep-Alive". Configure this to be "No" if an outbound proxy is used. "STUN" cannot be used if the detected NAT is symmetric NAT.</p>
Proxy-Require	<p>A SIP Extension to notify the SIP server that the phone is behind a NAT/Firewall. Do not configure this parameter unless this feature is supported on the SIP server.</p>
<b>Account 1 -&gt; SIP Settings -&gt; Basic Settings</b>	
TEL URI	<p>If the phone has an assigned PSTN telephone number, this field should be set to "User=Phone". Then a "User=Phone" parameter will be attached to the Request-Line and "TO" header in the SIP request to indicate the E.164 number. If set to "Enable", "Tel:" will be used instead of "SIP:" in the SIP request. The default setting is "Disable".</p>
SIP Registration	<p>Selects whether or not the phone will send SIP Register messages to the proxy/server. The default setting is "Yes".</p>
Unregister On Reboot	<p>If set to "Yes", the SIP user's registration information will be cleared when the phone reboots. The SIP Contact header will contain "*" to notify the server to unbind the connection. The default setting is "No".</p>
Register Expiration	<p>Specifies the frequency (in minutes) in which the phone refreshes its</p>

	registration with the specified registrar. The default value is 60 minutes. The maximum value is 64800 minutes (about 45 days).
Reregister Before Expiration	Specifies the time frequency (in seconds) that the phone sends re-registration request before the Register Expiration. The default value is 0.
Local SIP Port	Defines the local SIP port used to listen and transmit. The default value is 5060 for Account 1.
SIP Registration Failure Retry Wait Time	Specifies the interval to retry registration if the process is failed. The default value is 20 seconds.
SIP T1 Timeout	SIP T1 Timeout. The default setting is 0.5 seconds.
SIP T2 interval	SIP T2 Interval. The default setting is 4 seconds.
SIP Transport	Determines the network protocol used for the SIP transport. Users can choose from TCP, UDP and TLS.
SIP URI Scheme when using TLS	Specifies if "sip:" or "sips:" will be used when TLS/TCP is selected for SIP Transport. The default setting is "sips:".
Use Actual Ephemeral Port in Contact with TCP/TLS	This option is used to control the port information in the Via header and Contact header. If set to No, these port numbers will use the permanent listening port on the phone. Otherwise, they will use the ephemeral port for the particular connection.
Remove OBP from route	Configures to remove outbound proxy from route. This is used for the SIP Extension to notify the SIP server that the device is behind a NAT/Firewall.
Support SIP Instance ID	Defines whether SIP Instance ID is supported or not. The default setting is "Yes".
SUBSCRIBE for MWI	When set to "Yes", a SUBSCRIBE for Message Waiting Indication will be sent periodically. The phone supports synchronized and non-synchronized MWI. The default setting is "No".
SUBSCRIBE for Registration	When set to "Yes", a SUBSCRIBE for Registration will be sent out periodically. The default setting is "No".
Enable 100rel	The use of the PRACK (Provisional Acknowledgment) method enables reliability to SIP provisional responses (1xx series). This is very important in order to support PSTN internetworking. To invoke a reliable provisional response, the 100rel tag is appended to the value of the required header of the initial signaling messages.
Caller ID Display	When set to "Auto", the phone will look for the caller ID in the order of P-Asserted Identity Header, Remote-Party-ID Header and From Header in the incoming SIP INVITE. When set to "Disabled", all incoming calls are displayed with "Unavailable". When set to "From Header", the phone will display the caller ID based on the From Header in the incoming SIP INVITE. The default

	setting is "Auto".
Use Privacy Header	Controls whether the Privacy Header will present in the SIP INVITE message or not. The default setting is "default": the Privacy Header will show in INVITE unless "Huawei IMS" special feature is on. If set to "Yes", the Privacy Header will always show in INVITE. If set to "No", the Privacy Header will not show in INVITE.
Use P-Preferred-Identity Header	Controls whether the P-Preferred-Identity Header will present in the SIP INVITE message or not. The default setting is "default": the P-Preferred-Identity Header will show in INVITE unless "Huawei IMS" special feature is on. If set to "Yes", the P-Preferred-Identity Header will always show in INVITE. If set to "No", the P-Preferred-Identity Header will not show in INVITE.
<b>Account 1 -&gt; SIP Settings -&gt; Advanced Features</b>	
Conference URI	Configures the Conference URI when using Broadsoft N-way calling feature.
Music On Hold URI	Configures Music On Hold URI to call when a call is on hold. This feature has to be supported on the server side.
Special Feature	Different soft switch vendors have special requirements. Therefore users may need select special features to meet these requirements. Users can choose from Standard, Nortel MCS, Broadsoft, CBCOM, RNK, Sylanro or Huawei IMS depending on the server type. The default setting is "Standard".
<b>Account 1 -&gt; SIP Settings -&gt; Session Timer</b>	
Session Expiration	The SIP Session Timer extension that enables SIP sessions to be periodically "refreshed" via a SIP request (UPDATE, or re-INVITE). If there is no refresh via an UPDATE or re-INVITE message, the session will be terminated once the session interval expires. Session Expiration is the time (in seconds) where the session is considered timed out, provided no successful session refresh transaction occurs beforehand. The default value is 180 seconds.
Min-SE	The minimum session expiration (in seconds). The default value is 90 seconds.
Caller Request Timer	If set to "Yes" and the remote party supports session timers, the phone will use a session timer when it makes outbound calls.
Callee Request Timer	If set to "Yes" and the remote party supports session timers, the phone will use a session timer when it receives inbound calls.
Force Timer	If Force Timer is set to "Yes", the phone will use the session timer even if the remote party does not support this feature. If Force Timer is set to "No", the phone will enable the session timer only when the remote party supports this feature. To turn off the session timer, select "No".



UAC Specify Refresher	As a Caller, select UAC to use the phone as the refresher; or select UAS to use the Callee or proxy server as the refresher.
UAS Specify Refresher	As a Callee, select UAC to use caller or proxy server as the refresher; or select UAS to use the phone as the refresher.
Force INVITE	The Session Timer can be refreshed using the INVITE method or the UPDATE method. Select "Yes" to use the INVITE method to refresh the session timer.
<b>Account 1 -&gt; SIP Settings -&gt; Security Settings</b>	
Check Domain Certificates	Choose whether the domain certificates will be checked or not when TLS/TCP is used for SIP Transport. The default setting is "No".
Validate Incoming Messages	Choose whether the incoming messages will be validated or not. The default setting is "No".
Check SIP User ID for incoming INVITE	If set to "Yes", SIP User ID will be checked in the Request URI of the incoming INVITE. If it doesn't match the phone's SIP User ID, the call will be rejected. The default setting is "No".
Accept Incoming SIP from Proxy Only	When set to "Yes", the SIP address of the Request URL in the incoming SIP message will be checked. If it doesn't match the SIP server address of the account, the call will be rejected. The default setting is "No".
Authenticate Incoming INVITE	If set to "Yes", the phone will challenge the incoming INVITE for authentication with SIP 401 Unauthorized response. The default setting is "No".
<b>Account 1 -&gt; Audio Settings</b>	
Send DTMF	Specifies the mechanism to transmit DTMF digits. There are 3 supported modes: in audio which means DTMF is combined in the audio signal (not very reliable with low-bit-rate codecs), via RTP (RFC2833), or via SIP INFO.
DTMF Payload Type	Configures the payload type for DTMF using RFC2833. The default value is 101.
Preferred Vocoder	7 different vocoder types are supported on the phone, including G.711 U-law (PCMU), G.711 A-law (PCMA), G.723.1, G.729A/B, G.722 (wide band), iLBC and G72-32. Users can configure vocoders in a preference list that is included with the same preference order in SDP message.
Use First Matching Vocoder in 200OK SDP	When set to "Yes", the device will use the first matching vocoder in the received 200OK SDP as the codec. The default setting is "No".
SRTP Mode	Enables the SRTP mode based on your selection. The default setting is "Disabled".
Crypto Life Time	Choose whether to include the lifetime parameter in SRTP crypto offer.
Symmetric RTP	Defines whether symmetric RTP is supported or not. The default setting is "No".

Silence Suppression	Controls the silence suppression/VAD feature of the audio codec G.723 and G.729. If set to "Yes", when silence is detected, a small quantity of VAD packets (instead of audio packets) will be sent during the period of no talking. If set to "No", this feature is disabled. The default setting is "No".
Voice Frames Per TX	Configures the number of voice frames transmitted per packet. When configuring this, it should be noted that the "ptime" value for the SDP will change with different configurations here. This value is related to the codec used and the actual frames transmitted during the in payload call. For end users, it is recommended to use the default setting, as incorrect settings may influence the audio quality.
G723 Rate	Selects encoding rate for G723 codec. The default value is 5.3kbps.
G.726-32 Packing Mode	Selects "ITU" or "IETF" for G726-32 packing mode.
iLBC Frame Size	Selects iLBC packet frame size. The default value is 30ms.
iLBC Payload Type	Specifies iLBC Payload type. The default value is 97. The valid range is between 96 and 127.
Jitter Buffer Type	Selects either Fixed or Adaptive based on network conditions. The default setting is "Adaptive".
Jitter Buffer Length	Selects Low, Medium, or High based on network conditions. The default setting is "Medium".

### Account 1 -> Call Settings

Early Dial	Selects whether or not to enable early dial. If it's set to "Yes", the SIP proxy must support 484 response. The default setting is "No".
Dial Plan Prefix	Sets the prefix added to each dialed number.
Dial Plan	<p>A dial plan establishes the expected number and pattern of digits for a telephone number. This parameter configures the allowed dial plan for the phone.</p> <p>Dial Plan Rules:</p> <ol style="list-style-type: none"> <li>1. Accepted Digits: 1,2,3,4,5,6,7,8,9,0 , * , #, A,a,B,b,C,c,D,d;</li> <li>2. Grammar: x - any digit from 0-9; <ol style="list-style-type: none"> <li>a) xx+ - at least 2 digit numbers</li> <li>b) xx. - only 2 digit numbers</li> <li>c) ^ - exclude</li> <li>d) [3-5] - any digit of 3, 4, or 5</li> <li>e) [147] - any digit of 1, 4, or 7</li> <li>f) &lt;2=011&gt; - replace digit 2 with 011 when dialing</li> <li>g)   - the OR operand</li> </ol> </li> </ol>

	<ul style="list-style-type: none"> <li>• Example 1: {[369]11   1617xxxxxx}</li> </ul> <p>Allow 311, 611, and 911 or any 10 digit numbers with leading digits 1617;</p> <ul style="list-style-type: none"> <li>• Example 2: {^1900x+   &lt;=1617&gt;xxxxxxx}</li> </ul> <p>Block any number of leading digits 1900 or add prefix 1617 for any dialed 7 digit numbers;</p> <ul style="list-style-type: none"> <li>• Example 3: {1xxx[2-9]xxxxxx   &lt;2=011&gt;x+}</li> </ul> <p>Allows any number with leading digit 1 followed by a 3 digit number, followed by any number between 2 and 9, followed by any 7 digit number OR Allows any length of numbers with leading digit 2, replacing the 2 with 011 when dialed.</p> <p>Example of a simple dial plan used in a Home/Office in the US: { ^1900x.   &lt;=1617&gt;[2-9]xxxxxx   1[2-9]xx[2-9]xxxxxx   011[2-9]x.   [3469]11 }</p> <p>Explanation of example rule (reading from left to right):</p> <ul style="list-style-type: none"> <li>• ^1900x. - prevents dialing any number started with 1900;</li> <li>• &lt;=1617&gt;[2-9]xxxxxx - allows dialing to local area code (617) numbers by dialing 7 numbers and 1617 area code will be added automatically;</li> <li>• 1[2-9]xx[2-9]xxxxxx  - allows dialing to any US/Canada Number with 11 digits length;</li> <li>• 011[2-9]x - allows international calls starting with 011;</li> <li>• [3469]11 - allows dialing special and emergency numbers 311, 411, 611 and 911.</li> </ul> <p><b>Note:</b> In some cases where the user wishes to dial strings such as *123 to activate voice mail or other applications provided by their service provider, the * should be predefined inside the dial plan feature. An example dial plan will be: { *x+ } which allows the user to dial * followed by any length of numbers.</p>
Delayed Call Forward Wait Time	Defines the timeout (in seconds) before the call is forwarded on no answer. The default value is 20 seconds.
Enable Call Features	The default setting is "Yes". When enabled, call features using star codes will be supported locally.
Call Log	Configures Call Log setting on the phone. You can log all calls, only log incoming/outgoing calls or disable call log. The default setting is "Log All Calls".

Account Ring Tone	Allows users to configure the ringtone for the account. Users can choose from different ringtones from the dropdown menu.
Matching Incoming Caller ID	<p>Specifies matching rules with number, pattern or Alert Info text. When the incoming caller ID or Alert Info matches the rule, the phone will ring with selected distinctive ringtone. Matching rules:</p> <ul style="list-style-type: none"> <li>• Specific caller ID number. For example, 8321123;</li> <li>• A defined pattern with certain length using <b>x</b> and <b>+</b> to specify, where <b>x</b> could be any digit from 0 to 9. Samples:  <b>xx+</b> : at least 2-digit number;  <b>xx</b> : only 2-digit number;  <b>[345]xx</b>: 3-digit number with the leading digit of 3, 4 or 5;  <b>[6-9]xx</b>: 3-digit number with the leading digit from 6 to 9.</li> <li>• Alert Info text  Users could configure the matching rule as certain text (e.g., priority) and select the custom ring tone mapped to it. The custom ring tone will be used if the phone receives SIP INVITE with Alert-Info header in the following format:  Alert-Info: &lt;http://127.0.0.1&gt;; info=priority</li> </ul> <p>Selects the distinctive ring tone for the matching rule. When the incoming caller ID or Alert Info matches the rule, the phone will ring with the selected ring.</p>
Ring Timeout	Defines the timeout (in seconds) for the rings on no answer. The default setting is 60 seconds.
Send Anonymous	If set to "Yes", the "From" header in outgoing INVITE messages will be set to anonymous, essentially blocking the Caller ID to be displayed.
Anonymous Call Rejection	If set to "Yes", anonymous calls will be rejected. The default setting is "No".
Allow Auto Answer by Call-Info	If set to "Yes", the phone will automatically turn on the speaker phone to answer incoming calls after a short reminding beep, based on the SIP info header sent from the server/proxy. The default setting is "No".
Refer-To Use Target Contact	If set to "Yes", the "Refer-To" header uses the transferred target's Contact header information for attended transfer. The default setting is "No".
Transfer on Conference Hangup	Defines whether or not the call is transferred to the other party if the initiator of the conference hangs up. The default setting is "No".
No Key Entry Timeout (s)	Defines the timeout (in seconds) for no key entry. If no key is pressed after the timeout, the digits will be sent out. The default value is 4 seconds.
Use # as Dial Key	Allows users to configure the "#" key as the "Send" key. If set to "Yes", the "#"

	key will immediately dial out the input digits. In this case, this key is essentially equivalent to the "Send" key. If set to "No", the "#" key is included as part of the dialing string.
Hold Method	Specifies Hold method to Auto or RFC3264. Auto is to satisfy both rfc3264 and rfc2xxx for the maximum capability.

## SETTINGS PAGE DEFINITIONS

### Settings -> General Settings

Local RTP Port	This parameter defines the local RTP port used to listen and transmit. It is the base RTP port for channel 0. When configured, channel 0 will use this port _value for RTP; channel 1 will use port_value+2 for RTP. Local RTP port ranges from 1024 to 65400 and must be even. The default value is 5004.
Use Random Port	When set to "Yes", this parameter will force random generation of both the local SIP and RTP ports. This is usually necessary when multiple phones are behind the same full cone NAT. The default setting is "Yes" (This parameter must be set to "No" for Direct IP Calling to work).
Keep-alive Interval	Specifies how often the phone sends a blank UDP packet to the SIP server in order to keep the "ping hole" on the NAT router to open. The default setting is 20 seconds.
Use NAT IP	The NAT IP address used in SIP/SDP messages. This field is blank at the default settings. It should ONLY be used if it's required by your ITSP.
STUN Server	The IP address or Domain name of the STUN server. STUN resolution results are displayed in the STATUS page of the Web GUI. Only non-symmetric NAT routers work with STUN.

### Settings -> Call Features

Off-hook Auto Dial	Configures a User ID/extension to dial automatically when the phone is off hook. The phone will use the first account to dial out. The default setting is "No".
Off-hook Timeout	If configured, when the phone is on hook, it will go off hook after the timeout (in seconds). The default value is 30 seconds.
Disable Call Waiting	Disables the call waiting feature. The default setting is "No".
Disable Call Waiting Tone	Disables the call waiting tone when call waiting is on. The default setting is "No".
Disable Direct IP Call	Disables Direct IP Call. The default setting is "No".
Use Quick IP Call mode	When set to "Yes", users can dial an IP address under the same

	LAN/VPN segment by entering the last octet in the IP address. To dial quick IP call, off hook the phone and dial #XXX (X is 0-9 and XXX <=255), phone will make direct IP call to aaa.bbb.ccc.XXX where aaa.bbb.ccc comes from the local IP address REGARDLESS of subnet mask. #XX or #X are also valid so leading 0 is not required (but OK). No SIP server is required to make quick IP call. The default setting is "No".
Disable Conference	Disables the Conference function. The default setting is "No".
Enable sending DTMF via Speed Dial	Enables Multi Purpose Key to send DTMF during the call. The default setting is "No".
Enable Idle Mute	If this feature is enabled, MUTE key will take effect in idle state and future incoming call will be answered with mute.
Disable Transfer	Disables the Transfer function. The default setting is "No".
In-call dial number on pressing transfer key	Configures the number for the phone to dial as DTMF during the call using TRAN button.
Auto-Attended Transfer	If set to "Yes", the phone will use attended transfer by default. The default setting is "No".
Do Not Escape # as %23 in SIP URI	Specifies whether to replace # by %23 or not for some special situations. The default setting is "No".
Click-To-Dial Feature	Enables Click-To-Dial feature. The default setting is "Disabled".
Blink message LED on ringing	Message LED light will blink if there is an incoming call.
Call History Flash Writing: Write Timeout	Defines the interval (in seconds) to save the call history to phone's flash. The default value is 300 seconds.
Call History Flash Writing: Max Unsaved Log	Defines the number of unsaved logs before written to phone's flash. The default value is 200 entries.
Enable FLASH Key as CONF	If set to "Yes", the FLASH key can be used to establish 3-way conference. The default setting is "No".

### Settings -> Ring Tone

<p>Call Progresses Tones:</p> <ul style="list-style-type: none"> <li>System Ring Tone</li> <li>Dial Tone</li> <li>Second Dial Tone</li> <li>Message Waiting</li> <li>Ring Back Tone</li> <li>Call-Waiting Tone</li> <li>Busy Tone</li> <li>Reorder Tone</li> </ul>	<p>Configures ring or tone frequencies based on parameters from local telecom. The default value is North American standard. Frequencies should be configured with known values to avoid uncomfortable high pitch sounds.</p> <p><b>Syntax:</b> f1=val,f2=val[,c=on1/off1[-on2/off2[-on3/off3]]]; (Frequencies are in Hz and cadence on and off are in 10ms)</p> <p>ON is the period of ringing ("On time" in 'ms') while OFF is the period of silence. In order to set a continuous ring, OFF should be zero. Otherwise it will ring ON ms and a pause of OFF ms and then repeat the pattern. Up</p>
--	---

	to three cadences are supported.
Call Waiting Tone Gain	Configures the call waiting tone gain to adjust call waiting tone volume. The default setting is "Low".

### Settings -> Audio Control

Handset TX gain	Configures the transmission gain of the handset. The default value is 0 dB.
-----------------	---

### Settings -> Programmable Keys

Multi Purpose Keys X	<p>Assigns a function to the corresponding Multi Purpose Key. The key mode options are:</p> <ul style="list-style-type: none"> <li>• Speed Dial Enter the Speed Dial number in Value field to be dialed.</li> <li>• Dial DTMF Enter a series of DTMF digits in the Value field to be dialed during the call. "Enable MPK Sending DTMF" has to be set to "Yes" first.</li> <li>• Voice Mail Enter the Voice Mail access number in the Value field.</li> <li>• Call Return The last answered calls can be dialed out by using Call Return. The Value field should be left blank.</li> <li>• Transfer Enter the number in the value field to be transferred (blind transfer) during the call.</li> <li>• Intercom Enter the extension number in the value field to do the intercom.</li> <li>• 3-way Conference To establish 3-way conference.</li> </ul>
----------------------	--

## NETWORK PAGE DEFINITIONS

### Network -> Basic Settings

Internet Protocol	Selects Prefer IPv4 or Prefer IPv6.
IPv4 Address Type	Allows users to configure the appropriate network settings on the phone to obtain IPv4 address. Users could select "DHCP", "Static IP" or "PPPoE". By default, it is set to "DHCP".
DHCP Host name (Option 12)	Specifies the name of the client. This field is optional but may be required by some Internet Service Providers.
DHCP Vendor Class ID (Option 60)	Used by clients and servers to exchange vendor class ID.

PPPoE Account ID	Enter the PPPoE account ID.
PPPoE Password	Enter the PPPoE Password.
PPPoE Service Name	Enter the PPPoE Service Name.
IPv4 Address	Enter the IP address when static IP is used.
Subnet Mask	Enter the Subnet Mask when static IP is used for IPv4.
Gateway	Enter the Default Gateway when static IP is used for IPv4.
DNS Server 1	Enter the DNS Server 1 when static IP is used for IPv4.
DNS Server 2	Enter the DNS Server 2 when static IP is used for IPv4.
Preferred DNS Server	Enter the Preferred DNS Server for IPv4.
IPv6 Address Type	Allows users to configure the appropriate network settings on the phone to obtain IPv6 address. Users could select "Auto-configured" or "Statically configured" for the IPv6 address type.
Static IPv6 Address	Enter the static IPv6 address when Full Static is used in "Statically configured" IPv6 address type.
IPv6 Prefix Length	Enter the IPv6 prefix length when Full Static is used in "Statically configured" IPv6 address type.
IPv6 Prefix	Enter the IPv6 Prefix (64 bits) when Prefix Static is used in "Statically configured" IPv6 address type.
DNS Server 1	Enter the DNS Server 1 for IPv6.
DNS Server 2	Enter the DNS Server 2 for IPv6.
Preferred DNS server	Enter the Preferred DNS Server for IPv6.
<b>Network -&gt; Advanced Settings</b>	
802.1X mode	Allows the user to enable/disable 802.1X mode on the phone. The default value is disabled. To enable 802.1X mode, this field should be set to EAP-MD5.
802.1X Identity	Enter the Identity for the 802.1X mode.
MD5 Password	Enter the MD5 Password for the 802.1X mode.
802.1X CA Certificate	Upload 802.1X CA certificate to the phone; or delete existed 802.1X CA certificate from the phone.
802.1X Client Certificate	Upload 802.1X Client certificate to the phone; or delete existed 802.1X Client certificate from the phone.
HTTP Proxy	Specifies the HTTP proxy URL for the phone to send packets to. The proxy server will act as an intermediary to route the packets to the destination.
HTTPS Proxy	Specifies the HTTPS proxy URL for the phone to send packets to. The proxy server will act as an intermediary to route the packets to the destination.



Layer 3 QoS	Defines the Layer 3 QoS parameter. This value is used for IP Precedence, Diff-Serv or MPLS. The default value is 12.
Layer 2 QoS 802.1Q/VLAN Tag	Assigns the VLAN Tag of the Layer 2 QoS packets. The default value is 0.
Layer 2 QoS 802.1p Priority Value	Assigns the priority value of the Layer2 QoS packets. The default value is 0.
PC Port Mode	Configures the PC port mode. When set to "Mirrored", the traffic in the LAN port will go through PC port as well and packets can be captured by connecting a PC to the PC port. The default setting is "Enable".
Enabled LLDP	Control the LLDP service.

## MAINTENANCE PAGE DEFINITIONS

### Maintenance -> Web Access

End User Password	Allows the administrator to set the password for user-level web GUI access. This field is case sensitive with a maximum length of 30 characters.
Confirm Password	Confirms the end user password field to be the same as above.
Admin Password	Allows users to change the admin password. The password field is purposely hidden for security purpose. This field is case sensitive with a maximum length of 30 characters.
Confirm Password	Confirms the admin password field to be the same as above.

### Maintenance -> Upgrade and Provisioning

Firmware Upgrade and Provisioning	Specifies how firmware upgrading and provisioning request to be sent: Always Check for New Firmware, Check New Firmware only when F/W pre/suffix changes, Always Skip the Firmware Check.
XML Config File Password	The password for encrypting the XML configuration file using OpenSSL. This is required for the phone to decrypt the encrypted XML configuration file.
HTTP/HTTPS User Name	The user name for the HTTP/HTTPS server.
HTTP/HTTPS Password	The password for the HTTP/HTTPS server.
Upgrade Via	Allows users to choose the firmware upgrade method: TFTP, HTTP or HTTPS.
Firmware Server Path	Defines the server path for the firmware server. It could be different from the configuration server for provisioning.
Config Server Path	Defines the server path for provisioning. It could be different from the firmware server for upgrading.
Firmware File Prefix	This field enables user to store different versions of firmware files in one single

	directory on the firmware server. If configured, only the firmware file with the matching prefix will be downloaded.
Firmware File Postfix	This field enables user to store different versions of firmware files in one single directory on the firmware server. If configured, only the firmware file with the matching postfix will be downloaded.
Config File Prefix	This field enables user to store different configuration files in one single directory on the configuration server. If configured, only the configuration file with the matching prefix will be downloaded.
Config File Postfix	This field enables user to store different configuration files in one single directory on the configuration server. If configured, only the configuration file with the matching postfix will be downloaded.
Allow DHCP Option 43 and Option 66 Override Server	Default setting is "Yes". DHCP option 66 originally was only designed for TFTP server. Later on it was extended to support an HTTP URL. GXP phones support both TFTP and HTTP server via option 66. Users can also use DHCP option 43 vendor specific option to do this. DHCP option 43 approach has priorities.
Allow DHCP Option 120 to override SIP Server	Enables DHCP Option 120 from local server to override the SIP Server on the phone. The default setting is "No".
3CX Auto Provision	Phone will multicast SUBSCRIBE for provision if this feature is enabled.
Automatic Upgrade	Enables automatic upgrade and provisioning. The default setting is "No".
Hour of the Day (0-23)	Defines the hour of the day to check the HTTP/TFTP server for firmware upgrades or configuration files changes. The default value is 1.
Day of the Week (0-6)	Defines the day of the week to check HTTP/TFTP server for firmware upgrades or configuration files changes. The default value is 1.
Authenticate Conf File	Authenticates configuration file before acceptance. The default setting is "No".
<b>Maintenance -&gt; Syslog</b>	
Syslog Server	The URL or IP address of the syslog server for the phone to send syslog to.
Syslog Level	<p>Selects the level of logging for syslog. The default setting is "None". There are 4 levels: DEBUG, INFO, WARNING AND ERROR.</p> <p>Syslog messages are sent based on the following events:</p> <ul style="list-style-type: none"> <li>• product model/version on boot up (INFO level);</li> <li>• NAT related info (INFO level);</li> <li>• sent or received SIP message (DEBUG level);</li> <li>• SIP message summary (INFO level);</li> <li>• inbound and outbound calls (INFO level);</li> <li>• registration status change (INFO level);</li> <li>• negotiated codec (INFO level);</li> </ul>

	<ul style="list-style-type: none"> <li>• ethernet link up (INFO level);</li> <li>• SLIC chip exception (WARNING and ERROR levels);</li> <li>• memory exception (ERROR level).</li> </ul>
Send SIP Log	Configures whether the SIP log will be included in the syslog messages or not. The default setting is "No".
Auto Recover From Abnormal	Configures whether auto recover or not when the phone is running abnormal. The default setting is "Yes".
<b>Maintenance -&gt; Language</b>	
Display Language	Selects display language on the phone.
Language File Postfix	Specifies the language file postfix for downloaded language.
<b>Maintenance -&gt; TR-069</b>	
Enable TR-069	Enables TR-069. The default setting is "No".
ACS URL	URL for TR-069 Auto Configuration Servers (ACS).
TR-069 Username	ACS username for TR-069.
TR-069 Password	ACS password for TR-069.
Periodic Inform Enable	Enables periodic inform. If set to "Yes", device will send inform packets to the ACS. The default setting is "No".
Periodic Inform Interval	Sets up the periodic inform interval to send the inform packets to the ACS.
Connection Request Username	The user name for the ACS to connect to the phone.
Connection Request Password	The password for the ACS to connect to the phone.
Connection Request Port	The port for the ACS to connect to the phone.
CPE SSL Certificate	The Cert File for the phone to connect to the ACS via SSL.
CPE SSL Private Key	The Cert Key for the phone to connect to the ACS via SSL.
<b>Maintenance -&gt; Security</b>	
SIP TLS Certificate	SSL Certificate used for SIP TLS Transport.
SIP TLS Private Key	SSL Private key used for SIP TLS Transport.
SIP TLS Private Key Password	SSL Private key password used for SIP TLS Transport.
Download Device Configuration	Click to download the device configuration file in .txt format.
Web Access Mode	Sets the protocol for web interface as HTTP or HTTPS. Default setting is HTTP.
Disable SSH	Disable SSH access. SSH is enabled by default.

## NAT SETTINGS

If the devices are kept within a private network behind a firewall, we recommend using STUN Server. The following settings are useful in the STUN Server scenario:

- **STUN Server**

Under **Settings->General Settings**, enter a STUN Server IP (or FQDN) that you may have, or look up a free public STUN Server on the internet and enter it on this field. If using Public IP, keep this field blank.



- **Use Random Ports**

It is under **Settings->General Settings**. This setting depends on your network settings. When set to "Yes", it will force random generation of both the local SIP and RTP ports. This is usually necessary when multiple GXPs are behind the same NAT. If using a Public IP address, set this parameter to "No".

- **NAT Traversal**

It is under **Accounts X->Network Settings**. Default setting is "No". Enable the device to use NAT traversal when it is behind firewall on a private network. Select Keep-Alive, Auto, STUN (with STUN server path configured too) or other option according to the network setting.

## CLICK-TO-DIAL

From GXP1100/GXP1105 Web GUI, users could dial out with Click-to-Dial feature  on the top menu of the Web GUI when the account is registered. Before using the Click-To-Dial feature, make sure the option "Click-To-Dial Feature" under web GUI->Settings->Call Features is turned on. By default it's disabled and the dialing icon in web GUI is in grey .

After clicking on the  icon, a new dialing window will show as the figure below. Enter number and click on "Dial", the phone will go off hook and dial out the number from account 1.

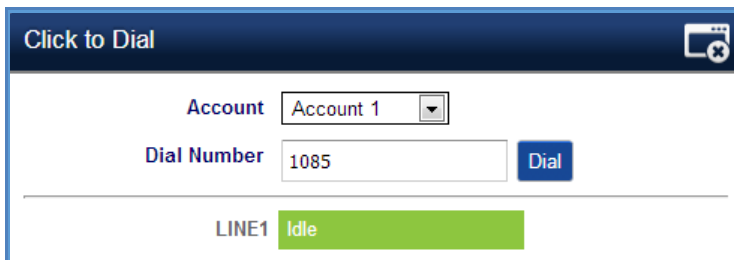

Figure 4: Click-to-Dial

Additionally, users could directly send the command for the phone to dial out by specifying the following URL in PC's web browser, or in the field as required in other call modules.

**[http://ip\\_address/cgi-bin/api-make\\_call?phonenumber=1234&account=0&password=admin/123](http://ip_address/cgi-bin/api-make_call?phonenumber=1234&account=0&password=admin/123)**

In the above link, replace the ***fields*** with

- ***ip\_address***:  
Phone's IP Address.
- ***phonenumber=1234***:  
The number for the phone to dial out
- ***account=0***:  
The account index for the phone to make call. The index is 0 for account 1, 1 for account 2, 2 for account 3, and etc.
- ***password=admin/123***:  
The admin login password or user login password of phone's Web GUI.

## SAVING THE CONFIGURATION CHANGES

After users makes changes to the configuration, press the "Save" button will save but not apply the changes until the "Apply" button on the top of web GUI page is clicked. Or, users could directly press "Save and Apply" button. We recommend rebooting or powering cycle the phone after applying all the changes.

## REBOOTING FROM REMOTE LOCATIONS

Press the "Reboot" button on the top right corner of the web GUI page to reboot the phone remotely. The web browser will then display a reboot message. Wait for about 1 minute to log in again.

## UPGRADING AND PROVISIONING

The GXP1100/GXP1105 can be upgraded via TFTP/HTTP/HTTPS by configuring the URL/IP Address for the TFTP/HTTP/HTTPS server and selecting a download method. Configure a valid URL for TFTP or HTTP; the server name can be FQDN or IP address.

### Examples of valid URLs:

firmware.grandstream.com

fw.ipvideotalk.com/gs

There are two ways to setup a software upgrade server: The IVR Menu or the Web Configuration Interface.

### UPGRADE VIA IVR MENU

Follow the steps below to configure the Upgrade Server IP address via IVR:

- Pick up the handset, press \*\*\* to access the IVR Menu;
- Input menu option 15 for "Upgrading Protocol". Then press 9 to toggle between different upgrading methods;
- Press # to return to the main menu and input menu option 13 for "Firmware Server IP Address";
- Input the 12-digit firmware upgrade IP address. For example, if the firmware upgrade IP address is 10.0.50.191, input 010000050191.

Then reboot the phone. The LED indicator on the top right corner will turn orange and red and then turn off which indicates the phone has restarted. After a while the indicator will blink in red meaning the download is in process. When upgrading is done you will see the phone restarts again. Please do not interrupt or power cycle the phone when the upgrading process is on.

### UPGRAGE VIA WEB GUI

Open a web browser on PC and enter the IP address of the phone. Then, login with the administrator username and password. Go to Maintenance->Upgrade and Provisioning page, enter the IP address or the FQDN for the upgrade server in "Firmware Server Path" field and choose to upgrade via TFTP or HTTP/HTTPS. Update the change by clicking the "Save and Apply" button. Then "Reboot" or power cycle the phone to update the new firmware.

The indicator on the top right corner will turn orange and red and then turn off which indicates the phone has restarted. After a while the indicator will blink in red meaning the download is in process. When download is done you will see the phone restarts again. Please do NOT disrupt or power down the unit. If a firmware upgrade fails for any reason (e.g., TFTP/HTTP server is not responding, there are no code image files available for upgrade, or checksum test fails, etc), the phone will stop the upgrading process and reboot using the existing firmware/software.

Firmware upgrades take around 60 seconds in a controlled LAN or 5-10 minutes over the Internet. We recommend completing firmware upgrades in a controlled LAN environment whenever possible.

## NO LOCAL TFTP/HTTP SERVERS

For users that would like to use remote upgrading without a local TFTP/HTTP server, Grandstream offers a NAT-friendly HTTP server. This enables users to download the latest software upgrades for their phone via this server. Please refer to the webpage:

<http://www.grandstream.com/support/firmware>.

Alternatively, users can download a free TFTP or HTTP server and conduct a local firmware upgrade. A free windows version TFTP server is available for download from:

[http://www.solarwinds.com/products/freetools/free\\_tftp\\_server.aspx](http://www.solarwinds.com/products/freetools/free_tftp_server.aspx)

<http://tftpd32.jounin.net/>.

Instructions for local firmware upgrade via TFTP:

1. Unzip the firmware files and put all of them in the root directory of the TFTP server;
2. Connect the PC running the TFTP server and the phone to the same LAN segment;
3. Launch the TFTP server and go to the File menu->Configure->Security to change the TFTP server's default setting from "Receive Only" to "Transmit Only" for the firmware upgrade;
4. Start the TFTP server and configure the TFTP server in the phone's web configuration interface;
5. Configure the Firmware Server Path to the IP address of the PC;
6. Update the changes and reboot the phone.

End users can also choose to download a free HTTP server from <http://httpd.apache.org/> or use Microsoft IIS web server.

### Note:

When the phone boots up, it will send a TFTP or HTTP request to download the configuration file "cfgxxxxxxxxxxxx" where "xxxxxxxxxxxx" is the MAC address of the phone. If it is a normal TFTP or HTTP upgrade, the following messages "TFTP Error from [IP ADDRESS] requesting cfg000b82023dd4: File does not exist. Configuration File Download" can be ignored in the TFTP/HTTP server log.

## CONFIGURATION FILE DOWNLOAD

Grandstream SIP Devices can be configured via the Web Interface as well as via a Configuration File (binary or XML) through TFTP or HTTP/HTTPS. The "Config Server Path" is the TFTP or HTTP/HTTPS server path for the configuration file. It needs to be set to a valid URL, either in FQDN or IP address format. The "Config Server Path" can be the same or different from the "Firmware Server Path".

A configuration parameter is associated with each particular field in the web configuration page. A parameter consists of a Capital letter P and 2 to 3 (Could be extended to 4 in the future) digit numeric numbers. i.e., P2 is associated with the "Admin Password" in the Web GUI->Settings->Advanced Settings. For a detailed parameter list, please refer to the corresponding firmware release configuration template.

When GXP1100/GXP1105 boots up, it will send TFTP or HTTP/HTTPS requests to download configuration files, "cfg000b82xxxxx" and "cfg000b82xxxxx.xml", where "000b82xxxxx" is the MAC address of the phone. If the download of "cfgxxxxxxxxxxxx.xml" is not successful, phone will issue request for a generic configuration file "cfg.xml". Configuration file name should be in lower case letters.

For more details on XML provisioning, please refer to:

[http://www.grandstream.com/general/gs\\_provisioning\\_guide\\_public.pdf](http://www.grandstream.com/general/gs_provisioning_guide_public.pdf)



## RESTORE FACTORY DEFAULT SETTINGS

### Warning:

Restoring the Factory Default Settings will delete all configuration information on the phone. Please backup or print all the settings before you restore to the factory default settings. Grandstream is not responsible for restoring lost parameters and cannot connect your device to your VoIP service provider.

Please follow the instructions below to reset the phone:

Pick up the handset, press \*\*\* to access the IVR menu. Enter 99 for factory reset. Then enter the MAC address printed on the bottom of the sticker. Please use the following mapping:

0-9:	0-9
A:	22 (press the "2" key twice, "A" will show on the LCD)
B:	222
C:	2222
D:	33 (press the "3" key twice, "D" will show on the LCD)
E:	333
F:	3333

**Example:** if the MAC address is 000**b**8200**e**395, it should be key in as "000**222**8200**333**395".

### Note:

- If there are digits like "22" in the MAC, you need to wait for 4 seconds to continue to key in another "2";
- Once the MAC address is correctly input, the phone will reboot. Otherwise, it will announce "Invalid Entry" and exit to the main menu.

## EXPERIENCING THE GXP1100/GXP1105

Please visit our website: <http://www.grandstream.com> to receive the most up- to-date updates on firmware releases, additional features, FAQs, documentation and news on new products.

We encourage you to browse our [product related documentation](#), [FAQs](#) and [User and Developer Forum](#) for answers to your general questions. If you have purchased our products through a Grandstream Certified Partner or Reseller, please contact them directly for immediate support.

Our technical support staff is trained and ready to answer all of your questions. Contact a technical support member or [submit a trouble ticket online](#) to receive in-depth support.

Thank you again for purchasing Grandstream IP phone, it will be sure to bring convenience and color to both your business and personal life.