

GA-970A-D3P

User's Manual

Rev. 1001

12ME-970AD3P-1001R

Declaration of Conformity

We, Manufacturer/Importer,

G.B.T. Technology Trading GmbH
Bullenkoppel 16, 22047 Hamburg, Germany

Address:

Declare that the product

Product Type: **Motherboard**

Product Name: **GA-970A-D3P**

conforms with the essential requirements of the following directives:

- 2004/108/EC EMC Directive:**
 - Conduction & Radiated Emissions: EN55022:2006+A1:2007
 - Immunity: EN55024:1998+A1:2001+A2:2003
 - Power-line harmonics: EN61000-3-2:2006
 - Power-line flicker: EN61000-3-3:2008

- 2006/95/EC LVD Directive**
 - Safety: EN60950-1:2006+A11:2009

- 2011/65/EU RoHS Directive**
 - Restriction of use of certain substances in electronic equipment: This product does not contain any of the restricted substances listed in Annex II, in concentrations and applications banned by the directive.

CE marking



Signature: Timmy Huang

(Stamp)

Date: May 24, 2013

Name:

Timmy Huang

DECLARATION OF CONFORMITY

Per FCC Part 2 Section 2.1077(a)



Responsible Party Name: **G.B.T. INC. (U.S.A)**

Address: **17358 Railroad Street**

City of Industry, CA 91748

Phone/Fax No: (626) 854-9338/ (626) 854-9326

hereby declares that the product

Product Name: Motherboard

Model Number: GA-970A-D3P

Conforms to the following specifications:

FCC Part 15, Subpart B, Section 15.107(a) and Section 15.109

(a), Class B Digital Device

Supplementary Information:

This device complies with part 15 of the FCC Rules. Operation is subject to the following two conditions: (1) This device may not cause harmful and (2) this device must accept any interference received, including that may cause undesired operation.

Representative Person's Name: ERIC LU

Signature: Eric Lu

Date: May 24, 2013

Copyright

© 2013 GIGA-BYTE TECHNOLOGY CO., LTD. All rights reserved.

The trademarks mentioned in this manual are legally registered to their respective owners.

Disclaimer

Information in this manual is protected by copyright laws and is the property of GIGABYTE. Changes to the specifications and features in this manual may be made by GIGABYTE without prior notice.

No part of this manual may be reproduced, copied, translated, transmitted, or published in any form or by any means without GIGABYTE's prior written permission.

Documentation Classifications

In order to assist in the use of this product, GIGABYTE provides the following types of documentations:

- For quick set-up of the product, read the Quick Installation Guide included with the product.
- For detailed product information, carefully read the User's Manual.

For product-related information, check on our website at: <http://www.gigabyte.com>

Identifying Your Motherboard Revision

The revision number on your motherboard looks like this: "REV: X.X." For example, "REV: 1.0" means the revision of the motherboard is 1.0. Check your motherboard revision before updating motherboard BIOS, drivers, or when looking for technical information.

Example:

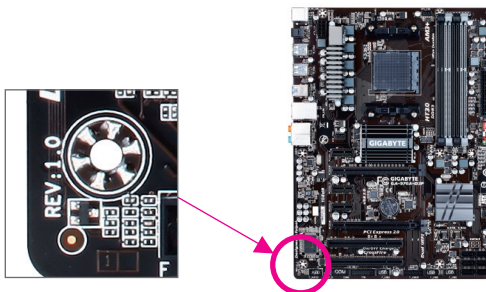

Table of Contents

Box Contents	6
Optional Items	6
GA-970A-D3P Motherboard Layout	7
GA-970A-D3P Motherboard Block Diagram	8
Chapter 1 Hardware Installation	9
1-1 Installation Precautions	9
1-2 Product Specifications	10
1-3 Installing the CPU and CPU Cooler	13
1-3-1 Installing the CPU	13
1-3-2 Installing the CPU Cooler	15
1-4 Installing the Memory	16
1-4-1 Dual Channel Memory Configuration	16
1-4-2 Installing a Memory	17
1-5 Installing an Expansion Card	18
1-6 Back Panel Connectors	19
1-7 Internal Connectors	21
Chapter 2 BIOS Setup	29
2-1 Startup Screen	30
2-2 The Main Menu	31
2-3 M.I.T.	33
2-4 System	41
2-5 BIOS Features	42
2-6 Peripherals	45
2-7 Power Management	48
2-8 Save & Exit	50
Chapter 3 Configuring SATA Hard Drive(s)	51
3-1 Configuring SATA Controllers	51
3-2 Installing the SATA RAID/AHCI Driver and Operating System	57

Chapter 4 Drivers Installation	61
4-1 Installing Chipset Drivers.....	61
4-2 Application Software.....	62
4-3 Technical Manuals.....	62
4-4 Contact.....	63
4-5 System.....	63
4-6 Download Center.....	64
 Chapter 5 Unique Features.....	 65
5-1 BIOS Update Utilities.....	65
5-1-1 Updating the BIOS with the Q-Flash Utility.....	65
5-1-2 Updating the BIOS with the @BIOS Utility.....	68
5-2 EasyTune 6.....	69
 Chapter 6 Appendix.....	 71
6-1 Configuring Audio Input and Output.....	71
6-1-1 Configuring 2/4/5.1/7.1-Channel Audio.....	71
6-1-2 Configuring S/PDIF Out.....	73
6-1-3 Configuring Microphone Recording.....	74
6-1-4 Using the Sound Recorder.....	76
6-2 Troubleshooting.....	77
6-2-1 Frequently Asked Questions.....	77
6-2-2 Troubleshooting Procedure.....	78
 Regulatory Statements.....	 80
Contact Us.....	83

Box Contents

- GA-970A-D3P motherboard
- Motherboard driver disk
- User's Manual
- Quick Installation Guide
- Two SATA cables
- I/O Shield

The box contents above are for reference only and the actual items shall depend on the product package you obtain. The box contents are subject to change without notice.

Optional Items

- 2-port USB 2.0 bracket (Part No. 12CR1-1UB030-6*R)
- eSATA bracket (Part No. 12CF1-3SATPW-4*R)
- 3.5" Front Panel with 2 USB 3.0/2.0 ports (Part No. 12CR1-FPX582-2*R)
- COM port cable (Part No. 12CF1-1CM001-3*R)

GA-970A-D3P Motherboard Layout

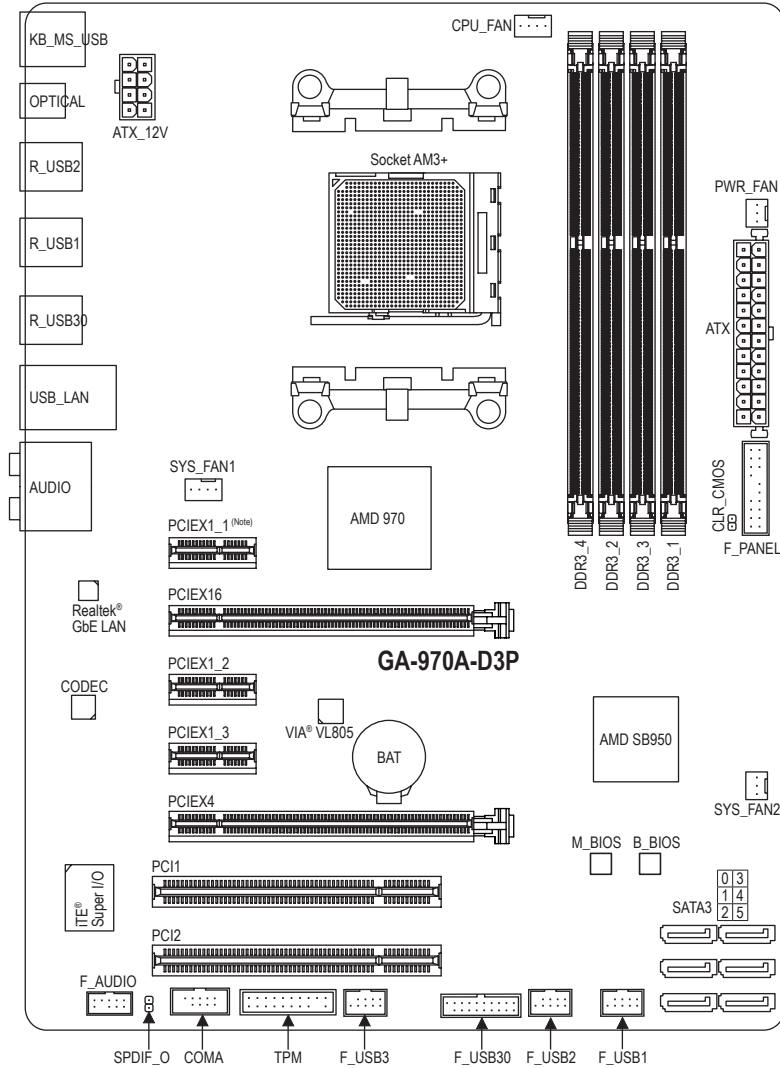

(Note) Due to a hardware limitation, the PCIEX1_1 slot can only accommodate a shorter PCI Express x1 expansion card. For a longer expansion card, use other expansion slots.

GA-970A-D3P Motherboard Block Diagram

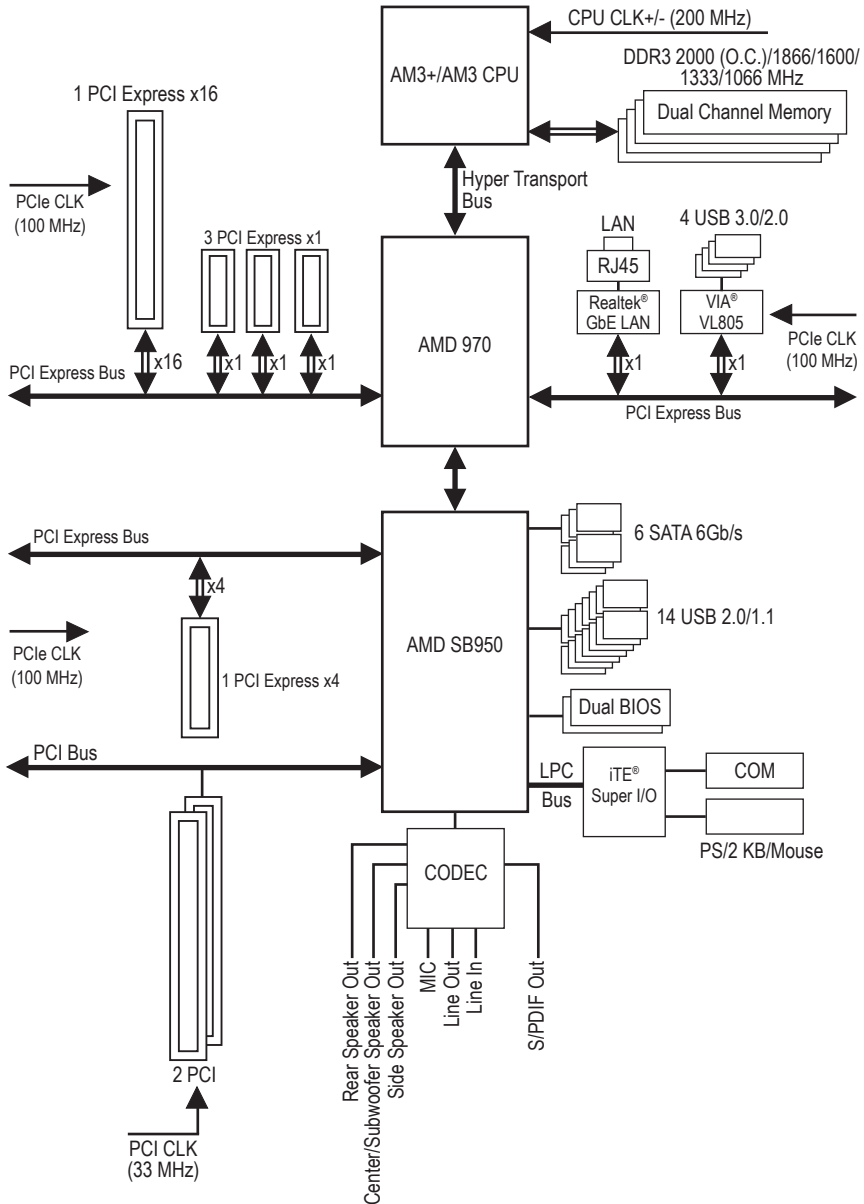

For detailed product information/limitation(s), refer to "1-2 Product Specifications."









Chapter 1 Hardware Installation





1-1 Installation Precautions





The motherboard contains numerous delicate electronic circuits and components which can become damaged as a result of electrostatic discharge (ESD). Prior to installation, carefully read the user's manual and follow these procedures:

- Prior to installation, make sure the chassis is suitable for the motherboard.
- Prior to installation, do not remove or break motherboard S/N (Serial Number) sticker or warranty sticker provided by your dealer. These stickers are required for warranty validation.
- Always remove the AC power by unplugging the power cord from the power outlet before installing or removing the motherboard or other hardware components.
- When connecting hardware components to the internal connectors on the motherboard, make sure they are connected tightly and securely.
- When handling the motherboard, avoid touching any metal leads or connectors.
- It is best to wear an electrostatic discharge (ESD) wrist strap when handling electronic components such as a motherboard, CPU or memory. If you do not have an ESD wrist strap, keep your hands dry and first touch a metal object to eliminate static electricity.
- Prior to installing the motherboard, please have it on top of an antistatic pad or within an electrostatic shielding container.
- Before unplugging the power supply cable from the motherboard, make sure the power supply has been turned off.
- Before turning on the power, make sure the power supply voltage has been set according to the local voltage standard.
- Before using the product, please verify that all cables and power connectors of your hardware components are connected.
- To prevent damage to the motherboard, do not allow screws to come in contact with the motherboard circuit or its components.
- Make sure there are no leftover screws or metal components placed on the motherboard or within the computer casing.
- Do not place the computer system on an uneven surface.
- Do not place the computer system in a high-temperature environment.
- Turning on the computer power during the installation process can lead to damage to system components as well as physical harm to the user.
- If you are uncertain about any installation steps or have a problem related to the use of the product, please consult a certified computer technician.

1-2 Product Specifications

	CPU	<ul style="list-style-type: none"> ◆ AM3+ Socket: <ul style="list-style-type: none"> - AMD AM3+ FX processor - AMD AM3 Phenom™ II processor/ AMD Athlon™ II processor (Go to GIGABYTE's website for the latest CPU support list.)
	Hyper Transport Bus	<ul style="list-style-type: none"> ◆ 4800 MT/s
	Chipset	<ul style="list-style-type: none"> ◆ North Bridge: AMD 970 ◆ South Bridge: AMD SB950
	Memory	<ul style="list-style-type: none"> ◆ 4 x 1.5V DDR3 DIMM sockets supporting up to 32 GB of system memory <ul style="list-style-type: none"> * Due to a Windows 32-bit operating system limitation, when more than 4 GB of physical memory is installed, the actual memory size displayed will be less than the size of the physical memory installed. ◆ Dual channel memory architecture ◆ Support for DDR3 2000(O.C.)/1866/1600/1333/1066 MHz memory modules <ul style="list-style-type: none"> * To support a DDR3 1866 MHz (and above) memory, you must install an AM3+ CPU first. ◆ Support for Extreme Memory Profile (XMP) memory modules (Go to GIGABYTE's website for the latest supported memory speeds and memory modules.)
	Audio	<ul style="list-style-type: none"> ◆ VIA® VT2021 codec ◆ High Definition Audio ◆ 2/4/5.1/7.1-channel ◆ Support for S/PDIF Out
	LAN	<ul style="list-style-type: none"> ◆ Realtek® GbE LAN chip (10/100/1000 Mbit)
	Expansion Slots	<ul style="list-style-type: none"> ◆ 1 x PCI Express x16 slot, running at x16 (PCIEX16) <ul style="list-style-type: none"> * For optimum performance, if only one PCI Express graphics card is to be installed, be sure to install it in the PCIEX16 slot. ◆ 1 x PCI Express x16 slot, running at x4 (PCIEX4) ◆ 3 x PCI Express x1 slots (All PCI Express slots conform to PCI Express 2.0 standard.) ◆ 2 x PCI slots
	Storage Interface	<ul style="list-style-type: none"> ◆ South Bridge: <ul style="list-style-type: none"> - 6 x SATA 6Gb/s connectors supporting up to 6 SATA 6Gb/s devices - Support for RAID 0, RAID 1, RAID 5, RAID 10, and JBOD
	USB	<ul style="list-style-type: none"> ◆ South Bridge: <ul style="list-style-type: none"> - Up to 14 USB 2.0/1.1 ports (8 ports on the back panel, 6 ports available through the internal USB headers) ◆ VIA® VL805 chip: <ul style="list-style-type: none"> - Up to 4 USB 3.0/2.0 ports (2 ports on the back panel, 2 ports available through the internal USB header)

	Internal Connectors	<ul style="list-style-type: none"> ◆ 1 x 24-pin ATX main power connector ◆ 1 x 8-pin ATX 12V power connector ◆ 6 x SATA 6Gb/s connectors ◆ 1 x CPU fan header ◆ 2 x system fan headers ◆ 1 x power fan header ◆ 1 x front panel header ◆ 1 x front panel audio header ◆ 1 x S/PDIF Out header ◆ 1 x USB 3.0/2.0 header ◆ 3 x USB 2.0/1.1 headers ◆ 1 x serial port header ◆ 1 x Clear CMOS jumper ◆ 1 x Trusted Platform Module (TPM) header
	Back Panel Connectors	<ul style="list-style-type: none"> ◆ 1 x PS/2 keyboard/mouse port ◆ 1 x optical S/PDIF Out connector ◆ 8 x USB 2.0/1.1 ports ◆ 2 x USB 3.0/2.0 ports ◆ 1 x RJ-45 port ◆ 6 x audio jacks (Center/Subwoofer Speaker Out/Rear Speaker Out/Side Speaker Out/Line In/Line Out/Microphone)
	I/O Controller	<ul style="list-style-type: none"> ◆ iTE® I/O Controller Chip
	Hardware Monitor	<ul style="list-style-type: none"> ◆ System voltage detection ◆ CPU/System temperature detection ◆ CPU/System/Power fan speed detection ◆ CPU overheating warning ◆ CPU/System/Power fan fail warning ◆ CPU/System fan speed control <ul style="list-style-type: none"> * Whether the fan speed control function is supported will depend on the cooler you install.
	BIOS	<ul style="list-style-type: none"> ◆ 2 x 32 Mbit flash ◆ Use of licensed AMI EFI BIOS ◆ Support for DualBIOS™ ◆ PnP 1.0a, DMI 2.0, SM BIOS 2.6, ACPI 2.0a

	Unique Features	<ul style="list-style-type: none"> ◆ Support for @BIOS ◆ Support for Q-Flash ◆ Support for Xpress Install ◆ Support for EasyTune <ul style="list-style-type: none"> * Available functions in EasyTune may differ by motherboard model. ◆ Support for ON/OFF Charge
	Bundled Software	<ul style="list-style-type: none"> ◆ Norton Internet Security (OEM version)
	Operating System	<ul style="list-style-type: none"> ◆ Support for Windows 8/7/Vista/XP
	Form Factor	<ul style="list-style-type: none"> ◆ ATX Form Factor; 30.5cm x 22.4cm

* GIGABYTE reserves the right to make any changes to the product specifications and product-related information without prior notice.

* Please visit the [Support & Downloads\Utility](#) page on GIGABYTE's website to check the supported operating system(s) for the software listed in the "Unique Features" and "Bundled Software" columns.

1-3 Installing the CPU and CPU Cooler



Read the following guidelines before you begin to install the CPU:

- Make sure that the motherboard supports the CPU.
(Go to GIGABYTE's website for the latest CPU support list.)
- Always turn off the computer and unplug the power cord from the power outlet before installing the CPU to prevent hardware damage.
- Locate the pin one of the CPU. The CPU cannot be inserted if oriented incorrectly.
- Apply an even and thin layer of thermal grease on the surface of the CPU.
- Do not turn on the computer if the CPU cooler is not installed, otherwise overheating and damage of the CPU may occur.
- Set the CPU host frequency in accordance with the CPU specifications. It is not recommended that the system bus frequency be set beyond hardware specifications since it does not meet the standard requirements for the peripherals. If you wish to set the frequency beyond the standard specifications, please do so according to your hardware specifications including the CPU, graphics card, memory, hard drive, etc.

1-3-1 Installing the CPU

- A. Locate the pin one (denoted by a small triangle) of the CPU socket and the CPU.

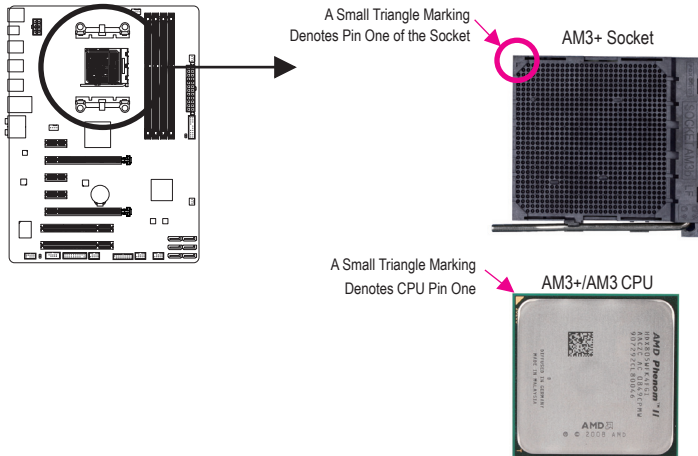

B. Follow the steps below to correctly install the CPU into the motherboard CPU socket.



- Before installing the CPU, make sure to turn off the computer and unplug the power cord from the power outlet to prevent damage to the CPU.
- Do not force the CPU into the CPU socket. The CPU cannot fit in if oriented incorrectly. Adjust the CPU orientation if this occurs.

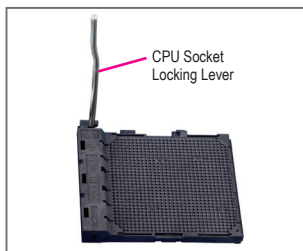

Step 1:

Completely lift up the CPU socket locking lever.

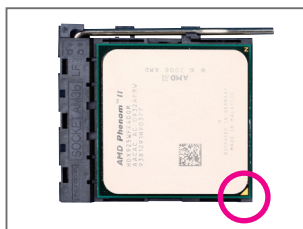

Step 2:

Align the CPU pin one (small triangle marking) with the triangle mark on the CPU socket and gently insert the CPU into the socket. Make sure that the CPU pins fit perfectly into their holes.

Once the CPU is positioned into its socket, place one finger down on the middle of the CPU, lowering the locking lever and latching it into the fully locked position.

1-3-2 Installing the CPU Cooler

Follow the steps below to correctly install the CPU cooler on the motherboard. (The following procedure uses the GIGABYTE cooler as the example.)



Step 1:
Apply an even and thin layer of thermal grease on the surface of the installed CPU.

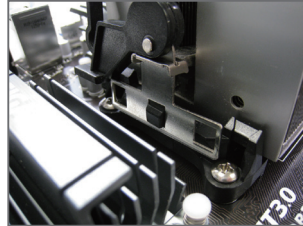

Step 2:
Hook the CPU cooler clip to the mounting lug on one side of the retention frame. On the other side, push straight down on the CPU cooler clip to hook it to the mounting lug on the retention frame.

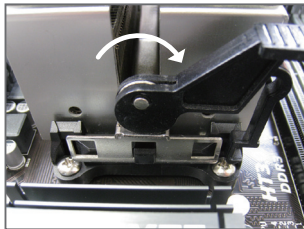

Step 3:
Turn the cam handle from the left side to the right side (as the picture above shows) to lock into place. (Refer to your CPU cooler installation manual for instructions on installing the cooler.)

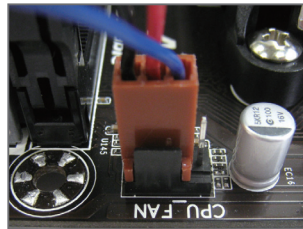

Step 4:
Finally, attach the power connector of the CPU cooler to the CPU fan header (CPU_FAN) on the motherboard.



Use extreme care when removing the CPU cooler because the thermal grease/tape between the CPU cooler and CPU may adhere to the CPU. Inadequately removing the CPU cooler may damage the CPU.

1-4 Installing the Memory



Read the following guidelines before you begin to install the memory:

- Make sure that the motherboard supports the memory. It is recommended that memory of the same capacity, brand, speed, and chips be used.
(Go to GIGABYTE's website for the latest supported memory speeds and memory modules.)
- Always turn off the computer and unplug the power cord from the power outlet before installing the memory to prevent hardware damage.
- Memory modules have a foolproof design. A memory module can be installed in only one direction. If you are unable to insert the memory, switch the direction.

1-4-1 Dual Channel Memory Configuration

This motherboard provides four DDR3 memory sockets and supports Dual Channel Technology. After the memory is installed, the BIOS will automatically detect the specifications and capacity of the memory. Enabling Dual Channel memory mode will double the original memory bandwidth.

The four DDR3 memory sockets are divided into two channels and each channel has two memory sockets as following:

▶▶ Channel A: DDR3_2, DDR3_4

▶▶ Channel B: DDR3_1, DDR3_3

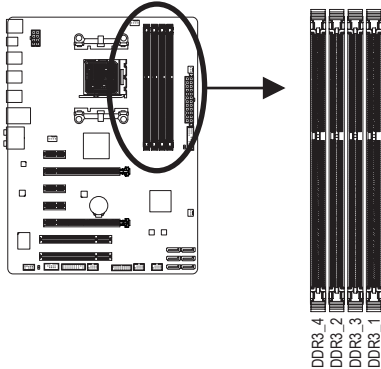

▶▶ Dual Channel Memory Configurations Table:

	DDR3_4	DDR3_2	DDR3_3	DDR3_1
Two Modules	--	DS/SS	--	DS/SS
	DS/SS	--	DS/SS	--
Four Modules	DS/SS	DS/SS	DS/SS	DS/SS

(SS=Single-Sided, DS=Double-Sided, "--"=No Memory)

Due to CPU limitations, read the following guidelines before installing the memory in Dual Channel mode.

1. Dual Channel mode cannot be enabled if only one DDR3 memory module is installed.
2. When enabling Dual Channel mode with two or four memory modules, it is recommended that memory of the same capacity, brand, speed, and chips be used and installed in the same colored DDR3 sockets for optimum performance. For optimum performance, when enabling Dual Channel mode with two memory modules, we recommend that you install them in the DDR3_1 and DDR3_2 sockets.

1-4-2 Installing a Memory

 Before installing a memory module, make sure to turn off the computer and unplug the power cord from the power outlet to prevent damage to the memory module. DDR3 and DDR2 DIMMs are not compatible to each other or DDR DIMMs. Be sure to install DDR3 DIMMs on this motherboard.

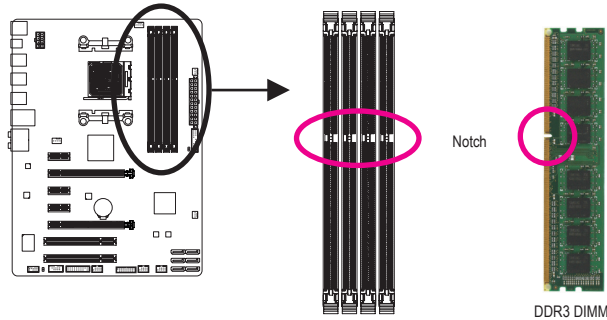

A DDR3 memory module has a notch, so it can only fit in one direction. Follow the steps below to correctly install your memory modules in the memory sockets.

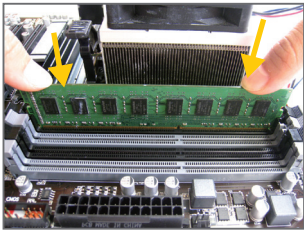

Step 1:

Note the orientation of the memory module. Spread the retaining clips at both ends of the memory socket. Place the memory module on the socket. As indicated in the picture on the left, place your fingers on the top edge of the memory, push down on the memory and insert it vertically into the memory socket.

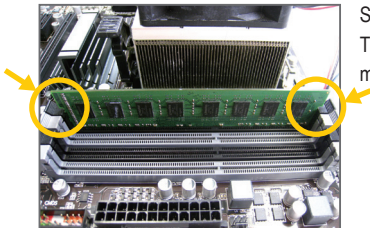

Step 2:

The clips at both ends of the socket will snap into place when the memory module is securely inserted.

1-5 Installing an Expansion Card



Read the following guidelines before you begin to install an expansion card:

- Make sure the motherboard supports the expansion card. Carefully read the manual that came with your expansion card.
- Always turn off the computer and unplug the power cord from the power outlet before installing an expansion card to prevent hardware damage.

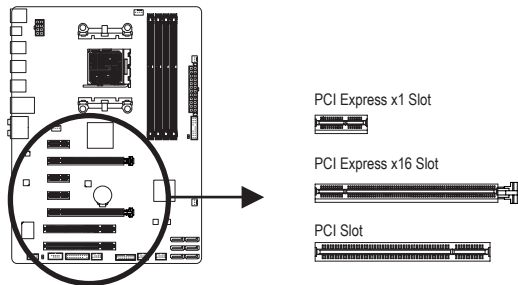

Follow the steps below to correctly install your expansion card in the expansion slot.

1. Locate an expansion slot that supports your card. Remove the metal slot cover from the chassis back panel.
2. Align the card with the slot, and press down on the card until it is fully seated in the slot.
3. Make sure the metal contacts on the card are completely inserted into the slot.
4. Secure the card's metal bracket to the chassis back panel with a screw.
5. After installing all expansion cards, replace the chassis cover(s).
6. Turn on your computer. If necessary, go to BIOS Setup to make any required BIOS changes for your expansion card(s).
7. Install the driver provided with the expansion card in your operating system.

Example: Installing and Removing a PCI Express Graphics Card:

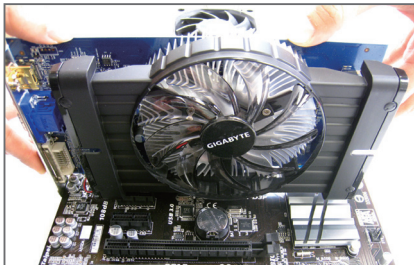

- **Installing a Graphics Card:**
Gently push down on the top edge of the card until it is fully inserted into the PCI Express slot. Make sure the card is securely seated in the slot and does not rock.

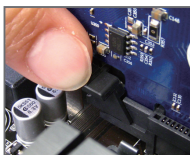

- **Removing the Card:**
Gently push back on the lever on the slot and then lift the card straight out from the slot.

1-6 Back Panel Connectors

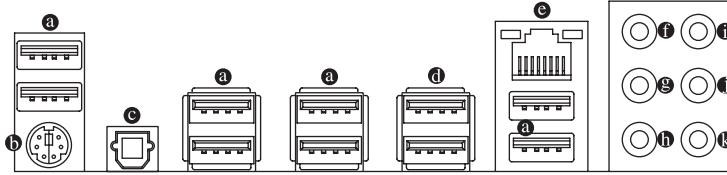

a USB 2.0/1.1 Port

The USB port supports the USB 2.0/1.1 specification. Use this port for USB devices such as a USB keyboard/mouse, USB printer, USB flash drive and etc.

b PS/2 Keyboard/Mouse Port

Use this port to connect a PS/2 mouse or keyboard.

c Optical S/PDIF Out Connector

This connector provides digital audio out to an external audio system that supports digital optical audio. Before using this feature, ensure that your audio system provides an optical digital audio in connector.

d USB 3.0/2.0 Port

The USB 3.0 port supports the USB 3.0 specification and is compatible to the USB 2.0/1.1 specification. Use this port for USB devices such as a USB keyboard/mouse, USB printer, USB flash drive and etc.

e RJ-45 LAN Port

The Gigabit Ethernet LAN port provides Internet connection at up to 1 Gbps data rate. The following describes the states of the LAN port LEDs.

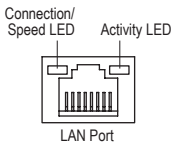

Connection/Speed LED:

State	Description
Orange	1 Gbps data rate
Green	100 Mbps data rate
Off	10 Mbps data rate

Activity LED:

State	Description
Blinking	Data transmission or receiving is occurring
Off	No data transmission or receiving is occurring



- When removing the cable connected to a back panel connector, first remove the cable from your device and then remove it from the motherboard.
- When removing the cable, pull it straight out from the connector. Do not rock it side to side to prevent an electrical short inside the cable connector.

❶ **Center/Subwoofer Speaker Out Jack (Orange)**

Use this audio jack to connect center/subwoofer speakers in a 5.1/7.1-channel audio configuration.

❷ **Rear Speaker Out Jack (Black)**

This jack can be used to connect front speakers in a 4/5.1/7.1-channel audio configuration.

❸ **Side Speaker Out Jack (Gray)**

Use this audio jack to connect side speakers in a 7.1-channel audio configuration.

❹ **Line In Jack (Blue)**

The default line in jack. Use this audio jack for line in devices such as an optical drive, walkman, etc.

❺ **Line Out Jack (Green)**

The default line out jack. Use this audio jack for a headphone or 2-channel speaker. This jack can be used to connect front speakers in a 4/5.1/7.1-channel audio configuration.

❻ **Mic In Jack (Pink)**

The default Mic in jack. Microphones must be connected to this jack.



The audio jacks can be reconfigured to perform different functions via the audio software. Only microphones still **MUST** be connected to the default Mic in jack. Refer to the instructions on setting up a 2/4/5.1/7.1-channel audio configuration in Chapter 6, "Configuring 2/4/5.1/7.1-Channel Audio."

1-7 Internal Connectors

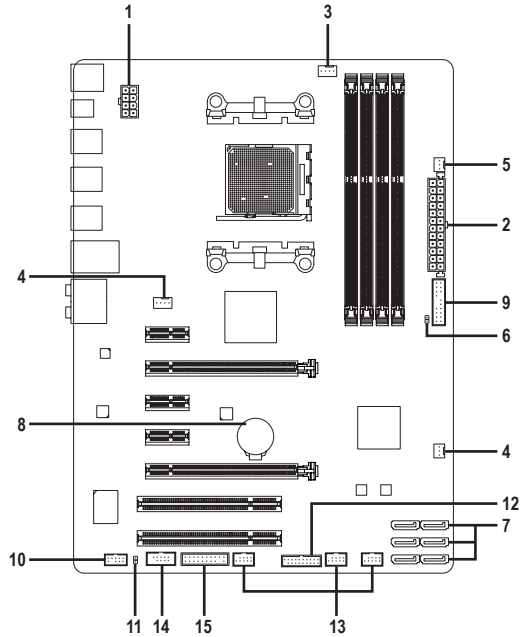

1) ATX_12V	9) F_PANEL
2) ATX	10) F_AUDIO
3) CPU_FAN	11) SPDIF_O
4) SYS_FAN1/SYS_FAN2	12) F_USB30
5) PWR_FAN	13) F_USB1/F_USB2/F_USB3
6) CLR_CMOS	14) COMA
7) SATA3 0/1/2/3/4/5	15) TPM
8) BAT	



Read the following guidelines before connecting external devices:

- First make sure your devices are compliant with the connectors you wish to connect.
- Before installing the devices, be sure to turn off the devices and your computer. Unplug the power cord from the power outlet to prevent damage to the devices.
- After installing the device and before turning on the computer, make sure the device cable has been securely attached to the connector on the motherboard.

1/2) ATX_12V/ATX (2x4 12V Power Connector and 2x12 Main Power Connector)

With the use of the power connector, the power supply can supply enough stable power to all the components on the motherboard. Before connecting the power connector, first make sure the power supply is turned off and all devices are properly installed. The power connector possesses a foolproof design. Connect the power supply cable to the power connector in the correct orientation.

The 12V power connector mainly supplies power to the CPU. If the 12V power connector is not connected, the computer will not start.



To meet expansion requirements, it is recommended that a power supply that can withstand high power consumption be used (500W or greater). If a power supply is used that does not provide the required power, the result can lead to an unstable or unbootable system.

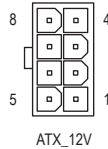
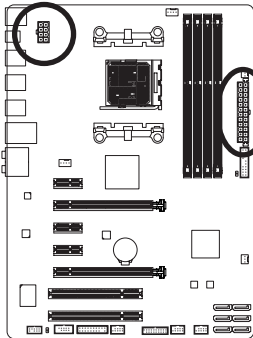

ATX_12V:

Pin No.	Definition
1	GND (Only for 2x4-pin 12V)
2	GND (Only for 2x4-pin 12V)
3	GND
4	GND
5	+12V (Only for 2x4-pin 12V)
6	+12V (Only for 2x4-pin 12V)
7	+12V
8	+12V

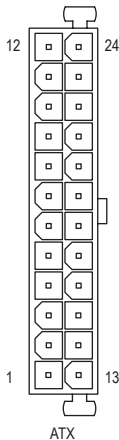

ATX:

Pin No.	Definition	Pin No.	Definition
1	3.3V	13	3.3V
2	3.3V	14	-12V
3	GND	15	GND
4	+5V	16	PS_ON (soft On/Off)
5	GND	17	GND
6	+5V	18	GND
7	GND	19	GND
8	Power Good	20	-5V
9	5VSB (stand by +5V)	21	+5V
10	+12V	22	+5V
11	+12V (Only for 2x12-pin ATX)	23	+5V (Only for 2x12-pin ATX)
12	3.3V (Only for 2x12-pin ATX)	24	GND (Only for 2x12-pin ATX)

3/4/5) CPU_FAN/SYS_FAN1/SYS_FAN2/PWR_FAN (Fan Headers)

The motherboard has a 4-pin CPU fan header (CPU_FAN), a 4-pin (SYS_FAN1) and a 3-pin (SYS_FAN2) system fan headers, and a 3-pin power fan header (PWR_FAN). Most fan headers possess a foolproof insertion design. When connecting a fan cable, be sure to connect it in the correct orientation (the black connector wire is the ground wire). The speed control function requires the use of a fan with fan speed control design. For optimum heat dissipation, it is recommended that a system fan be installed inside the chassis.

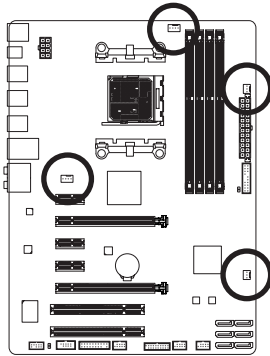

CPU_FAN:

Pin No.	Definition
1	GND
2	+12V / Speed Control
3	Sense
4	Speed Control

SYS_FAN1:

Pin No.	Definition
1	GND
2	+12V / Speed Control
3	Sense
4	Reserve

SYS_FAN2/PWR_FAN:

Pin No.	Definition
1	GND
2	+12V
3	Sense



- Be sure to connect fan cables to the fan headers to prevent your CPU and system from overheating. Overheating may result in damage to the CPU or the system may hang.
- These fan headers are not configuration jumper blocks. Do not place a jumper cap on the headers.

6) CLR_CMOS (Clear CMOS Jumper)

Use this jumper to clear the CMOS values (e.g. date information and BIOS configurations) and reset the CMOS values to factory defaults. To clear the CMOS values, use a metal object like a screwdriver to touch the two pins for a few seconds.

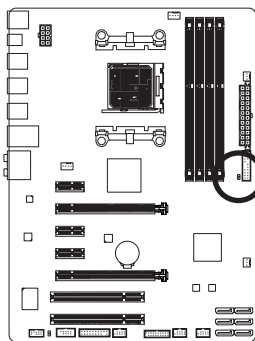

Open: Normal



Short: Clear CMOS Values



- Always turn off your computer and unplug the power cord from the power outlet before clearing the CMOS values.
- After system restart, go to BIOS Setup to load factory defaults (select Load Optimized Defaults) or manually configure the BIOS settings (refer to Chapter 2, "BIOS Setup," for BIOS configurations).

7) SATA3 0/1/2/3/4/5 (SATA 6Gb/s Connectors)

The SATA connectors conform to SATA 6Gb/s standard and are compatible with SATA 3Gb/s and SATA 1.5Gb/s standard. Each SATA connector supports a single SATA device. The AMD SB950 controller supports RAID 0, RAID 1, RAID 5, RAID 10, and JBOD. Refer to Chapter 3, "Configuring SATA Hard Drive(s)," for instructions on configuring a RAID array.

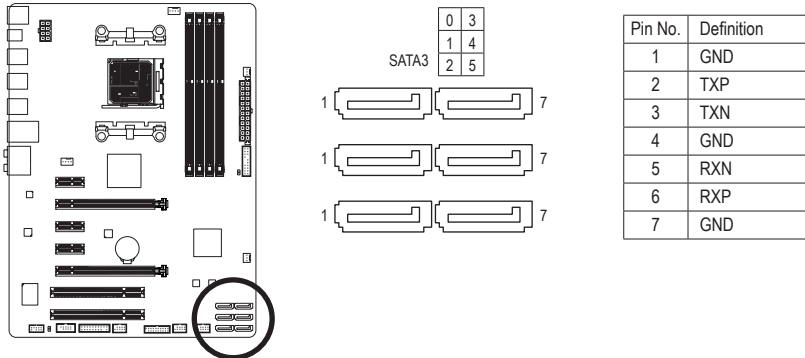

- A RAID 0 or RAID 1 configuration requires at least two hard drives. If more than two hard drives are to be used, the total number of hard drives must be an even number.
- A RAID 5 configuration requires at least three hard drives. (The total number of hard drives does not have to be an even number.)
- A RAID 10 configuration requires four hard drives.

8) BAT (Battery)

The battery provides power to keep the values (such as BIOS configurations, date, and time information) in the CMOS when the computer is turned off. Replace the battery when the battery voltage drops to a low level, or the CMOS values may not be accurate or may be lost.

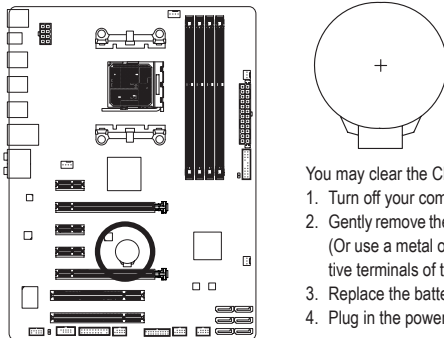

You may clear the CMOS values by removing the battery:

1. Turn off your computer and unplug the power cord.
2. Gently remove the battery from the battery holder and wait for one minute. (Or use a metal object like a screwdriver to touch the positive and negative terminals of the battery holder, making them short for 5 seconds.)
3. Replace the battery.
4. Plug in the power cord and restart your computer.



- Always turn off your computer and unplug the power cord before replacing the battery.
- Replace the battery with an equivalent one. Danger of explosion if the battery is replaced with an incorrect model.
- Contact the place of purchase or local dealer if you are not able to replace the battery by yourself or uncertain about the battery model.
- When installing the battery, note the orientation of the positive side (+) and the negative side (-) of the battery (the positive side should face up).
- Used batteries must be handled in accordance with local environmental regulations.

9) F_PANEL (Front Panel Header)

Connect the power switch, reset switch, speaker, chassis intrusion switch/sensor and system status indicator on the chassis to this header according to the pin assignments below. Note the positive and negative pins before connecting the cables.

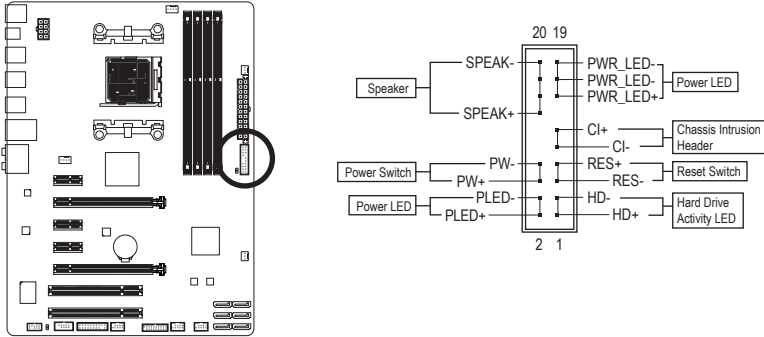

- **PLED/PWR_LED** (Power LED, Yellow/Purple):

System Status	LED
S0	On
S3/S4/S5	Off

Connects to the power status indicator on the chassis front panel. The LED is on when the system is operating. The LED is off when the system is in S3/S4 sleep state or powered off (S5).

- **PW** (Power Switch, Red):
Connects to the power switch on the chassis front panel. You may configure the way to turn off your system using the power switch (refer to Chapter 2, "BIOS Setup," "Power Management," for more information).
- **SPEAK** (Speaker, Orange):
Connects to the speaker on the chassis front panel. The system reports system startup status by issuing a beep code. One single short beep will be heard if no problem is detected at system startup.
- **HD** (Hard Drive Activity LED, Blue):
Connects to the hard drive activity LED on the chassis front panel. The LED is on when the hard drive is reading or writing data.
- **RES** (Reset Switch, Green):
Connects to the reset switch on the chassis front panel. Press the reset switch to restart the computer if the computer freezes and fails to perform a normal restart.
- **CI** (Chassis Intrusion Header, Gray):
Connects to the chassis intrusion switch/sensor on the chassis that can detect if the chassis cover has been removed. This function requires a chassis with a chassis intrusion switch/sensor.



The front panel design may differ by chassis. A front panel module mainly consists of power switch, reset switch, power LED, hard drive activity LED, speaker and etc. When connecting your chassis front panel module to this header, make sure the wire assignments and the pin assignments are matched correctly.

10) F_AUDIO (Front Panel Audio Header)

The front panel audio header supports Intel High Definition audio (HD) and AC'97 audio. You may connect your chassis front panel audio module to this header. Make sure the wire assignments of the module connector match the pin assignments of the motherboard header. Incorrect connection between the module connector and the motherboard header will make the device unable to work or even damage it.

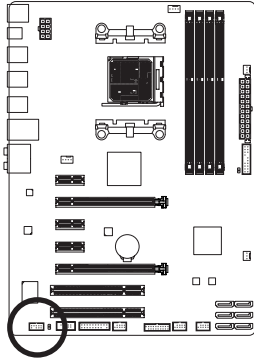

For HD Front Panel Audio:

Pin No.	Definition
1	MIC2_L
2	GND
3	MIC2_R
4	-ACZ_DET
5	LINE2_R
6	GND
7	FAUDIO_JD
8	No Pin
9	LINE2_L
10	GND

For AC'97 Front Panel Audio:

Pin No.	Definition
1	MIC
2	GND
3	MIC Power
4	NC
5	Line Out (R)
6	NC
7	NC
8	No Pin
9	Line Out (L)
10	NC



- The front panel audio header supports HD audio by default. If your chassis provides an AC'97 front panel audio module, refer to the instructions on how to activate AC'97 functionality via the audio software in Chapter 6, "Configuring 2/4/5.1/7.1-Channel Audio."
- Audio signals will be present on both of the front and back panel audio connections simultaneously. If you want to mute the back panel audio (only supported when using an HD front panel audio module), refer to Chapter 6, "Configuring 2/4/5.1/7.1-Channel Audio."
- Some chassis provide a front panel audio module that has separated connectors on each wire instead of a single plug. For information about connecting the front panel audio module that has different wire assignments, please contact the chassis manufacturer.

11) SPDIF_O (S/PDIF Out Header)

This header supports digital S/PDIF Out and connects a S/PDIF digital audio cable (provided by expansion cards) for digital audio output from your motherboard to certain expansion cards like graphics cards and sound cards. For example, some graphics cards may require you to use a S/PDIF digital audio cable for digital audio output from your motherboard to your graphics card if you wish to connect an HDMI display to the graphics card and have digital audio output from the HDMI display at the same time. For information about connecting the S/PDIF digital audio cable, carefully read the manual for your expansion card.

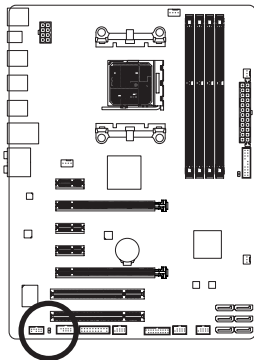

Pin No.	Definition
1	SPDIFO
2	GND

12) F_USB30 (USB 3.0/2.0 Header)

The header conforms to USB 3.0/2.0 specification and can provide two USB ports. For purchasing the optional 3.5" front panel that provides two USB 3.0/2.0 ports, please contact the local dealer.

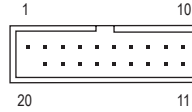
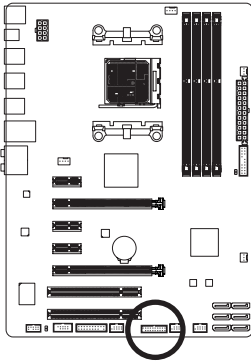

Pin No.	Definition	Pin No.	Definition
1	VBUS	11	D2+
2	SSRX1-	12	D2-
3	SSRX1+	13	GND
4	GND	14	SSTX2+
5	SSTX1-	15	SSTX2-
6	SSTX1+	16	GND
7	GND	17	SSRX2+
8	D1-	18	SSRX2-
9	D1+	19	VBUS
10	NC	20	No Pin

13) F_USB1/F_USB2/F_USB3 (USB Headers)

The headers conform to USB 2.0/1.1 specification. Each USB header can provide two USB ports via an optional USB bracket. For purchasing the optional USB bracket, please contact the local dealer.

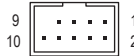
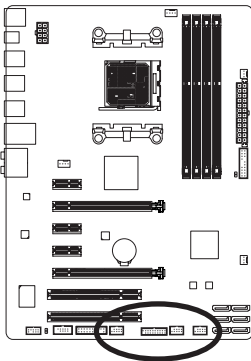

Pin No.	Definition
1	Power (5V)
2	Power (5V)
3	USB DX-
4	USB DY-
5	USB DX+
6	USB DY+
7	GND
8	GND
9	No Pin
10	NC



- Do not plug the IEEE 1394 bracket (2x5-pin) cable into the USB header.
- Prior to installing the USB bracket, be sure to turn off your computer and unplug the power cord from the power outlet to prevent damage to the USB bracket.

14) COMA (Serial Port Header)

The COM header can provide one serial port via an optional COM port cable. For purchasing the optional COM port cable, please contact the local dealer.

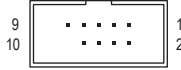
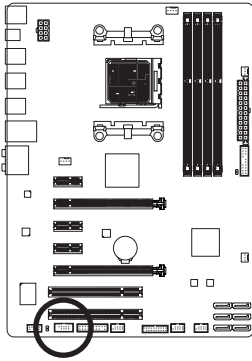

Pin No.	Definition
1	NDCD-
2	NSIN
3	NSOUT
4	NDTR-
5	GND
6	NDSR-
7	NRTS-
8	NCTS-
9	NRI-
10	No Pin

15) TPM (Trusted Platform Module Header)

You may connect a TPM (Trusted Platform Module) to this header.

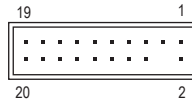
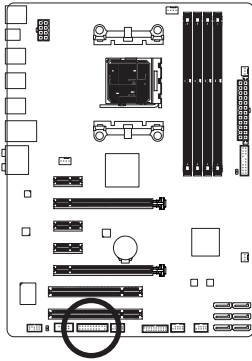

Pin No.	Definition	Pin No.	Definition
1	LCLK	11	LAD0
2	GND	12	GND
3	LFRAME	13	NC
4	No Pin	14	ID
5	LRESET	15	SB3V
6	NC	16	SERIRQ
7	LAD3	17	GND
8	LAD2	18	NC
9	VCC3	19	NC
10	LAD1	20	SUSCLK

Chapter 2 BIOS Setup

BIOS (Basic Input and Output System) records hardware parameters of the system in the CMOS on the motherboard. Its major functions include conducting the Power-On Self-Test (POST) during system startup, saving system parameters and loading operating system, etc. BIOS includes a BIOS Setup program that allows the user to modify basic system configuration settings or to activate certain system features.

When the power is turned off, the battery on the motherboard supplies the necessary power to the CMOS to keep the configuration values in the CMOS.

To access the BIOS Setup program, press the <Delete> key during the POST when the power is turned on.

To upgrade the BIOS, use either the GIGABYTE Q-Flash or @BIOS utility.

- Q-Flash allows the user to quickly and easily upgrade or back up BIOS without entering the operating system.
- @BIOS is a Windows-based utility that searches and downloads the latest version of BIOS from the Internet and updates the BIOS.

For instructions on using the Q-Flash and @BIOS utilities, refer to Chapter 5, "BIOS Update Utilities."



- Because BIOS flashing is potentially risky, if you do not encounter problems using the current version of BIOS, it is recommended that you not flash the BIOS. To flash the BIOS, do it with caution. Inadequate BIOS flashing may result in system malfunction.
- It is recommended that you not alter the default settings (unless you need to) to prevent system instability or other unexpected results. Inadequately altering the settings may result in system's failure to boot. If this occurs, try to clear the CMOS values and reset the board to default values. (Refer to the "Load Optimized Defaults" section in this chapter or introductions of the battery/clear CMOS jumper in Chapter 1 for how to clear the CMOS values.)

2-1 Startup Screen

The following startup Logo screen will appear when the computer boots.



Function Keys:

: BIOS SETUP/Q-FLASH

Press the <Delete> key to enter BIOS Setup or to access the Q-Flash utility in BIOS Setup.

<F9>: SYSTEM INFORMATION

Press the <F9> key to display your system information.

<F12>: BOOT MENU

Boot Menu allows you to set the first boot device without entering BIOS Setup. In Boot Menu, use the up arrow key <↑> or the down arrow key <↓> to select the first boot device, then press <Enter> to accept. The system will boot from the device immediately.

Note: The setting in Boot Menu is effective for one time only. After system restart, the device boot order will still be based on BIOS Setup settings.

<END>: Q-FLASH

Press the <End> key to access the Q-Flash utility directly without having to enter BIOS Setup first.

2-2 The Main Menu

On the main menu of the BIOS Setup program, press arrow keys to move among the items and press <Enter> to accept or enter a sub-menu. Or you can use your mouse to select the item you want.

(Sample BIOS Version: E7)

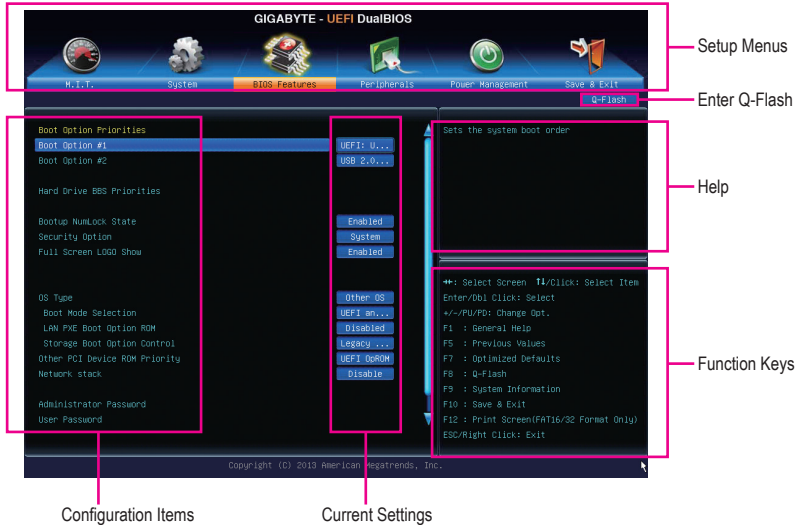

BIOS Setup Program Function Keys

<←><→>	Move the selection bar to select a setup menu
<↑><↓>	Move the selection bar to select an configuration item on a menu
<Enter>	Execute command or enter a menu
<+>/<Page Up>	Increase the numeric value or make changes
<->/<Page Down>	Decrease the numeric value or make changes
<F5>	Restore the previous BIOS settings for the current submenus
<F7>	Load the Optimized BIOS default settings for the current submenus
<F8>	Access the Q-Flash utility
<F9>	Display system information
<F10>	Save all the changes and exit the BIOS Setup program
<F12>	Capture the current screen as an image and save it to your USB drive
<Esc>	Main Menu: Exit the BIOS Setup program Submenus: Exit current submenu

BIOS Setup Menus

■ M.I.T.

Use this menu to configure the clock, frequency, and voltages of your CPU and memory, etc. Or check the system/CPU temperatures, voltages, and fan speeds.

■ System

Use this menu to configure the default language used by the BIOS and system time and date. This menu also displays information on the devices connected to the SATA ports.

■ BIOS Features

Use this menu to configure the device boot order, advanced features available on the CPU, and the primary display adapter.

■ Peripherals

Use this menu to configure all peripheral devices, such as SATA, USB, integrated audio, and integrated LAN, etc.

■ Power Management

Use this menu to configure all the power-saving functions.

■ Save & Exit

Save all the changes made in the BIOS Setup program to the CMOS and exit BIOS Setup. You can save the current BIOS settings to a profile or load optimized defaults for optimal-performance system operations.



- When the system is not stable as usual, select the **Load Optimized Defaults** item to set your system to its defaults.
- The BIOS Setup menus described in this chapter are for reference only and may differ by BIOS version.

2-3 M.I.T.



Whether the system will work stably with the overclock/overvoltage settings you made is dependent on your overall system configurations. Incorrectly doing overclock/overvoltage may result in damage to CPU, chipset, or memory and reduce the useful life of these components. This page is for advanced users only and we recommend you not to alter the default settings to prevent system instability or other unexpected results. (Inadequately altering the settings may result in system's failure to boot. If this occurs, clear the CMOS values and reset the board to default values.)



This section provides information on the BIOS version, CPU base clock, CPU frequency, memory frequency, total memory size, CPU temperature, Vcore, and memory voltage.

▶ **M.I.T. Current Status**

This screen provides information on CPU/memory frequencies/parameters.

▶ **Advanced Frequency Settings**



☞ **BCLK Clock Control**

Allows you to manually set the CPU base clock in 1 MHz increments. (Default: Auto)

Important: It is highly recommended that the CPU frequency be set in accordance with the CPU specifications.

☞ **CPU NorthBridge Frequency**

Allows you to alter the North Bridge controller frequency for the installed CPU. The adjustable range is dependent on the CPU being installed.

☞ **HT Link Frequency**

Allows you to manually set the frequency for the HT Link between the CPU and chipset. The adjustable range is from 200 MHz to 3200 MHz. (Default: Auto)

☞ **CPU Clock Ratio**

Allows you to alter the clock ratio for the installed CPU. The adjustable range is dependent on the CPU being installed.

☞ **CPU Frequency**

Displays the current operating CPU frequency.

▶ Advanced CPU Core Features



☞ CPU Clock Ratio, CPU Frequency

The settings above are synchronous to those under the same items on the **Advanced Frequency Settings** menu.

☞ Core Performance Boost ^(Note)

Allows you to determine whether to enable the Core Performance Boost (CPB) technology, a CPU performance-boost technology. (Default: Auto)

☞ CPB Ratio ^(Note)

Allows you alter the ratio for the CPB. The adjustable range is dependent on the CPU being installed. (Default: Auto)

☞ CPU Unlock ^(Note)

Allows you to determine whether unlock hidden CPU cores. (Default: Disabled)

☞ Cool & Quiet

- ▶▶ Enabled Lets the AMD Cool'n'Quiet driver dynamically adjust the CPU clock and VID to reduce heat output from your computer and its power consumption. (Default)
- ▶▶ Disabled Disables this function.

☞ C1E Support

Allows you to determine whether to let the CPU enter C1 mode in system halt state. When enabled, the CPU core frequency and voltage will be reduced during system halt state to decrease power consumption. (Default: Enabled)

☞ SVM

Virtualization enhanced by Virtualization Technology will allow a platform to run multiple operating systems and applications in independent partitions. With virtualization, one computer system can function as multiple virtual systems. (Default: Enabled)

(Note) This item is present only when you install a CPU that supports this feature.

☞ **CPU core Control** ^(Note 1)

Allows you to determine whether to manually enable/disable CPU cores. **Automatic mode** allows the BIOS to enable all CPU cores (number of cores available depends on the CPU being used). (Default: Automatic mode)

☞ **Core C6 State** ^(Note 1)

Allows you to determine whether to let the CPU enter C6 mode in system halt state. When enabled, the CPU core frequency will be reduced during system halt state to decrease power consumption. The C6 state is a more enhanced power-saving state than C1. (Default: Enabled)

☞ **HPC Mode** ^(Note 1)

Allows you to determine whether to enable High Performance Computing (HPC) mode for the CPU. **Enabled** prevents the CPU frequency from being lowered during system halt state. (Default: Disabled)

☞ **APM (AMD Application Power Management)** ^(Note 1)

- ▶▶ Enabled Dynamically monitors the power consumption of the CPU cores and automatically optimizes the CPU to its best performance level. (Default)
- ▶▶ Disabled Disables this function.

☞ **Extreme Memory Profile (X.M.P.)** ^(Note 2)

Allows the BIOS to read the SPD data on XMP memory module(s) to enhance memory performance when enabled.

- ▶▶ Disabled Disables this function. (Default)
- ▶▶ Profile1 Uses Profile 1 settings.
- ▶▶ Profile2 ^(Note 2) Uses Profile 2 settings.

☞ **System Memory Multiplier**

Allows you to set the system memory multiplier. **Auto** sets memory multiplier according to memory SPD data. (Default: Auto)

☞ **Memory Frequency (MHz)**

This value is automatically adjusted according to the **BCLK Clock Control** and **System Memory Multiplier** settings.

(Note 1) This item is present only when you install a CPU that supports this feature.

(Note 2) This item is present only when you install a memory module that supports this feature.

▶ Advanced Memory Settings



☞ **Extreme Memory Profile (X.M.P.)** ^(Note), **System Memory Multiplier**, **Memory Frequency(MHz)**
The settings above are synchronous to those under the same items on the **Advanced Frequency Settings** menu.

☞ **DRAM Timing Selectable**

Quick and **Expert** allows the memory timing settings below to be configurable. Options are: Auto (default), Quick, Expert.

☞ **Profile DDR Voltage**

When using a non-XMP memory module or **Extreme Memory Profile (X.M.P.)** is set to **Disabled**, this item will display as **1.50V**. When **Extreme Memory Profile (X.M.P.)** is set to **Profile1** or **Profile2**, this item will display the value based on the SPD data on the XMP memory.

☞ **Profile VTT Voltage**

The value displayed here is dependent on the CPU being used.

☞ **Channel Interleaving**

Enables or disables memory channel interleaving. **Enabled** allows the system to simultaneously access different channels of the memory to increase memory performance and stability. **Auto** lets the BIOS automatically configure this setting. (Default: Auto)

☞ **Rank Interleaving**

Enables or disables memory rank interleaving. **Enabled** allows the system to simultaneously access different ranks of the memory to increase memory performance and stability. **Auto** lets the BIOS automatically configure this setting. (Default: Auto)

(Note) This item is present only when you install a memory module that supports this feature.

▶ Channel A/B Timing Settings

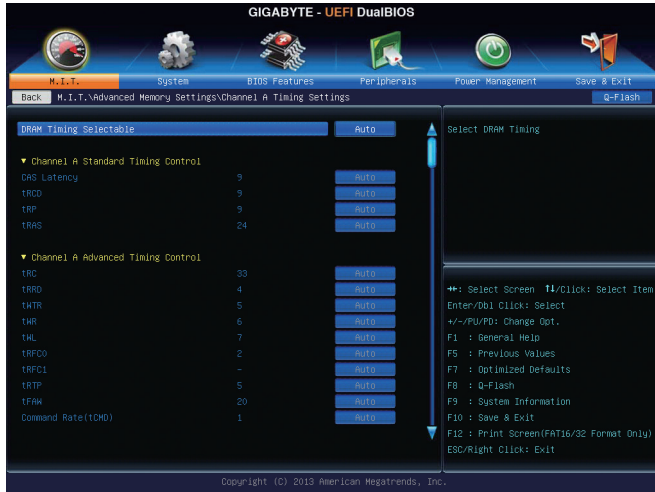

This sub-menu provides memory timing settings for each channel of memory. The respective timing setting screens are configurable only when **DRAM Timing Selectable** is set to **Quick** or **Expert**. Note: Your system may become unstable or fail to boot after you make changes on the memory timings. If this occurs, please reset the board to default values by loading optimized defaults or clearing the CMOS values.

▶ Advanced Voltage Settings



This sub-menu allows you to set CPU, chipset and memory voltages.

► PC Health Status



⦿ Reset Case Open Status

- ▶▶ Disabled Keeps or clears the record of previous chassis intrusion status. (Default)
- ▶▶ Enabled Clears the record of previous chassis intrusion status and the **Case Open** field will show "No" at next boot.

⦿ Case Open

Displays the detection status of the chassis intrusion detection device attached to the motherboard CI header. If the system chassis cover is removed, this field will show "Yes", otherwise it will show "No". To clear the chassis intrusion status record, set **Reset Case Open Status** to **Enabled**, save the settings to the CMOS, and then restart your system.

- ☞ **CPU Vcore/Dram Voltage/+3.3V/+5V/+12V**
Displays the current system voltages.
- ☞ **CPU/System Temperature**
Displays current CPU/system temperature.
- ☞ **CPU/System/Power Fan Speed**
Displays current CPU/system/power fan speed.
- ☞ **CPU Warning Temperature**
Sets the warning threshold for CPU temperature. When CPU temperature exceeds the threshold, BIOS will emit warning sound. Options are: Disabled (default), 60°C/140°F, 70°C/158°F, 80°C/176°F, 90°C/194°F.
- ☞ **CPU/System/Power Fan Fail Warning**
Allows the system to emit warning sound if the fan is not connected or fails. Check the fan condition or fan connection when this occurs. (Default: Disabled)
- ☞ **CPU Fan Control mode**
 - ▶▶ Auto Lets the BIOS automatically detect the type of CPU fan installed and sets the optimal CPU fan control mode. (Default)
 - ▶▶ Voltage Sets Voltage mode for a 3-pin CPU fan.
 - ▶▶ PWM Sets PWM mode for a 4-pin CPU fan.
- ☞ **CPU Fan Speed Control**
Allows you to determine whether to enable the fan speed control function and adjust the fan speed.
 - ▶▶ Normal Allows the fan to run at different speeds according to the CPU temperature. You can adjust the fan speed with EasyTune based on your system requirements. (Default)
 - ▶▶ Silent Allows the fan to run at slow speeds.
 - ▶▶ Manual Allows you to control the fan speed under the **Slope PWM** item.
 - ▶▶ Disabled Allows the fan to run at full speeds.
- ☞ **Slope PWM**
Allows you to control the CPU fan speed. This item is configurable only when **CPU Fan Speed Control** is set to **Manual**. Options are: 0.75 PWM value /°C ~ 2.50 PWM value /°C.
- ☞ **1st System Fan Speed Control (SYS_FAN1 Connector)**
Allows you to determine whether to enable the fan speed control function and adjust the fan speed.
 - ▶▶ Normal Allows the system fan to run at different speeds according to the system temperature. You can adjust the fan speed with EasyTune based on your system requirements. (Default)
 - ▶▶ Silent Allows the system fan to run at slow speeds.
 - ▶▶ Manual Allows you to control the system fan speed under the **Slope PWM** item.
 - ▶▶ Disabled Allows the system fan to run at full speeds.
- ☞ **Slope PWM**
Allows you to control the system fan speed. This item is configurable only when **1st System Fan Speed Control** is set to **Manual**. Options are: 0.75 PWM value /°C ~ 2.50 PWM value /°C.

2-4 System



This section provides information on your motherboard model and BIOS version. You can also select the default language used by the BIOS and manually set the system time.

System Language

Selects the default language used by the BIOS.

System Date

Sets the system date. The date format is week (read-only), month, date, and year. Use <Enter> to switch between the Month, Date, and Year fields and use the <Page Up> or <Page Down> key to set the desired value.

System Time

Sets the system time. The time format is hour, minute, and second. For example, 1 p.m. is 13:0:0. Use <Enter> to switch between the Hour, Minute, and Second fields and use the <Page Up> or <Page Down> key to set the desired value.

Access Level

Displays the current access level depending on the type of password protection used. (If no password is set, the default will display as Administrator.) The Administrator level allows you to make changes to all BIOS settings; the User level only allows you to make changes to certain BIOS settings but not all.

ATA Port Information

This section provides information on the device connected to each SATA port controlled by AMD Chipset.

2-5 BIOS Features



☞ **Boot Option Priorities**

Specifies the overall boot order from the available devices. For example, you can set hard drive as the first priority (**Boot Option #1**) and DVD ROM drive as the second priority (**Boot Option #2**). The list only displays the device with the highest priority for a specific type. For example, only hard drive defined as the first priority on the **Hard Drive BBS Priorities** submenu will be presented here.

Removable storage devices that support GPT format will be prefixed with "UEFI:" string on the boot device list. To boot from an operating system that supports GPT partitioning, select the device prefixed with "UEFI:" string.

Or if you want to install an operating system that supports GPT partitioning such as Windows 7 64-bit, select the optical drive that contains the Windows 7 64-bit installation disk and is prefixed with "UEFI:" string.

☞ **Hard Drive/CD/DVD ROM Drive/Floppy Drive/Network Device BBS Priorities**

Specifies the boot order for a specific device type, such as hard drives, optical drives, floppy disk drives, and devices that support Boot from LAN function, etc. Press <Enter> on this item to enter the submenu that presents the devices of the same type that are connected. This item is present only if at least one device for this type is installed.

☞ **Bootup NumLock State**

Enables or disables Numlock feature on the numeric keypad of the keyboard after the POST. (Default: Enabled)

☞ **Security Option**

Specifies whether a password is required every time the system boots, or only when you enter BIOS Setup. After configuring this item, set the password(s) under the **Administrator Password/User Password** item.

- ▶▶ Setup A password is only required for entering the BIOS Setup program.
- ▶▶ System A password is required for booting the system and for entering the BIOS Setup program. (Default)

☞ **Full Screen LOGO Show**

Allows you to determine whether to display the GIGABYTE Logo at system startup. **Disabled** skips the GIGABYTE Logo when the system starts up. (Default: Enabled)

☞ **OS Type**

Allows you to select the operating system to be installed. (Default: Other OS)

☞ **CSM Support**

Enables or disables UEFI CSM (Compatibility Support Module) to support a legacy PC boot process.

- ▶▶ Always Enables UEFI CSM. (Default)
- ▶▶ Never Disables UEFI CSM and supports UEFI BIOS boot process only.

This item is configurable only when **OS Type** is set to **Windows 8**.

☞ **Boot Mode Selection**

Allows you to select which type of operating system to boot.

- ▶▶ UEFI and Legacy Allows booting from operating systems that support legacy option ROM or UEFI option ROM. (Default)
- ▶▶ Legacy Only Allows booting from operating systems that only support legacy Option ROM.
- ▶▶ UEFI Only Allows booting from operating systems that only support UEFI Option ROM.

This item is configurable only when **CSM Support** is set to **Always**.

☞ **LAN PXE Boot Option ROM**

Allows you to select whether to enable the legacy option ROM for the LAN controller. (Default: Disabled)

This item is configurable only when **CSM Support** is set to **Always**.

☞ **Storage Boot Option Control**

Allows you to select whether to enable the UEFI or legacy option ROM for the storage device controller.

- ▶▶ Disabled Disables option ROM.
- ▶▶ Legacy Only Enables legacy option ROM only. (Default)
- ▶▶ UEFI Only Enables UEFI option ROM only.
- ▶▶ Legacy First Enables legacy option ROM first.
- ▶▶ UEFI First Enables UEFI option ROM first.

This item is configurable only when **CSM Support** is set to **Always**.

☞ **Other PCI Device ROM Priority**

Allows you to select whether to enable the UEFI or Legacy option ROM for the PCI device controller other than the LAN, storage device, and graphics controllers.

- ▶▶ Legacy OpROM Enables legacy option ROM only.
- ▶▶ UEFI OpROM Enables UEFI option ROM only. (Default)

☞ **Network stack**

Disables or enables booting from the network to install a GPT format OS, such as installing the OS from the Windows Deployment Services server. (Default: Disable)

☞ **Ipv4 PXE Support**

Enables or disables IPv4 PXE Support. This item is configurable only when **Network stack** is enabled.

☞ **Ipv6 PXE Support**

Enables or disables IPv6 PXE Support. This item is configurable only when **Network stack** is enabled.

↪ **Administrator Password**

Allows you to configure an administrator password. Press <Enter> on this item, type the password, and then press <Enter>. You will be requested to confirm the password. Type the password again and press <Enter>. You must enter the administrator password (or user password) at system startup and when entering BIOS Setup. Differing from the user password, the administrator password allows you to make changes to all BIOS settings.

↪ **User Password**

Allows you to configure a user password. Press <Enter> on this item, type the password, and then press <Enter>. You will be requested to confirm the password. Type the password again and press <Enter>. You must enter the administrator password (or user password) at system startup and when entering BIOS Setup. However, the user password only allows you to make changes to certain BIOS settings but not all.

To cancel the password, press <Enter> on the password item and when requested for the password, enter the correct one first. When prompted for a new password, press <Enter> without entering any password. Press <Enter> again when prompted to confirm.

2-6 Peripherals



- **OnChip SATA Controller**
Enables or disables the integrated SATA controllers. (Default: Enabled)
- **OnChip SATA Type**
Enables or disables RAID for the SATA controllers integrated in the Chipset or configures the SATA controllers to AHCI mode.
 - ▶▶ Native IDE Configures the SATA controller to IDE mode. (Default)
 - ▶▶ RAID Enables RAID for the SATA controller.
 - ▶▶ AHCI Configures the SATA controllers to AHCI mode. Advanced Host Controller Interface (AHCI) is an interface specification that allows the storage driver to enable advanced Serial ATA features such as Native Command Queuing and hot plug.
- **OnChip SATA Port4/5 Type (SATA3 4/SATA3 5 connectors)**
This option is configurable only when **OnChip SATA Type** is set to **RAID** or **AHCI**. Configures the operating mode of the integrated SATA3 4~SATA3 5 connectors.
 - ▶▶ As SATA Type The mode depends on the OnChip SATA Type settings.
 - ▶▶ IDE Configures the SATA3 4~SATA3 5 connectors to IDE mode. (Default)
- **HD Audio Azalia Device**
Enables or disables the onboard audio function. (Default: Enabled)
If you wish to install a 3rd party add-in audio card instead of using the onboard audio, set this item to **Disabled**.
- **Onboard USB Device**
Enables or disables the integrated USB controller. (Default: Enabled)
- **USB3.0 Controller (VIA® VL805 USB Controller)**
Enables or disables the VIA® VL805 USB controller. (Default: Enabled)

☞ **Onboard LAN Controller**

Enables or disables the onboard LAN function. (Default: Enabled)

If you wish to install a 3rd party add-in network card instead of using the onboard LAN, set this item to **Disabled**.

☞ **Legacy USB Support**

Allows USB keyboard/mouse to be used in MS-DOS. (Default: Enabled)

☞ **XHCI Hand-off**

Determines whether to enable XHCI Hand-off feature for an operating system without XHCI Hand-off support. (Default: Enabled)

☞ **EHCI Hand-off**

Determines whether to enable EHCI Hand-off feature for an operating system without EHCI Hand-off support. (Default: Disabled)

☞ **Port 60/64 Emulation**

Enables or disables emulation of I/O ports 64h and 60h. This should be enabled for full legacy support for USB keyboards/mice in MS-DOS or in operating system that does not natively support USB devices. (Default: Disabled)

☞ **USB Storage Devices**

Displays a list of connected USB mass storage devices. This item appears only when a USB storage device is installed.

☞ **IOMMU Controller**

Enables or disables AMD IOMMU support. (Default: Disabled)

▶ **Trusted Computing**

☞ **TPM SUPPORT**

Enables or disables Trusted Platform Module (TPM). Set this item to **Enable** when a TPM device is installed. (Default: Disable)

▶ SB SATA Configuration



- **SATA Hot Plug on PORT0~SATA Hot Plug on PORT5**
Enables or disable the hot plug capability for each SATA port. (Default: Disabled)
- **SATA Power on PORT0~SATA Power on PORT5**
Enables or disables each SATA port. (Default: Enabled)

▶ Super IO Configuration

This section provides information on the super I/O chip and allows you to configure the serial port.

- **Serial Port A**
Enables or disables the onboard serial port. (Default: Enabled)

2-7 Power Management



☞ Resume by Alarm

Determines whether to power on the system at a desired time. (Default: Disabled)

If enabled, set the date and time as following:

- ▶▶ Wake up day: Turn on the system at a specific time on each day or on a specific day in a month.
- ▶▶ Wake up hour/minute/second: Set the time at which the system will be powered on automatically.

Note: When using this function, avoid inadequate shutdown from the operating system or removal of the AC power, or the settings may not be effective.

☞ HPET Support

Enables or disables High Precision Event Timer (HPET) for Windows 8/7 operating system. (Default: Enabled)

☞ Soft-Off by PWR-BTTN

Configures the way to turn off the computer in MS-DOS mode using the power button.

- ▶▶ Instant-Off Press the power button and then the system will be turned off instantly. (Default)
- ▶▶ Delay 4 Sec Press and hold the power button for 4 seconds to turn off the system. If the power button is pressed for less than 4 seconds, the system will enter suspend mode.

☞ AC BACK

Determines the state of the system after the return of power from an AC power loss.

- ▶▶ Memory The system returns to its last known awake state upon the return of the AC power.
- ▶▶ Always On The system is turned on upon the return of the AC power.
- ▶▶ Always Off The system stays off upon the return of the AC power. (Default)

(Note) Supported on Windows 8/7 operating system only.

☞ **Power On By Keyboard**

Allows the system to be turned on by a PS/2 keyboard wake-up event.

Note: To use this function, you need an ATX power supply providing at least 1A on the +5VSB lead.

- ▶▶ Disabled Disables this function. (Default)
- ▶▶ Password Set a password with 1~5 characters to turn on the system.
- ▶▶ Keyboard 98 Press POWER button on the Windows 98 keyboard to turn on the system.
- ▶▶ Any key Press any key to turn on the system.

☞ **Power On Password**

Set the password when **Power On By Keyboard** is set to **Password**.

Press <Enter> on this item and set a password with up to 5 characters and then press <Enter> to accept.

To turn on the system, enter the password and press <Enter>.

Note: To cancel the password, press <Enter> on this item. When prompted for the password, press <Enter> again without entering the password to clear the password settings.

☞ **Power On By Mouse**

Allows the system to be turned on by a PS/2 mouse wake-up event.

Note: To use this function, you need an ATX power supply providing at least 1A on the +5VSB lead.

- ▶▶ Disabled Disables this function. (Default)
- ▶▶ Move Move the mouse to turn on the system.
- ▶▶ Double Click Double click on left button on the mouse to turn on the system.

☞ **ErP**

Determines whether to let the system consume least power in S5 (shutdown) state. (Default: Disabled)

Note: When this item is set to **Enabled**, the following functions will become unavailable: PME event wake up, power on by mouse, power on by keyboard, and wake on LAN.

2-8 Save & Exit

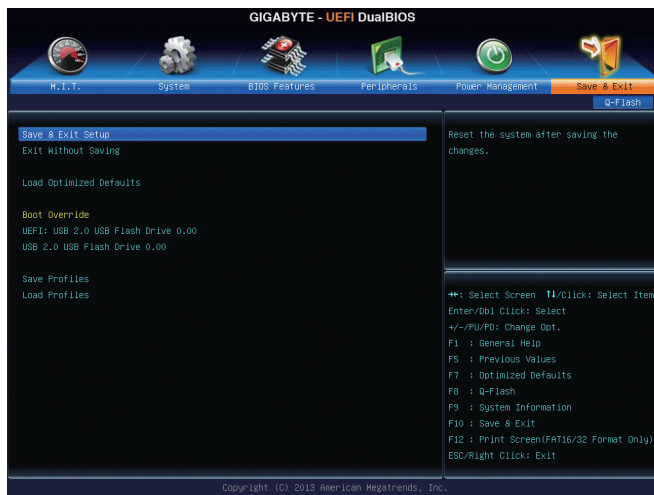

Save & Exit Setup

Press <Enter> on this item and select **Yes**. This saves the changes to the CMOS and exits the BIOS Setup program. Select **No** or press <Esc> to return to the BIOS Setup Main Menu.

Exit Without Saving

Press <Enter> on this item and select **Yes**. This exits the BIOS Setup without saving the changes made in BIOS Setup to the CMOS. Select **No** or press <Esc> to return to the BIOS Setup Main Menu.

Load Optimized Defaults

Press <Enter> on this item and select **Yes** to load the optimal BIOS default settings. The BIOS defaults settings help the system to operate in optimum state. Always load the Optimized defaults after updating the BIOS or after clearing the CMOS values.

Boot Override

Allows you to select a device to boot immediately. Press <Enter> on the device you select and select **Yes** to confirm. Your system will restart automatically and boot from that device.

Save Profiles

This function allows you to save the current BIOS settings to a profile. You can create up to 8 profiles and save as Setup Profile 1~ Setup Profile 8. Press <Enter> to complete. Or you can select **Select File in HDD/USB/FDD** to save the profile to your storage device.

Load Profiles

If your system becomes unstable and you have loaded the BIOS default settings, you can use this function to load the BIOS settings from a profile created before, without the hassles of reconfiguring the BIOS settings. First select the profile you wish to load and then press <Enter> to complete. You can select **Select File in HDD/USB/FDD** to input the profile previously created from your storage device or load the profile automatically created by the BIOS, such as reverting the BIOS settings to the last settings that worked properly (last known good record).

Chapter 3 Configuring SATA Hard Drive(s)

RAID Levels

	RAID 0	RAID 1	RAID 5	RAID 10
Minimum Number of Hard Drives	≥2	2	≥3	≥4
Array Capacity	Number of hard drives * Size of the smallest drive	Size of the smallest drive	(Number of hard drives - 1) * Size of the smallest drive	(Number of hard drives/2) * Size of the smallest drive
Fault Tolerance	No	Yes	Yes	Yes

To configure SATA hard drive(s), follow the steps below:

- A. Install SATA hard drive(s) in your computer.
- B. Configure SATA controller mode in BIOS Setup.
- C. Configure a RAID array in RAID BIOS ^(Note 1)
- D. Install the SATA RAID/AHCI driver and operating system ^(Note 2)

Before you begin

- At least two SATA hard drives (to ensure optimal performance, it is recommended that you use two hard drives with identical model and capacity). If you do not want to create RAID, you may prepare only one hard drive.
- Windows 8/7/XP setup disk.
- Motherboard driver disk.
- A USB flash drive
- A USB floppy disk drive (needed during Windows XP installation)
- An empty formatted floppy disk (needed during Windows XP installation)

3-1 Configuring SATA Controllers

A. Installing SATA hard drive(s) in your computer

Attach one end of the SATA signal cable to the rear of the SATA hard drive and the other end to available SATA port on the motherboard. Then connect the power connector from your power supply to the hard drive.

(Note 1) Skip this step if you do not want to create RAID array on the SATA controller.

(Note 2) Required when the SATA controller is set to AHCI or RAID mode.

B. Configuring SATA controller mode in BIOS Setup

Make sure to configure the SATA controller mode correctly in system BIOS Setup.

Step 1:

Turn on your computer and press <Delete> to enter BIOS Setup during the POST (Power-On Self-Test). Ensure **OnChip SATA Channel** is enabled under **Peripherals**. To enable RAID for the SATA3 0/1/2/3 connectors, set **OnChip SATA Type** to **RAID**. To enable RAID for the SATA3 4/SATA3 5 connectors, set **OnChip SATA Type** to **RAID** and set **OnChip SATA Port4/5 Type** to **As SATA Type**.

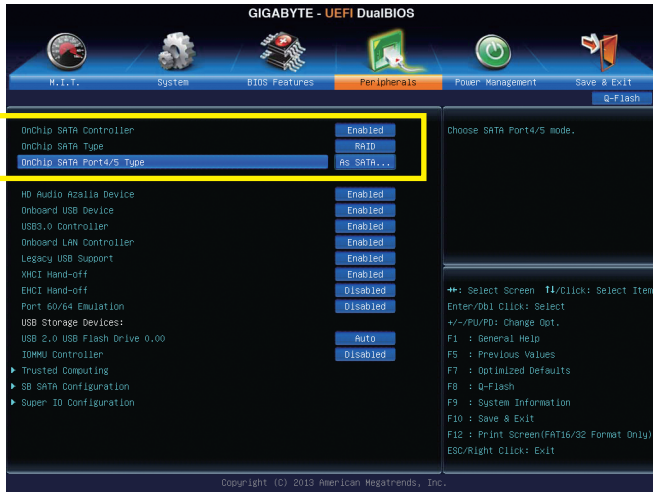

Figure 1

Step 2:

Save changes and exit BIOS Setup.



The BIOS Setup menus described in this section may differ from the exact settings for your motherboard. The actual BIOS Setup menu options you will see shall depend on the motherboard you have and the BIOS version.

C. Configuring a RAID array in RAID BIOS

Enter the RAID BIOS setup utility to configure a RAID array. Skip this step if you do not want to create RAID array on the SATA controller.

Step 1:

After the POST memory test begins and before the operating system boot begins, look for a message which says "Press <Ctrl-F> to enter RAID Option ROM Utility" (Figure 2). Press <Ctrl> + <F> to enter the RAID BIOS setup utility.

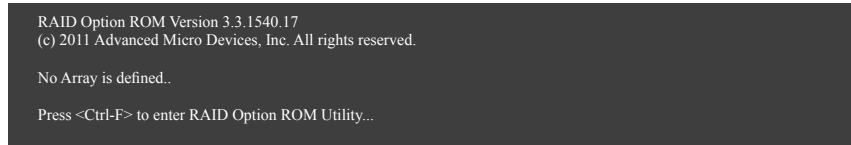

Figure 2

Step 2:

Main Menu

(Figure 3)

To view the disk drives assigned to arrays, press <1> to enter the **View Drive Assignments** window.

To create an array, press <2> to enter the **LD View/LD Define Menu** window.

To delete an array, press <3> to enter the **Delete LD Menu** window.

To view controller settings, press <4> to enter the **Controller Configuration** window.

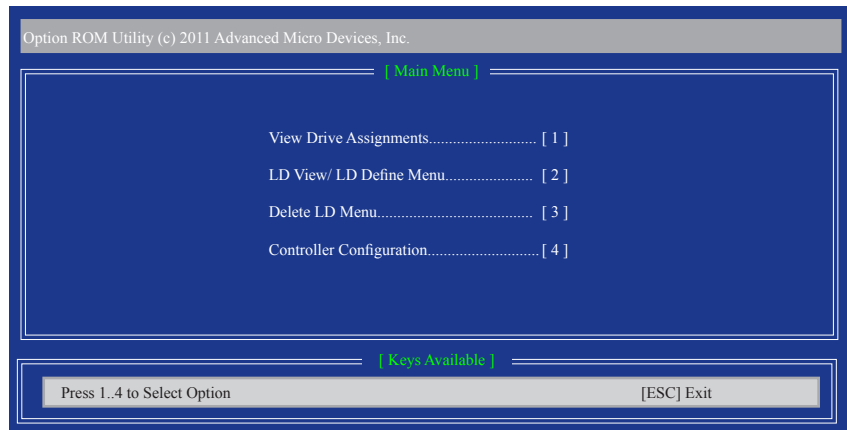

Figure 3

Create a RAID Array

To create a new array, press <2> to enter the **LD View Menu** window (Figure 4). To create an array, press <Ctrl+C> to access the **LD Define Menu**.

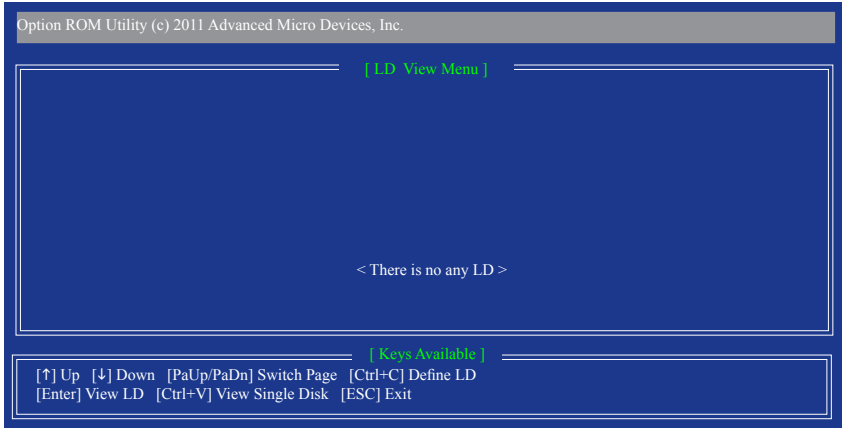

Figure 4

In the **LD Define Menu**, use the up or down arrow key to move to an item for further configuration (Figure 5).

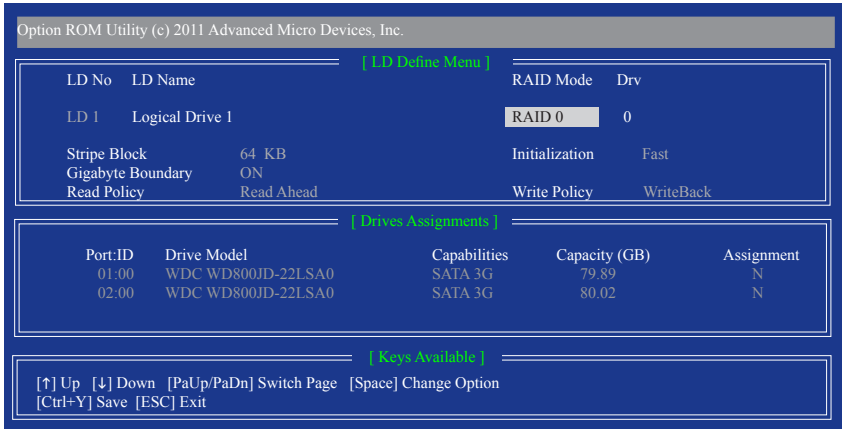
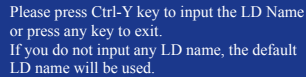

Figure 5

In the following procedure, we'll create RAID 0 as an example.

Steps:

1. Under the **RAID Mode** section, press the <SPACE> key to select **RAID 0**.
2. Set the **Stripe Block** size. 64 KB is the default.
3. Under the **Drives Assignments** section, press the up or down arrow key to highlight a drive.
4. Press the <SPACE> key or <Y> to change the **Assignment** option to **Y**. This action adds the drive to the disk array. The **Total Drv** section will show the number of disks assigned.
5. Press <Ctrl>+<Y> keys to save the information. The message in Figure 6 will appear. Press <Ctrl>+<Y> to input the array name. If you do not input the array name, the default array name will be used.



Please press Ctrl-Y key to input the LD Name
or press any key to exit.
If you do not input any LD name, the default
LD name will be used.

Figure 6

6. When the next message appears, press <Ctrl>+<Y> to clear the MBR or press other keys to ignore this option. Then, the message in Figure 7 will appear.

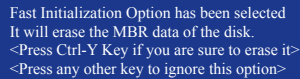

Fast Initialization Option has been selected
It will erase the MBR data of the disk.
<Press Ctrl-Y Key if you are sure to erase it>
<Press any other key to ignore this option>

Figure 7

7. Press <Ctrl>+<Y> to set the capacity of the RAID array or press other keys to set the array to its maximum capacity.



Press Ctrl-Y to Modify Array Capacity or press any
other key to use maximum capacity...

Figure 8

8. After the creation is complete, the screen will return to **LD View Menu** where you will see the newly-created array.
9. Press <Esc> to return to **Main Menu** and press <Esc> again if you want to exit the RAID BIOS utility.

View Drive Assignments

The **View Drive Assignments** option in the **Main Menu** displays whether the attached hard drives are assigned to a disk array or are unassigned. Under the **Assignment** column, drives are labeled with their assigned disk array or shown as **Free** if unassigned.

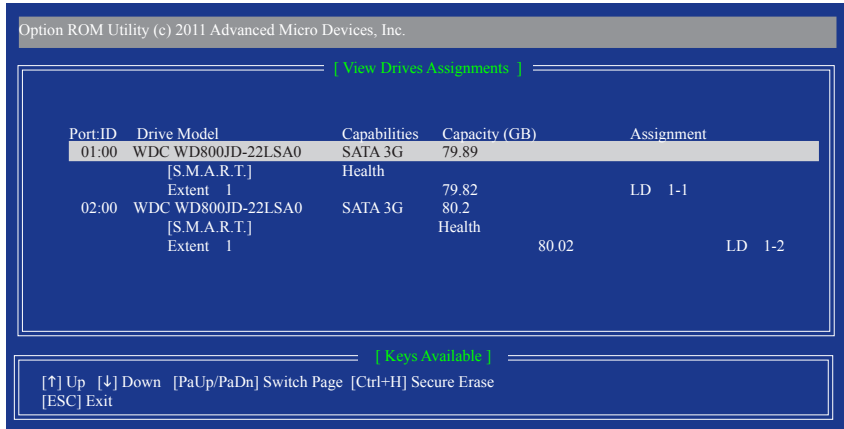

Figure 9

Delete an Array

The **Delete Array** menu option allows for deletion of disk array assignments.



Deleting an existing disk array could result in loss of data. Record all array information including the array type, the disk members, and stripe block size in case you wish to undo a deletion.

1. To delete an array, press <3> in the **Main Menu** to enter the **Delete LD Menu**. Then highlight the array you wish to delete and press the <Delete> key or the <Alt>+<D> keys.
2. The **View LD Definition Menu** will appear (as shown in Figure 10) showing which drives are assigned to this array. Press <Ctrl>+<Y> if you are sure to delete the array or other keys to abort.
3. When the array is deleted, the screen will return to **Delete LD Menu**. Press <Esc> to return to Main Menu.

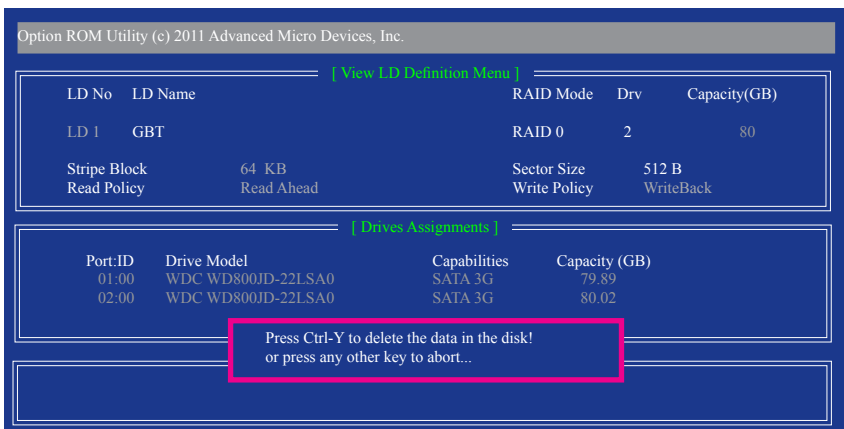

Figure 10

3-2 Installing the SATA RAID/AHCI Driver and Operating System

With the correct BIOS settings, you are ready to install the operating system.

A. Installing Windows 8/7

(The following instructions use Windows 8 as the example operating system.)

Step 1:

You need to install the SATA RAID/AHCI driver during the OS installation. Use an alternative system to copy the SATA RAID/AHCI driver from the motherboard driver disk to a USB flash drive. Copy the **Hw8** folder under **BootDrv** in the driver disk.

Step 2:

Boot from the Windows 8 setup disk and perform standard OS installation steps. When the screen requesting you to load the driver appears, select **Browse**.

Step 3:

Then browse to the USB flash drive and select the location of the driver. The locations of the drivers are as follows:

RAID driver for Windows 8 32-bit: Hw8\RAID\x86

RAID driver for Windows 8 64-bit: Hw8\RAID\x64

AHCI driver for Windows 8 32-bit: Hw8\AHCI\W8

AHCI driver for Windows 8 64-bit: Hw8\AHCI\W864A

For Windows 7, browse to the **Hw7** folder.

Step 4:

When a screen as shown in Figure 1 appears, select **AMD AHCI Compatible RAID Controller (C:\Hw8\RAID\x64\ahci64.inf)** and click **Next** to load the driver and continue the OS installation.

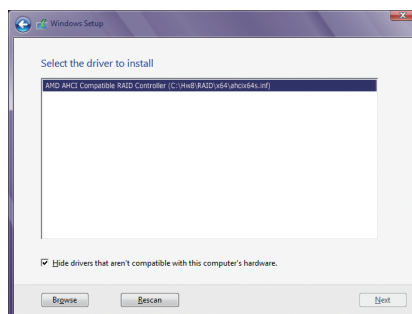

Figure 1

B. Installing Windows XP

Before installing Windows XP, connect a USB floppy disk drive to your computer first because you need to install the SATA RAID/AHCI driver from a floppy disk that contains the driver during the OS installation. Without the driver, the hard drive(s) may not be recognized during the Windows setup process. First, copy the driver from the motherboard driver disk to a floppy disk. Refer to the methods below.

Method A:

- For the AMD SB950, copy all files in the `\BootDrv\Hxp` folder to your floppy disk.

Method B:

Steps:

- 1: Use an alternative system and insert the motherboard driver disk.
- 2: From your optical drive folder, double click the **Menu.exe** file in the **BootDrv** folder. A Command Prompt window will open similar to that in Figure 2.
- 3: Insert the blank formatted disk (if you're using a USB floppy disk drive, make sure it is designated as drive A). Select the controller driver by pressing the corresponding letter from the menu and press <Enter>. For example, from the menu in Figure 2, for the AMD SB950, select **6) hseries AHCI/RAID for XP**.

Your system will then automatically copy the driver files to the floppy disk. Press any key to exit when finished.

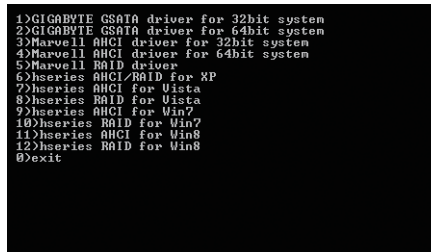

```
1)GIGABYTE SATA driver for 32bit system
2)GIGABYTE SATA driver for 64bit system
3)Marvell AHCI driver for 32bit system
4)Marvell AHCI driver for 64bit system
5)Marvell RAID driver
6)hseries AHCI/RAID for XP
7)hseries AHCI for Vista
8)hseries RAID for Vista
9)hseries AHCI for Win7
10)hseries RAID for Win7
11)hseries AHCI for Win8
12)hseries RAID for Win8
0)exit
```

Figure 2

Refer to the following for installing the driver during the Windows setup process.

Step 1:

Restart your system to boot from the Windows XP setup disk and press <F6> as soon as you see the message "Press F6 if you need to install a 3rd party SCSI or RAID driver." A screen will then appear asking you to specify an additional SCSI adapter. Press <S>.

Step 2:

Insert the floppy disk containing the SATA RAID/AHCI driver and press <Enter>. Then a controller menu similar to that in Figure 3 will appear. Select AMD AHCI Compatible RAID Controller-x86 platform and press <Enter>.

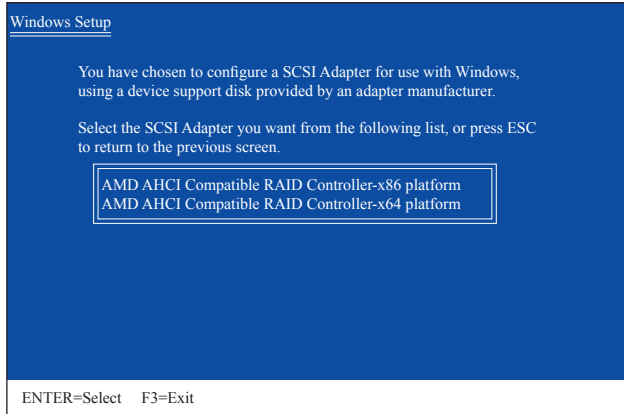

Figure 3

Step 3:

On the next screen, press <Enter> to continue the driver installation. After the driver installation, you can proceed with the Windows XP installation.

Rebuilding an Array:

Rebuilding is the process of restoring data to a hard drive from other drives in the array. Rebuilding applies only to fault-tolerant arrays such as RAID 1, RAID 5, and RAID 10 arrays. To replace the old drive, make sure to use a new drive of equal or greater capacity. The procedures below assume a new drive is added to replace a failed drive to rebuild a RAID 1 array.

While in the operating system, make sure the Chipset driver has been installed from the motherboard driver disk. Then install the AMD RAID Utility (go to Application Software\Install Application Software and select **AMD RAID Utility** to install). Then launch the AMD RAIDxpert from All Programs in the Start Menu.

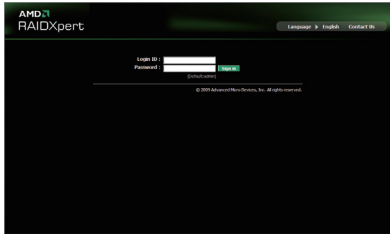

Step 1:
Enter the login ID and password (default: "admin"), and then click **Sign in** to launch **AMD RAIDxpert**.

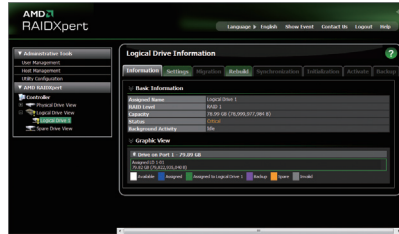

Step 2:
Select the RAID array to be rebuilt under **Logical Drive View** and click the **Rebuild** tab in the **Logical Drive Information** pane.

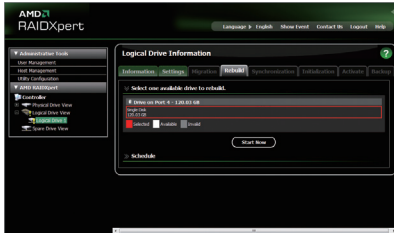

Step 3:
Select one available drive and click **Start Now** to start the rebuilding process.

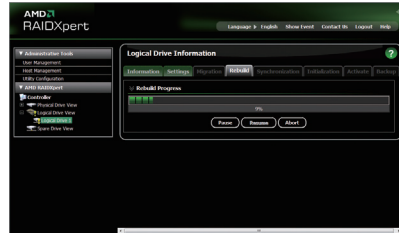

Step 4:
The rebuilding progress is displayed on the screen and you can select **Pause/Resume/Abort** during the rebuilding process.

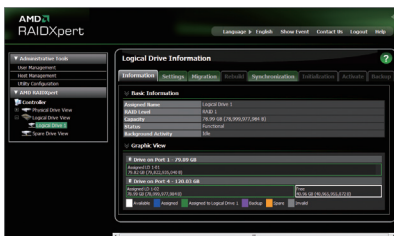

Step 5:
When done, the array's status on the **Information** page in the **Logical Drive Information** pane will display as **Functional**.

Chapter 4 Drivers Installation



- Before installing the drivers, first install the operating system.
- After installing the operating system, insert the motherboard driver disk into your optical drive. The driver Autorun screen is automatically displayed which looks like that shown in the screen shot below. (If the driver Autorun screen does not appear automatically, go to My Computer, double-click the optical drive and execute the **Run.exe** program.)

4-1 Installing Chipset Drivers



Now Loading Please wait...

After inserting the driver disk, "Xpress Install" will automatically scan your system and then list all the drivers that are recommended to install. You can click the **Install All** button and "Xpress Install" will install all the recommended drivers. Or click **Install Single** Items to manually select the drivers you wish to install.

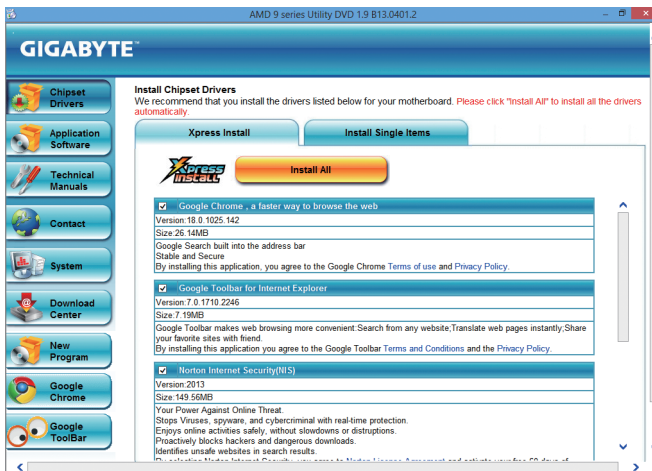

- Please ignore the popup dialog box(es) (e.g. the **Found New Hardware Wizard**) displayed when "Xpress Install" is installing the drivers. Failure to do so may affect the driver installation.
- Some device drivers will restart your system automatically during the driver installation. After the system restart, "Xpress Install" will continue to install other drivers.
- After "Xpress Install" installs all of the drivers, a dialog box will appear asking whether to install new GIGABYTE utilities. Click **Yes** to automatically install the utilities. Or click **No** if you want to manually select the utilities to install on the **Application Software** page later.
- For USB 2.0 driver support under the Windows XP operating system, please install the Windows XP Service Pack 1 or later. After installing the SP1 (or later), if a question mark still exists in **Universal Serial Bus Controller in Device Manager**, please remove the question mark (by right-clicking your mouse and select **Uninstall**) and restart the system. (The system will then autodetect and install the USB 2.0 driver.)

4-2 Application Software

This page displays all the utilities and applications that GIGABYTE develops and some free software. You can click the **Install** button on the right of an item to install it.

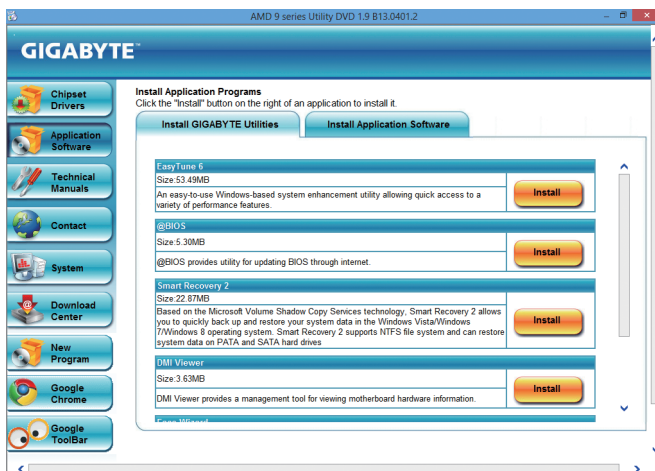

4-3 Technical Manuals

This page provides the content descriptions for this driver disk.

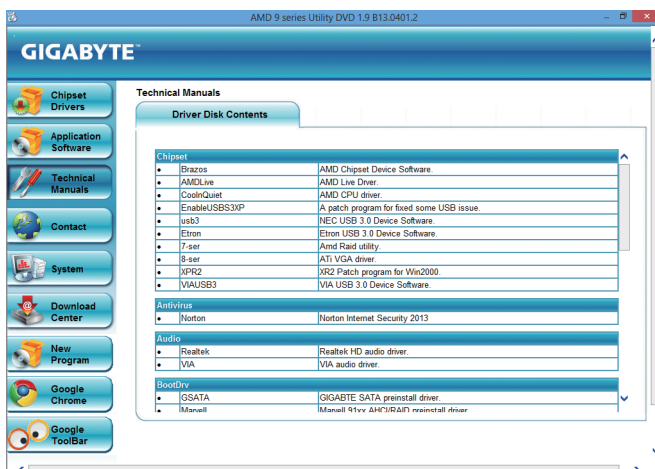

4-4 Contact

For the detailed contact information of the GIGABYTE Taiwan headquarter or worldwide branch offices, click the URL on this page to link to the GIGABYTE website.



4-5 System

This page provides the basic system information.

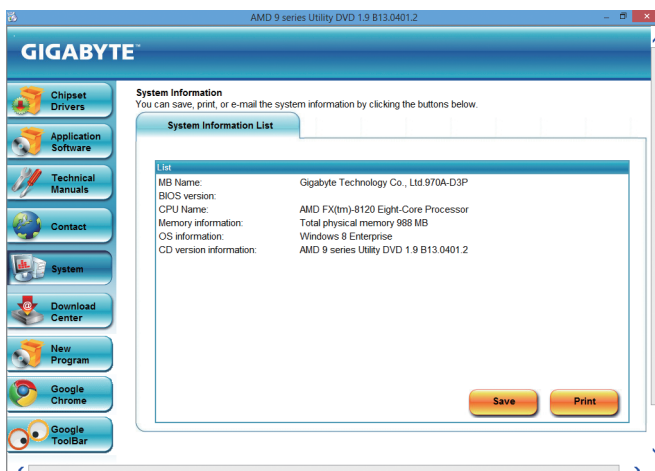

4-6 Download Center

To update the BIOS, drivers, or applications, click the **Download Center** button to link to the GIGABYTE website. The latest version of the BIOS, drivers, or applications will be displayed.

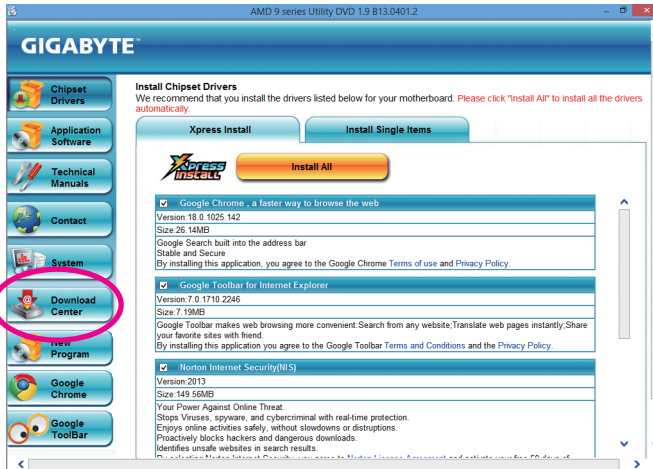

Chapter 5 Unique Features

5-1 BIOS Update Utilities

GIGABYTE motherboards provide two unique BIOS update tools, Q-Flash™ and @BIOS™. GIGABYTE Q-Flash and @BIOS are easy-to-use and allow you to update the BIOS without the need to enter MS-DOS mode. Additionally, this motherboard features the DualBIOS™ design, which enhances protection for the safety and stability of your computer by adding one more physical BIOS chip.

What is DualBIOS™?

Motherboards that support DualBIOS have two BIOS onboard, a main BIOS and a backup BIOS. Normally, the system works on the main BIOS. However, if the main BIOS is corrupted or damaged, the backup BIOS will take over on the next system boot and copy the BIOS file to the main BIOS to ensure normal system operation. For the sake of system safety, users cannot update the backup BIOS manually.

What is Q-Flash™?

With Q-Flash you can update the system BIOS without having to enter operating systems like MS-DOS or Windows first. Embedded in the BIOS, the Q-Flash tool frees you from the hassles of going through complicated BIOS flashing process.

What is @BIOS™?

@BIOS allows you to update the system BIOS while in the Windows environment. @BIOS will download the latest BIOS file from the nearest @BIOS server site and update the BIOS.

5-1-1 Updating the BIOS with the Q-Flash Utility

A. Before You Begin

1. From GIGABYTE's website, download the latest compressed BIOS update file that matches your motherboard model.
2. Extract the file and save the new BIOS file (e.g. 970AD3P.f1) to your USB flash drive, or hard drive. Note: The USB flash drive or hard drive must use FAT32/16/12 file system.
3. Restart the system. During the POST, press the <End> key to enter Q-Flash. Note: You can access Q-Flash by either pressing the <End> key during the POST or pressing the <F8> key in BIOS Setup. However, if the BIOS update file is saved to a hard drive in RAID/AHCI mode or a hard drive attached to an independent SATA controller, use the <End> key during the POST to access Q-Flash.



Because BIOS flashing is potentially risky, please do it with caution. Inadequate BIOS flashing may result in system malfunction.

B. Updating the BIOS

In the main menu of Q-Flash, use the keyboard or mouse to select an item to execute. When updating the BIOS, choose the location where the BIOS file is saved. The following procedure assumes that you save the BIOS file to a USB flash drive.

Step 1:

1. Insert the USB flash drive containing the BIOS file into the computer. In the main menu of Q-Flash, select **Update BIOS From Drive**.



- The **Save Main BIOS to Drive** option allows you to save the current BIOS file.
- Q-Flash only supports USB flash drive or hard drives using FAT32/16/12 file system.
- If the BIOS update file is saved to a hard drive in RAID/AHCI mode or a hard drive attached to an independent SATA controller, use the <End> key during the POST to access Q-Flash.

2. Select **USB Flash Drive**.

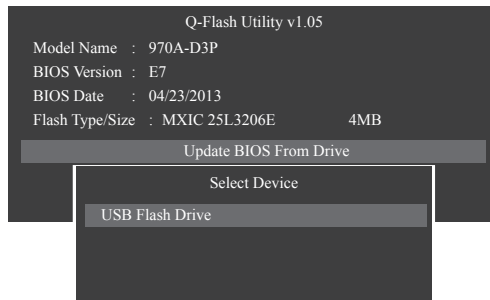

3. Select the BIOS update file.



Make sure the BIOS update file matches your motherboard model.

Step 2:

The process of the system reading the BIOS file from the USB flash drive is displayed on the screen. When the message "Are you sure to update BIOS?" appears, select **Yes** to begin the BIOS update. The monitor will display the update process.



- **Do not turn off or restart the system when the system is reading/updating the BIOS.**
- **Do not remove the USB flash drive or hard drive when the system is updating the BIOS.**

Step 3:

When the update process is complete, select **Reboot** to reboot the system.

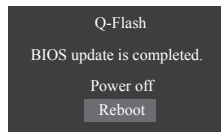

Step 4:

During the POST, press <Delete> to enter BIOS Setup. Select **Load Optimized Defaults** on the **Save & Exit** screen and press <Enter> to load BIOS defaults. System will re-detect all peripheral devices after a BIOS update, so we recommend that you reload BIOS defaults.

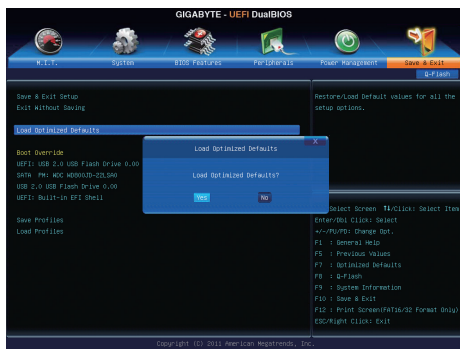

Select **Yes** to load BIOS defaults

Step 5:

Select **Save & Exit Setup** and press <Enter>. And then select **Yes** to save settings to CMOS and exit BIOS Setup. The procedure is complete after the system restarts.





5-1-2 Updating the BIOS with the @BIOS Utility

A. Before You Begin

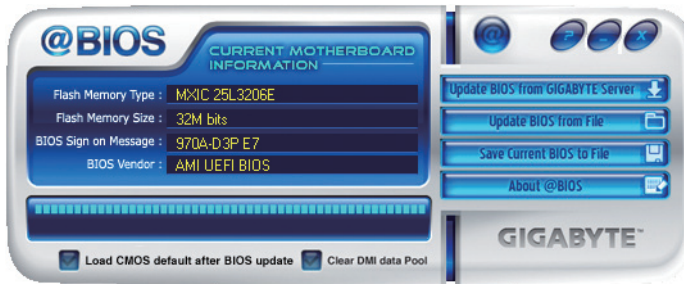
1. In Windows, close all applications and TSR (Terminate and Stay Resident) programs. This helps prevent unexpected failures when performing a BIOS update.
2. During the BIOS update process, ensure the Internet connection is stable and do NOT interrupt the Internet connection (for example, avoid a power loss or switching off the Internet). Failure to do so may result in a corrupted BIOS or a system that is unable to start.
3. Do not use the G.O.M. (GIGABYTE Online Management) function when using @BIOS.
4. GIGABYTE product warranty does not cover any BIOS damage or system failure resulting from an inadequate BIOS flashing.

B. Using @BIOS

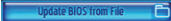

1.  **Update the BIOS Using the Internet Update Function:**
Click **Update BIOS from GIGABYTE Server**, select the @BIOS server site closest to your location and then download the BIOS file that matches your motherboard model. Follow the on-screen instructions to complete.
 If the BIOS update file for your motherboard is not present on the @BIOS server site, please manually download the BIOS update file from GIGABYTE's website and follow the instructions in "Update the BIOS without Using the Internet Update Function" below.
2.  **Update the BIOS without Using the Internet Update Function:**
Click **Update BIOS from File**, then select the location where you save the BIOS update file obtained from the Internet or through other source. Follow the on-screen instructions to complete.
3.  **Save the Current BIOS File:**
Click **Save Current BIOS to File** to save the current BIOS file.
4.  **Load BIOS Defaults after BIOS Update:**
Select the **Load CMOS default after BIOS update** check box and then the system will automatically load BIOS defaults after BIOS update and after the system restarts.

C. After Updating the BIOS

Restart your system after updating the BIOS.



Make sure that the BIOS file to be flashed matches your motherboard model. Updating the BIOS with an incorrect BIOS file could cause your system not to boot.





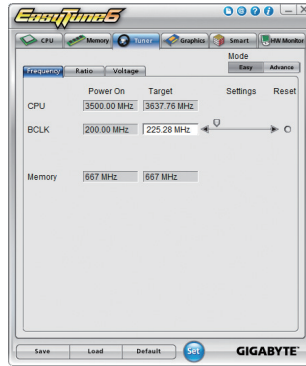

5-2 EasyTune 6

GIGABYTE's EasyTune 6 is a simple and easy-to-use interface that allows users to fine-tune their system settings or do overclock/overvoltage in Windows environment. The user-friendly EasyTune 6 interface also includes tabbed pages for CPU and memory information, letting users read their system-related information without the need to install additional software.

The EasyTune 6 Interface



Tabs Information

Tab	Description
	The CPU tab provides information on the installed CPU and motherboard.
	The Memory tab provides information on the installed memory module(s). You can select memory module on a specific slot to see its information.
	<p>The Tuner tab allows you to change memory settings and voltages.</p> <ul style="list-style-type: none"> • Easy mode provides information on CPU/memory. • Advanced mode allows you to individually change system clock settings and voltages settings using the sliders. • Save allows you to save the current settings to a new profile (.txt file). • Load allows you to load previous settings from a profile. <p>After making changes in Easy mode/Advanced mode, be sure to click Set for these changes to take effect or click Default to restore to default values.</p>
	The Graphics tab allows you to change the core clock and memory clock for your AMD or NVIDIA graphics card.
	The Smart tab allows you to specify a Smart Fan mode. Smart Fan Advanced mode allows the fan speed to be changed linearly based on the temperature thresholds you set.
	The HW Monitor tab allows you to monitor hardware temperature, voltage and fan speed and set temperature/fan speed alarm. You can choose the alert sound from the buzzer or use your own sound file (.wav file).



Available functions in EasyTune 6 may differ by motherboard model. Grayed-out area(s) indicates that the item is not configurable or the function is not supported.



Incorrectly doing overclock/overvoltage may result in damage to the hardware components such as CPU, chipset, and memory and reduce the useful life of these components. Before you do the overclock/overvoltage, make sure that you fully know each function of EasyTune 6, or system instability or other unexpected results may occur.

Chapter 6 Appendix

6-1 Configuring Audio Input and Output

6-1-1 Configuring 2/4/5.1/7.1-Channel Audio

The motherboard provides six audio jacks on the back panel which support 2/4/5.1/7.1-channel ^(Note) audio. The picture to the right shows the default audio jack assignments.



The integrated HD (High Definition) audio provides jack retasking capability that allows the user to change the function for each jack through the audio driver.

For example, in a 4-channel audio configuration, if a Rear speaker is plugged into the default Center/Subwoofer speaker out jack, you can retask the Center/Subwoofer speaker out jack to be Rear speaker out.



- To install a microphone, connect your microphone to the Mic in jack and manually configure the jack for microphone functionality.
- Audio signals will be present on both of the front and back panel audio connections simultaneously. If you want to mute the back panel audio (only supported when using an HD front panel audio module), refer to instructions on the next page.

High Definition Audio (HD Audio)

HD Audio includes multiple high quality digital-to-analog converters (DACs) and features multistreaming capabilities that allow multiple audio streams (in and out) to be simultaneously processed. For example, users can listen to MP3 music, have an Internet chat, make a telephone call over the Internet, and etc. all at the same time.

A. Configuring Speakers

(The following instructions use Windows 8 as the example operating system.)

Step 1:

After installing the audio driver, the **VIA HD Audio Deck** icon  will appear in the notification area. Click the icon to access the VIA HD Audio Deck.

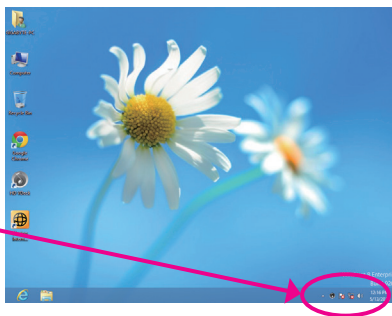

(Note) 2/4/5.1/7.1-Channel Audio Configurations:

Refer to the following for multi-channel speaker configurations.

- 2-channel audio: Headphone or Line out.
- 4-channel audio: Front speaker out and Rear speaker out.
- 5.1-channel audio: Front speaker out, Rear speaker out, and Center/Subwoofer speaker out.
- 7.1-channel audio: Front speaker out, Rear speaker out, Center/Subwoofer speaker out, and Side speaker out.

Step 2:

Connect an audio device to an audio jack. The **Please select a function** dialog box appears. Select the device according to the type of device you connect. Then click **OK**.



Step 3:

Go to the **Speaker** screen. On the **Speaker Setting** and Test tab, select **2, 4, 6, or 8-channel speaker** according to the type of speaker configuration you wish to set up. Then the speaker setup is completed.



B. Configuring Sound Effect

You may configure an audio environment on the **Sound Effects** tab.

C. Activating an AC'97 Front Panel Audio Module

If your chassis provides an AC'97 front panel audio module, to activate the AC'97 functionality, click the **Advanced Options** icon on the bottom right corner to open the **Advanced Options** dialog box. Do not select the **Enable front panel jack detection** check box. Click **OK** to complete.

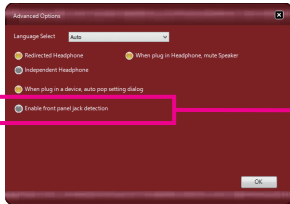

D. Muting the Back Panel Audio (For HD Audio Only)

Click the **Advanced Options** icon on the bottom right corner to open the **Advanced Options** dialog box. Select the **When plug in Headphone, mute Speaker** check box. Click **OK** to complete.

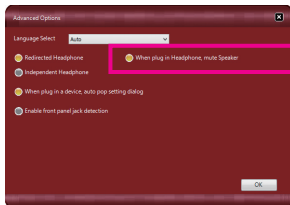

6-1-2 Configuring S/PDIF Out

The S/PDIF Out jack can transmit audio signals to an external decoder for decoding to get the best audio quality.

1. Connecting a S/PDIF Out Cable:

Connect a S/PDIF optical cable to the corresponding S/PDIF out connector as shown below and an external decoder for transmitting the S/PDIF digital audio signals.

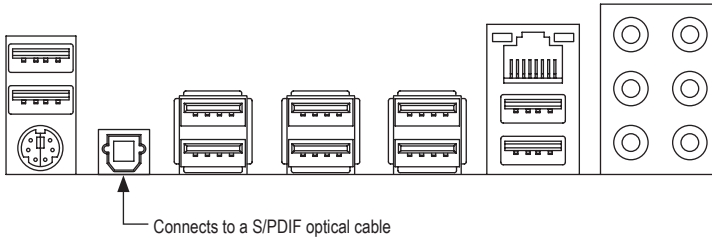

2. Configuring S/PDIF Out:

On the **SPDIF Out** screen (Note), click the **Default Format** tab and then select the sample rate and bit depth. Click **OK** to complete.



(Note) Enter the **SPDIF Out** screen to configure further settings if you use the S/PDIF Out connector(s) on the back panel for digital audio output or enter the **SPDIF HDMI** screen if you use the internal S/PDIF Out connector (SPDIF_O) for digital audio output.

6-1-3 Configuring Microphone Recording

Step 1:

After installing the audio driver, the **VIA HD Audio Deck** icon will appear in the notification area. Click the icon to access the VIA HD Audio Deck.

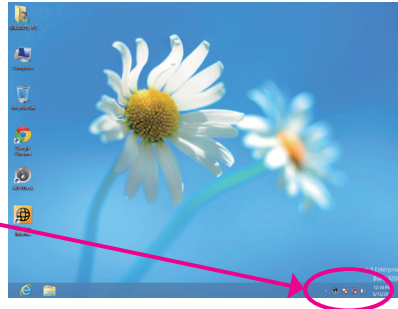

Step 2:

Connect your microphone to the Mic in jack (pink) on the back panel or the Mic in jack (pink) on the front panel.
Note: The microphone functions on the front panel and back panel cannot be used at the same time.



Step 3:

Go to the **Microphone** screen. Do not mute the recording volume (**REC Vol**), or you'll not be able to record the sound. To hear the sound being recorded during the recording process, do not mute the microphone volume (**Microphone**). It is recommended that you set the volumes at a middle level.



Step 4:

To raise the recording and playback volume for the microphone, use the slider on the right to set the microphone boost level.

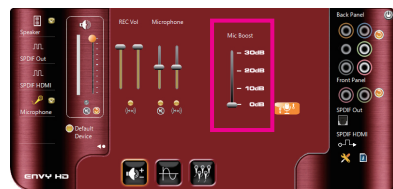

Step 5:

To open the Sound Recorder, move the mouse cursor to the bottom left corner of the screen, click the Start icon to switch to the Start screen (or press the Windows button on the keyboard). Right-click on the screen and click the **All apps** icon on the bottom right corner of the screen to access the Apps screen.

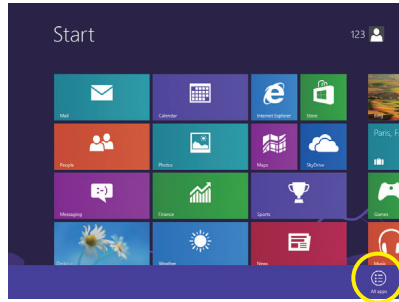

Step 6:

On this screen, click **Sound Recorder** for audio recording.

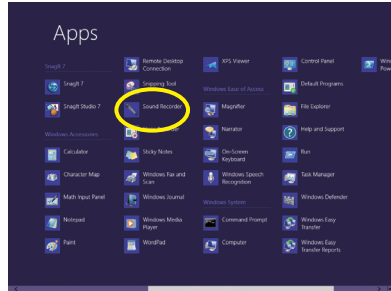

*** Enabling Stereo Mix**

If the HD Audio Manager does not display the recording device you wish to use, refer to the steps below. The following steps explain how to enable Stereo Mix (which may be needed when you want to record sound from your computer).

Step 1:

Locate the speaker icon in the notification area and right-click on this icon. Select **Recording devices**.

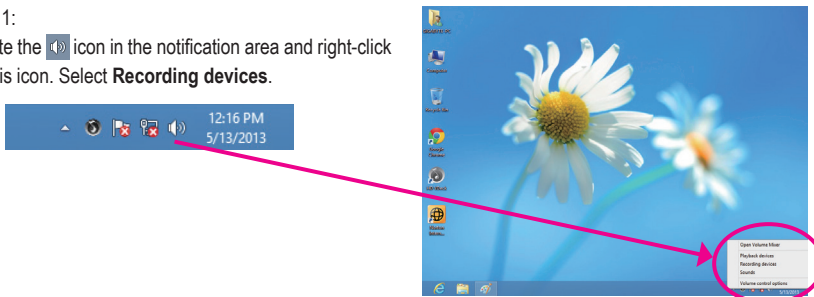

Step 2:

On the **Recording** tab, right-click on an empty space and select **Show Disabled Devices**.

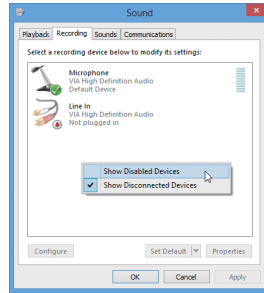

Step 3:

When the **Stereo Mix** item appears, right-click on this item and select **Enable**. Then set it as the default device.

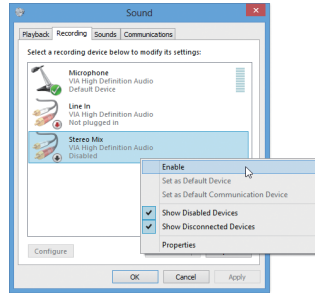

Step 4:



Now you can access the **VIA HD Audio Deck** to configure **Stereo Mix** and use **Sound Recorder** to record the sound.

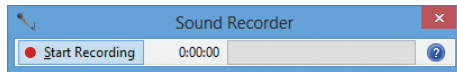

6-1-4 Using the Sound Recorder



A. Recording Sound

1. Make sure you have connected the sound input device (e.g. microphone) to the computer.
2. To record the audio, click the **Start Recording** button .
3. To stop recording audio, click the **Stop Recording** button .

Be sure to save the recorded audio file upon completion.

B. Playing the Recorded Sound

You can play your recording in a digital media player program that supports your audio file format.

6-2 Troubleshooting

6-2-1 Frequently Asked Questions

To read more FAQs for your motherboard, please go to the **Support & Downloads\FAQ** page on GIGABYTE's website.

- Q: Why is the light of my keyboard/optical mouse still on after the computer shuts down?
- A: Some motherboards provide a small amount of standby power after the computer shuts down and that's why the light is still on.
- Q: How do I clear the CMOS values?
- A: For motherboards that have a Clear CMOS button, press this button to clear the CMOS values (before doing this, please turn off the computer and unplug the power cord). For motherboards that have a Clear CMOS jumper, refer to the instructions in Chapter 1 to short the jumper to clear the CMOS values. If your board doesn't have this jumper/button, refer to the instructions on the motherboard battery in Chapter 1. You can temporarily remove the battery from the battery holder to stop supplying power to the CMOS, which will clear the CMOS values after about one minute.
- Q: Why do I still get a weak sound even though I have turned my speaker to the maximum volume?
- A: Make sure your speaker is equipped with an internal amplifier. If not, try a speaker with power/amplifier.
- Q: Why cannot I install the onboard HD audio driver successfully? (For Windows XP only)
- A: Step 1: First, make sure Service Pack 1 or Service Pack 2 has been installed (check in My Computer > Properties > General > System). If not, please update it from Microsoft's website. Then make sure the Microsoft UAA Bus Driver for High Definition Audio has been installed successfully (check in My Computer > Properties > Hardware > Device Manager > System Devices).
- Step 2: Check if **Audio Device on High Definition Audio Bus** or **Unknown device** is present in **Device Manager** or **Sound, video, and game controllers**. If yes, please disable this device. (If not, skip this step.)
- Step 3: Then go back to **My Computer > Properties > Hardware > Device Manager > System devices** and right-click on **Microsoft UAA Bus Driver for High Definition Audio** and select **Disable** and **Uninstall**.
- Step 4: In **Device Manager**, right-click on the computer name and select **Scan for hardware changes**. When the **Add New Hardware Wizard** appears, click **Cancel**. Then install the onboard HD audio driver from the motherboard driver disk or download the audio driver from GIGABYTE's website to install.
- For more details, go to the **Support & Downloads\FAQ** page on our website and search for "onboard HD audio driver."

6-2-2 Troubleshooting Procedure

If you encounter any troubles during system startup, follow the troubleshooting procedure below to solve the problem.

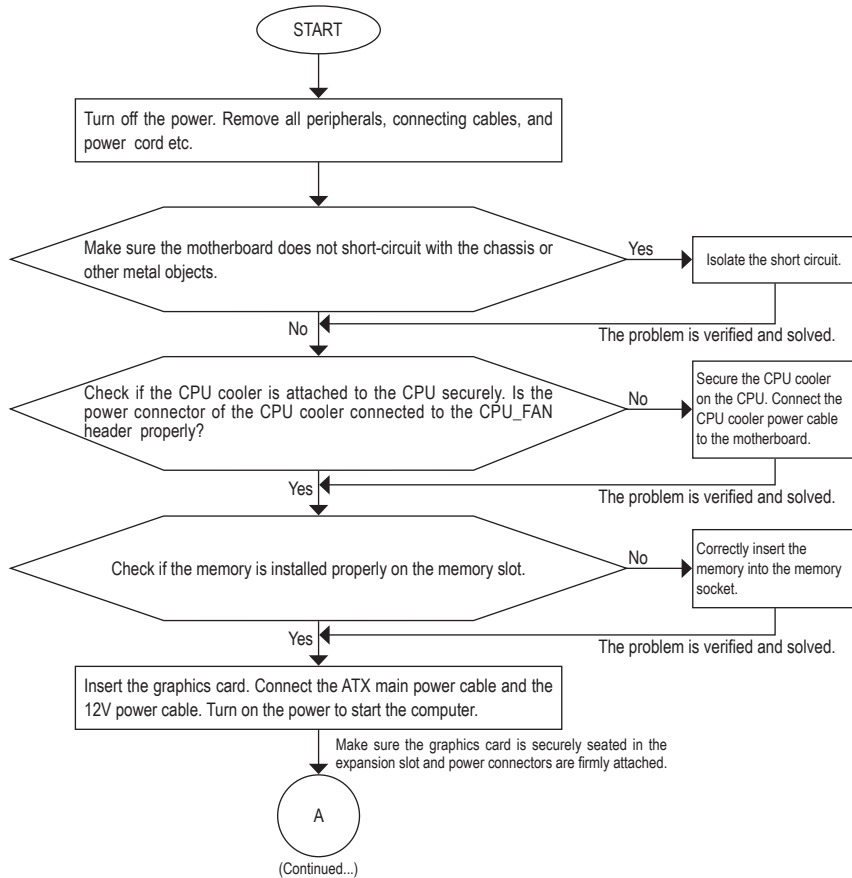

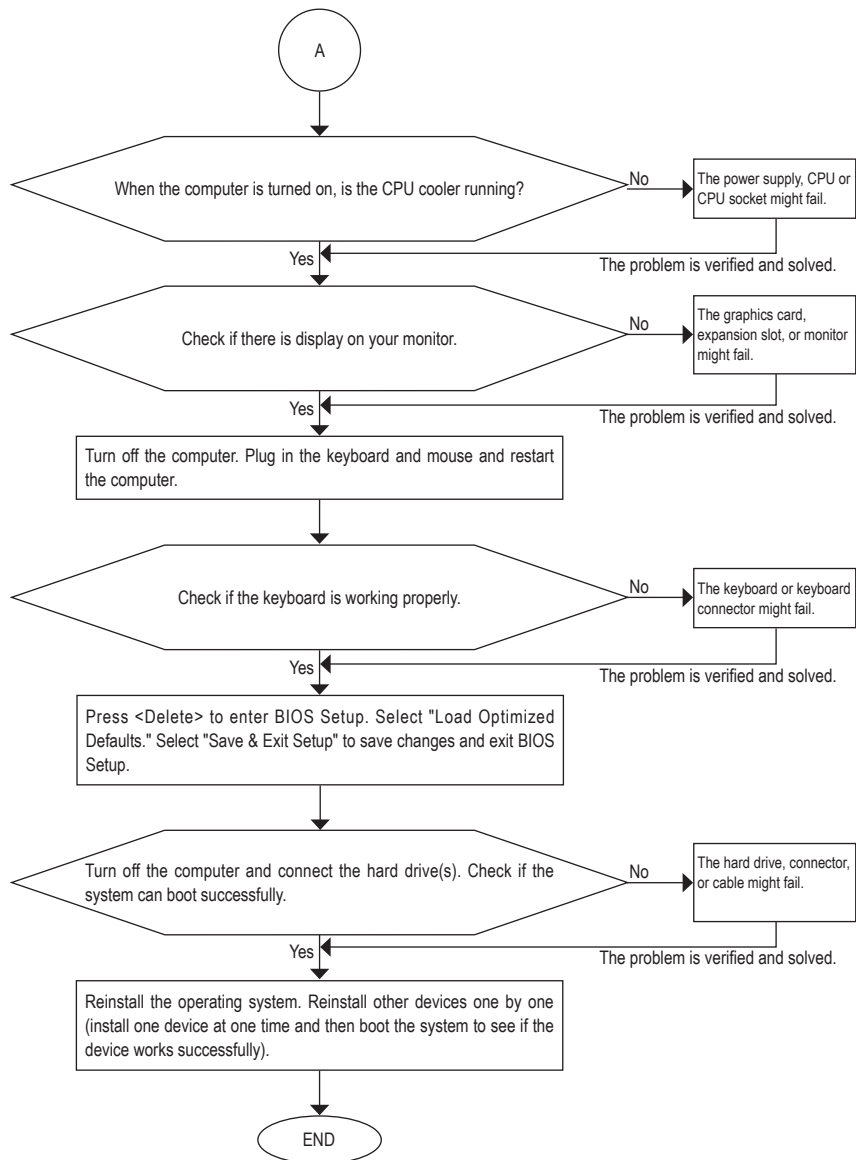

If the procedure above is unable to solve your problem, contact the place of purchase or local dealer for help. Or go to the **Support & Downloads** **Technical Support** page to submit your question. Our customer service staff will reply you as soon as possible.

Regulatory Statements

Regulatory Notices

This document must not be copied without our written permission, and the contents there of must not be imparted to a third party nor be used for any unauthorized purpose. Contravention will be prosecuted. We believe that the information contained herein was accurate in all respects at the time of printing. GIGABYTE cannot, however, assume any responsibility for errors or omissions in this text. Also note that the information in this document is subject to change without notice and should not be construed as a commitment by GIGABYTE.

Our Commitment to Preserving the Environment

In addition to high-efficiency performance, all GIGABYTE motherboards fulfill European Union regulations for RoHS (Restriction of Certain Hazardous Substances in Electrical and Electronic Equipment) and WEEE (Waste Electrical and Electronic Equipment) environmental directives, as well as most major worldwide safety requirements. To prevent releases of harmful substances into the environment and to maximize the use of our natural resources, GIGABYTE provides the following information on how you can responsibly recycle or reuse most of the materials in your "end of life" product.

Restriction of Hazardous Substances (RoHS) Directive Statement

GIGABYTE products have not intended to add and safe from hazardous substances (Cd, Pb, Hg, Cr+6, PBDE and PBB). The parts and components have been carefully selected to meet RoHS requirement. Moreover, we at GIGABYTE are continuing our efforts to develop products that do not use internationally banned toxic chemicals.

Waste Electrical & Electronic Equipment (WEEE) Directive Statement

GIGABYTE will fulfill the national laws as interpreted from the 2002/96/EC WEEE (Waste Electrical and Electronic Equipment) directive. The WEEE Directive specifies the treatment, collection, recycling and disposal of electric and electronic devices and their components. Under the Directive, used equipment must be marked, collected separately, and disposed of properly.

WEEE Symbol Statement



The symbol shown below is on the product or on its packaging, which indicates that this product must not be disposed of with other waste. Instead, the device should be taken to the waste collection centers for activation of the treatment, collection, recycling and disposal procedure. The separate collection and recycling of your waste equipment at the time of disposal will help to conserve natural resources and ensure that it is recycled in a manner that protects human health and the environment.

For more information about where you can drop off your waste equipment for recycling, please contact your local government office, your household waste disposal service or where you purchased the product for details of environmentally safe recycling.

- ♦ When your electrical or electronic equipment is no longer useful to you, "take it back" to your local or regional waste collection administration for recycling.
- ♦ If you need further assistance in recycling, reusing in your "end of life" product, you may contact us at the Customer Care number listed in your product's user's manual and we will be glad to help you with your effort.

Finally, we suggest that you practice other environmentally friendly actions by understanding and using the energy-saving features of this product (where applicable), recycling the inner and outer packaging (including shipping containers) this product was delivered in, and by disposing of or recycling used batteries properly. With your help, we can reduce the amount of natural resources needed to produce electrical and electronic equipment, minimize the use of landfills for the disposal of "end of life" products, and generally improve our quality of life by ensuring that potentially hazardous substances are not released into the environment and are disposed of properly.



Contact Us

• GIGA-BYTE TECHNOLOGY CO., LTD.

Address: No.6, Bao Chiang Road, Hsin-Tien Dist.,
New Taipei City 231, Taiwan

TEL: +886-2-8912-4000

FAX: +886-2-8912-4005

Tech. and Non-Tech. Support (Sales/Marketing) :

<http://ggts.gigabyte.com.tw>

WEB address (English): <http://www.gigabyte.com>

WEB address (Chinese): <http://www.gigabyte.tw>

• G.B.T. INC. - U.S.A.

TEL: +1-626-854-9338

FAX: +1-626-854-9326

Tech. Support: <http://ggts.gigabyte.com.tw>

Warranty Info: <http://rma.gigabyte.us>

Web address: <http://www.gigabyte.us>

• G.B.T. INC (USA) - Mexico

Tel: +1-626-854-9338 x 215 (Soporte de habla hispano)

FAX: +1-626-854-9326

Correo: soporte@gigabyte-usa.com

Tech. Support: <http://rma.gigabyte.us>

Web address: <http://latam.giga-byte.com>

• Giga-Byte SINGAPORE PTE. LTD. - Singapore

WEB address : <http://www.gigabyte.sg>

• Thailand

WEB address : <http://th.giga-byte.com>

• Vietnam

WEB address : <http://www.gigabyte.vn>

• NINGBO G.B.T. TECH. TRADING CO., LTD. - China

WEB address : <http://www.gigabyte.cn>

Shanghai

TEL: +86-21-63400912

FAX: +86-21-63400682

Beijing

TEL: +86-10-62102838

FAX: +86-10-62102848

Wuhan

TEL: +86-27-87685981

FAX: +86-27-87579461

GuangZhou

TEL: +86-20-87540700

FAX: +86-20-87544306

Chengdu

TEL: +86-28-85483135

FAX: +86-28-85256822

Xian

TEL: +86-29-85531943

FAX: +86-29-85510930

Shenyang

TEL: +86-24-83992342

FAX: +86-24-83992102

• GIGABYTE TECHNOLOGY (INDIA) LIMITED - India

WEB address : <http://www.gigabyte.in>

• Saudi Arabia

WEB address : <http://www.gigabyte.com.sa>

• Gigabyte Technology Pty. Ltd. - Australia

WEB address : <http://www.gigabyte.com.au>

- **G.B.T. TECHNOLOGY TRADING GMBH - Germany**
WEB address : <http://www.gigabyte.de>

- **G.B.T. TECH. CO., LTD. - U.K.**
WEB address : <http://www.giga-byte.co.uk>

- **Giga-Byte Technology B.V. - The Netherlands**
WEB address : <http://www.giga-byte.nl>

- **GIGABYTE TECHNOLOGY FRANCE - France**
WEB address : <http://www.gigabyte.fr>

- **Sweden**
WEB address : <http://www.gigabyte.se>

- **Italy**
WEB address : <http://www.giga-byte.it>

- **Spain**
WEB address : <http://www.giga-byte.es>

- **Greece**
WEB address : <http://www.gigabyte.com.gr>

- **Czech Republic**
WEB address : <http://www.gigabyte.cz>

- **Hungary**
WEB address : <http://www.giga-byte.hu>

- **Turkey**
WEB address : <http://www.gigabyte.com.tr>

- **Russia**
WEB address : <http://www.gigabyte.ru>

- **Poland**
WEB address : <http://www.gigabyte.pl>

- **Ukraine**
WEB address : <http://www.gigabyte.ua>

- **Romania**
WEB address : <http://www.gigabyte.com.ro>

- **Serbia**
WEB address : <http://www.gigabyte.co.rs>

- **Kazakhstan**
WEB address : <http://www.gigabyte.kz>

You may go to the GIGABYTE website, select your language in the language list on the top right corner of the website.

- **GIGABYTE Global Service System**



To submit a technical or non-technical (Sales/Marketing) question, please link to:

<http://ggts.gigabyte.com.tw>

Then select your language to enter the system.