

XP-850 User's Guide

Contents

XP-850 User's Guide	15
Product Basics	16
Setting Up the Control Panel	16
Control Panel Buttons and Lights	16
Adjusting Control Panel Position	17
Changing LCD Screen Language.....	17
Turning Off Control Panel Sounds.....	18
Product Parts Locations	18
Product Parts - Top.....	19
Product Parts - Front	21
Product Parts - Inside	23
Product Parts - Back.....	23
The Sleep Timer.....	24
Changing the Sleep Timer Setting From the Control Panel	24
Changing the Sleep Timer Setting - Windows	26
Changing the Sleep Timer Setting - Mac OS X.....	26
Epson Connect Solutions for Smartphones, Tablets, and More	27
Using Epson Email Print	28
Using the Epson iPrint Mobile App	28
Using Epson Remote Print	29
Using Epson Scan to Cloud.....	29
Using AirPrint	30
Using Google Cloud Print.....	30
Wi-Fi Networking	32
Selecting Wireless Network Settings From the Control Panel	32
Enabling Wi-Fi Direct Mode.....	34
Disabling and Re-enabling Wi-Fi Features.....	36
Loading Paper	38
Loading Paper in Cassette 1 (Upper Cassette)	38
Loading Paper in Cassette 2 (Lower Cassette)	41

Loading Paper in the Rear Paper Feed Slot	45
Loading Envelopes	49
Paper Loading Capacity	52
Available Epson Papers	53
Borderless Paper Type Compatibility	55
Paper or Media Type Settings	56
Placing Originals on the Product	57
Placing Originals on the Scanner Glass	57
Placing Originals in the Automatic Document Feeder	58
Copying	62
Copying Documents or Photos	62
Paper Type Settings - Copying	63
Paper Size Settings - Copying	64
Copying Options	64
Copying and Restoring Photos	67
Printing From a Computer	69
Printing with Windows	69
Selecting Basic Print Settings - Windows	69
Paper Source Options - Windows	72
Basic Print Options - Windows	72
Selecting Advanced Print Settings - Windows	73
Advanced Print Quality Settings - Windows	74
Advanced Print Options - Windows	75
Color Management Options - Windows	75
Selecting Print Layout Options - Windows	76
Selecting a Printing Preset - Windows	78
Selecting Double-sided Printing Settings - Windows	80
Double-sided Printing Options - Windows	82
Print Density Adjustments - Windows	83
Printing Your Document or Photo - Windows	83
Checking Print Status - Windows	84
Selecting Default Print Settings - Windows	85
Changing the Language of the Printer Software Screens	86

Changing Automatic Update Options	88
Printing with Mac OS X.....	88
Selecting Basic Print Settings - Mac OS X.....	89
Paper Source Options - Mac OS X.....	92
Print Quality Settings - Mac OS X	92
Print Options - Mac OS X.....	93
Selecting Page Setup Settings - Mac OS X.....	93
Selecting Print Layout Options - Mac OS X.....	94
Selecting Double-sided Printing Settings - Mac OS X	95
Double-sided Printing Options and Adjustments - Mac OS X.....	97
Managing Color - Mac OS X.....	98
Color Matching and Color Options - Mac OS X.....	99
Selecting Printing Preferences - Mac OS X.....	100
Printing Preferences - Mac OS X	101
Printing Your Document or Photo - Mac OS X.....	102
Checking Print Status - Mac OS X	102
Cancelling Printing Using a Product Button.....	104
Scanning	105
Starting a Scan.....	105
Starting a Scan Using the Product Control Panel	105
Scan to Memory Card Options.....	107
Changing Default Scan Button Settings.....	108
Starting a Scan Using the Epson Scan Icon	109
Starting a Scan from a Scanning Program.....	112
Selecting Epson Scan Settings	114
Scan Modes.....	114
Selecting the Scan Mode.....	114
Scanning in Office Mode.....	115
Available Document Source Settings - Office Mode.....	117
Selecting a Scan Area - Office Mode	118
Available Image Adjustments - Office Mode	120
Scanning in Home Mode	121
Selecting a Scan Area - Home Mode	124

Available Image Adjustments - Home Mode	127
Selecting a Scan Size - Home Mode.....	128
Scanning in Professional Mode	130
Available Document Source Settings - Professional Mode	133
Available Image Types - Professional Mode	133
Selecting a Scan Area - Professional Mode	134
Available Image Adjustments - Professional Mode	137
Selecting a Scan Size - Professional Mode.....	139
Image Preview Guidelines.....	142
Scan Resolution Guidelines	142
Selecting Scan File Settings.....	143
Available Scanned File Types and Optional Settings.....	144
Scanning with OS X Using Image Capture.....	145
Available Scan Settings - OS X Image Capture	147
Scanning Special Projects.....	147
Scanning to a PDF File.....	147
Restoring Photo Colors as You Scan	150
Convert Scanned Documents to Editable Text (OCR).....	151
Scanning Using OCR - Windows	151
Scanning Using OCR - Mac OS X.....	153
Faxing.....	156
Connecting a Telephone or Answering Machine.....	156
Setting Up Fax Features	159
Setting Up Fax Features Using the Product Control Panel	160
Selecting Your Country or Region.....	160
Selecting the Date and Time.....	162
Entering Fax Header Information.....	164
Entering Numbers and Characters for Faxing.....	166
Selecting Fax Send and Receive Settings	167
Selecting Fax Communication Settings	168
Printing Fax Reports	169
Restoring Default Fax Settings	171
Fax Send Options	172

Fax Receive Options.....	172
Fax Communications Options.....	173
Fax Report Options.....	174
Restore Default Settings Options.....	175
Setting Up Fax Features Using the Fax Utility - Windows.....	175
Setting Up Fax Features Using the Fax Utility - Mac OS X.....	177
Setting Up Speed Dial and Group Dial Lists.....	178
Setting Up Speed/Group Dial Lists Using the Product Control Panel.....	178
Creating Speed Dial List Entries.....	178
Printing Your Speed Dial List.....	180
Creating Group Dial List Entries.....	182
Printing Your Group Dial List.....	183
Setting Up Speed/Group Dial Lists Using the Fax Utility - Windows.....	184
Setting Up Speed/Group Dial Lists Using the Fax Utility - Mac OS X.....	187
Sending Faxes.....	188
Sending Faxes from the Product Control Panel.....	188
Manually Dialing or Redialing Fax Numbers.....	189
Selecting Fax Numbers from Speed or Group Dial Lists.....	190
Dialing Fax Numbers from a Connected Telephone.....	192
Broadcasting a Fax.....	193
Sending a Fax at a Specified Time.....	194
Fax Sending Options.....	195
Sending Faxes Using the Fax Utility - Windows.....	196
Sending Faxes Using the Fax Utility - Mac OS X.....	198
Receiving Faxes.....	201
Fax Reception.....	201
Receiving Faxes Automatically (Auto Answer).....	202
Receiving Faxes Manually.....	202
Using Memory Cards With Your Product.....	204
Inserting a Memory Card.....	204
Memory Card Types.....	205
Memory Card File Specifications.....	206
Removing a Memory Card.....	206

Printing from a Memory Card	207
Viewing and Printing Photos.....	207
Viewing and Printing Photos	208
Cropping Photos Displayed on the LCD Screen	209
Photo Adjustment Options - Memory Card.....	209
Print Setting Options - Memory Card	211
Paper Type Settings - Memory Card.....	212
Printing Photo Layouts from a Memory Card.....	213
Photo Layout Options	215
Printing Photo Greeting Cards.....	215
Creating and Printing a Greeting Card Template	215
Printing a Greeting Card from a Template.....	217
Transferring Photos on a Memory Card	218
Setting Up File Sharing for Photo Transfers From Your Computer	218
Transferring Photos from a Memory Card to Your Computer	219
Using an External Device with Your Product	220
Printing from a Camera Connected to Your Product	220
Selecting Print and Photo Adjustment Settings	220
Print Settings - Camera.....	223
Photo Adjustments - Camera.....	225
Connecting and Printing from a Camera.....	226
Viewing or Printing from a USB Flash Drive or External Device	227
USB Device File Specifications	228
Connecting and Using a USB Flash Drive or External Device	228
Printing Personalized Projects.....	229
Printing Coloring Book Pages	229
Printing Personalized Note Paper	231
Printing Lined Paper and Graph Paper.....	233
Printing on CDs/DVDs.....	235
CD/DVD Printing Features	235
Loading a CD/DVD.....	235
Removing a Printed CD/DVD	238
Placing a CD/DVD on the Scanner Glass.....	239

Copying onto a CD/DVD	239
Printing Photos from a Memory Card Onto a CD/DVD	241
Printing a Jewel Case Insert from a Memory Card	242
Printing on CDs/DVDs from a Computer	244
Printing on a CD/DVD with Windows	244
Designing a CD/DVD - Windows.....	244
Printing Your CD/DVD Design - Windows.....	245
Adjusting CD/DVD Print Position - Windows.....	246
Adjusting CD/DVD Print Quality - Windows	248
Printing on a CD/DVD with Mac OS X	249
Designing a CD/DVD - Mac OS X	250
Printing Your CD/DVD Design - Mac OS X	251
Adjusting CD/DVD Print Position - Mac OS X	251
Adjusting CD/DVD Print Quality - Mac OS X.....	253
Replacing Ink Cartridges	255
Check Cartridge Status	255
Checking Cartridge Status on the LCD Screen.....	255
Checking Cartridge Status with Windows.....	256
Checking Cartridge Status with Mac OS X	259
Purchase Epson Ink Cartridges.....	260
Ink Cartridge Part Numbers	260
Removing and Installing Ink Cartridges.....	261
Conserving Low Black Ink with Windows	265
Adjusting Print Quality.....	267
Print Head Maintenance.....	267
Print Head Nozzle Check.....	267
Checking the Nozzles Using the Product Control Panel	267
Checking the Nozzles Using a Computer Utility	269
Print Head Cleaning	271
Cleaning the Print Head Using the Product Control Panel	272
Cleaning the Print Head Using a Computer Utility.....	273
Print Head Alignment	276
Aligning the Print Head Using the Product Control Panel	276

Aligning the Print Head Using a Computer Utility	277
Cleaning the Paper Path	279
Cleaning and Transporting Your Product	280
Cleaning Your Product	280
Transporting Your Product	281
Solving Problems	284
Checking for Software Updates	284
Product Status Messages	285
Running a Product Check	286
Resetting Control Panel Defaults	288
Solving Setup Problems	289
Noise After Ink Installation	289
Software Installation Problems	290
Control Panel Setup Problems	290
Solving Network Problems	290
Product Cannot Connect to a Wireless Router or Access Point	291
Network Software Cannot Find Product on a Network	292
Product Does Not Appear in Mac OS X Printer Window	292
Cannot Print Over a Network	293
Cannot Scan Over a Network	294
Printing a Network Status Sheet	294
Solving Copying Problems	295
Product Makes Noise, But Nothing Copies	295
Product Makes Noise When It Sits for a While	296
Solving Paper Problems	296
Paper Feeding Problems	296
Paper Jam Problems Inside the Product	297
Paper Jam Problems in the Paper Cassette	299
Paper Jam Problems in the Auto Duplexer	300
Paper Jams in the Automatic Document Feeder	302
Paper Ejection Problems	305
Solving Problems Printing from a Computer	306
Nothing Prints	306

Product Icon Does Not Appear in Windows Taskbar	307
Error After Cartridge Replacement	307
Printing is Slow	308
Solving Page Layout and Content Problems	309
Inverted Image.....	309
Too Many Copies Print	309
Blank Pages Print	310
Incorrect Margins on Printout.....	310
Border Appears on Borderless Prints	311
Incorrect Characters Print.....	311
Incorrect Image Size or Position	312
Slanted Printout	312
Solving Print Quality Problems	313
White or Dark Lines in Printout	313
Blurry or Smearred Printout	314
Faint Printout or Printout Has Gaps	315
Grainy Printout.....	316
Incorrect Colors	317
Solving Scanning Problems	318
Scanning Software Does Not Operate Correctly	318
Cannot Start Epson Scan	318
Solving Scanned Image Quality Problems	319
Image Consists of a Few Dots Only.....	320
Line of Dots Appears in All Scanned Images.....	320
Straight Lines in an Image Appear Crooked	321
Image is Distorted or Blurry	321
Image Colors are Patchy at the Edges	321
Image is Too Dark	321
Back of Original Image Appears in Scanned Image	322
Ripple Patterns Appear in an Image	322
Scanned Image Colors Do Not Match Original Colors.....	322
Scan Area is Not Adjustable in Thumbnail Preview	323
Scanned Image Edges are Cropped	323

Solving Memory Card Problems.....	323
Memory Card Does Not Fit Into a Slot	324
Cannot View or Print Photos from a Memory Card	324
Cannot Transfer Photos To or From a Memory Card.....	324
Solving Faxing Problems.....	325
Cannot Send or Receive Faxes.....	325
Cannot Receive Faxes with a Telephone Connected to Your Product	326
When to Uninstall Your Product Software	326
Uninstalling Product Software - Windows.....	326
Uninstalling Product Software - Mac OS X	328
Where to Get Help.....	328
Technical Specifications	330
Windows System Requirements	330
Mac System Requirements	331
Printing Specifications	331
Scanning Specifications	331
Automatic Document Feeder (ADF) Specifications	332
Fax Specifications	332
Paper Specifications	333
Printable Area Specifications	334
Ink Cartridge Specifications.....	336
Memory Card Specifications	337
Dimension Specifications	338
Electrical Specifications	339
Environmental Specifications	339
Interface Specifications	340
External USB Device Specifications.....	340
Network Interface Specifications	340
Safety and Approvals Specifications	341
Notices	343
FCC Compliance Statement.....	343
Software Notice.....	345
Trademarks	348

Copyright Notice.....	348
libTIFF Software Acknowledgment.....	349
A Note Concerning Responsible Use of Copyrighted Materials.....	349
Default Delay Times for Power Management for Epson Products	350
Copyright Attribution	350

XP-850 User's Guide

Welcome to the XP-850 *User's Guide*.

Product Basics

See these sections to learn about the basic features of your product.

[Setting Up the Control Panel](#)

[Product Parts Locations](#)

[The Sleep Timer](#)

[Epson Connect Solutions for Smartphones, Tablets, and More](#)

[Using AirPrint](#)

[Using Google Cloud Print](#)

Setting Up the Control Panel

See these sections to set up the control panel for use.

[Control Panel Buttons and Lights](#)

[Adjusting Control Panel Position](#)

[Changing LCD Screen Language](#)

[Turning Off Control Panel Sounds](#)

Parent topic: [Product Basics](#)

Control Panel Buttons and Lights

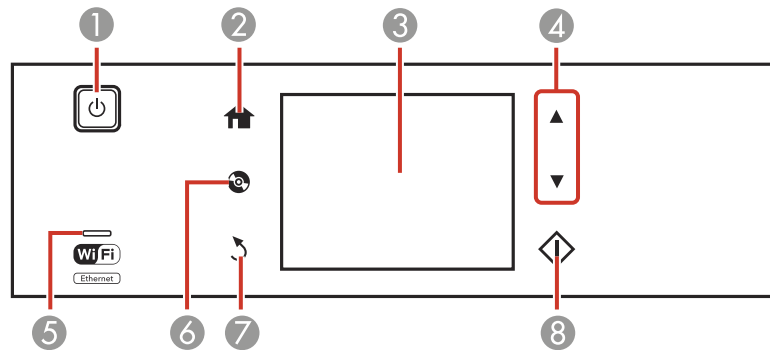

1 The  power button and the  power light

- 2 The 🏠 home button
- 3 The LCD screen
- 4 The up and down arrow buttons (you can also scroll by swiping up and down on the LCD screen with your finger)
- 5 The WiFi light
- 6 The 🔄 CD button
- 7 The ↶ back button
- 8 The ⬡ start button

Parent topic: [Setting Up the Control Panel](#)

Adjusting Control Panel Position

You can adjust the position of the control panel to make it easier to access. Raise or lower it to the desired angle as shown.

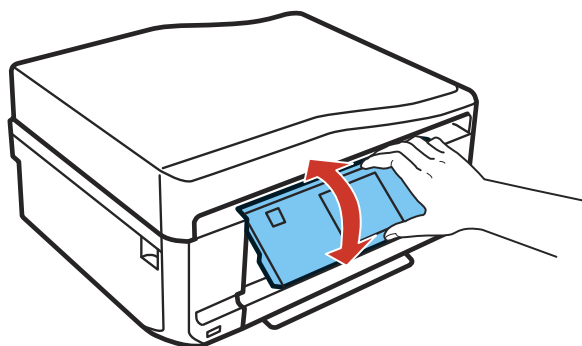

Parent topic: [Setting Up the Control Panel](#)

Changing LCD Screen Language

You can change the language used on the LCD screen.



1. Press the 🏠 home button, if necessary.
2. Press the left or right arrow button and then select **Setup**.
3. Scroll down and select **Basic Setup**.

4. Scroll down and select **Language**.
5. Select a language.
6. Press the  home button to exit.

Parent topic: [Setting Up the Control Panel](#)

Turning Off Control Panel Sounds

You can turn off the sound heard when you press buttons on the control panel.

1. Press the  home button, if necessary.
2. Press the left or right arrow button and then select **Setup**.
3. Select **Printer Setup**.
4. Select **Sound**.
5. Select **Button Press**.
6. Select the **Off** setting.
7. Press the  home button to exit.

Parent topic: [Setting Up the Control Panel](#)

Product Parts Locations

See these sections to identify the parts on your product.

[Product Parts - Top](#)

[Product Parts - Front](#)

[Product Parts - Inside](#)

[Product Parts - Back](#)

Parent topic: [Product Basics](#)

Product Parts - Top

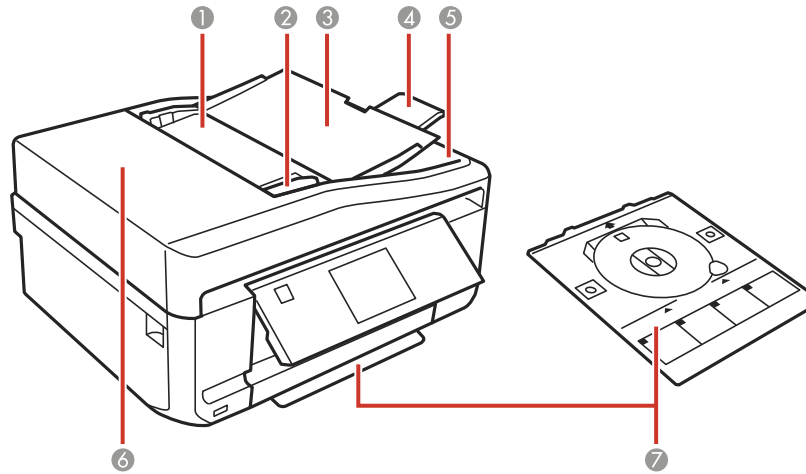

- 1 Automatic Document Feeder (ADF)
- 2 Edge guide
- 3 ADF paper support
- 4 ADF output extension
- 5 ADF output tray
- 6 ADF cover
- 7 CD/DVD tray (shown removed and in storage position)

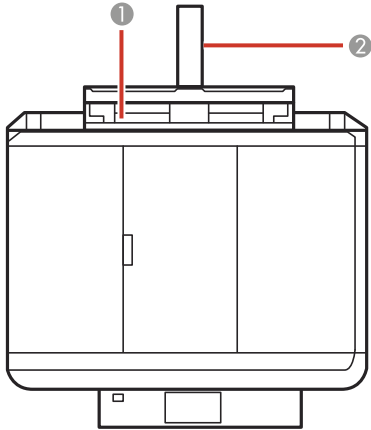

- 1 Rear paper feed slot
- 2 Paper support

Parent topic: [Product Parts Locations](#)

Product Parts - Front

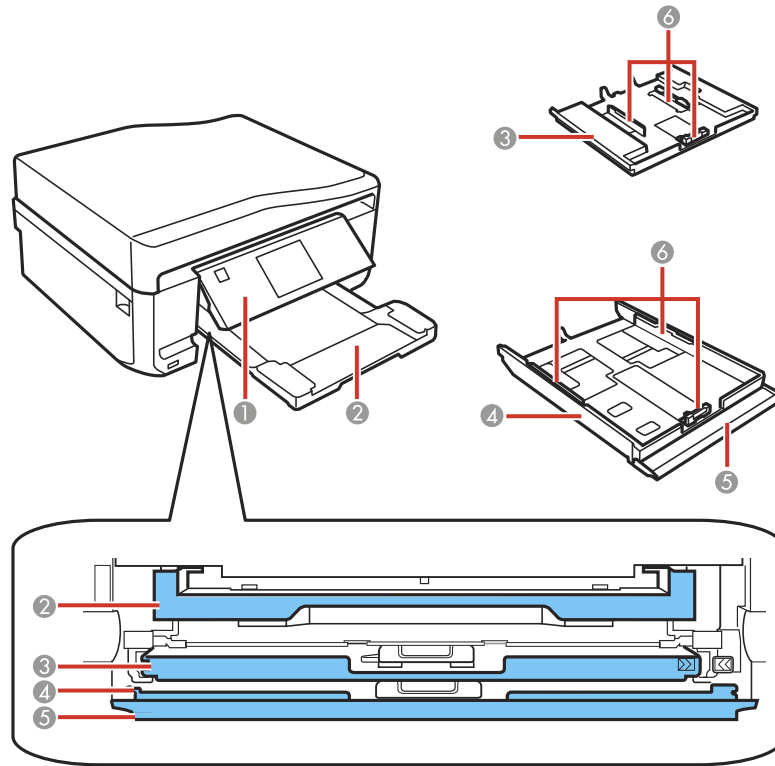

- 1 Control panel
- 2 Output tray
- 3 Cassette 1 (upper cassette)
- 4 Cassette 2 (lower cassette)
- 5 Front cover
- 6 Cassette edge guides

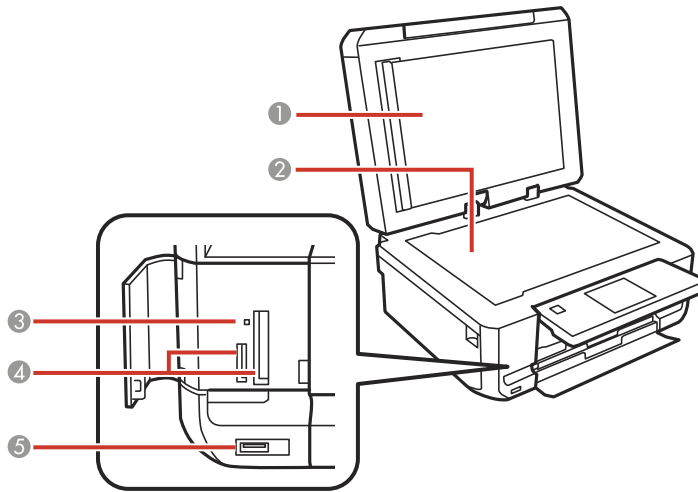

- 1 Document cover
- 2 Scanner glass
- 3 Memory card access light
- 4 Memory card slots
- 5  USB Type A port for external devices

Parent topic: [Product Parts Locations](#)

Product Parts - Inside

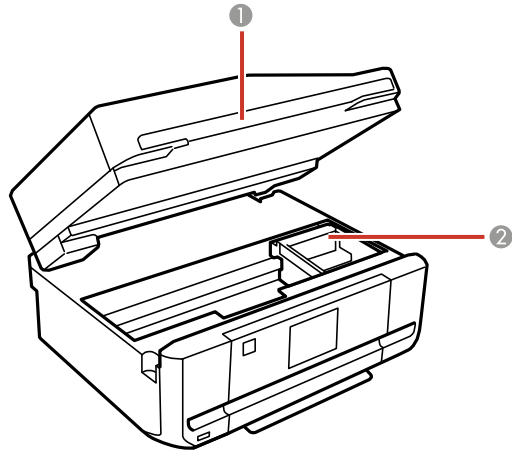

- 1 Scanner unit
- 2 Print head/ink cartridge holder

Parent topic: [Product Parts Locations](#)

Product Parts - Back

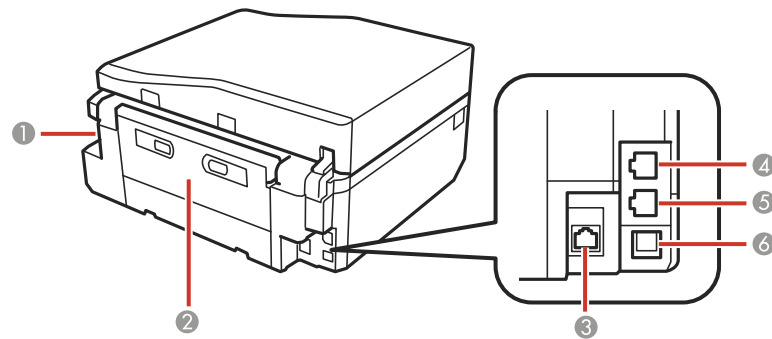

- 1 AC inlet

- 2 Rear cover
- 3 **LAN** port
- 4 **LINE** port
- 5 **EXT** port
- 6 **USB** port

Parent topic: [Product Parts Locations](#)

The Sleep Timer

The product enters sleep mode if it is not used for a period of time. You can adjust the time period before sleep mode, but increasing the time reduces the product's energy efficiency.

[Changing the Sleep Timer Setting From the Control Panel](#)

[Changing the Sleep Timer Setting - Windows](#)

[Changing the Sleep Timer Setting - Mac OS X](#)

Parent topic: [Product Basics](#)

Changing the Sleep Timer Setting From the Control Panel

You can use the product's control panel to change the time period before the product enters sleep mode.

1. Press the  home button, if necessary.
2. Press the left or right arrow button and then select **Setup**.
3. Select **Printer Setup**.

You see this screen:



4. Press the up or down arrow buttons to select **Sleep Timer**.
You see this screen:

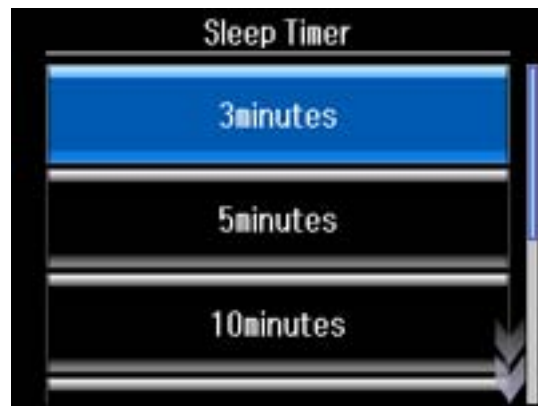

5. Press the up or down arrow buttons to select the time period you want before the product goes to sleep.
6. Press the  home button to exit.

Parent topic: [The Sleep Timer](#)

Changing the Sleep Timer Setting - Windows

You can use the printer software to change the time period before the printer enters sleep mode.

1. Access the Windows Desktop, right-click the product icon in the Windows taskbar, and select **Printer Settings**.
2. Click the **Maintenance** tab.
3. Click the **Printer and Option Information** button.

You see the Printer and Option Information screen:

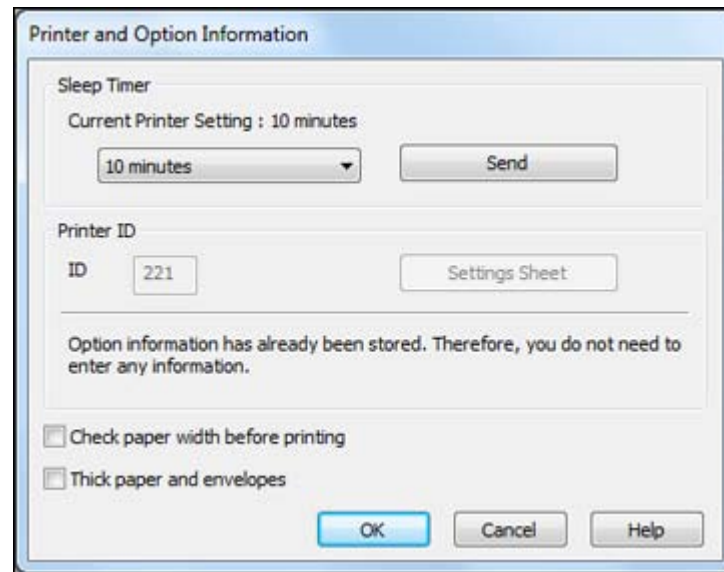

4. Select the time period you want before the product goes to sleep as the **Sleep Timer** setting.
5. Click **Send**.
6. Click **OK** to close the open program windows.

Parent topic: [The Sleep Timer](#)

Changing the Sleep Timer Setting - Mac OS X

You can use the printer software to change the time period before the printer enters sleep mode.

1. Do one of the following:
 - **Mac OS X 10.6/10.7/10.8:** In the Apple menu or the Dock, select **System Preferences**. Select **Print & Fax** or **Print & Scan**, select your product, and select **Options & Supplies**. Select **Utility** and select **Open Printer Utility**.
 - **Mac OS X 10.5:** In the Apple menu or the Dock, select **System Preferences**. Select **Print & Fax**, select your product, and select **Open Print Queue**. Select **Utility**.
2. Select **Printer Settings**.

You see this screen:

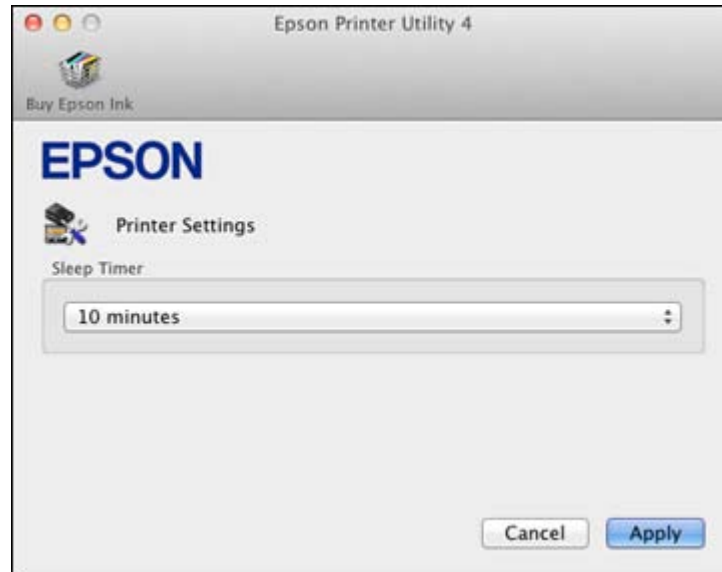

3. Select the time period you want before the product goes to sleep as the **Sleep Timer** setting.
4. Click **Apply**.
5. Close the Printer Settings window.

Parent topic: [The Sleep Timer](#)

Epson Connect Solutions for Smartphones, Tablets, and More

You can print documents, photos, emails, and web pages from your home, office, or even across the globe. You can use your smartphone, tablet, or computer. Epson offers these solutions to print and scan

from anywhere: Epson Email Print, Epson iPrint Mobile App, Epson Remote Print, and Epson Scan to Cloud

[Using Epson Email Print](#)

[Using the Epson iPrint Mobile App](#)

[Using Epson Remote Print](#)

[Using Epson Scan to Cloud](#)

Parent topic: [Product Basics](#)

Using Epson Email Print

With Epson Email Print, you can print from any device that can send email, such as your smartphone, tablet, or laptop. Just activate your product's unique email address. When you want to print, attach a PDF, Microsoft Office document, or photo and send an email to your product.

1. Set up your product for network printing as described in this manual. See the link below.
2. If you did not already set up Email Print when you installed your product software, visit epson.com/connect to learn more about Email Print, check compatibility, and get detailed setup instructions.
3. Send an email with attachments to your product's Email Print address.

Note: Both the email and any attachments print by default. You can change these printing options by logging into your Epson Connect account.

Parent topic: [Epson Connect Solutions for Smartphones, Tablets, and More](#)

Using the Epson iPrint Mobile App

Use this free Apple and Android app to print to nearby Epson networked products. The Epson iPrint Mobile App lets you print PDFs, Microsoft Office documents, photos, and web pages over a wireless network. You can even scan and save a file on your device, send it as an email, or upload it to an online service such as Box, Dropbox, Evernote, or Google Drive.

1. Set up your product on a network as described in this manual. See the link below.
2. Visit epson.com/connect to learn more about Epson iPrint and check the compatibility of your mobile device.
3. Download Epson iPrint from the Apple App Store or Google Play.
4. Connect your mobile device to the same wireless network that your product is using.
5. Print from your mobile device to your Epson product.

Parent topic: [Epson Connect Solutions for Smartphones, Tablets, and More](#)

Using Epson Remote Print

With Epson Remote Print software on your Windows computer or laptop, you can print to an Epson Email-enabled product anywhere in the world.

1. Set up your product for network printing as described in this manual. See the link below.
2. Visit epson.com/connect to learn more about Remote Print and how to download the software.
3. Download and install the Remote Print software.
4. Obtain the email address and optional access key of the Epson product you want to use for printing, and enter this address during Remote Print setup.
5. Select the print command in your application and choose the Remote Print driver for your Epson product.

Parent topic: [Epson Connect Solutions for Smartphones, Tablets, and More](#)

Using Epson Scan to Cloud

The Epson Scan to Cloud service sends your scanned files to a destination that you have registered with Epson Connect.

1. Set up your product for network printing as described in this manual. See the link below.
2. Visit epson.com/connect for instructions on registering an account and your product with Epson Connect.
3. After registering, sign in to the Epson Connect web page with the email address and password you selected.
4. Select **Destination List** for Scan to Cloud.
5. Click **Add**, then follow the instructions on the screen to create your destination list.
6. When you're ready to scan, select the setting for the Scan to Cloud service on your product control panel.

Parent topic: [Epson Connect Solutions for Smartphones, Tablets, and More](#)

Related tasks

[Starting a Scan Using the Product Control Panel](#)

Using AirPrint

AirPrint allows you to wirelessly print to your AirPrint-enabled product from iPhone, iPad, and iPod touch running the latest version of iOS.

1. Set up your product for wireless printing as described in this manual. See the link below.
2. Connect your Apple device to the same wireless network that your product is using.
3. Print from your iPad, iPhone, or iPod touch to your product.

Parent topic: [Product Basics](#)

Using Google Cloud Print

With a Google Account, you can print from your Apple or Android device to your Epson product. You can also print from Chromebooks and the Google Chrome browser without drivers or cables.

Set up your Epson product for network printing as described in this manual. See the link below.

Note: Make sure your Epson printer and computer are connected to the same network before starting the Google Cloud Print setup.

If your product is already on your network, follow these steps:

1. Connect your device to the same network that your Epson product is using.
2. Print a network status sheet.
3. Locate your product's IP address on the network status sheet.
4. Enter the IP address into the address bar of a web browser.
5. Select the **Google Cloud Print Services** option.

Note: If you don't see the **Google Cloud Print Services** option, turn your product off and back on. If the option still doesn't appear, select the **Firmware Update** option and follow the on-screen instructions to update your product.

6. Click **Register**.
7. Select the check box to agree to the Usage Advisory and click **Next**.
8. Click **OK** to launch the sign-in page.
A separate browser window opens.

9. Enter your Google Account username and password and click **Sign in**, or, if you don't have an account, click **Sign up for a new Google Account** and follow the on-screen instructions.
10. Click **Finish printer registration** to complete setup and print a test page.

Your product is now linked to your Google Account and can be accessed from any Chromebook, computer, Apple or Android device with internet access. Visit [Epson Support](#) for more information on using Google Cloud Print, or the [Google Cloud Print](#) website for a list of [supported apps](#).

Parent topic: [Product Basics](#)

Related tasks

[Printing a Network Status Sheet](#)

Wi-Fi Networking

See these sections to use your product on a Wi-Fi network.

[Selecting Wireless Network Settings From the Control Panel](#)

[Enabling Wi-Fi Direct Mode](#)

[Disabling and Re-enabling Wi-Fi Features](#)

Selecting Wireless Network Settings From the Control Panel

You can select or change wireless network settings using your product control panel.

To install your product on a wireless network, follow the instructions on the *Start Here* sheet and install the necessary software from the product CD. The installer program guides you through network setup.

Note: Breakdown or repair of this product may cause loss of fax and network data and settings. Epson is not responsible for backing up or recovering data and settings during or after the warranty period. We recommend that you make your own backup or print out your fax and network data and settings.

1. Press the  home button, if necessary.
2. Select **Wi-Fi Setup**.

You see this screen:



3. Select **Wi-Fi Setup Wizard**.

Note: If you need to disable the wireless network to set up your product on an Ethernet network, scroll down and select **Disable Wi-Fi** instead. Then follow the instructions on the *Start Here* sheet to set up your product on a wired network and install the necessary software from the product CD. The installer program guides you through network setup.

4. Select the name of your wireless network or enter the name manually.

Note: To enter the wireless network name manually, scroll down and then select **Other Networks**. Use the displayed keypad to enter your network name, as described in the next step.

5. Enter your wireless password (or network name and then password) using the displayed keypad.



Note: The network name and password are case sensitive. Be sure to correctly enter uppercase and lowercase letters, and numeric or special characters.

- Press the touch screen buttons repeatedly to scroll through characters.
 - Press **←** or **→** to move the cursor.
 - Press **1 Symb.** to enter symbols.
 - Press **X** to delete the previous character.
6. Press **Done** when you're finished entering your password.

7. Confirm the displayed network settings and select **Proceed** to save them.

Note: If you need to change a setting, press the ↶ back button.

8. If you want to print a network setup report, press the ⬠ start button. (Otherwise, select **Cancel**.)
9. Press the 🏠 home button to exit.

The WiFi light should now be on.

Note: If the WiFi light is off, you may have selected the wrong network name or entered the password incorrectly. Repeat these steps to try again.

Parent topic: [Wi-Fi Networking](#)

Enabling Wi-Fi Direct Mode

You can enable Wi-Fi Direct mode to allow direct communication between your product and computer or other devices without a wireless router or access point.

Note: If the printer is already connected to a wireless router or access point, you must disable Wi-Fi on the printer before you can use Wi-Fi Direct.

1. Press the 🏠 home button, if necessary.
2. Select **Wi-Fi Setup**.

You see this screen:



3. Scroll down and select **Wi-Fi Direct Connection Setup** .
4. Select **Proceed**.
5. When you see a message asking you to select the Wi-Fi Network, scroll down to view the SSID (Wi-Fi network name) and password.
6. Select **Change Password** and select **Proceed**.

Note: If you have already connected devices or computers to your product via Wi-Fi Direct, they will be disconnected when you change the password.

7. Enter a Wi-Fi Direct password.

Note: The password must be at least 8 and no more than 22 characters long.



- Press the touch screen buttons repeatedly to scroll through characters.
 - Press **←** or **→** to move the cursor.
 - Press **1 Symb.** to enter symbols.
 - Press **X** to delete the previous character.
8. Press **Done** when you finish entering your password.
 9. Scroll down to view the SSID (Wi-Fi network name) and password.
 10. Select **Proceed**.

11. Use your computer or wireless device to select the Wi-Fi network name (SSID) displayed on the LCD screen, then enter the password shown.
12. Press the  home button to exit.

You see an **AP** connection symbol on the LCD screen and should be able to print directly to your product from your computer or device.

Note: If the **AP** connection symbol is not displayed on the LCD screen, Wi-Fi Direct mode is not enabled. Repeat these steps to try again.

Parent topic: [Wi-Fi Networking](#)

Disabling and Re-enabling Wi-Fi Features

You may need to disable your product's Wi-Fi features if you change your network connection type or need to solve a problem with your network connection.

Note: Before disabling Wi-Fi features, make a note of your product's SSID (network name) and password, and any network settings selected for the Epson Connect services you may use.

1. Press the  home button, if necessary.
2. Select **Wi-Fi Setup**.

You see this screen:



3. Scroll down and select **Disable Wi-Fi**.

4. Select **Yes**.
5. When you see the confirmation message, select **OK**.

Note: To re-enable Wi-Fi and reconnect to your previous network, select **Wi-Fi Setup > Wi-Fi Setup Wizard**, then select **Yes**.

Parent topic: [Wi-Fi Networking](#)

Loading Paper

Before you print, load paper for the type of printing you will do.

[Loading Paper in Cassette 1 \(Upper Cassette\)](#)

[Loading Paper in Cassette 2 \(Lower Cassette\)](#)

[Loading Paper in the Rear Paper Feed Slot](#)

[Loading Envelopes](#)

[Paper Loading Capacity](#)

[Available Epson Papers](#)

[Borderless Paper Type Compatibility](#)

[Paper or Media Type Settings](#)

Loading Paper in Cassette 1 (Upper Cassette)

You can load photo paper and other media in these sizes in the upper paper cassette:

- 3.5 x 5 inches (89 x 127 mm)
- 4 x 6 inches (102 x 152 mm)
- 5 x 7 inches (127 x 178 mm)
- A6 (4.1 x 5.8 inches [105 x 148 mm])
- 16:9 wide (4 x 7.1 inches [102 x 181 mm])

Note: Do not remove or insert the paper cassette during printing.

1. Close the output tray, if necessary.

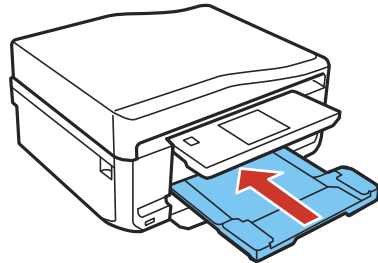

Note: As you slide in the output tray, there may be slight resistance and noise. This is normal.

2. Open the front cover.

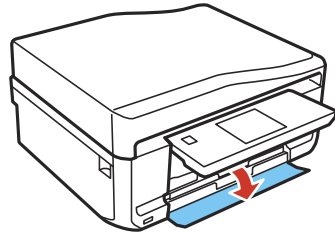

3. Pull out the upper paper cassette. The upper cassette has a ► label on the right side.

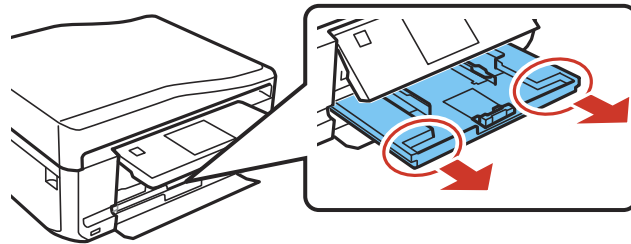

4. Slide the edge guides outward.

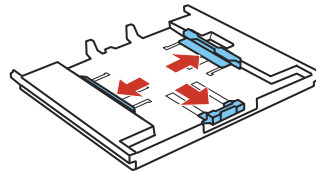

5. Set the front edge guide to the position for the paper size you are using.

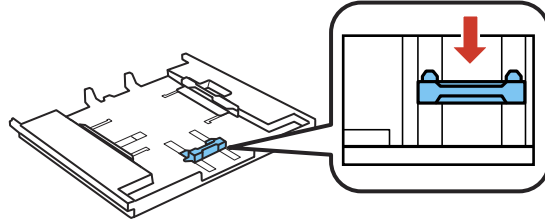

Note: Various paper sizes are marked on the tray.

6. Insert paper with the glossy or printable side facedown.

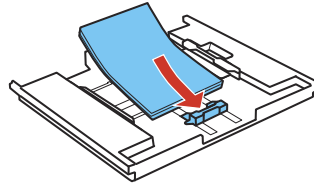

Note: Make sure the paper is loaded against the front edge guide.

7. Slide the side edge guides against the paper, but not too tightly.

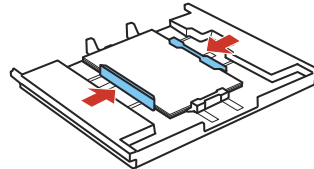

Note: Make sure the paper is under the tabs on the edge guides.

8. Keep the cassette flat as you insert it.

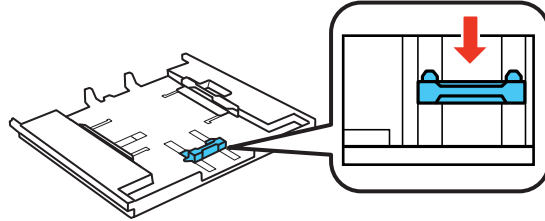

Note: The output tray opens automatically when you print. Leave enough space in front of the product for the paper to be fully ejected. Do not remove or insert the paper cassette while the product is operating.

Always follow these paper loading guidelines:

- Load only the recommended number of sheets.
- Load paper short edge first and printable side facedown.
- Make sure the paper is under the tabs on the edge guides and not sticking out from the end of the cassette.
- Check the paper package for any additional loading instructions.

Parent topic: [Loading Paper](#)

Related references

[Paper Loading Capacity](#)

Related tasks

[Loading Paper in Cassette 2 \(Lower Cassette\)](#)

[Loading Paper in the Rear Paper Feed Slot](#)

[Loading Envelopes](#)

Loading Paper in Cassette 2 (Lower Cassette)

You can load paper up to this size in the lower paper cassette: Legal (8.5 × 14 inches [216 × 357 mm]).

Note: Do not remove or insert the paper cassette during printing.

1. Close the output tray, if necessary.

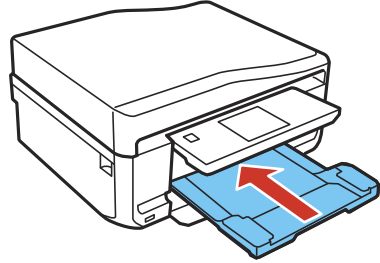

Note: As you slide in the output tray, there may be slight resistance and noise. This is normal.

2. Open the front cover.

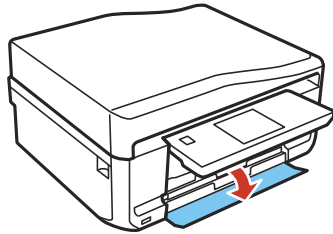

3. Pull on the front cover to pull out the lower paper cassette.

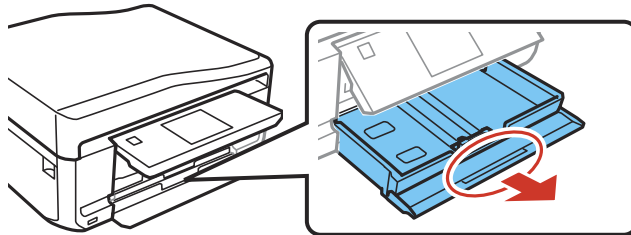

4. Slide the edge guides outward.

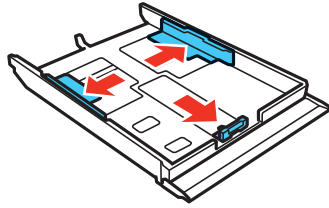

Note: If you are using legal-size paper, remove the CD/DVD tray from the product. Press the button on the cassette and then extend it as shown.

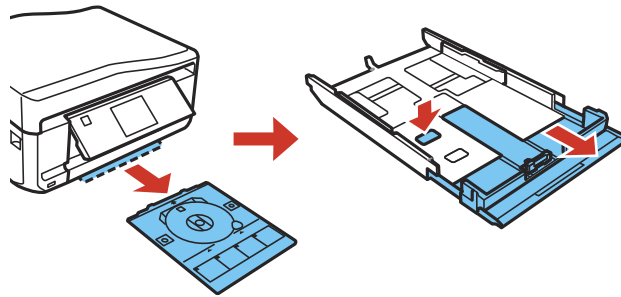

5. Set the front edge guide to the paper size you are using.

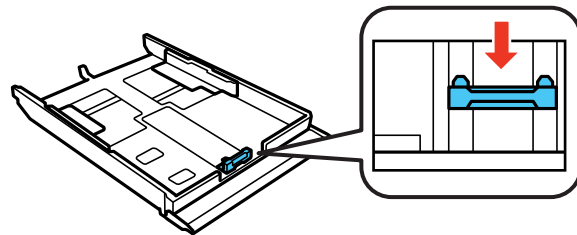

Note: Various paper sizes are marked on the tray.

6. Insert paper with the glossy or printable side facedown.

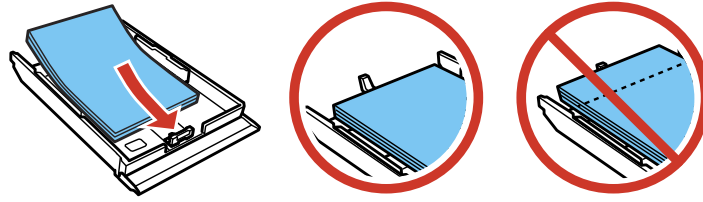

Note: Make sure the paper is loaded against the edge guide and not sticking out from the end of the cassette.

7. Slide the side edge guides against the paper, but not too tightly.

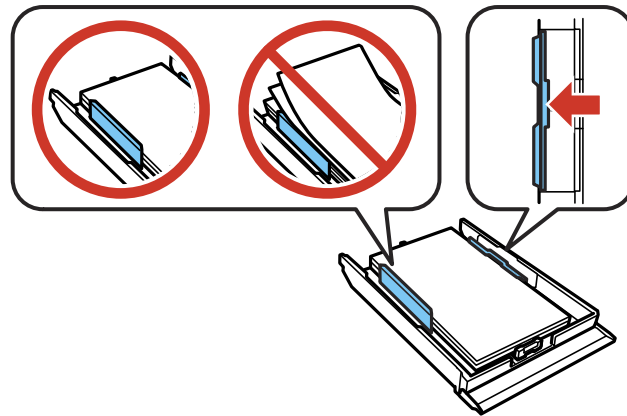

Note: Make sure the paper is under the tabs on the edge guides.

8. Keep the cassette flat as you insert it.

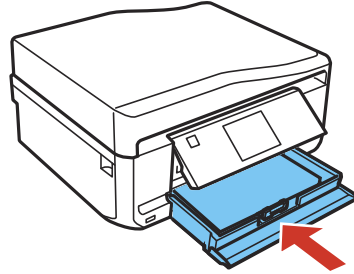

Note: The output tray opens automatically when you print. Leave enough space in front of the product for the paper to be fully ejected. Do not remove or insert the paper cassette while the product is operating.

Always follow these paper loading guidelines:

- Load only the recommended number of sheets.
- Load paper short edge first and printable side facedown.
- Make sure the paper is under the tabs on the edge guides and not sticking out from the end of the cassette.
- Check the paper package for any additional loading instructions.

Parent topic: [Loading Paper](#)

Related references

[Paper Loading Capacity](#)

Related tasks

[Loading Paper in Cassette 1 \(Upper Cassette\)](#)

[Loading Paper in the Rear Paper Feed Slot](#)

[Loading Envelopes](#)

Loading Paper in the Rear Paper Feed Slot

You can load card stock, envelopes, and other thick media in the rear paper feed slot.

Note: Paper that is too stiff may not load correctly. Check the paper specifications.

1. Send your print job from a computer or using the product's touch screen.
 - If printing from a computer, select **Rear Paper Feed Slot** for the **Source** (Windows) or **Paper Source** (Mac OS X) setting.
 - If printing from the product's touch screen, select **Rear Paper Feed Slot** for the **Paper Source** setting.
2. Flip open the rear paper feed slot cover and swing out the paper support.

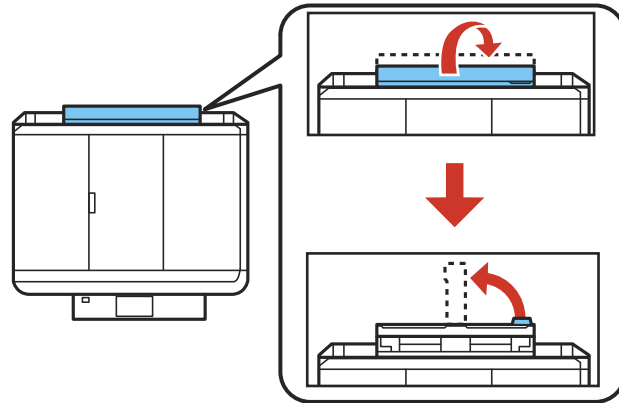

3. Slide the edge guides outward.

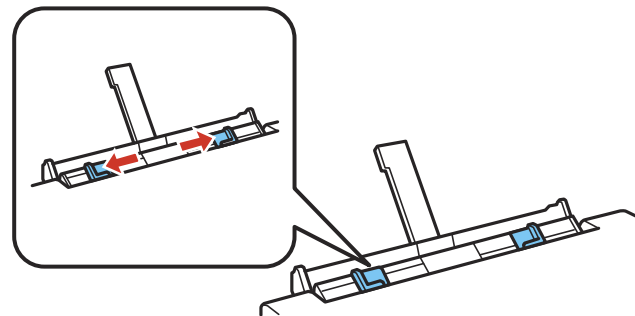

4. Do one of the following:

- Load a single sheet of paper or thick media, printable side up and short edge first, in the center of the rear paper feed slot. Slide the edge guides against the paper, but not too tightly.

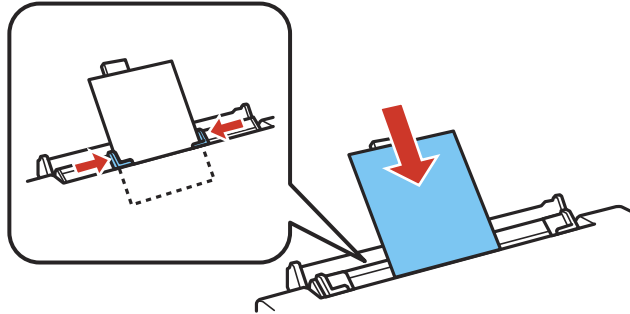

- Load an envelope, short edge first with the flap facing down, in the center of the rear paper feed slot. Slide the edge guides against the envelope, but not too tightly.

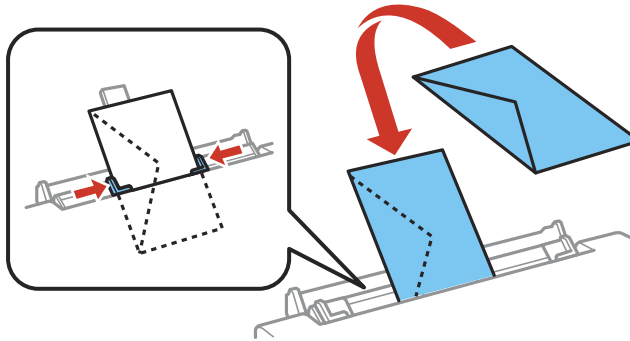

5. Push the paper or envelope down until it meets resistance. About 2 inches (5 cm) of the paper should be fed inside the printer as shown.

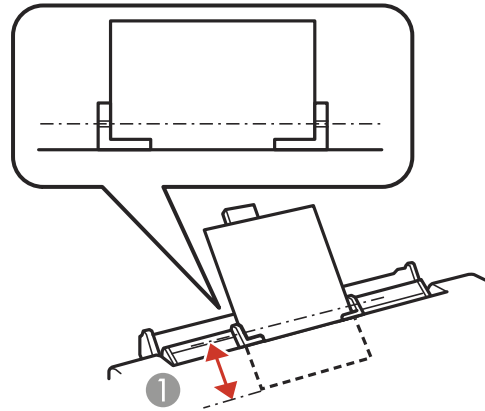

1 2 inches (5 cm)

6. When you are ready to print, press the  start button.

Note: To cancel printing, select **Cancel**.

Always follow these loading guidelines:

- Load one sheet or envelope at a time.
- Load the paper or envelope short edge first and printable side faceup.
- Check the paper package for any additional loading instructions.

Parent topic: [Loading Paper](#)

Related references

[Paper Loading Capacity](#)

[Paper Specifications](#)

Related tasks

[Loading Paper in Cassette 1 \(Upper Cassette\)](#)

[Loading Paper in Cassette 2 \(Lower Cassette\)](#)

Loading Envelopes

Loading Envelopes

You can load envelopes in Cassette 2 (lower cassette) as described here. You can print on plain paper envelopes in this size: No. 10 (4.1 × 9.5 inches [105 × 241 mm]).

You can also load a single envelope in the rear paper feed slot, as described in that section.

Note: Do not remove or insert the paper cassette during printing.

1. Close the output tray, if necessary.

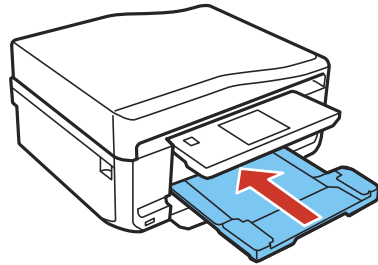

Note: As you slide in the output tray, there may be slight resistance and noise. This is normal.

2. Open the front cover.

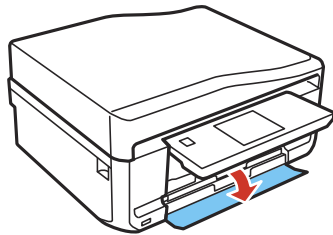

3. Pull on the front cover to pull out the lower paper cassette.

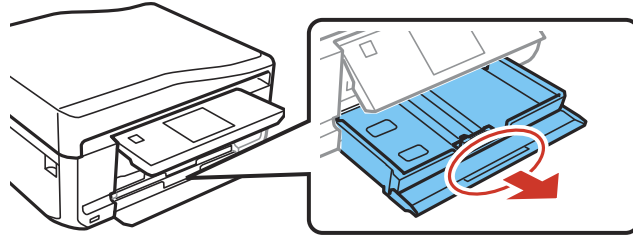

4. Slide the edge guides outward.

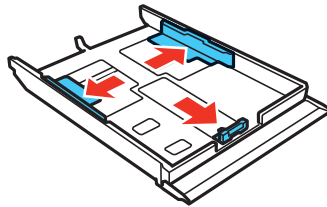

5. Insert up to 10 envelopes, printable side facedown and flap edge left, as shown.

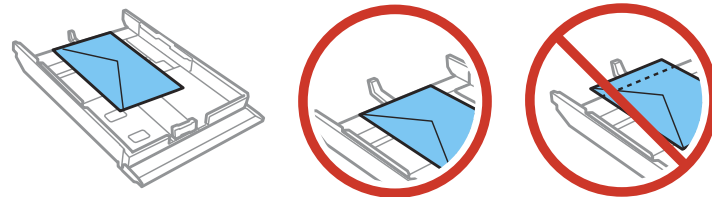

Note: Make sure the envelope is not sticking out from the end of the cassette.

6. Slide the edge guides against the envelopes, but not too tightly.

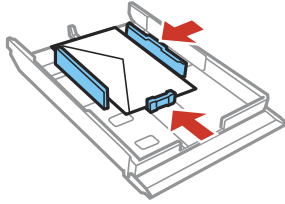

Note: Make sure the envelopes are under the tabs on the edge guides.

7. Keep the cassette flat as you insert it.

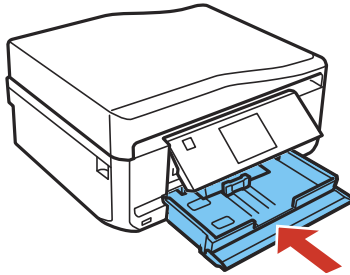

Note: The output tray opens automatically when you print.

Always follow these envelope loading guidelines:

- If you have trouble loading a stack of envelopes, press each envelope flat before loading it or load one envelope at a time.
- Do not load envelopes that are curled, folded, or too thin.

Parent topic: [Loading Paper](#)

Related references

[Paper Loading Capacity](#)

Related tasks

[Loading Paper in Cassette 1 \(Upper Cassette\)](#)

[Loading Paper in Cassette 2 \(Lower Cassette\)](#)

Loading Paper in the Rear Paper Feed Slot

Paper Loading Capacity

Load one sheet of paper or one envelope at a time in the rear paper feed slot. See the table here for the loading capacity of the paper cassettes.

Paper type	Load up to this many sheets	
	Cassette 2 (lower cassette)	Cassette 1 (upper cassette)
Plain paper	Letter (8.5 × 11 inches [216 × 279 mm]), A4 (8.3 × 11.7 inches [210 × 297 mm]), or Legal (8.5 × 14 inches [216 × 357 mm]) size: 100 sheets	—
Epson Bright White Paper Epson Presentation Paper Matte	80 sheets	—
Epson Premium Presentation Paper Matte Epson Ultra Premium Presentation Paper Matte	20 sheets	—
Epson Photo Paper Glossy Epson Premium Photo Paper Glossy Epson Ultra Premium Photo Paper Glossy Epson Premium Photo Paper Semi-gloss Epson Ultra Premium Photo Paper Luster	20 sheets	20 sheets

Paper type	Load up to this many sheets	
	Cassette 2 (lower cassette)	Cassette 1 (upper cassette)
Epson Premium Presentation Paper Matte Double-sided Epson Photo Quality Self-adhesive Sheets Epson Iron-on Cool Peel Transfer paper Epson Brochure & Flyer Paper Matte Double-sided	1 sheet	—
Envelopes	10 envelopes	—

Parent topic: [Loading Paper](#)

Available Epson Papers

You can purchase genuine Epson ink and paper at Epson Supplies Central at epson.com/ink3 (U.S. sales) or epson.ca (Canadian sales). You can also purchase supplies from an Epson authorized reseller. To find the nearest one, call 800-GO-EPSON (800-463-7766).

Paper Type	Size	Part number	Sheet count
Epson Bright White Paper	Letter (8.5 × 11 inches [216 × 279 mm])	S041586	500
Epson Photo Paper Glossy	4 × 6 inches (102 × 152 mm)	S041809	50
		S042038	100
	Letter (8.5 × 11 inches [216 × 279 mm])	S041141	20
		S041649	50
		S041271	100

Paper Type	Size	Part number	Sheet count
Epson Premium Photo Paper Glossy	4 x 6 inches (102 x 152 mm)	S041808	40
		S041727	100
	5 x 7 inches (127 x 178 mm)	S041464	20
	8 x 10 inches (203 x 254 mm)	S041465	20
Epson Ultra Premium Photo Paper Glossy	Letter (8.5 x 11 inches [216 x 279 mm])	S042183	25
		S041667	50
	4 x 6 inches (102 x 152 mm)	S042181	60
		S042174	100
Epson Ultra Premium Photo Paper Glossy	5 x 7 inches (127 x 178 mm)	S041945	20
	8 x 10 inches (203 x 254 mm)	S041946	20
	Letter (8.5 x 11 inches [216 x 279 mm])	S042182	25
	S042175	50	
Epson Ultra Premium Photo Paper Luster	Letter (8.5 x 11 inches [216 x 279 mm])	S041405	50
Epson Premium Photo Paper Semi-gloss	4 x 6 inches (102 x 152 mm)	S041982	40
	Letter (8.5 x 11 inches [216 x 279 mm])	S041331	20
Epson Presentation Paper Matte	Letter (8.5 x 11 inches [216 x 279 mm])	S041062	100
	Legal (8.5 x 14 inches [216 x 357 mm])	S041067	100
Epson Premium Presentation Paper Matte	8 x 10 inches (203 x 254 mm)	S041467	50
	Letter (8.5 x 11 inches [216 x 279 mm])	S041257	50
		S042180	100
Epson Premium Presentation Paper Matte Double-sided	Letter (8.5 x 11 inches [216 x 279 mm])	S041568	50
Epson Ultra Premium Presentation Paper Matte	Letter (8.5 x 11 inches [216 x 279 mm])	S041341	50

Paper Type	Size	Part number	Sheet count
Epson Brochure & Flyer Paper Matte Double-sided	Letter (8.5 × 11 inches [216 × 279 mm])	S042384	150
Epson Photo Quality Self-adhesive Sheets	A4 (8.3 × 11.7 inches [210 × 297 mm])	S041106	10
Epson Iron-on Cool Peel Transfer paper	Letter (8.5 × 11 inches [216 × 279 mm])	S041153	10
Epson Velvet Fine Art Paper	Letter (8.5 × 11 inches [216 × 279 mm])	S041636	20

Parent topic: [Loading Paper](#)

Borderless Paper Type Compatibility

You can print borderless photos on compatible paper types in compatible sizes:

Borderless Paper Types

- Epson Photo Paper Glossy
- Epson Premium Photo Paper Glossy
- Epson Ultra Premium Photo Paper Glossy
- Epson Premium Photo Paper Semi-gloss
- Epson Ultra Premium Photo Paper Luster
- Epson Premium Presentation Paper Matte
- Epson Ultra Premium Presentation Paper Matte

Borderless Paper Sizes

- 3.5 × 5 inches (89 × 127 mm)
- 4 × 6 inches (102 × 152 mm)
- 16:9 wide (4 × 7.1 inches [102 × 181 mm])
- 5 × 7 inches (127 × 178 mm)
- 8 × 10 inches (203 × 254 mm)
- Letter (8.5 × 11 inches [216 × 279 mm])

- A4 (8.3 × 11.7 inches [210 × 297 mm])

Parent topic: [Loading Paper](#)

Paper or Media Type Settings

For this paper	Select this paper Type or Media Type setting
Plain paper Epson Bright White Paper Epson Iron-on Cool Peel Transfer paper Epson Photo Quality Self-adhesive Sheets	Plain Paper/Bright White Paper
Epson Ultra Premium Photo Paper Glossy	Ultra Premium Photo Paper Glossy
Epson Premium Photo Paper Glossy	Premium Photo Paper Glossy
Epson Photo Paper Glossy	Photo Paper Glossy
Epson Presentation Paper Matte	Presentation Paper Matte
Epson Premium Photo Paper Semi-gloss	Premium Photo Paper Semi-Gloss
Epson Ultra Premium Photo Paper Luster	Ultra Premium Photo Paper Luster
Epson Premium Presentation Paper Matte Epson Premium Presentation Paper Matte Double-sided Epson Ultra Premium Presentation Paper Matte Epson Brochure & Flyer Paper Matte Double-sided	Premium Presentation Paper Matte
Epson Velvet Fine Art Paper	Velvet Fine Art Paper
Envelopes	Envelope

Note: The settings listed here are available only when printing from your computer; they do not apply to your product's control panel settings.

Parent topic: [Loading Paper](#)

Placing Originals on the Product

Follow the instructions here to place your original documents or photos on the product.

Caution: Do not place anything on top of your product or use its cover as a writing surface to avoid damaging it.

[Placing Originals on the Scanner Glass](#)

[Placing Originals in the Automatic Document Feeder](#)

Placing Originals on the Scanner Glass

You can place originals up to this size on the scanner glass: Letter (8.5 × 11 inches [216 × 279 mm]) or A4 (8.3 × 11.7 inches [210 × 297 mm]).

1. Open the document cover.
2. Place your original facedown on the scanner glass with the top of the original facing into the corner shown. Slide the original to the edges of the indicated corner.

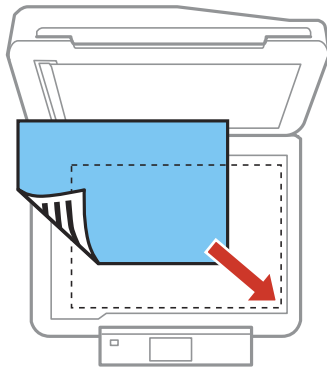

Note: You can place multiple originals on the scanner glass. Just make sure they are at least 0.20 inch (5 mm) away from each other and from the edge of the scanner glass.

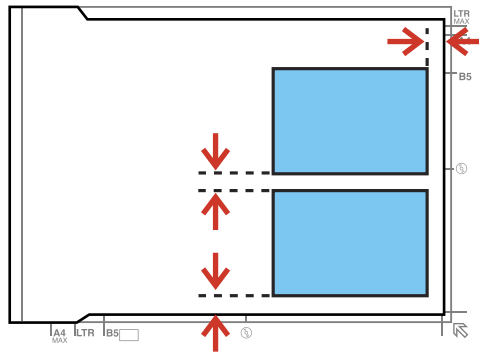

3. If you are copying two book pages onto one sheet, place the book as shown to copy the first page, then turn the book as shown to copy the second page.

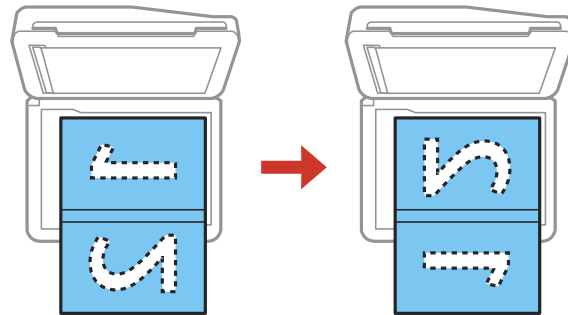

4. Close the document cover gently to keep your original in place.

Parent topic: [Placing Originals on the Product](#)

Related topics

[Copying](#)

[Scanning](#)

[Faxing](#)

Placing Originals in the Automatic Document Feeder

You can place multi-page original documents in the Automatic Document Feeder (ADF). Make sure the originals meet the Automatic Document Feeder specifications before loading them.

Caution: Make sure your originals are not creased or folded, and do not contain holes, staples, tape, or other materials that could obstruct the feeder.

1. Open the ADF paper support, and then slide out the output tray extension.

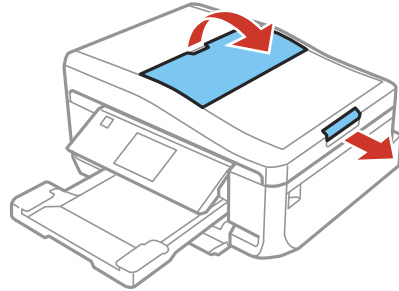

2. Slide the ADF edge guide outward.

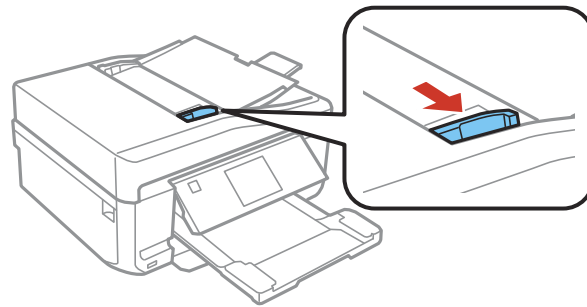

3. Fan your stack of originals and tap them gently on a flat surface to even the edges.

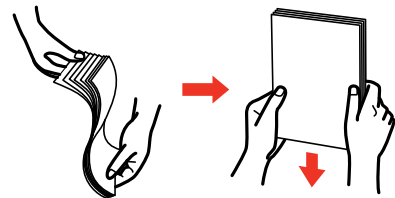

4. Insert the originals into the ADF faceup and top-edge first.

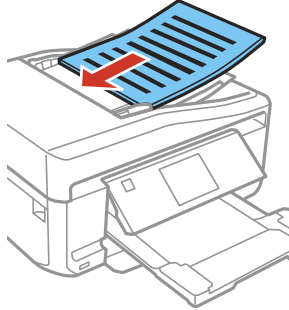

5. Slide the ADF edge guide against the originals, but not too tightly.

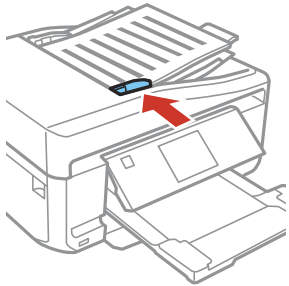

Note: If you're using the **Letter, 2-up Copy**, or **A4, 2-up Copy** layout, make sure the originals are loaded as shown.

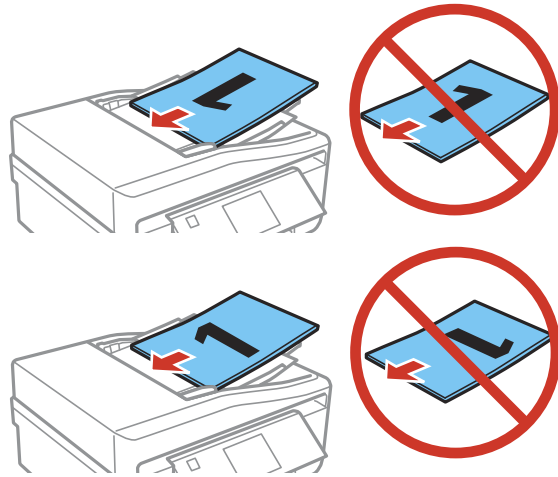

Parent topic: [Placing Originals on the Product](#)

Related references

[Automatic Document Feeder \(ADF\) Specifications](#)

Related topics

[Copying](#)

[Scanning](#)

[Faxing](#)

Copying

See the information here to copy documents or photos using your product.

Note: Copies may not be exactly the same size as your originals.

[Copying Documents or Photos](#)

[Copying and Restoring Photos](#)

Related tasks

[Copying onto a CD/DVD](#)

Copying Documents or Photos

You can copy documents or photos onto various sizes and types of paper, including Epson special papers.

1. Place your original document or photo on the scanner glass, or load your documents in the ADF.
2. Load the paper you want to print on.

Note: Load only the recommended number of sheets.

3. Select **Copy**.

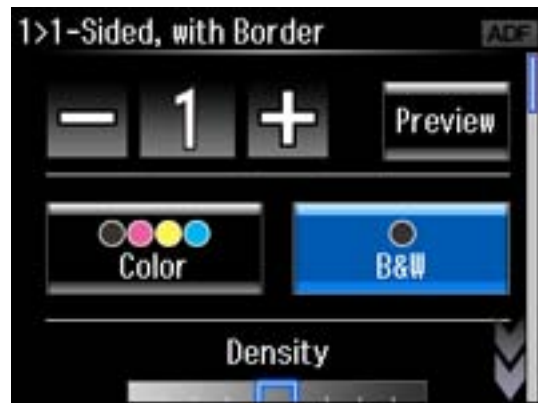

4. To print more than one copy, press + or – to select the number (up to 99).

5. Select **Color** or **B&W**.
6. Scroll down to view and change additional copy settings, if necessary.
7. When you are ready to copy, press \diamond start.

Note: To cancel printing, select **Cancel**.

[Paper Type Settings - Copying](#)

[Paper Size Settings - Copying](#)

[Copying Options](#)

Parent topic: [Copying](#)

Related references

[Paper Loading Capacity](#)

[Available Epson Papers](#)

Related topics

[Loading Paper](#)

[Placing Originals on the Product](#)

Paper Type Settings - Copying

Select a **Paper Type** setting that matches the paper you loaded.

Paper type loaded	Paper Type setting
Plain paper	Plain Paper
Epson Bright White Paper	
Epson Presentation Paper Matte	
Epson Iron-on Cool Peel Transfer paper	
Epson Photo Quality Self-adhesive Sheets	
Epson Premium Presentation Paper Matte	Matte
Epson Ultra Premium Presentation Paper Matte	
Epson Premium Presentation Paper Matte Double-sided	

Paper type loaded	Paper Type setting
Epson Premium Photo Paper Glossy Epson Premium Photo Paper Semi-gloss Epson Ultra Premium Photo Paper Luster	Prem. Glossy
Epson Ultra Premium Photo Paper Glossy	Ultra Glossy
Epson Photo Paper Glossy	Glossy

Parent topic: [Copying Documents or Photos](#)

Paper Size Settings - Copying

Select the **Paper Size** setting that matches the paper you loaded.

Note: You can copy photos only on these paper sizes.

- 4 x 6 inches (102 x 152 mm)
- 5 x 7 inches (127 x 178 mm)
- 8 x 10 inches (203 x 254 mm)
- Letter (8.5 x 11 inches [216 x 279 mm])
- A4 (8.3 x 11.7 inches [210 x 297 mm])
- Legal (8.5 x 14 inches [216 x 357 mm])

Parent topic: [Copying Documents or Photos](#)

Copying Options

Select the copying options you want to use for your copies.

Note: Not all options or settings may be available, depending on other copying settings.

Copying option	Available settings	Description
Density	Varying levels	Adjusts the lightness or darkness of copies

Copying option	Available settings	Description
2-Sided Copying	1>1-Sided	Uses the duplexer and ADF to make 2-sided copies
	2>2-Sided	
	1>2-Sided	
	2>1-Sided	
Layout	With Border	Leaves a small margin around the image
	Borderless	Expands the image to the edge of the paper (slight cropping may occur)
	A4, 2-up Copy	Copies 2 originals onto a single A4-size sheet
	Letter, 2-up Copy	Copies 2 originals onto a single letter-size sheet
	A4, Book/2-up	Copies 2 pages of a book or magazine onto a single A4-size sheet
	Letter, Book/2-up	Copies 2 pages of a book or magazine onto a single letter-size sheet
Reduce/Enlarge	Custom Size	Automatically sizes the image by the percentage you select
	Actual Size	Copies at 100% size
	Auto Fit Page	Automatically sizes the image to fit the selected paper size setting
	Letter->4x6in and other conversions	Automatically converts from one size to another
Paper Size	Various sizes	Selects the paper size for the copy printout
Paper Type	Plain Paper	Adjusts printer settings for the selected paper type
	Matte	
	Prem. Glossy	
	Ultra Glossy	
	Glossy	

Copying option	Available settings	Description
Paper Source	Cassette 1	Copies onto paper loaded in Cassette 1 (upper cassette)
	Cassette 2	Copies onto paper loaded in Cassette 2 (lower cassette)
Document Type	Text	Copies a text document
	Text & Image	Copies a document that includes text and images
	Photo	Copies a photograph
Quality	Draft	Provides lower quality for draft copies (plain paper only)
	Standard Quality	Provides good quality for most copies
	Best	Provides the highest quality for special copies
Documentation Orientation	Portrait	Specifies the orientation of your originals (only available when 2>1-Sided or 1>2-Sided is selected)
	Landscape	
Binding Direction	Left Edge	Specifies the binding edge of your double-sided originals (only available when 2>1-Sided is selected)
	Top Edge	
Binding Margin	Left Edge	Specifies the binding edge of your double-sided copies (only available when 1>2-Sided is selected)
	Top Edge	
Expansion	Standard	Adjusts the amount of expansion for printing borderless photos
	Medium	
	Minimum	
Dry Time	Standard	Provides longer drying time for 2-sided copies, if smudges or marks appear on the front of the paper when you print on the second side
	Long	
	Longer	
Clear All Settings	—	Restores the copy settings to the default settings

Parent topic: [Copying Documents or Photos](#)

Copying and Restoring Photos

You can restore the colors in faded photos as you copy them.

1. Load photo paper in the product.
2. Press the  home button, if necessary.
3. Select **More Functions**.
4. Select **Copy/Restore Photos**.



5. Select **On**.
6. Place up to two original photos on the product.

Note: View the LCD screen for instructions on placing your photos on the product.
7. Press the  start button.
8. Press **+** or **-** to select one or more copies of the photo (up to 99).
9. If you placed two originals on the scanner, press the left or right arrow button to view the second original, then press **+** or **-** to select one or more copies of the photo (up to 99).
10. To adjust your print and copy settings, do one or more of the following:
 - To change the print settings, select **Settings**, and select the necessary settings.
 - To adjust the copy image, select **Edit > Photo Adjustments**, then select your settings.

- To crop or zoom into your photo, select **Edit > Crop/Zoom**, then press the icons displayed on the LCD screen to crop your image.

11. When you are ready to print, press the  start button.

Note: To cancel printing, select **Cancel**.

Parent topic: [Copying](#)

Related references

[Paper Loading Capacity](#)

[Available Epson Papers](#)

[Paper Type Settings - Copying](#)

[Paper Size Settings - Copying](#)

[Copying Options](#)

Related tasks

[Placing Originals on the Scanner Glass](#)

Related topics

[Loading Paper](#)

Printing From a Computer

Before printing from your computer, make sure you have set up your product and installed its software as described on the *Start Here* sheet.

Note: If you have an Internet connection, it is a good idea to check for updates to your product software on Epson's support website. If you see a Software Update screen, select **Enable automatic checking** and click **OK**. The update scans your system to see if you have the latest product software. Follow the on-screen instructions.

[Printing with Windows](#)

[Printing with Mac OS X](#)

[Cancelling Printing Using a Product Button](#)

Related tasks

[Checking for Software Updates](#)

Printing with Windows

You can print with your product using any Windows printing program, as described in these sections.

[Selecting Basic Print Settings - Windows](#)

[Selecting Advanced Print Settings - Windows](#)

[Selecting Print Layout Options - Windows](#)

[Selecting a Printing Preset - Windows](#)

[Selecting Double-sided Printing Settings - Windows](#)

[Printing Your Document or Photo - Windows](#)

[Selecting Default Print Settings - Windows](#)

[Changing Automatic Update Options](#)

Parent topic: [Printing From a Computer](#)

Selecting Basic Print Settings - Windows

Select the basic settings for the document or photo you want to print.

1. Open a photo or document for printing.

2. Select the print command in your application.

Note: You may need to select a print icon on your screen, the **Print** option in the File menu, or another command. See your application's help utility for details.

3. If necessary, select your product name as the printer you want to use.

Note: You may also need to select **Properties** or **Preferences** to view your print settings.

You see the Main tab of your printer settings window:

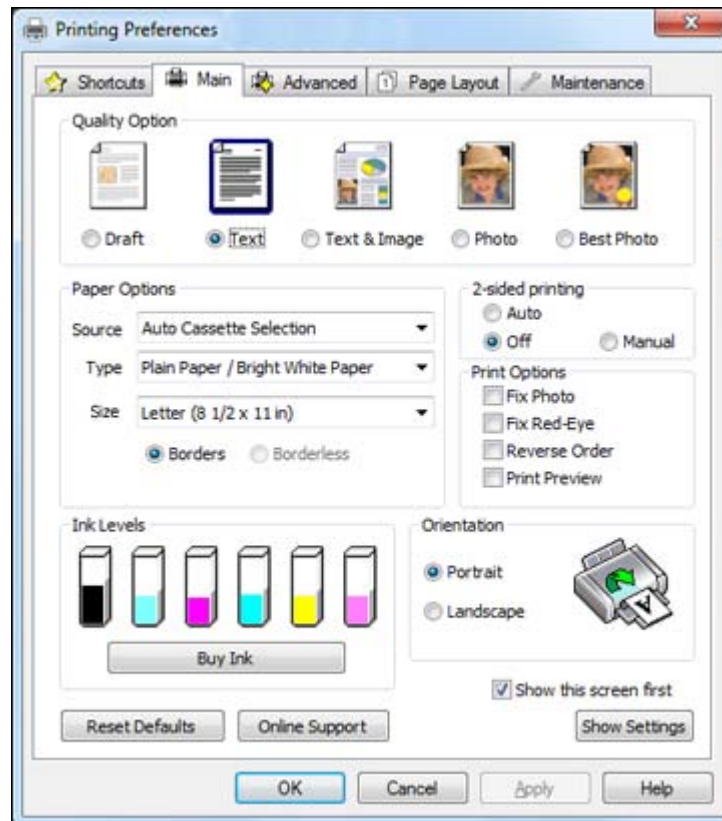

4. Select the **Quality Option** setting that matches your print content and the print quality you want to use.
5. Select the **Source** setting that indicates where you loaded the paper or CD/DVD you want to print on.
6. Select the type of paper you loaded as the **Type** setting.

Note: The setting may not exactly match the name of your paper. Check the paper type settings list for details.

7. Select the size of the paper you loaded as the **Size** setting.

Note: You can also select the **User-Defined** setting to create a custom paper size.

8. Select one of the border options:
 - If you are printing a borderless photo, select **Borderless**.

Note: You must select a compatible borderless paper type and size to print without borders. Check the borderless paper compatibility list for details.

- If you are printing a document or a photo with borders, select **Borders**.

9. Select the orientation of your document or photo as shown in the printer settings window.

Note: If you are printing an envelope, select **Landscape**.

10. To print on both sides of the paper, select a **2-sided printing** option.
11. Select any of the available print options.

Note: If you need to access the Epson product support website, click the **Online Support** button.

[Paper Source Options - Windows](#)

[Basic Print Options - Windows](#)

Parent topic: [Printing with Windows](#)

Related references

[Borderless Paper Type Compatibility](#)

[Paper or Media Type Settings](#)

Related tasks

[Selecting Double-sided Printing Settings - Windows](#)

Paper Source Options - Windows

You can select any of the available options in the Paper Source menu to print on the paper loaded in that source.

Auto Cassette Selection

Automatically selects the paper source based on the selected paper size.

Cassette 1

Selects the paper in cassette 1 as the paper source.

Cassette 2

Selects the paper in cassette 2 as the paper source.

Cassette 1 > Cassette 2

Selects the paper in cassette 1 as the paper source and automatically switches to cassette 2 when cassette 1 is empty.

CD/DVD

Selects the CD or DVD loaded as the source.

Parent topic: [Selecting Basic Print Settings - Windows](#)

Basic Print Options - Windows

You can select any of the basic print options to customize your print. Some options may be pre-selected or unavailable, depending on other settings you have chosen.

Fix Photo

Improves the color, contrast, and sharpness of flawed photos.

Note: Fix Photo uses a sophisticated face recognition technology to optimize photos that include faces. For this to work, both eyes and the nose must be visible in the subject's face. If your photo includes a face with an intentional color cast, such as a statue, you may want to turn off **Fix Photo** to retain the special color effects.

Fix Red-Eye

Reduces or removes red-eye in photos.

Reverse Order

Prints multi-page print jobs last page first.

Print Preview

Displays a preview of your printout before printing.

Parent topic: [Selecting Basic Print Settings - Windows](#)

Selecting Advanced Print Settings - Windows

Select print settings on the Advanced tab to customize the quality and color settings for your printout, and save your own printing presets.

1. Click the **Advanced** tab.

You see the advanced print settings:

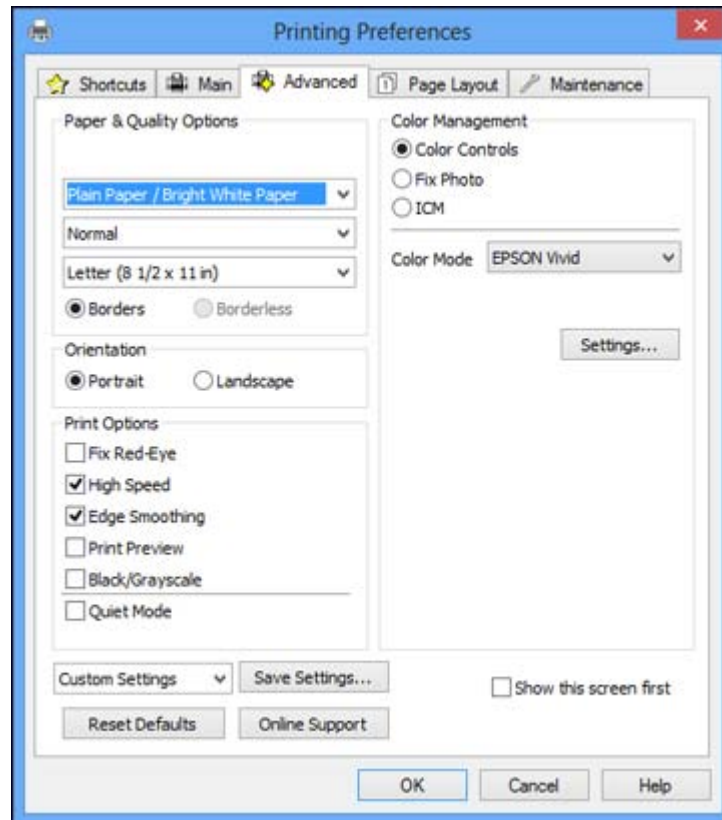

2. Select the **Paper & Quality Options** settings for your printout:
 - Select where you loaded the paper or CD/DVD you want to print on.
 - Select the type of paper you loaded.

Note: Check the paper type settings list for details.

- Select the print quality setting you want to use.

Note: Check the print quality settings list for details.

- Select the size of the paper you loaded.
- Select **Borderless** to print a borderless photo, or **Borders** to print a document or a photo with borders.

Note: You must select a compatible borderless paper type and size to print without borders. Check the borderless paper compatibility list for details.

3. Select **Portrait** or **Landscape** as the orientation of your document or photo.

Note: If you are printing an envelope, select **Landscape**.

4. Select any of the available advanced print options.
5. Select any of the available color management options, or turn off color management.

[Advanced Print Quality Settings - Windows](#)

[Advanced Print Options - Windows](#)

[Color Management Options - Windows](#)

Parent topic: [Printing with Windows](#)

Related references

[Borderless Paper Type Compatibility](#)

[Paper or Media Type Settings](#)

[Paper Source Options - Windows](#)

Related tasks

[Selecting Double-sided Printing Settings - Windows](#)

Advanced Print Quality Settings - Windows

You can select any of the print quality settings to fine-tune the quality of your print. Some settings may be unavailable, depending on the paper type and border setting you have chosen.

Draft

For draft printing on photo paper.

Fast Economy

For the fastest printing with draft quality.

Economy

For fast printing with reduced quality.

Normal

For everyday text and image printing.

Fine

For text and graphics with good quality and print speed.

Photo

For photos and graphics with good quality and print speed.

Photo RPM

For the best print quality, but the slowest print speed.

Parent topic: [Selecting Advanced Print Settings - Windows](#)

Advanced Print Options - Windows

You can select any of the print options to customize your print. Some options may be unavailable, depending on other settings you have chosen.

Fix Red-Eye

Reduces or removes red-eye in photos.

High Speed

Speeds up printing, but may reduce print quality.

Edge Smoothing

Smooths jagged edges in low-resolution images such as screen captures or images from the Web.

Print Preview

Displays a preview of your printout before printing.

Black/Grayscale

Prints text and graphics in black or shades of gray.

Quiet Mode

Lessens noise during printing when you select **Plain Paper/Bright White Paper** as the paper Type or Media Type setting.

Parent topic: [Selecting Advanced Print Settings - Windows](#)

Color Management Options - Windows

You can adjust the **Color Management** settings on the Advanced tab to fine-tune the colors in your printout, or turn off color management in your printer software.

Color Controls

Lets you select a **Color Mode** setting, individual settings for **Brightness**, **Contrast**, **Saturation**, and **Density**, and individual color tones. Depending on the selected color mode, you can also adjust the midtone density using the **Gamma** setting.

Fix Photo

Improves the color, contrast, and sharpness of flawed photos.

Note: Fix Photo uses a sophisticated face recognition technology to optimize photos that include faces. For this to work, both eyes and the nose must be visible in the subject's face. If your photo includes a face with an intentional color cast, such as a statue, you may want to turn off **Fix Photo** to retain the special color effects.

ICM

Lets you turn off color management in your printer software using the **Off (No Color Adjustment)** option. You can then manage color using only your application software.

Parent topic: [Selecting Advanced Print Settings - Windows](#)

Selecting Print Layout Options - Windows

You can select a variety of sizing and layout options for your document or photo on the Page Layout tab.

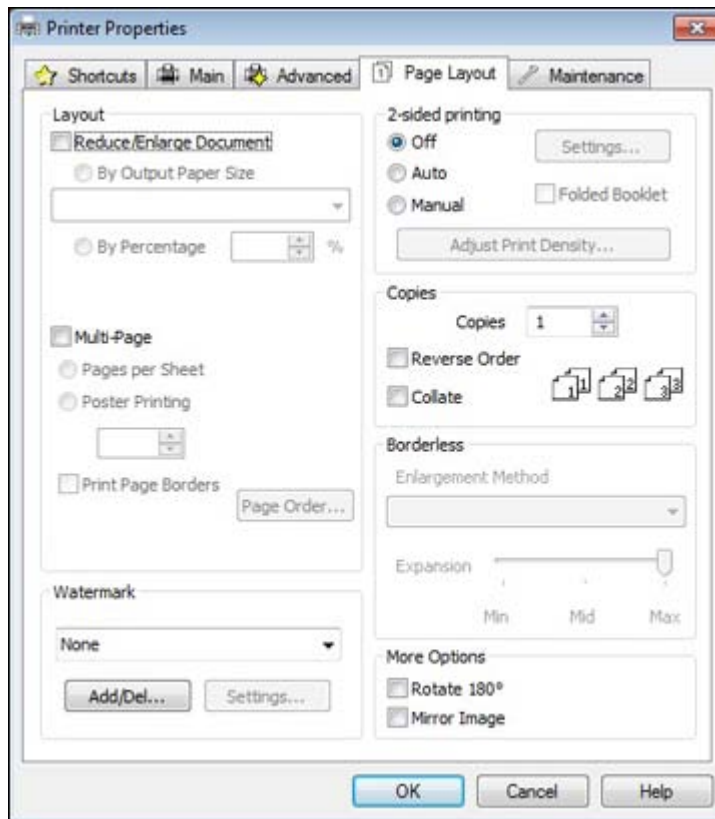

- To change the size of your printed document or photo, select the **Reduce/Enlarge Document** checkbox and select sizing options.
- To print on both sides of your paper, select the **2-sided printing** options.
- To print multiple pages on one sheet of paper, or print one image on multiple sheets of paper, select the **Multi-Page** checkbox and select the options you want.
- To print multiple copies and arrange their print order, select the **Copies** options.

- To control printing at the edges of borderless images, select a **Borderless** option:

Note: To make changes to the **Borderless** settings, you must have selected the **Borderless** option on the Advanced tab.

- To adjust the automatic settings, select **Auto Expand** as the Enlargement Method setting, then adjust the **Expansion** slider (if necessary) to control the amount of image expansion.

Note: If you select the **Min** option for the Expansion setting, you may see white borders on your printed photo.

- To print the borderless image at its actual size without scaling, select **Retain Size** as the Enlargement Method setting.
- To add a watermark to your printout, select **Watermark** settings.
- To rotate or flip the printed image, select the **Rotate 180°** or **Mirror Image** checkboxes.

Parent topic: [Printing with Windows](#)

Related tasks

[Selecting Double-sided Printing Settings - Windows](#)

Selecting a Printing Preset - Windows

For quick access to common groups of print settings, you can select a printing preset.

Note: You can create your own preset by clicking the **Save Settings** button on the Advanced tab.

1. Click the **Shortcuts** tab.

You see the available Printing Presets options:



2. Place your cursor over a Printing Presets option to view its list of settings.
3. Use any of the available options on the screen to control your printing presets.
4. To choose an option for printing, select it.
5. Click **OK**.

Parent topic: [Printing with Windows](#)

Selecting Double-sided Printing Settings - Windows

You can print on both sides of the paper by selecting one of the **2-sided printing** options on the Main or Page Layout tab. (Some options are not available on the Main tab.)

Automatic double-sided printing is only available if you have loaded plain paper in these sizes: Letter (8.5 x 11 inches [216 x 279 mm]) and A4 (8.3 x 11.7 inches [210 x 297 mm]).

Note: Some options may be unavailable, depending on other settings you have chosen.

1. Click the **Page Layout** tab.
2. Select one of the **2-sided printing** options:
 - Select the **Auto** checkbox to automatically print your double-sided print job.
 - Select the **Manual** checkbox to print your double-sided print job manually by printing one side and flipping the paper over to print the other side (recommended for paper types that do not support automatic duplexing).
3. Select the **Folded Booklet** checkbox if you want to order the pages of your double-sided print to create a single-fold booklet.
4. Click the **Settings** button.
You see this window:

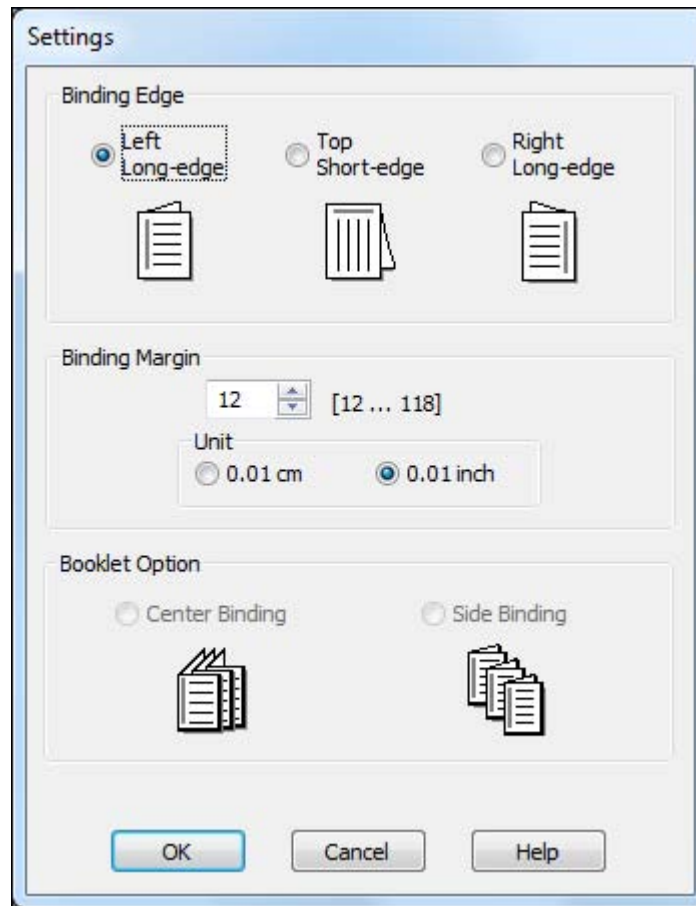

5. Select the binding options you want to use.
6. Click **OK** to return to the Page Layout tab.
7. Click the **Adjust Print Density** button.

You see this window:

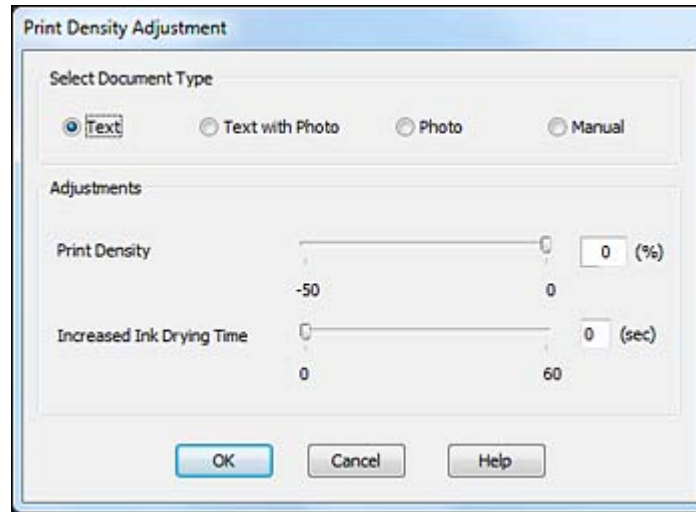

8. Select the type of document you are printing as the Document Type setting. The software automatically sets the **Adjustments** options for that document type.
9. If you selected the **Manual** document type, select the **Adjustments** options you want to use.
10. Click **OK** to return to the Page Layout tab.
11. Print a test copy of your double-sided document to test the selected settings.
12. Follow any instructions displayed on the screen during printing.

[Double-sided Printing Options - Windows](#)

[Print Density Adjustments - Windows](#)

Parent topic: [Printing with Windows](#)

Related tasks

[Selecting Basic Print Settings - Windows](#)

[Selecting Advanced Print Settings - Windows](#)

Double-sided Printing Options - Windows

You can select any of the double-sided options to set up your double-sided print job.

Binding Edge Options

Select a setting that orients double-sided print binding in the desired direction.

Binding Margin Options

Select options that define a wider margin to allow for binding.

Booklet Option

Select a binding option to use when creating a folded booklet.

Parent topic: [Selecting Double-sided Printing Settings - Windows](#)

Print Density Adjustments - Windows

You can select any of the available options on the Print Density Adjustment window to adjust the print quality of your double-sided print job.

Print Density

Sets the level of ink coverage for double-sided printing.

Increased Ink Drying Time

Sets the amount of time required for drying ink after printing on one side of the paper before printing the other side in double-sided printing to prevent ink smearing.

Parent topic: [Selecting Double-sided Printing Settings - Windows](#)

Printing Your Document or Photo - Windows

Once you have selected your print settings, you are ready to save your settings and print.

1. Click **OK** to save your settings.

You see your application's Print window, such as this one:

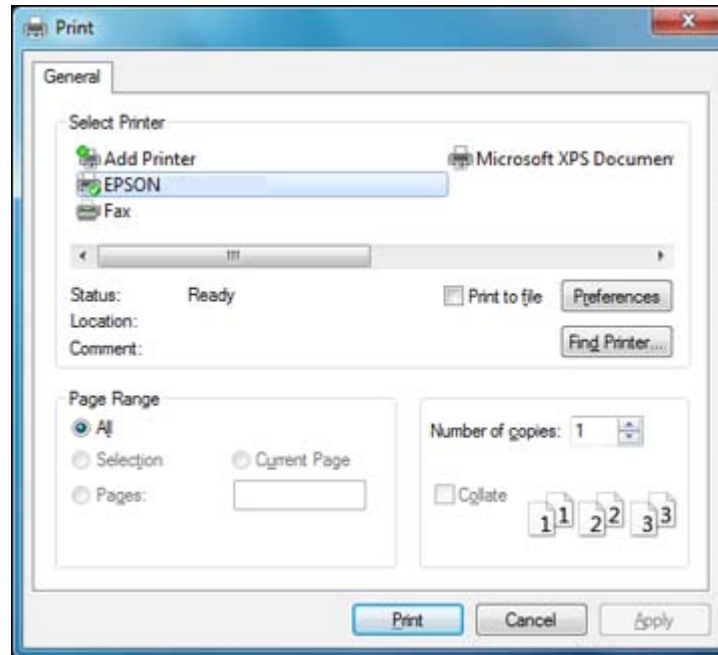

2. Click **OK** or **Print** to start printing.

[Checking Print Status - Windows](#)

Parent topic: [Printing with Windows](#)

Related tasks

[Selecting Basic Print Settings - Windows](#)

[Selecting Advanced Print Settings - Windows](#)

[Selecting Print Layout Options - Windows](#)

Checking Print Status - Windows

During printing, you see this window showing the progress of your print job. It allows you to control printing and check ink cartridge status.

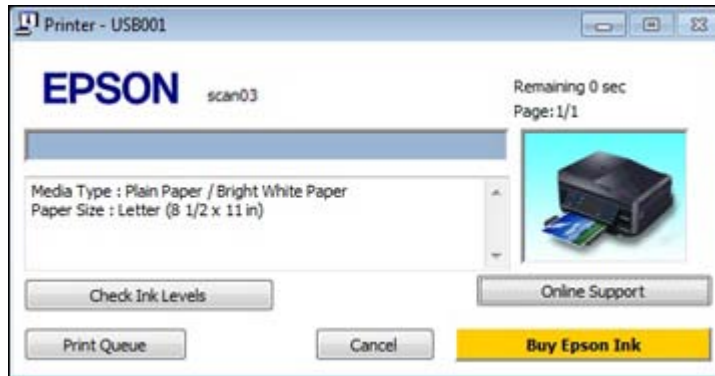

- To cancel printing, click **Cancel**.
- To see print jobs lined up for printing, click **Print Queue**.
- To check ink status, click **Check Ink Levels**.

Parent topic: [Printing Your Document or Photo - Windows](#)

Selecting Default Print Settings - Windows

When you change your print settings in a program, the changes apply only while you are printing in that program session. If you want to change the print settings you use in all your Windows programs, you can select new default print settings.

1. Access the Windows Desktop and right-click the product icon in the Windows taskbar.
2. Select **Printer Settings**.

You see the printer settings window:

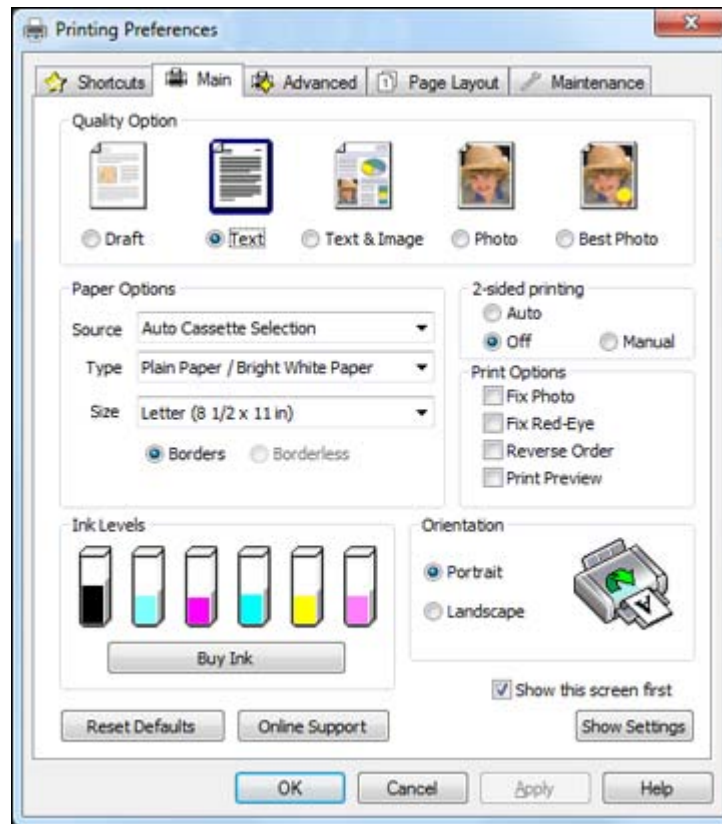

3. Select the print settings you want to use as defaults in all your Windows programs.

4. Click **OK**.

These settings are now the defaults selected for printing. You can still change them as needed for printing in any program session.

[Changing the Language of the Printer Software Screens](#)

Parent topic: [Printing with Windows](#)

Changing the Language of the Printer Software Screens

You can change the language used on the Windows printer software screens.

1. Access the Windows Desktop and right-click the product icon in the Windows taskbar.

2. Select **Printer Settings**.
You see the printer settings window.
3. Click the **Maintenance** tab.
You see the maintenance options:

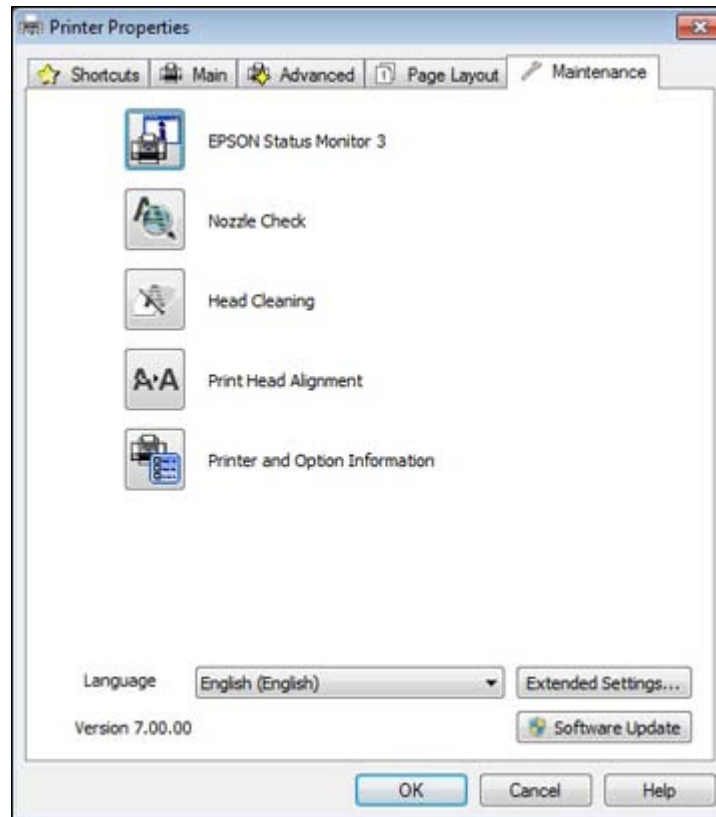

4. Select the language you want to use as the **Language** setting.
5. Click **OK** to close the printer software window.

The printer software screens appear in the language you selected the next time you access them.

Parent topic: [Selecting Default Print Settings - Windows](#)

Changing Automatic Update Options

Your printer software for Windows automatically checks for updates to the product software. You can change how often the software checks for updates or disable this feature.

1. Access the Windows Desktop and right-click the product icon in the Windows taskbar.
2. Select **Software Update Settings**.

You see this window:

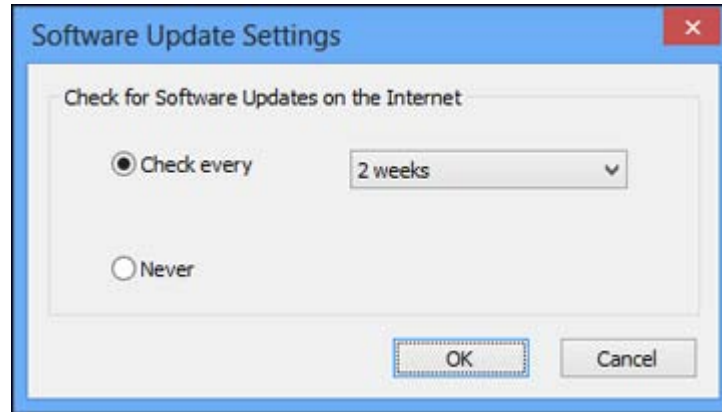

3. Do one of the following:
 - To change how often the software checks for updates, select a setting in the **Check every** menu.
 - To disable the automatic update feature, select the **Never** option.
4. Click **OK** to exit.

Note: If you choose to disable the automatic update feature, you can check for updates manually.

Parent topic: [Printing with Windows](#)

Related tasks

[Checking for Software Updates](#)

Printing with Mac OS X

You can print with your product using any Mac OS X printing program, as described in these sections.

Note: If you have an internet connection, it is a good idea to check for updates to your product software on Epson's support website.

[Selecting Basic Print Settings - Mac OS X](#)

[Selecting Page Setup Settings - Mac OS X](#)

[Selecting Print Layout Options - Mac OS X](#)

[Selecting Double-sided Printing Settings - Mac OS X](#)

[Managing Color - Mac OS X](#)

[Selecting Printing Preferences - Mac OS X](#)

[Printing Your Document or Photo - Mac OS X](#)

Parent topic: [Printing From a Computer](#)

Selecting Basic Print Settings - Mac OS X

Select the basic settings for the document or photo you want to print.

1. Open a photo or document for printing.
2. Select the print command in your application.

Note: You may need to select a print icon on your screen, the **Print** option in the File menu, or another command. See your application's help utility for details.

3. Select your product as the **Printer** setting.

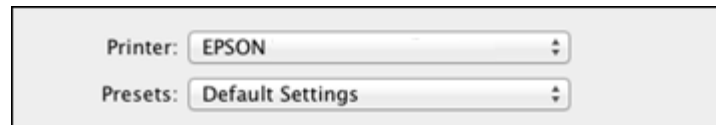

4. If necessary, click the arrow next to the Printer setting or the **Show Details** button to expand the print window.

You see the expanded printer settings window for your product:

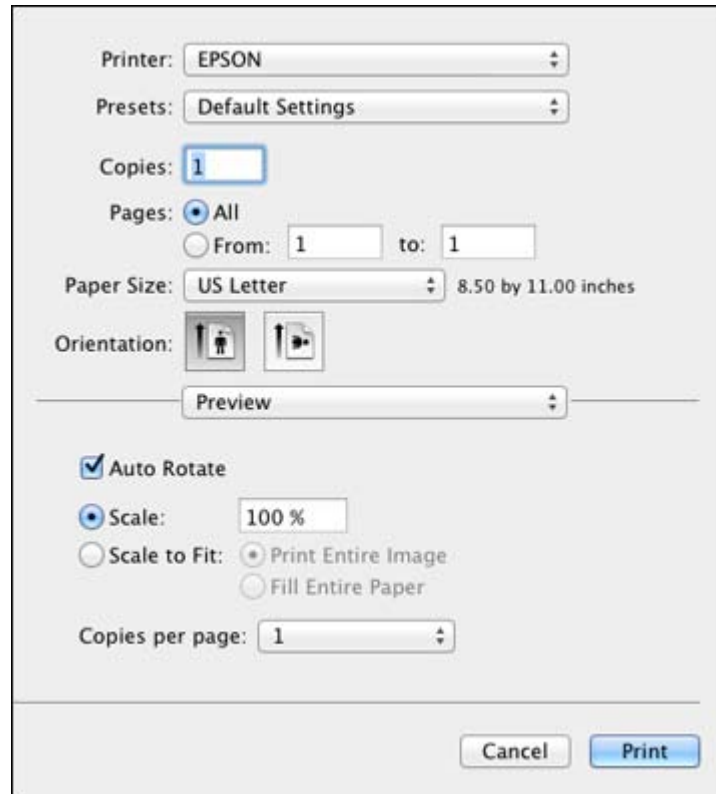

Note: The print window may look different, depending on the version of Mac OS X and the application you are using.

5. Select the **Copies** and **Pages** settings as necessary.

Note: If you do not see these settings in the print window, check for them in your application before printing.

6. Select the page setup options: **Paper Size** and **Orientation**.

Note: If you do not see these settings in the print window, check for them in your application before printing. They may be accessible by selecting **Page Setup** from the File menu.

7. Select any application-specific settings that appear on the screen, such as those shown in the image above for the Preview application.
8. Select **Print Settings** from the pop-up menu.

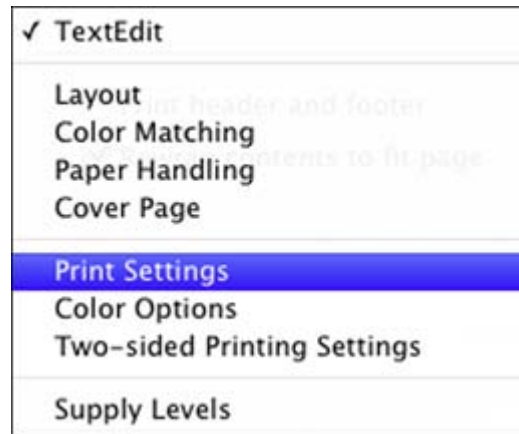

You see these settings:

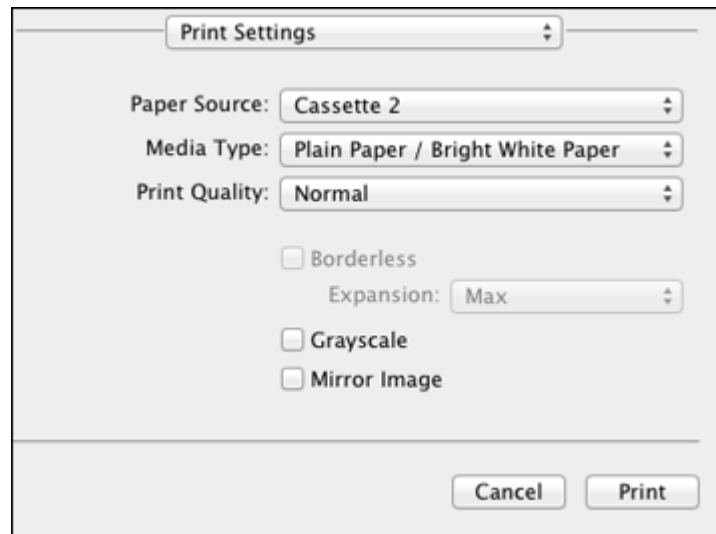

9. Select the **Paper Source** you wish to print from.
10. Select the type of paper you loaded as the **Media Type** setting.

Note: The setting may not exactly match the name of your paper. Check the paper type settings list for details.

11. Select the **Print Quality** setting you want to use.
12. Select any of the available print options.

[Paper Source Options - Mac OS X](#)

[Print Quality Settings - Mac OS X](#)

[Print Options - Mac OS X](#)

Parent topic: [Printing with Mac OS X](#)

Related references

[Paper or Media Type Settings](#)

Related tasks

[Selecting Page Setup Settings - Mac OS X](#)

[Printing Your Document or Photo - Mac OS X](#)

Paper Source Options - Mac OS X

You can select any of the available options in the Paper Source menu to print from paper loaded in that source.

Cassette 1

Selects the paper in cassette 1 as the paper source.

Cassette 2

Selects the paper in cassette 2 as the paper source.

Rear Paper Feed Slot

Selects the paper in the rear feed slot as the paper source.

Parent topic: [Selecting Basic Print Settings - Mac OS X](#)

Print Quality Settings - Mac OS X

You can select any of the print quality settings to fine-tune the quality of your print. Some settings may be unavailable, depending on the paper type and border setting you have chosen.

Draft

For draft printing on photo paper.

Fast Economy

For the fastest printing with draft quality.

Economy

For fast printing with reduced quality.

Normal

For everyday text and image printing.

Fine

For text and graphics with good quality and print speed.

Photo

For photos and graphics with good quality and print speed.

Photo RPM

For the best print quality, but the slowest print speed.

Parent topic: [Selecting Basic Print Settings - Mac OS X](#)

Print Options - Mac OS X

You can select any of the print options to customize your print. Some options may be unavailable, depending on other settings you have chosen.

Expansion

If you selected a borderless paper size setting, this option adjusts the image expansion settings to control printing at the edges of borderless prints.

Grayscale

Prints text and graphics in black or shades of gray.

Mirror Image

Lets you flip the printed image horizontally.

Note: If you select the **Min** option for the Expansion setting, you may see white borders on your printed photo.

Parent topic: [Selecting Basic Print Settings - Mac OS X](#)

Selecting Page Setup Settings - Mac OS X

Depending on your application, you may be able to select the paper size and orientation settings from the print window.

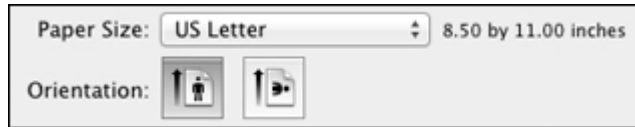

Note: If you do not see these settings in the print window, check for them in your application before printing. They may be accessible by selecting **Page Setup** from the File menu.

1. Select the size of the paper you loaded as the **Paper Size** setting. If you are printing a borderless photo, select the **Borderless** checkbox or a paper size with a **Borderless** option. You can also select a custom setting to create a custom paper size.

Note: You must select a compatible borderless paper type and size to print without borders. Check the borderless paper compatibility list for details.

2. Select the orientation of your document or photo as shown in the print window.

Note: If you are printing an envelope, select the  icon.

Note: You can reduce or enlarge the size of the printed image by selecting **Paper Handling** from the pop-up menu and selecting a scaling option.

Parent topic: [Printing with Mac OS X](#)

Related references

[Borderless Paper Type Compatibility](#)

Selecting Print Layout Options - Mac OS X

You can select a variety of layout options for your document or photo by selecting **Layout** from the pop-up menu on the print window.

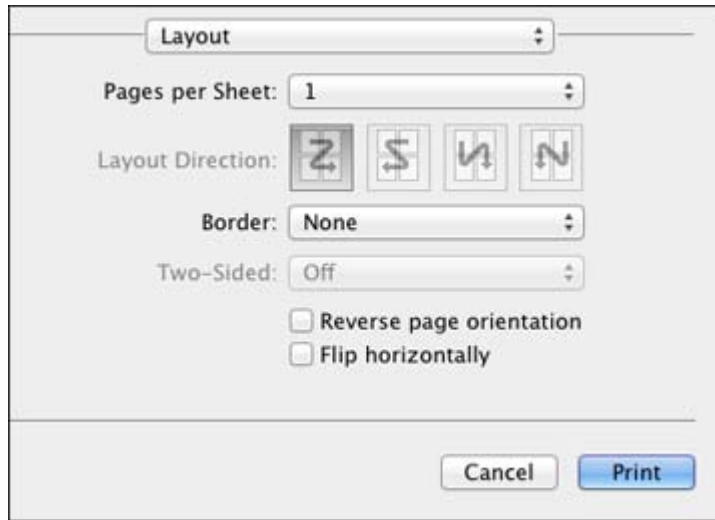

- To print multiple pages on one sheet of paper, select the number of pages in the **Pages per Sheet** pop-up menu. To arrange the print order of the pages, select a **Layout Direction** setting.
- To print borders around each page on the sheet, select a line setting from the **Border** pop-up menu.
- To invert or flip the printed image, select the **Reverse page orientation** or **Flip horizontally** settings.

Parent topic: [Printing with Mac OS X](#)

Selecting Double-sided Printing Settings - Mac OS X

You can print on both sides of the paper by selecting **Two-sided Printing Settings** from the pop-up menu on the print window.

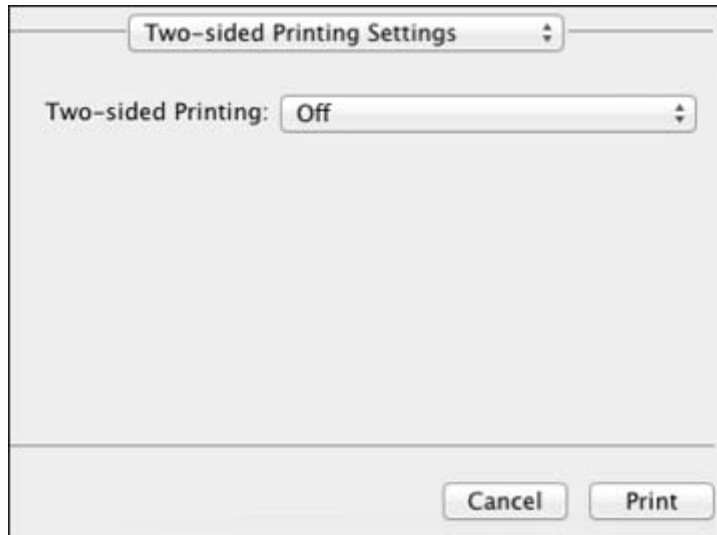

Note: Some options may be pre-selected or unavailable, depending on other settings you have chosen or if you are accessing the product over a network. This screen may be different, depending on the version of Mac OS X you are using.

1. Select one of the **Two-sided Printing** options.

2. Select the type of document you are printing as the **Document Type** setting. The software automatically sets the Adjustments options for that document type.



3. If necessary, customize the Adjustments settings as instructed on the screen.
4. Print a test copy of your double-sided document to test the selected settings.
5. Follow any instructions displayed on the screen during printing.

[Double-sided Printing Options and Adjustments - Mac OS X](#)

Parent topic: [Printing with Mac OS X](#)

Double-sided Printing Options and Adjustments - Mac OS X

You can select any of the available options in the **Two-sided Printing Settings** or **Output Settings** pop-up menu to set up your double-sided print job.

Two-sided Printing Options

Long-Edge binding

Orients double-sided printed pages to be bound on the long edge of the paper.

Short-Edge binding

Orients double-sided printed pages to be bound on the short edge of the paper.

Adjustments**Print Density**

Sets the level of ink coverage for double-sided printing.

Increased Ink Drying Time

Sets the amount of time required for drying ink after printing on one side of the paper before printing the other side in double-sided printing.

Parent topic: [Selecting Double-sided Printing Settings - Mac OS X](#)

Managing Color - Mac OS X

You can adjust the Color Matching and Color Options settings to fine-tune the colors in your printout, or turn off color management in your printer software.

1. Select **Color Matching** from the pop-up menu in the print window.



2. Select one of the available options.

3. Select **Color Options** from the pop-up menu in the print window.



Note: The available settings on the Color Options menu depend on the option you selected on the Color Matching menu.

4. Select one of the available options.

[Color Matching and Color Options - Mac OS X](#)

Parent topic: [Printing with Mac OS X](#)

Color Matching and Color Options - Mac OS X

You can select from these settings on the **Color Matching** and **Color Options** menus.

Color Matching Settings

EPSON Color Controls

Lets you manage color using controls in your printer software, or turn off color management.

ColorSync

Prints using standard color profiles for your product and paper to help match image colors. You can customize the conversion method and filter settings on the ColorSync pop-up menu in the print window.

Color Options Settings

Manual Settings

Lets you select manual color adjustments. Click the arrow next to **Advanced Settings** and select settings for **Brightness**, **Contrast**, **Saturation**, and individual color tones. You can also select a color **Mode** setting for printing photos and graphics and the **Fix Red-Eye** setting to reduce or remove red-eye in photos. Depending on the selected color mode, you can also adjust the midtone density using the **Gamma** setting.

Fix Photo

Improves the color, contrast, and sharpness of flawed photos. Click the arrow next to **Advanced Settings** and select the **Fix Red-Eye** setting to reduce or remove red-eye in photos.

Note: Fix Photo uses a sophisticated face recognition technology to optimize photos that include faces. For this to work, both eyes and the nose must be visible in the subject's face. If your photo includes a face with an intentional color cast, such as a statue, you may want to turn off **Fix Photo** to retain the special color effects.

Off (No Color Adjustment)

Turns off color management in your printer software so you can manage color using only your application software.

Parent topic: [Managing Color - Mac OS X](#)

Selecting Printing Preferences - Mac OS X

You can select printing preferences that apply to all the print jobs you send to your product.

1. In the Apple menu or the Dock, select **System Preferences**.
2. Select **Print & Fax** or **Print & Scan**, select your product, and select **Options & Supplies**.
3. Select **Driver**.

You see a screen like this:

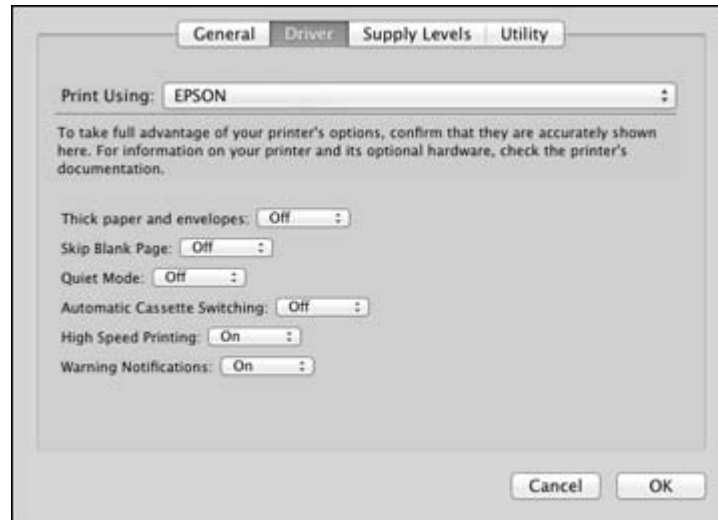

4. Select any of the available printing preferences.
5. Click **OK**.

[Printing Preferences - Mac OS X](#)

Parent topic: [Printing with Mac OS X](#)

Printing Preferences - Mac OS X

You can select from these settings on the Driver tab.

Thick paper and envelopes

Prevents ink from smearing when you print on envelopes or other thick paper.

Skip Blank Page

Ensures that your product does not print pages that contain no text or images.

Quiet Mode

Lessens noise during printing when you select **Plain Paper/Bright White Paper** as the paper Type or Media Type setting.

Automatic Cassette Switching

Automatically switches to the other cassette when one of the cassettes runs out of paper.

High Speed Printing

Speeds up printing, but may reduce print quality.

Warning Notifications

Lets you choose whether or not to receive warning notifications from the printer software when ink is low.

Parent topic: [Selecting Printing Preferences - Mac OS X](#)

Printing Your Document or Photo - Mac OS X

Once you have selected your print settings, you are ready to print.

Click **Print** at the bottom of the print window.

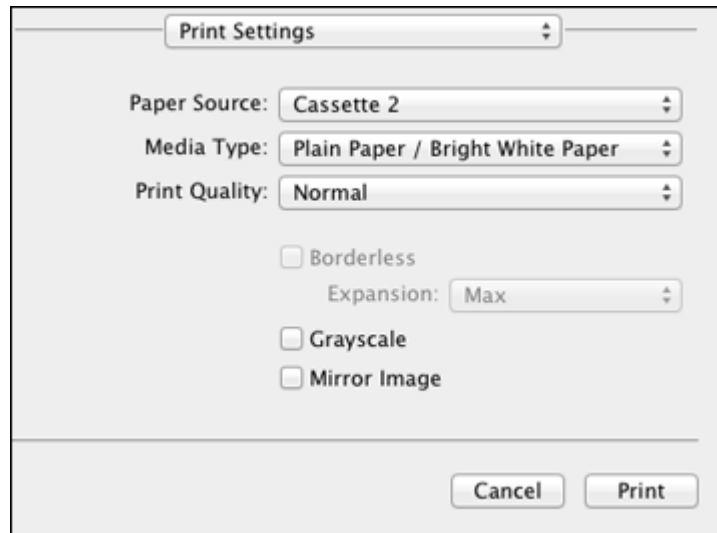

[Checking Print Status - Mac OS X](#)

Parent topic: [Printing with Mac OS X](#)

Checking Print Status - Mac OS X

During printing, you can view the progress of your print job, control printing, and check ink cartridge status.

1. Click the printer icon when it appears in the Dock.

You see the print status window:

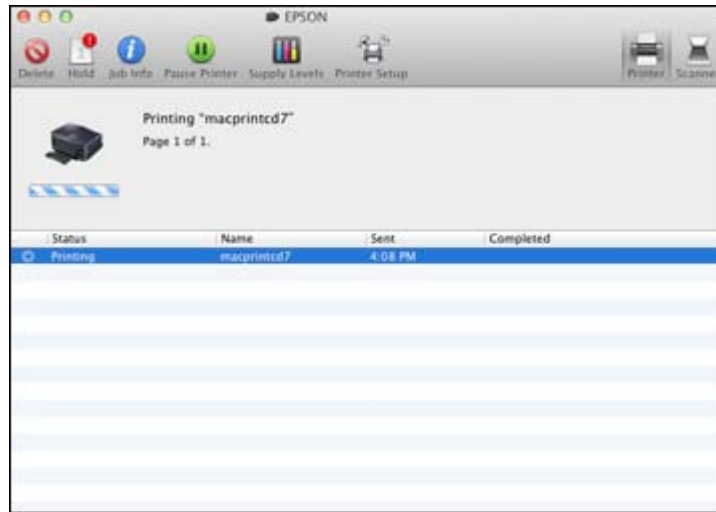



2. Select the following options as necessary:

Mac OS X 10.5/10.6/10.7:

- To cancel printing, click the print job and click the **Delete** icon.
- To pause a print job, click the print job and click the **Hold** icon. To resume a print job, click the print job marked "Hold" and click the **Resume** icon.
- To pause printing for all queued print jobs, click the **Pause Printer** icon.
- To check ink status, click the **Supply Levels** icon.

Mac OS X 10.8:

- To cancel printing, click the  button next to the print job.
- To pause a print job, click the  button next to the print job. To resume a print job, click the  button.
- To pause printing for all queued print jobs, click the large **Pause** button.
- To check ink status, click the **Settings** icon, then click the **Supply Levels** tab.

Parent topic: [Printing Your Document or Photo - Mac OS X](#)

Cancelling Printing Using a Product Button

If you need to cancel printing, select **Cancel** on the LCD display.

Parent topic: [Printing From a Computer](#)

Scanning

You can scan original documents or photos and save them as digital files.

[Starting a Scan](#)

[Selecting Epson Scan Settings](#)

[Scanning with OS X Using Image Capture](#)

[Scanning Special Projects](#)

Starting a Scan

After placing your original documents or photos on your product for scanning, start scanning using one of these methods.

[Starting a Scan Using the Product Control Panel](#)

[Starting a Scan Using the Epson Scan Icon](#)

[Starting a Scan from a Scanning Program](#)

Parent topic: [Scanning](#)

Related topics

[Placing Originals on the Product](#)

Starting a Scan Using the Product Control Panel

You can scan an image to your computer using your product's touch panel buttons.

Your product automatically selects suitable default scan settings, but you can view or change them as necessary.

1. Make sure you installed the product software and connected the product to your computer or network.
2. Press the  home button, if necessary.
3. Select **Scan**.

The scan options are displayed:



4. Scroll up or down to view additional scan options, then select the one you want.
 - **Scan to Memory Card** saves your scan file on a memory card and lets you select the file format, quality, and other settings.
 - **Scan to Cloud** sends your scanned files to a destination that you have registered with Epson Connect.
 - **Scan to PC** saves your scan file directly to your computer or as an image capture in Mac OS X 10.6/10.7/10.8.
 - **Scan to PC (PDF)** saves your scan as a PDF file to your computer or as an image capture in Mac OS X 10.6/10.7/10.8.
 - **Scan to PC (Email)** scans your original and attaches it to a message in your e-mail program. You can select the e-mail program you want to use and resize your image, if necessary, from an option screen on your computer.

Note: This works with MAPI-type email such as Microsoft Outlook, Windows Live Mail, Mac Mail, and Entourage, but not web-based email such as Gmail.
 - **Scan to PC (WSD)** lets you manage wireless scanning in Windows 7 or Windows Vista (English only).
5. To scan to your PC, you first need to select how you connected your product to your computer:
 - If your product is connected directly to your computer with a USB cable, select **USB Connection**.
 - If your product is connected to your computer over a network, select the computer name from the list.

6. Press the  start button to start scanning.

[Scan to Memory Card Options](#)

[Changing Default Scan Button Settings](#)

Parent topic: [Starting a Scan](#)

Related tasks

[Using Epson Scan to Cloud](#)

Scan to Memory Card Options

Select the **Scan to Memory Card** options you want to use.

Scan to Memory Card setting	Available options	Description
JPEG PDF	—	JPEG: for photos PDF: for documents
Color B&W	—	Select color or black-and-white scans
Contrast	Various levels	Decrease or increase image contrast
2-Sided Scanning	Off On	Automatic 2-sided scanning for documents in the ADF
Scan Area	Letter Legal A4 Auto Cropping Max Area	Selects the page size for documents or special settings for photos. Auto Cropping: for photos with dark edges Max Area: for most photos
Document	Text Photograph	Selects the type of original you are scanning

Scan to Memory Card setting	Available options	Description
Resolution	200 dpi 300 dpi 600 dpi	200 dpi: for e-mailing or posting on the web 300 dpi: for printing or OCR 600 dpi: for highest quality printing
Document Orientation	Portrait Landscape	Specifies the orientation of your originals
Binding Direction	Left Edge Top Edge	Specifies the binding edge of your double-sided originals

Parent topic: [Starting a Scan Using the Product Control Panel](#)

Changing Default Scan Button Settings

You can view or change the default scan settings your product uses when you scan to your computer using the product buttons. You do this using the Event Manager program.

1. Do one of the following to open Event Manager:
 - **Windows 8.x:** Navigate to the **Apps** screen and select **Event Manager**.
 - **Windows (other versions):** Click  or **Start > All Programs** or **Programs > EPSON Software > Event Manager**.
 - **Mac OS X:** Open the **Applications** folder, click **Epson Software**, and click **Event Manager**.
2. Open the **Scanner** (Windows) or **Select Scanner** (Mac OS X) drop-down list and select your product, if necessary.
3. Click **Make Job Settings**.
4. Open the **Edit Job Settings** drop-down list and select the scan button settings you want to view or change.
5. Change the settings as necessary.
6. Click **OK**.
7. Click **Close** to close the Event Manager window.

Parent topic: [Starting a Scan Using the Product Control Panel](#)

Starting a Scan Using the Epson Scan Icon

You can start the Epson Scan program to select scan settings, scan, and save the scanned image to a file.

- **Windows:** Double-click the **EPSON Scan** icon on your Windows Desktop.
- **OS X:** Open the **Applications** folder, open the **Epson Software** folder, and double-click the **EPSON Scan** icon.

Note: With OS X 10.6, 10.7, 10.8, or 10.9, in addition to scanning with Image Capture, you can download and install Epson Scan scanning software. Epson Scan provides additional image adjustment and photo correction features for enhancing scanned images, and provides an interface for TWAIN-compliant OCR scanning software, such as ABBYY FineReader. To download Epson Scan, visit Epson's driver download site ([U.S. downloads](#) or [Canadian downloads](#)).

You see an Epson Scan window like this:

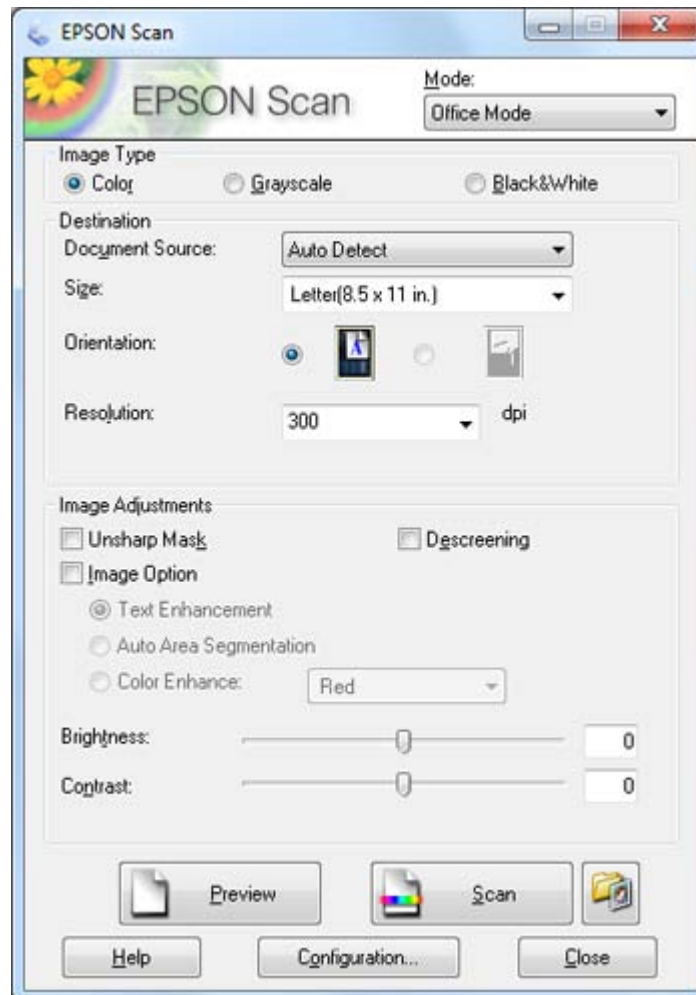

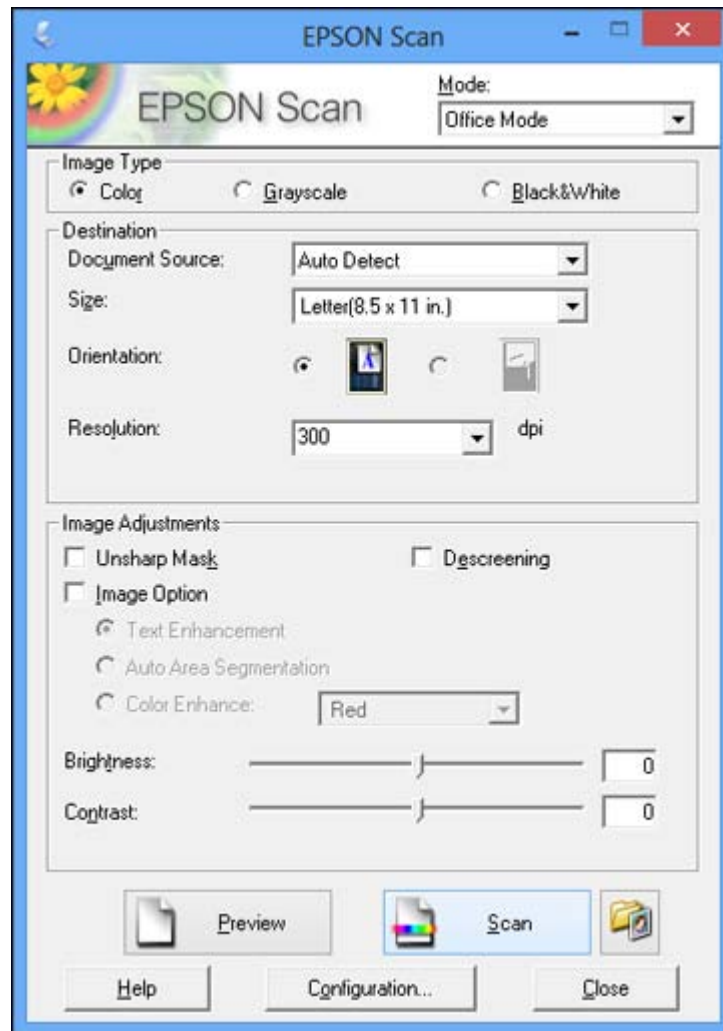

Parent topic: [Starting a Scan](#)

Related tasks

[Scanning with OS X Using Image Capture](#)

Related topics

[Selecting Epson Scan Settings](#)

Starting a Scan from a Scanning Program

You can start Epson Scan from a scanning program to select scan settings, scan, and open the scanned image in the program.

Note: With OS X 10.6, 10.7, 10.8, or 10.9, in addition to scanning with Image Capture, you can download and install Epson Scan scanning software. Epson Scan provides additional image adjustment and photo correction features for enhancing scanned images, and provides an interface for TWAIN-compliant OCR scanning software, such as ABBYY FineReader. To download Epson Scan, visit Epson's driver download site ([U.S. downloads](#) or [Canadian downloads](#)).

1. Open your scanning program and select its scanning option. (See your scanning program help for instructions.)
2. Select your product.

Note: In certain programs, you may need to select your product as the "source" first. If you see a **Select Source** option, choose it and select your product. With Windows, do not select a **WIA** option for your product; it will not work correctly.

You see an Epson Scan window like this:

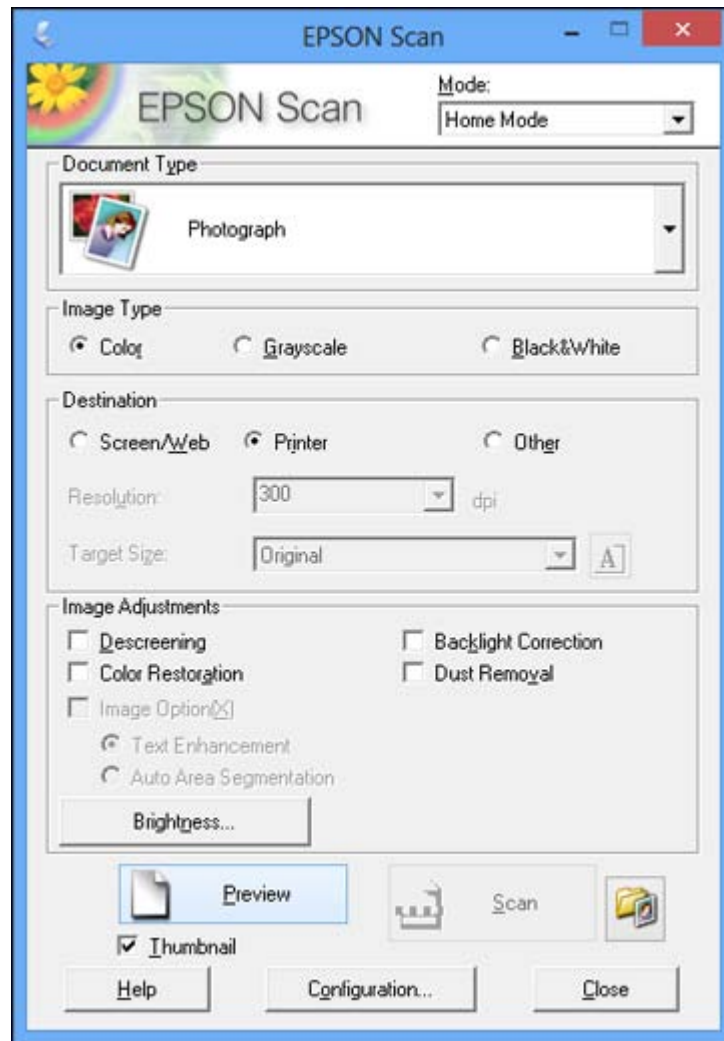

Note: Epson Scan may start in a different mode when you first access it.

Parent topic: [Starting a Scan](#)

Selecting Epson Scan Settings

After starting Epson Scan, you can select settings in various modes to customize your scan.

[Scan Modes](#)

[Selecting the Scan Mode](#)

[Scanning in Office Mode](#)

[Scanning in Home Mode](#)

[Scanning in Professional Mode](#)

[Image Preview Guidelines](#)

[Scan Resolution Guidelines](#)

[Selecting Scan File Settings](#)

Parent topic: [Scanning](#)

Scan Modes

Epson Scan provides a choice of scan modes with different levels of control over your settings.

Office Mode

You can quickly scan text documents and adjust them on a preview screen. You can also select various image adjustment options and preview your scanned image.

Home Mode

You can select setting groups based on the type of content you are scanning. You can also select various image adjustment options, and preview and size your scanned image.

Professional Mode

You can manually customize all available settings, and preview and size your scanned image.

Note: You must place your original on the scanner glass when using **Home Mode**.

Parent topic: [Selecting Epson Scan Settings](#)

Related tasks

[Selecting the Scan Mode](#)

Selecting the Scan Mode

Select the Epson Scan mode you want to use from the Mode box in the upper right corner of the Epson Scan window:

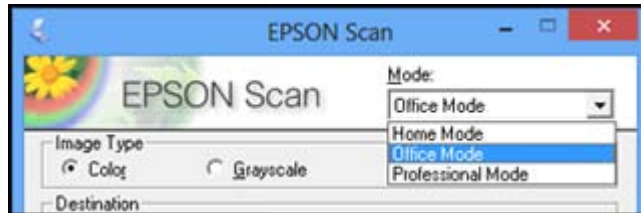

Parent topic: [Selecting Epson Scan Settings](#)

Related tasks

[Scanning in Office Mode](#)

[Scanning in Home Mode](#)

[Scanning in Professional Mode](#)

Scanning in Office Mode

When you scan in Office Mode, Epson Scan automatically saves your scanned file in JPEG format in your operating system's Pictures or My Pictures folder, or opens it in your scanning program. You can select settings, preview, and change the scanned file settings as necessary.

1. Start Epson Scan and select **Office Mode** as the Mode setting.

You see this window:

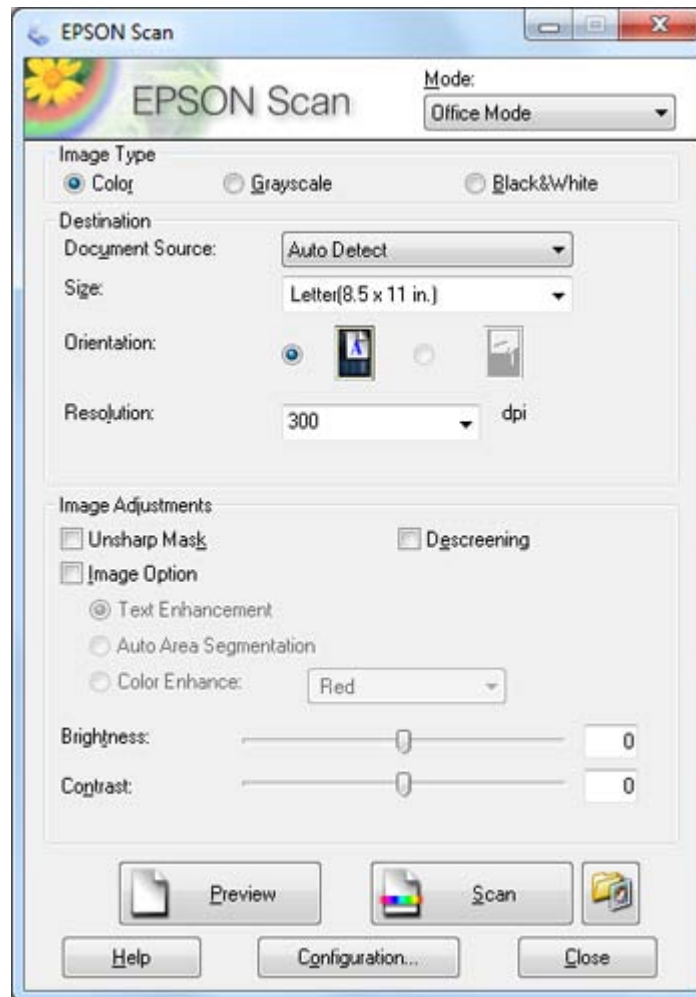

2. Select the **Image Type** setting that matches your original.
3. Select the **Document Source** setting indicating where you placed your original. To scan a 2-sided document in the ADF, select **ADF-Double-sided**.

Note: If you are using the ADF, remove any documents from the scanner glass.

4. Select the **Size** and **Orientation** settings that match your original.

5. Select the **Resolution** setting you want to use for your scan.
6. Click the **Preview** button.

Epson Scan previews your original and displays the result in a separate Preview window.

7. If you are using the ADF, reinsert your original into the ADF.
8. If desired, select the area in your preview image that you want to scan (scan area).

Note: You cannot select a scan area if you chose **ADF-Double-sided** as the **Document Source** setting.

9. Select any of the image adjustment settings you want to use. Before making adjustments, click the image or scan area in the Preview window.
10. Click **Scan**.

You see the File Save Settings window.

11. Change any of the necessary file save settings and click **OK**.

Epson Scan scans your original, and saves the file in the selected folder or opens it in your scanning program. If the file was saved directly to your computer, you see the file in the Windows Explorer or OS X Finder, where you can view and print the image, if desired.

[Available Document Source Settings - Office Mode](#)

[Selecting a Scan Area - Office Mode](#)

[Available Image Adjustments - Office Mode](#)

Parent topic: [Selecting Epson Scan Settings](#)

Related concepts

[Image Preview Guidelines](#)

[Scan Resolution Guidelines](#)

Related tasks

[Selecting Scan File Settings](#)

Available Document Source Settings - Office Mode

You can select these Document Source options in Epson Scan Office Mode.

Auto Detect

Automatically detects where the originals are placed on your product for scanning.

ADF - Single-sided

Selects the Automatic Document Feeder as the location where the originals are placed on your product for single-sided scanning.

ADF - Double-sided

Selects the Automatic Document Feeder as the location where the originals are placed on your product for double-sided scanning.

Document Table

Selects the scanner glass as the location where the originals are placed on your product for scanning.

Parent topic: [Scanning in Office Mode](#)

Selecting a Scan Area - Office Mode

You can select a specific area in your preview image to include in your scanned image. You can select the entire image area or a portion of it. You can even select multiple scan areas to create multiple scanned images of different areas.

You can also use the scan area to select specific Image Adjustments settings for a scanned image. Just be sure to click inside the scan area before selecting the settings.

1. In the Preview window, click the  Auto Locate icon to create a marquee (dotted line) on the preview image.

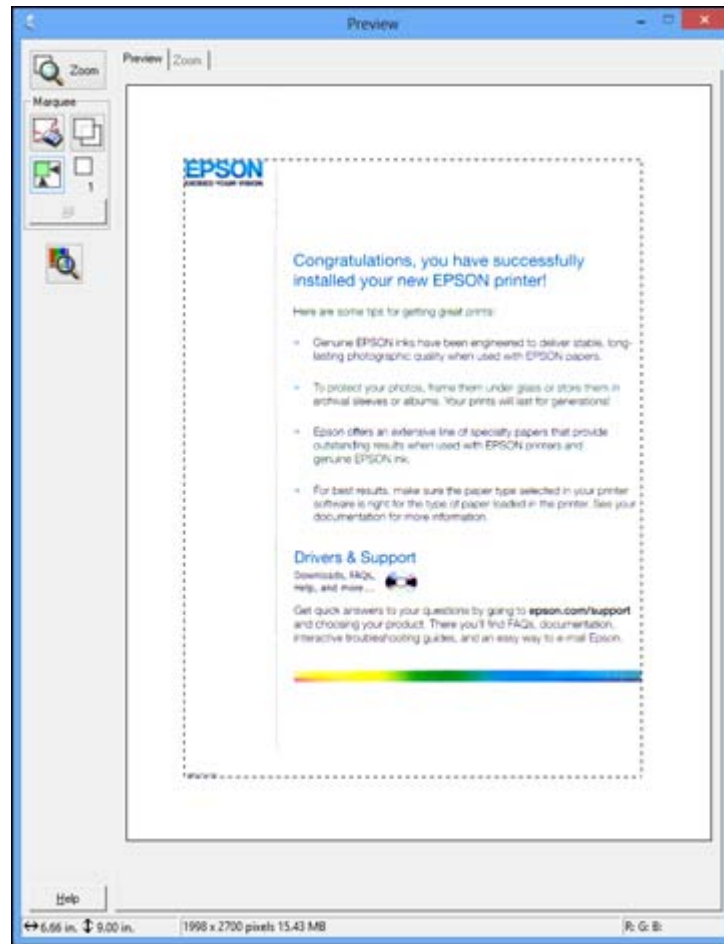

2. Do the following, as necessary, to work with the selected scan area:
 - If the marquee is correct, continue with the next step.
 - To move the marquee, click inside the scan area and drag the marquee where you want it.

- To resize the scan area, place your cursor over the edge or corner of the marquee, then click and drag the edges where you want them. (Hold down the **Shift** key as you resize the marquee to retain the same width/height proportions.)
- To create additional marquees (up to 50, if available), click the  Copy Marquee icon to copy the existing marquee and paste it on the preview image.

Note: If you draw multiple marquees, make sure you select the **All** button in the Preview window before you scan. Otherwise, only the area inside the currently selected marquee will be scanned.

- To delete a marquee, click the marquee, then click the  Delete Marquee icon.

3. Click inside each scan area and make any necessary settings in the Epson Scan window.

Parent topic: [Scanning in Office Mode](#)

Available Image Adjustments - Office Mode

You can select these Image Adjustments options in Epson Scan Office Mode. Not all adjustment settings may be available, depending on other settings you have chosen.

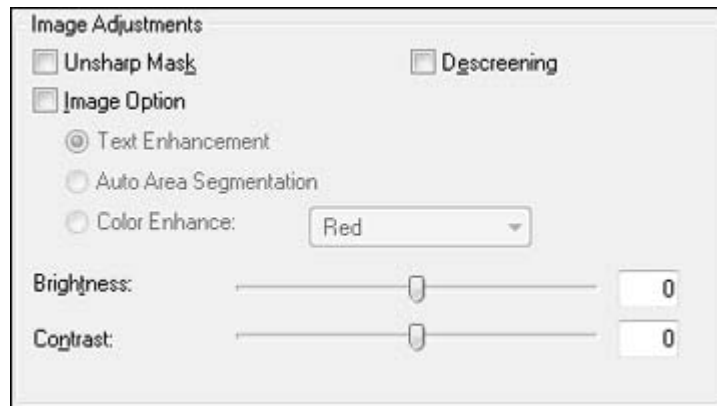

Note: Select the **Image Option** checkbox if you need to set any of the grayed-out image adjustments beneath the checkbox.

Unsharp Mask

Makes the edges of certain image areas clearer. Turn off this option to leave softer edges.

Descreening

Removes the ripple pattern that might appear in subtly shaded image areas, such as skin tones. This option improves results when scanning magazines or newspapers. (The results of descreening do not appear in the preview image, only in your scanned image.)

Text Enhancement

Sharpens the appearance of letters in text documents.

Auto Area Segmentation

Makes grayscale images clearer and text recognition more accurate by separating the text from the graphics.

Color Enhance

Enhances the red, green, or blue shades in the scanned image.

Brightness

Adjusts the overall lightness and darkness of the scanned image.

Contrast

Adjusts the difference between the light and dark areas of the overall scanned image.

Threshold

Adjusts the level at which black areas in text and line art are delineated, improving text recognition in OCR (Optical Character Recognition) programs.

Parent topic: [Scanning in Office Mode](#)

Scanning in Home Mode

When you scan in Home Mode, Epson Scan automatically saves your scanned file in JPEG format in your operating system's Pictures or My Pictures folder, or opens it in your scanning program. You can select settings, preview, and change the scanned file settings as necessary.

Note: You must place your original on the scanner glass when using **Home Mode**.

1. Start Epson Scan and select **Home Mode** as the Mode setting.

You see this window:

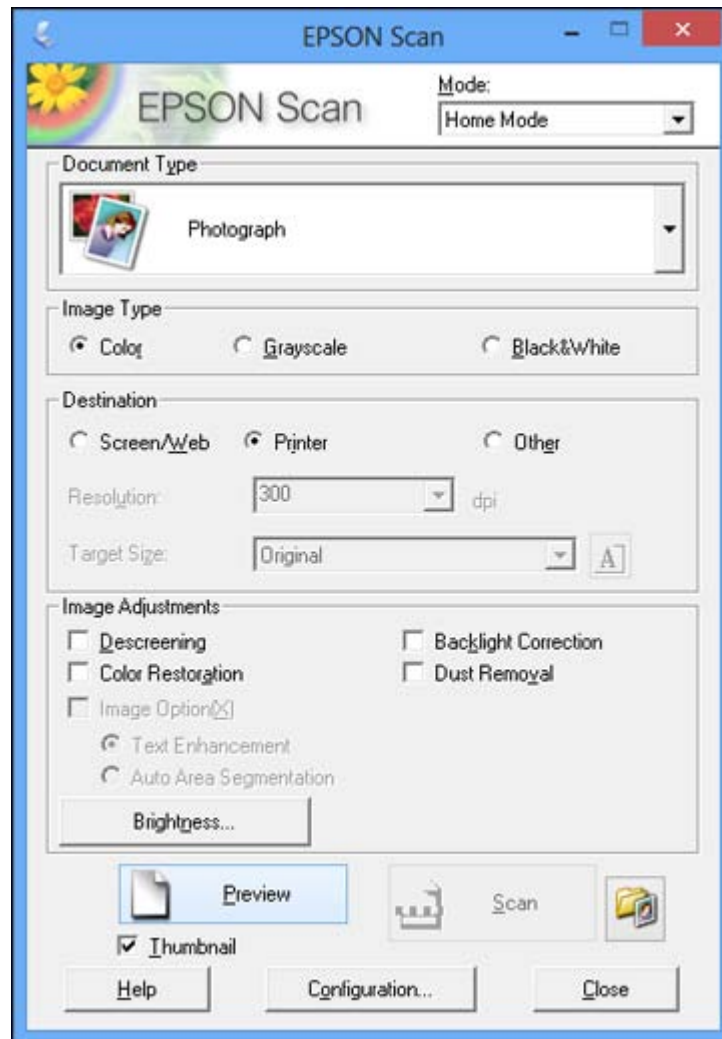

2. Select the **Document Type** setting that matches your original, such as **Photograph** or **Text/Line Art**.
3. Select the **Image Type** setting that matches your original.

4. Select the way you plan to use your scanned image as the **Destination** setting. (The Resolution setting is selected automatically based on the Destination setting you choose.)
 - **Screen/Web**: Select this option for images you will email, view on a computer screen, or post on the web.
 - **Printer**: Select this option for images you will print or documents you will convert to editable text using OCR (Optical Character Recognition) software.
 - **Other**: Select this option if you want to select a custom resolution for your image.
5. If you selected **Other** in the last step, select the **Resolution** setting you want to use for your scan.
6. Click the **Preview** button.

Epson Scan previews your original and displays the result in a separate Preview window.
7. If desired, select the area in your preview image that you want to scan (scan area).
8. Select any of the image adjustment settings you want to use. Before making adjustments, click the image or scan area in the Preview window.
9. If you want to reduce or enlarge your image as you scan, select the **Target Size** setting you want to use.
10. Click **Scan**.

You see the File Save Settings window.
11. Change any of the necessary file save settings and click **OK**.

Epson Scan scans your original, and saves the file in the selected folder or opens it in your scanning program. If the file was saved directly to your computer, you see the file in the Windows Explorer or OS X Finder, where you can view and print the image, if desired.

[Selecting a Scan Area - Home Mode](#)

[Available Image Adjustments - Home Mode](#)

[Selecting a Scan Size - Home Mode](#)

Parent topic: [Selecting Epson Scan Settings](#)

Related concepts

[Image Preview Guidelines](#)

[Scan Resolution Guidelines](#)

Related tasks

[Selecting Scan File Settings](#)

Selecting a Scan Area - Home Mode

You can select a specific area in your preview image to include in your scanned image. You can select the entire image area or a portion of it. You can even select multiple scan areas to create multiple scanned images of different areas (Normal Preview mode only).

You can also use the scan area to select specific Image Adjustments settings for a scanned image. Just be sure to click inside the scan area before selecting the settings.

1. Do one of the following to select your scan area in the Preview image:
 - **Thumbnail preview:** Your scan area is selected automatically, but you can change it. Place your cursor in one corner of the desired scan area, then click and drag the cursor to the opposite corner to create a marquee (dotted line) on the preview image.

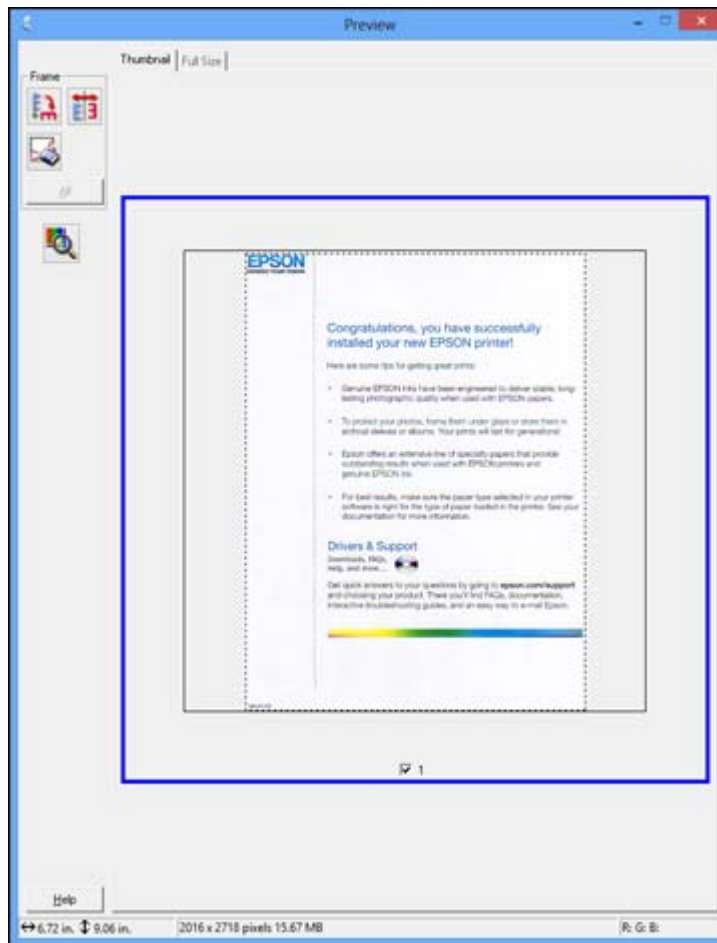

- **Normal preview:** Click the  Auto Locate icon to create a marquee (dotted line) on the preview image.

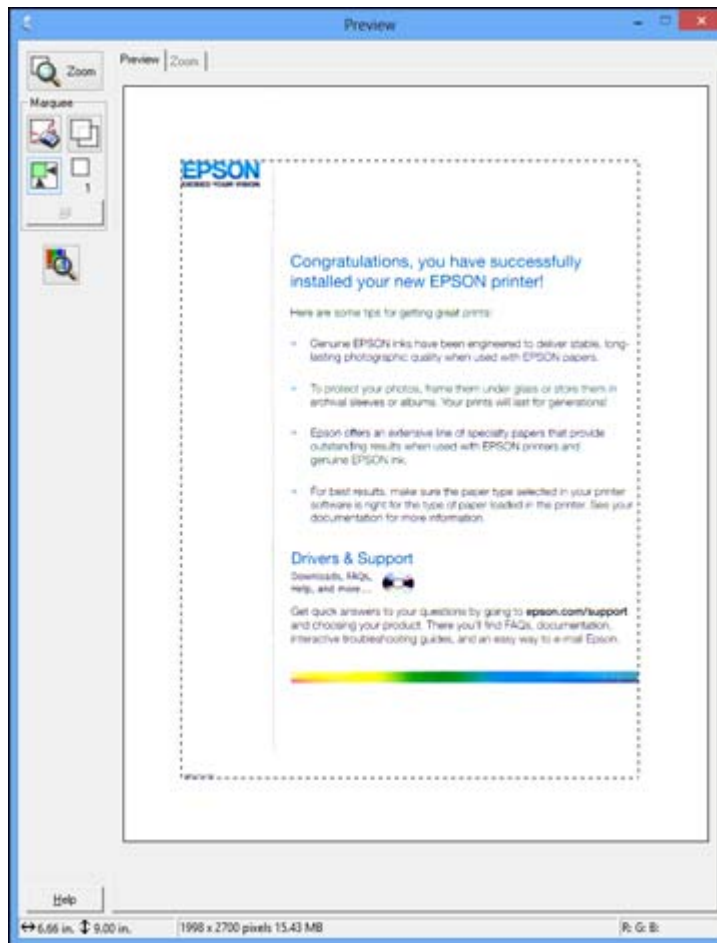

2. Do the following, as necessary, to work with the selected scan area:
 - If the marquee is correct, continue with the next step.
 - To move the marquee, click inside the scan area and drag the marquee where you want it.
 - To resize the scan area, place your cursor over the edge or corner of the marquee, then click and drag the edges where you want them. (Hold down the **Shift** key as you resize the marquee to retain the same width/height proportions.)

- **Normal preview:** To create additional marquees (up to 50), click the  Copy Marquee icon to copy the existing marquee and paste it on the preview image.

Note: If you draw multiple marquees, make sure you select the **All** button in the Preview window before you scan. Otherwise, only the area inside the currently selected marquee will be scanned.

- To delete a marquee, click the marquee, then click the  Delete Marquee icon.
3. Click inside the scan area and make any necessary settings in the Epson Scan window.

Parent topic: [Scanning in Home Mode](#)

Available Image Adjustments - Home Mode

You can select these Image Adjustments options in Epson Scan Home Mode.

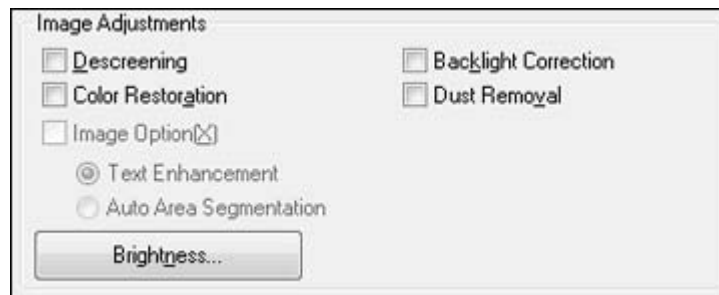

Note: Select the **Image Option** checkbox if you need to set any of the grayed-out image adjustments. Not all adjustment settings may be available, depending on the Document Type and Image Type setting. Click the **Brightness** button to access additional settings.

Descreening

Removes the ripple pattern that might appear in subtly shaded image areas, such as skin tones. This option improves results when scanning magazines or newspapers. (The results of descreening do not appear in the preview image, only in your scanned image.)

Color Restoration

Restores the colors in faded photos automatically.

Backlight Correction

Removes shadows from photos that have too much background light.

Dust Removal

Removes dust marks from your originals automatically.

Text Enhancement

Sharpens the appearance of letters in text documents.

Auto Area Segmentation

Makes grayscale images clearer and text recognition more accurate by separating the text from the graphics.

Brightness

Adjusts the overall lightness and darkness of the scanned image.

Contrast

Adjusts the difference between the light and dark areas of the overall scanned image.

Threshold

Adjusts the level at which black areas in text and line art are delineated, improving text recognition in OCR (Optical Character Recognition) programs.

Parent topic: [Scanning in Home Mode](#)

Selecting a Scan Size - Home Mode

You can reduce or enlarge the size of your image as you scan. You can also select a specific scan size, such as a common photo size like 4 × 6 inches (102 × 152 mm). This places a scan area of that size on the preview image so you can use it to help crop the image in the correct proportions.

1. Click the **Preview** button to preview your image.
2. In the Epson Scan window, select the size you want your scanned image to be from the **Target Size** list.



Note: If you need to rotate the orientation of the target size for your image, click the  Orientation icon.

A marquee (dotted line) appears on your preview image proportioned for the size you selected.

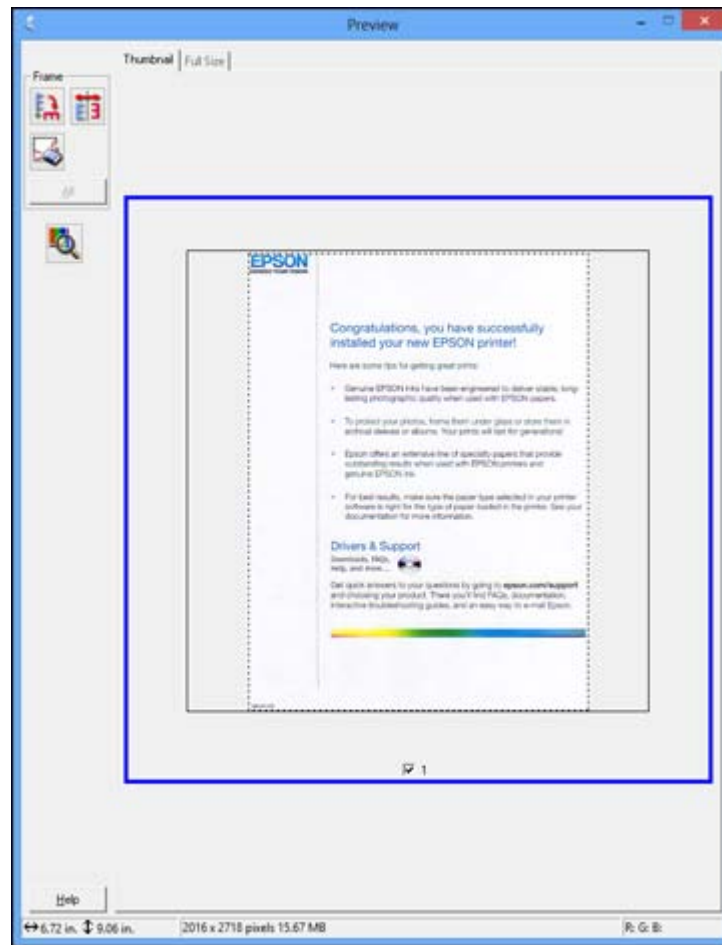

3. Do the following, as necessary, to work with the selected scan area:
 - To move the marquee, click inside the scan area and drag the marquee where you want it.
 - To resize the scan area, place your cursor over the edge or corner of the marquee, then click and drag the edge where you want it.

Note: Manually adjusting the marquee will not change the target size of the scanned file. The marquee only indicates the area of the image that will be scanned.

4. To create a scanned image size that is not available in the Target Size list, click the **Customize** option.

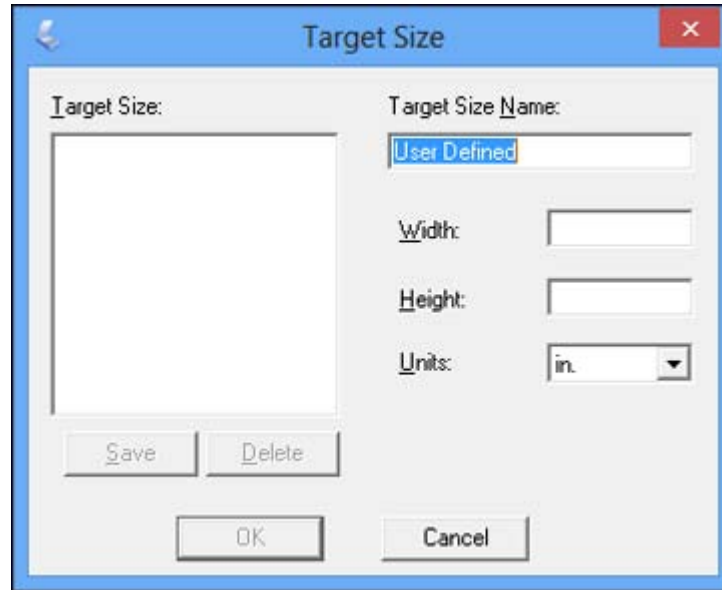

5. Name the custom size, enter the size, click **Save**, and click **OK**. Then create a scan area on the preview image.

The marquee is automatically proportioned for your custom scan size.

Parent topic: [Scanning in Home Mode](#)

Scanning in Professional Mode

When you scan in Professional Mode, Epson Scan automatically saves your scanned file in JPEG format in your operating system's Pictures or My Pictures folder, or opens it in your scanning program. You can select settings, preview, and change the scanned file settings as necessary.

1. Start Epson Scan and select **Professional Mode** as the Mode setting.

You see this window:

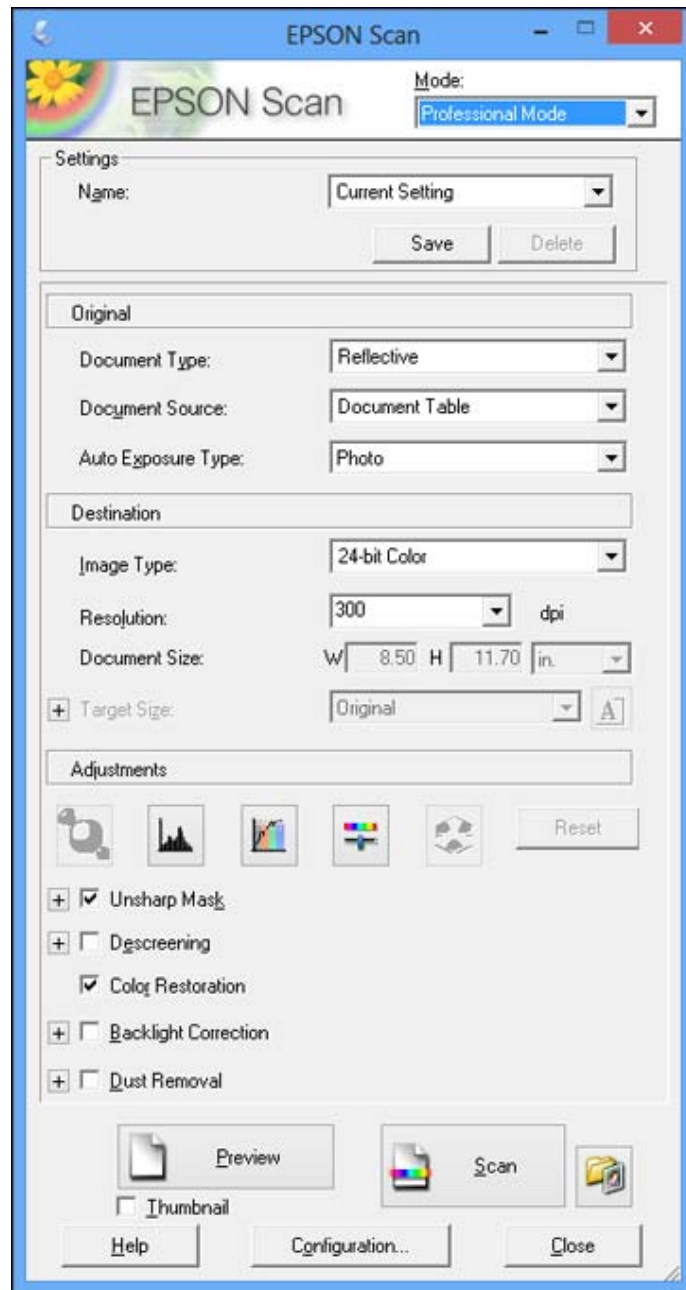

2. Select the **Document Type** setting that matches your original, such as **Reflective** for documents or photos.
3. Select the **Document Source** setting indicating where you placed your original. To scan a 2-sided document in the ADF, select **ADF - Double-sided**.

Note: If you are using the ADF, remove any documents from the scanner glass.

4. Select the specific type of original you are scanning as the **Auto Exposure Type** setting: **Document** or **Photo**.
5. Select the details of your original and how you want it scanned as the **Image Type** setting.
6. Select the **Resolution** setting you want to use for your scan.
7. Click the **Preview** button.

Epson Scan previews your original and displays the result in a separate Preview window.

8. If you are using the ADF, reinsert your original into the ADF.
9. If desired, select the area in your preview image that you want to scan (scan area).

Note: You cannot select a scan area if you chose **ADF-Double-sided** as the **Document Source** setting.

10. Select any of the image adjustment settings you want to use. Before making adjustments, click the image or scan area in the Preview window.
11. If you want to reduce or enlarge your image as you scan, select the **Target Size** setting you want to use.

Note: You cannot select a target size if you chose **ADF-Double-sided** as the **Document Source** setting.

12. Click **Scan**.

You see the File Save Settings window.

13. Change any of the necessary file save settings and click **OK**.

Epson Scan scans your original, and saves the file in the selected folder or opens it in your scanning program. If the file was saved directly to your computer, you see the file in the Windows Explorer or OS X Finder, where you can view and print the image, if desired.

[Available Document Source Settings - Professional Mode](#)

[Available Image Types - Professional Mode](#)
[Selecting a Scan Area - Professional Mode](#)
[Available Image Adjustments - Professional Mode](#)
[Selecting a Scan Size - Professional Mode](#)

Parent topic: [Selecting Epson Scan Settings](#)

Related concepts

[Image Preview Guidelines](#)
[Scan Resolution Guidelines](#)

Related tasks

[Selecting Scan File Settings](#)

Available Document Source Settings - Professional Mode

You can select these Document Source options in Epson Scan Professional Mode.

Document Table

Selects the scanner glass as the location where the originals are placed on your product for scanning.

ADF - Single-sided

Selects the Automatic Document Feeder as the location where the originals are placed on your product for single-sided scanning.

ADF - Double-sided

Selects the Automatic Document Feeder as the location where the originals are placed on your product for double-sided scanning.

Parent topic: [Scanning in Professional Mode](#)

Available Image Types - Professional Mode

You can select these Image Type options in Epson Scan Professional Mode.

24-bit Color

Select this setting for color photos.

Color Smoothing

Select this setting for color graphic images, such as charts or graphs.

8-bit Grayscale

Select this setting for black-and-white photos.

Black & White

Select this setting for black text documents or line art.

Parent topic: [Scanning in Professional Mode](#)

Selecting a Scan Area - Professional Mode

You can select a specific area in your preview image to include in your scanned image. You can select the entire image area or a portion of it. You can even select multiple scan areas to create multiple scanned images of different areas (Normal Preview mode only).

You can also use the scan area to select specific Image Adjustments settings for a scanned image. Just be sure to click inside the scan area before selecting the settings.

Note: In Professional Mode, the default Preview mode is Normal mode. To use Thumbnail Preview mode instead, select the **Thumbnail** checkbox beneath the Preview button (if available), then click the **Preview** button to preview your image again.

1. Do one of the following to select your scan area in the Preview image:

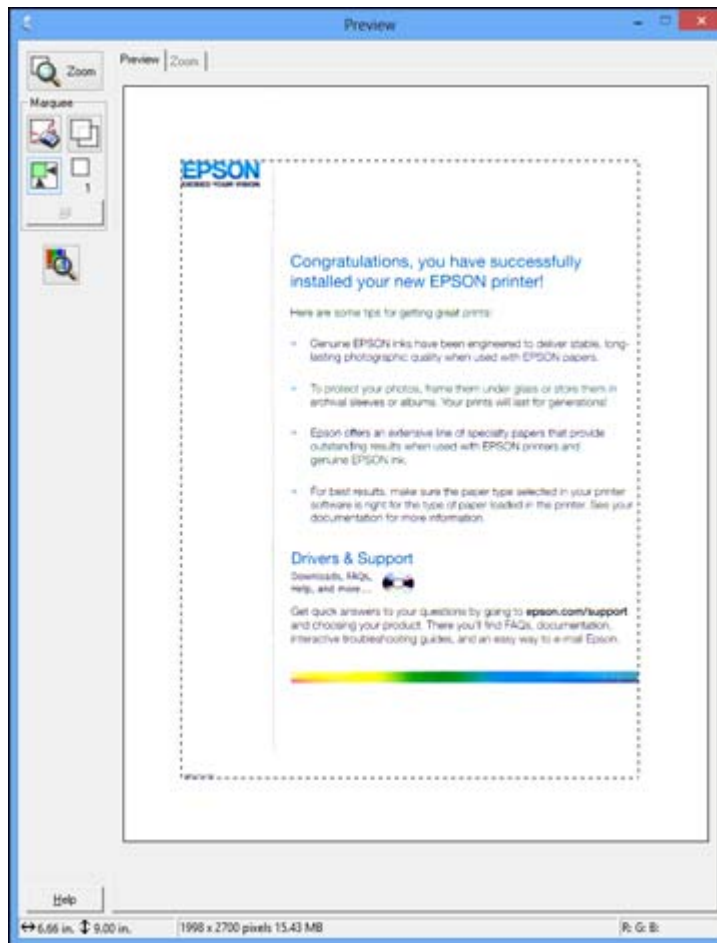

- **Normal preview:** Click the  Auto Locate icon to create a marquee (dotted line) on the preview image.

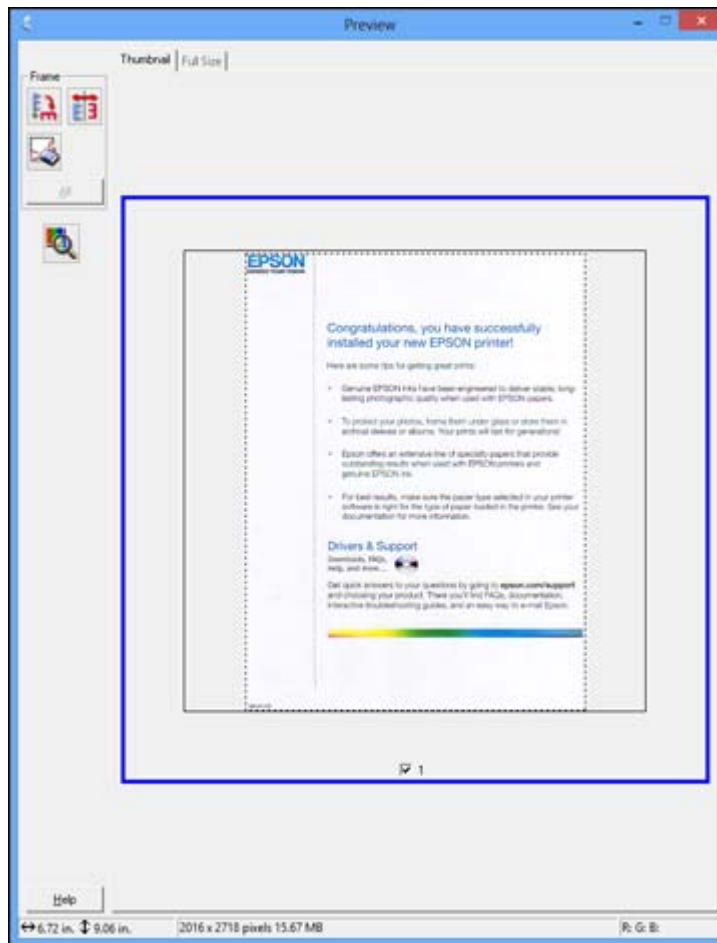

- **Thumbnail preview:** Your scan area is selected automatically, but you can change it. Place your cursor in one corner of the desired scan area, then click and drag the cursor to the opposite corner to create a marquee (dotted line) on the preview image.



2. Do the following, as necessary, to work with the selected scan area:
 - If the marquee is correct, continue with the next step.
 - To move the marquee, click inside the scan area and drag the marquee where you want it.
 - To resize the scan area, place your cursor over the edge or corner of the marquee, then click and drag the edges where you want them. (Hold down the **Shift** key as you resize the marquee to retain the same width/height proportions.)

- **Normal preview:** To create additional marquees (up to 50, if available), click the  Copy Marquee icon to copy the existing marquee and paste it on the preview image.
- To delete a marquee, click the marquee, then click the  Delete Marquee icon.

Note: If you draw multiple marquees, make sure you select the **All** button in the Preview window before you scan. Otherwise, only the area inside the currently selected marquee will be scanned.

3. Click inside the scan area and make any necessary settings in the Epson Scan window.

Parent topic: [Scanning in Professional Mode](#)

Available Image Adjustments - Professional Mode

You can select these Adjustments options in Epson Scan Professional Mode. Not all adjustment settings may be available, depending on other settings you have chosen.

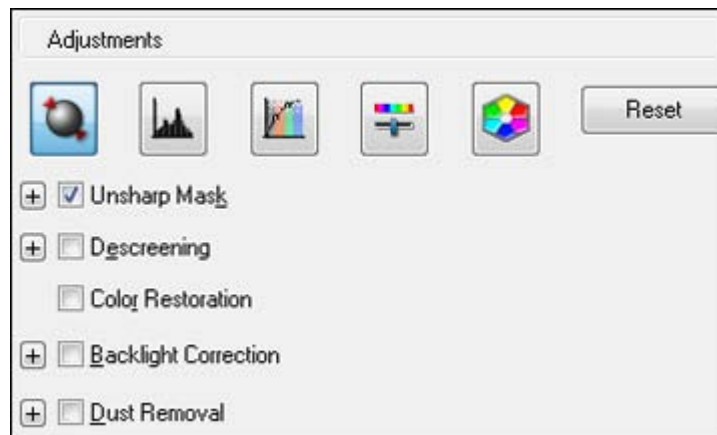

Click the  image adjustment icon to access additional settings.

Click the + (Windows) or ► (OS X) icon next to a setting to change the level of adjustment.

Unsharp Mask

Makes the edges of certain image areas clearer. Turn off this option to leave softer edges.

Descreening

Removes the ripple pattern that might appear in subtly shaded image areas, such as skin tones. This option improves results when scanning magazines or newspapers. (The results of descreening do not appear in the preview image, only in your scanned image.)

Color Restoration

Restores the colors in faded photos automatically.

Backlight Correction

Removes shadows from photos that have too much background light.

Dust Removal

Removes dust marks from your originals automatically.

Auto Exposure

Automatically adjusts the image exposure settings when you click the  Auto Exposure icon. To automatically adjust image exposure settings continuously, click the **Configuration** button, click the **Color** tab, and select **Continuous auto exposure**. You can adjust the level of auto exposure using a slider.

Histogram Adjustment

Provides a graphical interface for adjusting highlight, shadow, and gamma levels individually. (For advanced users only.) Click the  histogram icon to access the settings.

Tone Correction

Provides a graphical interface for adjusting tone levels individually. (For advanced users only.) Click the  tone correction icon to access the settings.

Brightness

Adjusts the overall lightness and darkness of the scanned image.

Contrast

Adjusts the difference between the light and dark areas of the overall scanned image.

Saturation

Adjusts the density of colors in the overall image.

Color Balance

Adjusts the balance of colors in the overall image.

Color Palette

Provides a graphical interface for adjusting mid-tone levels, such as skin tones, without affecting the highlight and shadow areas of the image. (For advanced users only.) Click the  Color Palette icon to access the settings.

Threshold

Adjusts the level at which black areas in text and line art are delineated, improving text recognition in OCR (Optical Character Recognition) programs.

Parent topic: [Scanning in Professional Mode](#)

Selecting a Scan Size - Professional Mode

You can reduce or enlarge the size of your image as you scan. You can also select a specific scan size, such as a common photo size like 4 × 6 inches (102 × 152 mm). This places a scan area of that size on the preview image so you can use it to help crop the image in the correct proportions.

1. Click the **Preview** button to preview your image.
2. In the Epson Scan window, select the size you want your scanned image to be from the **Target Size** list.



Note: If you need to rotate the orientation of the target size for your image, click the  orientation icon.

A marquee (dotted line) appears on your preview image proportioned for the size you selected.

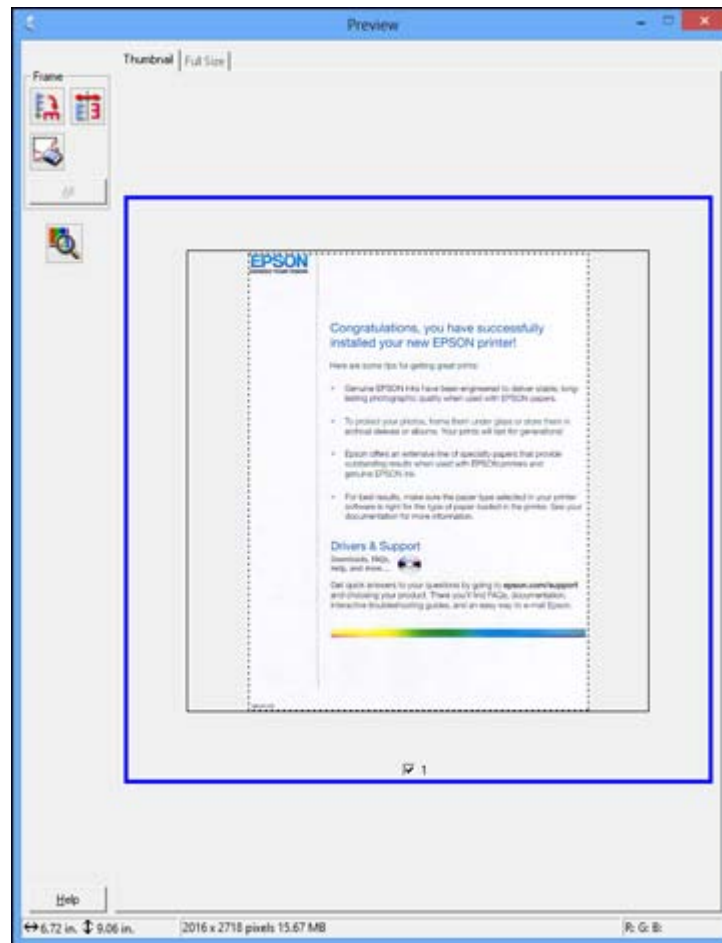

3. Do the following, as necessary, to work with the selected scan area:
 - To move the marquee, click inside the scan area and drag the marquee where you want it.
 - To resize the scan area, place your cursor over the edge or corner of the marquee, then click and drag the edge where you want it.

Note: Manually adjusting the marquee will not change the target size of the scanned file. The marquee only indicates the area of the image that will be scanned.

4. To create a scanned image size that is not available in the Target Size list, click the **Customize** option.

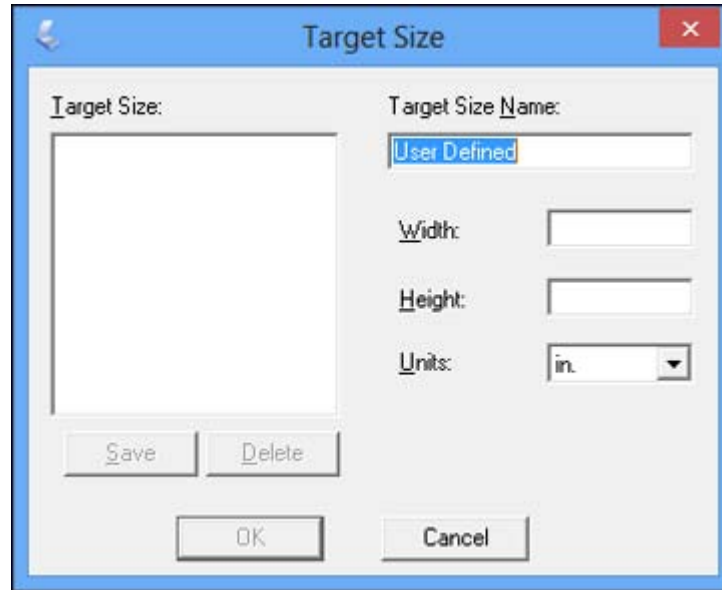

5. Name the custom size, enter the size, click **Save**, and click **OK**. Then create a scan area on the preview image.
The marquee is automatically proportioned for your custom scan size.
6. To use additional sizing tools, click the + (Windows) or ► (OS X) icon next to the Target Size setting and select options as desired.



- **Scale:** Reduces or enlarges your image by the percentage you enter.

- **Trimming:** Turns automatic image cropping on or off.
-  Unlock icon: Unlocks the width/height proportions of the scanned image size so you can adjust it without constraint.

Parent topic: [Scanning in Professional Mode](#)

Image Preview Guidelines

You can preview your scanned image so you can adjust the scan settings using the preview as a guide. There are two types of preview available, depending on the scan mode and selected settings:

Thumbnail preview

A thumbnail preview displays your previewed images as thumbnails with the scanned image area and exposure automatically selected. If the **Thumbnail** checkbox is selected, clicking the **Preview** button opens a thumbnail preview.

Normal preview

A normal preview displays your previewed images in their entirety so you can select the scanned image area and other settings manually. If the **Thumbnail** checkbox is deselected, clicking the **Preview** button opens a normal preview.

Parent topic: [Selecting Epson Scan Settings](#)

Scan Resolution Guidelines

If you plan to enlarge a scanned image so you can print it at a larger size, you may need to increase the resolution from the default resolution set by Epson Scan. Follow these guidelines to determine the resolution setting you need:

- You will enlarge the image as you scan it.
If you will enlarge the image using Epson Scan's Target Size setting (Home and Professional modes only), you do not need to increase the Resolution setting.
- You will scan the image at its original size, but enlarge it later in an image-editing program.
Increase Epson Scan's Resolution setting in your scan. Increase the resolution by the same amount you will increase the image size to retain a high image quality. For example, if the resolution is 300 dpi (dots per inch) and you will double the image size later, change the Resolution setting to 600 dpi.
- You will scan the image at 100% or smaller size.
Select Epson Scan's Resolution setting based on how you will use the scanned image:
 - Email/view on a computer screen/post on the web: 96 to 150 dpi
 - Print/convert to editable text (OCR): 300 dpi

- Fax: 200 dpi

Parent topic: [Selecting Epson Scan Settings](#)

Selecting Scan File Settings

You can select the location, name, and format of your scan file on the File Save Settings window. You can also select various optional settings that control how Epson Scan behaves when you scan and save files.

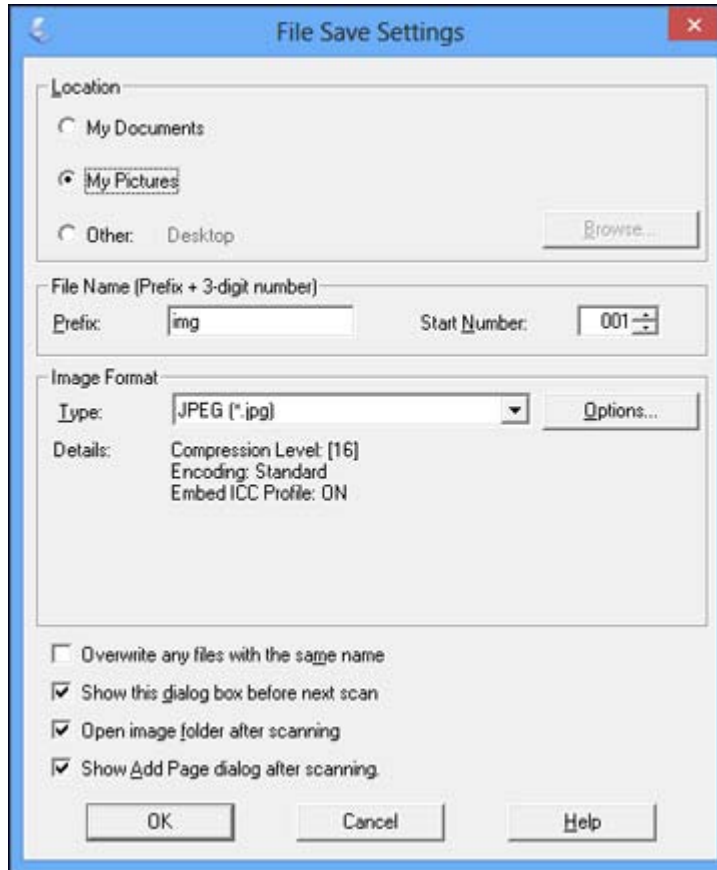

The File Save Settings window may appear after you click **Scan** on the Epson Scan window. You may also be able to access the window by clicking the  icon on the Epson Scan window.

1. Do one of the following to select the folder in which you want to save your scanned image:
 - Click the button for one of the displayed folders.
 - Click the **Other** button, click the **Browse** or **Choose** button, and select a folder.
2. Type in a stem file name in the **Prefix** field. This name is used along with numbers to automatically name your scanned files.
3. Select a different number as the **Start Number** setting, if you like.
4. Select the file format you want to use in the Image Format **Type** menu.
5. If your file format provides optional settings, click the **Options** button to select them.
6. Choose any of the optional settings you want to use by selecting their checkboxes.
7. Click **OK**.

[Available Scanned File Types and Optional Settings](#)

Parent topic: [Selecting Epson Scan Settings](#)

Available Scanned File Types and Optional Settings

You can select from a variety scanned file types and optional settings on the File Save Settings window in Epson Scan.

File Formats

Bitmap (*.bmp)

A standard image file format for most Windows programs.

JPEG (*.jpg)

An image format that lets you highly compress image data. However, the higher the compression, the lower the image quality. (The Tiff format is recommended when you need to modify or retouch your scanned image.)

Multi-TIFF (*.tif)

A Tiff file format when multiple pages are saved to the same file, allowing you to edit the images using a compatible program.

PDF (*.pdf)

A document format that is readable by Windows and OS X systems using Adobe Reader, Acrobat, or other programs. You can save multi-page documents in one PDF file.

PICT (*.pct)

A standard image file format for most OS X programs.

PRINT Image Matching II (*.jpg or *.tif)

File formats that include Epson PRINT Image Matching II data for enhanced quality and a wider color range (does not affect the way the image displays on the screen).

TIFF (*.tif)

A file format created for exchanging data between many programs, such as graphic and DTP software.

Optional Settings**Overwrite any files with the same name**

Select to overwrite previous files with the same names.

Show this dialog box before next scan

Select to have the File Save Settings window appear automatically before you scan.

Open image folder after scanning

Select to have Windows Explorer or OS X Finder automatically open to the folder where your scanned image is saved after scanning.

Show Add Page dialog after scanning

If you are scanning a multi-page document using the PDF or Multi-Tiff format, select to display a prompt for scanning additional pages after the first page is scanned.

Parent topic: [Selecting Scan File Settings](#)

Scanning with OS X Using Image Capture

With OS X 10.6/10.7/10.8, you can scan with your product using an image-editing application such as Image Capture.

Note: With OS X 10.6, 10.7, 10.8, or 10.9, in addition to scanning with Image Capture, you can download and install Epson Scan scanning software. Epson Scan provides additional image adjustment and photo correction features for enhancing scanned images, and provides an interface for TWAIN-compliant OCR scanning software, such as ABBYY FineReader. To download Epson Scan, visit Epson's driver download site ([U.S. downloads](#) or [Canadian downloads](#)).

1. Open an image editing application, such as Image Capture.
2. Select your Epson product from the **DEVICES** or **SHARED** list, if necessary. (You may need to hover over the **DEVICES** or **SHARED** list, click **Show**, and select your product.)
3. If you see the **Show Details** button, click it.

If you are scanning an item on the scanner glass, your product begins a preview scan.

4. Select the **Scan Mode** setting indicating where you placed your original (if available). Select any other scan settings as necessary.

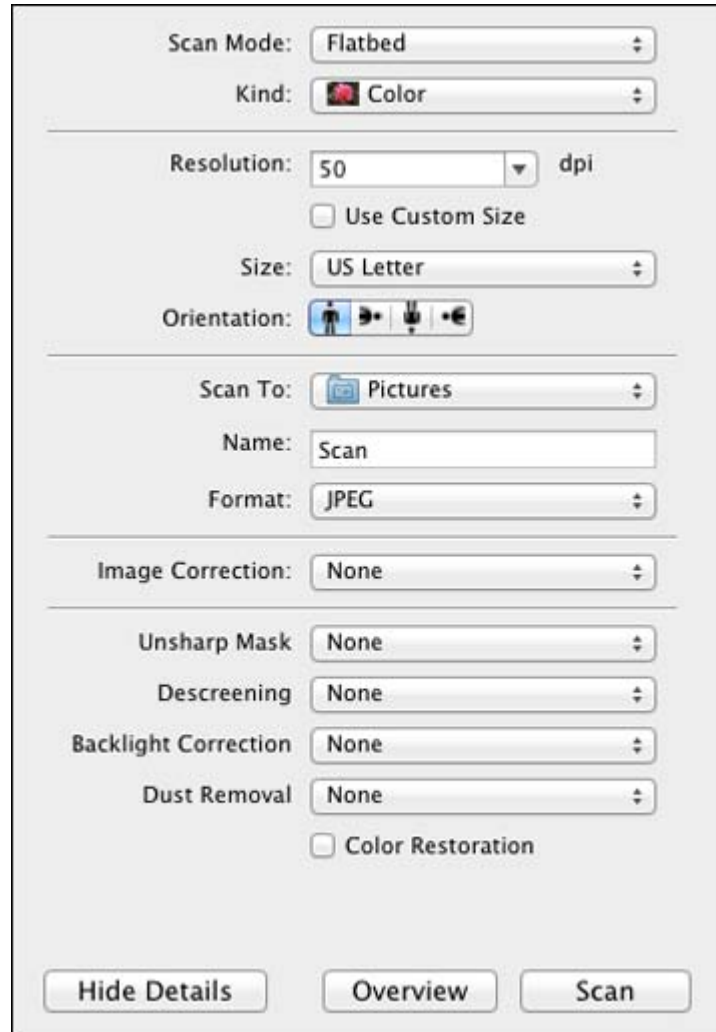

The image shows a scan settings dialog box with the following options:

- Scan Mode: Flatbed
- Kind: Color
- Resolution: 50 dpi
- Use Custom Size
- Size: US Letter
- Orientation: Portrait (indicated by a vertical icon)
- Scan To: Pictures
- Name: Scan
- Format: JPEG
- Image Correction: None
- Unsharp Mask: None
- Descreening: None
- Backlight Correction: None
- Dust Removal: None
- Color Restoration

Buttons at the bottom: Hide Details, Overview, Scan

5. Select the folder in which you want to save your scanned file in the **Scan To** pop-up menu.
6. Click **Scan**.

Your scanned file is saved in the folder you selected.

[Available Scan Settings - OS X Image Capture](#)

Parent topic: [Scanning](#)

Available Scan Settings - OS X Image Capture

You can select these scan settings in your imaging editing application for OS X.

Unsharp Mask

Makes the edges of certain image areas clearer. Turn off this option to leave softer edges.

Descreening

Removes the ripple pattern that might appear in subtly shaded image areas, such as skin tones. This option improves results when scanning magazines or newspapers. (The results of descreening do not appear in the preview image, only in your scanned image.)

Backlight Correction

Removes shadows from photos that have too much background light.

Dust Removal

Removes dust marks from your originals automatically.

Color Restoration

Restores the colors in faded photos automatically.

Parent topic: [Scanning with OS X Using Image Capture](#)

Scanning Special Projects

Your product's scanning software offers various options to help you quickly complete special scan projects.

[Scanning to a PDF File](#)

[Restoring Photo Colors as You Scan](#)

[Convert Scanned Documents to Editable Text \(OCR\)](#)

Parent topic: [Scanning](#)

Scanning to a PDF File

Using Epson Scan, you can scan a multi-page document and save it in one PDF (Portable Document Format) file on your computer.

1. Place your original on your product for scanning.
2. Start Epson Scan.

3. Select the scan mode you want to use.
4. Select the scan settings for your scan.
5. Preview your image.
6. When you finish selecting all your settings, click **Scan**.
You see the File Save Settings window.

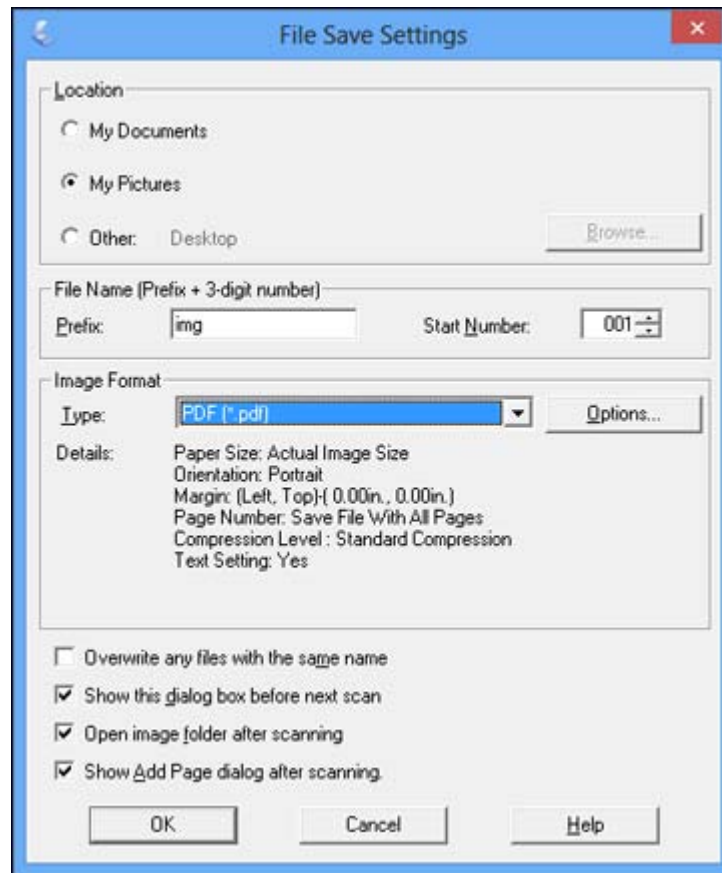

7. Select **PDF** as the Type setting.
8. Select any other settings you want to use on the File Save Settings window. Click the **Options** button to access additional settings.

9. Click **OK**.

Epson Scan scans your document and you see this window:

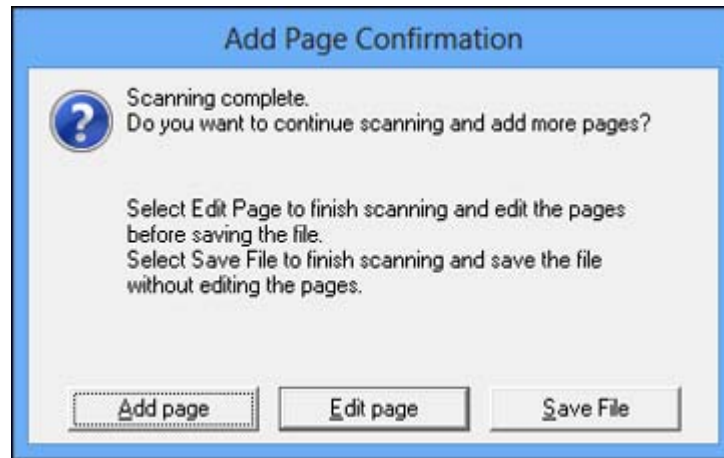

10. Choose one of the following options on the screen:

- If you are scanning only one page, click **Save File**.
- If you need to scan additional pages in a document, click **Add page**. Place additional pages on the product for scanning, click **Scan**, and repeat until you have scanned all the pages. When you are finished, click **Save File**.
- If you need to delete or reorder the scanned pages, click **Edit page**. Delete or reorder the pages using the icons that appear on the bottom of the editing window. When you are finished, click **OK**.

Note: If you installed an OCR (Optical Character Recognition) program, you may see a screen indicating the program is converting your page to text. Wait until the program re-scans the page and close the program, if necessary.

11. Click **Close** to exit the Epson Scan window, if necessary.

Epson Scan scans your original, and saves the PDF file in the selected folder or opens it in your scanning program. If the file was saved directly to your computer, you see the file in the Windows Explorer or Mac OS X Finder, where you can view and print the document, if desired.

Parent topic: [Scanning Special Projects](#)

Related tasks

[Starting a Scan Using the Epson Scan Icon](#)

[Selecting the Scan Mode](#)

[Selecting Scan File Settings](#)

Related topics

[Placing Originals on the Product](#)

Restoring Photo Colors as You Scan

You can restore the colors in faded photos as you scan them using Epson Scan's Color Restoration setting. You can select this setting in any of the available scan modes.

Note: Color restoration is not available in Office Mode, if Epson Scan offers that mode.

1. Place your original on your product for scanning.
2. Start Epson Scan.
3. Select the scan mode you want to use.
4. Select the scan settings for your scan.
5. Preview your image.
6. Locate or access the image adjustment settings.
7. Select the **Color Restoration** checkbox.



8. When you finish selecting all your settings, click **Scan**.
9. Click **Close** to exit the Epson Scan window, if necessary.

Epson Scan scans your original, and saves the color-restored file in the selected folder or opens it in your scanning program. If the file was saved directly to your computer, you see the file in the Windows Explorer or Mac OS X Finder, where you can view and print the image, if desired.

Parent topic: [Scanning Special Projects](#)

Related tasks

[Starting a Scan Using the Epson Scan Icon](#)

[Selecting the Scan Mode](#)

Related topics

[Placing Originals on the Product](#)

[Selecting Epson Scan Settings](#)

Convert Scanned Documents to Editable Text (OCR)

You can scan a document and convert the text into data that you can edit with a word processing, spreadsheet, or HTML-editing program. This process is called OCR (Optical Character Recognition).

To scan and use OCR, you need to install an OCR program, such as ABBYY FineReader.

In Mac OS X 10.6/10.7/10.8, you can use ABBYY FineReader to convert scanned documents to editable text by first using an application such as Image Capture. Scan and save your document in Image Capture, then open ABBYY FineReader, open the **Get Images From** pop-up menu, and select **File**. Select the conversion option you want to use, then select your scanned file and follow the instructions on the screen.

Note: With OS X 10.6, 10.7, 10.8, or 10.9, in addition to scanning with Image Capture, you can download and install Epson Scan scanning software. Epson Scan provides additional image adjustment and photo correction features for enhancing scanned images, and provides an interface for TWAIN-compliant OCR scanning software, such as ABBYY FineReader. To download Epson Scan, visit Epson's driver download site ([U.S. downloads](#) or [Canadian downloads](#)).

[Scanning Using OCR - Windows](#)

[Scanning Using OCR - Mac OS X](#)

Parent topic: [Scanning Special Projects](#)

Scanning Using OCR - Windows

You can use the ABBYY FineReader OCR program to convert scanned documents to editable text.

1. Place your original on your product for scanning.
2. Do one of the following to open ABBYY FineReader:
 - **Windows 8.x:** Navigate to the **Apps** screen and select **ABBYY FineReader 9.0 Sprint**.
 - **Windows (other versions):** Click  or **Start > All Programs** or **Programs > ABBYY FineReader 9.0 Sprint > ABBYY FineReader 9.0 Sprint**.

You see this window:



3. Select the language used in the document you are going to scan as the **Document Language** setting.
4. Click either the **Scan to Other Formats** icon or the icon that corresponds with the program you want to scan to.
5. If you see the Select Scanner window, select your product and click **OK**.

Note: Do not select a **WIA** option for your product; it will not work correctly.

You see the scan settings window.

6. Select your scan settings.
7. Click **Preview** and adjust the area you want to scan, if necessary.
8. Click **Scan**.

Note: To scan a multi-page document, select settings in the Multi-Page Scanning section and click **Scan** for each page.

9. When you are finished scanning, click **Close**.

Your document is scanned and processed into editable text, then you see the Save As window.

10. Select a name and a file format for your document and click **Save**.

The file is saved and then opened in an application associated with the file type you selected, if available on your system.

Parent topic: [Convert Scanned Documents to Editable Text \(OCR\)](#)

Related topics

[Placing Originals on the Product](#)

Scanning Using OCR - Mac OS X

You can use the ABBYY FineReader OCR program to convert scanned documents to editable text.

In Mac OS X 10.6/10.7/10.8, you can use ABBYY FineReader to convert scanned documents to editable text by first using an application such as Image Capture. Scan and save your document in Image Capture, then open ABBYY FineReader, open the **Get Images From** pop-up menu, and select **File**. Select the conversion option you want to use, then select your scanned file and follow the instructions on the screen.

Note: With OS X 10.6, 10.7, 10.8, or 10.9, in addition to scanning with Image Capture, you can download and install Epson Scan scanning software. Epson Scan provides additional image adjustment and photo correction features for enhancing scanned images, and provides an interface for TWAIN-compliant OCR scanning software, such as ABBYY FineReader. To download Epson Scan, visit Epson's driver download site ([U.S. downloads](#) or [Canadian downloads](#)).

1. Place your original on your product for scanning.
2. Open the **Applications** folder and click the **ABBYY FineReader Sprint** icon.

You see this window:



3. Open the **Get Images From** pop-up menu and select your product.
4. Select the language used in the document you are going to scan as the **Document Language** setting.
5. Select the type of document you are going to scan.
Epson Scan starts in the last scan mode you used.
6. Select your scan settings and click **Scan**.
Your document is scanned and you see the Epson Scan window while your document is converted to editable text.
7. Click **Close** to close the Epson Scan window and Preview window, if necessary.

You see the Save Converted File As window:

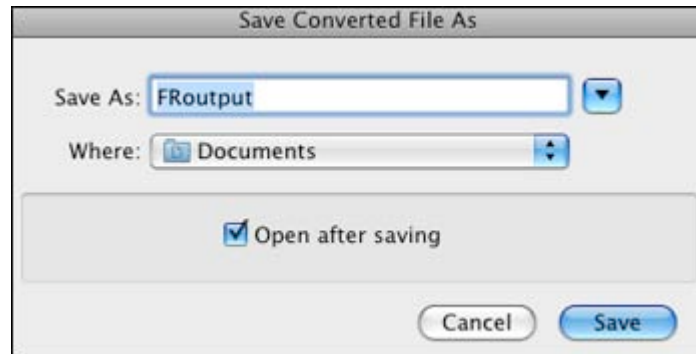

8. Click the **Save** button.

The file is saved and then opened in an application associated with the file type you selected, if available on your system.

Parent topic: [Convert Scanned Documents to Editable Text \(OCR\)](#)

Related tasks

[Scanning with OS X Using Image Capture](#)

Related topics

[Placing Originals on the Product](#)

Faxing

See these sections to fax using your product.

Note: This product allows you to store names, telephone numbers, and fax data in its memory even when the power is turned off. Make sure you restore all of the default settings if you give away or dispose of the product. This will erase all of your network settings and fax data.

[Connecting a Telephone or Answering Machine](#)

[Setting Up Fax Features](#)

[Setting Up Speed Dial and Group Dial Lists](#)

[Sending Faxes](#)

[Receiving Faxes](#)

Connecting a Telephone or Answering Machine

You must connect your product to a telephone wall jack to send or receive faxes. If you want to use the same telephone line to receive calls, you can connect a telephone or answering machine to your product using an additional phone cable.

Note: If you do not connect a telephone to your product, make sure to turn on Auto Answer mode. Otherwise, you cannot receive faxes.

1. Connect a phone cable to your telephone wall jack and to the **LINE** port on your product.

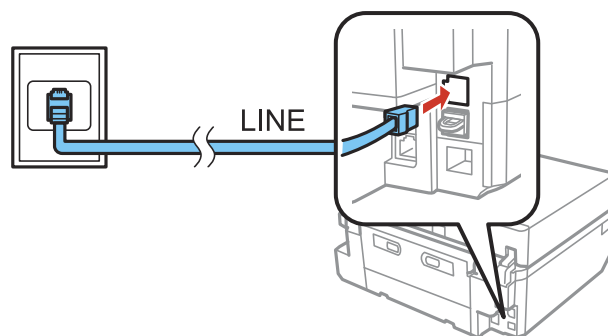

Note: If you have a DSL or ISDN connection, you must connect the appropriate DSL filter, or ISDN terminal adapter or router to the wall jack to be able to use the line for faxing or voice calls using your product. Contact your DSL or ISDN provider for the necessary equipment.

DSL connection

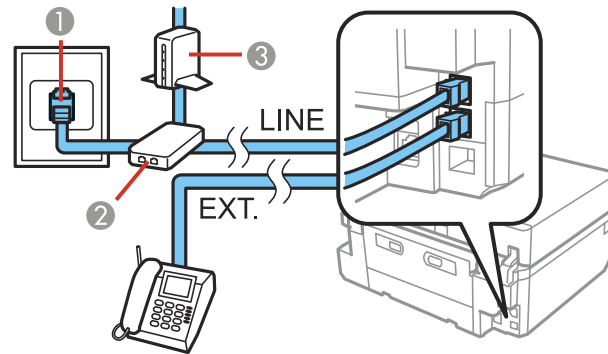

- 1 Telephone wall jack
- 2 DSL filter
- 3 DSL modem

ISDN connection (one phone number)

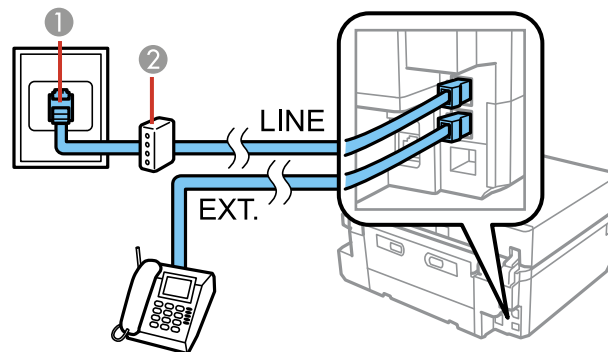

- 1 ISDN wall jack
- 2 Terminal adapter or ISDN router

ISDN connection (two phone numbers)

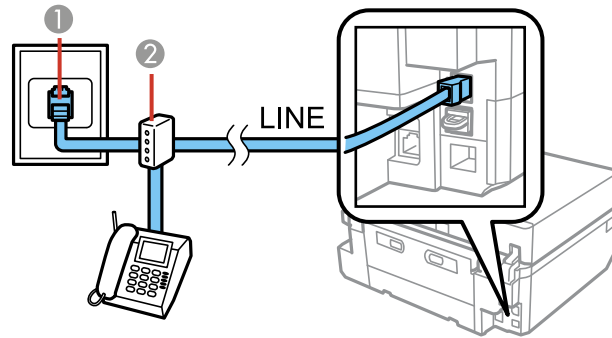

- 1 ISDN wall jack
- 2 Terminal adapter or ISDN router

2. If you are connecting a telephone or answering machine to your product using a second phone cable, remove the cap from the **EXT** port on your product.

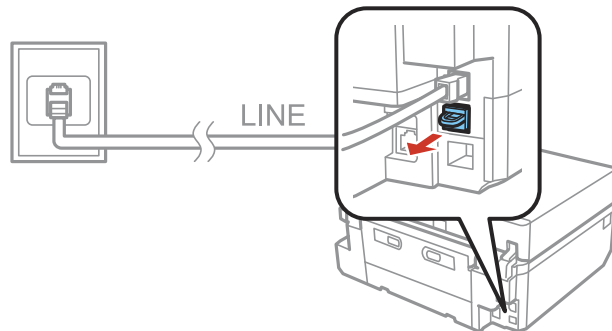

3. Connect a second phone cable to your telephone or answering machine and to the **EXT** port on your product.

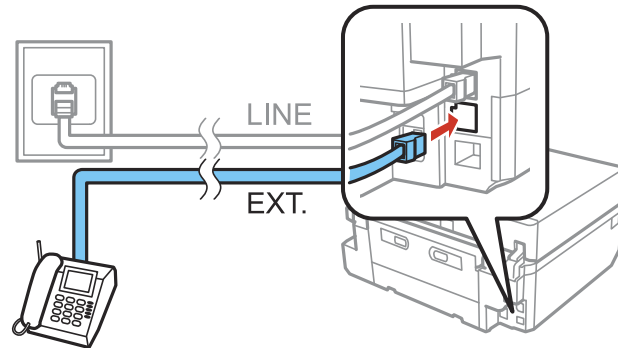

Note: If you connect an answering machine and Auto Answer mode is turned on, set the number of rings before your product answers a call to a number that is higher than your answering machine's setting for the number of rings.

Any phone or answering machine must be connected to the **EXT** port for your product to detect an incoming fax call when the phone is picked up. Epson cannot guarantee compatibility with VoIP, cable phone systems, or fiberoptic digital services such as FIOS.

Parent topic: [Faxing](#)

Related tasks

[Receiving Faxes Automatically \(Auto Answer\)](#)

Setting Up Fax Features

Before faxing with your product, set up your fax header and select the fax features you want to use.

Note: If you leave your product unplugged for a long period of time, you may need to reset the date and time settings for faxes.

[Setting Up Fax Features Using the Product Control Panel](#)

[Setting Up Fax Features Using the Fax Utility - Windows](#)

[Setting Up Fax Features Using the Fax Utility - Mac OS X](#)

Parent topic: [Faxing](#)

Setting Up Fax Features Using the Product Control Panel

See these sections to set up fax features using the product control panel.

[Selecting Your Country or Region](#)

[Selecting the Date and Time](#)

[Entering Fax Header Information](#)

[Entering Numbers and Characters for Faxing](#)

[Selecting Fax Send and Receive Settings](#)

[Selecting Fax Communication Settings](#)

[Printing Fax Reports](#)

[Restoring Default Fax Settings](#)

[Fax Send Options](#)

[Fax Receive Options](#)

[Fax Communications Options](#)

[Fax Report Options](#)

[Restore Default Settings Options](#)

Parent topic: [Setting Up Fax Features](#)

Related tasks

[Setting Up Fax Features Using the Fax Utility - Windows](#)

[Setting Up Fax Features Using the Fax Utility - Mac OS X](#)

Selecting Your Country or Region

Before faxing, select the country or region in which you are using your product.

Note: If you change the country or region, your fax settings return to their defaults and you must select them again.

1. Press the  home button, if necessary.

2. Press the left or right arrow button and then select **Setup**.



3. Scroll down and select **Basic Setup**.



4. Select **Country/Region**.
5. Scroll up or down, if necessary, then select your country or region.
You see a confirmation screen.
6. If the setting is correct, select **Yes**. (If not, select **No** and retry.)

Note: Changing the country or region restores the fax settings to the default settings.

Parent topic: [Setting Up Fax Features Using the Product Control Panel](#)

Selecting the Date and Time

Before faxing, select the current date, time, and daylight saving phase in your area, and choose your preferred date and time format.

1. Press the  home button, if necessary.
2. Press the left or right arrow button and then select **Setup**.



3. Select **Basic Setup**.



4. Select **Daylight Saving Time**.
5. Select the setting that applies to your area:
 - **Winter**: it is winter or your region does not use Daylight Saving Time (DST)
 - **Summer**: it is spring or summer and your region uses Daylight Saving Time (DST)

After making a selection, you return to the **Basic Setup** screen.

Note: If your region uses Daylight Saving Time (DST), you must change this setting to match the season. When you change from **Winter** to **Summer**, your product automatically sets its clock ahead one hour. When you change from **Summer** to **Winter**, it sets its clock back one hour.

6. Select **Date/Time**.



7. Select the date format you want to use.
8. Use the numeric keypad to enter the current date, then select **Done**.
9. Select the time format you want to use.
10. Use the numeric keypad to enter the current time, select **AM** or **PM** if you selected a 12-hour time format, then select **Done**.

You return to the **Basic Setup** screen.

Parent topic: [Setting Up Fax Features Using the Product Control Panel](#)

Entering Fax Header Information

Before faxing, add your sender name and fax number to the fax header to identify the source of the faxes you send.

1. Press the  home button, if necessary.
2. Press the left or right arrow button and then select **Setup**.



3. Scroll down and then select **Fax Settings**.



4. Select **Communication**.

5. Scroll down and then select **Header**.
6. Select **Fax Header**.



7. Use the numeric keypad to enter the sender name for your fax source, such as your name or a business name. You can enter up to 40 characters.
8. Select **Done**.
You return to the **Header** screen.
9. Select **Your Phone Number**.



10. Use the numeric keypad to enter your fax number, up to 20 characters. For international numbers that require use of a + symbol, press the # key.

Note: When entering a phone number, the * key does not work.

11. Select **Done**.

You return to the **Header** screen.

Parent topic: [Setting Up Fax Features Using the Product Control Panel](#)



Related tasks

[Entering Numbers and Characters for Faxing](#)

Entering Numbers and Characters for Faxing

Follow these guidelines to enter numbers and characters for faxing and setting up your fax settings.



- To enter text or characters, press the keys on the numeric keypad until the desired character or number appears.
- To enter symbols, press the **1 Symb.** key until the desired symbol appears.
- To enter a pause symbol (–) in phone numbers requiring a brief pause during dialing, press .
- To move the cursor to the next space, press .
- To delete the previous character, press .

Parent topic: [Setting Up Fax Features Using the Product Control Panel](#)

Selecting Fax Send and Receive Settings

You can select the fax quality and other settings for incoming and outgoing faxes.

1. Press the  home button, if necessary.
2. Press the left or right arrow button and then select **Setup**.



3. Scroll down and then select **Fax Settings**.



4. Select **Send Settings** or **Receive Settings**.
5. Change any of the available settings.

6. Press the  home button to exit.

Parent topic: [Setting Up Fax Features Using the Product Control Panel](#)

Related references

[Fax Send Options](#)

[Fax Receive Options](#)

Selecting Fax Communication Settings

You can customize how your product sends and receives faxes over your phone line.

1. Press the  home button, if necessary.
2. Press the left or right arrow button and then select **Setup**.



3. Scroll down and then select **Fax Settings**.



4. Select **Communication**.
5. Change any of the available settings.
6. Press the  home button to exit.

Parent topic: [Setting Up Fax Features Using the Product Control Panel](#)

Related references

[Fax Communications Options](#)

Printing Fax Reports

You can run a variety of reports on your fax transmissions and print your speed and group dial lists.

Note: You can also select to print a report automatically after a fax is sent by going to **Setup > Fax Settings > Send Settings > Last Transmission Report**.

1. Make sure you loaded letter-size or larger paper in your product.
2. Press the  home button, if necessary.

3. Select **Fax**.



4. Select **Advanced Options**.
5. Scroll down and then select **Fax Report**.



6. Select one of the available reports.
7. Press the \diamond start button to print the report.

Parent topic: [Setting Up Fax Features Using the Product Control Panel](#)

Related references

[Fax Report Options](#)

Restoring Default Fax Settings

You can restore your fax settings to their default options, if necessary.

1. Press the  home button, if necessary.
2. Press the left or right arrow button and then select **Setup**.



3. Scroll down and then select **Restore Default Settings**.



4. Select one of the available options.

You see a confirmation screen.

5. Select **Yes** or **No**.

Parent topic: [Setting Up Fax Features Using the Product Control Panel](#)

Related references

[Restore Default Settings Options](#)

Fax Send Options

Set the Send Settings options you want to use for outgoing faxes.

Setting	Options	Description
Resolution	Standard	Provides good scan resolution and print quality for most faxes.
	Fine	Provides best scan resolution and print quality for faxes of small print and line art.
	Photo	Provides best scan resolution and print quality for faxed photos.
Contrast	-4 to +4	Adjusts the contrast for faxes; negative settings make faxes lighter and positive settings make faxes darker.
2-Sided Faxing	Off	Lets you fax 2-sided originals placed in the ADF.
	On	
Last Transmission Report	On Error	Prints a report on the last transmitted fax only if a fax error occurs (default setting).
	On Send	Prints a report on the last transmitted fax after every fax you send.
	Off	Does not print a report on the last transmitted fax after you send a fax.

Parent topic: [Setting Up Fax Features Using the Product Control Panel](#)

Fax Receive Options

Set the printing options you want to use for incoming faxes.

Setting	Options	Description
Auto Answer	Off	Allows you to confirm if an incoming fax should be printed. (A telephone must be connected to the product.)
	On	Automatically receive and print faxes.
Paper Size	Letter	Sets the size of the paper loaded for incoming faxes.
	Legal	
	A4	
Auto Reduction	On	Reduces size of incoming faxes to fit on the size of paper selected as the Paper Size setting.
	Off	Prints incoming faxes in original size or on multiple sheets, if loaded paper size is smaller.

Parent topic: [Setting Up Fax Features Using the Product Control Panel](#)

Fax Communications Options

Set the communication options you want to use for faxing over your phone line.

Setting	Options	Description
DRD	All	If you are using a Distinctive Ring Service on your phone line, your telephone company can assign two or more phone numbers to the same line and assign different ring patterns to each. If you use this service, select the number of rings for your fax number as the DRD setting so your product can receive faxes on the correct number of rings. All is the default setting and works for phone lines that do not use this service.
	Single	
	Double	
	Triple	
	Double & Triple	
ECM	On	Turns on Error Correction Mode (ECM) to automatically request retransmission of faxes received with detected errors (default setting).
	Off	Turns off Error Correction Mode (ECM).

Setting	Options	Description
Fax Speed	Fast(33,600bps)	Transmits faxes at 33.6 Kbps
	Medium(14,400bps)	Transmits faxes at 14.4 Kbps (default setting)
	Slow(9,600bps)	Transmits faxes at 9.6 Kbps
Rings to Answer	1 to 9	Sets the number of rings before your product receives a fax. The default setting is 4 . If Auto Answer is turned on and an answering machine is connected to the product, make sure this setting is set higher than the number of rings your answering machine is set to answer a call.
Dial Tone Detection	On	Automatically dials the phone number you enter to send a fax when the product detects a dial tone on the line.
	Off	Turns off automatic dial tone detection. This is necessary if you connected your product to a phone line on a Private Branch Exchange (PBX) or Terminal Adapter (TA) system.
Header	Fax Header	Lets you set up the header information for outgoing faxes.
	Your Phone Number	

Parent topic: [Setting Up Fax Features Using the Product Control Panel](#)

Fax Report Options

Select the fax report or list you want to print.

Fax Log

View or print a report on recent fax transmissions.

Last Transmission

Print a report on your last fax transmission.

Contact List

Print a list of your contacts.

Speed Dial List

Print a list of your speed dial entries.

Group Dial List

Print a list of your group dial entries.

Reprint Faxes

Reprint the most recent incoming fax.

Protocol Trace

Print a protocol trace of your last fax transmission.

Parent topic: [Setting Up Fax Features Using the Product Control Panel](#)

Restore Default Settings Options

Select the product settings you want to restore.

Fax Send/Receive Settings

Restores all of the default fax settings on the **Send Settings**, **Receive Settings**, and **Communication** screens.

Fax Data Settings

Erases the speed dial list, group dial list, header, and fax log.

Wi-Fi/Network Settings

Restores all of the default network settings.

All Except Wi-Fi/Network & Fax Settings

Restores all of the default settings on the control panel, except for the network and fax settings.

All Settings

Restores all of the default settings on the control panel.

Parent topic: [Setting Up Fax Features Using the Product Control Panel](#)

Setting Up Fax Features Using the Fax Utility - Windows

You can set up your fax header and select your fax settings using the FAX Utility for Windows.

1. Do one of the following:
 - **Windows 8.x:** Navigate to the **Start** screen.
 - **Windows (other versions):** Click  or **Start > Programs** or **All Programs > EPSON Software**.
2. Select **FAX Utility**.

You see this window:



3. Select **Fax Settings for Printer**. (Select your product, if prompted.)
You see this window:



4. Select **Fax Settings**.
5. Follow the prompts that appear on the screen to enter your fax header information and select your fax settings.

Note: For detailed information, select the FAX Utility **Help** option.

Parent topic: [Setting Up Fax Features](#)

Related topics

[Setting Up Fax Features Using the Product Control Panel](#)

Setting Up Fax Features Using the Fax Utility - Mac OS X

You can set up your fax header and select your fax settings using the FAX Utility for Mac OS X.

1. Do one of the following:
 - **Mac OS X 10.6/10.7/10.8:** In the Apple menu or the Dock, select **System Preferences**. Select **Print & Fax** or **Print & Scan**, select the **FAX** option for your product, and select **Options & Supplies**. Select **Utility** and select **Open Printer Utility**.
 - **Mac OS X 10.5:** In the Apple menu or the Dock, select **System Preferences**. Select **Print & Fax**, select the **FAX** option for your product, and select **Open Print Queue**. Select **Utility**.
2. Double-click **FAX Utility**, if necessary.

You see this window:



3. Select your **FAX** product in the Printer list.
4. Select **Fax Settings**.
5. Follow the prompts that appear on the screen to enter your fax header information and select your fax settings.

Note: For detailed information, select the FAX Utility ? icon.

Parent topic: [Setting Up Fax Features](#)

Related topics

[Setting Up Fax Features Using the Product Control Panel](#)

Setting Up Speed Dial and Group Dial Lists

You can set up a speed dial list of fax numbers so you can quickly select them for faxing. You can also set up a group dial list to send a fax message to multiple speed dial numbers.

See these sections to set up speed dial and group dial lists.

[Setting Up Speed/Group Dial Lists Using the Product Control Panel](#)

[Setting Up Speed/Group Dial Lists Using the Fax Utility - Windows](#)

[Setting Up Speed/Group Dial Lists Using the Fax Utility - Mac OS X](#)

Parent topic: [Faxing](#)

Setting Up Speed/Group Dial Lists Using the Product Control Panel

You can set up your speed dial and group dial lists using the control panel on your product.

[Creating Speed Dial List Entries](#)

[Printing Your Speed Dial List](#)

[Creating Group Dial List Entries](#)

[Printing Your Group Dial List](#)

Parent topic: [Setting Up Speed Dial and Group Dial Lists](#)

Related tasks

[Setting Up Speed/Group Dial Lists Using the Fax Utility - Windows](#)

[Setting Up Speed/Group Dial Lists Using the Fax Utility - Mac OS X](#)

Creating Speed Dial List Entries

You can create a speed dial list of fax numbers to help you quickly send faxes.

Note: You can create up to 60 speed dial and group dial entries combined.

1. Press the  home button, if necessary.
2. Select **Fax**.



3. Select **Contacts**.
4. Select **Add/Edit Contacts**.
5. Select **Speed Dial Setup**.

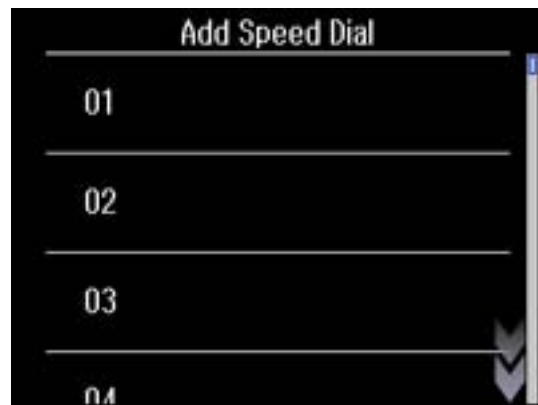

6. Select the number you want to use for the fax number you are adding.

7. Use the numeric keypad to enter the fax number. You can enter up to 64 characters.
8. Select **Done**.

You see this screen:



9. Use the numeric keypad to enter a name for the speed dial entry. You can enter up to 30 characters.
10. Select **Done**.

You return to the Add/Edit Contacts screen.

11. Do the following as necessary:
 - To create additional entries, select **Speed Dial Setup** and repeat the steps above.
 - To edit an existing entry, select **Edit Contacts**, select the entry, and change the information.
 - To delete an entry, select **Delete Contacts**, select the entry, select **Proceed**, and confirm the deletion.

Parent topic: [Setting Up Speed/Group Dial Lists Using the Product Control Panel](#)

Related tasks

[Printing Your Speed Dial List](#)

Printing Your Speed Dial List

You can print your speed dial list for easy reference.

1. Load paper in your product.
2. Press the  home button, if necessary.

3. Select **Fax**.



4. Select **Advanced Options**.
5. Scroll down and then select **Fax Report**.



6. Scroll down and then select **Speed Dial List**.
7. Press the \diamond start button to print the report.

Parent topic: [Setting Up Speed/Group Dial Lists Using the Product Control Panel](#)

Creating Group Dial List Entries

You can create a group dial list after creating a speed dial list. Each group dial list can include up to 30 fax numbers.

Note: You can create up to 60 speed dial and group dial entries combined.

1. Press the  home button, if necessary.
2. Select **Fax**.



3. Select **Contacts**.
4. Select **Add/Edit Contacts**.
5. Select **Group Dial Setup**.
6. Select the number you want to use for the group dial entry you are adding.
7. Use the numeric keypad to enter a name for the group dial entry. You can enter up to 30 characters.
8. Select **Done**.
9. Select the speed dial entry you want to add to the group and press to select it.
10. Continue selecting speed dial entries as necessary.
11. When you are finished, select **Done**.

You return to the Add/Edit Contacts screen.

12. Do the following as necessary:

- To create additional entries, select **Group Dial Setup** and repeat the steps above.
- To edit an existing entry, select **Edit Contacts**, select the entry, and change the information.
- To delete an entry, select **Delete Contacts**, select the entry, select **Proceed**, and confirm the deletion.

Parent topic: [Setting Up Speed/Group Dial Lists Using the Product Control Panel](#)

Related tasks

[Creating Speed Dial List Entries](#)

[Printing Your Group Dial List](#)

Printing Your Group Dial List

You can print your group dial list for easy reference.

1. Load paper in your product.
2. Press the  home button, if necessary.
3. Select **Fax**.



4. Select **Advanced Options**.

5. Scroll down and then select **Fax Report**.



6. Scroll down and then select **Group Dial List**.
7. Press the \diamond start button to print the report.

Parent topic: [Setting Up Speed/Group Dial Lists Using the Product Control Panel](#)

Setting Up Speed/Group Dial Lists Using the Fax Utility - Windows

You can set up your speed dial and group dial lists using the FAX Utility for Windows. The utility also lets you import fax numbers from the Windows Address Book and back up fax numbers stored in your product's memory.

Note: You can create up to 60 speed dial and group dial entries combined.

1. Do one of the following:
 - **Windows 8.x:** Navigate to the **Start** screen.
 - **Windows (other versions):** Click  or **Start > Programs** or **All Programs > EPSON Software**.
2. Select **FAX Utility**.

You see this window:



3. Select **Fax Settings for Printer**. (Select your product, if prompted.)
You see this window:



4. Select **Speed Dial/Group Dial List**.

You see this window:

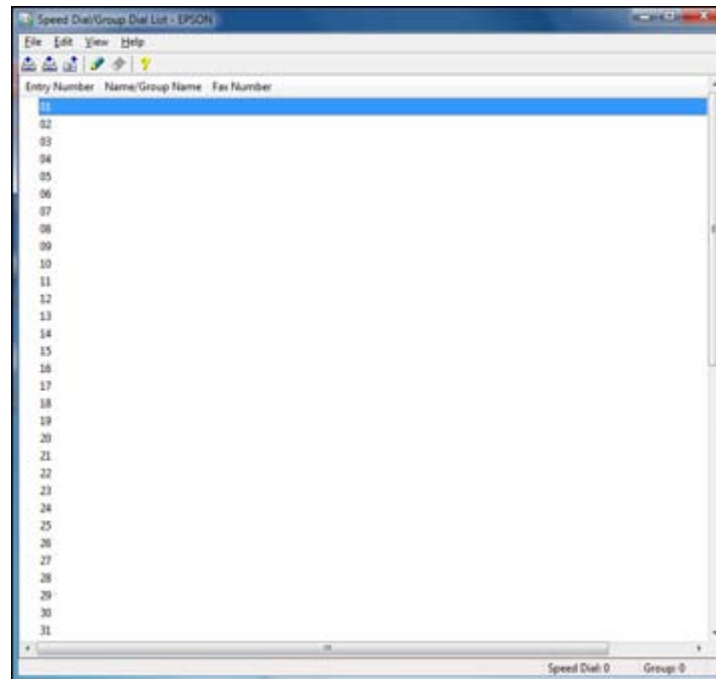

5. Select an empty entry and click the  icon.

Note: To edit an entry, select it and click the  icon. To delete an entry, select it and click the  icon.

6. Do one of the following:

- To create a speed dial entry, select **Speed Dial**, enter a name and fax number, and click **OK**.
- To create a group dial entry, select **Group**, enter a name, select your desired fax numbers, and click **OK**.

7. Repeat the previous steps as necessary to add all your speed dial or group dial entries.

8. When you are finished, click the  icon to save the entries to your product's memory.

Parent topic: [Setting Up Speed Dial and Group Dial Lists](#)

Related topics

[Setting Up Speed/Group Dial Lists Using the Product Control Panel](#)

Setting Up Speed/Group Dial Lists Using the Fax Utility - Mac OS X

You can set up your speed dial and group dial lists using the FAX Utility. The utility also lets you import fax numbers from the MacAddress Book and back up fax numbers to your product's memory.

Note: You can create up to 60 speed dial and group dial entries combined.

1. Do one of the following:
 - **Mac OS X 10.6/10.7/10.8:** In the Apple menu or the Dock, select **System Preferences**. Select **Print & Fax** or **Print & Scan**, select the **FAX** option for your product, and select **Options & Supplies**. Select **Utility** and select **Open Printer Utility**.
 - **Mac OS X 10.5:** In the Apple menu or the Dock, select **System Preferences**. Select **Print & Fax**, select the **FAX** option for your product, and select **Open Print Queue**. Select **Utility**.
2. Double-click **FAX Utility**, if necessary.

You see this window:

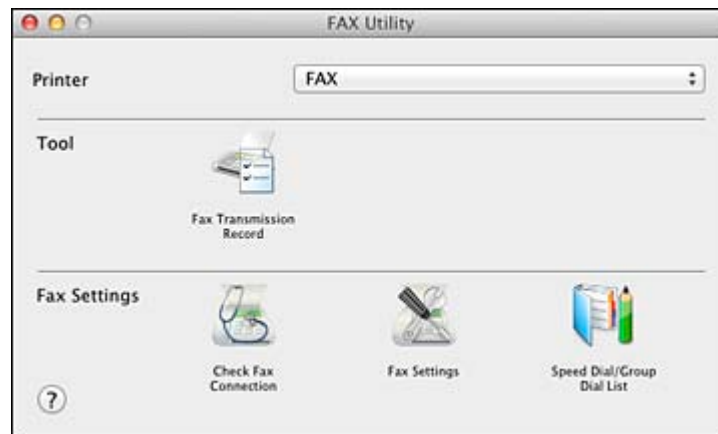



3. Select your **FAX** product in the Printer list.
4. Select **Speed Dial/Group Dial List**.

You see this window:

5. To add an entry, double-click an empty entry.

Note: To edit an entry, select it and change the information. To delete an entry, select it and press the **Delete** key on your keyboard.

6. Do one of the following:
 - To create a speed dial entry, select **Speed Dial**, enter a name and fax number, and click **OK**.
 - To create a group dial entry, select **Group Dial**, enter a name, select your desired fax numbers, and click **OK**.
7. Repeat the previous steps as necessary to add all your speed dial or group dial entries.
8. To import entries from your MacAddress book, click the  icon.
9. When you are finished, click the  icon to save the entries to your product's memory.

Parent topic: [Setting Up Speed Dial and Group Dial Lists](#)

Related topics

[Setting Up Speed/Group Dial Lists Using the Product Control Panel](#)

Sending Faxes

See these sections to send faxes using your product.

[Sending Faxes from the Product Control Panel](#)

[Sending Faxes Using the Fax Utility - Windows](#)

[Sending Faxes Using the Fax Utility - Mac OS X](#)

Parent topic: [Faxing](#)

Sending Faxes from the Product Control Panel

See these sections to send faxes using the product's control panel.

[Manually Dialing or Redialing Fax Numbers](#)

[Selecting Fax Numbers from Speed or Group Dial Lists](#)

[Dialing Fax Numbers from a Connected Telephone](#)

[Broadcasting a Fax](#)

[Sending a Fax at a Specified Time](#)

Fax Sending Options

Parent topic: [Sending Faxes](#)

Manually Dialing or Redialing Fax Numbers

You can send a fax from your product control panel by manually dialing the fax number or redialing the last dialed fax number.

1. Place your original on the product for faxing.
2. Press the  home button, if necessary.
3. Select **Fax**.



4. Do one of the following:
 - Select the **Enter Fax Number** area on the LCD display, then use the numeric keypad to enter the fax number. You can enter up to 64 characters.
 - Press **Redial** to redial the last dialed fax number.
5. If you need to change any fax settings, scroll down and select your settings.

Note: If your recipient's fax machine does not print in color, your fax is automatically sent in black-and-white.

6. Press the  start button. If prompted, select where you placed your document (ADF or scanner glass).

Note: To cancel faxing, select **Cancel**.

Your product scans your original and prompts you to place additional pages, if necessary. After scanning your originals, your product dials the number and sends the fax.

Note: If the number is busy or there is a communication problem, your product displays a redialing message and will redial the number in a few minutes.

Parent topic: [Sending Faxes from the Product Control Panel](#)

Related references

[Fax Sending Options](#)

Related tasks

[Entering Numbers and Characters for Faxing](#)

Related topics

[Placing Originals on the Product](#)

Selecting Fax Numbers from Speed or Group Dial Lists

You can send a fax from your product control panel by selecting a speed dial or group dial entry from the list.

1. Place your original on the product for faxing.
2. Press the  home button, if necessary.

3. Select **Fax**.



4. Select **Contacts**.
5. Select the speed dial or group dial entry you want to use.
6. If you need to change any fax settings, scroll down and select your settings.

Note: If your recipient's fax machine does not print in color, your fax is automatically sent in black-and-white.

7. Press the  start button. If prompted, select where you placed your document (ADF or scanner glass).

Note: To cancel faxing, select **Cancel**.

Your product scans your original and prompts you to place additional pages, if necessary. After scanning your originals, your product dials the number and sends the fax.

Note: If the number is busy or there is a communication problem, your product displays a redialing message and will redial the number in a few minutes.

Parent topic: [Sending Faxes from the Product Control Panel](#)

Related references

[Fax Sending Options](#)

Related topics

[Placing Originals on the Product](#)

[Setting Up Speed Dial and Group Dial Lists](#)

Dialing Fax Numbers from a Connected Telephone

If you have connected a telephone to the **EXT** port on your product, you can send a fax by dialing the fax number from the connected telephone.

1. Place your original on the product for faxing.
2. Press the  home button, if necessary.
3. Select **Fax**.



4. Dial the fax number from the connected telephone.
5. Select **Send** on the LCD display.

Note: Your product now communicates with the recipient's fax machine. Do not hang up the telephone.

6. If you need to change any fax settings, scroll down and select your settings.

Note: If your recipient's fax machine does not print in color, your fax is automatically sent in black-and-white.

7. Press the  start button. If prompted, select where you placed your document (ADF or scanner glass).

Note: To cancel faxing, select **Cancel**.

Your product scans your original and prompts you to place additional pages, if necessary.

8. Hang up the telephone.

After scanning your originals, your product sends the fax.

Parent topic: [Sending Faxes from the Product Control Panel](#)

Related references

[Fax Sending Options](#)

Related topics

[Placing Originals on the Product](#)

Broadcasting a Fax

You can easily send a fax to several recipients at the same time using your speed dial list or group dial list, or by entering phone numbers. You can send the same fax to up to 30 phone numbers.

Note: You can only send faxes in black-and-white when you use this option.

1. Place your original on the product for faxing.
2. Press the  home button, if necessary.
3. Select **Fax**.



4. Select **Advanced Options**.
5. Select **Broadcast Fax**.
6. Select **Add New** then do one of the following:
 - Select **Enter Fax Number** then use the numeric keypad to manually enter fax numbers.
 - Select **Select From Contacts** then select a speed or group dial entry.
7. Repeat the step above to add additional fax recipients, if necessary.
8. When you have finished selecting your recipients, select **Done**.
9. If you need to change any fax settings, scroll down and select your settings.
10. Press the  start button. If prompted, select where you placed your document (ADF or scanner glass).

Note: To cancel faxing, select **Cancel**.

Your product scans your original and prompts you to place additional pages, if necessary. After scanning your originals, your product dials the number and sends the fax.

Note: If the number is busy or there is a communication problem, your product displays a redialing message and will redial the number in a few minutes.

Parent topic: [Sending Faxes from the Product Control Panel](#)

Related references

[Fax Sending Options](#)

Related topics

[Placing Originals on the Product](#)

Sending a Fax at a Specified Time

You can send a fax at a time of your choice.

Note: You can only send faxes in black-and-white when you use this option.

1. Place your original on the product for faxing.
2. Press the  home button, if necessary.

3. Select **Fax**.



4. Enter a phone number or select a number from a speed or group dial list.
5. Select **Advanced Options**.
6. Select **Send Fax Later**.
7. Select **On**, use the number pad to enter your desired time, then select **Done**.
8. If you need to change any fax settings, scroll down and select your settings.
9. Press the \diamond start button. If prompted, select where you placed your document (ADF or scanner glass).

Note: To cancel faxing, select **Cancel**.

Your product scans your original and prompts you to place additional pages, if necessary.

After scanning your originals, your product dials the number and sends the fax at the specified time. You cannot send additional faxes until the timed fax has been sent.

Note: If the number is busy or there is a communication problem, your product displays a redialing message and will redial the number in a few minutes.

Parent topic: [Sending Faxes from the Product Control Panel](#)

Fax Sending Options

While sending a fax, you can select these options.

Setting	Options	Description
Resolution	Standard	Provides good scan resolution and print quality for most faxes.
	Fine	Provides best scan resolution and print quality for faxes of small print and line art.
	Photo	Provides best scan resolution and print quality for faxed photos.
Contrast	Various levels	Adjusts the contrast for faxes; negative settings make faxes lighter and positive settings make faxes darker.
2-Sided Faxing	Off	Lets you fax 2-sided originals placed in the ADF.
	On	

Parent topic: [Sending Faxes from the Product Control Panel](#)

Sending Faxes Using the Fax Utility - Windows

You can send a fax from a printing program in Windows. You can fax up to 100 pages at a time, including a cover sheet.

1. Open the file you want to fax and select the print command.

You see a window like this:

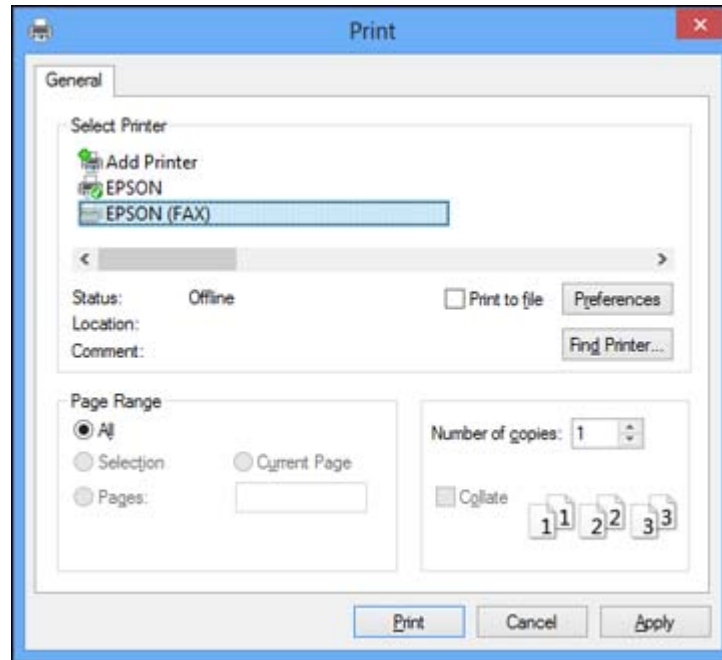

2. Select your product with the **FAX** option as the printer.
3. To change the Paper Size, Orientation, Color, Image Quality, or Character Density settings, click the **Preferences** or **Properties** button.

Note: If you see a **Setup**, **Printer**, or **Options** button, click it. Then click **Preferences** or **Properties** on the next screen. For more information about selecting fax print settings, click **Help**.

4. Select the Page Range as necessary. (Leave the Number of copies set to 1.)
5. Click **Print**.

If you're faxing for the first time, you see a window like this one:

The image shows a dialog box titled "Enter Sender Information". It contains the following fields and controls:

- Nickname: Sender1
- Name: (empty)
- Phone Number: (empty)
- Fax Number: (empty)
- Address: (empty)
- Company/Corp.: (empty)
- Division/Title: (empty)
- Buttons: OK, Cancel

6. Enter your sender information so that recipients can identify the origin of the fax. Then click **OK** to save the sender information.
7. Add a cover sheet, input a fax number, or set up a phone book of numbers for future use, then click **Next**.

Note: For detailed instructions on using the Epson FAX Utility, click **Help**.

8. If you added a cover sheet to your fax, select a cover sheet style, enter your subject and comment information, then click **Next**.
9. Click **Send** to transmit your fax.

Parent topic: [Sending Faxes](#)

Sending Faxes Using the Fax Utility - Mac OS X

You can send a fax from a Mac OS X printing program using the FAX Utility. You can fax up to 100 pages at a time, including a cover sheet.

1. Open the file you want to fax.
2. Select the print command in your application.

Note: You may need to select a print icon on your screen, the **Print** option in the **File** menu, or another command. See your application's help utility for details.



3. Select your product **FAX** option as the **Printer** setting.
4. If necessary, click the arrow next to the Printer setting or the **Show Details** button to expand the print window.
5. Select the number of pages you are faxing as the **Pages** setting.

Note: Leave the **Copies** setting set to **1**.

6. Select **Recipient Settings** from the pop-up menu.

You see this window:

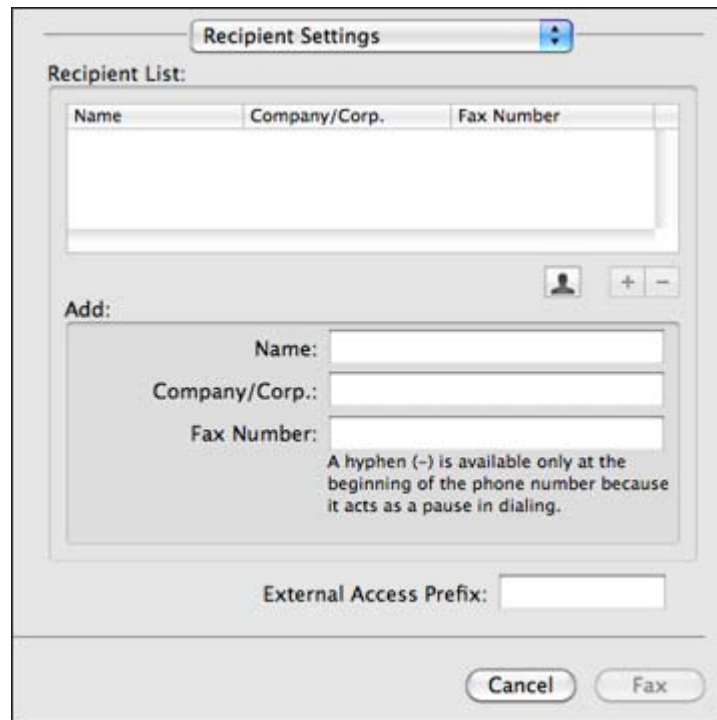

The image shows a 'Recipient Settings' dialog box. At the top, there is a title bar with the text 'Recipient Settings' and a close button. Below the title bar, the text 'Recipient List:' is followed by a table with three columns: 'Name', 'Company/Corp.', and 'Fax Number'. The table is currently empty. To the right of the table are three buttons: a person icon, a plus sign, and a minus sign. Below the table, the text 'Add:' is followed by three input fields labeled 'Name:', 'Company/Corp.:', and 'Fax Number:'. Below the 'Fax Number:' field, there is a note: 'A hyphen (-) is available only at the beginning of the phone number because it acts as a pause in dialing.' At the bottom of the dialog box, there is an 'External Access Prefix:' label followed by an input field. At the very bottom, there are two buttons: 'Cancel' and 'Fax'.

7. Do one of the following to choose your recipient:
 - Select a name or group from the **Recipient List**.
 - Enter a name, company, and fax number and click the **+** button.
 - Click the  icon and select a recipient from your address book.
8. Select **Fax Settings** from the pop-up menu.

You see this window:

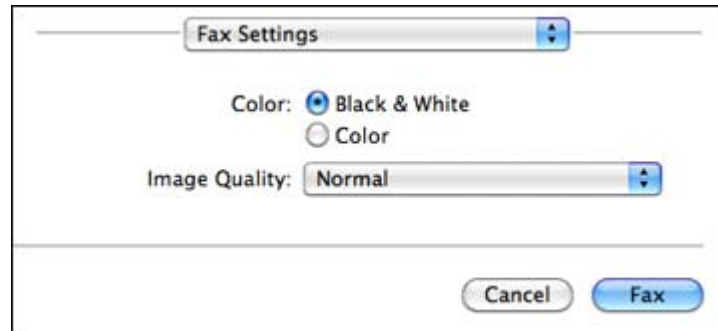

9. Select the **Color** and **Image Quality** settings you want to use for your fax.

10. Click **Fax**.

Parent topic: [Sending Faxes](#)

Receiving Faxes

See these sections to receive faxes with your product.

[Fax Reception](#)

[Receiving Faxes Automatically \(Auto Answer\)](#)

[Receiving Faxes Manually](#)

Parent topic: [Faxing](#)

Fax Reception

Your product will automatically receive and print faxes when you set fax reception to Auto Answer mode.

If you connected a telephone to your product so you can use the same phone line for faxes and voice calls, you can also set your product to receive faxes manually. This allows you to check for a fax tone using the telephone and press a button on your product to receive the fax.

Make sure to load paper in your product and select your fax settings before receiving a fax.

Note: If you run out of paper during fax printing, load more paper and press the button indicated on your product's LCD screen to continue.

Parent topic: [Receiving Faxes](#)

Receiving Faxes Automatically (Auto Answer)

To receive and print faxes automatically, you can turn on **Auto Answer** mode.

Check the  auto answer icon on your product's Home screen to see if **Auto Answer** mode is turned on or not.



To turn **Auto Answer** mode on or off, select **Setup > Fax Settings > Receive Settings > Auto Answer**.

If an answering machine is connected, make sure the product's **Rings to Answer** setting is set higher than the number of rings your answering machine is set to answer a call. For example, if the answering machine is set to pick up on the fourth ring, set the product to pick up on the fifth ring or later.

If a telephone is connected, and you use it to answer a call that turns out to be a fax, wait until the product's LCD screen displays a message that a connection has been made before hanging up.

Parent topic: [Receiving Faxes](#)

Related references

[Fax Receive Options](#)



[Fax Communications Options](#)

Related tasks

[Receiving Faxes Manually](#)

Receiving Faxes Manually

You can set up your product to receive faxes manually by turning off **Auto Answer** mode. This lets you check for a fax tone on the connected telephone before receiving a fax.

1. When the connected telephone rings, answer the call.
2. If you hear a fax tone, select **Receive** on the LCD display.
3. Press the  start button, then hang up the phone.
4. Press the  start button again to print the fax.

Parent topic: [Receiving Faxes](#)

Using Memory Cards With Your Product

Follow the instructions here to work with a memory card inserted into your product.

[Inserting a Memory Card](#)

[Printing from a Memory Card](#)

[Transferring Photos on a Memory Card](#)

Inserting a Memory Card

Insert only one memory card at a time into a memory card slot on your product.

1. Make sure the memory card and the files on it are compatible with your product before inserting the card.
2. Open the cover and insert your memory card into the correct slot, making sure the card is oriented correctly.

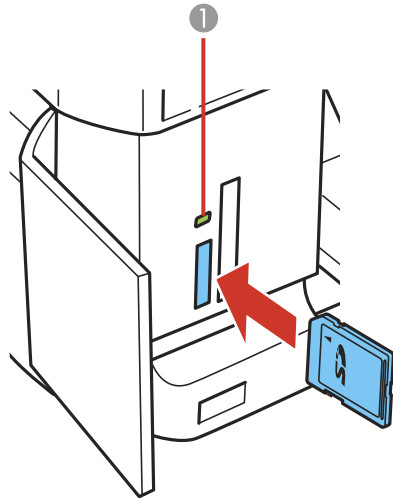

1 Memory card access light

Note: Do not force the card all the way into the slot. Insert it only until it meets resistance.

The memory card access light flashes and then stays lit.

Caution: Do not remove a memory card or turn off your product while the memory card access light is flashing or you may lose data from the memory card.

[Memory Card Types](#)

[Memory Card File Specifications](#)

[Removing a Memory Card](#)

Parent topic: [Using Memory Cards With Your Product](#)

Memory Card Types

You can insert these types of memory cards in your product.

Note: Cards marked with an asterisk (*) require an adapter; consult your adapter documentation for details on using it.

Left Slot

You can insert the following cards in the left slot:

- Memory Stick Duo
- Memory Stick PRO Duo
- Memory Stick PRO-HG Duo
- Memory Stick Micro*
- MagicGate Memory Stick Duo
- SDXC
- SDHC
- SD
- miniSDHC*
- miniSD*
- microSDXC*
- microSDHC*
- microSD*

Right Slot

You can insert the following cards in the right slot:

- CompactFlash
- Microdrive

Parent topic: [Inserting a Memory Card](#)

Memory Card File Specifications

You can insert memory cards in your product containing files that meet these specifications.

File format	JPEG with the Exif version 2.3 standard
Image size	80 × 80 pixels to 9200 × 9200 pixels
Number of files	Up to 9990

Parent topic: [Inserting a Memory Card](#)

Removing a Memory Card

After you finish working with a memory card, you can check to make sure it is safe to remove it from your product.

Caution: Do not remove a memory card or turn off your product while the memory card access light is flashing or you may lose data from the memory card.

1. Make sure the memory card access light is not flashing.

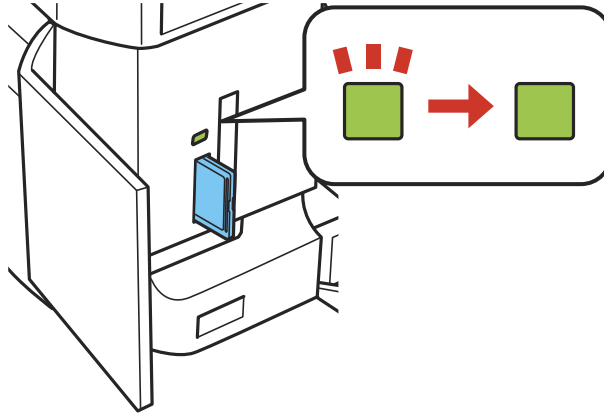

2. If your product is connected to your computer using a USB cable, do one of the following:
 - **Windows:** Open the **My Computer**, **Computer**, **Windows Explorer**, or **File Explorer** utility. Then right-click the name of your memory card (listed as a removable disk) and select **Eject**.
 - **OS X:** Drag the removable disk icon for your memory card from the desktop or computer window into the trash.
3. Pull the memory card straight out of its slot.

Parent topic: [Inserting a Memory Card](#)

Printing from a Memory Card

See these sections to print photos from a memory card inserted into your product:

[Viewing and Printing Photos](#)

[Printing Photo Layouts from a Memory Card](#)

[Printing Photo Greeting Cards](#)

Parent topic: [Using Memory Cards With Your Product](#)

Viewing and Printing Photos

See these sections to view and print photos displayed on your product's LCD screen.

[Viewing and Printing Photos](#)

[Cropping Photos Displayed on the LCD Screen](#)

[Photo Adjustment Options - Memory Card](#)

[Print Setting Options - Memory Card](#)

[Paper Type Settings - Memory Card](#)

Parent topic: [Printing from a Memory Card](#)

Viewing and Printing Photos

You can select photos for printing as you view them on the LCD screen.

1. Select **Print Photos**.



2. Do one of the following to select your photos:
 - To select individual photos, select the thumbnail image of the photo you want to print, then press **+** or **-** to select the number of copies (up to 99). Press the left or right arrow button to scroll through and select additional photos, or press the **↶** back button to return to the thumbnail image view and select another photo.
 - To select all photos, select **Options > Select Photos > Select All Photos**, then press **+** or **-** to select the number of copies (up to 99). Select **Done** when finished.
 - To select photos based on the date they were taken, select **Options > Select Photos > Select by Date**, then select any of the dates shown. Select **Proceed**, then press **+** or **-** to select the number of copies (up to 99). Select **Done** when finished.

3. To adjust your photos, do either of the following as necessary (adjustments modify only your printed copy, not the original file):
 - To crop, zoom into, or rotate a photo, select the thumbnail image of the photo you want to modify, then select **Edit > Crop/Zoom**. Make the necessary adjustments, select **OK**, then **Done** when finished.
 - To change the appearance (e.g., brightness and contrast) of your printed photos, select the thumbnail image of a photo, select **Edit > Photo Adjustments**, and select the necessary settings. When you are finished, press the ↩ back button twice.
4. To change the print settings, select **Settings**, then select the necessary settings. When you are finished, press the ↩ back button.
5. When you are ready to print, press the ⬠ start button.

Note: To cancel printing, select **Cancel**.

Parent topic: [Viewing and Printing Photos](#)

Related references

[Photo Adjustment Options - Memory Card](#)

[Print Setting Options - Memory Card](#)

Related tasks

[Cropping Photos Displayed on the LCD Screen](#)

Cropping Photos Displayed on the LCD Screen

If you want to crop or rotate photos displayed on the LCD screen, select the thumbnail image of the photo you want to modify, select **Edit > Crop/Zoom**, and select the necessary options.

- To crop the photo, press **+** to move the yellow crop area inward or **-** to move the crop area outward.
- To move the crop area, press the arrow buttons.
- To rotate the crop area, press **↻**.
- To check the cropped image, press **OK**.

Parent topic: [Viewing and Printing Photos](#)

Photo Adjustment Options - Memory Card

Select the **Photo Adjustment** options you want to use when viewing and printing photos displayed on the LCD screen. The modifications affect only the printed copy of the photo, not the original file.

Photo Adjustment settings	Available options	Description
Fix Photo	Fix Photo On	Automatically adjusts the brightness, contrast, and saturation of the photo based on the Scene Detection setting that is selected.
	Fix Photo Off	Turns off automatic adjustments; see Note below
	P.I.M.	Uses your camera's PRINT Image Matching or Exif Print adjustments
Scene Detection	Automatic	Optimizes the Fix Photo adjustments for specific types of photos; select the option that best matches your photo content
	People	
	Landscape	
	Night Scene	
Fix Red-Eye	Off - Current	Automatically fixes the red-eye effect in photos
	On - Current	
	Off - All Photos	
	On - All Photos	
Filter	Sepia	Applies a sepia tone filter to the viewed or printed photo
	B&W	Applies a black-and-white filter to the viewed or printed photo
Brightness	Various settings	Adjust individual qualities in your photo
Contrast		
Sharpness		
Saturation		

Note: **Fix Photo** uses a sophisticated face recognition technology to optimize photos that include faces. For this to work, both eyes and the nose must be visible in the subject's face. If your photo includes a face with an intentional color cast, such as a statue, you may want to turn off **Fix Photo** to retain the special color effects.

Parent topic: [Viewing and Printing Photos](#)

Print Setting Options - Memory Card

Select the **Print Settings** options you want to use when printing photos displayed on the LCD screen.

Print settings	Available options	Description
Paper Size	Various paper sizes	Indicates the size of paper you have loaded
Paper Type	Various paper types	Indicates the type of paper you have loaded; see the list of paper types for memory card (available options depend on the selected Paper Size setting)
Paper Source	Cassette 1	Prints onto paper loaded in Cassette 1 (upper cassette)
	Cassette 2	Prints onto paper loaded in Cassette 2 (lower cassette)
	Cassette 1>Cassette 2	Prints onto paper loaded in Cassette 1 and then onto paper loaded in Cassette 2 when the first cassette is empty (load the same size and type of paper in both cassettes when selecting this option)
	Rear Paper Feed Slot	Prints onto paper loaded in the rear paper feed slot
Borderless	Borderless	Expands the image to the edge of the paper (slight cropping may occur)
	With Border	Leaves a small margin around the image
Quality	Draft	Provides lower quality for draft printing
	Standard Quality	Provides good quality for most prints
	Best	Provides the highest quality for important prints
Expansion	Standard	Expands images correctly for most borderless prints
	Medium	Expands images slightly less for borderless prints
	Minimum	Expands images the least for borderless prints (you may see some white border)
Date	Various date formats	Prints the date the photo was taken on the photo in the format you select

Print settings	Available options	Description
Print Info. On Photos	Camera Settings	Prints settings that you added in your camera
	Camera Text	Prints text that you added in your camera
	Landmark	Prints location information embedded in a photo by cameras that have a built-in GPS feature
Fit Frame	On	Automatically crops the photo to fit into the selected photo layout
	Off	Turns off automatic cropping
Bidirectional	On	Prints at normal speed
	Off	Slows down printing to improve print quality
Clear All Settings	Yes	Clears all print settings.
	No	

Parent topic: [Viewing and Printing Photos](#)

Related references

[Paper Type Settings - Memory Card](#)

Paper Type Settings - Memory Card

Select a **Paper Type** setting that matches the paper you loaded.

Paper type loaded	Paper Type setting
Plain paper Epson Bright White Paper Epson Presentation Paper Matte Epson Iron-on Cool Peel Transfer paper Epson Photo Quality Self-adhesive Sheets	Plain Paper
Epson Premium Presentation Paper Matte Epson Ultra Premium Presentation Paper Matte Epson Premium Presentation Paper Matte Double-sided	Matte

Paper type loaded	Paper Type setting
Epson Premium Photo Paper Glossy Epson Premium Photo Paper Semi-gloss Epson Ultra Premium Photo Paper Luster	Prem. Glossy
Epson Ultra Premium Photo Paper Glossy	Ultra Glossy
Epson Photo Paper Glossy	Glossy
Epson Velvet Fine Art Paper	Velvet Fine Art Paper

Parent topic: [Viewing and Printing Photos](#)

Printing Photo Layouts from a Memory Card

You can print one or more photos from a memory card in special layouts on various sizes of photo paper.

1. Press the  home button, if necessary.
2. Select **More Functions**.



3. Select **Photo Layout Sheet**.

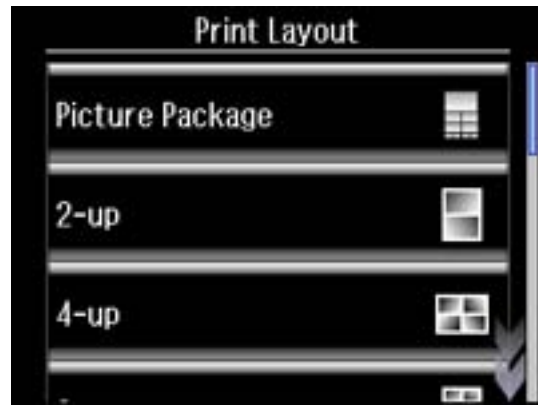

4. Scroll down to view all of the layout options, then select the option you want.
5. Select the paper size and paper type that matches the paper you loaded, then select **Proceed**.
6. If you see a screen asking you to choose between automatic and manual placement of photos, do one of the following:
 - Select **Automatic layout** if you want to allow your product to place the photos in the layout automatically.
 - Select **Place photos manually** to place photos in the layout manually.
7. Select the photos you want to print, then select **Proceed**. If you chose to place the photos manually, follow the instructions on the LCD screen to select and place your photos on the layout, then select **Proceed**.
8. Press **+** or **-** to select the number of layout sheets to print (up to 99), then select **Proceed**.
9. Select additional print settings for your layout as necessary.
10. When you are ready to print, press the **⬠** start button.

Note: To cancel printing, select **Cancel**.

[Photo Layout Options](#)

Parent topic: [Printing from a Memory Card](#)

Photo Layout Options

Select the layout you want to use when printing your photos in a layout.

Picture Package

Prints one photo in multiple sizes on one sheet.

2-up, 4-up, 8-up, or 20-up

Print 2, 4, 8, or 20 photos on one sheet.

Upper ½ or Lower ½

Print one photo in the upper or lower half of the sheet.

Photo ID

Prints 4 ID-sized photos on one sheet.

Jewel Upper

Prints one photo on the upper half of a folded jewel case insert.

Jewel Index

Prints 24 to 48 thumbnail images on a folded jewel case insert.

Parent topic: [Printing Photo Layouts from a Memory Card](#)

Printing Photo Greeting Cards

You can create custom greeting cards using photos on your memory card or other device, and add your own handwritten or printed text.

First you select your photo and print a template on plain paper. Then you fill out the template, add your message, and print your cards.

[Creating and Printing a Greeting Card Template](#)

[Printing a Greeting Card from a Template](#)

Parent topic: [Printing from a Memory Card](#)

Creating and Printing a Greeting Card Template

Before you start, make sure plain paper is loaded and your memory card is inserted.

1. Press the  home button, if necessary.

2. Select **More Functions**.



3. Select **Greeting Card**.



4. Select **Select Photo and Print Template**.
5. Select the photo you want, then select **Proceed**.
6. Select **Paper Size**, then select **Letter** to print three cards on one letter-size sheet or **4x6in** to print one card.
7. Select **Paper Type**, then select the type of paper you plan to use.
8. Select the other print settings as necessary, then select **Proceed**.

9. When you are ready to print your greeting card template on plain paper, press the \diamond start button.

Parent topic: [Printing Photo Greeting Cards](#)

Related tasks

[Inserting a Memory Card](#)

Related topics

[Loading Paper](#)

Printing a Greeting Card from a Template

After your greeting card template is printed, you fill it out to create your card and add your message.

1. Use a dark pen or pencil to fill in the circles and select the Text Style and Text Effects.

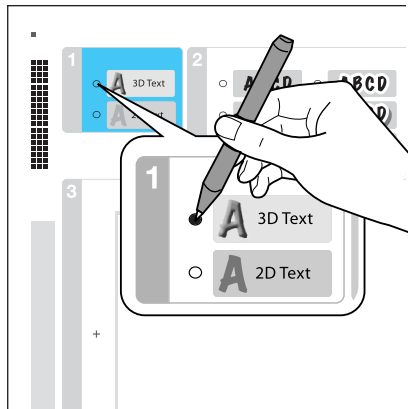

2. Add your greeting card message within the box. You can write it in by hand, print a message and paste it into the box, or draw a picture.

Tip: When adding text, place it in the direction that your photo faces.

3. Load photo paper either in Cassette 2 (lower) for this size: Letter (8.5 × 11 inches [216 × 279 mm]), or in Cassette 1 (upper) for this size: 4 × 6 inches (102 × 152 mm).

4. Select **Print Greeting Cards from Template**. (If you don't see the option, press the \uparrow home button and select **More Functions** > **Greeting Card** > **Print Greeting Cards from Template**.)

5. Follow the instructions on the LCD screen to place the template facedown on the scanner glass, with the blue triangle facing into the front right corner.

6. Close the document cover, then select **Proceed**.
7. To print more than one copy, press **+** or **-** to select the number (up to 99).
8. When you are ready to print, press the  start button.

Note: To cancel printing, select **Cancel**.

When you finish printing, cut your greeting cards apart, if necessary.

Parent topic: [Printing Photo Greeting Cards](#)

Related tasks

[Creating and Printing a Greeting Card Template](#)

Transferring Photos on a Memory Card

You can transfer photos to and from a memory card inserted into a memory card slot on your product.

[Setting Up File Sharing for Photo Transfers From Your Computer](#)

[Transferring Photos from a Memory Card to Your Computer](#)

Parent topic: [Using Memory Cards With Your Product](#)

Setting Up File Sharing for Photo Transfers From Your Computer

Before you transfer photos from a computer to a memory card inserted into a memory card slot on your product, you may need to set up your product's file sharing settings.

1. Remove any memory cards from the product.

Caution: Remove the memory card before you change the file sharing settings or you may lose data from the memory card. Do not remove a memory card or turn off your product while the memory card access light is flashing or you may lose data from the memory card.

2. Press the  home button, if necessary.
3. Press the left or right arrow button and then select **Setup**.
4. Scroll down and select **File Sharing Setup**.
5. Select the connection type between the printer and your computer.

Parent topic: [Transferring Photos on a Memory Card](#)

Related tasks

[Removing a Memory Card](#)

Transferring Photos from a Memory Card to Your Computer

You can transfer photos to and from a memory card inserted into a memory card slot on your product and a computer connected to your product.

Note: Do not transfer photos to and from a memory card while you are printing from the memory card.

1. Make sure your product is connected to a computer.
2. Insert a memory card into a memory card slot on your product.
3. Do one of the following to access your memory card files from your computer:
 - **Windows:** Open the **Computer**, **My Computer**, **Windows Explorer**, or **File Explorer** utility, then select the removable disk icon.
 - **Mac OS X with a USB connection:** Look for the removable disk icon on your desktop or computer window, then select it.
 - **Mac OS X with a network connection:** Select the hard drive icon on your desktop or computer window, select your product in the **SHARED** section of the sidebar (you may need to widen the sidebar to see the name), then select the **MEMORYCARD** icon.
4. Select the folder that contains your photos.
5. Drag the photos you want to transfer to the desired folder on your computer or on your memory card.

Note: Your product's LCD screen does not update to display new photos transferred to the memory card. Wait until the memory card access light stops flashing, then remove and insert the memory card to update the photos displayed.

Parent topic: [Transferring Photos on a Memory Card](#)

Related tasks

[Inserting a Memory Card](#)

[Removing a Memory Card](#)

Using an External Device with Your Product

Follow the instructions in these sections to use your product with an external device, such as a camera, smartphone, or other device.

[Printing from a Camera Connected to Your Product](#)

[Viewing or Printing from a USB Flash Drive or External Device](#)

Printing from a Camera Connected to Your Product

If you have a digital camera that supports PictBridge printing, you can connect it to the product and print your photos directly from the camera. Check your camera manual to see if it is compatible.

Note: Your photos must be in JPG format and sized from 80 × 80 to 9200 × 9200 pixels. Epson cannot guarantee the compatibility of your camera. Some combinations of paper type, size, and layout may not be supported, depending on your camera and the product settings.

[Selecting Print and Photo Adjustment Settings](#)

[Connecting and Printing from a Camera](#)

Parent topic: [Using an External Device with Your Product](#)

Selecting Print and Photo Adjustment Settings

Before printing from your camera, you can make image adjustments and select the print settings for your photos. Image adjustments affect only the printed copy of the photo, not the original file.

1. Press the  home button, if necessary.

2. Press the left or right arrow button and then select **Setup**.



3. Scroll down and select **External Device Setup**.

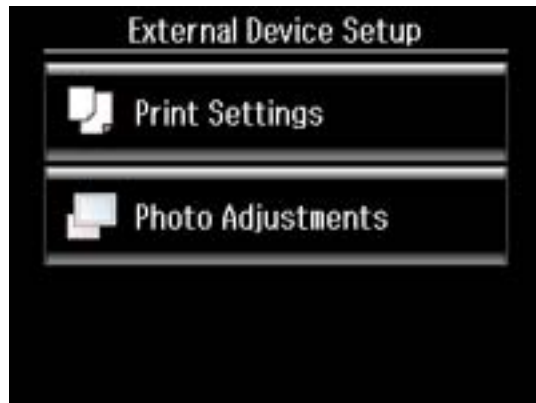

4. Select **Print Settings**.

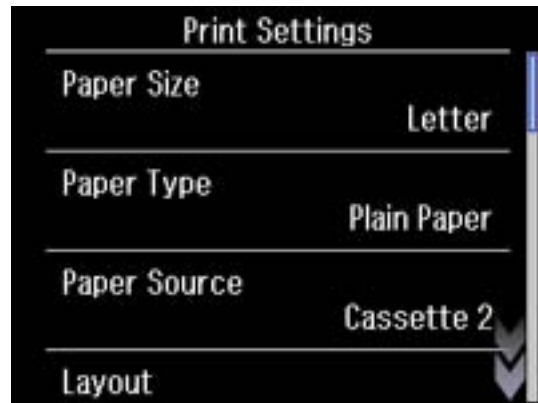

5. Select the print settings you want to use.
6. When you are done, press the ↩ back button.
7. Select **Photo Adjustments**.

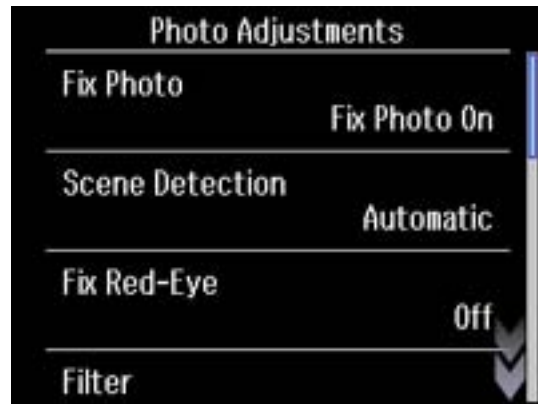

8. Select the photo adjustments you want to use, then press the 🏠 home button to exit.
After you select settings, you are ready to connect your camera and print your photos.
[Print Settings - Camera](#)

Photo Adjustments - Camera

Parent topic: [Printing from a Camera Connected to Your Product](#)

Print Settings - Camera

Select the **Print Settings** options you want to use when printing photos from your camera.

Print settings	Available options	Description
Paper Size	Various paper sizes	Indicates the size of paper you have loaded
Paper Type	Various paper types	Indicates the type of paper you have loaded; see the list of paper types for copying (available options depend on the selected Paper Size setting)
Paper Source	Cassette 1	Prints onto paper loaded in Cassette 1 (upper cassette)
	Cassette 2	Prints onto paper loaded in Cassette 2 (lower cassette)
	Cassette 1> Cassette 2	Prints onto paper loaded in Cassette 1 and then onto paper loaded in Cassette 2 when the first cassette is empty (load the same size and type of paper in both cassettes when selecting this option)
	Rear Paper Feed Slot	Prints onto paper loaded in the rear paper feed slot

Print settings	Available options	Description
Layout	Borderless	Expands the image to the edge of the paper (slight cropping may occur)
	With Border	Leaves a small margin around the image
	Picture Package	Prints one photo in multiple sizes on one sheet
	1-up, 2-up, 4-up, 8-up, 20-up, 30-up, 80-up, or Variety	Prints the selected number of photos on one sheet or CD/DVD
	Upper ½ or Lower ½	Print one photo in the upper or lower half of the sheet
	Jewel Upper	Prints one photo on the upper half of a folded jewel case insert
	Jewel Index	Prints 24 to 48 thumbnail images on a folded jewel case insert
Quality	Draft	Provides lower quality for draft printing
	Standard Quality	Provides good quality for most prints
	Best	Provides the highest quality for important prints
Expansion	Standard	Expands images correctly for most borderless prints
	Medium	Expands images slightly less for borderless prints
	Minimum	Expands images the least for borderless prints (you may see some white border)
Date	Off	Does not print the date on which the photo was taken
	On	Prints the date on which the photo was taken
Print Info. on Photos	Camera Settings	Prints your camera's shutter speed, aperture, and ISO speed
	Camera Text	Prints text that you added in your camera
	Landmark	Prints location information embedded in a photo by cameras that have a built-in GPS feature

Print settings	Available options	Description
Fit Frame	On	Automatically crops the photo to fit into the selected photo layout
	Off	Turns off automatic cropping
Bidirectional	On	Prints at normal speed
	Off	Slows down printing to improve print quality
CD Inner/Outer	Range of measurements	Selects inner and outer diameter for printing on CDs/DVDs from your camera
CD Density	Standard Density	Adjusts the print density when printing on CDs/DVDs from your camera
	Darker	
	Darkest	

Parent topic: [Selecting Print and Photo Adjustment Settings](#)

Related references

[Paper Type Settings - Copying](#)

Photo Adjustments - Camera

Select the **Photo Adjustments** options you want to use when printing photos from your camera. The modifications affect only the printed copy of the photo, not the original file.

Photo Adjustments settings	Available options	Description
Fix Photo	Fix Photo On	Automatically adjusts the brightness, contrast, and saturation of the photo based on the Scene Detection setting that is selected
	Fix Photo Off	Turns off automatic adjustments; see Note below
	P.I.M	Uses your camera's PRINT Image Matching or Exif Print adjustments

Photo Adjustments settings	Available options	Description
Scene Detection	Automatic	Optimizes the Fix Photo adjustments for specific types of photos; select the option that best matches your photo content
	People	
	Landscape	
	Night Scene	
Fix Red-Eye	Off	Does not automatically fix the red-eye effect in photos
	On	Automatically fixes the red-eye effect in photos
Filter	Off	Turns off the filter setting
	Sepia	Applies a sepia tone filter to the viewed or printed photo
	B&W	Applies a black-and-white filter to the viewed or printed photo
Brightness	Various settings	Adjust individual qualities in your photo
Contrast		
Sharpness		
Saturation		

Note: **Fix Photo** uses a sophisticated face recognition technology to optimize photos that include faces. For this to work, both eyes and the nose must be visible in the subject's face. If your photo includes a face with an intentional color cast, such as a statue, you may want to turn off **Fix Photo** to retain the special color effects.

Parent topic: [Selecting Print and Photo Adjustment Settings](#)

Connecting and Printing from a Camera

Before you connect your camera, make sure the product is turned on but not printing.

1. Remove any memory cards from the product.
2. Load the paper you want to use for printing.

3. Connect the USB cable that came with your camera to the  USB port on the front of your product.

Note: You cannot use the USB port to transfer images from your camera to your computer.

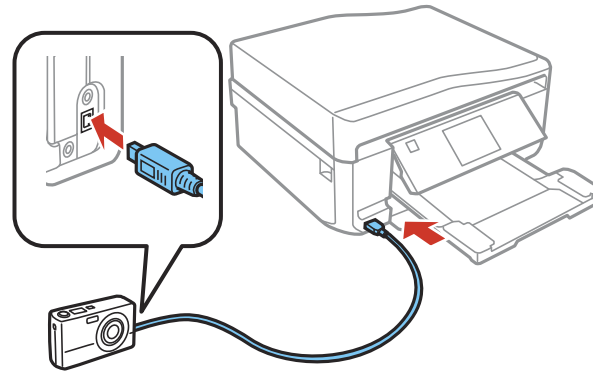

4. Turn on your camera.
 5. Follow the instructions that came with your camera to select and print your photos.
- When you finish printing, turn off your camera and disconnect it from the product.

Parent topic: [Printing from a Camera Connected to Your Product](#)

Related tasks

[Removing a Memory Card](#)

Related topics

[Loading Paper](#)

Viewing or Printing from a USB Flash Drive or External Device

You can view and print photos from a USB thumb drive or other external storage device, such as an external hard drive or CD/DVD burner.

Note: Make sure the files on your device are compatible with the product.

[USB Device File Specifications](#)

[Connecting and Using a USB Flash Drive or External Device](#)

Parent topic: [Using an External Device with Your Product](#)

Related tasks

[Removing a Memory Card](#)

Related topics

[Loading Paper](#)

[Viewing and Printing Photos](#)

USB Device File Specifications

You can print external device files that meet these specifications.

File format	JPEG with the Exif version 2.3 standard
Image size	80 × 80 pixels to 9200 × 9200 pixels
Number of files	Up to 9990

Parent topic: [Viewing or Printing from a USB Flash Drive or External Device](#)

Connecting and Using a USB Flash Drive or External Device

Before you connect your thumb drive or device, make sure the product is turned on but not printing.

Note: Epson cannot guarantee the compatibility of your drive.

1. Remove any memory cards from the product.
2. Load the paper you want to use for printing.
3. Insert your USB thumb drive or the USB cable that came with your device into the  USB port on the front of your product.
4. Insert storage media (such as a CD) into your drive, if necessary.
5. Select the photos to print from the LCD screen.

When you finish printing, make sure the access light on the drive is not flashing, then remove or disconnect it from the product.

Caution: Do not remove the USB drive or turn off the product when the access light is flashing, or you may lose photos on the drive.

Parent topic: [Viewing or Printing from a USB Flash Drive or External Device](#)

Printing Personalized Projects

You can turn any photo or drawing into a coloring book page, or print lined paper, graph paper, or stationery with a photo background.

[Printing Coloring Book Pages](#)

[Printing Personalized Note Paper](#)

[Printing Lined Paper and Graph Paper](#)

Printing Coloring Book Pages

You can create a coloring book page from a photo on your memory card, or from a photo or drawing placed on the scanner glass.

1. Load one of these types of paper in either Letter (8.5 × 11 inches [216 × 279 mm]) or A4 (8.3 × 11.7 inches [210 × 297 mm]) size:
 - Plain paper
 - Epson Bright White Paper
 - Epson Presentation Paper Matte
 - Epson Premium Presentation Paper Matte
 - Epson Velvet Fine Art Paper (letter-size only)
2. Press the  home button, if necessary.
3. Select **More Functions**.



4. Scroll down and select **Coloring Book**.

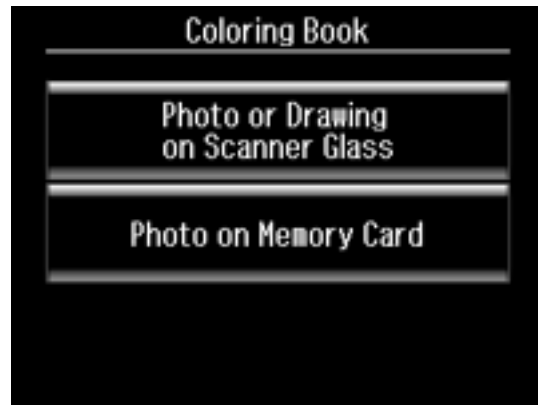

5. Do one of the following:
 - Select **Photo or Drawing on Scanner Glass** to print a design from an original placed facedown on the scanner glass, in the front right corner.
 - Select **Photo on Memory Card** to print a design from a memory card inserted in your product, then select a photo.
6. Select **Proceed**.
7. Select **Paper Settings** and select the size and type of paper that you loaded.
8. Select **Paper Source** and select where you loaded your paper.
9. If necessary, adjust the following settings:
 - **Density** to make the print lighter or darker
 - **Line Detection** to change the amount of detail in the print
10. When you are ready to print, press the  start button.

Note: To cancel printing, select **Cancel**.

Parent topic: [Printing Personalized Projects](#)

Related tasks

[Inserting a Memory Card](#)

Related topics

[Loading Paper](#)

[Placing Originals on the Product](#)

Printing Personalized Note Paper

You can print lined or unlined note paper with one of your own photos in the background.

1. Load plain paper in either Letter (8.5 × 11 inches [216 × 279 mm]) or A4 (8.3 × 11.7 inches [210 × 297 mm]) size.
2. Insert a memory card into your product's memory card slot.
3. Press the  home button, if necessary.
4. Select **More Functions**.



5. Scroll down and select **Print Ruled Papers**.

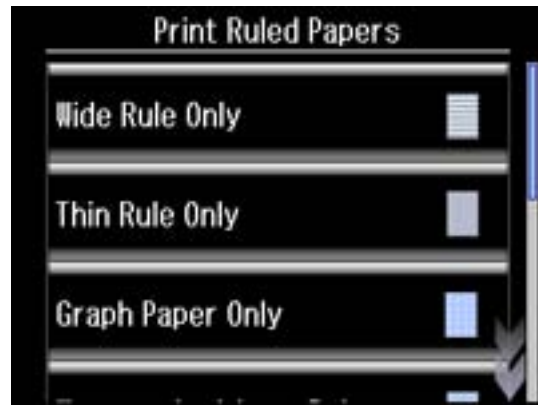

6. Scroll down and select one of the following settings:

- **Watermark without Rule**
- **Watermark Horizontal Rule**
- **Watermark Vertical Rule**

Note: View the thumbnails next to each option to preview the design layout.

7. Select the size of paper you loaded.
8. Select the photo you want to use for your note paper, then select **Proceed**.

Note: To rotate the layout, select **Rotate**.

9. When you see a message asking you to load paper, select **Proceed**.
10. To print more than one sheet, press **+** or **-** to select the number (up to 99).
11. When you are ready to print, press the **◇** start button.

Note: To cancel printing, select **Cancel**.

Parent topic: [Printing Personalized Projects](#)

Related tasks

[Inserting a Memory Card](#)

Related topics

[Loading Paper](#)

Printing Lined Paper and Graph Paper

You can print wide-rule or narrow-rule notebook paper and graph paper.

1. Load plain paper in either Letter (8.5 × 11 inches [216 × 279 mm]) or A4 (8.3 × 11.7 inches [210 × 297 mm]) size.
2. Press the  home button, if necessary.
3. Select **More Functions**.



4. Scroll down and select **Print Ruled Papers**.

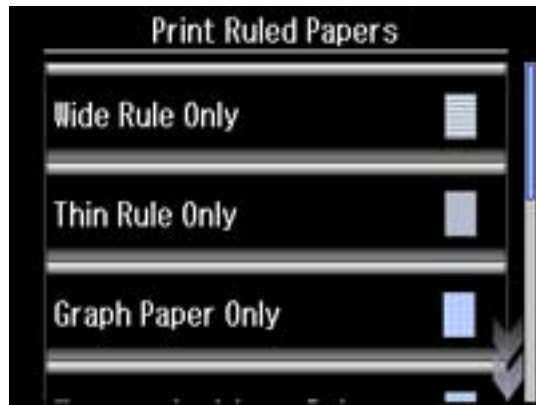

5. Select one of the following settings:

- **Wide Rule Only**
- **Thin Rule Only**
- **Graph Paper Only**

Note: View the thumbnails next to each option to preview the design layout.

6. Select the size of paper you loaded.
7. When you see a message asking you to load paper, select **Proceed**.
8. To print more than one sheet, press **+** or **-** to select the number (up to 99).
9. When you are ready to print, press the **◇** start button.

Note: To cancel printing, select **Cancel**.

Parent topic: [Printing Personalized Projects](#)

Related topics

[Loading Paper](#)

Printing on CDs/DVDs

Follow the instructions here to print a design onto ink jet-printable CDs or DVDs to create a custom label.

[CD/DVD Printing Features](#)

[Loading a CD/DVD](#)

[Removing a Printed CD/DVD](#)

[Placing a CD/DVD on the Scanner Glass](#)

[Copying onto a CD/DVD](#)

[Printing Photos from a Memory Card Onto a CD/DVD](#)

[Printing a Jewel Case Insert from a Memory Card](#)

[Printing on CDs/DVDs from a Computer](#)

CD/DVD Printing Features

You can use any of the following features to print custom CD/DVD labels and accessories:

- Copy an existing CD/DVD label onto a new CD/DVD
- Use your product's control panel to print photos from a memory card onto a CD/DVD
- Print text and images from your computer using the Epson Print CD software

You can also use your product's control panel to create a jewel case insert with photos from a memory card.

Parent topic: [Printing on CDs/DVDs](#)

Related tasks

[Copying onto a CD/DVD](#)

[Printing Photos from a Memory Card Onto a CD/DVD](#)



[Printing a Jewel Case Insert from a Memory Card](#)

Loading a CD/DVD

You can print on any compatible, ink jet-printable CDs or DVDs, including Blu-ray Discs.

Caution: Do not insert the CD/DVD tray while the product is printing, copying, or performing other operations. Otherwise, your product may be damaged or the surface of the CD/DVD may become dirty or scratched.

Note: If you are using discs where the printable area extends to within 0.16 inch (4 mm) of the center hole, you may need to adjust the inner diameter setting using the control panel or Epson Print CD software.

1. Burn your files, music, or video onto your disc before printing on it.
2. Press the  home button, if necessary.
3. Press the  CD button and select **Load CD/DVD**.
4. When you see a message asking if you want to prepare for CD loading, select **Yes**.
5. Raise the control panel all the way up.

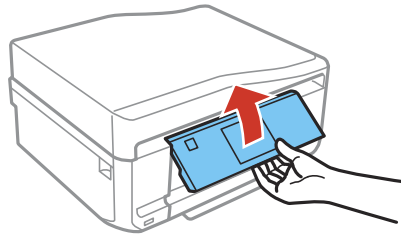

6. Make sure nothing is on the output tray, then close it.

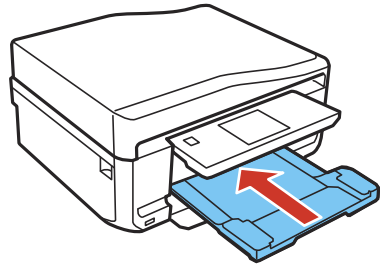

7. Close the front cover.

8. Remove the CD/DVD tray from the bottom of the product.

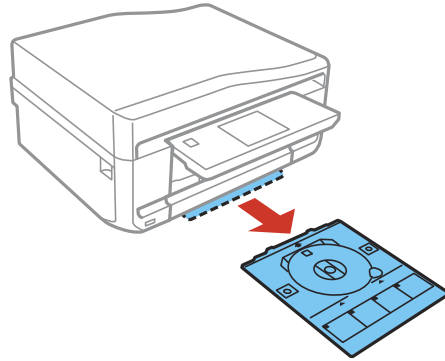

9. Place a CD or DVD on the CD/DVD tray with the printable side faceup, and insert the tray into the slot above the output tray.

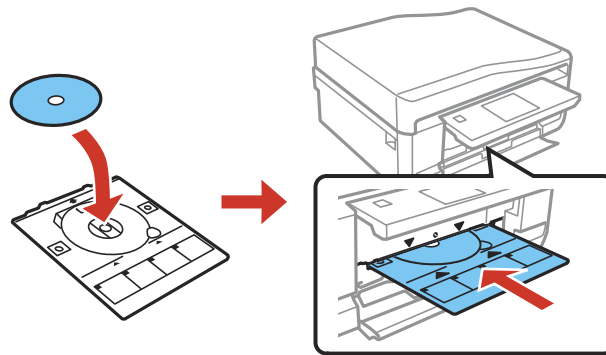

Note: Make sure the ▲ marks on the tray and the ▼ marks on the product line up.

10. Select **Ready** > **OK** on the touch panel.

Note: The CD/DVD tray ejects automatically after a certain period of time.

Caution: Do not turn off the product with a CD or DVD loaded in it. Always remove the disc first.

Parent topic: [Printing on CDs/DVDs](#)

Removing a Printed CD/DVD

After your CD or DVD is printed, the tray extends automatically.

1. Pull the CD/DVD tray out of the product, and then remove your CD or DVD from the tray.

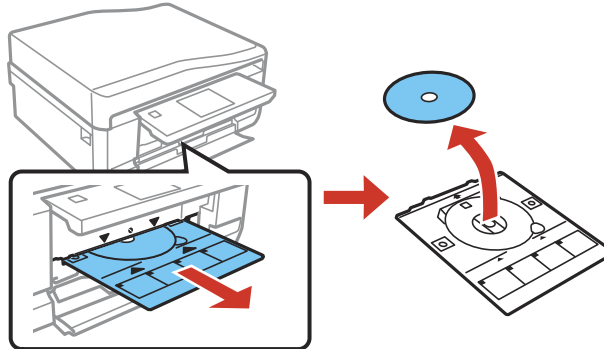

2. Insert the CD/DVD tray into the storage slot on the bottom of the product.

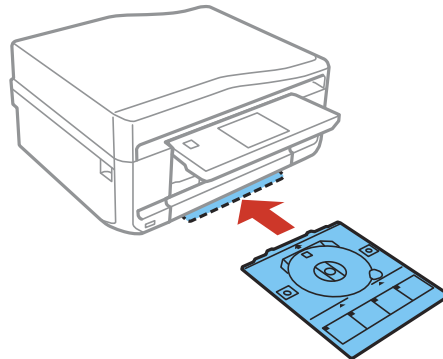

After printing, handle the CD or DVD carefully. You may need to wait up to 24 hours for the ink to dry fully before inserting it in a drive, depending on the type of disc you used. Keep printed discs away from moisture and direct sunlight.

Parent topic: [Printing on CDs/DVDs](#)

Placing a CD/DVD on the Scanner Glass

You can place a CD or DVD on the scanner glass and copy the label design onto another CD or DVD.

1. Open the document cover.
2. Place your CD or DVD facedown in the center of the scanner glass.

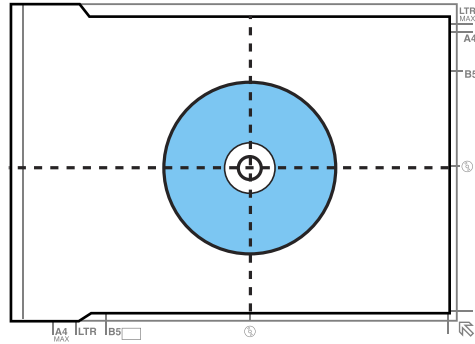



3. Close the document cover gently to keep your disc in place.

Parent topic: [Printing on CDs/DVDs](#)

Copying onto a CD/DVD

You can copy a printed photo or CD/DVD label directly onto an ink jet-printable CD or DVD. If you want, you can first print a test design on plain paper.

1. Load the CD, DVD, or plain paper you want to print on.
2. Press the  home button, if necessary.
3. Press the  CD button.
4. Select **CD/DVD Copy**.
5. Follow the instructions on the LCD screen to place your original CD, DVD, or photo on the scanner glass, then select **Proceed**.
6. If necessary, adjust the inner and outer diameter of your CD as shown on the screen, then select **Proceed**.

You see this screen:

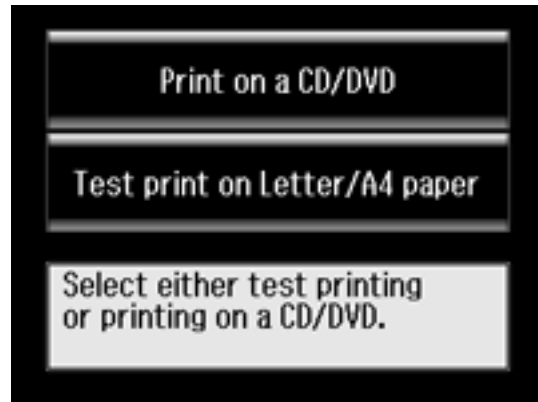

7. Select one of the options shown on the screen to print on a CD/DVD or a test print on plain paper. If printing on plain paper, select **Proceed**.
8. Select any copy settings as needed.

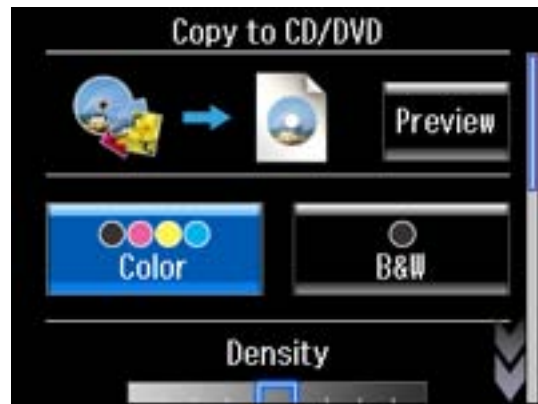

9. When you are ready to print, press the  start button.

Note: To cancel printing, select **Cancel**.

Parent topic: [Printing on CDs/DVDs](#)

Related tasks

[Loading a CD/DVD](#)

[Placing a CD/DVD on the Scanner Glass](#)



Related topics

[Loading Paper](#)

[Placing Originals on the Product](#)

Printing Photos from a Memory Card Onto a CD/DVD

You can print one or more photos from a memory card directly onto a CD/DVD. If you want, you can first print a test design on plain paper.

1. Insert a memory card into a memory card slot on your product.
2. Load the CD, DVD, or plain paper you want to print on.
3. Press the  home button, if necessary.
4. Press the  CD button.
5. Select **Print on CD/DVD**.

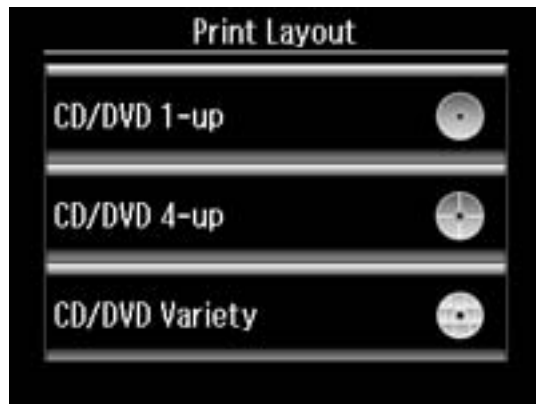

6. Select a layout.
7. Follow the instructions on the screen to select your photo or photos.
8. When you see the screen to adjust the inner and outer diameter of your CD, adjust the settings if necessary, then select **Proceed**.

You see this screen:

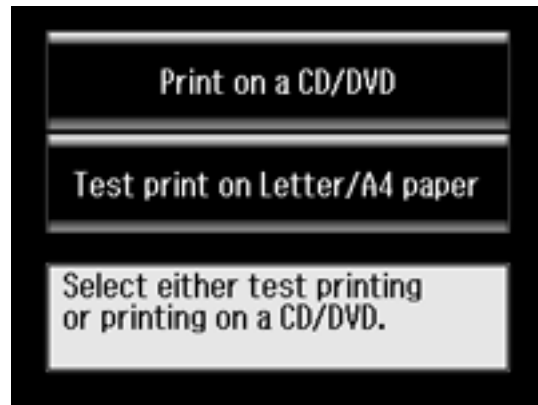

9. Select one of the options shown on the screen to print on a CD/DVD or a test print on plain paper. If printing on plain paper, select **Proceed**.
10. Adjust the **CD Density** setting if necessary, then press the \diamond start button to print.

Note: To cancel printing, select **Cancel**.

Parent topic: [Printing on CDs/DVDs](#)

Related tasks

[Loading a CD/DVD](#)

[Inserting a Memory Card](#)

Related topics

[Loading Paper](#)

Printing a Jewel Case Insert from a Memory Card

You can print a photo from a memory card, automatically sized to fit on a CD/DVD jewel case insert. You can also print thumbnail images formatted to fit on a jewel case insert. After the insert is printed, you can cut and fold it to fit.

1. Insert a memory card into a memory card slot on your product.
2. Load the paper you want to print on.

3. Press the  home button, if necessary.
4. Select **More Functions**.



5. Select **Photo Layout Sheet**.

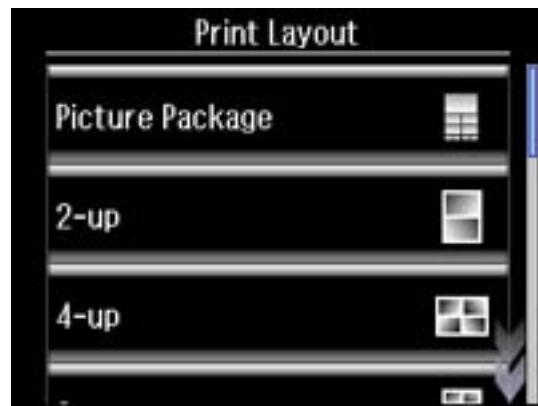

6. Scroll down and then select one of the following:
 - **Jewel Upper** to print one photo on the upper half of the insert.
 - **Jewel Index** to print 24 or 48 thumbnail images on the insert.
7. Select your paper size and type, then select **Proceed**.

8. Follow the instructions on the LCD display to select your photos and set the number of copies.
9. When you see the Print Settings screen, change your print settings if necessary.
10. When you are ready to print, press the  start button.

Note: To cancel printing, select **Cancel**.

11. After your insert is printed, cut and fold it following the crop lines.

Parent topic: [Printing on CDs/DVDs](#)

Related tasks

[Inserting a Memory Card](#)

Related topics

[Loading Paper](#)

Printing on CDs/DVDs from a Computer

Before printing directly on CDs or DVDs from your computer, make sure you have set up your product as described on the *Start Here* sheet, and installed the Epson Print CD software.

[Printing on a CD/DVD with Windows](#)

[Printing on a CD/DVD with Mac OS X](#)

Parent topic: [Printing on CDs/DVDs](#)

Related tasks

[Loading a CD/DVD](#)

Printing on a CD/DVD with Windows

You can print with your product using the Epson Print CD software, as described in these sections.

[Designing a CD/DVD - Windows](#)

[Printing Your CD/DVD Design - Windows](#)

[Adjusting CD/DVD Print Position - Windows](#)

[Adjusting CD/DVD Print Quality - Windows](#)

Parent topic: [Printing on CDs/DVDs from a Computer](#)

Designing a CD/DVD - Windows

You can use Epson Print CD to design your disc by importing photos, adding text, and creating special effects.

1. Open the Epson Print CD program on your computer.

You see this screen:

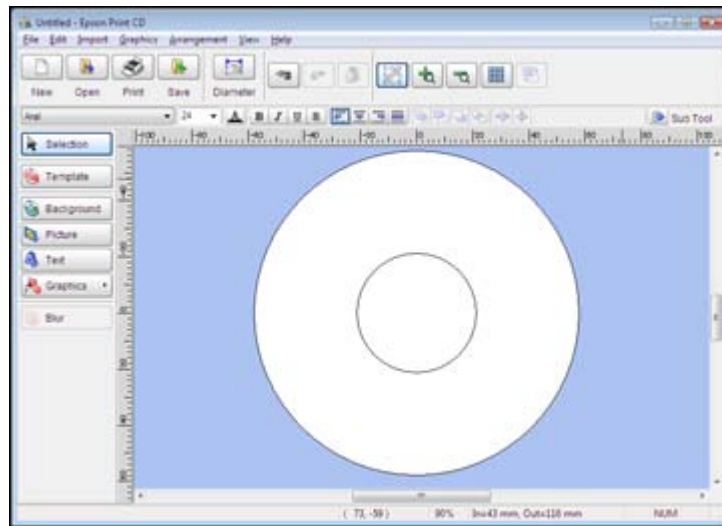

2. Use the buttons on the left side of the screen to select a pre-designed template or add a background image, picture, text, or graphic elements. For more information, select the **Help** menu.
3. When you are finished creating your design, click **Save** and save your design file.

Parent topic: [Printing on a CD/DVD with Windows](#)

Printing Your CD/DVD Design - Windows

After you create your design, you can print it on paper to test it, then print it on the CD or DVD that contains your data, photos, video, or music. Make sure the disc is loaded for printing before you start.

1. Open your file in Epson Print CD and click **Print**.

You see this screen:

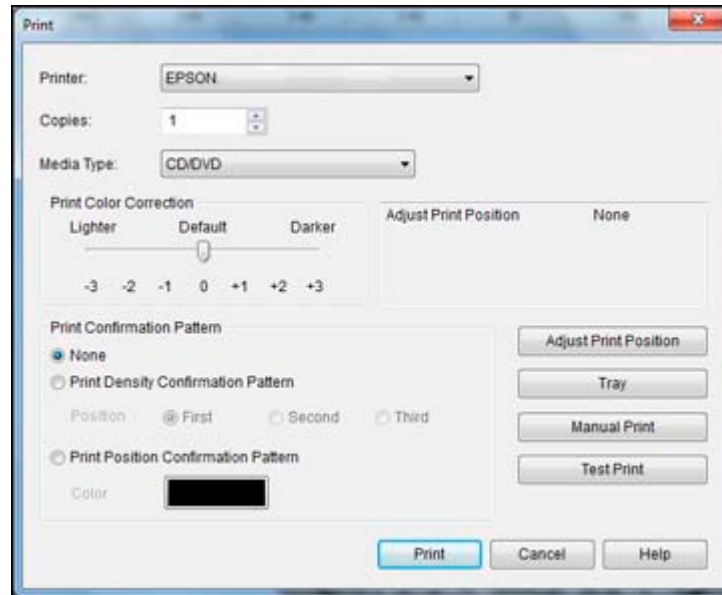

2. Make sure your product is selected as the **Printer** setting.
3. To see how your design will look without printing on the disc, click **Test Print** and follow the instructions on the screen.
4. When you are ready to print on the disc, click the **Print** button on the screen.
5. Click **Print**.

Parent topic: [Printing on a CD/DVD with Windows](#)

Adjusting CD/DVD Print Position - Windows

If your printed design is not positioned correctly on the disc, you can adjust the print position. First, load an extra CD/DVD to use for printing test patterns.

1. Open your file in Epson Print CD and click **Print**.

You see this screen:

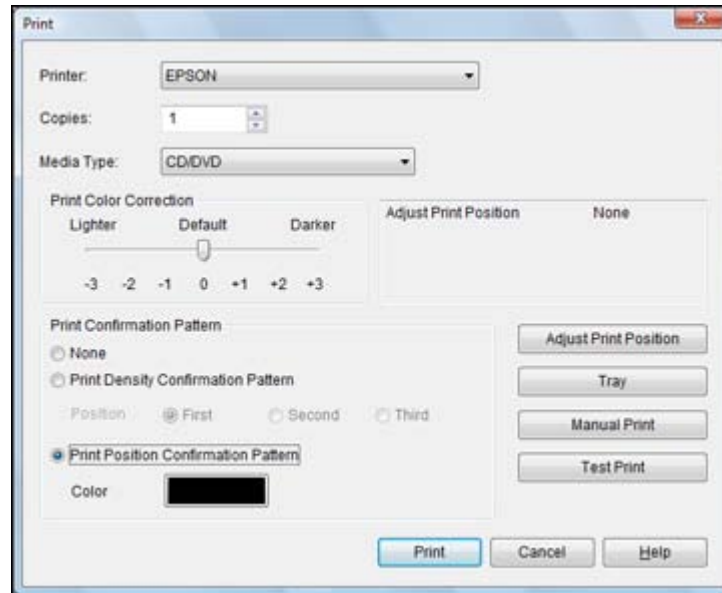

2. Select **Print Position Confirmation Pattern**.
3. Click **Print**.
4. Remove the disc after printing.
5. Using a metric ruler, measure the distance from the hole to the cross marks labeled **Top** and **Right**.

Note: Be sure to measure from the edge of the hole and not the edge of the printable area.

6. Click **Print** again, then select **Adjust Print Position**.
You see this screen:

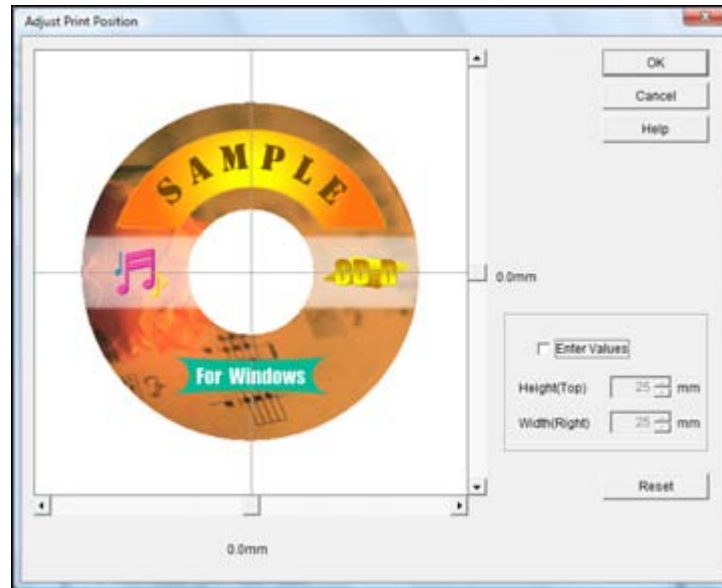

7. Click **Enter Values**, then select the distance for Top into the **Height (Top)** box and the distance for Right in the **Width (Right)** box.
8. Click **OK**.

Parent topic: [Printing on a CD/DVD with Windows](#)

Adjusting CD/DVD Print Quality - Windows

If ink smears on your disc or is sticky after it dries, you can adjust the color saturation and ink density. This may be necessary to make sure your designs look their best on the particular brand of discs you are using. First, load an extra CD/DVD to use for printing test patterns.

1. Open your file in Epson Print CD and click **Print**.

You see this screen:

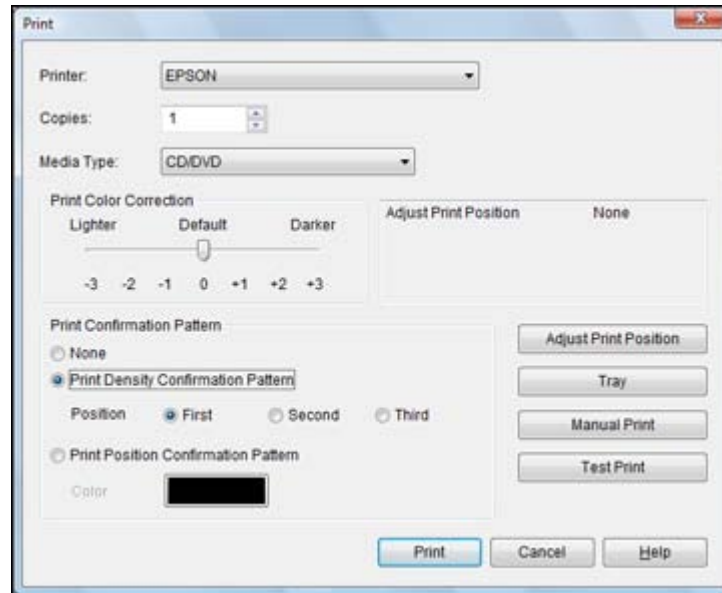

2. Select **Print Density Confirmation Pattern**.
3. Click **Print**.
4. Remove the disc after printing and check to see if you need to make the density darker or lighter.
5. Load the same disc in the product again.
6. Click **Print**.
7. Adjust the **Print Color Correction** slider to a darker or lighter setting as necessary.
8. Select **Print Density Confirmation Pattern** and select the **Second** radio button.
9. Click **Print** to print another test pattern
10. Examine the disc after printing to see if further adjustment is needed.

When the ink density looks good, you are ready to print on your burned CD or DVD.

Parent topic: [Printing on a CD/DVD with Windows](#)

Printing on a CD/DVD with Mac OS X

You can print with your product using the Epson Print CD software, as described in these sections.

[Designing a CD/DVD - Mac OS X](#)

[Printing Your CD/DVD Design - Mac OS X](#)

[Adjusting CD/DVD Print Position - Mac OS X](#)

[Adjusting CD/DVD Print Quality - Mac OS X](#)

Parent topic: [Printing on CDs/DVDs from a Computer](#)

Designing a CD/DVD - Mac OS X

You can use Epson Print CD to design your disc by importing photos, adding text, and creating special effects.

1. Open the Epson Print CD program in the **Applications > Epson Software > Print CD** folder on your Mac.

You see this screen:

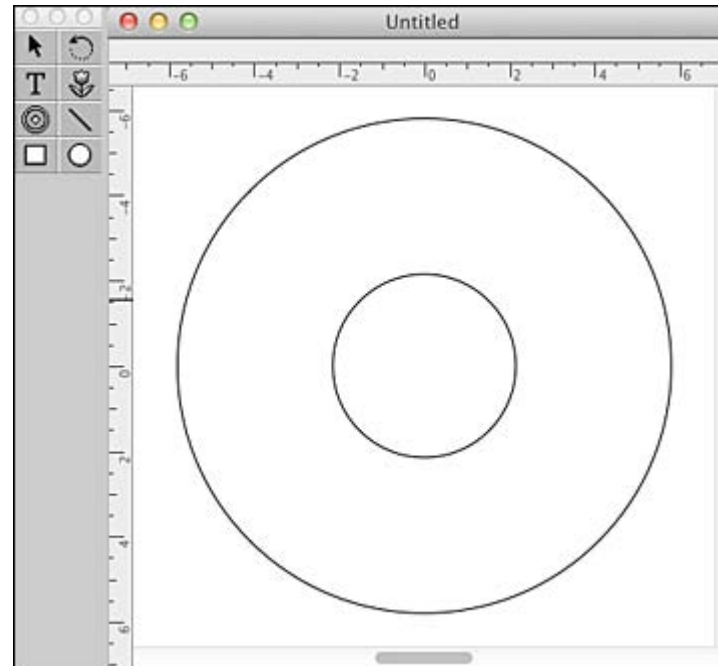

2. Use the icons on the left side of the screen to add a background image, picture, text, or graphic elements.

3. When you are finished creating your design, make sure you save it.

Parent topic: [Printing on a CD/DVD with Mac OS X](#)

Printing Your CD/DVD Design - Mac OS X

After you create your design, you can print it on paper to test it, then print it on the CD or DVD that contains your data, photos, video, or music. Make sure the disc is loaded for printing before you start.

1. Open your file in Epson Print CD and select **Print** from the File menu.

You see this screen:

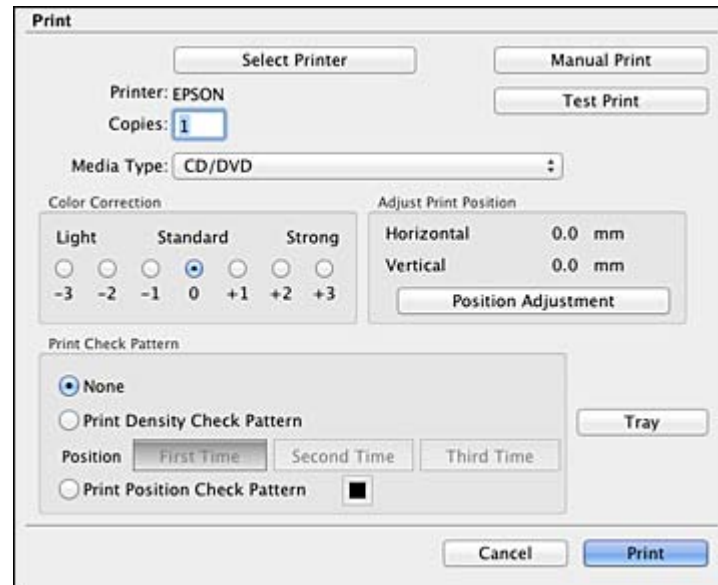

2. Make sure your product is selected as the **Printer** setting.
3. To see how your design will look without printing on the disc, select **Test Print** and follow the instructions on the screen.
4. When you are ready to print on the disc, click the **Print** button on the screen.

Parent topic: [Printing on a CD/DVD with Mac OS X](#)

Adjusting CD/DVD Print Position - Mac OS X

If your printed design is not positioned correctly on the disc, you can adjust the print position. First, load an extra CD/DVD to use for printing test patterns.

1. Open your file in Epson Print CD and select **Print** from the File menu.
You see this screen:

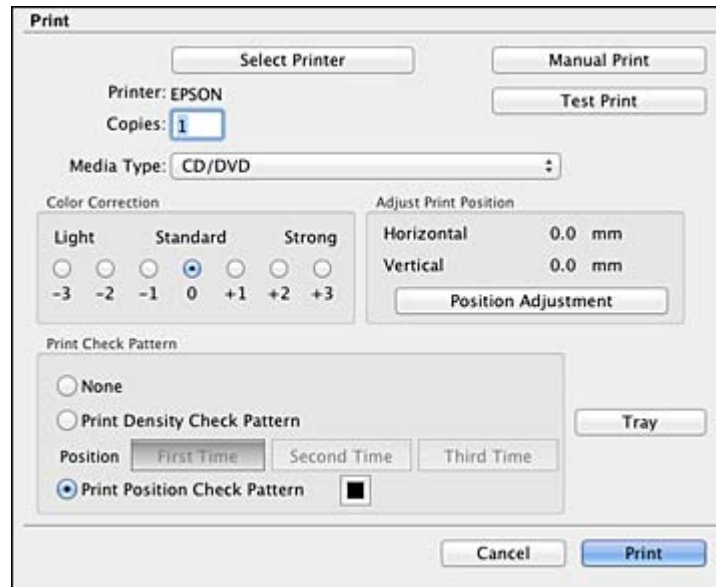

2. Select **Print Position Check Pattern**.
3. Click **Print**.
4. Remove the disc after printing.
5. Using a metric ruler, measure the distance from the hole to the cross marks labeled **Top** and **Right**.

Note: Be sure to measure from the edge of the hole and not the edge of the printable area.

6. Select **Print** from the File menu.
7. Select **Position Adjustment**.

You see this screen:

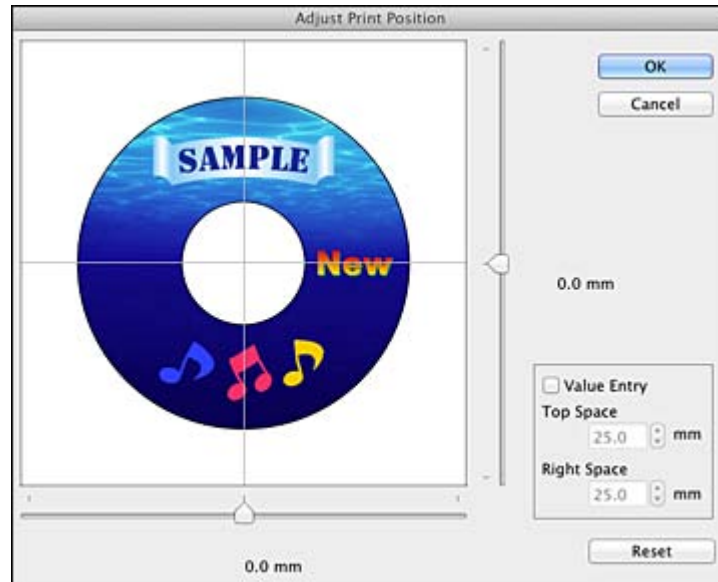

8. Click **Value Entry**, then select the distance for Top into the **Top Space** box and the distance for Right in the **Right Space** box.
9. Click **OK**.

Parent topic: [Printing on a CD/DVD with Mac OS X](#)

Adjusting CD/DVD Print Quality - Mac OS X

If ink smears on your disc or is sticky after it dries, you can adjust the color saturation and ink density. This may be necessary to make sure your designs look their best on the particular brand of discs you are using. First, load an extra CD/DVD to use for printing test patterns.

1. Open your file in Epson Print CD and select **Print** from the File menu.

You see this screen:

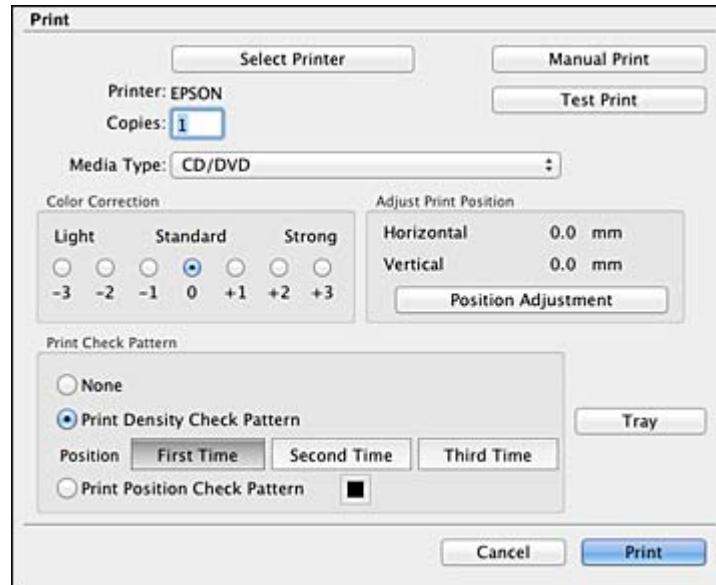

2. Select **Print Density Check Pattern**.
3. Click **Print**.
4. Remove the disc after printing and check to see if you need to make the density darker or lighter.
5. Load the same disc in the product again.
6. Select **Print** from the File menu.
7. Select a darker or lighter setting in the **Color Correction** box as necessary.
8. Select **Print Density Check Pattern** and select **Second Time**.
9. Click **Print** to print another test pattern.
10. Examine the disc after printing to see if further adjustment is needed.

When the ink density looks good, you are ready to print on your burned CD or DVD.

Parent topic: [Printing on a CD/DVD with Mac OS X](#)

Replacing Ink Cartridges

When an ink cartridge is expended, you need to replace it.

You may also need to replace a cartridge that is more than six months old, if your printouts do not look their best, even after cleaning and aligning the print head.

Note: Please dispose of your used Epson branded ink cartridges responsibly and in accordance with local requirements. If you would like to return your used ink cartridges to Epson for proper disposal, please go to epson.com/recycle for more information.

[Check Cartridge Status](#)

[Purchase Epson Ink Cartridges](#)

[Removing and Installing Ink Cartridges](#)

[Conserving Low Black Ink with Windows](#)

Check Cartridge Status

Your product and its printing software will let you know when an ink cartridge is low or expended.

[Checking Cartridge Status on the LCD Screen](#)

[Checking Cartridge Status with Windows](#)

[Checking Cartridge Status with Mac OS X](#)

Parent topic: [Replacing Ink Cartridges](#)

Checking Cartridge Status on the LCD Screen

You can check the status of your ink cartridges using your product's LCD screen.

1. Press the  home button, if necessary.

2. Press the left or right arrow button and then select **Setup**.



3. Select **Ink Levels**.
The ink cartridge status is displayed.

Note: Displayed ink levels are approximate.

4. Select **OK** to exit.

Parent topic: [Check Cartridge Status](#)

Related tasks

[Removing and Installing Ink Cartridges](#)

Checking Cartridge Status with Windows

A low ink reminder appears if you try to print when ink is low, and you can check your cartridge status at any time using a utility on your Windows computer.

1. To check your cartridge status, access the Windows Desktop and double-click the product icon in the Windows taskbar.

You see this window:

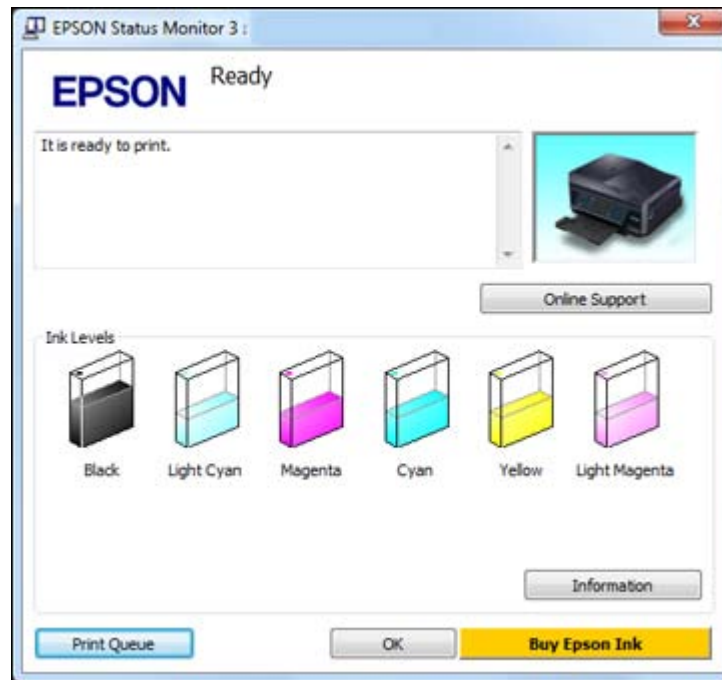

2. Replace or reinstall any ink cartridge indicated on the screen.

Note: If any of the cartridges installed in the product are broken, incompatible with the product model, or improperly installed, Epson Status Monitor will not display an accurate cartridge status.

3. To disable the low ink reminder, right-click the product icon in the Windows taskbar and select **Monitoring Preferences**.

You see this window:

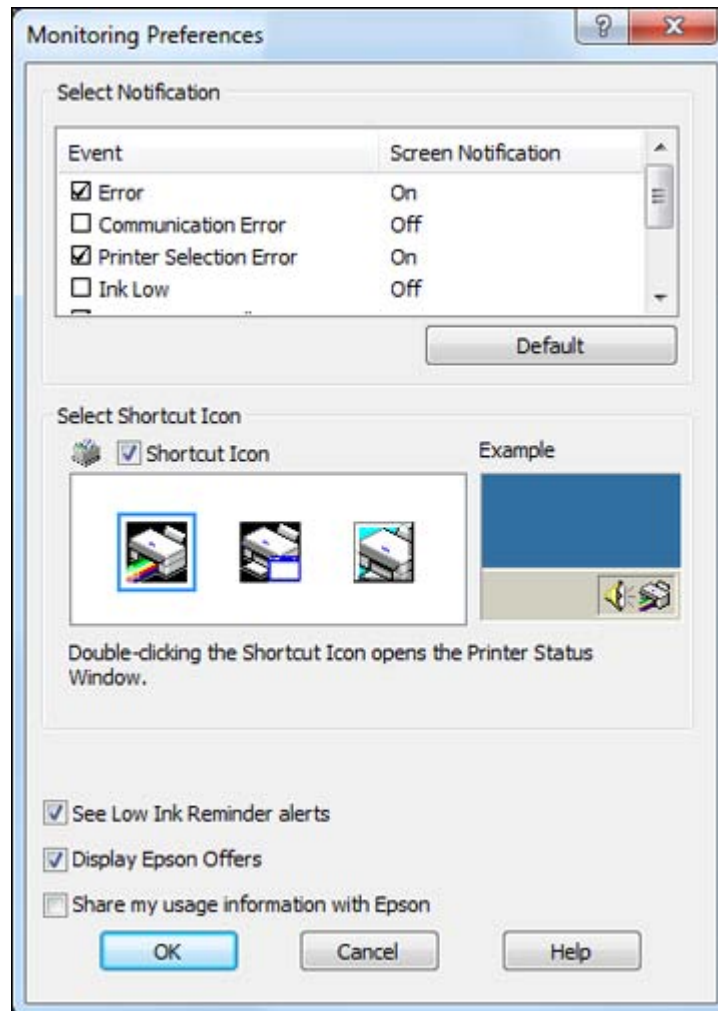

4. Deselect the **See Low Ink Reminder alerts** checkbox at the bottom of the screen.
5. To disable promotional offers, deselect the **Display Epson Offers** checkbox.

Parent topic: [Check Cartridge Status](#)

Related tasks

[Removing and Installing Ink Cartridges](#)

Checking Cartridge Status with Mac OS X

You can check your cartridge status using a utility on your Mac.

1. Do one of the following:
 - **Mac OS X 10.6/10.7/10.8:** In the Apple menu or the Dock, select **System Preferences**. Select **Print & Fax** or **Print & Scan**, select your product, and select **Options & Supplies**. Select **Utility** and select **Open Printer Utility**.
 - **Mac OS X 10.5:** In the Apple menu or the Dock, select **System Preferences**. Select **Print & Fax**, select your product, and select **Open Print Queue**. Select **Utility**.
2. Select **EPSON Status Monitor**.

You see a window like this:



3. Do the following as necessary:
 - To update the ink cartridge status, click **Update**.
 - Replace or reinstall any ink cartridge indicated on the screen.

Note: If any of the cartridges installed in the product is broken, incompatible with the product model, or improperly installed, Epson Status Monitor will not display an accurate cartridge status.

Parent topic: [Check Cartridge Status](#)

Related tasks

[Removing and Installing Ink Cartridges](#)

Purchase Epson Ink Cartridges

You can purchase genuine Epson ink and paper at Epson Supplies Central at epson.com/ink3 (U.S. sales) or epson.ca (Canadian sales). You can also purchase supplies from an Epson authorized reseller. To find the nearest one, call 800-GO-EPSON (800-463-7766).

Note: We recommend that you use genuine Epson cartridges and do not refill them. The use of other products may affect your print quality and could result in printer damage.

The cartridges included with the printer are designed for printer setup and not for resale. After some ink is used for priming, the rest is available for printing. Yields vary considerably based on images printed, print settings, paper type, frequency of use, and temperature. For print quality, a variable amount of ink remains in the cartridge after the "replace cartridge" indicator comes on.

[Ink Cartridge Part Numbers](#)

Parent topic: [Replacing Ink Cartridges](#)

Ink Cartridge Part Numbers

Use these part numbers when you order or purchase new ink cartridges.

Note: For best printing results, use up a cartridge within 6 months of opening the package.

Ink color	Part number	
	Standard-capacity	High-capacity
Black	277	277XL

Ink color	Part number	
	Standard-capacity	High-capacity
Cyan	277	277XL
Magenta	277	277XL
Yellow	277	277XL
Light Cyan	277	277XL
Light Magenta	277	277XL

Parent topic: [Purchase Epson Ink Cartridges](#)

Removing and Installing Ink Cartridges

Make sure you have your replacement cartridges handy before you begin. You must install new cartridges immediately after removing the old ones.

Caution: Leave your old cartridges in the printer until you are ready to replace them to prevent the print head nozzles from drying out. Do not open ink cartridge packages until you are ready to install the ink. Cartridges are vacuum packed to maintain reliability.

1. Make sure that the CD/DVD tray is not inserted for printing.
2. Turn on your product.
 - If an ink cartridge is expended, you see a message on the LCD screen. Note which cartridges need to be replaced and select **Proceed**, then choose **Yes, replace now**.
 - If you are replacing a cartridge before you see a message on the LCD screen, select **Setup > Maintenance > Ink Cartridge Replacement**.

3. Lift up the scanner unit.

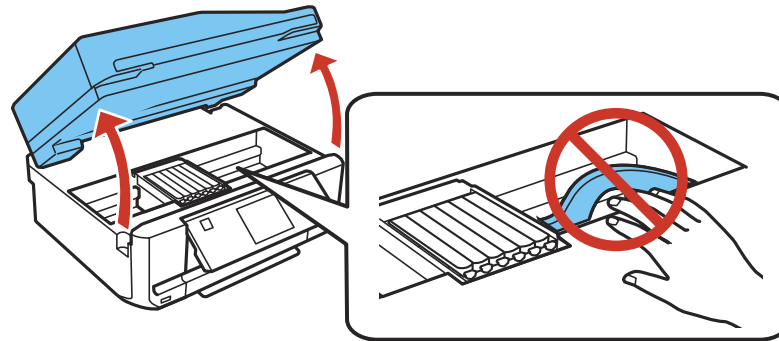

Caution: Do not move the print head by hand; otherwise, you may damage your product. Do not touch the flat white cable inside the printer.

4. Push in the blue tab to unlock the ink cartridge you are replacing. Then lift the bottom of the ink cartridge to remove it.

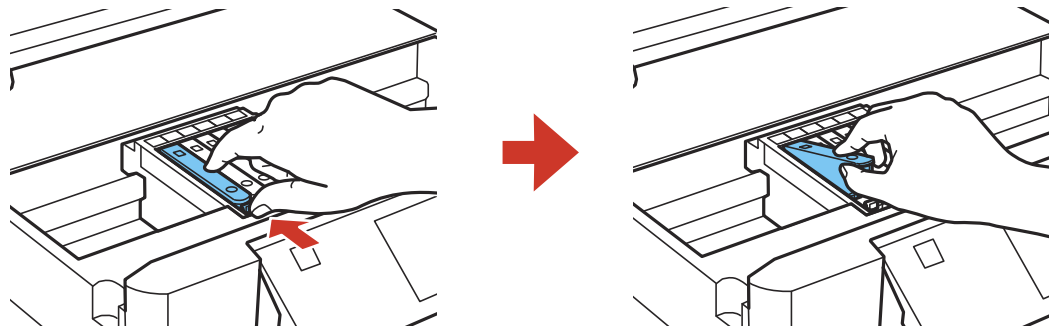

Warning: If ink gets on your skin, wash it thoroughly with soap and water. If ink gets into your eyes, flush them immediately with water. If ink gets into your mouth, spit it out and see a doctor right away. Keep ink cartridges out of the reach of children.

- Recap the used ink cartridge using the cap that came with it.

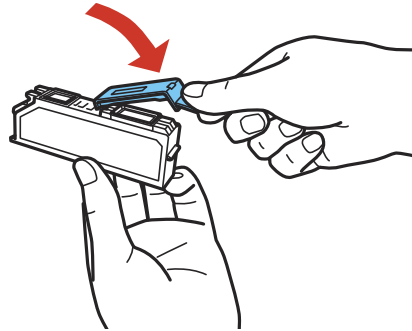

Note: Dispose of used cartridges carefully. Do not take the used cartridge apart or try to refill it.

- Remove the new ink cartridge from the package.

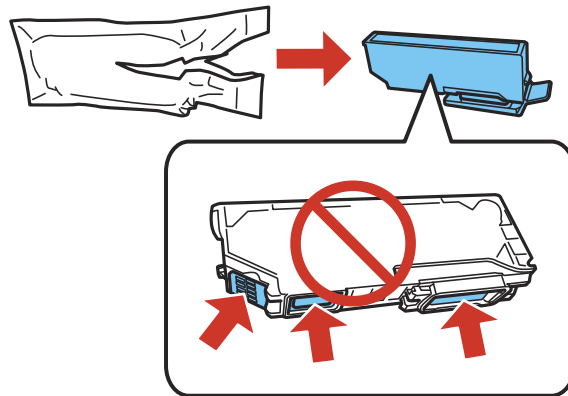

Caution: Do not shake the cartridges after opening the packages, or ink may leak. Do not touch the areas shown above. Doing so may prevent normal operation and printing.

7. Remove the cap from the cartridge and store it in the bag that came with your product for later use.

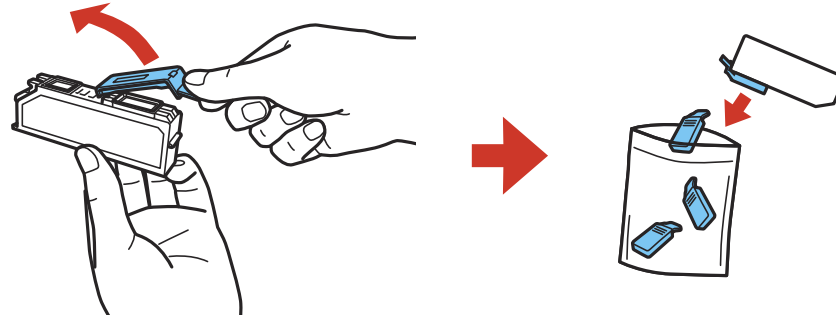

Note: Save the cap so you can recap ink cartridges before storing or disposing of them.

Caution: Do not remove any other labels or seals, or ink will leak.

8. Insert the ink cartridge head first into the ink cartridge holder. Then press the bottom of the ink cartridge down until it clicks into place.

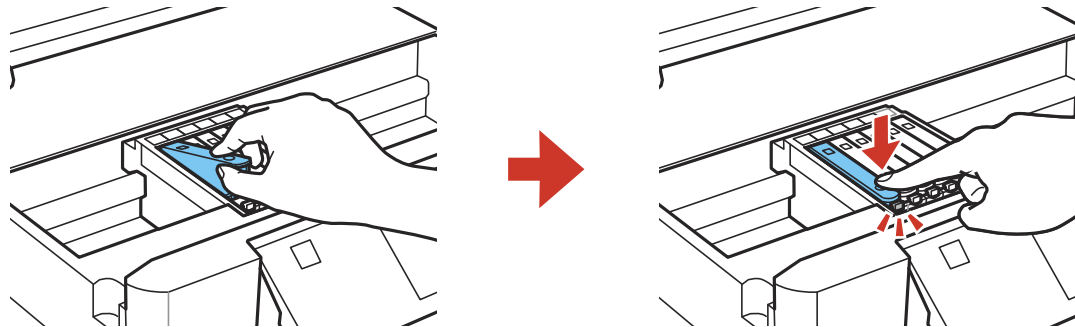

9. Once you replace all the cartridges that need replacing, close the scanner unit.

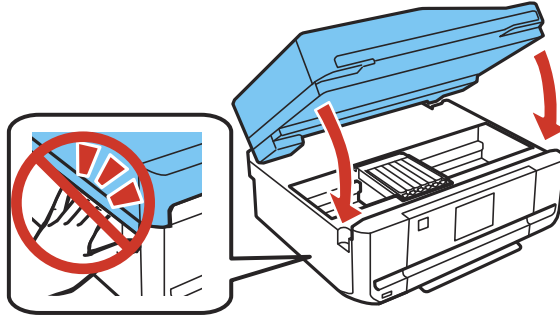

The product starts priming the ink. This takes a few minutes. When you see a completion message on the LCD screen, ink replacement is complete.

Note: If you see an error screen telling you an ink cartridge is installed incorrectly, lift up the scanner unit and press the ink cartridge down until it clicks into place. When you're finished, close the scanner unit.

If you remove a low or expended ink cartridge, you cannot re-install and use the cartridge.

Caution: If you remove an ink cartridge for later use, recap the ink cartridge using the cap that came with it to prevent the ink from drying out and to protect the surrounding area from getting smeared by ink. Store the ink cartridge in the same environment as the product. Do not leave the product with the ink cartridges removed for an extended period of time. Otherwise, ink remaining in the print head nozzles may dry out and you may not be able to print.

Parent topic: [Replacing Ink Cartridges](#)

Related concepts

[Purchase Epson Ink Cartridges](#)

Conserving Low Black Ink with Windows

The following window appears when black ink runs low and there is more color ink.

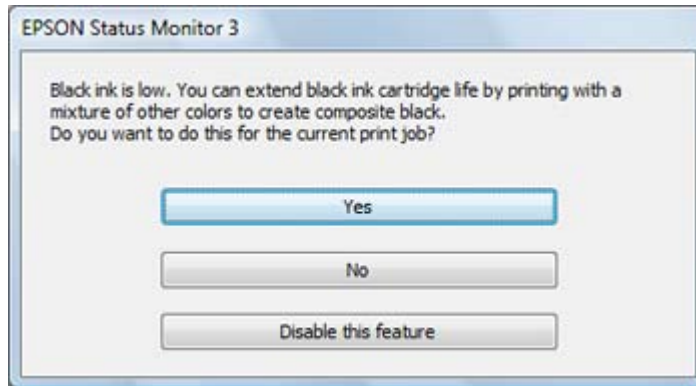

Note: The window appears only when you have selected **Plain Paper/Bright White Paper** as the paper type setting, and depends on other selected print settings. To use this feature, Epson Status Monitor must be enabled.

- Click **Yes** to use a mixture of color inks to create black, or **No** to continue using the remaining black ink for the document you are printing.
- Click **Disable this feature** to continue using the remaining black ink.

Note: If you disable this feature, it remains disabled until you reinstall the black ink cartridge.

Parent topic: [Replacing Ink Cartridges](#)

Adjusting Print Quality

If your print quality declines, you may need to run a utility to clean or align the print head.

If running these utilities does not solve the problem, you may need to replace the ink cartridges.

[Print Head Maintenance](#)

[Print Head Alignment](#)

[Cleaning the Paper Path](#)

Related topics

[Replacing Ink Cartridges](#)

Print Head Maintenance

If your printouts become too light, or you see dark or light bands across them, you may need to clean the print head nozzles. Cleaning uses ink, so clean the nozzles only if print quality declines.

You can check for clogged nozzles before you clean them so you don't clean them unnecessarily.

Note: You cannot clean the print head if an ink cartridge is expended, and may not be able to clean it when a cartridge is low. You must replace the cartridge first.

[Print Head Nozzle Check](#)

[Print Head Cleaning](#)

Parent topic: [Adjusting Print Quality](#)

Related topics

[Replacing Ink Cartridges](#)

Print Head Nozzle Check

You can print a nozzle check pattern to check for clogged nozzles.

[Checking the Nozzles Using the Product Control Panel](#)

[Checking the Nozzles Using a Computer Utility](#)

Parent topic: [Print Head Maintenance](#)

Checking the Nozzles Using the Product Control Panel

You can check the print head nozzles using the control panel on your product.

1. Make sure the CD/DVD tray is not inserted for printing.
2. Load a few sheets of plain paper in the product.
3. Press the  home button, if necessary.
4. Press the left or right arrow button and then select **Setup**.
5. Select **Maintenance**.



6. Select **Nozzle Check**.

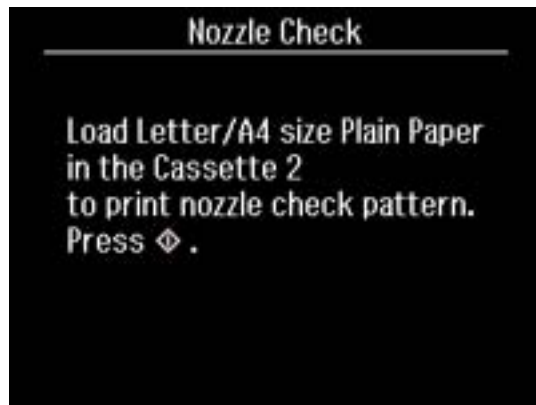

7. Press the  start button.

The nozzle check pattern is printed.

8. Check the printed pattern to see if there are gaps in the lines.

Print head is clean

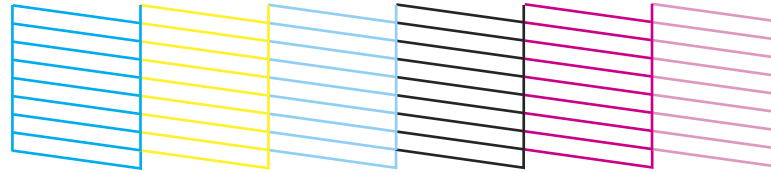

Print head needs cleaning

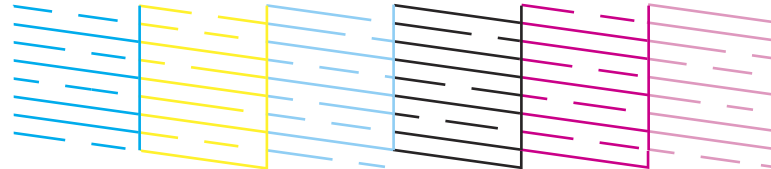

9. Do one of the following:
 - If there are no gaps, the print head is clean. Select **Done**.
 - If there are gaps or the pattern is faint, select **Clean the Print Head**.

10. Follow the instructions on the screen to clean the print head.

If you don't see any improvement after cleaning the print head up to 2 times, leave the product on and wait at least 6 hours. Then try cleaning the print head again. If quality still does not improve, one of the ink cartridges may be old or damaged and needs to be replaced.

Parent topic: [Print Head Nozzle Check](#)

Related tasks

[Cleaning the Print Head Using the Product Control Panel](#)

[Loading Paper in Cassette 2 \(Lower Cassette\)](#)

Related topics

[Replacing Ink Cartridges](#)

Checking the Nozzles Using a Computer Utility

You can check the print head nozzles using a utility on your Windows or Mac computer.

1. Make sure the CD/DVD tray is not inserted for printing.
2. Load a few sheets of plain paper in the product.
3. Do one of the following:
 - **Windows:** Access the Windows Desktop and right-click the product icon in the Windows taskbar.
 - **Mac OS X 10.6/10.7/10.8:** In the Apple menu or the Dock, select **System Preferences**. Select **Print & Fax** or **Print & Scan**, select your product, and select **Options & Supplies**. Select **Utility** and select **Open Printer Utility**.
 - **Mac OS X 10.5:** In the Apple menu or the Dock, select **System Preferences**. Select **Print & Fax**, select your product, and select **Open Print Queue**. Select **Utility**.
4. Select **Nozzle Check**.

You see a window like this:

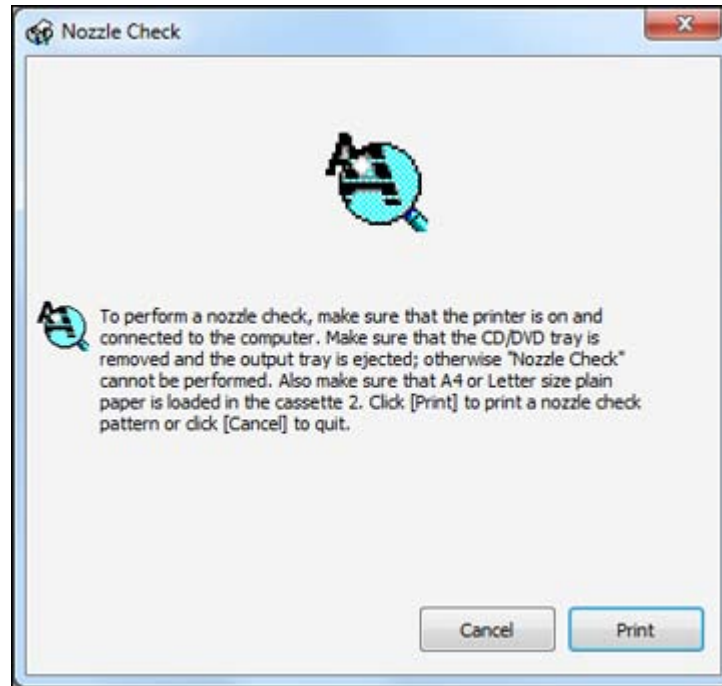

5. Click **Print**.

6. Check the printed pattern to see if there are gaps in the lines.

Print head is clean

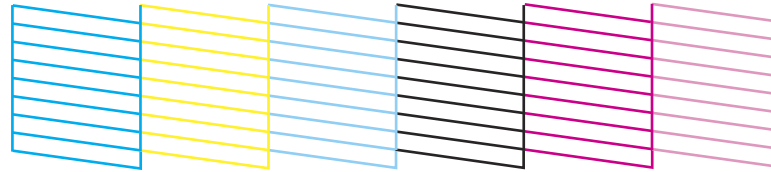

Print head needs cleaning

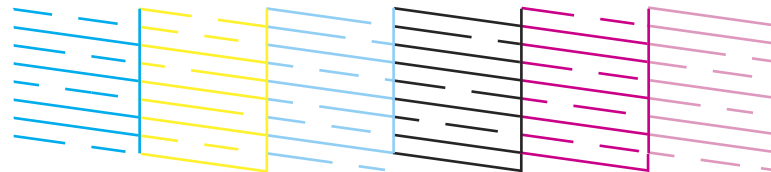

7. If there are no gaps, click **Finish**.

If there are gaps or the pattern is faint, clean the print head.

Parent topic: [Print Head Nozzle Check](#)

Related tasks

[Cleaning the Print Head Using a Computer Utility](#)

[Loading Paper in Cassette 2 \(Lower Cassette\)](#)

Related topics

[Replacing Ink Cartridges](#)

Print Head Cleaning

If print quality has declined and the nozzle check pattern indicates clogged nozzles, you can clean the print head.

Note: You cannot clean the print head if an ink cartridge is expended, and may not be able to clean it when a cartridge is low. You must replace the cartridge first.

[Cleaning the Print Head Using the Product Control Panel](#)

[Cleaning the Print Head Using a Computer Utility](#)

Parent topic: [Print Head Maintenance](#)

Related topics

[Replacing Ink Cartridges](#)

Cleaning the Print Head Using the Product Control Panel

You can check the print head nozzles using the control panel on your product.

1. Make sure the CD/DVD tray is not inserted for printing.
2. Load a few sheets of plain paper in the product.
3. Press the  home button, if necessary.
4. Press the left or right arrow button and then select **Setup**.
5. Select **Maintenance**.



6. Select **Head Cleaning**.



7. Press the [Start Button Icon] start button to clean the print head. You see a message on the LCD screen during the cleaning cycle.

Caution: Never turn off the product during a cleaning cycle or you may damage it.

When the cleaning cycle is finished, you see a message on the display screen.

8. Select **Print Nozzle Check Pattern**, then press the [Start Button Icon] start button to run a nozzle check and confirm that the print head is clean.

If you don't see any improvement after cleaning the print head up to 2 times, leave the product on and wait at least 6 hours. Then try cleaning the print head again. If quality still does not improve, one of the ink cartridges may be old or damaged and needs to be replaced.

Parent topic: [Print Head Cleaning](#)

Related tasks

[Checking the Nozzles Using the Product Control Panel](#)

[Loading Paper in Cassette 2 \(Lower Cassette\)](#)

Related topics

[Replacing Ink Cartridges](#)

Cleaning the Print Head Using a Computer Utility

You can clean the print head using a utility on your Windows computer or Mac.

1. Make sure the CD/DVD tray is not inserted for printing.
2. Load a few sheets of plain paper in the product.
3. Do one of the following:
 - **Windows:** Right-click the product icon in the Windows taskbar.
 - **Mac OS X 10.6/10.7/10.8:** In the Apple menu or the Dock, select **System Preferences**. Select **Print & Fax** or **Print & Scan**, select your product, and select **Options & Supplies**. Select **Utility** and select **Open Printer Utility**.
 - **Mac OS X 10.5:** In the Apple menu or the Dock, select **System Preferences**. Select **Print & Fax**, select your product, and select **Open Print Queue**. Select **Utility**.
4. Select **Head Cleaning**.

You see a window like this:

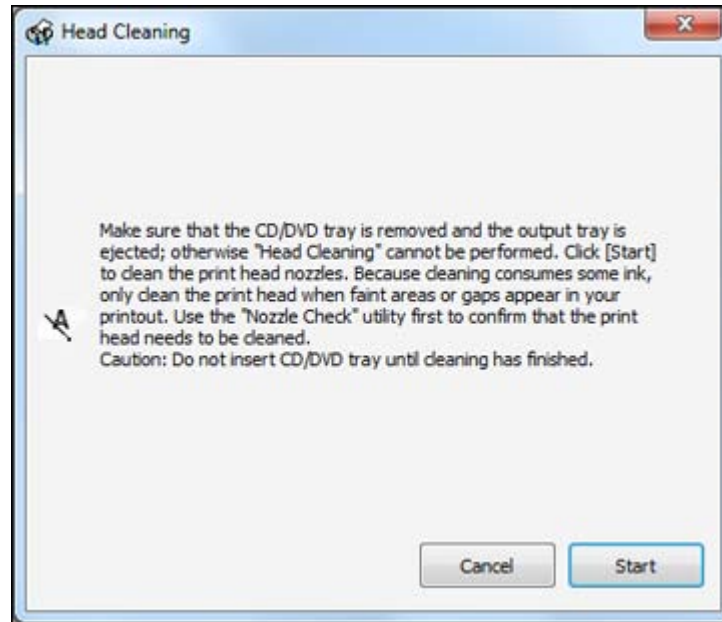

5. Click **Start** to begin the cleaning cycle.
You see a message on the LCD screen during the cleaning cycle.

Caution: Never turn off the product during a cleaning cycle or you may damage it.

- When the cleaning cycle is finished, you can check to see if the nozzles are clean; click **Print Nozzle Check Pattern** and click **Print**.
- Check the printed pattern to see if there are gaps in the lines.

Print head is clean

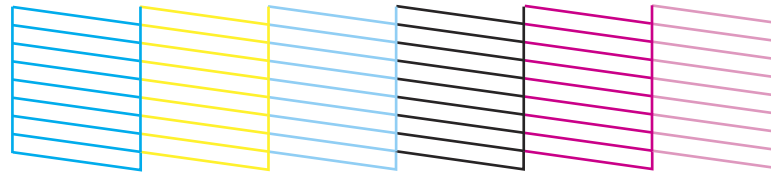

Print head needs cleaning

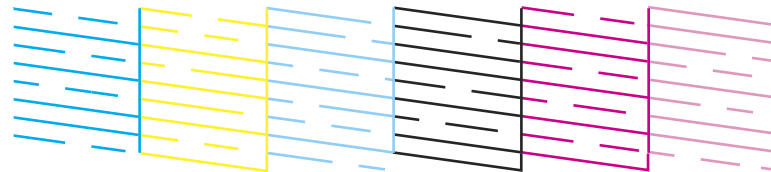

- If there are no gaps, click **Finish**.
- If there are gaps or the pattern is faint, click **Clean** to clean the print head again.

If you don't see any improvement after cleaning the print head up to 2 times, leave the product on and wait at least 6 hours. Then try cleaning the print head again. If quality still does not improve, one of the ink cartridges may be old or damaged and needs to be replaced.

Parent topic: [Print Head Cleaning](#)

Related tasks

[Checking the Nozzles Using a Computer Utility](#)

[Loading Paper in Cassette 2 \(Lower Cassette\)](#)

Related topics

[Replacing Ink Cartridges](#)

Print Head Alignment

If your printouts become grainy or blurry, you notice misalignment of vertical lines, or you see dark or light horizontal bands, you may need to align the print head.

Note: Banding may also occur if your print head nozzles need cleaning.

[Aligning the Print Head Using the Product Control Panel](#)

[Aligning the Print Head Using a Computer Utility](#)

Parent topic: [Adjusting Print Quality](#)

Aligning the Print Head Using the Product Control Panel

You can align the print head using the control panel on your product.

1. Make sure the CD/DVD tray is not inserted for printing.
2. Load a few sheets of plain paper in the product.
3. Press the  home button, if necessary.
4. Press the left or right arrow buttons and then select **Setup**.
5. Select **Maintenance**.



6. Select **Print Head Alignment**.



7. Press the ⬠ start button to print an alignment sheet.

Note: Do not cancel printing while you are printing a head alignment pattern.

8. Check the printed pattern and select the number representing the best printed pattern for each set.
9. Select **Done** when you are finished.

Parent topic: [Print Head Alignment](#)

Related tasks

[Loading Paper in Cassette 2 \(Lower Cassette\)](#)

Aligning the Print Head Using a Computer Utility

You can align the print head using a utility on your Windows computer or Mac.

1. Make sure the CD/DVD tray is not inserted for printing.
2. Load a few sheets of plain paper in the product.
3. Do one of the following:
 - **Windows:** Access the Windows Desktop and right-click the product icon in the Windows taskbar.
 - **Mac OS X 10.6/10.7/10.8:** In the Apple menu or the Dock, select **System Preferences**. Select **Print & Fax** or **Print & Scan**, select your product, and select **Options & Supplies**. Select **Utility** and select **Open Printer Utility**.

- **Mac OS X 10.5:** In the Apple menu or the Dock, select **System Preferences**. Select **Print & Fax**, select your product, and select **Open Print Queue**. Select **Utility**.
4. Select **Print Head Alignment**.
 5. Click **Next**, then click **Print** to print an alignment sheet.

Note: Do not cancel printing while you are printing a head alignment pattern.

You see a window like this:

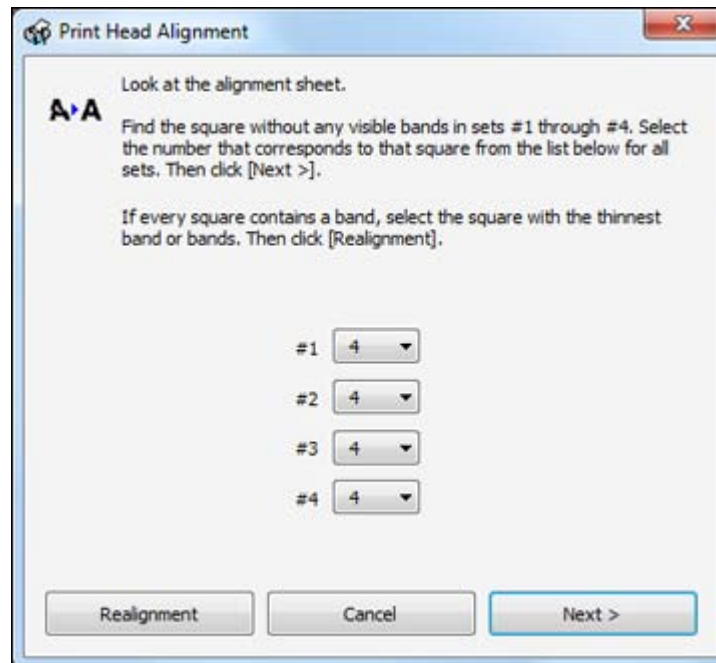

6. Check the printed pattern and follow the instructions on the screen to choose the number representing the best printed pattern for each set.
 - After choosing each pattern number, click **Next**.
 - If no patterns are aligned in one or more of the sets, choose the closest one in each set and click **Realignment**. Then print another alignment sheet and check it.

Note: Click **Skip** (where available) if you want to skip a particular alignment sheet.

7. When you are done, click **Finish**.

Parent topic: [Print Head Alignment](#)

Related tasks

[Loading Paper in Cassette 2 \(Lower Cassette\)](#)

Cleaning the Paper Path

If you see ink on the back of a printout, you can clean the paper path to remove any excess ink.

1. Load a few sheets of plain paper in the product.
2. Use the product control panel to make a copy, but without placing a document on the scanner glass.
3. Check the back of the ejected paper to see if it is clean.
4. Repeat as necessary until the paper comes out clean.

Parent topic: [Adjusting Print Quality](#)

Related tasks

[Loading Paper in Cassette 2 \(Lower Cassette\)](#)

Related topics

[Copying](#)

Cleaning and Transporting Your Product

See these sections if you need to clean or transport your product.

[Cleaning Your Product](#)

[Transporting Your Product](#)

Cleaning Your Product

To keep your product working at its best, you should clean it several times a year.

Close the output tray and front cover when you are not using the product to protect it from dust.

Caution: Do not use a hard brush, alcohol, or paint thinner to clean the product or you may damage it. Do not use oil or other lubricants inside the product or let water get inside it.

1. Turn off the product.
2. Unplug the power cable.
3. Disconnect any connected cables.
4. Remove all the paper.
5. Clean the scanner glass with a soft, lint-free cloth (microfiber is recommended), moistened with a little glass cleaner.

Caution: Do not spray glass cleaner directly on the glass and do not press the glass surface with any force.

6. Open the ADF cover and use a soft, dry, lint-free cloth (microfiber is recommended), to clean the roller and the interior of the ADF.

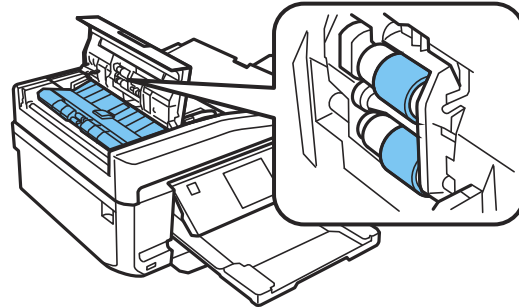

7. Clean the outer case and control panel with a soft, dry cloth. Do not use liquid or chemical cleansers.

Parent topic: [Cleaning and Transporting Your Product](#)

Transporting Your Product

If you need to ship your product or transport it a long distance, prepare it for transportation as described here.

Caution: During transportation and storage, follow these guidelines:

- Avoid tilting the product, placing it vertically, or turning it upside down; otherwise ink may leak.
- Leave the ink cartridges installed. Removing the cartridges can dry out the print head and may prevent the product from printing.
- Do not carry the product by its control panel; this may damage the product.

1. Turn off the product.
2. Lift up the scanner unit and check to see if the print head is in the far right position (the home position). If not, turn on the product, wait for the print head to move, then turn the product off again.

3. Secure the ink cartridge holder to the case with tape.

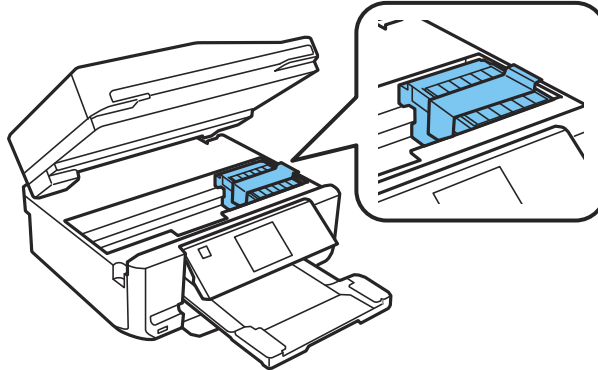

Caution: Do not place tape on the white flat cable inside the product; otherwise, you may damage your product.

4. Lower the scanner unit.
5. Remove all the paper from the product.
6. Unplug the power cable.
7. Disconnect any connected cables.
8. Close the rear paper feed slot cover, the output tray, the ADF input tray, and the ADF output tray extension. Then lower the control panel.

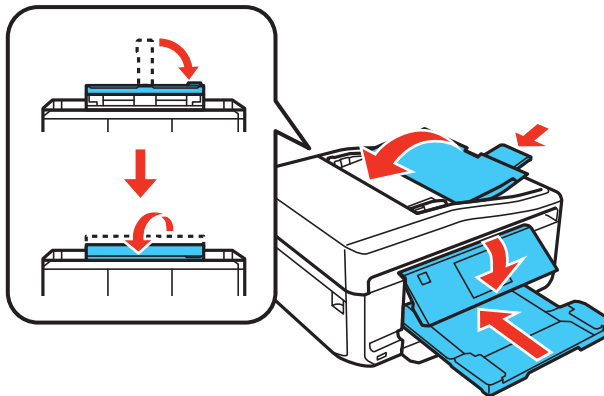

9. Place the product in its original packing materials, if possible, or use equivalent materials with cushioning around the product.

Keep the product level during transportation. Be sure to remove the tape from the ink cartridge holder before turning on your product. If print quality has declined when you print again, clean and align the print head.

Parent topic: [Cleaning and Transporting Your Product](#)

Related concepts

[Print Head Cleaning](#)

[Print Head Alignment](#)

Solving Problems

Check these sections for solutions to problems you may have using your product.

[Checking for Software Updates](#)

[Product Status Messages](#)

[Running a Product Check](#)

[Resetting Control Panel Defaults](#)

[Solving Setup Problems](#)

[Solving Network Problems](#)

[Solving Copying Problems](#)

[Solving Paper Problems](#)

[Solving Problems Printing from a Computer](#)

[Solving Page Layout and Content Problems](#)

[Solving Print Quality Problems](#)

[Solving Scanning Problems](#)

[Solving Scanned Image Quality Problems](#)

[Solving Memory Card Problems](#)

[Solving Faxing Problems](#)

[When to Uninstall Your Product Software](#)

[Where to Get Help](#)

Checking for Software Updates

Periodically, it's a good idea to check Epson's support website for free updates to your product software. You can select **Download the Latest Software** from the Home screen of this manual or visit Epson's driver download site ([U.S. downloads](#) or [Canadian downloads](#)).

- **Windows:** Your printer software automatically checks for updates. You can also manually update the software by selecting **Software Update** here:
 - Accessing the Windows Desktop and right-clicking the product icon in the Windows taskbar
 - On the **Maintenance** tab in the printer settings window

You can also update the software by selecting **EPSON Software Updater** in the **EPSON** or **EPSON Software** program group, accessible by the **Start** button, or on the **Start** or **Apps** screens, depending on your version of Windows.

- **Mac OS X:** You can manually update the software by opening the **Applications > Epson Software** folder and selecting **EPSON Software Updater**.

Parent topic: [Solving Problems](#)

Related tasks

[Changing Automatic Update Options](#)

Product Status Messages

You can often diagnose problems with your product by checking the messages on its LCD screen. You can also see help information and how-to instructions on the screen. Press the  home button, if necessary, press the left or right arrow button, and then select **Help**.

LCD screen message	Condition/solution
Paper jam	Paper is jammed in the product. Follow the instructions on the LCD screen to remove the jammed paper from the indicated area.
Paper out	No paper is loaded. Load paper in the product.
Photos not recognized. Place the photos correctly on the scanner glass.	There is a problem with originals placed on the product. Check to make sure they are placed correctly and repeat the operation.
Printer error. Turn the power off and on again. For details, see your documentation.	A fatal error has occurred. Turn the product off and then back on again. If the error continues, check for a paper jam. If there is no paper jam, contact Epson for support.
Communication error. Check if a computer is connected.	Make sure the computer is connected to your product and your scanning software is installed correctly.
A printer's ink pad is nearing the end of its service life. Please contact Epson Support.	The ink pads are near the end of their service life and the message will be displayed until the ink pad is replace. Contact Epson for support. (To resume printing, press the  start button.)
A printer's ink pad is at the end of its service life. Please contact Epson Support.	The ink pad is at the end of its service life. Turn off the product and contact Epson for support.

LCD screen message	Condition/solution
Memory card or external device not recognized.	Make sure the memory card or external device is inserted correctly and meets the specifications for your product.
No dial tone detected. Run Check Fax Connection under Fax Settings in Setup menu.	Make sure the phone cable is connected correctly and the phone line works. If you connected the product to a PBX (Private Branch Exchange) phone line or Terminal Adapter, turn off the Dial Tone Detection setting.
Combination of IP address and subnet mask is invalid. See your documentation.	There is a problem with the network connection to your product.
Recovery mode	An error has occurred during firmware updating. Connect your product using a USB cable and try downloading the Firmware Update from Epson's support website. If you still need help, contact Epson for support.

Parent topic: [Solving Problems](#)

Related references

[Fax Communications Options](#)

[Where to Get Help](#)

[Paper Jam Problems Inside the Product](#)

[Paper Jam Problems in the Paper Cassette](#)

[Paper Jam Problems in the Auto Duplexer](#)

[Paper Jams in the Automatic Document Feeder](#)

Related topics

[Loading Paper](#)

[Placing Originals on the Product](#)

Running a Product Check

Running a product check helps you determine if your product is operating properly.

1. Disconnect any interface cables connected to your product.
2. Load plain paper in the product.
3. Press the  home button, if necessary.
4. Press the left or right arrow button and then select **Setup**.

5. Select **Maintenance**.

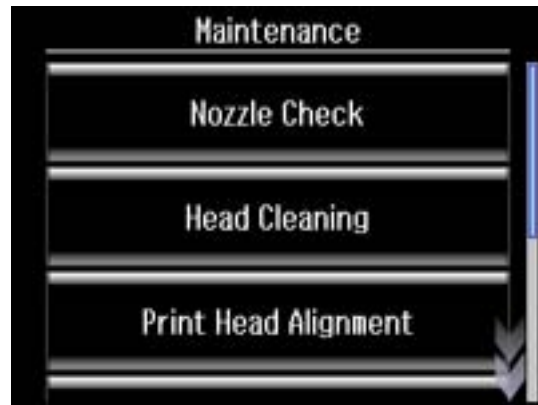

6. Select **Nozzle Check**.

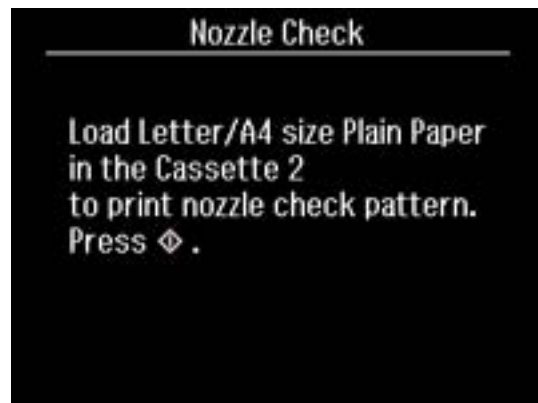

7. Press the \diamond start button.
The nozzle check pattern is printed.
8. Do one of the following, depending on the results of the product check:
 - If the page prints and the nozzle check pattern is complete, the product is operating properly. Any operation problem you may have could be caused by your computer, cable, software, or selected

settings. Check the other solutions in this book or try uninstalling and reinstalling your printer software.

- If the page prints but the nozzle check pattern has gaps, clean or align the print head.
- If the page does not print, the product may have a problem. Check the other solutions in this manual. If they do not work, contact Epson.

Parent topic: [Solving Problems](#)

Related concepts

[Print Head Cleaning](#)

[Print Head Alignment](#)

[When to Uninstall Your Product Software](#)

Related references

[Where to Get Help](#)

Resetting Control Panel Defaults

If you have a problem with settings on the product control panel, you can reset them to their factory defaults. You can choose which settings to reset or reset them all.

1. Press the  home button, if necessary.
2. Press the left or right arrow button and then select **Setup**.
3. Scroll down and select **Restore Default Settings**.



4. Select one of these options:
 - **Fax Send/Receive Settings:** Resets all settings on the Send Settings, Receive Settings, and Communication screens.
 - **Fax Data Settings:** Erases the speed dial list, group dial list, header, and fax log.
 - **Wi-Fi/Network Settings:** Resets all network settings.
 - **All except Wi-Fi/Network & Fax Settings:** Resets all control panel settings, except for network and fax settings.
 - **All Settings:** Resets all control panel settings.You see a confirmation screen.
5. Select **Yes** to reset the selected settings. (Select **No** if you want to cancel the operation.)

Parent topic: [Solving Problems](#)

Solving Setup Problems

Check these sections if you have problems while setting up your product.

[Noise After Ink Installation](#)

[Software Installation Problems](#)

[Control Panel Setup Problems](#)

Parent topic: [Solving Problems](#)

Noise After Ink Installation

If you hear noises from your product after installing ink, check the following:

- The first time you install ink cartridges, the product must prime its print head. Wait until priming finishes before you turn off the product, or it may prime improperly and use excess ink the next time you turn it on. Your product is finished priming the print head when the  power light stops flashing.
- If the product's print head stops moving or making noise, and the charging process has not finished after approximately 5 minutes, turn off your product. Turn it back on and check to see if charging is still in progress. If it is still in progress, contact Epson for help.

Parent topic: [Solving Setup Problems](#)

Related references

[Where to Get Help](#)

Software Installation Problems

If you have problems while installing your product software, try these solutions:

- Make sure your product is turned on and any necessary cables are securely connected at both ends. If you still have problems installing software, disconnect the cable and carefully follow the instructions on the *Start Here* sheet. Also make sure your system meets the requirements for your operating system.
- Close any other programs, including screen savers and virus protection software, and install your product software again.
- In Windows, make sure your product is selected as the default printer and the correct port is shown in the printer properties.
- If you see any error message or your software does not install correctly in Windows, you may not have software installation privileges. Contact your System Administrator.

Parent topic: [Solving Setup Problems](#)

Related concepts

[When to Uninstall Your Product Software](#)

Related references

[Windows System Requirements](#)

[Mac System Requirements](#)

Control Panel Setup Problems

If you have problems setting up the control panel, try these solutions:

- To view LCD screen text in a different language, select a different language setting for the panel.
- To adjust the position of the control panel, carefully raise or lower it.

Parent topic: [Solving Setup Problems](#)

Related tasks

[Adjusting Control Panel Position](#)

[Changing LCD Screen Language](#)

Solving Network Problems

Check these solutions if you have problems setting up or using your product on a network.

Note: Breakdown or repair of this product may cause loss of fax and network data and settings. Epson is not responsible for backing up or recovering data and settings during or after the warranty period. We recommend that you make your own backup or print out your fax and network data and settings.

[Product Cannot Connect to a Wireless Router or Access Point](#)

[Network Software Cannot Find Product on a Network](#)

[Product Does Not Appear in Mac OS X Printer Window](#)

[Cannot Print Over a Network](#)

[Cannot Scan Over a Network](#)

[Printing a Network Status Sheet](#)

Parent topic: [Solving Problems](#)

Product Cannot Connect to a Wireless Router or Access Point

If your product has trouble finding or connecting to a wireless router or access point, try these solutions:

- Make sure to place your product within contact range of your router or access point.

Note: Avoid placing your product near a microwave oven, 2.4 GHz cordless phone, or large metal object, such as a filing cabinet.

- Verify that your router or access point is operating correctly by connecting to it from your computer or another device.
- You may need to disable the firewall and any anti-virus software on your wireless router or access point.
- Check to see if access restrictions, such as MAC address filtering, are set on the router or access point. If access restrictions are set, add your product's MAC address to your router's address list. To obtain your product's MAC address, print a network status sheet. Then follow the instructions in your router or access point documentation to add the address to the list.
- If your router or access point does not broadcast its network name (SSID), follow the instructions that came with your product to enter your wireless network name manually.
- If your router or access point has security enabled, determine the kind of security it is using and any required password or passphrase for connection. Then make sure to enter the exact WEP key or WPA passphrase correctly.
- Check if your computer is restricting the available wireless channels. If so, verify that your wireless access point is using one of the usable channels and change to a usable channel, if necessary.

Parent topic: [Solving Network Problems](#)

Network Software Cannot Find Product on a Network

If EpsonNet Setup cannot find your product on a network, try these solutions:

- Make sure your product is turned on and connected to your network. Verify connection using your product control panel.
- Check if your network name (SSID) contains non-ASCII characters. Your product cannot display non-ASCII characters.
- If necessary, reinstall your product software and try running EpsonNet Setup again:
 1. Reset your product's network settings to their factory defaults.
 2. Windows only: uninstall your product software.
 3. Initialize your router following the instructions in your router documentation.

Note: If you are reading these instructions online, you will lose your internet connection when you initialize your router, so note the next step before initializing it.

4. Download your product software from the Epson website, or install it from the CD that came with your product using the instructions on the *Start Here* sheet.
- If you have replaced your router, reinstall your product software to connect to the new router.

Parent topic: [Solving Network Problems](#)

Related concepts

[When to Uninstall Your Product Software](#)

Product Does Not Appear in Mac OS X Printer Window

If your product does not appear in the Mac OS X printer window, try these solutions:

- Turn your product off, wait 30 seconds, then turn it back on again.
- If you are connecting the product wirelessly via EpsonNet Setup and the WiFi light on your product is not solid green, make sure your product software was installed correctly. If necessary, reinstall your software.

Parent topic: [Solving Network Problems](#)

Related concepts

[When to Uninstall Your Product Software](#)

Cannot Print Over a Network

If you cannot print over a network, try these solutions:

- Make sure that your product is turned on.
- Make sure you install your product's network software as described in your product documentation.
- Print a network status sheet and verify that the network settings are correct. If the network status is **Disconnected**, check any cable connections and turn your product off and then on again.
- If you are using TCP/IP, make sure the product's IP address is set correctly for your network. If your network does not assign IP addresses using DHCP, set the IP address manually.
- Make sure your computer and product are both using the same wireless network.
- If network printing is slow, print a network status sheet and check the signal strength. If it is poor, place your product closer to your router or access point.

Note: Avoid placing your product near a microwave oven, 2.4 GHz cordless phone, or large metal object, such as a filing cabinet.

- Check your wired LAN router or access point to see if the LED for the port to which your product is connected is on or flashing . If the link LED is off, try the following:
 - Make sure the Ethernet cable is securely connected to your product and to your router, access point, switch, or hub.
 - Try connecting your product to a different port or a different router, access point, switch, or hub.
 - Try connecting with a different Ethernet cable.
 - Try printing to your product from another computer on the network.
- If you are connecting the product via EpsonNet Setup and the WiFi light on your product is not solid green , make sure your product software was installed correctly. If necessary, reinstall your software.

Parent topic: [Solving Network Problems](#)

Related concepts

[When to Uninstall Your Product Software](#)

Related tasks

[Printing a Network Status Sheet](#)

Cannot Scan Over a Network

If you cannot start Epson Scan for scanning over a network, try these solutions:

- If you are scanning a large original at a high resolution, a network communication error may occur. Try scanning again at a lower resolution.
- If network communication was interrupted while starting Epson Scan, exit Epson Scan, wait a few seconds, and restart it. If Epson Scan cannot restart, turn off your product, turn it back on, and try restarting Epson Scan again.
- Check the connection setting and test the connection using Epson Scan Settings:

Windows 8.x: Navigate to the **Apps** screen and select **EPSON Scan Settings**. Make sure the **Connection** setting is set to **Network**, then click the **Test** button.

Windows (other versions): Click  or **Start > All Programs** or **Programs > EPSON > EPSON Scan > EPSON Scan Settings**. Make sure the **Connection** setting is set to **Network**, then click the **Test** button.

Mac OS X: Open the **Applications** folder, click **Epson Software**, and click **EPSON Scan Settings**. Make sure the **Connection** setting is set to **Network**, then click the **Test** button.

- Make sure the option selected as the **Timeout Setting** in the Epson Scan Settings program is long enough to complete scanning over a network.
- You may need to disable the firewall and any anti-virus software on your wireless router or access point.

Note: With OS X 10.6, 10.7, 10.8, or 10.9, in addition to scanning with Image Capture, you can download and install Epson Scan scanning software. Epson Scan provides additional image adjustment and photo correction features for enhancing scanned images, and provides an interface for TWAIN-compliant OCR scanning software, such as ABBYY FineReader. To download Epson Scan, visit Epson's driver download site ([U.S. downloads](#) or [Canadian downloads](#)).

Parent topic: [Solving Network Problems](#)

Related topics

[Scanning](#)

Printing a Network Status Sheet

You can print a network status sheet to help you determine the causes of any problems you may have using your product on a network.

1. Press the  home button, if necessary.

2. Press the left or right arrow button and then select **Setup**.
3. Scroll down and select **Wi-Fi/Network Settings**.

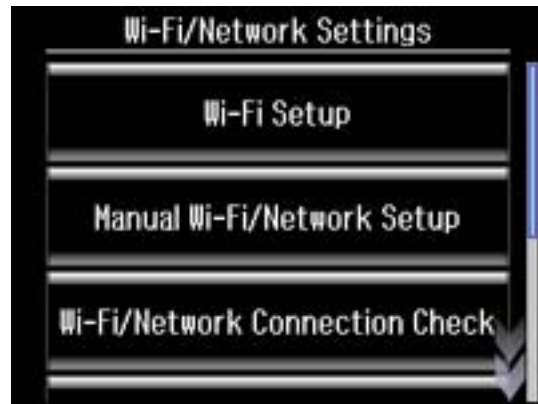

4. Select **Wi-Fi/Network Status**.
5. Select **Print the status sheet**.
6. Press the \diamond start button to print the network status sheet.
(Select **Cancel** if you want to cancel the operation.)

Examine the settings shown on the network status sheet to diagnose any problems you have.

Parent topic: [Solving Network Problems](#)

Solving Copying Problems

Check these solutions if you have problems copying with your product.

[Product Makes Noise, But Nothing Copies](#)

[Product Makes Noise When It Sits for a While](#)

Parent topic: [Solving Problems](#)

Product Makes Noise, But Nothing Copies

If your product makes a noise, but nothing copies, try these solutions:

- Run a nozzle check to see if any of the print head nozzles are clogged. Then clean the print head, if necessary.

- If the nozzle check page does not print, but the product's power is on, make sure your product software is installed correctly.
- Make sure your product is level (not tilted).

Parent topic: [Solving Copying Problems](#)

Related concepts

[Print Head Nozzle Check](#)

[Print Head Cleaning](#)

Product Makes Noise When It Sits for a While

Your product is performing routine maintenance. This is normal.

Parent topic: [Solving Copying Problems](#)

Solving Paper Problems

Check these sections if you have problems using paper with your product.

[Paper Feeding Problems](#)

[Paper Jam Problems Inside the Product](#)

[Paper Jam Problems in the Paper Cassette](#)

[Paper Jam Problems in the Auto Duplexer](#)

[Paper Jams in the Automatic Document Feeder](#)

[Paper Ejection Problems](#)

Parent topic: [Solving Problems](#)

Paper Feeding Problems

If you have problems feeding paper, try these solutions:

- Make sure the paper cassette is inserted all the way in the printer.
- If paper does not feed correctly, remove and reload it against the right side of the cassette and adjust the edge guides. Make sure the paper stack is not above the tab on the edge guides inside the cassette.
- If multiple pages feed at once, remove the paper, fan the edges to separate the sheets, and reload it.
- Do not load more than the recommended number of sheets.
- Make sure your paper meets the specifications for your product.
- If paper jams when you print on both sides of the paper, try loading fewer sheets.

- For best results, follow these guidelines:
 - Use new, smooth, high-quality paper that is not curled, creased, old, too thin, or too thick.
 - Load paper in the cassette printable side down.
 - Follow any special loading instructions that came with the paper.

Parent topic: [Solving Paper Problems](#)

Related references

[Paper Loading Capacity](#)

[Paper Jam Problems Inside the Product](#)

[Paper Jam Problems in the Paper Cassette](#)

[Paper Jam Problems in the Auto Duplexer](#)

[Paper Jams in the Automatic Document Feeder](#)

Related topics

[Loading Paper](#)

Paper Jam Problems Inside the Product

If you see a message that paper has jammed inside the product, follow the steps below or on the LCD screen to clear the jam.

1. Cancel the print job, if necessary.
2. Remove any jammed paper from the rear paper feed slot.

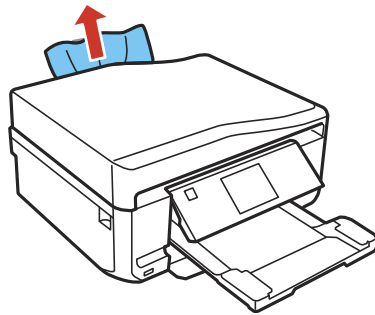

3. Lift the scanner unit and remove any jammed paper inside.

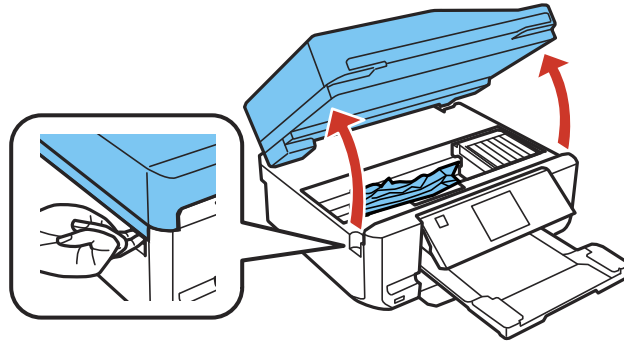

Caution: Do not touch the flat white cable inside the printer.

4. Close the scanner unit.

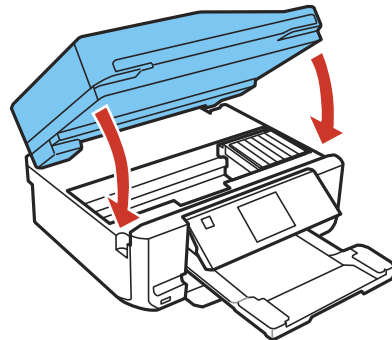

5. Follow the prompts on the LCD screen to clear any error messages. If you still see a paper jam message, check the other paper jam solutions.

Parent topic: [Solving Paper Problems](#)

Related references

[Paper Jam Problems in the Paper Cassette](#)

[Paper Jam Problems in the Auto Duplexer](#)

[Paper Jams in the Automatic Document Feeder](#)

Paper Jam Problems in the Paper Cassette

If you see a message that paper has jammed in the paper cassette, follow the steps below or on the LCD screen to clear the jam.

1. Cancel the print job, if necessary.
2. Pull out both paper cassettes, then carefully remove any jammed paper.

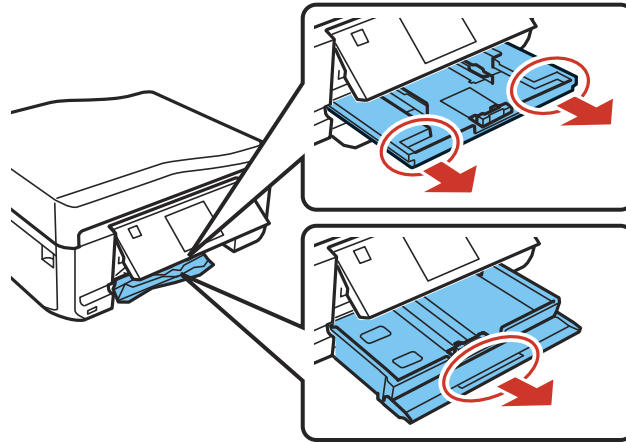

3. Make sure the paper you loaded is under the edge guides.
4. Keep the cassette flat as you insert it. If inserting Cassette 1 (upper cassette), insert it until the arrows on the right side line up.
5. Follow the prompts on the LCD screen to clear any error messages. If you still see a paper jam message, check the other paper jam solutions.

Parent topic: [Solving Paper Problems](#)

Related references

[Paper Jam Problems Inside the Product](#)

[Paper Jam Problems in the Auto Duplexer](#)

[Paper Jams in the Automatic Document Feeder](#)

Paper Jam Problems in the Auto Duplexer

If you see a message that paper has jammed in the auto duplexer, follow the steps below or on the LCD screen to clear the jam.

1. Cancel the print job, if necessary.
2. Press the buttons to release the auto duplexer and remove the duplexer from your product. Carefully remove any jammed paper from inside the unit.

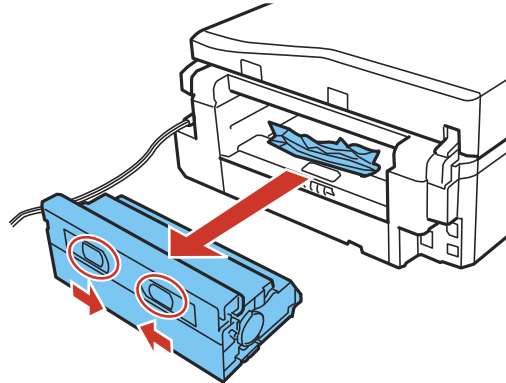

3. Remove any jammed paper from the duplexer.

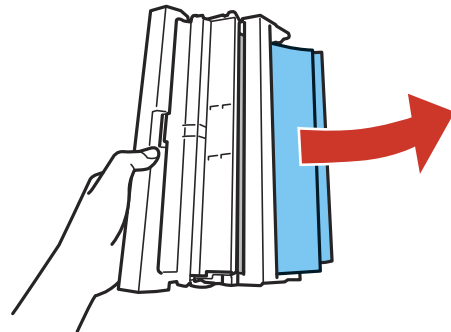

4. Open the duplexer and remove any jammed paper from inside it.

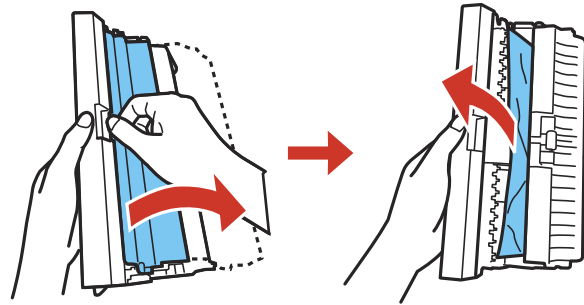

5. Reattach the duplexer.

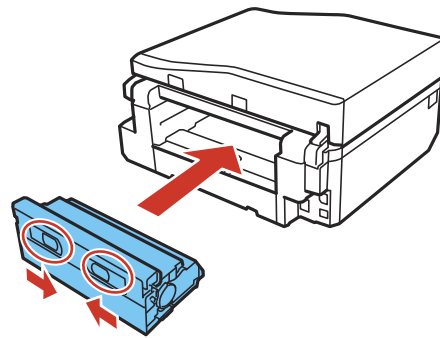

6. Follow the prompts on the LCD screen to clear any error messages. If you still see a paper jam message, check the other paper jam solutions.

Parent topic: [Solving Paper Problems](#)

Related references

[Paper Jam Problems Inside the Product](#)

[Paper Jam Problems in the Paper Cassette](#)

[Paper Jams in the Automatic Document Feeder](#)

Paper Jams in the Automatic Document Feeder

If you have problems with paper jams in the automatic document feeder (ADF), follow the steps below or on the LCD screen to clear the jam.

1. Cancel the print job, if necessary.
2. Remove your originals from the ADF.
3. Open the ADF cover, then carefully remove any jammed paper.

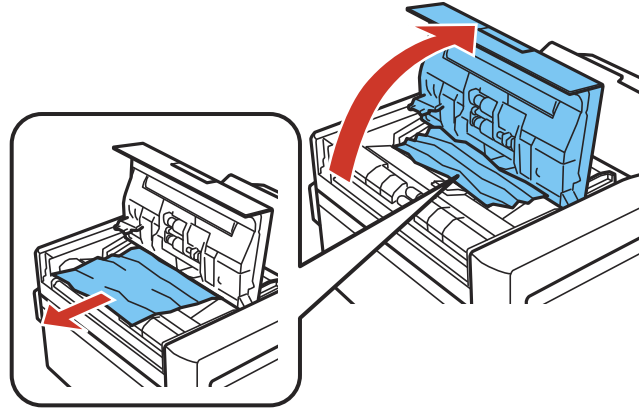

Caution: Make sure you open the ADF cover before removing any jammed paper. Otherwise the product may be damaged.

4. Leave the ADF cover open, then raise the scanner unit.

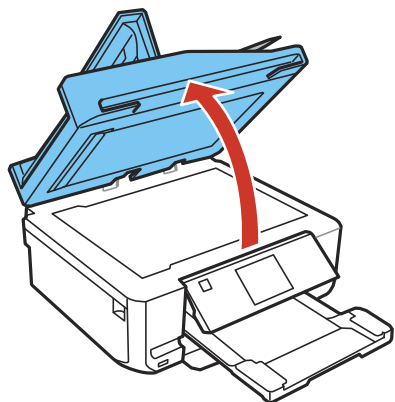

5. Press the tabs and remove the document mat.

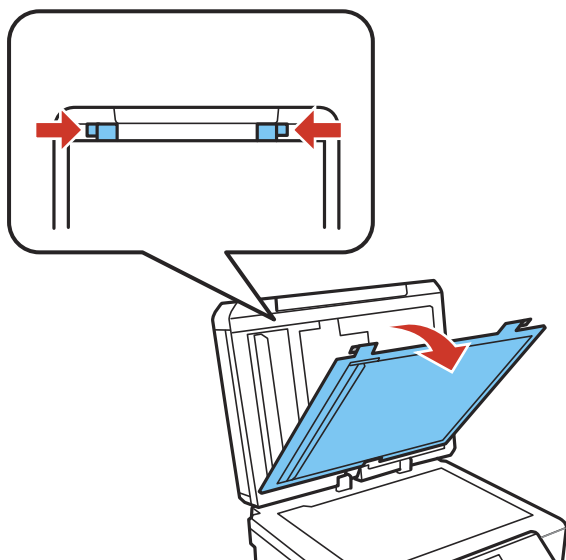

6. Carefully remove any jammed paper.

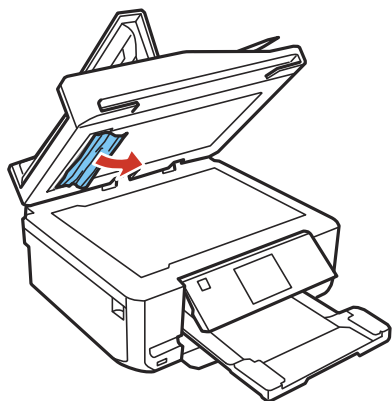

7. Reattach the document mat, lower the scanner unit, and close the ADF cover.
8. Open the ADF as shown.

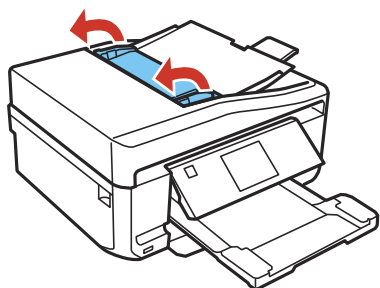

9. Carefully remove any jammed paper from beneath the ADF.

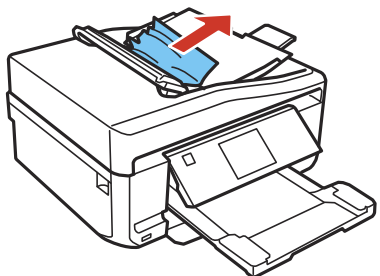

10. Close the ADF.
11. Reload your originals.

Caution: Do not load the ADF beyond its capacity for your paper size. Also make sure your originals are not bent, folded, or curled and do not have tape, staples, or other materials that could obstruct the feeder.

12. Follow the prompts on the LCD screen to clear any error messages. If you still see a paper jam message, check the other paper jam solutions.

Parent topic: [Solving Paper Problems](#)

Related references

- [Paper Jam Problems Inside the Product](#)
- [Paper Jam Problems in the Paper Cassette](#)
- [Paper Jam Problems in the Auto Duplexer](#)
- [Automatic Document Feeder \(ADF\) Specifications](#)

Paper Ejection Problems

If you have problems with paper ejecting properly, try these solutions:

- If paper does not eject fully, you may have set the wrong paper size. Cancel printing to eject the paper. Select the correct paper size when you reprint.
- If paper is wrinkled when it ejects, it may be damp or too thin. Load new paper and be sure to select the correct paper type setting when you reprint.

Parent topic: [Solving Paper Problems](#)

Related references

- [Paper or Media Type Settings](#)
- [Paper Jam Problems Inside the Product](#)
- [Paper Jam Problems in the Paper Cassette](#)
- [Paper Jam Problems in the Auto Duplexer](#)
- [Paper Jams in the Automatic Document Feeder](#)

Related tasks

- [Cancelling Printing Using a Product Button](#)

Related topics

- [Loading Paper](#)

Solving Problems Printing from a Computer

Check these sections if you have problems while printing from your computer.

[Nothing Prints](#)

[Product Icon Does Not Appear in Windows Taskbar](#)

[Error After Cartridge Replacement](#)

[Printing is Slow](#)

Parent topic: [Solving Problems](#)

Nothing Prints

If you have sent a print job and nothing prints, try these solutions:

- Make sure your product is turned on.
- Make sure any interface cables are connected securely at both ends.
- If you connected your product to a USB hub, make sure it is a first-tier hub. If it still does not print, connect your product directly to your computer instead of the hub.
- Run a product check to see if a test page prints. If the test page prints, check to see if your product software is installed correctly.
- In Windows, make sure your product is selected as the default printer.
- In Windows, clear any stalled print jobs from the Windows Spooler:
 - **Windows 8.x:** Navigate to the **Apps** screen and select **Control Panel > Hardware and Sound > Devices and Printers**. Right-click your product name, select **See what's printing**, and select your product name again if necessary. Right-click the stalled print job, click **Cancel**, and click **Yes**.
 - **Windows 7:** Click  and select **Devices and Printers**. Right-click your product name, select **See what's printing**, and select your product name again, if necessary. Right-click the stalled print job, click **Cancel**, and click **Yes**.
 - **Windows Vista:** Click  and select **Control Panel**. Click **Printer** under **Hardware and Sound**, right-click your product name, and select **Open**. Right click the stalled print job, click **Cancel**, and click **Yes**.
 - **Windows XP:** Click **Start** and select **Printers and Faxes**. (Or open the **Control Panel**, select **Printers and Other Hardware**, if necessary, and select **Printers and Faxes**.) Right-click your product name, select **Open**, right-click the stalled print job, click **Cancel**, and click **Yes**.



Parent topic: [Solving Problems Printing from a Computer](#)

Related tasks

[Running a Product Check](#)

Product Icon Does Not Appear in Windows Taskbar

If you do not see your product icon in the Windows taskbar, first try restarting your computer. If that does not work, try this solution:

1. Do one of the following:
 - **Windows 8.x:** Navigate to the **Apps** screen and select **Control Panel > Hardware and Sound > Devices and Printers**.
 - **Windows 7:** Click  and select **Devices and Printers**.
 - **Windows Vista:** Click , select **Control Panel**, and click **Printer** under **Hardware and Sound**.
 - **Windows XP:** Click **Start** and select **Printers and Faxes**. (Or open the **Control Panel**, select **Printers and Other Hardware**, if necessary, and **Printers and Faxes**.)
2. Right-click your product name, select **Printing Preferences**, and select your product name again if necessary.
3. Click the **Maintenance** tab.
4. Click the **Extended Settings** button.
5. Click the **Monitoring Preferences** button.
6. Click the **Register the shortcut icon to the taskbar** checkbox.
7. Click **OK** to close the open program windows.

Parent topic: [Solving Problems Printing from a Computer](#)

Error After Cartridge Replacement

If you see an error light or error message after you replace an ink cartridge, follow these steps:

1. Make sure the print head is in the ink cartridge replacement position. (The ink cartridge holder should be beneath the cutout in the product case.)

Note: If the print head is not in the ink cartridge replacement position, follow the instructions on replacing an ink cartridge in this manual to move it.

2. Remove and reinsert the replaced ink cartridge, making sure to push it all the way into its slot.
3. Complete the ink cartridge installation steps.

Parent topic: [Solving Problems Printing from a Computer](#)

Related topics

[Replacing Ink Cartridges](#)

Printing is Slow

If printing becomes slow, try these solutions:

- Make sure your system meets the requirements for your operating system. If you are printing a high-resolution image, you may need more than the minimum requirements. If necessary, increase your system's memory.
- If you are using Windows 7, close the **Devices and Printers** window before you print.
- Clear space on your hard drive or run a defragmentation utility to free up existing space.
- Close any programs you are not using when you print.
- If your product is connected to a USB hub, connect it directly to your computer instead.
- If printing becomes slower after printing continuously for a long time, the product may have automatically slowed down to protect the print mechanism from overheating or becoming damaged. Let the product rest with the power on for 30 minutes, then try printing again.

For the fastest printing, select the following settings in your product software:

- Make sure the paper type setting matches the type of paper you loaded.
- Turn on any high speed settings in your product software.
- Select a lower print quality setting.
- **Windows:** Click the **Maintenance** tab, select **Extended Settings**, and select the following settings:
 - **High Speed Copies**
 - **Always spool RAW datatype**
 - **Page Rendering Mode**
 - **Print as Bitmap**

Parent topic: [Solving Problems Printing from a Computer](#)

Related references

[Windows System Requirements](#)

[Mac System Requirements](#)

[Paper or Media Type Settings](#)

Related tasks

[Selecting Basic Print Settings - Windows](#)

[Selecting Basic Print Settings - Mac OS X](#)

Solving Page Layout and Content Problems

Check these sections if you have problems with the layout or content of your printed pages.

[Inverted Image](#)

[Too Many Copies Print](#)

[Blank Pages Print](#)

[Incorrect Margins on Printout](#)

[Border Appears on Borderless Prints](#)

[Incorrect Characters Print](#)

[Incorrect Image Size or Position](#)

[Slanted Printout](#)

Parent topic: [Solving Problems](#)

Inverted Image

If your printed image is inverted unexpectedly, try these solutions:

- Turn off any mirror or inversion settings in your printing application.
- Turn off the **Mirror Image**, **Flip horizontally**, or **Reverse page orientation** settings in your printer software. (This option has different names, depending on your operating system version.)

Note: Leave these options turned on when you print on Epson Iron-on Cool Peel Transfer paper, if available for your product.

Parent topic: [Solving Page Layout and Content Problems](#)

Related tasks

[Selecting Print Layout Options - Windows](#)

[Selecting Basic Print Settings - Mac OS X](#)

Too Many Copies Print

Make sure that the **Copies** setting in your printing program or printer software is not set for multiple copies.

Parent topic: [Solving Page Layout and Content Problems](#)

Blank Pages Print

If blank pages print unexpectedly, try these solutions:

- Make sure you selected the correct paper size settings in your printing program and printer software.
- If a blank page exists in a document you are printing and you want to skip printing it, select the **Skip Blank Page** setting in your printer software.
- Run a print head nozzle check to see if any of the nozzles are clogged. Then clean the print head, if necessary.
- Make sure your product is selected as the printer in your printing program.

Parent topic: [Solving Page Layout and Content Problems](#)

Related concepts

[Print Head Nozzle Check](#)

[Print Head Cleaning](#)

Related references

[Printing Preferences - Mac OS X](#)

Related tasks

[Selecting Basic Print Settings - Windows](#)

[Selecting Basic Print Settings - Mac OS X](#)

Incorrect Margins on Printout

If your printed page has incorrect margins, try these solutions:

- Make sure you selected the correct paper size settings in your printing program and printer software.
- Make sure you selected the correct margins for your paper size in your printing program.
- Make sure your paper is positioned correctly for feeding into the printer.

You can use the preview option in your printer software to check your margins before you print.

Parent topic: [Solving Page Layout and Content Problems](#)

Related tasks

[Selecting Print Layout Options - Windows](#)

[Selecting Basic Print Settings - Mac OS X](#)

Related topics

[Loading Paper](#)

Border Appears on Borderless Prints

If you see a border on borderless prints, try these solutions:

- Make sure you are printing on a compatible borderless paper type and size.

Note: Do not select a custom paper size for borderless prints.

- **Windows:** Make sure you selected the **Borderless** setting in your printer software.
- **Mac OS X:** Make sure you selected the **Borderless** checkbox or a paper size with a **Borderless** option in your printer software.
- Adjust the **Expansion** setting to adjust the amount of image expansion on the edges of borderless prints.
- Make sure the image size and the paper size are set correctly; if the image is small, the enlargement may not be enough to cover the paper.

Parent topic: [Solving Page Layout and Content Problems](#)

Related references

[Borderless Paper Type Compatibility](#)

Related tasks

[Selecting Basic Print Settings - Windows](#)

[Selecting Print Layout Options - Windows](#)



[Selecting Basic Print Settings - Mac OS X](#)

[Selecting Page Setup Settings - Mac OS X](#)

Incorrect Characters Print

If incorrect characters appear in your prints, try these solutions before reprinting:

- Make sure any cables are securely connected at both ends.
- In Windows, delete all print jobs from the Windows Spooler:
 - **Windows 8.x:** Navigate to the **Apps** screen and select **Control Panel > Hardware and Sound > Devices and Printers**. Right-click your product name, select **See what's printing**, and select your product name again, if necessary. Right-click the stalled print job, click **Cancel**, and click **Yes**.

- **Windows 7:** Click  and select **Devices and Printers**. Right-click your product name, select **See what's printing**, and select your product name again, if necessary. Right-click the stalled print job, click **Cancel**, and click **Yes**.
- **Windows Vista:** Click  and select **Control Panel**. Click **Printer** under **Hardware and Sound**, right-click your product name, and select **Open**. Right click the stalled print job, click **Cancel**, and click **Yes**.
- **Windows XP:** Click **Start** and select **Printers and Faxes**. (Or open the **Control Panel**, select **Printers and Other Hardware** if necessary, and select **Printers and Faxes**.) Right-click your product name, select **Open**, right-click the stalled print job, click **Cancel**, and click **Yes**.
- Make sure your product is selected as the printer in your printing program.
- If your product is connected to a USB hub, connect it directly to your computer instead.

Parent topic: [Solving Page Layout and Content Problems](#)

Incorrect Image Size or Position

If your printed image is the wrong size or in the wrong position, try these solutions:

- Make sure you selected the correct paper size and layout settings in your printing program and printer software.
- Make sure your paper is positioned correctly for feeding into the printer.

You can use the preview option in your printer software to check your margins before you print.

Parent topic: [Solving Page Layout and Content Problems](#)

Related tasks

[Selecting Basic Print Settings - Windows](#)

[Selecting Print Layout Options - Windows](#)

[Selecting Basic Print Settings - Mac OS X](#)

[Selecting Page Setup Settings - Mac OS X](#)

Related topics

[Loading Paper](#)

Slanted Printout

If your printouts are slanted, try these solutions:

- Slide the edge guides against the edges of the paper.
- Select a higher print quality setting in your printer software.

- Align the print head.
- Make sure the product is not printing while tilted or at an angle.

Parent topic: [Solving Page Layout and Content Problems](#)

Related concepts

[Print Head Alignment](#)

Related tasks

[Selecting Basic Print Settings - Windows](#)

[Selecting Basic Print Settings - Mac OS X](#)

Solving Print Quality Problems

Check these sections if your printouts have problems with print quality, but your image looks fine on your computer screen.

[White or Dark Lines in Printout](#)

[Blurry or Smearred Printout](#)

[Faint Printout or Printout Has Gaps](#)

[Grainy Printout](#)

[Incorrect Colors](#)

Parent topic: [Solving Problems](#)

Related topics

[Solving Scanned Image Quality Problems](#)

White or Dark Lines in Printout

If you notice white or dark lines in your prints (also called banding), try these solutions before you reprint:

- Run a nozzle check to see if any of the print head nozzles are clogged. Then clean the print head, if necessary.
- Make sure the paper type setting matches the type of paper you loaded.
- Make sure you loaded the printable side of the paper correctly for your product.
- Turn off any high speed settings in your product software.
- Align the print head.
- You may need to replace the ink cartridges.

Parent topic: [Solving Print Quality Problems](#)

Related concepts

[Print Head Nozzle Check](#)

[Print Head Cleaning](#)

[Print Head Alignment](#)

Related references

[Paper or Media Type Settings](#)

[Printing Preferences - Mac OS X](#)

Related tasks

[Selecting Advanced Print Settings - Windows](#)

Related topics

[Loading Paper](#)

[Replacing Ink Cartridges](#)

Blurry or Smearred Printout

If your printouts are blurry or smearred, try these solutions:

- Make sure your paper is not damp, curled, old, or loaded incorrectly in your product.
- Use a support sheet with special paper, or load special paper one sheet at a time.
- Make sure your paper meets the specifications for your product.
- Use Epson papers to ensure proper saturation and absorption of genuine Epson inks.
- Make sure the paper type setting in your product software matches the type of paper you loaded.
- Remove each sheet from the output tray as it is printed.
- Avoid handling printouts on glossy paper right after printing to allow the ink to set.
- Turn off any high speed settings in your product software.
- If you print on both sides of a sheet of paper, smudges may appear on the reverse side of heavily saturated or dark images. If one side of a sheet will contain a lighter image or text, print that side first. Adjust the **Print Density** and/or **Increased Ink Drying Time** settings.
- Run a nozzle check to see if any of the print head nozzles are clogged. Then clean the print head, if necessary.
- Align the print head.
- Clean the paper path.

Note: Your product will not operate properly while tilted at an angle. Place it on a flat, stable surface that extends beyond the base of the product in all directions.

Parent topic: [Solving Print Quality Problems](#)

Related concepts

[Print Head Nozzle Check](#)

[Print Head Cleaning](#)

Related references

[Printing Preferences - Mac OS X](#)

[Paper Specifications](#)

Related tasks

[Selecting Basic Print Settings - Windows](#)

[Selecting Advanced Print Settings - Windows](#)

[Selecting Double-sided Printing Settings - Windows](#)

[Selecting Basic Print Settings - Mac OS X](#)

[Selecting Double-sided Printing Settings - Mac OS X](#)

[Cleaning the Paper Path](#)

Related topics

[Loading Paper](#)

Faint Printout or Printout Has Gaps

If your printouts are faint or have gaps, try these solutions:

- Run a nozzle check to see if any of the print head nozzles are clogged. Then clean the print head, if necessary.
- The ink cartridges may be old or low on ink, and you may need to replace them.
- Make sure the paper type setting matches the type of paper you loaded.
- Make sure your paper is not damp, curled, old, or loaded incorrectly in your product.
- Align the print head.
- Clean the paper path.

Parent topic: [Solving Print Quality Problems](#)

Related concepts

[Print Head Nozzle Check](#)

[Print Head Cleaning](#)

[Print Head Alignment](#)

Related references

[Paper or Media Type Settings](#)

Related tasks

[Cleaning the Paper Path](#)

Related topics

[Loading Paper](#)

[Replacing Ink Cartridges](#)

Grainy Printout

If your printouts are grainy, try these solutions:

- Make sure you loaded the printable side of the paper correctly for your product.
- Select a higher print quality setting and turn off any high speed settings in your product software.
- Run a nozzle check to see if any of the print head nozzles are clogged. Then clean the print head, if necessary.
- Align the print head.
- You may need to increase the image resolution or print a smaller size; see your software documentation.
- If you enlarged the image in an image-editing program, you need to increase the resolution setting to retain a high image quality. Increase the resolution by the same amount you increased the image size. For example, if the resolution is 300 dpi (dots per inch) and you will double the image size later, change the resolution setting to 600 dpi.

Note: Higher resolution settings result in larger file sizes, which take longer to process and print. Consider the limitations of your computer system when selecting a resolution, and select the lowest possible resolution that produces acceptable quality to keep file sizes manageable.

Parent topic: [Solving Print Quality Problems](#)

Related concepts

[Print Head Nozzle Check](#)

[Print Head Cleaning](#)

[Print Head Alignment](#)

Related references

[Printing Preferences - Mac OS X](#)

Related tasks

[Selecting Basic Print Settings - Windows](#)

[Selecting Advanced Print Settings - Windows](#)

[Selecting Basic Print Settings - Mac OS X](#)

Related topics

[Loading Paper](#)

Incorrect Colors

If your printouts have incorrect colors, try these solutions:

- Make sure the **Black/Grayscale** or **Grayscale** setting is not selected in your printer software.
- Run a nozzle check to see if any of the print head nozzles are clogged. Then clean the print head, if necessary.
- The ink cartridges may be old or low on ink, and you may need to replace them.
- Your printed colors can never exactly match your on-screen colors. However, you can use a color management system to get as close as possible. Try using the color management options in your printer software.
- For best results, use genuine Epson ink and paper.

Parent topic: [Solving Print Quality Problems](#)

Related concepts

[Print Head Nozzle Check](#)

[Print Head Cleaning](#)

Related tasks

[Selecting Basic Print Settings - Windows](#)

[Selecting Advanced Print Settings - Windows](#)

[Selecting Basic Print Settings - Mac OS X](#)

[Managing Color - Mac OS X](#)

Related topics

[Replacing Ink Cartridges](#)

Solving Scanning Problems

Check these solutions if you have problems scanning with your product.

[Scanning Software Does Not Operate Correctly](#)

[Cannot Start Epson Scan](#)

Parent topic: [Solving Problems](#)

Scanning Software Does Not Operate Correctly

If your scanning software does not operate correctly, try these solutions:

- Make sure your computer has adequate memory and meets the system requirements for your operating system.
- Make sure your computer is not running in a power-saving mode, such as sleep or standby. If so, wake your system and restart your scanning software.
- If you upgraded your operating system but did not reinstall your scanning software, try reinstalling it.

Note: With OS X 10.6, 10.7, 10.8, or 10.9, in addition to scanning with Image Capture, you can download and install Epson Scan scanning software. Epson Scan provides additional image adjustment and photo correction features for enhancing scanned images, and provides an interface for TWAIN-compliant OCR scanning software, such as ABBYY FineReader. To download Epson Scan, visit Epson's driver download site ([U.S. downloads](#) or [Canadian downloads](#)).

Parent topic: [Solving Scanning Problems](#)

Related concepts

[When to Uninstall Your Product Software](#)

Related references

[Windows System Requirements](#)

[Mac System Requirements](#)

Related tasks

[Scanning with OS X Using Image Capture](#)

Cannot Start Epson Scan

If you cannot start Epson Scan, try these solutions:

- Make sure your product is turned on and any interface cables are securely connected at both ends.
- Make sure Epson Scan is selected in your scanning program.

- Make sure your computer is not running in a power-saving mode, such as sleep or standby. If so, wake your system and restart Epson Scan.
- Check the connection setting and test the connection using Epson Scan Settings:
Windows 8.x: Navigate to the **Apps** screen and select **EPSON Scan Settings**. Make sure the correct **Connection** setting is selected, then click the **Test** button.
Windows (other versions): Click  or **Start > All Programs** or **Programs > EPSON > EPSON Scan > EPSON Scan Settings**. Make sure the correct **Connection** setting is selected, then click the **Test** button.
Mac OS X: Open the **Applications** folder, click **Epson Software**, and click **EPSON Scan Settings**. Make sure the correct **Connection** setting is selected, then click the **Test** button.
- Make sure you do not have multiple versions of Epson Scan installed. If you do, uninstall both versions and install one version.
- If you upgraded your operating system but did not reinstall Epson Scan, try reinstalling it.

Note: With OS X 10.6, 10.7, 10.8, or 10.9, in addition to scanning with Image Capture, you can download and install Epson Scan scanning software. Epson Scan provides additional image adjustment and photo correction features for enhancing scanned images, and provides an interface for TWAIN-compliant OCR scanning software, such as ABBYY FineReader. To download Epson Scan, visit Epson's driver download site ([U.S. downloads](#) or [Canadian downloads](#)).

Parent topic: [Solving Scanning Problems](#)

Related tasks

[Scanning with OS X Using Image Capture](#)

Related topics

[Starting a Scan](#)

Solving Scanned Image Quality Problems

Check these sections if a scanned image on your computer screen has a quality problem.

[Image Consists of a Few Dots Only](#)

[Line of Dots Appears in All Scanned Images](#)

[Straight Lines in an Image Appear Crooked](#)

[Image is Distorted or Blurry](#)

[Image Colors are Patchy at the Edges](#)

[Image is Too Dark](#)
[Back of Original Image Appears in Scanned Image](#)
[Ripple Patterns Appear in an Image](#)
[Scanned Image Colors Do Not Match Original Colors](#)
[Scan Area is Not Adjustable in Thumbnail Preview](#)
[Scanned Image Edges are Cropped](#)

Parent topic: [Solving Problems](#)

Related topics

[Solving Print Quality Problems](#)

Image Consists of a Few Dots Only

If your scanned image consists only of a few dots, try these solutions:

- Make sure you placed your original for scanning facing the correct way.
- If you are scanning using the Epson Scan **Black & White** setting, adjust the **Threshold** setting and scan again.

Parent topic: [Solving Scanned Image Quality Problems](#)

Related references

[Available Image Adjustments - Office Mode](#)

[Available Image Adjustments - Home Mode](#)

[Available Image Adjustments - Professional Mode](#)

Related topics

[Placing Originals on the Product](#)

Line of Dots Appears in All Scanned Images

If a line of dots appears in all your scanned images, clean the scanner glass with a soft, dry, lint-free cloth or use a small amount of glass cleaner on the cloth, if necessary. Paper towels are not recommended.

Caution: Do not spray glass cleaner directly on the scanner glass.

Parent topic: [Solving Scanned Image Quality Problems](#)

Related tasks

[Cleaning Your Product](#)

Straight Lines in an Image Appear Crooked

If straight lines in an original appear crooked in a scanned image, make sure to place your original straight when you scan it.

Parent topic: [Solving Scanned Image Quality Problems](#)

Related topics

[Placing Originals on the Product](#)

Image is Distorted or Blurry

If a scanned image appears distorted or blurry, try these solutions:

- Make sure your original is not wrinkled or warped. This may prevent the original from laying flat on the scanner glass.
- Do not move your original or your product during scanning.
- Your product will not operate properly while tilted at an angle. Place it on a flat, stable surface that extends beyond the base of the product in all directions.
- Adjust these Epson Scan settings (if available) and try scanning again:
 - Select the **Unsharp Mask** setting.
 - Adjust the **Auto Exposure** setting.
 - Increase the **Resolution** setting.

Parent topic: [Solving Scanned Image Quality Problems](#)

Related topics

[Selecting Epson Scan Settings](#)

Image Colors are Patchy at the Edges

If you are scanning a thick or warped original, cover its edges with paper to block external light as you scan it.

Parent topic: [Solving Scanned Image Quality Problems](#)

Image is Too Dark

If your scanned image is too dark, try these solutions:

- Adjust these Epson Scan settings (if available) and try scanning again:
 - **Auto Exposure**

- **Brightness**
- **Histogram Adjustment**
- Check the brightness and contrast settings of your computer monitor.

Parent topic: [Solving Scanned Image Quality Problems](#)

Related topics

[Selecting Epson Scan Settings](#)

Back of Original Image Appears in Scanned Image

If an image from the back of a thin original appears in your scanned image, place a piece of black paper on the back of the original and scan it again.

Parent topic: [Solving Scanned Image Quality Problems](#)

Ripple Patterns Appear in an Image

You may see a ripple pattern (called a moiré) in scanned images of printed documents. This is caused by interference from differing pitches in the scanner's screen and your original's halftone screen. To reduce this effect, adjust these Epson Scan settings (if available) and try scanning again:

- Select the **Descreening** setting.
- Select a lower **Resolution** setting.

Parent topic: [Solving Scanned Image Quality Problems](#)

Related topics

[Selecting Epson Scan Settings](#)

Scanned Image Colors Do Not Match Original Colors

Printed colors can never exactly match the colors on your computer monitor because printers and monitors use different color systems: monitors use RGB (red, green, and blue) and printers typically use CMYK (cyan, magenta, yellow, and black).

Check the color matching and color management capabilities of your computer, display adapter, and the software you are using to see if they are affecting the palette of colors you see on your screen.

To adjust the colors in your scanned image, adjust these Epson Scan settings (if available) and try scanning again:

- Change the **Image Type** setting and experiment with different combinations of the next settings.
- Adjust the **Tone Correction** setting.

- Adjust the **Auto Exposure** setting.

Parent topic: [Solving Scanned Image Quality Problems](#)

Related topics

[Selecting Epson Scan Settings](#)

Scan Area is Not Adjustable in Thumbnail Preview

If you cannot adjust the scan area while viewing a Thumbnail preview in Epson Scan, try these solutions:

- Create a scan area by drawing a marquee on your preview image and adjusting it as necessary.
- Switch to Normal preview mode, if available, and preview your image again.

Parent topic: [Solving Scanned Image Quality Problems](#)

Related concepts

[Image Preview Guidelines](#)

Related tasks

[Selecting a Scan Area - Office Mode](#)

[Selecting a Scan Area - Home Mode](#)

[Selecting a Scan Area - Professional Mode](#)

Scanned Image Edges are Cropped

If the edges of a scanned image are cropped, make sure your original is placed correctly for scanning. If necessary, move your original away from the edges of the scanner glass slightly.

Parent topic: [Solving Scanned Image Quality Problems](#)

Related topics

[Placing Originals on the Product](#)

Solving Memory Card Problems

Check these solutions if you have problems using memory cards with your product.

[Memory Card Does Not Fit Into a Slot](#)

[Cannot View or Print Photos from a Memory Card](#)

[Cannot Transfer Photos To or From a Memory Card](#)

Parent topic: [Solving Problems](#)

Memory Card Does Not Fit Into a Slot

If a memory card does not fit properly in a slot, do not force it in. You may need to use an adapter with your memory card.

Parent topic: [Solving Memory Card Problems](#)

Related references

[Memory Card Types](#)

Related tasks

[Inserting a Memory Card](#)

Cannot View or Print Photos from a Memory Card

If you cannot view or print photos from a memory card inserted in your product, try these solutions:

- Make sure you have inserted only one memory card at a time.
- Make sure your memory card is compatible with the product.
- Make sure the files on your memory card are in the correct format.
- If you have too many photos on your memory card, you may not see all the photos you expect or may be prompted to select a group of photos by date. Reduce the number of photos on your card or select one group of photos at a time. Check the memory card specifications for the maximum number of photos.

Parent topic: [Solving Memory Card Problems](#)

Related references

[Memory Card Types](#)

[Memory Card File Specifications](#)

Related tasks

[Inserting a Memory Card](#)

Cannot Transfer Photos To or From a Memory Card

If you have problems transferring photos to or from a memory card inserted in your product, try these solutions:

- Make sure you have inserted only one memory card at a time.
- Make sure your memory card is compatible with the product.
- Make sure your product is securely connected to your computer.

- If you are transferring photos to the memory card, check the memory card's write-protect tab to make sure it is set to allow writing to the card.
- Make sure that the file sharing setting for your product is set correctly.

Parent topic: [Solving Memory Card Problems](#)

Related references

[Memory Card Types](#)

[Memory Card File Specifications](#)

Related topics

[Transferring Photos on a Memory Card](#)

Solving Faxing Problems

Check these solutions if you have problems faxing with your product.

[Cannot Send or Receive Faxes](#)

[Cannot Receive Faxes with a Telephone Connected to Your Product](#)

Parent topic: [Solving Problems](#)

Cannot Send or Receive Faxes

If you cannot send or receive faxes, try these solutions:

- Make sure the recipient's fax machine is turned on and working.
- Make sure paper is loaded correctly in your product.
- Make sure Auto Answer mode is turned on to receive faxes automatically. Check your product control panel to see if this mode is turned on.
- Check that the cable connecting your telephone wall jack to your product's **LINE** port is secure.
- Print a fax connection report using your product control panel or fax software to help diagnose the problem.
- Verify that the telephone wall jack works by connecting a phone to it and testing it.
- If you connected your product to a DSL phone line, you must connect a DSL filter to the phone jack to enable faxing over the line. Contact your DSL provider for the necessary filter.
- Try lowering your product's fax speed setting.
- Make sure the error correction mode (ECM) setting is turned on if you are trying to send or receive a color fax.

Note: If your product is connected to a VoIP (Voice over Internet Protocol) phone line, keep in mind that fax machines are designed to work over analog phone lines. Epson cannot guarantee that fax transmission will work when using VoIP.

If your phone line includes voice mail answering services, calls or faxes may be inadvertently received by your voice mail service.

Parent topic: [Solving Faxing Problems](#)

Related tasks

[Connecting a Telephone or Answering Machine](#)

[Receiving Faxes Automatically \(Auto Answer\)](#)

[Selecting Fax Communication Settings](#)

[Printing Fax Reports](#)

Related topics

[Loading Paper](#)

Cannot Receive Faxes with a Telephone Connected to Your Product

Make sure your telephone is connected to your product's **EXT** port.

Note: When answering a call that is a fax, wait until the product's LCD screen displays a message that a connection has been made before you hang up.

Parent topic: [Solving Faxing Problems](#)

Related tasks

[Connecting a Telephone or Answering Machine](#)

When to Uninstall Your Product Software

If you have a problem that requires you to uninstall and re-install your software, follow the instructions for your operating system.

[Uninstalling Product Software - Windows](#)

[Uninstalling Product Software - Mac OS X](#)

Parent topic: [Solving Problems](#)

Uninstalling Product Software - Windows

You can uninstall and then re-install your product software to solve certain problems.

1. Turn off the product.
2. Disconnect any interface cables.
3. Do one of the following:
 - **Windows 8.x:** Navigate to the **Apps** screen and select **Control Panel > Programs > Programs and Features**. Select the uninstall option for your Epson product, then select **Uninstall/Change**.

Note: If you see a **User Account Control** window, click **Yes** or **Continue**.

Select your product again, if necessary, then select **OK**, and click **Yes** to confirm the uninstallation.

- **Windows (other versions):** Click  or **Start**, and select **All Programs** or **Programs**. Select **EPSON**, select your product, then click **EPSON Printer Software Uninstall**.

Note: If you see a **User Account Control** window, click **Yes** or **Continue**.

In the next window, select your product and click **OK**. Then follow any on-screen instructions.

4. Do one of the following to uninstall Epson Event Manager, then follow any on-screen instructions:
 - **Windows 8.x:** Select **Epson Event Manager** and click **Uninstall**.
 - **Windows 7 or Windows Vista:** Open the Windows **Control Panel** utility. Select **Programs and Features**. (In Classic view, select **Programs** and click **Uninstall a program**.) Select **Epson Event Manager** and click **Uninstall/Change**.
 - **Windows XP:** Open the Windows **Control Panel** utility. Double-click **Add or Remove Programs**. Select **Epson Event Manager** and click **Change/Remove**.
5. Do one of the following to uninstall Epson Scan, then follow any on-screen instructions:
 - **Windows 8.x, Windows 7, or Windows Vista:** Select **EPSON Scan** and click **Uninstall/Change**.
 - **Windows XP:** Select **EPSON Scan** and click **Change/Remove**.
6. Restart your computer, then see the *Start Here* sheet to re-install your software.

Note: If you find that re-installing your product software does not solve a problem, contact Epson.

Parent topic: [When to Uninstall Your Product Software](#)

Uninstalling Product Software - Mac OS X

In most cases, you do not need to uninstall your product software before re-installing it. However, you can download the Uninstaller utility from the Epson support website to uninstall your product software as described here.

Note: If you find that re-installing your product software does not solve a problem, contact Epson.

1. To download the Uninstaller utility, visit the Epson download site ([U.S. downloads](#) or [Canadian downloads](#)).
2. Follow the instructions on the screen to install the Uninstaller utility.
3. Quit all applications currently running on your Mac.
4. Double-click the **Uninstaller** icon.
5. Select the checkbox for each software program you want to uninstall.
6. Click **Uninstall**.
7. Follow the on-screen instructions to uninstall the software.
8. To reinstall your product software, see the *Start Here* sheet for instructions.

Note: If you uninstall the printer driver and your product name remains in the Print & Fax, Print & Scan, or Printers & Scanners window, select your product name and click the – (remove) icon to remove it.

Parent topic: [When to Uninstall Your Product Software](#)

Where to Get Help

If you need to contact Epson for technical support services, use the following support options.

Internet Support

Visit Epson's support website at [epson.com/support](#) (U.S.) or [epson.ca/support](#) (Canada) for solutions to common problems. You can download drivers and documentation, get FAQs and troubleshooting advice, or e-mail Epson with your questions.

Speak to a Support Representative

Before you call Epson for support, please have the following information ready:

- Product name
- Product serial number (located on a label on the product)

- Proof of purchase (such as a store receipt) and date of purchase
- Computer configuration
- Description of the problem

Then call:

- U.S.: (562) 276-4382, 6 AM to 8 PM, Pacific Time, Monday through Friday, and 7 AM to 4 PM, Pacific Time, Saturday
- Canada: (905) 709-3839, 6 AM to 8 PM, Pacific Time, Monday through Friday, and 7 AM to 4 PM, Pacific Time, Saturday

Days and hours of support are subject to change without notice. Toll or long distance charges may apply.

Purchase Supplies and Accessories

You can purchase genuine Epson ink and paper at Epson Supplies Central at epson.com/ink3 (U.S. sales) or epson.ca (Canadian sales). You can also purchase supplies from an Epson authorized reseller. To find the nearest one, call 800-GO-EPSON (800-463-7766).

Parent topic: [Solving Problems](#)

Technical Specifications

These sections list the technical specifications for your product.

Note: Epson offers a recycling program for end of life products. Please go to epson.com/recycle for information on how to return your products for proper disposal.

- [Windows System Requirements](#)
- [Mac System Requirements](#)
- [Printing Specifications](#)
- [Scanning Specifications](#)
- [Automatic Document Feeder \(ADF\) Specifications](#)
- [Fax Specifications](#)
- [Paper Specifications](#)
- [Printable Area Specifications](#)
- [Ink Cartridge Specifications](#)
- [Memory Card Specifications](#)
- [Dimension Specifications](#)
- [Electrical Specifications](#)
- [Environmental Specifications](#)
- [Interface Specifications](#)
- [External USB Device Specifications](#)
- [Network Interface Specifications](#)
- [Safety and Approvals Specifications](#)

Windows System Requirements

To use your product and its software, your computer should use one of these Microsoft operating systems:

- Windows 8.x
- Windows 7
- Windows Vista
- Windows XP Professional x64 Edition
- Windows XP SP3

Note: Visit Epson's support website at epson.com/support (U.S.) or epson.ca/support (Canada) for the latest in compatibility and drivers for your product.

Parent topic: [Technical Specifications](#)

Mac System Requirements

To use your product and its software, your Mac should use one of these operating systems:

- Mac OS X 10.8.x
- Mac OS X 10.7.x
- Mac OS X 10.6.x
- Mac OS X 10.5.8

Note: Visit Epson's support website at epson.com/support (U.S.) or epson.ca/support (Canada) for the latest in compatibility and drivers for your product.

Parent topic: [Technical Specifications](#)

Printing Specifications

Paper path	Paper cassette 1 (upper) and cassette 2 (lower), front entry Rear paper feed slot, top entry
Capacity	Cassette 1: 0.24 inch (6.0 mm) thick stack Approximately 100 sheets at 20 lb (75 g/m ²) Cassette 2: 0.43 inch (11.0 mm) thick stack Approximately 20 sheets of Epson Premium Photo Paper Glossy Rear Paper Feed Slot: One sheet between 0.002 (0.05 mm) to 0.024 inch (0.6 mm) thickness

Parent topic: [Technical Specifications](#)

Scanning Specifications

Scanner type	Flatbed, color
---------------------	----------------

Photoelectric device	CIS
Effective pixels	40800 × 56160 pixels at 4800 dpi
Document size	Maximum: 8.5 × 11.7 inches (216 × 297 mm) Scanner glass: US letter or A4
Scanning resolution	4800 dpi (main scan) 4800 dpi (sub scan)
Output resolution	50 to 4800, 7200, and 9600 dpi (50 to 4800 dpi in 1 dpi increments)
Image data	16 bits per pixel per color internal 8 bits per pixel per color external (maximum)
Light source	LED

Parent topic: [Technical Specifications](#)

Automatic Document Feeder (ADF) Specifications

Paper input	Faceup loading
Paper output	Facedown ejection
Paper size	US letter, legal, or A4 size You cannot use the 2-sided scanning feature with legal size paper
Paper type	Plain paper
Paper weight	17 lb (64 g/m ²) to 24 lb (95 g/m ²)
Sheet feeding capacity	Total thickness: 0.12 inch (3 mm) Approximately 30 sheets (US letter or A4) or 10 sheets (legal)

Parent topic: [Technical Specifications](#)

Fax Specifications

Fax type	Black and white and color fax capability
-----------------	--

Support line	Household phone line
Speed	Up to 33.6 kbps
Resolution	<p>Monochrome</p> <p>Standard: 200 × 100 dpi</p> <p>Fine: 200 × 200 dpi</p> <p>Photo: 200 × 200 dpi</p> <p>Color</p> <p>Fine: 200 × 200 dpi</p> <p>Photo: 200 × 200 dpi</p>
Error correction mode	CCITU/ITU Group 3 fax with error correction mode
Speed dial/group dial numbers	Up to 60 (combined)
Page memory	Up to 180 (ITU-T No. 1 chart)
Redial	2 times (with 1 minute interval)
Interface	<p>RJ-11 Phone Line</p> <p>RJ-11 Telephone set connection</p>

Parent topic: [Technical Specifications](#)

Paper Specifications

Note: Since the quality of any particular brand or type of paper may be changed by the manufacturer at any time, Epson cannot guarantee the quality of any non-Epson brand or type of paper. Always test a sample of paper stock before purchasing large quantities or printing large jobs.

Single-sheets

Size	A4 (8.3 × 11.7 inches [210 × 297 mm]) A6 (4.1 × 5.8 inches [105 × 148 mm]) Letter (8.5 × 11 inches [216 × 279 mm]) Legal (8.5 × 14 inches [216 × 357 mm]) 4 × 6 inches (102 × 152 mm) 5 × 7 inches (127 × 178 mm) 8 × 10 inches (203 × 254 mm) 3.5 × 5 inches (89 × 127 mm) 16:9 wide (4 × 7.1 inches [102 × 181 mm]) Half Letter (5.5 × 8.5 inches [140 × 279 mm])
Paper types	Plain paper and paper distributed by Epson
Thickness	0.003 inch (0.08 mm) to 0.004 inch (0.11 mm)
Weight	17 lb (64 g/m ²) to 24 lb (90 g/m ²)

Envelopes

Size	No. 10 (4.1 × 9.5 inches [105 × 241 mm])
Paper types	Plain bond paper
Weight	20 lb (75 g/m ²) to 24 lb (90 g/m ²)

Parent topic: [Technical Specifications](#)

Printable Area Specifications

Note: When printing borderless, quality may decline in the expanded printable area.

Single sheets

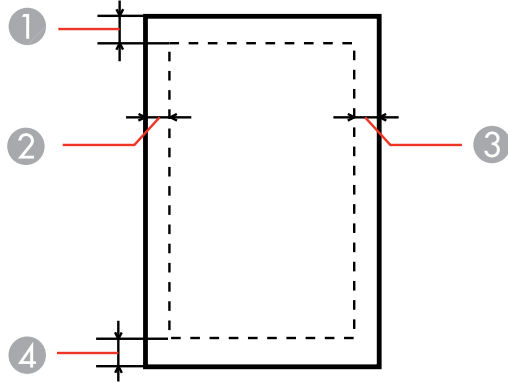

- 1 Top: 0.12 inch (3.0 mm) minimum
- 2 Left: 0.12 inch (3.0 mm) minimum
- 3 Right: 0.12 inch (3.0 mm) minimum
- 4 Bottom: 0.12 inch (3.0 mm) minimum

Envelopes

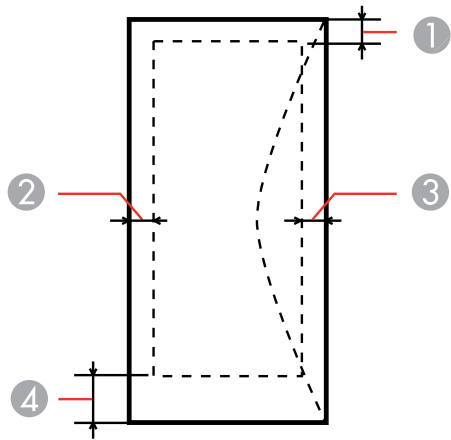

- 1 Left: 0.12 inch (3.0 mm) minimum
- 2 Bottom: 0.20 inch (5.0 mm) minimum
- 3 Top: 0.20 inch (5.0 mm) minimum
- 4 Right: 0.83 inch (21.0 mm) minimum

CD/DVDs

12-cm CD/DVDs

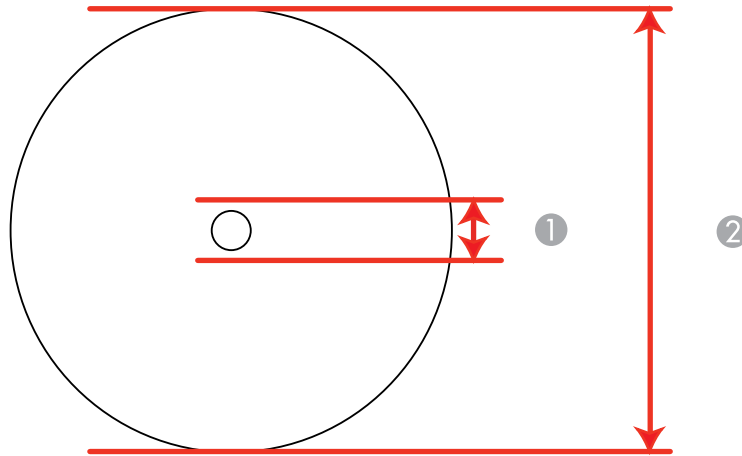

- 1 0.7 inch (18 mm) minimum inner margin
- 2 4.7 inch (120 mm) maximum outer margin

Note: Avoid printing in the clear plastic areas of discs to prevent staining the disc with ink.

Parent topic: [Technical Specifications](#)

Ink Cartridge Specifications

Note: We recommend that you use genuine Epson cartridges and do not refill them. The use of other products may affect your print quality and could result in printer damage.

The cartridges included with the printer are designed for printer setup and not for resale. After some ink is used for priming, the rest is available for printing. Yields vary considerably based on images printed, print settings, paper type, frequency of use, and temperature. For print quality, a variable amount of ink remains in the cartridge after the "replace cartridge" indicator comes on.

Color	Black, Cyan, Magenta, Yellow, Light Cyan, Light Magenta
Cartridge life	Opened package: 6 months Unopened package: do not use if the date on the package has expired
Temperature	Storage: -4 to 104 °F (-20 to 40 °C) 1 month at 104 °F (40 °C) Ink freezes at 3.2 °F (-16 °C) Ink thaws and is usable after 3 hours at 77 °F (25 °C)

Note: For best printing results, use up a cartridge within 6 months of opening the package.

Parent topic: [Technical Specifications](#)

Memory Card Specifications

Note: Cards marked with an asterisk (*) require an adapter; consult your adapter documentation for details on using it.

Compatible types

CompactFlash
Microdrive
Memory Stick Duo
Memory Stick PRO Duo
Memory Stick PRO-HG Duo
Memory Stick Micro*
MagicGate Memory Stick Duo
SDXC
SDHC
SD
miniSDHC*
miniSD*
microSDXC*
microSDHC*
microSD*

Media format DCF

DCF (Design rule for Camera File system) version 1.0 or 2.0 compliant

Voltage requirements

3.3 V

Maximum current for CompactFlash and Microdrive: 500 mA

Parent topic: [Technical Specifications](#)

Dimension Specifications**Height**

Stored: 7.5 inches (191 mm)

Printing: 8.1 inches (207 mm)

Width

Stored: 15.4 inches (390 mm)

Printing: 17.2 inches (438 mm)

Depth	Stored: 13.3 inches (339 mm) Printing: 23.5 inches (598 mm)
Weight (without ink cartridges)	19.2 lb (8.7 kg)

Parent topic: [Technical Specifications](#)

Electrical Specifications

Power supply rating	100 to 120 V
Input voltage range	90 to 132 V
Rated frequency range	50/60 Hz
Input frequency range	49.5/60.5 Hz
Rated current	0.7 A
Power consumption	Standalone copying: 21 W (ISO/IEC24712) Ready mode: 7.0 W Sleep mode: 2.0 W Power off mode: 0.2 W

Parent topic: [Technical Specifications](#)

Environmental Specifications

Temperature	Operating: 50 to 95 °F (10 to 35 °C) Storage: -4 to 104 °F (-20 to 40 °C) 1 month at 104 °F (40 °C)
Humidity (non-condensing)	Operating: 20 to 80% RH Storage: 5 to 85% RH

Parent topic: [Technical Specifications](#)

Interface Specifications

Interface type	Hi-Speed USB (Device Class for computers) Hi-Speed USB (for PictBridge compliant device/Mass storage class for external storage)
-----------------------	---

Note: Epson cannot guarantee the operation of externally connected devices.

Parent topic: [Technical Specifications](#)

External USB Device Specifications

Note: Use only external storage devices with independent AC power sources. External storage devices that are powered via USB are not recommended. Epson cannot guarantee the operation of externally connected devices.

CD-ROM/CD-R drive	700MB maximum capacity CD-RW is not supported
DVD-ROM/DVD-R drive	4.7GB maximum capacity DVD-RW, DVD+R, and DVD+RW are not supported
Magneto-optical drive	1.3GB
Hard disk and USB flash drives	2TB Formatted in FAT, FAT32, or exFAT.

Parent topic: [Technical Specifications](#)

Network Interface Specifications

Wi-Fi

Standard	IEEE 802.11 b/g/n
Security	WPA-PSK (TKIP/AES); WPA2 compliant WEP (64/128 bit)

Frequency band	2.4 GHz
Communication mode	Infrastructure mode Ad hoc mode Wi-Fi Direct

Note: Wireless LAN standard complies with either IEEE 802.11 b/g or IEEE 802.11 b/g/n, depending on purchase location.

Ethernet

Standard	IEEE802.3i/u, IEEE802.3az*
Communication mode	Ethernet 100BASE-TX/10BASE-T

* The connected device should be IEEE802.3az compliant.

Parent topic: [Technical Specifications](#)

Safety and Approvals Specifications

United States	Safety: UL60950-1 EMC: FCC part 15 Subpart B class B
Canada	Safety: CAN/CSA C22.2 No. 60950-1 EMC: CAN/CSA-CEI/IEC CISPR 22 Class B

This equipment contains the following wireless module:

- Manufacturer: Askey Computer Corporation.
- Type: WLU6117-D69 (RoHS)

This product conforms to Part 15 of FCC Rules and RSS-210 of the IC Rules. Epson cannot accept responsibility for any failure to satisfy the protection requirements resulting from a non-recommended modification of the product. Operation is subject to the following two conditions: (1) this device may not cause harmful interference, and (2) this device must accept any interference received, including interference that may cause undesired operation of the device.

To prevent radio interference to the licensed service, this device is intended to be operated indoors and away from windows to provide maximum shielding. Equipment (or its transmit antenna) that is installed outdoors is subject to licensing.

Parent topic: [Technical Specifications](#)

Notices

Check these sections for important notices about your product.

Note: Epson offers a recycling program for end of life products. Please go to epson.com/recycle for information on how to return your products for proper disposal.

[FCC Compliance Statement](#)

[Software Notice](#)

[Trademarks](#)

[Copyright Notice](#)

FCC Compliance Statement

For United States Users

This equipment complies with Part 68 of the FCC rules and the requirements adopted by the Administrative Council for Terminal Attachments ("ACTA") . On the surface of this equipment is a label that contains, among other information, a product identifier in the format US:AAAEQ##TXXXX. If requested, this number must be provided to the telephone company.

Applicable certification jack Universal Service Order Codes ("USOC") for the equipment: RJ11C.

A plug and jack used to connect this equipment to the premises wiring and telephone network must comply with the applicable FCC Part 68 rules and requirements adopted by the ACTA. A compliant telephone cord and modular plug is provided with this product. It is designed to be connected to a compatible modular jack that is also compliant. See installation instructions for details.

The REN is used to determine the number of devices that may be connected to a telephone line. Excessive RENs on a telephone line may result in the devices not ringing in response to an incoming call. In most but not all areas, the sum of RENs should not exceed five (5.0). To be certain of the number of devices that may be connected to a line, as determined by the total RENs, contact the local telephone company. For products approved after July 23, 2001, the REN for this product is part of the product identifier that has the format US:AAAEQ##TXXXX. The digits represented by ## are the REN without a decimal point (e.g., 03 is a REN of 0.3). For earlier products, the REN is separately shown on the label.

If this equipment causes harm to the telephone network, the telephone company will notify you in advance that temporary discontinuance of service may be required. But if advance notice isn't practical, the telephone company will notify the customer as soon as possible. Also, you will be advised of your right to file a complaint with the FCC if you believe it is necessary.

The telephone company may make changes in its facilities, equipment, operations or procedures that could affect the operation of the equipment. If this happens the telephone company will provide advance notice in order for you to make necessary modifications to maintain uninterrupted service.

If you have problems with this product and require technical or customer support, please visit www.epson.com for more information.

This product is not intended to be repaired by the customer. If you experience trouble connecting this equipment to a telephone line, please contact:

Name: Epson America, Inc.

Address: 3840 Kilroy Airport Way, Long Beach, CA 90806 U.S.A.

Telephone: (562) 981-3840

If the equipment is causing harm to the telephone network, the telephone company may request that you disconnect the equipment until the problem is resolved.

This equipment may not be used on coin service provided by the telephone company. Connection to party line service is subject to state tariffs. Contact the state public utility commission, public service commission or corporation commission for information.

If your home has specially wired alarm equipment connected to the telephone line, ensure the installation of this equipment does not disable your alarm equipment. If you have questions about what will disable alarm equipment, consult your telephone company or a qualified installer.

The Telephone Consumer Protection Act of 1991 makes it unlawful for any person to use a computer or other electronic device, including fax machines, to send any message unless such message clearly contains in a margin at the top or bottom of each transmitted page or on the first page of the transmission, the date and time it is sent and an identification of the business or other entity, or other individual sending the message and the telephone number of the sending machine or such business, other entity, or individual. (The telephone number provided may not be a 900 number or any other number for which charges exceed local or long-distance transmission charges.)

In order to program this information into your fax machine, follow the instructions in "Entering Fax Header Information".

According to the FCC's electrical safety advisory, we recommend that you may install an AC surge arrester in the AC outlet to which this equipment is connected. Telephone companies report that electrical surges, typically lightning transients, are very destructive to customer terminal equipment connected to AC power sources and that this is a major nationwide problem.

This equipment has been tested and found to comply with the limits for a Class B digital device, pursuant to Part 15 of the FCC Rules. These limits are designed to provide reasonable protection against harmful interference in a residential installation. This equipment generates, uses, and can radiate radio frequency energy and, if not installed and used in accordance with the instructions, may cause harmful

interference to radio or television reception. However, there is no guarantee that interference will not occur in a particular installation. If this equipment does cause interference to radio and television reception, which can be determined by turning the equipment off and on, the user is encouraged to try to correct the interference by one or more of the following measures:

- Reorient or relocate the receiving antenna.
- Increase the separation between the equipment and receiver.
- Connect the equipment into an outlet on a circuit different from that to which the receiver is connected.
- Consult the dealer or an experienced radio/TV technician for help.

WARNING

The connection of a non-shielded equipment interface cable to this equipment will invalidate the FCC Certification or Declaration of this device and may cause interference levels which exceed the limits established by the FCC for this equipment. It is the responsibility of the user to obtain and use a shielded equipment interface cable with this device. If this equipment has more than one interface connector, do not leave cables connected to unused interfaces. Changes or modifications not expressly approved by the manufacturer could void the user's authority to operate the equipment.

For Canadian Users

1. This product meets the applicable Industry Canada technical specifications.
2. The Ringer Equivalence Number is an indication of the maximum number of devices allowed to be connected to a telephone interface. The termination on an interface may consist of any combination of devices subject only to the requirement that the sum of the RENs of all the devices does not exceed five.

This Class B digital apparatus complies with Canadian ICES-003.

Le présent matériel est conforme aux spécifications techniques applicables d'Industrie Canada.

L'indice d'équivalence de la sonnerie (IES) sert à indiquer le nombre maximal de terminaux qui peuvent être raccordés à une interface téléphonique. La terminaison d'une interface peut consister en une combinaison quelconque de dispositifs, à la seule condition que la somme d'indices d'équivalence de la sonnerie de tous les dispositifs n'excède pas 5.

Cet appareil numérique de la classe B est conforme à la norme NMB-003 du Canada.

Parent topic: [Notices](#)

Software Notice

1. This printer product includes open source software programs listed in Section 6) according to the license terms of each open source software program.

2. We provide the source code of the GPL Programs, LGPL Programs, Apache License Program and ncftp license Program (each is defined in Section 6) until five (5) years after the discontinuation of same model of this printer product. If you desire to receive the source code above, please contact the customer support of your region. You shall comply with the license terms of each open source software program.
3. The open source software programs are WITHOUT ANY WARRANTY; without even the implied warranty of MERCHANTABILITY AND FITNESS FOR A PARTICULAR PURPOSE. See the license agreements of each open source software program for more details, which are described in OSS.pdf on your Printer Software CD.
4. OpenSSL toolkit
This printer product includes software developed by the OpenSSL project for use in the OpenSSL Toolkit (<http://www.openssl.org/>).
This product includes cryptographic software written by Eric Young (eay@cryptsoft.com).
5. The license terms of each open source software program are described in OSS.pdf on your Printer Software CD.
6. The list of open source software programs which this printer product includes are as follows.

GNU GPL

This printer product includes the open source software programs which apply the GNU General Public License Version 2 or later version ("GPL Programs").

The list of GPL Programs:

linux-2.6.35-arm1-epson12

busybox-1.17.4

udhcp 0.9.8cvs20050124-5

ethtool-2.6.35

GNU LGPL

This printer product includes the open source software programs which apply the GNU Lesser General Public License Version 2 or later version ("LGPL Programs").

The list of LGPL Programs:

uclibc-0.9.32

libusb-1.0.8

zeroconf 0.6.1-1

iksemel-rev25

Apache License

This printer product includes the open source software program "Bonjour" which apply the Apache License Version2.0 ("Apache License Program").

Bonjour License

This printer product includes the open source software program "Bonjour " which applies the terms and conditions provided by owner of the copyright to the "Bonjour ".

Net-SNMP license

This printer product includes the open source software program "Net-SNMP" which applies the terms and conditions provided by owner of the copyright to the "Net-SNMP".

OpenSSL License/Original SSLeay License

This printer product includes the open source software program "OpenSSL toolkit" which applies the license terms of OpenSSL License and Original SSLeay License.

BSD License (Berkeley Software Distribution License)

This printer product includes the open source software program "busybox-1.17.4 " which apply the Berkeley Software Distribution License ("BSD Program").

Sun RPC License

This printer product includes the open source software program "busybox-1.17.4 " which apply the Sun RPC License ("Sun RPC Program").

ncftp license

This printer product includes the open source software program "ncftp-3.2.4 " which applies the terms and conditions provided by owner of the copyright to the "ncftp ".

ARC4 license

This printer product includes the open source software program "ARC4" which applies the terms and conditions provided by owner of the copyright to the "ARC4".

json_parserlicense

This printer product includes the open source software program "json_parser" which applies the terms and conditions provided by owner of the copyright to the " json_parser ".

MD5license

This printer product includes the open source software program "MD5" which applies the terms and conditions provided by owner of the copyright to the " MD5 ".

AESlicense

This printer product includes the open source software program "AES" which applies the terms and conditions provided by owner of the copyright to the "AES".

SHA1 license

This printer product includes the open source software program "SHA1" which applies the terms and conditions provided by owner of the copyright to the "SHA1".

Parent topic: [Notices](#)

Trademarks

EPSON® and Supplies Central® are registered trademarks, EPSON Connect™, EPSON iPrint™, and Remote Print™ are trademarks, and EPSON Exceed Your Vision is a registered logomark of Seiko Epson Corporation.

EPSON StoreSM is a service mark of Epson America, Inc.

Apple, iPad, iPhone, iPod touch, and Mac OS are trademarks of Apple Inc., registered in the U.S. and other countries. AirPrint is a trademark of Apple Inc.

General Notice: Other product names used herein are for identification purposes only and may be trademarks of their respective owners. Epson disclaims any and all rights in those marks.



Parent topic: [Notices](#)

Copyright Notice

All rights reserved. No part of this publication may be reproduced, stored in a retrieval system, or transmitted in any form or by any means, electronic, mechanical, photocopying, recording, or otherwise, without the prior written permission of Seiko Epson Corporation. The information contained herein is designed only for use with this Epson product. Epson is not responsible for any use of this information as applied to other products.

Neither Seiko Epson Corporation nor its affiliates shall be liable to the purchaser of this product or third parties for damages, losses, costs, or expenses incurred by purchaser or third parties as a result of: accident, misuse, or abuse of this product or unauthorized modifications, repairs, or alterations to this product, or (excluding the U.S.) failure to strictly comply with Seiko Epson Corporation's operating and maintenance instructions.

Seiko Epson Corporation shall not be liable for any damages or problems arising from the use of any options or any consumable products other than those designated as Original Epson Products or Epson Approved Products by Seiko Epson Corporation.

Seiko Epson Corporation shall not be held liable for any damage resulting from electromagnetic interference that occurs from the use of any interface cables other than those designated as Epson approved Products by Seiko Epson Corporation.

This information is subject to change without notice.

[libTIFF Software Acknowledgment](#)

[A Note Concerning Responsible Use of Copyrighted Materials](#)

[Default Delay Times for Power Management for Epson Products](#)

[Copyright Attribution](#)

Parent topic: [Notices](#)

libTIFF Software Acknowledgment

Copyright © 1988-1997 Sam Leffler

Copyright © 1991-1997 Silicon Graphics, Inc.

Permission to use, copy, modify, distribute, and sell this software and its documentation for any purpose is hereby granted without fee, provided that (i) the above copyright notices and this permission notice appear in all copies of the software and related documentation, and (ii) the names of Sam Leffler and Silicon Graphics may not be used in any advertising or publicity relating to the software without the specific, prior written permission of Sam Leffler and Silicon Graphics.

THE SOFTWARE IS PROVIDED "AS-IS" AND WITHOUT WARRANTY OF ANY KIND, EXPRESS, IMPLIED OR OTHERWISE, INCLUDING WITHOUT LIMITATION, ANY WARRANTY OF MERCHANTABILITY OR FITNESS FOR A PARTICULAR PURPOSE.

IN NO EVENT SHALL SAM LEFFLER OR SILICON GRAPHICS BE LIABLE FOR ANY SPECIAL, INCIDENTAL, INDIRECT OR CONSEQUENTIAL DAMAGES OF ANY KIND, OR ANY DAMAGES WHATSOEVER RESULTING FROM LOSS OF USE, DATA OR PROFITS, WHETHER OR NOT ADVISED OF THE POSSIBILITY OF DAMAGE, AND ON ANY THEORY OF LIABILITY, ARISING OUT OF OR IN CONNECTION WITH THE USE OR PERFORMANCE OF THIS SOFTWARE.

Parent topic: [Copyright Notice](#)

A Note Concerning Responsible Use of Copyrighted Materials

Epson encourages each user to be responsible and respectful of the copyright laws when using any Epson product. While some countries' laws permit limited copying or reuse of copyrighted material in

certain circumstances, those circumstances may not be as broad as some people assume. Contact your legal advisor for any questions regarding copyright law.

Parent topic: [Copyright Notice](#)

Default Delay Times for Power Management for Epson Products

This product will enter sleep mode after a period of nonuse. This is to ensure that the product meets Energy Star standards of energy efficiency. More energy savings can be achieved by setting the time to sleep to a shorter interval.

Parent topic: [Copyright Notice](#)

Copyright Attribution

© 2014 Epson America, Inc.

1/14

CPD-37262R2

Parent topic: [Copyright Notice](#)