

Dell™ OptiPlex™ 755

Quick Reference Guide

Models DCTR, DCNE, DCSM, and DCCY

Notes, Notices, and Cautions



NOTE: A NOTE indicates important information that helps you make better use of your computer.



NOTICE: A NOTICE indicates either potential damage to hardware or loss of data and tells you how to avoid the problem.



CAUTION: A CAUTION indicates a potential for property damage, personal injury, or death.

Information in this document is subject to change without notice.

© 2007 Dell Inc. All rights reserved.

Reproduction in any manner whatsoever without the written permission of Dell Inc. is strictly forbidden.

Trademarks used in this text: *Dell*, the *DELL* logo, *OptiPlex*, *Inspiron*, *Dimension*, *Latitude*, *Dell Precision*, *DellNet*, *TravelLite*, *OpenManage*, *PowerVault*, *Axim*, *PowerEdge*, *PowerConnect*, *PowerApp*, and *StrikeZone* are trademarks of Dell Inc.; *Intel*, *Pentium*, *SpeedStep*, and *Celeron* are registered trademarks and *Core* and *vPro* are trademarks of Intel Corporation in the U.S and other countries; *Microsoft*, *MS-DOS*, *Windows*, *Windows Vista*, and the *Windows Vista Start button* are either registered trademarks or trademarks of Microsoft Corporation in the United States and/or other countries; *IBM* is a registered trademark of International Business Machines Corporation; *Bluetooth* is a trademark owned by Bluetooth SIG, Inc. and is used by Dell Inc. under license. *ENERGY STAR* is a registered trademark of the U.S. Environmental Protection Agency. As an ENERGY STAR partner, Dell Inc. has determined that this product meets the ENERGY STAR guidelines for energy efficiency.

Other trademarks and trade names may be used in this document to refer to either the entities claiming the marks and names or their products. Dell Inc. disclaims any proprietary interest in trademarks and trade names other than its own.

Models: DCTR, DCNE, DCSM, and DCCY

Contents

Finding Information	5
Setting Up Your Computer	10
Set Up Your Keyboard and Mouse	11
Set Up Your Monitor	12
Power Connections	12
Before You Begin	13
Recommended Tools	13
Turning Off Your Computer	13
Before Working Inside Your Computer	14
Mini Tower Computer	16
System Views	16
Removing the Computer Cover	22
Inside Your Computer	24
System Board Components	25
Jumper Settings	26
Desktop Computer	27
System Views	27
Removing the Computer Cover	32
Inside Your Computer	33
System Board Components	35
Jumper Settings	36
Small Form Factor Computer	37
System Views	37
Removing the Computer Cover	43

Inside Your Computer	44
System Board Components	46
Jumper Settings	47
Ultra Small Form Factor Computer	48
System Views	48
Removing the Computer Cover	55
Inside Your Computer	56
Cable Cover (Optional)	57
System Board Components	59
Jumper Settings	60
Solving Problems	61
Dell Diagnostics	61
System Lights	65
Diagnostic Lights	66
Beep Codes	70
Resolving Software and Hardware Incompatibilities	72
Restoring Your Operating System	73
Using Microsoft Windows System Restore	73
Using Dell™ PC Restore and Dell Factory Image Restore	75
Using the Drivers and Utilities Media	78
Reinstalling Drivers and Utilities	79
 Index	 83

Finding Information



NOTE: Some features or media may be optional and may not ship with your computer. Some features or media may not be available in certain countries.



NOTE: Additional information may ship with your computer.

What Are You Looking For?

- A diagnostic program for my computer
- Drivers for my computer
- Desktop System Software (DSS)

Find It Here

Drivers and Utilities Media

NOTE: The *Drivers and Utilities* media may be optional and may not ship with your computer.

Documentation and drivers are already installed on your computer. You can use the media to reinstall drivers (see "Reinstalling Drivers and Utilities" on page 79), to run the Dell Diagnostics (see "Dell Diagnostics" on page 61).

Readme files may be included on your media to provide last-minute updates about technical changes to your computer or advanced technical-reference material for technicians or experienced users.



NOTE: Drivers and documentation updates can be found at support.dell.com.

What Are You Looking For?

- How to set up my computer
- How to run the Dell Diagnostics
- Error codes and diagnostic lights
- Tools and utilities
- How to set up a printer
- How to troubleshoot and solve problems
- How to remove and install parts

Find It Here

Owner's Manual

NOTE: This document may be optional and may not ship with your computer.



NOTE: This document is available as a PDF at support.dell.com.

-
- Warranty information
 - Terms and Conditions (U.S. only)
 - Safety instructions
 - Regulatory information
 - Ergonomics information
 - End User License Agreement

Dell™ Product Information Guide

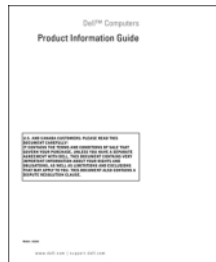

-
- How to remove and replace parts
 - Specifications
 - How to configure system settings
 - How to troubleshoot and solve problems

Dell™ OptiPlex™ User's Guide

Microsoft Windows Help and Support Center

- 1 Click **Start** or  → **Help and Support** → **Dell User and System Guides** → **System Guides**.
- 2 Click the *User's Guide* for your computer.

What Are You Looking For?

- Service Tag and Express Service Code
- Microsoft Windows License Label

Find It Here**Service Tag and Microsoft® Windows® License**

These labels are located on your computer.

- Use the Service Tag to identify your computer when you use support.dell.com or contact support.
- Enter the Express Service Code to direct your call when contacting support.



NOTE: As an increased security measure, the newly designed Microsoft Windows license label incorporates a missing portion or "hole" to discourage removal of the label.

What Are You Looking For?**Find It Here**

- Solutions — Troubleshooting hints and tips, articles from technicians, and online courses, frequently asked questions
- Community — Online discussion with other Dell customers
- Upgrades — Upgrade information for components, such as memory, the hard drive, and the operating system
- Customer Care — Contact information, service call and order status, warranty, and repair information
- Service and support — Service call status and support history, service contract, online discussions with technical support
- Dell Technical Update Service — Proactive e-mail notification of software and hardware updates for your computer
- Reference — Computer documentation, details on my computer configuration, product specifications, and white papers
- Downloads — Certified drivers, patches, and software updates
- Desktop System Software (DSS)— If you reinstall the operating system for your computer, you should also reinstall the DSS utility. DSS provides critical updates for your operating system and support for processors, optical drives, USB devices, and so on. DSS is necessary for correct operation of your Dell computer. The software automatically detects your computer and operating system and installs the updates appropriate for your configuration.

Dell Support Website — support.dell.com

NOTE: Select your region or business segment to view the appropriate support site.

To download Desktop System Software:

- 1** Go to support.dell.com and click Drivers & Downloads.
- 2** Enter your Service Tag or Product Type and Product Model, and click **Go**.
- 3** Scroll to **System and Configuration Utilities**→ **Dell Notebook System Software** and click **Download Now**.
- 4** Select **Drivers & Downloads** and click **Go**.

NOTE: The support.dell.com user interface may vary depending on your selections.

What Are You Looking For?

- How to use Windows XP
- How to work with programs and files
- How to personalize my desktop

Find It Here**Windows Help and Support Center**

- 1 To access Windows Help and Support:
 - In Windows XP, click **Start** and click **Help and Support**.
 - In Windows Vista™, click the Windows Vista Start button  and click **Help and Support**.
- 2 Type a word or phrase that describes your problem, and then click the arrow icon.
- 3 Click the topic that describes your problem.
- 4 Follow the instructions on the screen.

-
- How to reinstall my operating system

Operating System Media

NOTE: The *Operating System* media may be optional and may not ship with your computer.

The operating system is already installed on your computer. To reinstall your operating system, use the *Operating System* media. See "Restoring Your Operating System" in your *User's Guide* or *Owner's Manual*.





What Are You Looking For?	Find It Here
	<p>After you reinstall your operating system, use the <i>Drivers and Utilities</i> media to reinstall drivers for the devices that came with your computer.</p> <p>Your operating system product key label is located on your computer.</p> <p>NOTE: The color of your CD varies based on the operating system you ordered.</p>

Setting Up Your Computer

 **CAUTION:** Before performing any of the procedures in this section, follow the safety instructions in *Product Information Guide*.

 **NOTICE:** If your computer has an expansion card installed (such as a modem card), connect the appropriate cable to the card, *not* to the connector on the back panel.

 **NOTICE:** To help allow the computer to maintain proper operating temperature, ensure that you do not place the computer too close to a wall or other storage compartment that might prevent air circulation around the chassis. See your Product Information Guide for more information.

 **NOTE:** Before you install any devices or software that did not ship with your computer, read the documentation that came with the device or software, or contact the vendor to verify that the device or software is compatible with your computer and operating system.

You must complete all the steps to properly set up your computer. See the appropriate figures that follow the instructions.

 **NOTICE:** Do not attempt to operate a PS/2 mouse and a USB mouse simultaneously.

- 1 Connect the keyboard and mouse.

 **NOTICE:** Do not connect a modem cable to the network adapter connector. Voltage from telephone communications can cause damage to the network adapter

- 2 Connect the modem or network cable.

Insert the network cable, not the telephone line, into the network connector. If you have an optional modem, connect the telephone line to the modem.

3 Connect the monitor.

Align and gently insert the monitor cable to avoid bending connector pins. Tighten the thumbscrews on the cable connectors.

 **NOTE:** Some monitors have the video connector underneath the back of the screen. See the documentation that came with your monitor for its connector locations.

4 Connect the speakers.

5 Connect power cables to the computer, monitor, and devices and connect the other ends of the power cables to electrical outlets.

 **NOTICE:** To avoid damaging a computer with a manual voltage-selection switch, set the switch for the voltage that most closely matches the AC power available in your location.

 **NOTICE:** In Japan, the voltage selection switch must be set to the 115-V position even though the AC power available in Japan is 100 V.

6 Verify that the voltage selection switch is set correctly for your location.

Your computer has a manual voltage-selection switch. Computers with a voltage selection switch on the back panel must be manually set to operate at the correct operating voltage.

Set Up Your Keyboard and Mouse

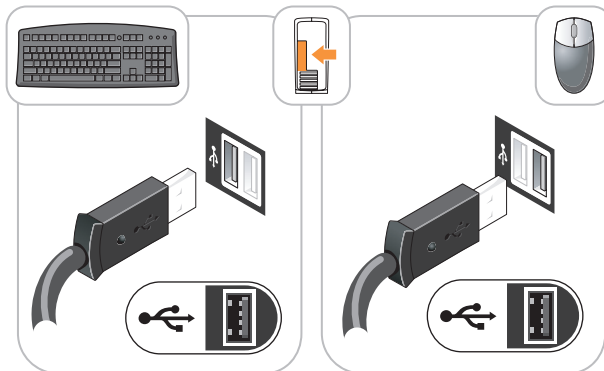

Set Up Your Monitor

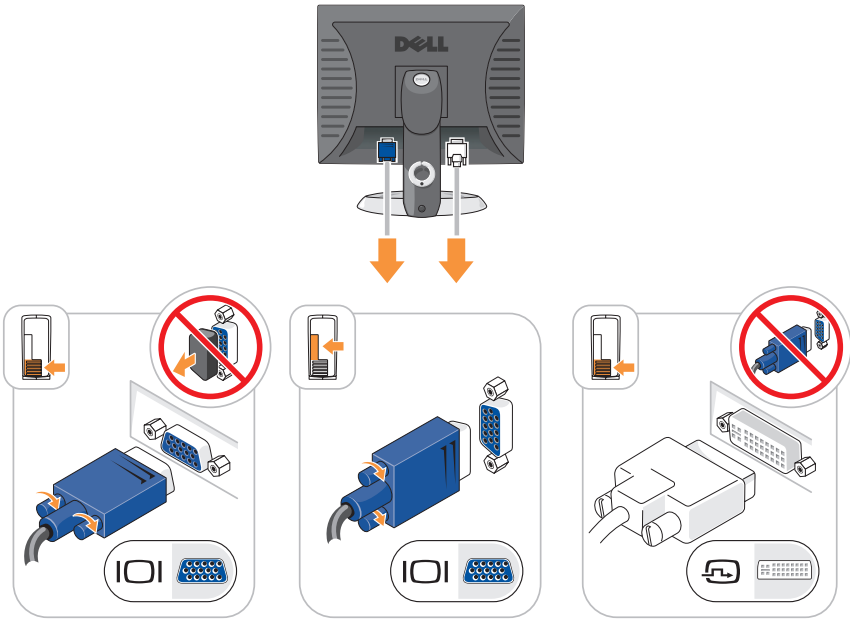

Power Connections

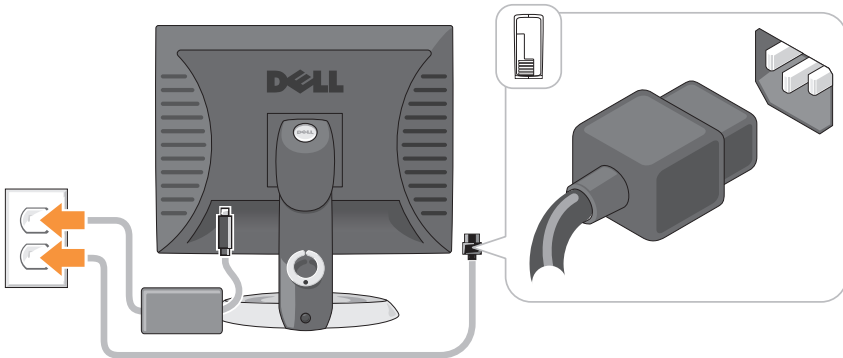

Before You Begin

This chapter provides procedures for removing and installing the components in your computer. Unless otherwise noted, each procedure assumes that the following conditions exist:

- You have performed the steps in "Turning Off Your Computer" on page 13 and "Mini Tower Computer" on page 16.
- You have read the safety information in your Dell™ *Product Information Guide*.
- A component can be replaced by performing the removal procedure in reverse order.

Recommended Tools

The procedures in this document may require the following tools:

- Small flat-blade screwdriver
- Phillips screwdriver
- Flash BIOS update program floppy disk or CD

Turning Off Your Computer

 **NOTICE:** To avoid losing data, save and close all open files and exit all open programs before you turn off your computer.

- 1 Shut down the operating system:
 - a Save and close all open files and exit all open programs.
 - b *In the Microsoft® Windows® XP operating system*, click **Start**→ **Shut Down**→ **Shut down**.

In the Microsoft® Windows Vista™ operating system, click the Windows Vista Start Button  in the lower-left corner of the desktop, click the arrow in the lower-right corner of the Start menu as shown below, and then click **Shut Down**.



The computer turns off after the operating system shutdown process is complete.

- ➔ **NOTICE:** Ensure that the computer and all attached devices are turned off. If your computer and attached devices did not automatically turn off when you shut down your operating system, press and hold the power button for about 4 seconds to turn them off.

Before Working Inside Your Computer

Use the following safety guidelines to help protect your computer from potential damage and to help ensure your own personal safety.

- ⚠ **CAUTION:** Before you begin any of the procedures in this section, follow the safety instructions in the *Product Information Guide*.
- ⚠ **CAUTION:** Handle components and cards with care. Do not touch the components or contacts on a card. Hold a card by its edges or by its metal mounting bracket. Hold a component such as a processor by its edges, not by its pins.
- ➔ **NOTICE:** Only a certified service technician should perform repairs on your computer. Damage due to servicing that is not authorized by Dell is not covered by your warranty.
- ➔ **NOTICE:** When you disconnect a cable, pull on its connector or on its strain-relief loop, not on the cable itself. Some cables have a connector with locking tabs; if you are disconnecting this type of cable, press in on the locking tabs before you disconnect the cable. As you pull connectors apart, keep them evenly aligned to avoid bending any connector pins. Also, before you connect a cable, ensure that both connectors are correctly oriented and aligned.
- ➔ **NOTICE:** To avoid damaging the computer, perform the following steps before you begin working inside the computer.
 - 1 Turn off your computer.
 - 2 If the computer is connected to a docking device (docked), undock it. See the documentation that came with your docking device for instructions.
- ➔ **NOTICE:** To disconnect a network cable, first unplug the cable from your computer and then unplug it from the network wall jack.
 - 3 Disconnect all telephone or network cables from the computer.
 - 4 Disconnect your computer and all attached devices from their electrical outlets, and then press the power button to ground the system board.
 - 5 If applicable, remove the computer stand (for instructions, see the documentation that came with the stand) and the cable cover, if attached (see "Cable Cover (Optional)" on page 57).



CAUTION: To guard against electrical shock, always unplug your computer from the electrical outlet before removing the cover.

6 Remove the computer cover.

- For a mini tower computer, see "Removing the Computer Cover" on page 22.
- For a desktop computer, see "Removing the Computer Cover" on page 32.
- For a small form factor computer, see "Removing the Computer Cover" on page 43.
- For an ultra small form factor computer, see "Removing the Computer Cover" on page 55.



NOTICE: Before touching anything inside your computer, ground yourself by touching an unpainted metal surface, such as the metal at the back of the computer. While you work, periodically touch an unpainted metal surface to dissipate any static electricity that could harm internal components.



Mini Tower Computer

System Views

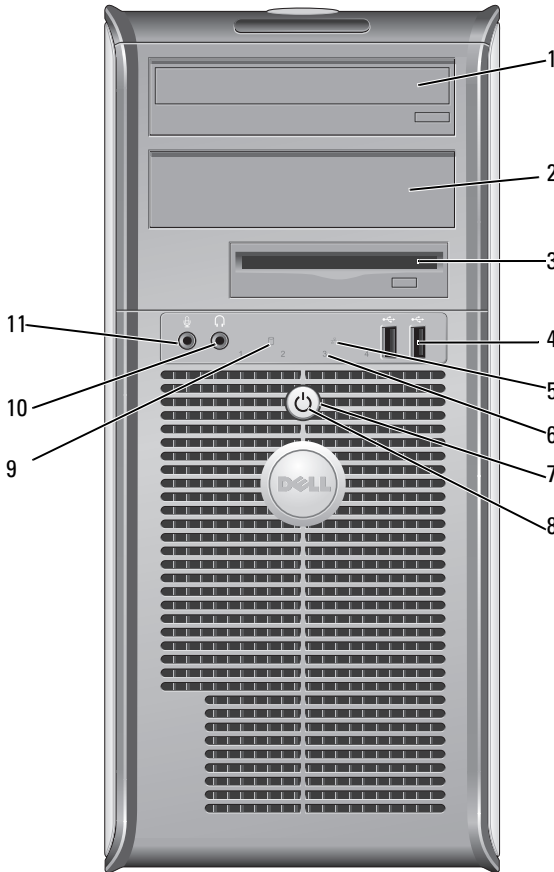
Front View



- 1 5.25-inch drive bay Can contain an optical drive. Insert a CD or DVD (if supported) into this drive.
- 2 5.25-inch drive bay Can contain an optical drive. Insert a CD or DVD (if supported) into this drive.

- | | | |
|---|------------------------|---|
| 3 | 3.5-inch drive bay | Can contain an optional floppy drive or optional media card reader. |
| 4 | USB 2.0 connectors (2) | <p>Use the front USB connectors for devices that you connect occasionally, such as joysticks or cameras, or for bootable USB devices (see your online <i>User's Guide</i> for more information on booting to a USB device).</p> <p>It is recommended that you use the back USB connectors for devices that typically remain connected, such as printers and keyboards.</p> |
| 5 | LAN indicator light | This light indicates that a LAN (local area network) connection is established. |
| 6 | diagnostic lights | Use the lights to help you troubleshoot a computer problem based on the diagnostic code. For more information, see "Diagnostic Lights" on page 66. |
| 7 | power button | <p>Press this button to turn on the computer.</p> <p> NOTICE: To avoid losing data, do not turn off the computer by pressing the power button. Instead, perform an operating system shutdown. See "Turning Off Your Computer" on page 13 for more information.</p> <p> NOTICE: If your operating system has ACPI enabled, when you press the power button the computer will perform an operating system shutdown.</p> |

- 8 power light The power light illuminates and blinks or remains solid to indicate different operating modes:
- No light — The computer is turned off.
 - Steady green — The computer is in a normal operating state.
 - Blinking green — The computer is in a power-saving mode
 - Blinking or solid amber — The computer is receiving electrical power, but an internal power problem may exist (see "Power Problems" in the *User's Guide*).
- To exit from a power-saving mode, press the power button or use the keyboard or the mouse if it is configured as a wake device in the Windows Device Manager. For more information about sleep modes and power-saving mode, see "Advanced Features" in the *User's Guide*.
- See "Diagnostic Lights" on page 66 for a description of light codes that can help you troubleshoot problems with your computer.
- 9 hard drive activity light This light flickers when the hard drive is being accessed.
- 10 headphone connector Use the headphone connector to attach headphones and most kinds of speakers.
- 11 microphone connector Use the microphone connector to attach a microphone.

Back View

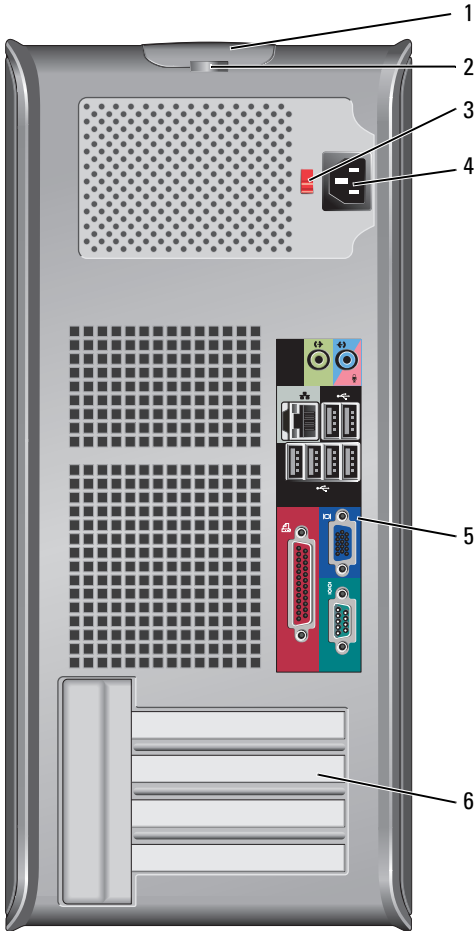

1 cover-release latch

This latch allows you to open the computer cover.

2 padlock ring

Insert a padlock to lock the computer cover.

- 3 voltage selection switch Your computer is equipped with a manual voltage-selection switch. To help avoid damaging a computer with a manual voltage-selection switch, set the switch for the voltage that most closely matches the AC power available in your location.
 - ➔ **NOTICE:** In Japan, the voltage selection switch must be set to the 115-V position.

Also, ensure that your monitor and attached devices are electrically rated to operate with the AC power available in your location.
- 4 power connector Insert the power cable.
- 5 back panel connectors Plug serial, USB, and other devices into the appropriate connectors. See "Back Panel Connectors" on page 20.
- 6 card slots (4) Access connectors for any installed PCI or PCI Express cards, PS/2 connector, eSATA connector, etc.

Back Panel Connectors

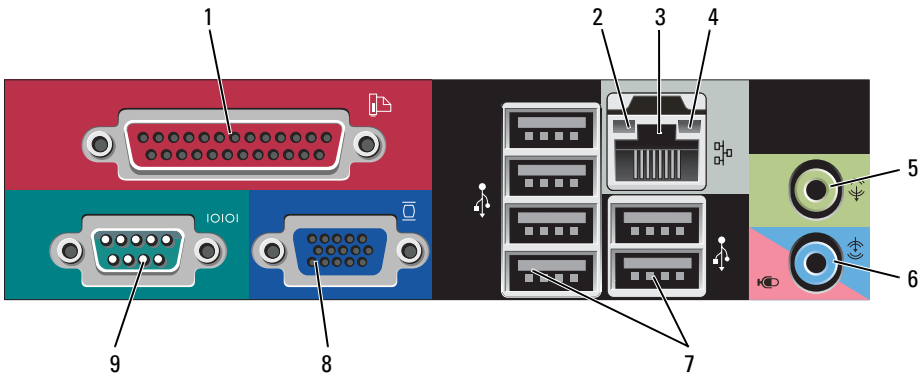

- 1 parallel connector Connect a parallel device, such as a printer, to the parallel connector. If you have a USB printer, plug it into a USB connector.
 - NOTE:** The integrated parallel connector is automatically disabled if the computer detects an installed card containing a parallel connector configured to the same address. For more information, see "System Setup Options" in the *User's Guide*.

- | | | |
|---|------------------------------|---|
| 2 | link integrity light | <ul style="list-style-type: none"> • Green — A good connection exists between a 10-Mbps network and the computer. • Orange — A good connection exists between a 100-Mbps network and the computer. • Yellow — A good connection exists between a 1-Gbps (or 1000-Mbps) network and the computer. • Off — The computer is not detecting a physical connection to the network. |
| 3 | network adapter connector | <p>To attach your computer to a network or broadband device, connect one end of a network cable to either a network jack or your network or broadband device. Connect the other end of the network cable to the network adapter connector on the back panel of your computer. A click indicates that the network cable has been securely attached.</p> <p>NOTE: Do not plug a telephone cable into the network connector.</p> <p>Remote management features require use of the onboard NIC.</p> <p>It is recommended that you use Category 5 wiring and connectors for your network. If you must use Category 3 wiring, force the network speed to 10 Mbps to ensure reliable operation.</p> |
| 4 | network activity light | Flashes a yellow light when the computer is transmitting or receiving network data. A high volume of network traffic may make this light appear to be in a steady "on" state. |
| 5 | line-out connector | Use the green line-out connector to attach headphones and most speakers with integrated amplifiers. |
| 6 | line-in/microphone connector | Use the blue and pink line-in/microphone connector to attach a record/playback device such as a cassette player, CD player, or VCR.; or a personal computer microphone for voice or musical input into a sound or telephony program. |
| 7 | USB 2.0 connectors (6) | Use the back USB connectors for devices that typically remain connected, such as printers and keyboards. |

- 8 video connector Plug the cable from your VGA-compatible monitor into the blue connector.
- NOTE:** If you purchased an optional graphics card, this connector will be covered by a cap. Connect your monitor to the connector on the graphics card. Do not remove the cap.
- NOTE:** If you are using a graphics card that supports dual monitors, use the y-cable that came with your computer.
- 9 serial connector Connect a serial device, such as a handheld device, to the serial port. The default designations are COM1 for serial connector 1 and COM2 for serial connector 2.
- For more information, see "System Setup Options" in the *User's Guide*.

Removing the Computer Cover

 **CAUTION:** Before you begin any of the procedures in this section, follow the safety instructions located in the *Product Information Guide*.

 **CAUTION:** To guard against electrical shock, always unplug your computer from the electrical outlet before removing the computer cover.

- 1 Follow the procedures in "Before You Begin" on page 13.
- 2 Lay the computer on its side as shown in the illustration.
- 3 Locate the cover release latch shown in the illustration. Then, slide the release latch back as you lift the cover.
- 4 Grip the sides of the computer cover and pivot the cover up using the hinge tabs as leverage points.
- 5 Remove the cover from the hinge tabs and set it aside on a soft nonabrasive surface.

 **CAUTION:** Graphics card heat sinks can become very hot during normal operation. Ensure that a graphics card heat sink has had sufficient time to cool before you touch it.

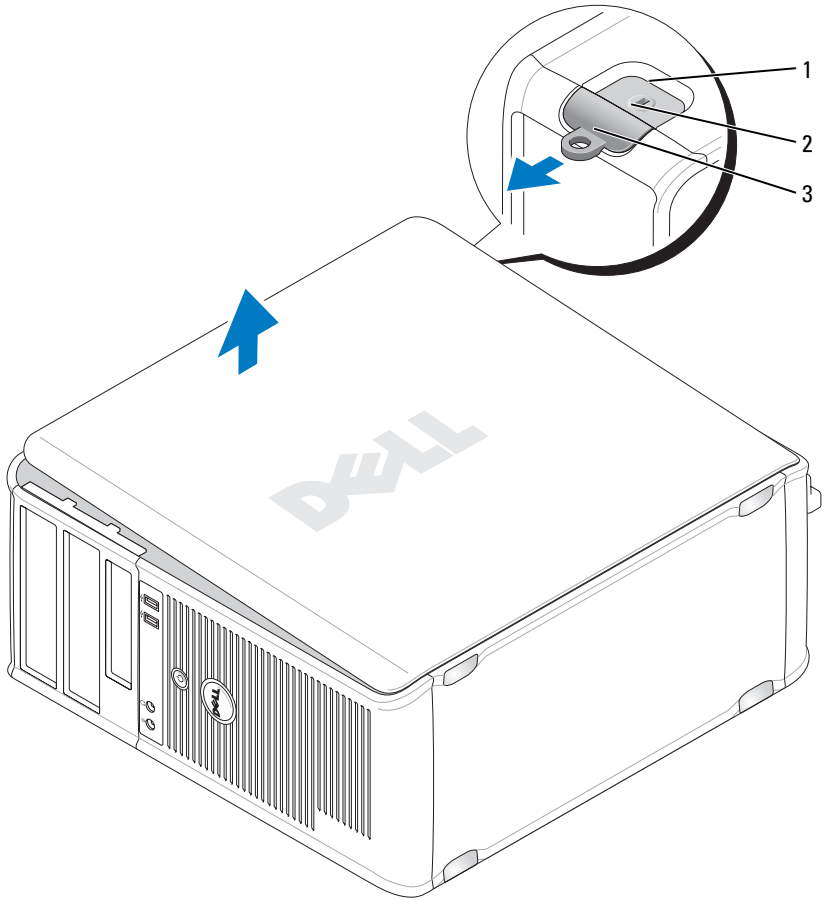

- 1 security cable slot
- 3 padlock ring

- 2 cover release latch

Inside Your Computer

⚠ CAUTION: Before you begin any of the procedures in this section, follow the safety instructions located in the *Product Information Guide*.

⚠ CAUTION: To avoid electrical shock, always unplug your computer from the electrical outlet before removing the computer cover.

➡ NOTICE: Be careful when opening the computer cover to ensure that you do not accidentally disconnect cables from the system board.

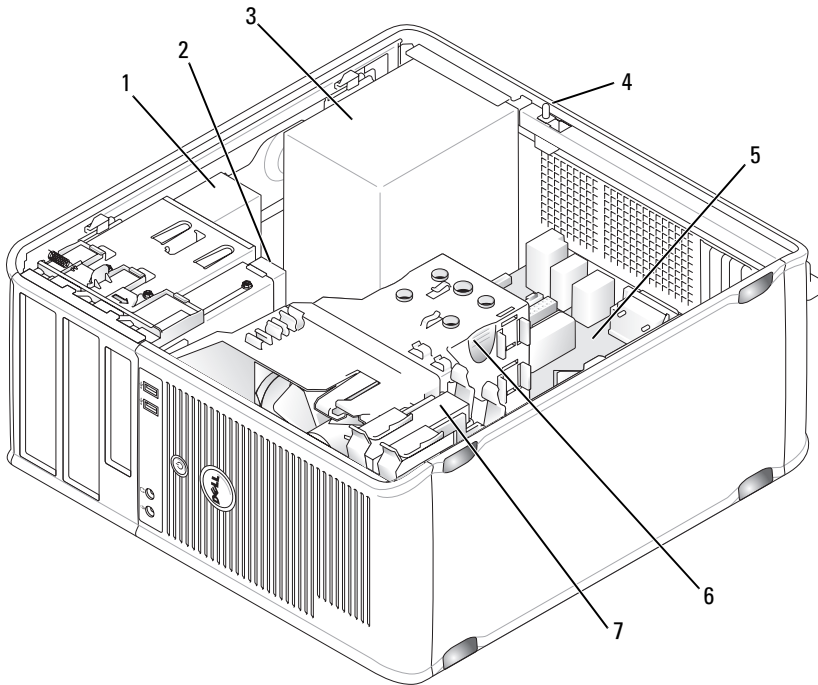

- 1 optical drive
- 3 power supply
- 5 system board
- 7 hard drive

- 2 disk drive
- 4 optional chassis-intrusion switch
- 6 heat sink assembly

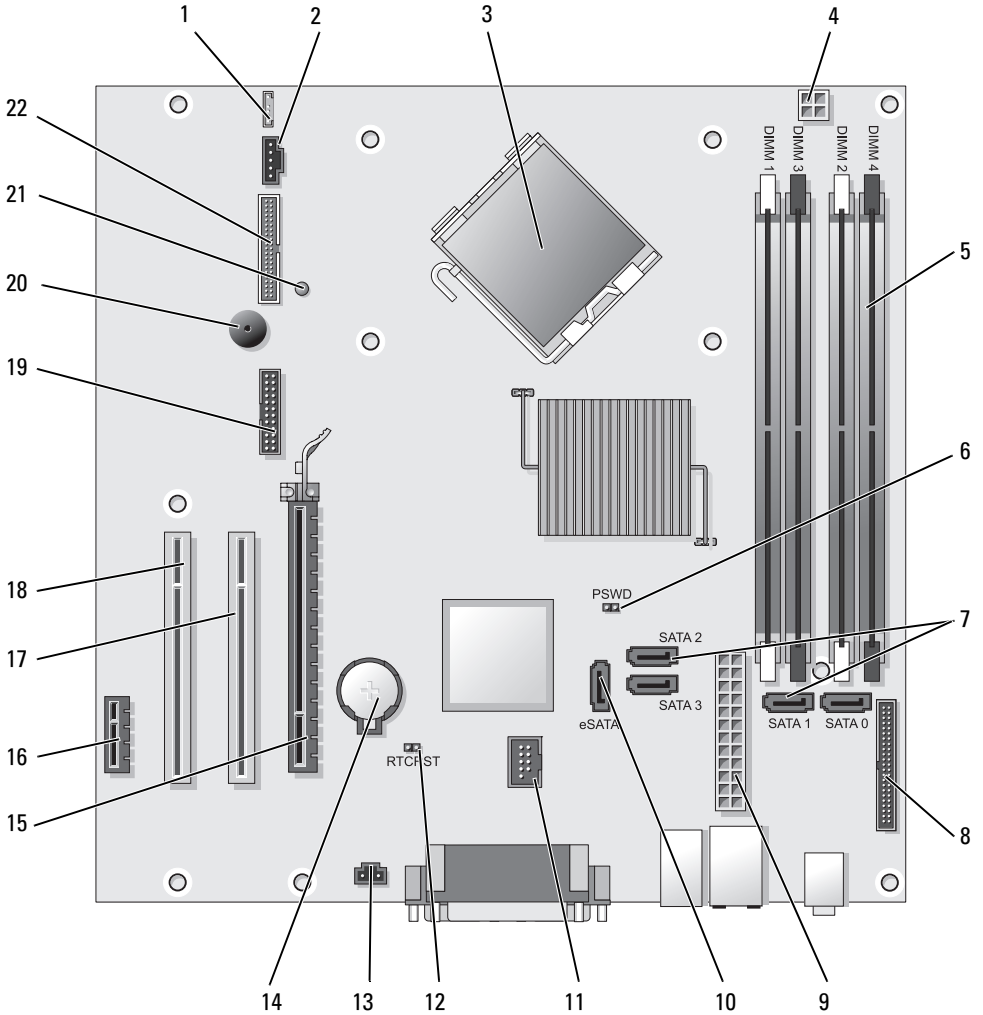

System Board Components





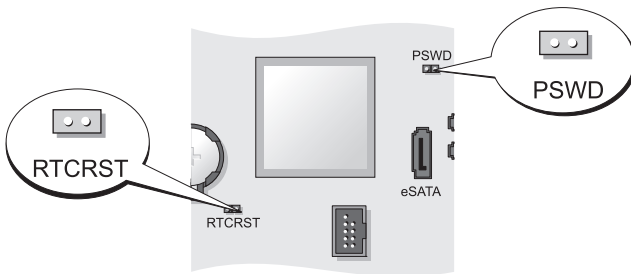

- | | | | |
|----|---|----|---------------------------------------|
| 1 | speaker connector (INT_SPKR) | 12 | RTC reset jumper (RTC_RST) |
| 2 | fan (FAN_CPU) | 13 | intrusion switch connector (INTRUDER) |
| 3 | processor connector (CPU) | 14 | battery socket (BATTERY) |
| 4 | processor power connector (12VPOWER) | 15 | PCI Express x16 connector (SLOT1) |
| 5 | memory module connectors (DIMM_1, DIMM_2, DIMM_3, DIMM_4) | 16 | PCI Express x1 connector (SLOT4) |
| 6 | password jumper (PSWD) | 17 | PCI connector (SLOT2) |
| 7 | SATA drive connectors (SATA0, SATA1, SATA2, SATA3) | 18 | PCI connector (SLOT3) |
| 8 | front-panel connector (FRONTPANEL) | 19 | serial connector (SERIAL2) |
| 9 | power connector (POWER) | 20 | system board speaker (BEEP) |
| 10 | external SATA connector (eSATA) | 21 | aux power LED (AUX_LED) |
| 11 | internal USB (INT_USB) | 22 | floppy connector (DSKT) |

Jumper Settings



Jumper	Setting	Description
PSWD		Password features are enabled (default setting).
		Password features are disabled.

Jumper	Setting	Description
RTCRAST		The real-time clock has not been reset.
		The real-time clock is being reset (jumped temporarily).

 *jumped*  *unjumpered*

Desktop Computer

System Views

Front View

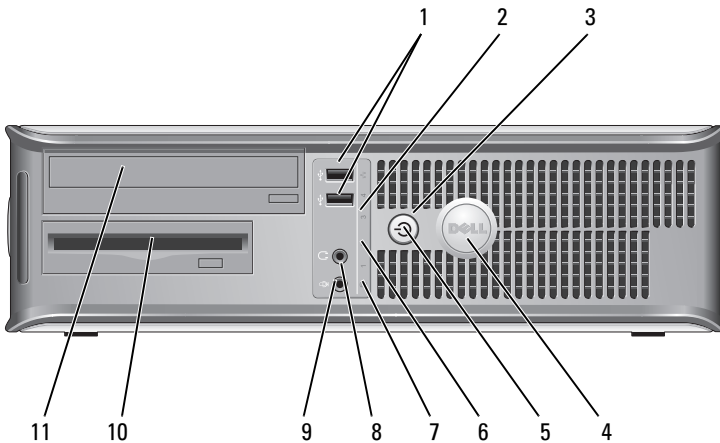



- 1** USB 2.0 connectors (2)

Use the front USB connectors for devices that you connect occasionally, such as joysticks or cameras, or for bootable USB devices (see "System Setup" in the *User's Guide* for more information about booting to a USB device).

It is recommended that you use the back USB connectors for devices that typically remain connected, such as printers and keyboards.
- 2** LAN indicator light

This light indicates that a LAN (local area network) connection is established.

- 3 power button Press this button to turn on the computer.
-  **NOTICE:** To avoid losing data, do not turn off the computer by pressing the power button. Instead, perform an operating system shutdown. See "Turning Off Your Computer" in the *User's Guide* for more information.
-  **NOTICE:** If your operating system has ACPI enabled, when you press the power button the computer will perform an operating system shutdown.
- 4 Dell badge This badge can be rotated to match the orientation of your computer. To rotate, place fingers around the outside of the badge, press firmly, and turn the badge. You can also rotate the badge using the slot provided near the bottom of the badge.
- 5 power light The power light illuminates and blinks or remains solid to indicate different operating states:
- No light — The computer is turned off.
 - Steady green — The computer is in a normal operating state.
 - Blinking green — The computer is in a power-saving mode.
 - Blinking or solid amber — See "Power Problems" in the *User's Guide*.
- To exit from a power-saving mode, press the power button or use the keyboard or the mouse if it is configured as a wake device in the Windows Device Manager. For more information about sleep modes and exiting from a power-saving mode, see "Power Management for Windows XP and Vista" in the *User's Guide*.
- See "Diagnostic Lights" on page 66 for a description of light codes that can help you troubleshoot problems with your computer.
- 6 diagnostic lights Use the lights to help you troubleshoot a computer problem based on the diagnostic code. For more information, see "Diagnostic Lights" on page 66.
- 7 hard drive activity light This light flickers when the hard drive is being accessed.

- | | | |
|----|----------------------|---|
| 8 | headphone connector | Use the headphone connector to attach headphones and most kinds of speakers. |
| 9 | microphone connector | Use the microphone connector to attach a microphone. |
| 10 | 3.5-inch drive bay | Can contain an optional floppy drive, second hard drive, or optional media card reader. |
| 11 | 5.25-inch drive bay | Can contain an optical drive. Insert a CD or DVD (if supported) into this drive. |

Back View

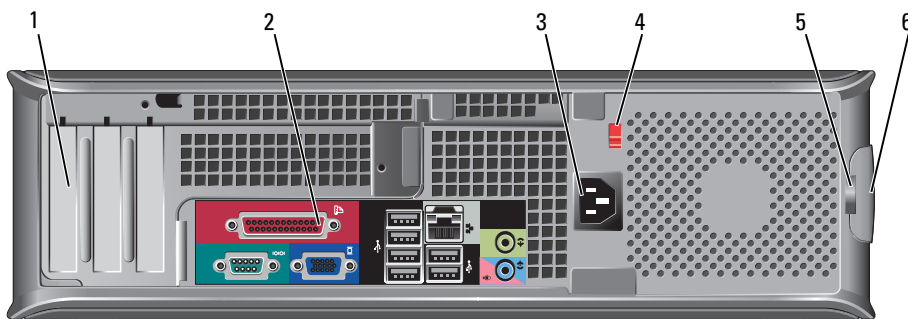

- | | | |
|---|-----------------------|--|
| 1 | card slots (3) | Access connectors for any installed PCI or PCI Express cards, PS/2 connector, eSATA connector, etc.
NOTE: The back view of the system will be different if a riser is installed. |
| 2 | back panel connectors | Plug serial, USB, and other devices into the appropriate connectors (see "Back Panel Connectors" on page 30). |
| 3 | power connector | Insert the power cable. |

- 4 voltage selection switch Your computer is equipped with a manual voltage selection switch. To help avoid damaging a computer with a manual voltage selection switch, set the switch for the voltage that most closely matches the AC power available in your location.
 - ➡ **NOTICE:** In Japan, the voltage selection switch must be set to the 115-V position.

Also, ensure that your monitor and attached devices are electrically rated to operate with the AC power available in your location.
- 5 padlock ring Insert a padlock to lock the computer cover.
- 6 cover-release latch Allows you to open the computer cover.

Back Panel Connectors

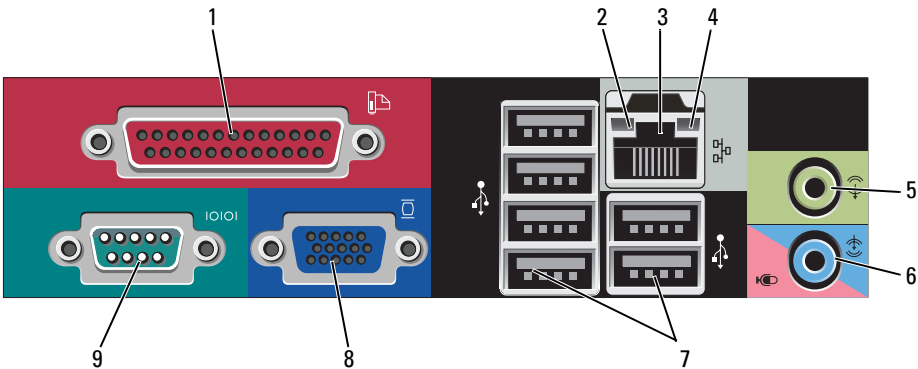

- 1 parallel connector Connect a parallel device, such as a printer, to the parallel connector. If you have a USB printer, plug it into a USB connector.
 - NOTE:** The integrated parallel connector is automatically disabled if the computer detects an installed card containing a parallel connector configured to the same address. For more information, see "System Setup Options" in the *User's Guide*.

- | | | |
|---|------------------------------|---|
| 2 | link integrity light | <ul style="list-style-type: none"> • Green — A good connection exists between a 10-Mbps network and the computer. • Orange — A good connection exists between a 100-Mbps network and the computer. • Yellow — A good connection exists between a 1-Gbps (or 1000-Mbps) network and the computer. • Off — The computer is not detecting a physical connection to the network. |
| 3 | network adapter connector | <p>To attach your computer to a network or broadband device, connect one end of a network cable to either a network jack or your network or broadband device. Connect the other end of the network cable to the network adapter connector on the back panel of your computer. A click indicates that the network cable has been securely attached.</p> <p>NOTE: Do not plug a telephone cable into the network connector.</p> <p>Remote management features require use of the onboard NIC.</p> <p>It is recommended that you use Category 5 wiring and connectors for your network. If you must use Category 3 wiring, force the network speed to 10 Mbps to ensure reliable operation.</p> |
| 4 | network activity light | Flashes a yellow light when the computer is transmitting or receiving network data. A high volume of network traffic may make this light appear to be in a steady "on" state. |
| 5 | line-out connector | Use the green line-out connector to attach headphones and most speakers with integrated amplifiers. |
| 6 | line-in/microphone connector | Use the blue and pink line-in/microphone connector to attach a record/playback device such as a cassette player, CD player, or VCR; or a personal computer microphone for voice or musical input into a sound or telephony program. |
| 7 | USB 2.0 connectors (6) | Use the back USB connectors for devices that typically remain connected, such as printers and keyboards. |

- 8 video connector Plug the cable from your VGA-compatible monitor into the blue connector.
- NOTE:** If you purchased an optional graphics card, this connector will be covered by a cap. Connect your monitor to the connector on the graphics card. Do not remove the cap.
- NOTE:** If you are using a graphics card that supports dual monitors, use the y-cable that came with your computer.
- 9 serial connector Connect a serial device, such as a handheld device, to the serial port. The default designations are COM1 for serial connector 1 and COM2 for serial connector 2.
- For more information, see "System Setup Options" in the *User's Guide*.

Removing the Computer Cover



CAUTION: Before you begin any of the procedures in this section, follow the safety instructions in the *Product Information Guide*.



CAUTION: To guard against electrical shock, always unplug your computer from the electrical outlet before removing the computer cover.

- 1 Follow the procedures in "Before You Begin" on page 13.
- 2 If you have installed a padlock through the padlock ring on the back panel, remove the padlock.
- 3 Locate the cover release latch shown in the illustration. Then, slide the release latch back as you lift the cover.
- 4 Grip the sides of the computer cover and pivot the cover up using the hinge tabs as leverage points.
- 5 Remove the cover from the hinge tabs and set it aside on a soft nonabrasive surface.



CAUTION: Graphics card heat sinks can become very hot during normal operation. Ensure that a graphics card heat sink has had sufficient time to cool before you touch it.

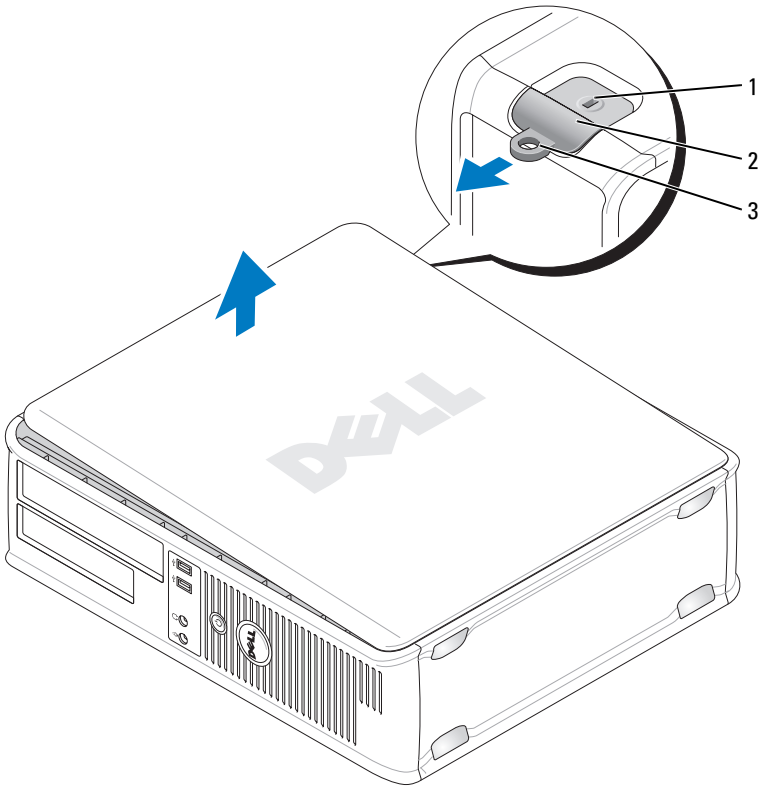

1 security cable slot

2 cover release latch

3 padlock ring

Inside Your Computer



CAUTION: Before you begin any of the procedures in this section, follow the safety instructions in the *Product Information Guide*.



CAUTION: To avoid electrical shock, always unplug your computer from the electrical outlet before removing the computer cover.



NOTICE: Be careful when opening the computer cover to ensure that you do not accidentally disconnect cables from the system board.

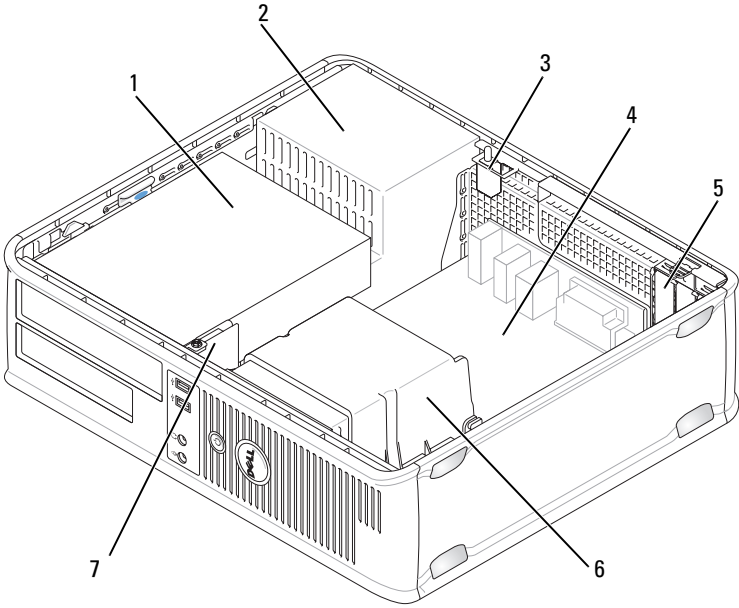

- | | | | |
|---|--|---|--------------------|
| 1 | drive bays (media card reader or floppy drive, optical drive and hard drive) | 2 | power supply |
| 3 | optional chassis-intrusion switch | 4 | system board |
| 5 | card slots | 6 | heat sink assembly |
| 7 | front I/O panel | | |

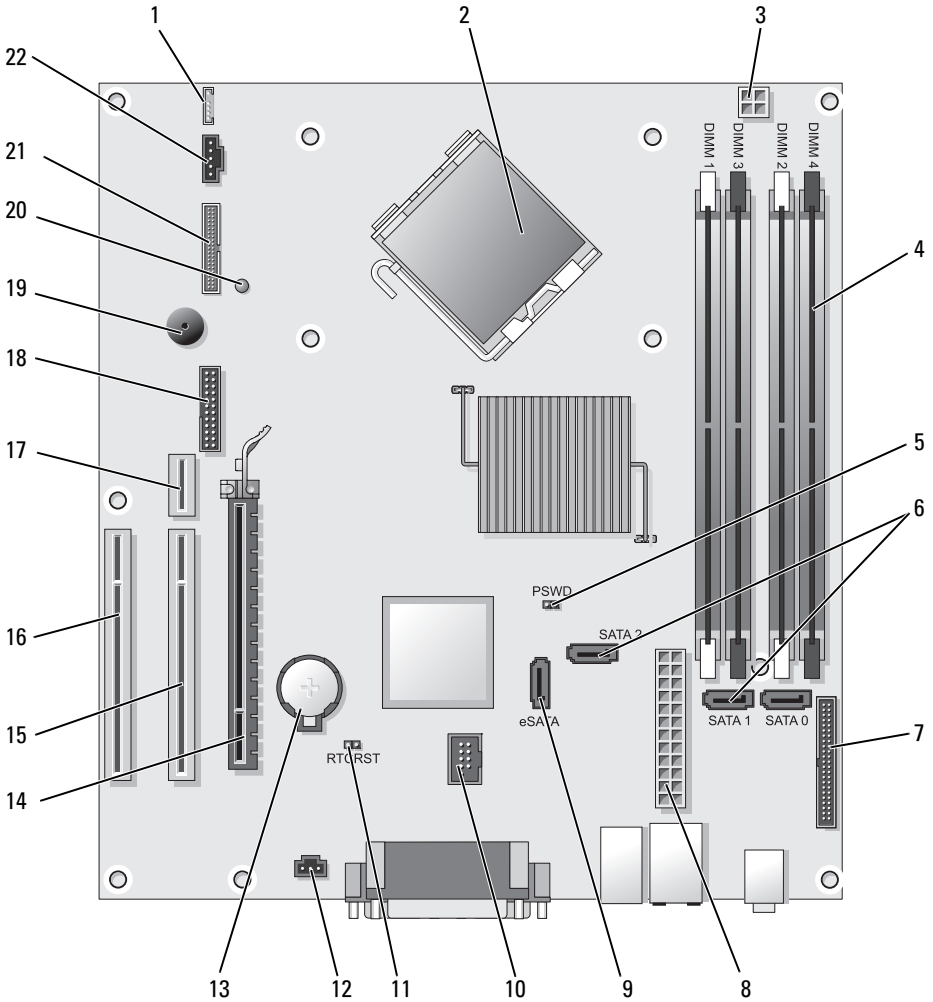

System Board Components





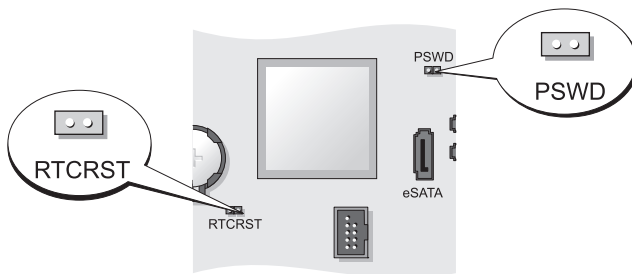

- | | | | |
|----|---|----|--|
| 1 | internal speaker (INT_SPKR) | 12 | intrusion switch connector (INTRUDER) |
| 2 | processor connector (CPU) | 13 | battery socket (BATTERY) |
| 3 | processor power connector (12VPOWER) | 14 | PCI Express x16 connector (SLOT1) |
| 4 | memory module connectors (DIMM_1, DIMM_2, DIMM_3, DIMM_4) | 15 | PCI connector (SLOT2) |
| 5 | password jumper (PSWD) | 16 | PCI connector (SLOT3) |
| 6 | SATA connectors (SATA0, SATA1, SATA2) | 17 | riser connector (uses PCI-E port/SLOT1 and PCI port/SLOT2) |
| 7 | front-panel connector (FRONTPANEL) | 18 | serial connector (SERIAL2) |
| 8 | power connector (POWER) | 19 | system board speaker (BEEP) |
| 9 | external SATA connector (eSATA) | 20 | aux power LED (AUX_LED) |
| 10 | internal USB (INT_USB) | 21 | floppy connector (DSKT) |
| 11 | RTC reset jumper (RTCRST) | 22 | fan connector (FAN_CPU) |

Jumper Settings



Jumper	Setting	Description
PSWD		Password features are enabled (default setting).
		Password features are disabled.

Jumper	Setting	Description
RTCST		The real-time clock has not been reset.
		The real-time clock is being reset (jumpered temporarily).

 *jumpered*  *unjumpered*

Small Form Factor Computer

System Views

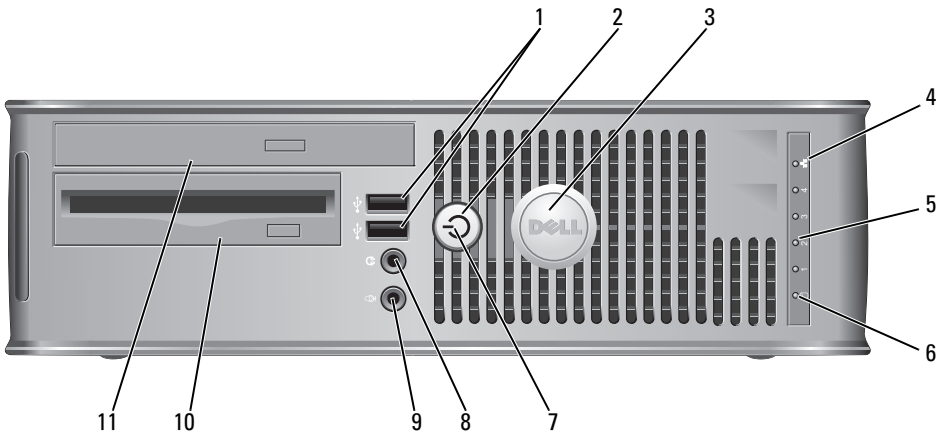

Front View



- 1 USB 2.0 connectors (2)

Use the front USB connectors for devices that you connect occasionally, such as joysticks or cameras, or for bootable USB devices (see "System Setup" in the *User's Guide* for more information about booting to a USB device).

It is recommended that you use the back USB connectors for devices that typically remain connected, such as printers and keyboards.

- | | | |
|---|---------------------------|---|
| 2 | power button | <p>Press to turn on the computer.</p> <p> NOTICE: To avoid losing data, do not turn off the computer by pressing the power button. Instead, perform an operating system shutdown. See "Turning Off Your Computer" on page 13 for more information.</p> <p> NOTICE: If your operating system has ACPI enabled, when you press the power button the computer will perform an operating system shutdown.</p> |
| 3 | Dell badge | <p>Can be rotated to match the orientation of your computer. To rotate, place fingers around the outside of the badge, press firmly, and turn the badge. You can also rotate the badge using the slot provided near the bottom of the badge.</p> |
| 4 | LAN indicator light | <p>Indicates that a LAN (local area network) connection is established.</p> |
| 5 | diagnostic lights | <p>Use the lights to help you troubleshoot a computer problem based on the diagnostic code. For more information, see "Diagnostic Lights" on page 66.</p> |
| 6 | hard drive activity light | <p>This light flickers when the hard drive is being accessed.</p> |

- 7 power light The power light illuminates and blinks or remains solid to indicate different operating states:
- No light — The computer is turned off.
 - Steady green — The computer is in a normal operating state.
 - Blinking green — The computer is in a power-saving mode.
 - Blinking or solid amber — See "Power Problems" in the *User's Guide*.
- To exit from a power-saving mode, press the power button or use the keyboard or the mouse if it is configured as a wake device in the Windows Device Manager. For more information about sleep modes and exiting from a power-saving mode, see "Power Management for Windows XP and Vista" in the *User's Guide*.
- See "Dell Diagnostics" on page 61 for a description of light codes that can help you troubleshoot problems with your computer.
- 8 headphone connector Use the headphone connector to attach headphones and most kinds of speakers.
- 9 microphone connector Use the microphone connector to attach a microphone.
- 10 3.5-inch drive bay Can contain an optional slimline floppy drive or optional media card reader.
- 11 5.25-inch drive bay Can contain a slimline optical drive. Insert a CD or DVD (if supported) into this drive.

Back View

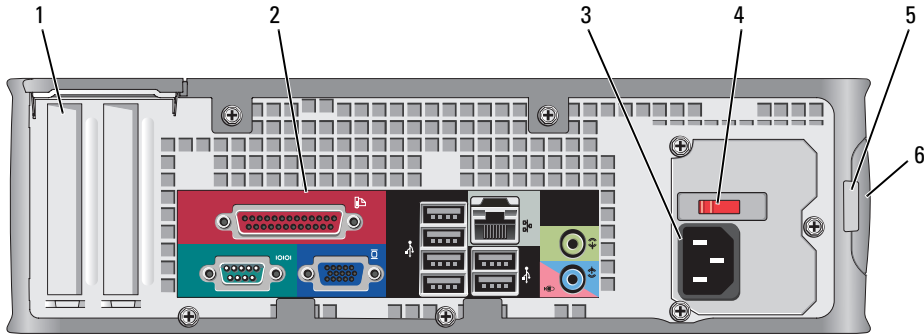

- 1 card slots (2) Access connectors for any installed PCI cards, PCI Express cards, PS/2, eSATA, and so on.
- 2 back panel connectors Plug serial, USB, and other devices into the appropriate connectors (see "Back Panel Connectors" on page 41).
- 3 power connector Insert the power cable.
- 4 voltage selection switch Your computer is equipped with a manual voltage-selection switch. To help avoid damaging a computer with a manual voltage selection switch, set the switch for the voltage that most closely matches the AC power available in your location.

➡ NOTICE: In Japan, the voltage selection switch must be set to the 115-V position.

Also, ensure that your monitor and attached devices are electrically rated to operate with the AC power available in your location.

- 5 padlock ring Insert a padlock to lock the computer cover.
- 6 cover release latch Allows you to open the computer cover.

Back Panel Connectors

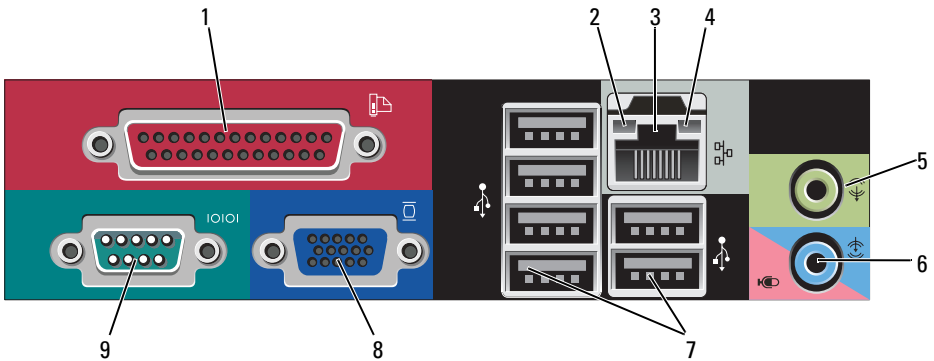

- 1 parallel connector Connect a parallel device, such as a printer, to the parallel connector. If you have a USB printer, plug it into a USB connector.

NOTE: The integrated parallel connector is automatically disabled if the computer detects an installed card containing a parallel connector configured to the same address. For more information, see "System Setup Options" in the *User's Guide*.

- 2 link integrity light
- Green — A good connection exists between a 10-Mbps network and the computer.
 - Orange — A good connection exists between a 100-Mbps network and the computer.
 - Yellow — A good connection exists between a 1-Gbps (or 1000-Mbps) network and the computer.
 - Off — The computer is not detecting a physical connection to the network.

- 3 network adapter connector To attach your computer to a network or broadband device, connect one end of a network cable to either a network jack or your network or broadband device. Connect the other end of the network cable to the network adapter connector on the back panel of your computer. A click indicates that the network cable has been securely attached.
- NOTE:** Do not plug a telephone cable into the network connector.
- Remote management features require use of the onboard NIC.
- It is recommended that you use Category 5 wiring and connectors for your network. If you must use Category 3 wiring, force the network speed to 10 Mbps to ensure reliable operation.
- 4 network activity light Flashes a yellow light when the computer is transmitting or receiving network data. A high volume of network traffic may make this light appear to be in a steady "on" state.
- 5 line-out connector Use the green line-out connector (available on computers with integrated sound) to attach headphones and most speakers with integrated amplifiers.
- 6 line-in/microphone connector Use the blue and pink line-in/microphone connector (available on computers with integrated sound) to attach a record/playback device such as a cassette player, CD player, or VCR; or a personal computer microphone for voice or musical input into a sound or telephony program.
- 7 USB 2.0 connectors (6) Use the back USB connectors for devices that typically remain connected, such as printers and keyboards.

- 8 video connector Plug the cable from your VGA-compatible monitor into the blue connector.
- NOTE:** If you purchased an optional graphics card, this connector will be covered by a cap. Connect your monitor to the connector on the graphics card. Do not remove the cap.
- NOTE:** If you are using a graphics card that supports dual monitors, use the y-cable that came with your computer.
- 9 serial connector Connect a serial device, such as a handheld device, to the serial port.
- For more information, see "System Setup Options" in the *User's Guide*.

Removing the Computer Cover



CAUTION: Before you begin any of the procedures in this section, follow the safety instructions in the *Product Information Guide*.



CAUTION: To guard against electrical shock, always unplug your computer from the electrical outlet before removing the computer cover.

- 1 Follow the procedures in "Before You Begin" on page 13.
- 2 If you have installed a padlock through the padlock ring on the back panel, remove the padlock.
- 3 Locate the cover release latch shown in the illustration. Then, slide the release latch back as you lift the cover.
- 4 Grip the sides of the computer cover and pivot the cover up using the bottom hinges as leverage points.
- 5 Remove the cover from the hinge tabs and set it aside on a soft nonabrasive surface.



CAUTION: Graphics card heat sinks can become very hot during normal operation. Ensure that a graphics card heat sink has had sufficient time to cool before you touch it.

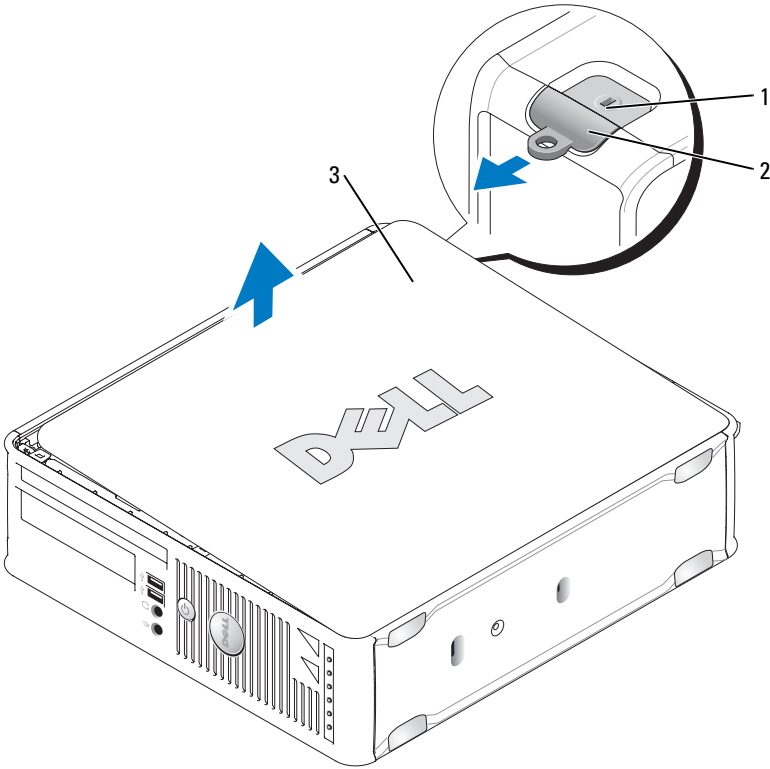

1 security cable slot

2 cover release latch

3 computer cover

Inside Your Computer

! **CAUTION:** Before you begin any of the procedures in this section, follow the safety instructions in the *Product Information Guide*.

! **CAUTION:** To avoid electrical shock, always unplug your computer from the electrical outlet before removing the computer cover.

➡ **NOTICE:** Be careful when opening the computer cover to ensure that you do not accidentally disconnect cables from the system board.

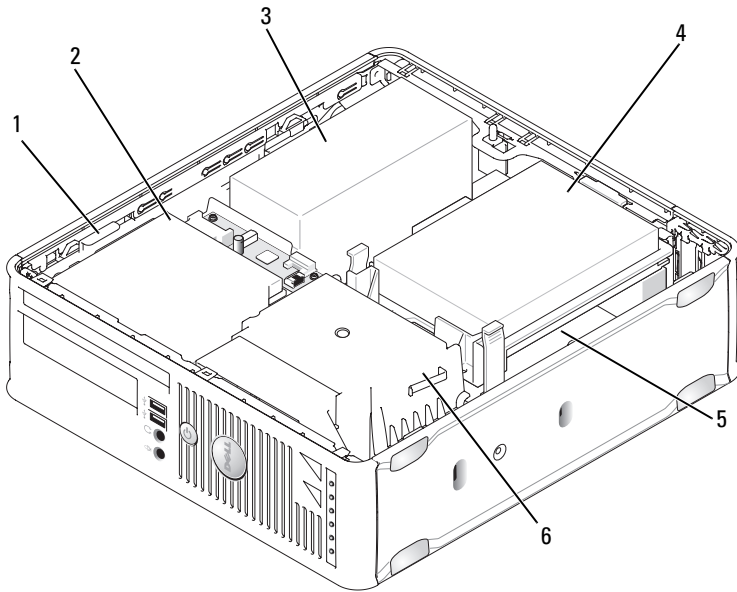

- | | | | |
|---|---------------------|---|--------------------|
| 1 | drive-release latch | 2 | optical drive |
| 3 | power supply | 4 | hard drive |
| 5 | system board | 6 | heat sink assembly |

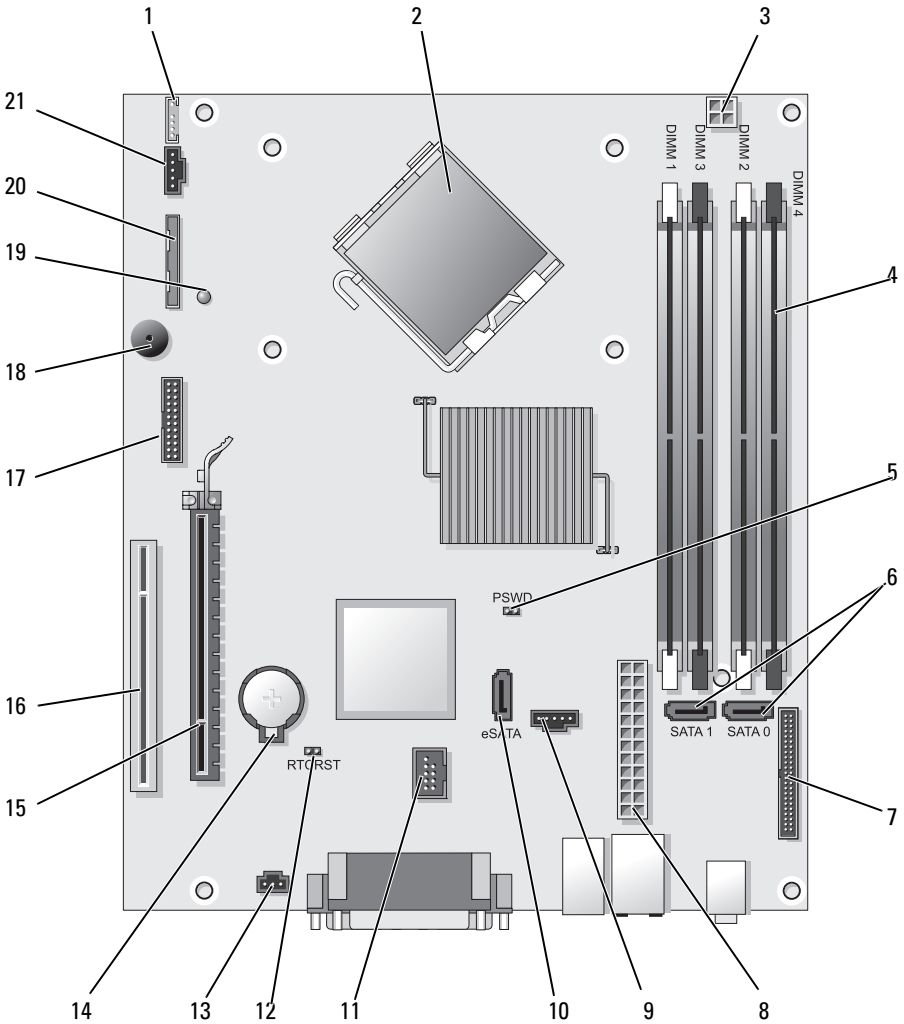

System Board Components





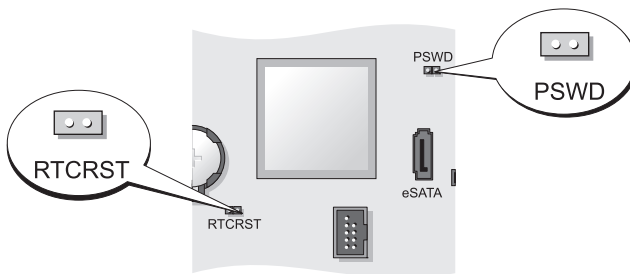

- | | | | |
|----|---|----|---------------------------------------|
| 1 | internal speaker connector (INT_SPKR) | 12 | RTC reset jumper (RTCRST) |
| 2 | processor connector (CPU) | 13 | intrusion switch connector (INTRUDER) |
| 3 | processor power connector (12VPOWER) | 14 | battery socket (BATTERY) |
| 4 | memory module connectors (DIMM_1, DIMM_2, DIMM_3, DIMM_4) | 15 | PCI Express x16 connector (SLOT1) |
| 5 | password jumper (PSWD) | 16 | PCI connector (SLOT2) |
| 6 | SATA connectors (SATA0, SATA1) | 17 | serial connector (SERIAL2) |
| 7 | front-panel connector (FRONTPANEL) | 18 | system board speaker (BEEP) |
| 8 | power connector (POWER) | 19 | aux power LED (AUX_LED) |
| 9 | fan connector (FAN_HDD) | 20 | floppy drive connector (DSKT) |
| 10 | eSATA connector (eSATA) | 21 | fan connector (FAN_CPU) |
| 11 | internal USB connector (INT_USB) | | |

Jumper Settings





Jumper	Setting	Description
PSWD		Password features are enabled (default setting).
		Password features are disabled.

Jumper	Setting	Description
RTC RST		The real-time clock has not been reset.
		The real-time clock is being reset (jumped temporarily).

 *jumped*  *unjumped*

Ultra Small Form Factor Computer

System Views

-  **NOTICE:** Do not place your monitor on the computer. Use a monitor stand.
-  **NOTICE:** When setting up your computer, secure all cables toward the back of your work area to prevent the cables from being pulled, tangled, or stepped on.
-  **NOTE:** If you want to orient your computer under a desk top or on a wall surface, use the optional wall-mount bracket. To order this bracket, contact Dell (see "Contacting Dell" in the *User's Guide*).



Front View

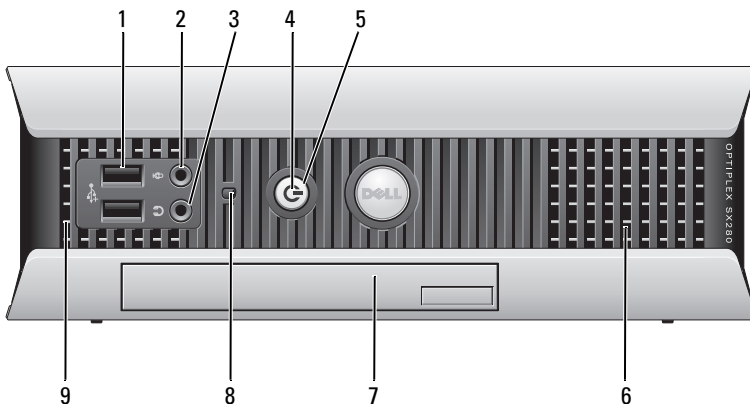

- 1 USB connectors (2) Use the front USB connectors for devices that you connect occasionally, such as joysticks or cameras, or for bootable USB devices (see "System Setup" in the *User's Guide* for more information about booting to a USB device).
It is recommended that you use the back USB connectors for devices that typically remain connected, such as printers and keyboards.
- 2 microphone connector Use the microphone connector to attach a microphone.
- 3 headphone connector Use the headphone connector to attach headphones and most kinds of speakers.
- 4 power light The power light illuminates and blinks or remains solid to indicate different states:
- No light — The computer is turned off.
 - Steady green — The computer is in a normal operating state.
 - Blinking green — The computer is in a power-saving mode.
 - Blinking or solid yellow — See "Power Problems" in the *User's Guide*.
- To exit from a power-saving mode, press the power button or use the keyboard or the mouse if it is configured as a wake device in the Windows Device Manager. For more information about sleep modes and exiting from a power-saving mode, see "Power Management for Windows XP and Vista" in the *User's Guide*.
See "System Lights" on page 65 for a description of light codes that can help you troubleshoot problems with your computer.
- 5 power button Press this button to turn on the computer.
-  **NOTICE:** To avoid losing data, do not turn off the computer by pressing the power button. See "Turning Off Your Computer" on page 13 for more information
- 6 vents The vents help prevent your computer from overheating. To ensure proper ventilation, do not block these cooling vents.
- 7 module bay Install a D-module optical drive, second hard drive, or floppy drive in the module bay.

- 8 hard drive access light The hard drive access light is on when the computer reads data from or writes data to the hard drive. The light might also be on when devices such as your CD player are operating.
- 9 vents The vents help prevent your computer from overheating. To ensure proper ventilation, do not block these cooling vents.

Side View

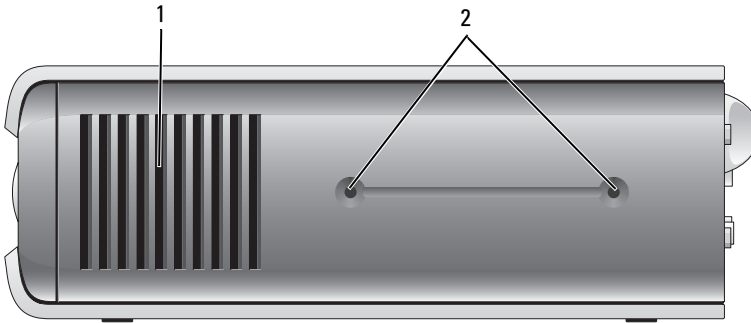

- 1 vents The vents located on each side of the computer help prevent your computer from overheating. To ensure proper ventilation, do not block these cooling vents.
- 2 mounting holes For mounting optional stand.

Back View

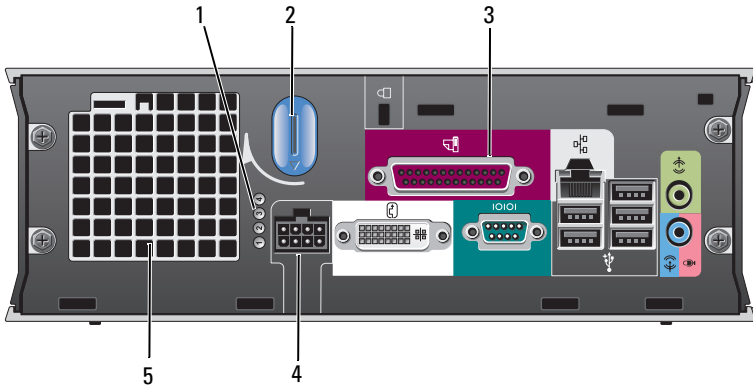

- | | | |
|---|-----------------------------|---|
| 1 | diagnostic lights | See "Diagnostic Lights" on page 66 for a description of light codes that can help you troubleshoot problems with your computer. |
| 2 | computer cover release knob | Rotate this knob in a clockwise direction to remove the cover. |
| 3 | back panel connectors | See "Back Panel Connectors" on page 52 for a description of the connectors for your computer. |
| 4 | power connector | Insert the AC power adapter plug. |
| 5 | vents | The vents help prevent your computer from overheating. To ensure proper ventilation, do not block these cooling vents. |

Back Panel Connectors

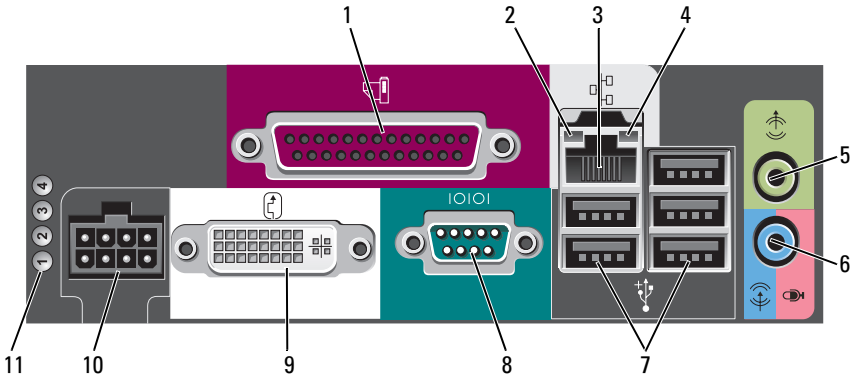

- 1 parallel connector Connect a parallel device, such as a printer, to the parallel connector. If you have a USB printer, plug it into a USB connector.
- 2 link integrity light
- Green — A good connection exists between a 10-Mbps network and the computer.
 - Orange — A good connection exists between a 100-Mbps network and the computer.
 - Yellow — A good connection exists between a 1000-Mbps (1-Gbps) network and the computer.
 - Off — The computer is not detecting a physical connection to the network or the network controller is turned off in system setup.

- 3 network adapter To attach your computer to a network or broadband device, connect one end of a network cable to either a network jack or your network or broadband device. Connect the other end of the network cable to the network adapter connector on the back panel of your computer. A click indicates that the network cable has been securely attached.

NOTE: Do not plug a telephone cable into the network connector.

It is recommended that you use Category 5 wiring and connectors for your network. If you must use Category 3 wiring, force the network speed to 10 Mbps to ensure reliable operation.

- | | | |
|----|------------------------------|--|
| 4 | network activity light | The amber light flashes when the computer is transmitting or receiving network data. A high volume of network traffic may make this light appear to be in a steady "on" state. |
| 5 | line-out connector | Use the green line-out connector to attach an amplified speaker set. |
| 6 | line-in/microphone connector | Use the blue and pink line-in/microphone connector to attach a record/playback device such as a cassette player, CD player, or VCR.; or a personal computer microphone for voice or musical input into a sound or telephony program. |
| 7 | USB connectors (5) | Use the back USB connectors for devices that typically remain connected, such as printers and keyboards. |
| 8 | serial connector | Connect a serial device, such as a handheld device, to the serial connector. |
| 9 | video connector | If you have a DVI-compatible monitor, plug the cable from your monitor into the white DVI video connector on the back panel.

If you have a VGA monitor, see "Connecting a VGA Monitor" on page 53. |
| 10 | power connector | Insert the AC power adapter plug. |
| 11 | diagnostic lights | See "Diagnostic Lights" on page 66 for a description of light codes that can help you troubleshoot problems with your computer. |

Connecting a VGA Monitor

If you have a VGA monitor, plug the adapter cable into the white DVI video connector on the back panel of your computer, and connect the monitor cable to the VGA connector on the adapter.

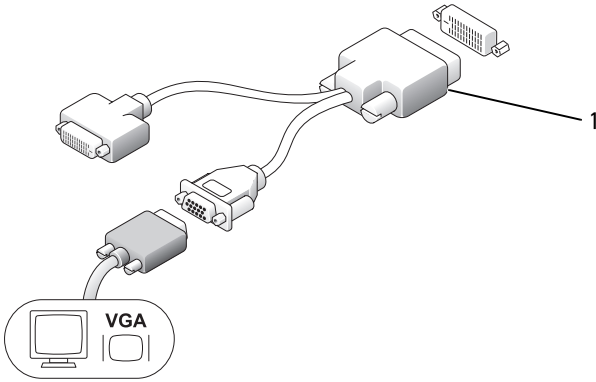

- 1 cable adapter
- 2 VGA connector
- 3 monitor cable

Connecting Two Monitors

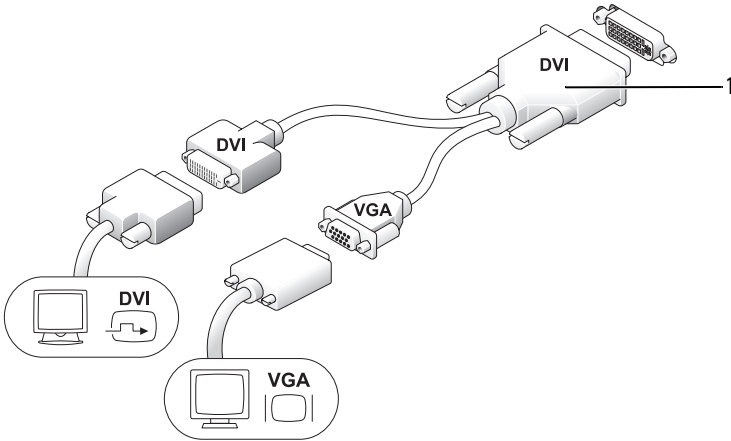



- 1 cable adapter

Use the cable adapter to connect a VGA monitor and a DVI monitor to the DVI-I connector on the back panel.

When you connect two monitors, the video driver will detect this connection and activate the multimonitor functionality.

Removing the Computer Cover

 **CAUTION:** Before you begin any of the procedures in this section, follow the safety instructions in the *Product Information Guide*.

 **NOTICE:** To prevent static damage to components inside your computer, discharge static electricity from your body before you touch any of your computer's electronic components. You can do so by touching an unpainted metal surface on the computer chassis.

- 1 Follow the procedures in "Before You Begin" on page 13.
- 2 Remove the computer cover (see "Removing the Computer Cover" on page 55).

 **NOTICE:** Before touching anything inside your computer, ground yourself by touching an unpainted metal surface. While you work, periodically touch an unpainted metal surface to dissipate any static electricity that could harm internal components.

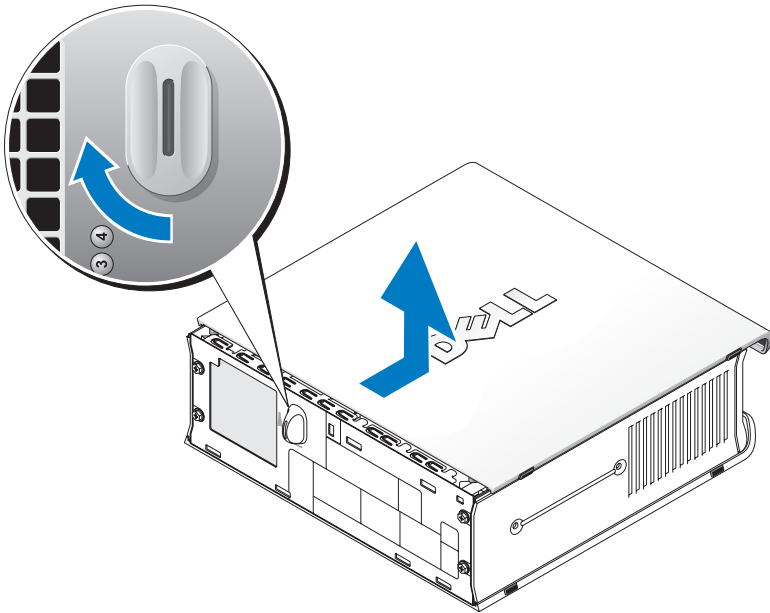

- 3 If applicable, remove the cable cover, (see "Cable Cover (Optional)" on page 57).
- 4 Remove the computer cover:
 - a Rotate the cover release knob in a clockwise direction, as shown in the illustration.
 - b Slide the computer cover forward by 1 cm (1/2 inch), or until it stops, and then raise the cover.

 **CAUTION:** Graphics card heat sinks can become very hot during normal operation. Ensure that a graphics card heat sink has had sufficient time to cool before you touch it.



1 release knob

Inside Your Computer

-  **CAUTION:** Before you begin any of the procedures in this section, follow the safety instructions in the *Product Information Guide*.
-  **CAUTION:** To avoid electrical shock, always unplug your computer from the AC power adapter before removing the cover.
-  **NOTICE:** To prevent static damage to components inside your computer, discharge static electricity from your body before you touch any of your computer's electronic components. You can do so by touching an unpainted metal surface on the computer chassis.

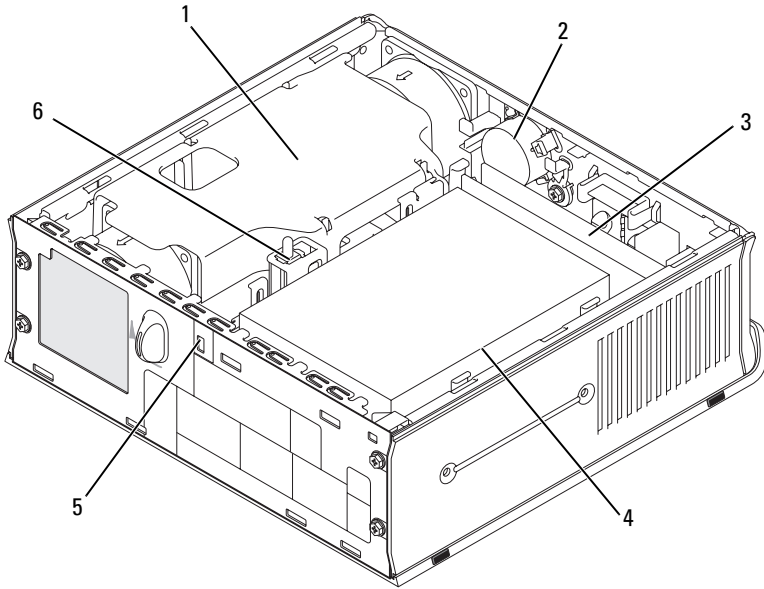

- | | | | |
|---|-------------------------------|---|--------------------------|
| 1 | fan shroud/heat sink assembly | 2 | speaker (optional) |
| 3 | memory modules (2) | 4 | hard drive |
| 5 | security cable slot | 6 | chassis intrusion switch |

Cable Cover (Optional)

Attaching the Cable Cover

- 1 Ensure that all external device cables are threaded through the hole in the cable cover.
- 2 Connect all device cables to the connectors on the back of the computer.
- 3 Hold the bottom of the cable cover so as to align the tabs with the slots on the computer's back panel.
- 4 Insert the tabs into the slots and slide the cover to align the ends of the cover with the ends of the chassis (see the illustration) until the cable cover is securely positioned.
- 5 Install a security device in the security cable slot (optional).

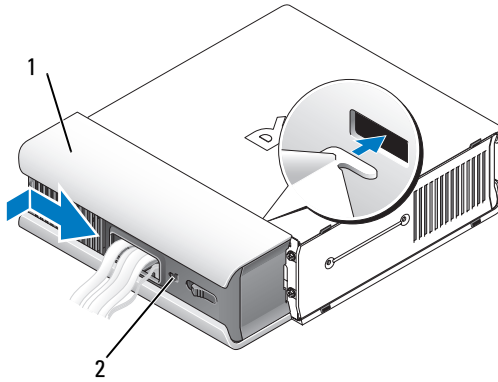

1 cable cover

2 security cable slot

Removing the Cable Cover

- 1 If a security device is installed in the security cable slot, remove the device.

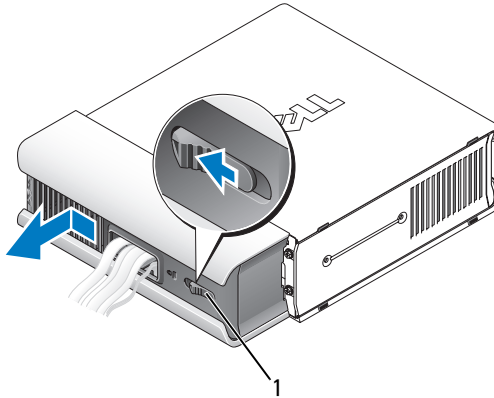

1 release button

- 2 Slide the release button, grasp the cable cover, and slide the cover sideways as shown until it stops, and then lift the cable cover up and away.

System Board Components

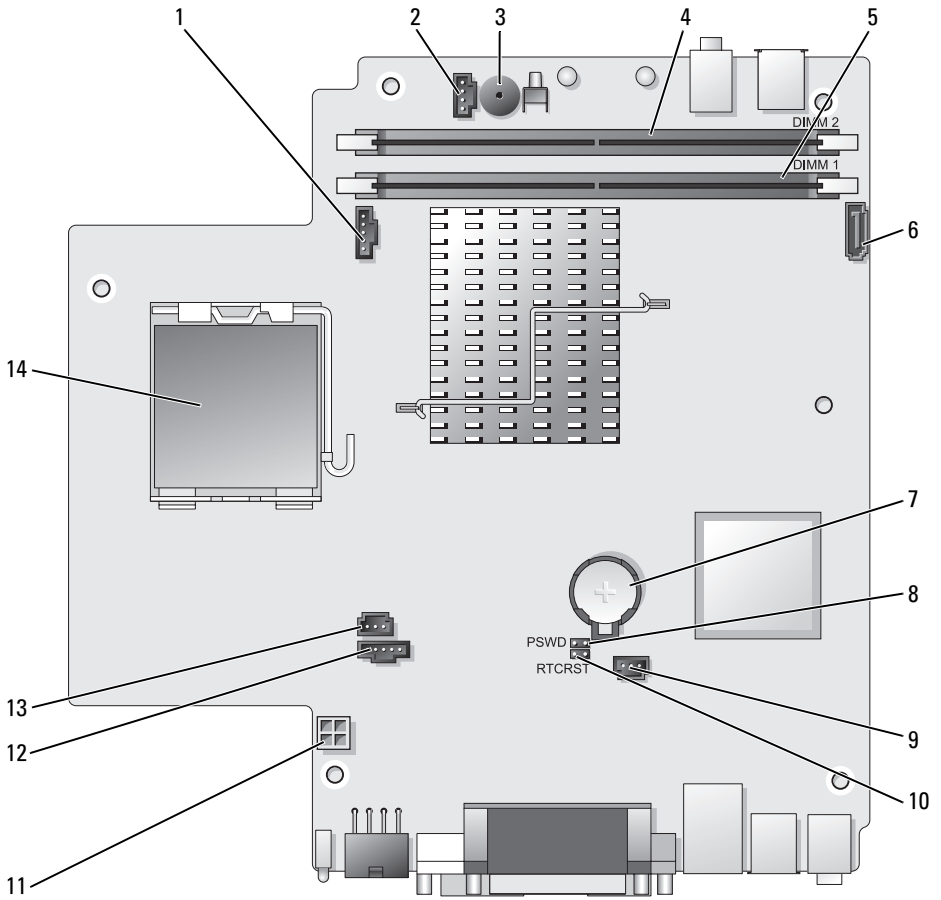



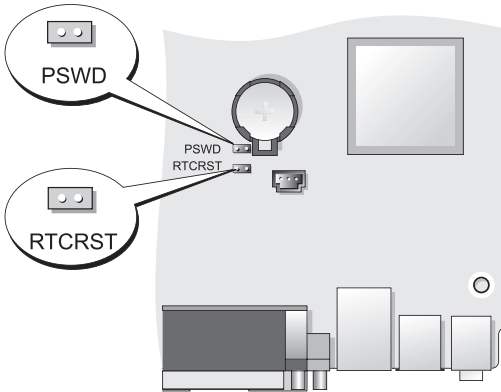

- 1 fan connector (FAN_FRONT)
- 2 internal speaker connector (INT_SPKR)
- 3 system board speaker (BEEP)
- 4 channel B memory connector (DIMM_2)
- 5 channel A memory connector (DIMM_1)
- 6 SATA data cable connector (SATA0)
- 7 battery (BATT)
- 8 password jumper (PSWD)
- 9 hard drive fan connector (FAN_HDD)
- 10 clear CMOS jumper (RTCST)
- 11 hard drive power connector (SATA_PWR)
- 12 fan connector (FAN_REAR)
- 13 intrusion switch connector (INTRUDER)
- 14 processor (CPU)

Jumper Settings



Jumper	Setting	Description
PSWD		Password features are enabled (default setting).
		Password features are disabled.

Jumper	Setting	Description
RTCST		The real-time clock has not been reset.
		The real-time clock is being reset (jumpered temporarily).

 *jumpered*  *unjumpered*

Solving Problems

Dell provides a number of tools to help you if your computer does not perform as expected. For the latest troubleshooting information available for your computer, see the Dell Support website at support.dell.com.

If computer problems occur that require help from Dell, write a detailed description of the error, beep codes, or diagnostics light patterns, record your Express Service Code and Service Tag below, and then contact Dell from the same location as your computer. For information on contacting Dell, see your online *User's Guide*.

For an example of the Express Service Code and Service Tag, see "Finding Information" in your computer *User's Guide*.

Express Service Code: _____

Service Tag: _____

Dell Diagnostics



CAUTION: Before you begin any of the procedures in this section, follow the safety instructions located in the *Product Information Guide*.

When to Use the Dell Diagnostics

If you experience a problem with your computer, perform the checks in this section and run the Dell Diagnostics before you contact Dell for technical assistance.

It is recommended that you print these procedures before you begin.



NOTICE: The Dell Diagnostics works only on Dell™ computers.

Enter system setup (see "Entering System Setup" in the *User's Guide*), review your computer's configuration information, and ensure that the device you want to test displays in system setup and is active.

Start the Dell Diagnostics from either your hard drive or from the *Drivers and Utilities media* (an optional CD). See "Starting the Dell Diagnostics From Your Hard Drive" on page 62 or "Starting the Dell Diagnostics From the Drivers and Utilities CD (Optional)" on page 63 for more information.

Starting the Dell Diagnostics From Your Hard Drive

The Dell Diagnostics is located on a hidden diagnostic utility partition on your hard drive.



NOTE: If your computer cannot display a screen image, contact Dell.

- 1 Shut down the computer. Turn on (or restart) your computer.
- 2 If the computer is connected to a docking device (docked), undock it. See the documentation that came with your docking device for instructions.
- 3 Connect the computer to an electrical outlet.
- 4 Turn on the computer. When the DELL™ logo appears, press <F12> immediately.



NOTE: If you see a message stating that no diagnostics utility partition has been found, run the Dell Diagnostics from your optional *Drivers and Utilities CD*. See "Using the Drivers and Utilities Media" on page 78 for more information about the optional *Drivers and Utilities CD*.

If you wait too long and the operating system logo appears, continue to wait until you see the Microsoft® Windows® desktop. Then shut down your computer and try again.

- 5 When the boot device list appears, highlight **DiagnosticsBoot to Utility Partition** and press <Enter>.
- 6 Press any key to choose a diagnostic option on your hard drive. The resulting menu displays:
 - Test Memory - this takes you to the MPMemory Diagnostic
 - Test System - takes you to the Dell Diagnostic Utility
 - Exit - exits Diagnostics
- 7 Select **Test System**.
- 8 When the Dell Diagnostics **Main Menu** appears, select the test you want to run (see "Dell Diagnostics Main Menu" on page 63).

Starting the Dell Diagnostics From the Drivers and Utilities CD (Optional)

- 1 Insert the *Drivers and Utilities* CD (optional).
- 2 Shut down and restart the computer.

When the DELL logo appears, press <F12> immediately.

If you wait too long and the Windows logo appears, continue to wait until you see the Windows desktop. Then shut down your computer and try again.



NOTE: The next steps change the boot sequence for one time only. On the next start-up, the computer boots according to the devices specified in system setup.

- 3 When the boot device list appears, highlight **SATA CD-ROM Device** and press <Enter>.
- 4 Select the **SATA CD-ROM Device** option from the CD boot menu.
- 5 Select the **Boot from CD-ROM** option from the menu that appears.
- 6 Type 1 to start the *Drivers and Utilities* CD menu.
- 7 Type 2 to start the Dell Diagnostics.
- 8 Select **Run the 32 Bit Dell Diagnostics** from the numbered list. If multiple versions are listed, select the version appropriate for your computer.
- 9 When the Dell Diagnostics **Main Menu** appears, select the test you want to run (see "Dell Diagnostics Main Menu" on page 63).

Dell Diagnostics Main Menu

- 1 After the Dell Diagnostics loads and the **Main Menu** screen appears, click the button for the option you want.

Option	Function
Express Test	Performs a quick test of devices. This test typically takes 10 to 20 minutes and requires no interaction on your part. Run Express Test first to increase the possibility of tracing the problem quickly.
Extended Test	Performs a thorough check of devices. This test typically takes an hour or more and requires you to answer questions periodically.

Option	Function
Custom Test	Tests a specific device. You can customize the tests you want to run.
Symptom Tree	Lists the most common symptoms encountered and allows you to select a test based on the symptom of the problem you are having.

- 2 If a problem is encountered during a test, a message appears with an error code and a description of the problem. Write down the error code and problem description and follow the instructions on the screen.

If you cannot resolve the error condition, contact Dell (see "Contacting Dell" in the *User's Guide*).



NOTE: The Service Tag for your computer is located at the top of each test screen. If you contact Dell, technical support will ask for your Service Tag. Your computer's Service Tag is listed in the **System Info** option in system setup. See "System Setup" in the *User's Guide* for more information.

- 3 If you run a test from the **Custom Test** or **Symptom Tree** option, click the applicable tab described in the following table for more information.

Tab	Function
Results	Displays the results of the test and any error conditions encountered.
Errors	Displays error conditions encountered, error codes, and the problem description.
Help	Describes the test and may indicate requirements for running the test.
Configuration	Displays your hardware configuration for the selected device. The Dell Diagnostics obtains configuration information for all devices from system setup, memory, and various internal tests, and it displays the information in the device list in the left pane of the screen. The device list may not display the names of all the components installed on your computer or all devices attached to your computer.
Parameters	Allows you to customize the test by changing the test settings.

- 4 When the tests are completed, if you are running the Dell Diagnostics from the *Drivers and Utilities CD*, remove the CD.
- 5 When the tests are complete, close the test screen to return to the **Main Menu** screen. To exit the Dell Diagnostics and restart the computer, close the **Main Menu** screen.

System Lights

Your power button light and hard drive light may indicate a computer problem.

Power Light	Problem Description	Suggested Resolution
Solid green	Power is on, and the computer is operating normally. On the desktop computer, a solid green light indicates a network connection.	No corrective action is required.
Blinking green	The computer is in a power-saving mode.	Press the power button, move the mouse, or press a key on the keyboard to wake the computer.
Blinks green several times and then turns off	A configuration error exists.	Check the diagnostic lights to see if the specific problem is identified (see "Diagnostic Lights" on page 66).
Solid yellow	The Dell Diagnostics is running a test, or a device on the system board may be faulty or incorrectly installed.	If the Dell Diagnostics is running, allow the testing to complete. If the computer does not boot, contact Dell for technical assistance (see "Contacting Dell" in the <i>User's Guide</i>).
Blinking yellow	A power supply or system board failure has occurred.	See "Power Problems" in the <i>User's Guide</i> .

Power Light	Problem Description	Suggested Resolution
Solid green and a beep code during POST	A problem was detected while the BIOS was executing.	See "Beep Codes" on page 70 for instructions on diagnosing the beep code. Also, check the diagnostic lights to see if the specific problem is identified (see "Diagnostic Lights" on page 66).
Solid green power light and no beep code and no video during POST	The monitor or the graphics card may be faulty or incorrectly installed.	Check the diagnostic lights to see if the specific problem is identified (see "Diagnostic Lights" on page 66). See "Video and Monitor Problems" in the <i>User's Guide</i> .
Solid green power light and no beep code but the computer locks up during POST	An integrated system board device may be faulty.	Check the diagnostic lights to see if the specific problem is identified (see "Diagnostic Lights" on page 66). If the problem is not identified, contact Dell for technical assistance (see "Contacting Dell" in the <i>User's Guide</i>).

Diagnostic Lights





 **CAUTION:** Before you begin any of the procedures in this section, follow the safety instructions in the *Product Information Guide*.



To help troubleshoot a problem, your computer has four lights labeled 1, 2, 3, and 4 on the front panel. When the computer starts normally, the lights flash before turning off. If the computer malfunctions, the sequence of the lights help to identify the problem.



NOTE: After the computer completes POST, all four lights turn off before booting to the operating system.

Power Light	Problem Description	Suggested Resolution
①②③④	<p>The computer is in a normal <i>off</i> condition or a possible pre-BIOS failure has occurred.</p> <p>The diagnostic lights are not lit after the system successfully boots to the operating system.</p>	<ul style="list-style-type: none"> • Plug the computer into a working electrical outlet (see "Power Problems" in the <i>User's Guide</i>). • If the problem persists, contact Dell (see "Contacting Dell" in the <i>User's Guide</i>).
①②③④	<p>A possible processor failure has occurred.</p>	<ul style="list-style-type: none"> • Reseat the processor (see Processor information for your system). • If the problem persists, contact Dell (see "Contacting Dell" in the <i>User's Guide</i>).
①②③④	<p>Memory modules are detected, but a memory failure has occurred.</p>	<ul style="list-style-type: none"> • If two or more memory modules are installed, remove the modules (see "Removing Memory" in the <i>User's Guide</i>), then reinstall one module (see "Installing Memory" in the <i>User's Guide</i>) and restart the computer. If the computer starts normally, continue to install additional memory modules (one at a time) until you have identified a faulty module or reinstalled all modules without error. • If available, install working memory of the same type into your computer (see "Installing Memory" in the <i>User's Guide</i>). • If the problem persists, contact Dell (see "Contacting Dell" in the <i>User's Guide</i>).

Power Light	Problem Description	Suggested Resolution
	A possible graphics card failure has occurred.	<ul style="list-style-type: none"> • Reseat any installed graphics cards (see the "Cards" information for your system). • If available, install a working graphics card into your computer. • If the problem persists, contact Dell (see "Contacting Dell" in the <i>User's Guide</i>).
	A possible floppy drive or hard drive failure has occurred.	Reseat all power and data cables.
	A possible USB failure has occurred.	Reinstall all USB devices and check all cable connections.
	No memory modules are detected.	<ul style="list-style-type: none"> • If two or more memory modules are installed, remove the modules (see "Removing Memory" in the <i>User's Guide</i>), then reinstall one module (see "Installing Memory" in the <i>User's Guide</i>) and restart the computer. If the computer starts normally, continue to install additional memory modules (one at a time) until you have identified a faulty module or reinstalled all modules without error. • If available, install working memory of the same type into your computer (see "Installing Memory" in the <i>User's Guide</i>). • If the problem persists, contact Dell (see "Contacting Dell" in the <i>User's Guide</i>).

Power Light	Problem Description	Suggested Resolution
	Memory modules are detected, but a memory configuration or compatibility error has occurred.	<ul style="list-style-type: none"> • Ensure that no special requirements for memory module/connector placement exist (see "Memory" in the <i>User's Guide</i>). • Ensure that the memory you are using is supported by your computer (see the specifications for your system). • If the problem persists, contact Dell (see "Contacting Dell" in the <i>User's Guide</i>).
	A possible expansion card failure has occurred.	<ol style="list-style-type: none"> 1 Determine if a conflict exists by removing an expansion card (not a graphics card) and restarting the computer (see the "Cards" section for your system). 2 If the problem persists, reinstall the card you removed, then remove a different card and restart the computer. 3 Repeat this process for each expansion card installed. If the computer starts normally, troubleshoot the last card removed from the computer for resource conflicts (see "Resolving Software and Hardware Incompatibilities" on page 72). 4 If the problem persists, contact Dell (see "Contacting Dell" in the <i>User's Guide</i>).

Power Light	Problem Description	Suggested Resolution
	Another failure has occurred.	<ul style="list-style-type: none"> • Ensure that all hard drive and optical drive cables are properly connected to the system board (see "System Board Components" for your system). • If there is an error message on the screen identifying a problem with a device (such as the floppy drive or hard drive), check the device to make sure it is functioning properly. • If the operating system is attempting to boot from a device (such as the floppy drive or optical drive), check system setup (see "System Setup" in the <i>User's Guide</i>) to ensure the boot sequence is correct for the devices installed on your computer. • If the problem persists, contact Dell (see "Contacting Dell" in the <i>User's Guide</i>).

Beep Codes

Your computer might emit a series of beeps during start-up if the monitor cannot display errors or problems. This series of beeps, called a beep code, identifies a problem. For example, beep code 1-3-1 (one possible beep code) consists of one beep, a burst of three beeps, and then one beep. This beep code tells you that the computer encountered a memory problem.

Reseating the memory modules may correct the following beep code errors. If the problem persists, contact Dell (see "Contacting Dell" in the *User's Guide*) for instructions on obtaining technical assistance.

Code	Cause
1-3-1 through 2-4-4	Memory not being properly identified or used
4-3-1	Memory failure above address 0FFFFh

If you experience any of the following beep code errors, see "Contacting Dell" in the *User's Guide* for instructions on obtaining technical assistance.

Code	Cause
1-1-2	Microprocessor register failure
1-1-3	NVRAM read/write failure
1-1-4	ROM BIOS checksum failure
1-2-1	Programmable interval timer failure
1-2-2	DMA initialization failure
1-2-3	DMA page register read/write failure
1-3	Video Memory Test failure
1-3-1 through 2-4-4	Memory not being properly identified or used
3-1-1	Slave DMA register failure
3-1-2	Master DMA register failure
3-1-3	Master interrupt mask register failure
3-1-4	Slave interrupt mask register failure
3-2-2	Interrupt vector loading failure
3-2-4	Keyboard Controller Test failure
3-3-1	NVRAM power loss
3-3-2	Invalid NVRAM configuration
3-3-4	Video Memory Test failure
3-4-1	Screen initialization failure
3-4-2	Screen retrace failure
3-4-3	Search for video ROM failure

Code	Cause
4-2-1	No timer tick
4-2-2	Shutdown failure
4-2-3	Gate A20 failure
4-2-4	Unexpected interrupt in protected mode
4-3-1	Memory failure above address 0FFFFh
4-3-3	Timer-chip counter 2 failure
4-3-4	Time-of-day clock stopped
4-4-1	Serial or parallel port test failure
4-4-2	Failure to decompress code to shadowed memory
4-4-3	Math-coprocessor test failure
4-4-4	Cache test failure

Resolving Software and Hardware Incompatibilities

If a device is either not detected during the operating system setup or is detected but incorrectly configured, you can use the Hardware Troubleshooter to resolve the incompatibility.

To start the Hardware Troubleshooter:

Windows XP:

- 1 Click **Start**→ **Help and Support**.
- 2 Type `hardware troubleshooter` in the search field and press <Enter> to start the search.
- 3 In the **Fix a Problem** section, click **Hardware Troubleshooter**.
- 4 In the **Hardware Troubleshooter** list, select the option that best describes the problem and click **Next** to follow the remaining troubleshooting steps.

Windows Vista:

- 1 Click the Windows Vista start button , and click **Help and Support**.
- 2 Type `hardware troubleshooter` in the search field and press <Enter> to start the search.
- 3 In the search results, select the option that best describes the problem and follow the remaining troubleshooting steps.

Restoring Your Operating System

You can restore your operating system in the following ways:

- System Restore returns your computer to an earlier operating state without affecting data files. Use System Restore as the first solution for restoring your operating system and preserving data files.
- Dell PC Restore by Symantec (available in Windows XP) and Dell Factory Image Restore (available in Windows Vista) returns your hard drive to the operating state it was in when you purchased the computer. Both permanently delete all data on the hard drive and remove any programs installed after you received the computer. Use Dell PC Restore or Dell Factory Image Restore only if System Restore did not resolve your operating system problem.
- If you received an *Operating System* disc with your computer, you can use it to restore your operating system. However, using the *Operating System* disc also deletes all data on the hard drive. Use the disc *only* if System Restore did not resolve your operating system problem.

Using Microsoft Windows System Restore

The Windows operating systems provide a System Restore option which allows you to return your computer to an earlier operating state (without affecting data files) if changes to the hardware, software, or other system settings have left the computer in an undesirable operating state. Any changes that System Restore makes to your computer are completely reversible.



NOTICE: Make regular backups of your data files. System Restore does not monitor your data files or recover them.



NOTE: The procedures in this document were written for the Windows default view, so they may not apply if you set your Dell™ computer to the Windows Classic view.

Starting System Restore

Windows XP:

 **NOTICE:** Before you restore the computer to an earlier operating state, save and close any open files and exit any open programs. Do not alter, open, or delete any files or programs until the system restoration is complete.

- 1 Click **Start**→ **All Programs**→ **Accessories**→ **System Tools**→ **System Restore**.
- 2 Click either **Restore my computer to an earlier time** or **Create a restore point**.
- 3 Click **Next** and follow the remaining on-screen prompts.

Windows Vista:

- 1 Click **Start** .
- 2 In the Start Search box, type **System Restore** and press <Enter>.



NOTE: The **User Account Control** window may appear. If you are an administrator on the computer, click **Continue**; otherwise, contact your administrator to continue the desired action.

- 3 Click **Next** and follow the remaining prompts on the screen.

In the event that System Restore did not resolve the issue, you may undo the last system restore.

Undoing the Last System Restore

 **NOTICE:** Before you undo the last system restore, save and close all open files and exit any open programs. Do not alter, open, or delete any files or programs until the system restoration is complete.

Windows XP:

- 1 Click **Start**→ **All Programs**→ **Accessories**→ **System Tools**→ **System Restore**.
- 2 Click **Undo my last restoration** and click **Next**.

Windows Vista:

- 1 Click **Start** .
- 2 In the Start Search box, type **System Restore** and press <Enter>.
- 3 Click **Undo my last restoration** and click **Next**.

Enabling System Restore



NOTE: Windows Vista does not disable System Restore; regardless of low disk space. Therefore, the steps below apply only to Windows XP.

If you reinstall Windows XP with less than 200 MB of free hard-disk space available, System Restore is automatically disabled.

To see if System Restore is enabled:

- 1 Click **Start**→ **Control Panel**→ **Performance and Maintenance**→ **System**.
- 2 Click the **System Restore** tab and ensure that **Turn off System Restore** is unchecked.

Using Dell™ PC Restore and Dell Factory Image Restore



NOTICE: Using Dell PC Restore or Dell Factory Image Restore permanently deletes all data on the hard drive and removes any programs or drivers installed after you received your computer. If possible, back up the data before using these options. Use PC Restore or Dell Factory Image Restore only if System Restore did not resolve your operating system problem.



NOTE: Dell PC Restore by Symantec and Dell Factory Image Restore may not be available in certain countries or on certain computers.

Use Dell PC Restore (Windows XP) or Dell Factory Image Restore (Windows Vista) only as the last method to restore your operating system. These options restore your hard drive to the operating state it was in when you purchased the computer. Any programs or files added since you received your computer—including data files—are permanently deleted from the hard drive. Data files include documents, spreadsheets, e-mail messages, digital photos, music files, and so on. If possible, back up all data before using PC Restore or Factory Image Restore.

Windows XP: Dell PC Restore

Using PC Restore:

- 1 Turn on the computer.

During the boot process, a blue bar with www.dell.com appears at the top of the screen.

- 2 Immediately upon seeing the blue bar, press <Ctrl><F11>.

If you do not press <Ctrl><F11> in time, let the computer finish starting, and then restart the computer again.



NOTICE: If you do not want to proceed with PC Restore, click **Reboot**.

- 3 Click **Restore** and click **Confirm**.

The restore process takes approximately 6 to 10 minutes to complete.

- 4 When prompted, click **Finish** to reboot the computer.



NOTE: Do not manually shut down the computer. Click **Finish** and let the computer completely reboot.

- 5 When prompted, click **Yes**.

The computer restarts. Because the computer is restored to its original operating state, the screens that appear, such as the End User License Agreement, are the same ones that appeared the first time the computer was turned on.

- 6 Click **Next**.

The **System Restore** screen appears and the computer restarts.

- 7 After the computer restarts, click **OK**.

Removing PC Restore:



NOTICE: Removing Dell PC Restore from the hard drive permanently deletes the PC Restore utility from your computer. After you have removed Dell PC Restore, you will not be able to use it to restore your computer operating system.

Dell PC Restore enables you to restore your hard drive to the operating state it was in when you purchased your computer. It is recommended that you *do not* remove PC Restore from your computer, even to gain additional hard drive space. If you remove PC Restore from the hard drive, you cannot ever recall it, and you will never be able to use PC Restore to return your computer operating system to its original state.

- 1 Log on to the computer as a local administrator.
- 2 In Microsoft Windows Explorer, go to `c:\dell\utilities\DSR`.

3 Double-click the filename **DSRIRRemv2.exe**.



NOTE: If you do not log on as a local administrator, a message appears stating that you that you must log on as administrator. Click **Quit**, and then log on as a local administrator.



NOTE: If the partition for PC Restore does not exist on your computer hard drive, a message appears stating that the partition was not found. Click **Quit**; there is no partition to delete.

4 Click **OK** to remove the PC Restore partition on the hard drive.

5 Click **Yes** when a confirmation message appears.

The PC Restore partition is deleted and the newly available disk space is added to the free space allocation on the hard drive.

6 Right-click **Local Disk (C)** in Windows Explorer, click **Properties**, and verify that the additional disk space is available as indicated by the increased value for **Free Space**.

7 Click **Finish** to close the **PC Restore Removal** window and restart the computer.

Windows Vista: Dell Factory Image Restore

1 Turn on the computer. When the Dell logo appears, press <F8> several times to access the Vista Advanced Boot Options Window.

2 Select **Repair Your Computer**.

The System Recovery Options window appears.

3 Select a keyboard layout and click **Next**.

4 To access the recovery options, log on as a local user. To access the command prompt, type **administrator** in the User name field, then click **OK**.

5 Click **Dell Factory Image Restore**.



NOTE: Depending upon your configuration, you may need to select **Dell Factory Tools**, then **Dell Factory Image Restore**.

The Dell Factory Image Restore welcome screen appears.

6 Click **Next**.

The Confirm Data Deletion screen appears.

➔ **NOTICE:** If you do not want to proceed with **Factory Image Restore**, click **Cancel**.

7 Click the checkbox to confirm that you want to continue reformatting the hard drive and restoring the system software to the factory condition, then click **Next**.

The restore process begins and may take five or more minutes to complete. A message appears when the operating system and factory-installed applications have been restored to factory condition.

8 Click **Finish** to reboot the system.

Using the Drivers and Utilities Media

➔ **NOTICE:** The *Drivers and Utilities* media may contain drivers for operating systems that are not on your computer. Ensure that you are installing software appropriate for your operating system.

Many drivers, such as the keyboard driver, come with your Microsoft Windows operating system. You may need to install drivers if you:

- Upgrade your operating system.
- Reinstall your operating system.
- Connect or install a new device.

Identifying Drivers

If you experience a problem with any device, identify whether the driver is the source of your problem and, if necessary, update the driver.

Microsoft® Windows® XP

- 1 Click **Start** → **Control Panel**.
- 2 Under **Pick a Category**, click **Performance and Maintenance**, and click **System**.
- 3 In the **System Properties** window, click the **Hardware** tab, and click **Device Manager**.

Microsoft Windows Vista™

- 1 Click the Windows Vista start button , and right-click **Computer**.
- 2 Click **Properties**→ **Device Manager**.



NOTE: The **User Account Control** window may appear. If you are an administrator on the computer, click **Continue**; otherwise, contact your administrator to continue.

Scroll down the list to see if any device has an exclamation point (a yellow circle with a [!]) on the device icon.

If an exclamation point is next to the device name, you may need to reinstall the driver or install a new driver (see "Reinstalling Drivers and Utilities" on page 79).

Reinstalling Drivers and Utilities



NOTICE: The Dell Support website at support.dell.com and your *Drivers and Utilities* media provide approved drivers for Dell™ computers. If you install drivers obtained from other sources, your computer might not work correctly.

Using Windows Device Driver Rollback

If a problem occurs on your computer after you install or update a driver, use Windows Device Driver Rollback to replace the driver with the previously installed version.

Windows XP:

- 1 Click **Start**→ **My Computer**→ **Properties**→ **Hardware**→ **Device Manager**.
- 2 Right-click the device for which the new driver was installed and click **Properties**.
- 3 Click the **Drivers** tab→ **Roll Back Driver**.

Windows Vista:

- 1 Click the Windows Vista start button , and right-click **Computer**.
- 2 Click **Properties**→ **Device Manager**.



NOTE: The **User Account Control** window may appear. If you are an administrator on the computer, click **Continue**; otherwise, contact your administrator to enter the Device Manager.

- 3 Right-click the device for which the new driver was installed and click **Properties**.
- 4 Click the **Drivers** tab→ **Roll Back Driver**.

If Device Driver Rollback does not resolve the problem, then use System Restore (see "Restoring Your Operating System" on page 73) to return your computer to the operating state that existed before you installed the new driver.

Manually Reinstalling Drivers

After extracting the driver files to your hard drive as described in the previous section:

Windows XP:

- 1 Click **Start**→ **My Computer**→ **Properties**→ **Hardware**→ **Device Manager**.
- 2 Double-click the type of device for which you are installing the driver (for example, **Audio** or **Video**).
- 3 Double-click the name of the device for which you are installing the driver.
- 4 Click the **Driver** tab→ **Update Driver**.
- 5 Click **Install from a list or specific location (Advanced)**→ **Next**.
- 6 Click **Browse** and browse to the location to which you previously copied the driver files.
- 7 When the name of the appropriate driver appears, click **Next**.
- 8 Click **Finish** and restart your computer.

Windows Vista:

- 1 Click the Windows Vista start button , and right-click **Computer**.
- 2 Click **Properties**→ **Device Manager**.



NOTE: The **User Account Control** window may appear. If you are an administrator on the computer, click **Continue**; otherwise, contact your administrator to enter the Device Manager.

- 3 Double-click the type of device for which you are installing the driver (for example, **Audio** or **Video**).
- 4 Double-click the name of the device for which you are installing the driver.

- 5** Click the **Driver** tab→ **Update Driver**→ **Browse my computer for driver software**.
- 6** Click **Browse** and browse to the location to which you previously copied the driver files.
- 7** When the name of the appropriate driver appears, click the name of the driver→ **OK**→ **Next**.
- 8** Click **Finish** and restart your computer.