

Kit 1370

VOLVO V70, 5-dr Estate, 04-07

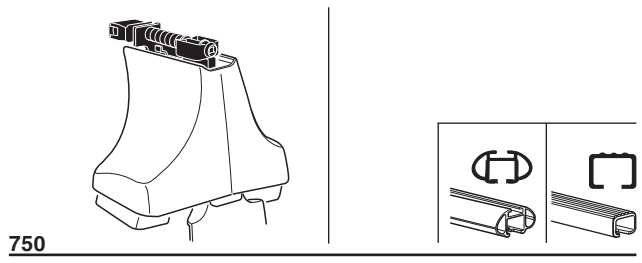
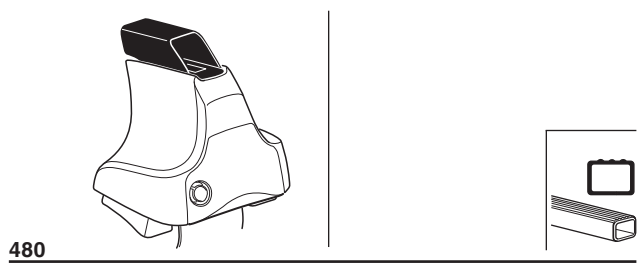
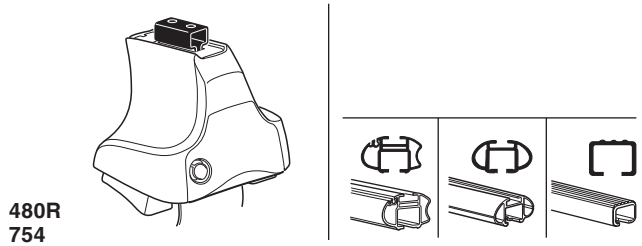

x2 x2 x2 x4	x2	x2 x2 x4 x4	x2 x2	x2

← **696** x 2

← **698** x 2

← **188** x 4

x 1

Kit

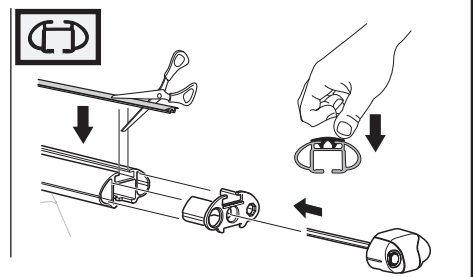
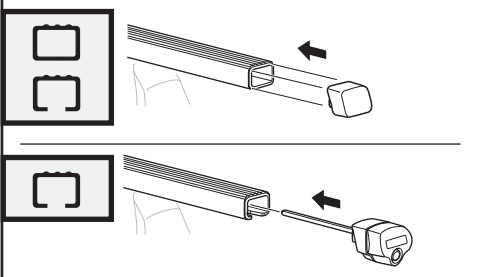
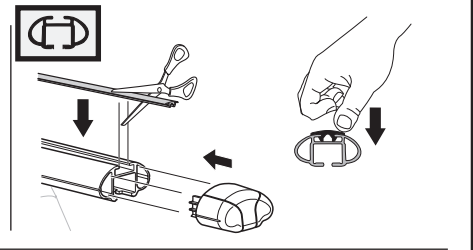
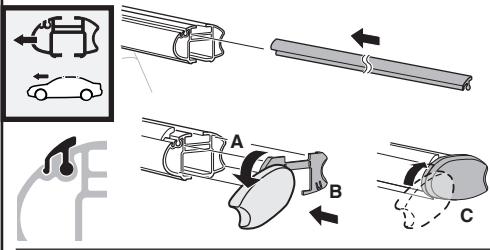
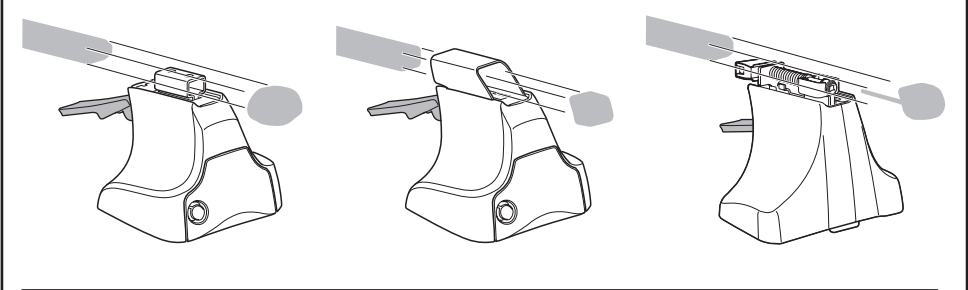
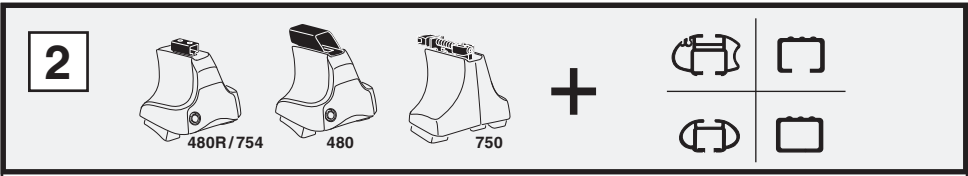
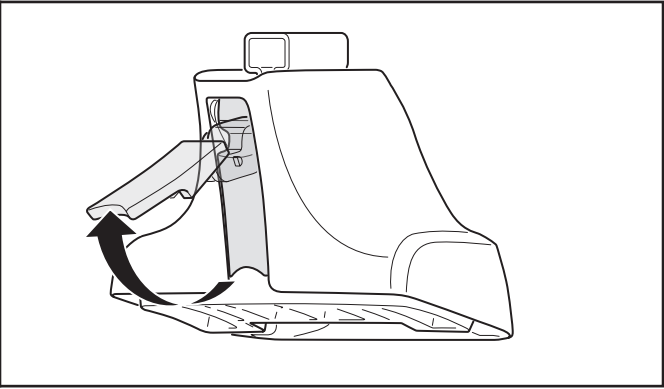
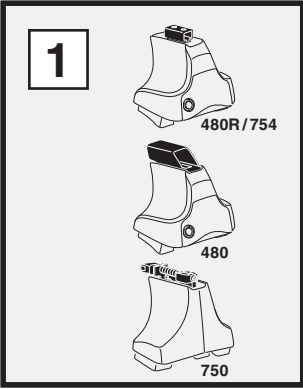

3

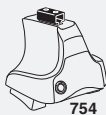

754

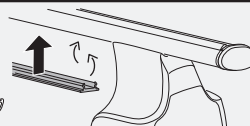
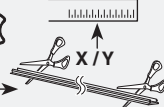

750



1

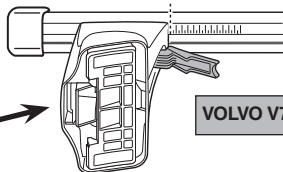
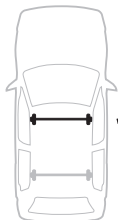

2

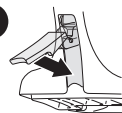

VOLVO V70, 5-dr Estate, 04-07

X

38

1

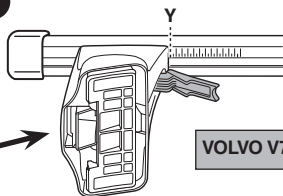

2

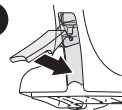

VOLVO V70, 5-dr Estate, 04-07

Y

35.5



480R

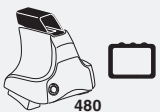

480

1

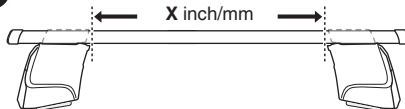

2

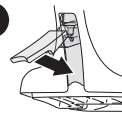

VOLVO V70, 5-dr Estate, 04-07

X inch

X mm

40 5/8"

1031 mm

1

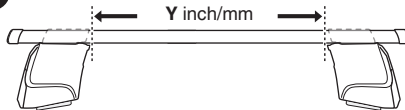

2

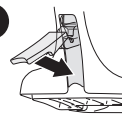

VOLVO V70, 5-dr Estate, 04-07

Y inch

Y mm

39 5/8"

1006 mm

4

VOLVO V70, 5-dr Estate, 04-07

188



696



FL



188



696



FR



188



698



RL



188



698



RR

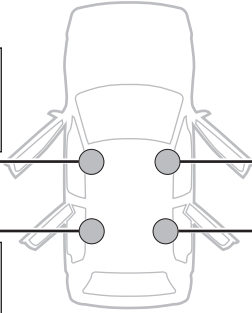

480R/754



480

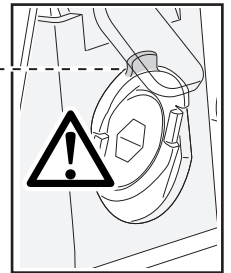
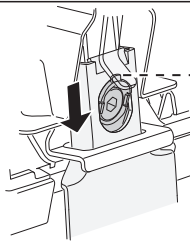
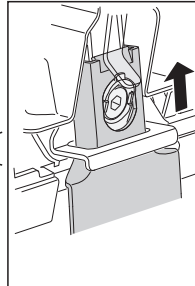
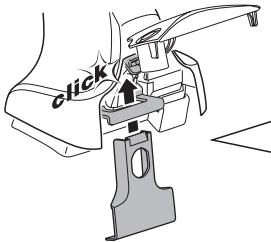
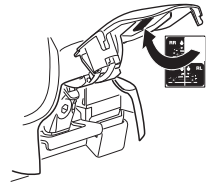
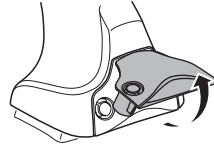
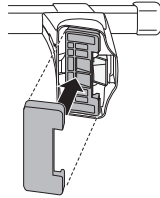

750

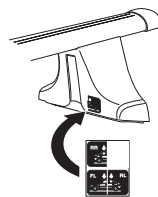
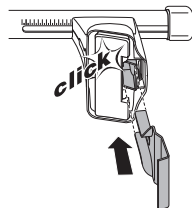
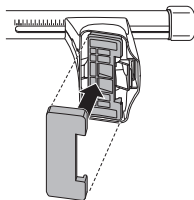

5

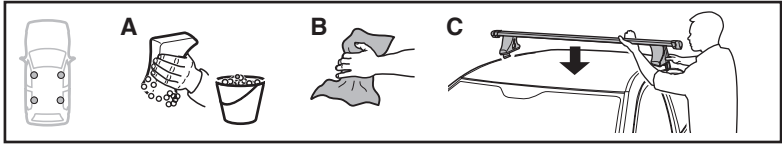

	X mm	Y mm	X inch	Y inch
VOLVO V70, 5-dr Estate, 04-07	355 mm	810 mm	14 "	31 7/8 "

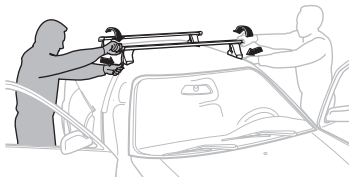
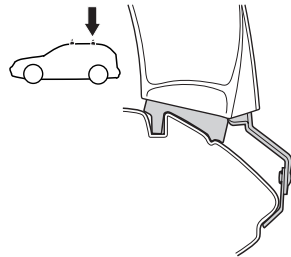
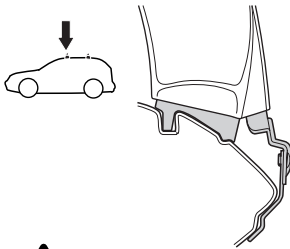
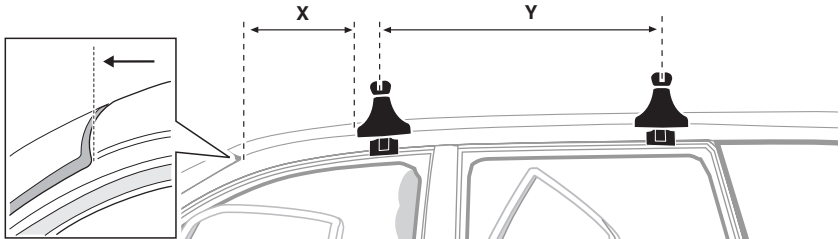

GB/US Tighten alternately

D Die Schrauben abwechselnd anziehen

F Serrer alternativement chaque côté

NL Afwisselend aan de linker- en de rechterkant aandraaien

I Alternare il serraggio delle viti

E Serrare alternativamente

PT Aperte alternadamente

S Dra åt växelvis

FIN Kierrä vuorotellen

EST Pinguldage vaheldumisi

LAT Pielieciet pamišus

LIT Užsukinėkite pakaitomis

PL Śruby dokręcaj naprzemiennie

RU Затягивайте попеременно

CZ Pokręťta bagażníka dokręcaj dokręcaj naprzemiennie.

SK Doťahujte striedavo

SLO Privijajte izmenično.

HR Naizmjenično zategnite

HU Egymástól függetlenül szorítandó

GR Σφιγγετε εναλλάξ

TR Dönüşümlü sıkın

中文 交替拧紧

한국어 번갈아 가며 조이십시오.

日本語 交互に締め付けてください。

ไทย ชันโนแบบสลับ

6



480R/754



480

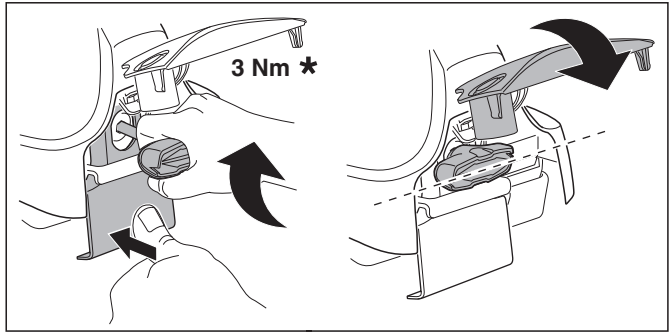
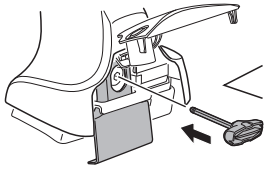

3 Nm *

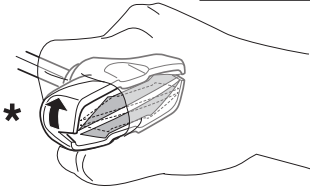

*

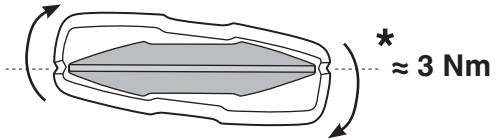

* ≈ 3 Nm



750

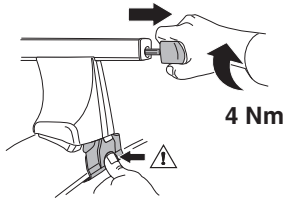

4 Nm

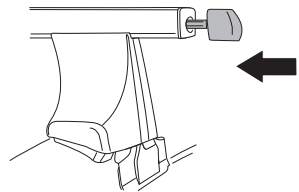

i



1



2

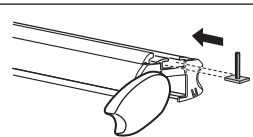

i

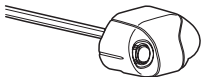

1

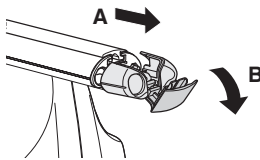

2

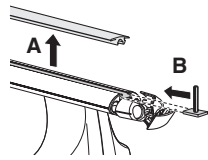

i



1

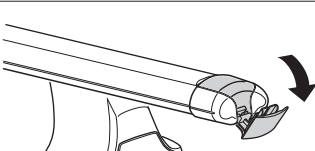

2

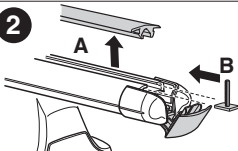

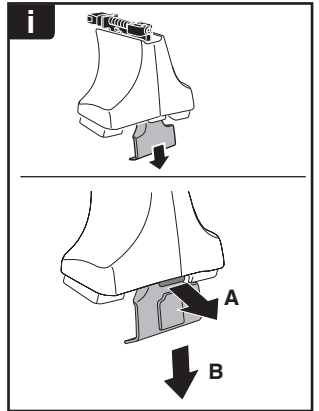

THULE
SWEDEN
**ONE
KEY
SYSTEM**



- 544 (x4)
- 596 (x6)
- 588 (x8)
- NA 510 (x10)
- EUR 452 (x12)
- ASIA



WW ▶ Thule Sweden AB, Box 69, 330 33 Hillerstorp, SWEDEN
NA ▶ Thule Inc., 42 Silvermine Road, Seymour, Connecticut 06483, USA

info@thule.com
customer.service@thule.com

www.thule.com