

Contents

1. Introduction	4
2. Terminology	4
3. Function	5
3.1. Fire alarm lines:	5
3.2. Current thresholds for:	5
3.3. Controllable output for fire condition:	5
3.4. Relay output for fire condition:	5
3.5. Relay output for fault condition:	5
3.6. Performance:	5
3.7. Indications of registered events:	6
3.8. Power supply	6
3.8.1. Mains:	6
3.8.2. Backup batteries:.....	6
3.8.3. Consumption on backup batteries supply:.....	6
3.9. Power supply to external devices:	6
3.10. Fuses:	6
3.11. Dimensions	6
3.12. Weight, backup batteries not included	6
4. Contents of delivery:	6
5. General information	7
5.1. Access levels	7
5.1.1. Access level 1.....	7
5.1.2. Access level 2 and 3.....	7
5.1.3. Access level 4.....	7
5.2. Indications and buttons for control	7
5.3. Conditions of the fire control panel	9
6. Duty mode	9
6.1. Description	9
6.2. LED and sound indication	9
7. Fire condition	9
7.1. Description	9
7.2. LED and sound indication	9
7.3. Using the buttons	10
7.3.1. Button (Alarm).....	10
7.3.2. Button (Outputs)	10
7.3.3. Button (Reset of line).....	10
8. Fault condition	10
8.1. Description	10

8.2. LED and sound indication	11
8.3. Using the buttons	11
9. <i>Disabled component mode</i>	11
9.1. Description	11
9.2. To disable a line:.....	11
9.3. To enable a line:.....	12
9.4. To disable outputs in Fire condition:.....	12
9.5. To enable outputs in Fire condition:.....	12
10. <i>Test condition</i>	12
10.1. Description	12
10.2. Setting a line in Test condition	12
10.3. Removing the Test condition	12
11. <i>Delay of outputs</i>	12
11.1. Description	12
11.2. Setting a time value for delay of outputs	13
11.3. Disabling time delay of outputs	13
12. <i>Installation and initial start of the fire control panel</i>	13
12.1. To mount the fire control panel :	13
12.2. Periphery devices assembly	13
12.2.1. Mounting periphery devices to controllable outputs	13
12.2.2. Mounting periphery devices to relay outputs	13
12.3. Connecting fire detectors	14
12.4. Connection to power supply	15
13. <i>Fire control panel start up</i>	15
14. <i>Conditions of operation, storage and transportation</i>	15
14.1. Operation and storage.....	15
14.1.1. Temperature:	15
14.1.2. Relative humidity:	15
14.2. Transportation.....	15
15. <i>Warranty</i>	15
<i>Appendixes</i>	15
<i>Appendixes</i>	16

1. Introduction

Fire control panel FS4000 is an up-to-date, highly reliable, multifunctional and versatile unit. It is designed to receive signals from manual call points and automatic fire detectors, releasing sound and light indication. The fire control panel provides options for connection of external signal and executive units.

2. Terminology

DELAY OF OUTPUTS – delay of activation of controllable and relay outputs with a certain period of time from the moment a fire condition is registered. Typically, the delay period is sufficient for the staff to inspect the premises indicated by the fire control panel. The delay is eliminated through activation of a manual call point (response current $\geq 40\text{mA}$ at 24V) or by a fire condition in another line. The delay time is user programmable and is equal for all fire alarm lines.

DISABLED LINE – a switched off *line*, without power supply, not controlled for activated fire detectors and fault condition. This condition is user defined. The indication for a disabled line includes common light indication and separate light indication for each line.

DISABLED OUTPUTS – *the controllable output* and *the relay output* are switched off (executing devices can not be activated) and are not monitored for a fault condition. This feature is user defined. The indication for a disabled controllable output includes common light indication and separate light indication for the controllable output.

GROUNDS – non-system *non-fatal fault condition*, due to leakage to a grounded wire.

CONTROLLABLE OUTPUT – potential output that monitors the serviceability of the connection wires between the fire control panel and the executing device.

SHORT CIRCUIT IN A LINE OR IN A CONTROLLABLE OUTPUT – non-system *non-fatal fault condition* due to registered current value in a *line* or in a *controllable output* that exceeds a specified threshold value.

LINE IN TEST – a *line* set by the user to Test condition. The line is powered and reset (the power is cut off for 3 s) periodically every 64 s. The events registered in a line in Test condition are not saved in the archive and do not trigger associated outputs nor light and sound signalling. The indication for a line in Test condition is common light indication and separate light indication for each line.

LOCAL SOUNDER - sounder built-in the fire control panel

NON-FATAL FAULT CONDITION – fault condition that allows the fire control panel to continue operation. A non-fatal fault condition is usually a *non-system* fault condition. The indication is common light indication, local sound indication and text messages on the LCD display.

ACCESS LEVEL – access level to various indications and control functions. (see section 5.1).

LOW BATTERY – non-system *fatal fault condition* due to full discharge of the backup batteries upon interrupted power supply.

SUPRESSED OUTPUT – *controllable* or *relay* output which should normally be activated upon Fire condition, but is manually switched off by the user.

FIRE ALARM LINE (further on it will be referred as **LINE**) – a combination of automatic fire detectors and manual call points, physically connected by the means of two-wire connection. The basic configuration of FS 4000 includes 2 lines; the maximum configuration includes 8 lines. Up to 32 fire detectors can be integrated into one line.

FIRE CONDITION – Fire condition phase entered by the control panel upon activation of automatic fire detector or manual call point. Common light indication and separate light indication for each line, local light indicators and local sound signaling indicate the phase.

INTERRUPTED LINE OR CONTROLLABLE OUTPUT – non-system *non-fatal fault condition* due to current value in a *line* or in a *controllable output* lower than the threshold value.

RELAY OUTPUT – relay, potential-free, switching outputs that control external executive devices.

SYSTEM FAULT – fault condition due to a fault in a basic component of the fire control panel (or the system). The System fault may be a *fatal error* or a *non-fatal error*. The event is indicated by common light indicators and local sound signaling.

REMOVED FIRE DETECTOR – non-system *non-fatal fault condition* due to removed fire detector in a *line*.

3. Function

Fire control panel FS4000 is designed to operate with conventional automatic fire detectors and manual call points. The panel has outputs provided for external executive devices.

The unit is produced in four versions:

- | | |
|----------------------|------------|
| ◆ 2 fire alarm lines | - FS4000/2 |
| ◆ 4 fire alarm lines | - FS4000/4 |
| ◆ 6 fire alarm lines | - FS4000/6 |
| ◆ 8 fire alarm lines | - FS4000/8 |

Technical features

3.1. Fire alarm lines:

- | | |
|--|------------|
| – Maximum number of fire detectors in a line | - 32 |
| – Connecting line | - two-wire |
| – Maximum resistance of a line | - 100Ω |

3.2. Current thresholds for:

- | | |
|-----------|-------------------|
| ◆ 0÷3mA | - Fault condition |
| ◆ 3÷12mA | - Duty mode |
| ◆ 12÷80mA | - Fire condition |
| ◆ >80mA | - Short circuit |

3.3. Controllable output for fire condition:

- | | |
|------------------------------|--------------------|
| – Type | - potential, relay |
| – Electrical characteristics | - (19÷24)V/450mA |

3.4. Relay output for fire condition:

- | | |
|------------------------------|-----------------------------|
| – Type | - potential-free, switching |
| – Electrical characteristics | - 3A/125VAC; 3A/30VDC |

3.5. Relay output for fault condition:

- | | |
|------------------------------|-----------------------------|
| – Type | - potential-free, switching |
| – Electrical characteristics | - 3A/125VAC; 3A/30VDC |

3.6. Performance:

- Control over fire alarm lines and controllable output for fault conditions (short circuit and interruption) and automatic reset
- Detection of removed fire detector and automatic reset;
- Identification of manual call points;
- LED indication for alarm state and emergency;

- Delay of outputs for fire condition with time period of 1,2,3,4 or 5 minutes after fire condition is registered;
- Built-in sounder for fire condition – one tonal, continuous, can be switched off;
- Built-in sounder for fault condition – one tonal, discontinuous, can be switched off;
- Test mode for fire alarm lines;
- Disabling fire alarm lines;
- Disabling outputs for fire condition.

3.7. Indications of registered events:

- Light indication - LED
- Sound - built-in sounder

3.8. Power supply

3.8.1. Mains:

- voltage - (100÷240)V
- frequency - 50/60Hz

3.8.2. Backup batteries:

- battery type - lead, gel electrolyte
- number of batteries - 1 pc
- nominal voltage of the backup battery - 12V
- nominal capacity C_{20} - (3 or 7)Ah
- charge voltage - 14,2V
- Operation in Duty mode upon interruption in main power supply

	12V / 7Ah	12V / 3Ah
◆ 2 lines	80h	32h
◆ 4 lines	72h	30h
◆ 6 lines	60h	25h
◆ 8 lines	54h	22h

3.8.3. Consumption on backup batteries supply:

- Configuration of 2 lines - < 80mA at 12V
- Configuration of 4 lines - < 95mA at 12V
- Configuration of 6 lines - < 110mA at 12V
- Configuration of 8 lines - < 125mA at 12V

3.9. Power supply to external devices:

- voltage - (19÷24)V
- maximum current value (including current of controllable output) - 0,45A

3.10. Fuses:

- Main supply 230V - 4.0A
- Backup battery - 4.0A
- Power supply to external devices - 0,9A automatic
- Controllable output - 0,65A automatic

3.11. Dimensions

- 313x218x85mm

3.12. Weight, backup batteries not included

- 2,5kg

4. Contents of delivery:

- Fire control panel FS4000 - 1 pc
- End of line module "EOL"
 - ◆ for 2 lines - 2 pcs
 - ◆ for 4 lines - 4 pcs
 - ◆ for 6 lines - 6 pcs
 - ◆ for 8 lines - 8 pcs

- Resistor 5,6kΩ/ 0,25W - 1 pc
- Fuse 4A - 2 pcs
- Instruction manual - 1 pc
- Instruction for the authorized staff - 1 pc
- Packing - 1 pc

5. General information

5.1. Access levels

There are 4 levels of access to the variable indications and control functions of FS4000

5.1.1. Access level 1

All persons who would presumably find out and react to alarm for fault condition or fire condition have access to level 1. All light indicators are visible here.

5.1.2. Access level 2 and 3

For the personnel in charge for the fire protection; they shall be trained and authorized to operate the fire control panel in the following conditions:

- Duty Mode;
- Fire condition;
- Fault condition;
- Disabled component;
- Test.

To enter Access level 2 and 3 unlock and open the front cover of the control panel.

The following features are accessible:

- exit of fire condition (see section **Error! Reference source not found.**);
- suppressing the outputs activated upon fire condition;
- suppressing the local sounder;
- connection of fire alarm lines and executive devices;
- replacing a burnt fuse;
- disabling a line;
- disabling outputs for fire condition;
- setting a line in test mode.







5.1.3. Access level 4

Accessible for personnel trained and authorized by the Producer to repair the fire control panel and to modify the software. Special means are required for access to this level.

5.2. Indications and buttons for control

Table 1 gives detailed description of the indications for each status, Table 2 presents the basic means for control. In Appendix 1 is displayed the front panel of the control panel with indications and buttons for control.

Table 1

Conditions of the fire control panel	Indication
All conditions - The fire control panel is power supplied	 Indicator <i>Power supply</i> – continuous green light
All conditions	 Indicator <i>Delay of outputs</i> - continuous yellow light
Fire condition	 Common indicator <i>Fire condition</i> – flashing red light
Fire condition and Fault condition - Sound signaling is suppressed	 Indicator <i>Stop Alarm</i> - continuous red light
Fire condition- Outputs for fire condition are disabled	 Indicator <i>Disabled outputs</i> - continuous red light
Fault condition - all types of faults	 Common indicator <i>Fault condition</i> - flashing yellow light
Fault condition – System fault	 Indicator <i>System fault</i> – continuous yellow light











Conditions of the fire control panel	Indication
Fault condition - Fault in mains supply	 Indicator <i>Fault in mains supply</i> - continuous yellow light
Fault condition - Fault in the backup batteries or in the charger	 Indicator <i>Backup battery fault</i> - continuous yellow light
Fault condition- Fault in internal power supply units, voltage for supply of lines and/or user voltage 24V	 Indicator <i>Backup battery fault</i> - continuous yellow light
Fault condition - Fault in a controllable output	 Indicator <i>Out of order/Disabled controllable output</i> – flashing yellow light
Fault condition – Grounds Leakage to earthen wire or earthen case	 Indicator <i>Fault in grounds</i> – continuous yellow light
Disabled component - Disabled line or controllable output	 Indicator <i>Disabled component</i> - continuous yellow light
Test condition	 Indicator <i>Test</i> – continuous yellow light
Fire condition	Local sounder – continuous signal
Fault condition - All faults except for Low battery	Local sounder – discontinuous signal: 1s sound 1s break
Fault condition - Low battery	Local sounder – discontinuous signal: 1s sound 3s break

Table 2

Means of control	Condition of the fire control panel	Access level	Operation
Button <i>Reset of line</i> 	Fire condition	Level 2	Exit of Fire condition
Button <i>Outputs</i> 	Fire condition	Level 2	- if outputs for fire condition are activated – to suppress the outputs; - if outputs for fire condition are not activated – to force activation
Button <i>Alarm</i> 	Fire condition and Fault condition	Level 2	To suppress /activate the local sounder

5.3. Conditions of the fire control panel

Fire control panel FS4000 monitors the fire alarm lines by consecutively scanning their condition. Depending on the current value, the line can be in normal condition, in fire condition or in a fault condition (short circuit or break). Simultaneously, a constant control for removed fire detectors is being carried out, provided that the fire alarm installation is designed and completed as shown on the diagram of section 12.3. Control over the controllable outputs of fault condition (short circuit or break) is being carried out as well.



The fire control panel FS4000 operates in five basic modes: Duty Mode, Fire Condition, Fault Condition, Disabled Component Mode and Test Mode.

6. Duty mode

6.1. Description

The fire control panel is in Duty Mode, when it is not in Fire condition or in Fault condition.

6.2. LED and sound indication

In Duty mode are active only the green LED indicator  (Power supply) and the yellow indicator  if a short circuit is set for the outputs. The local sounder is off.

7. Fire condition

7.1. Description



The fire control panel enters Fire condition after a fire detector is activated in one of the fire alarm lines.

The fire control panel can be in Fire condition in one or more lines.

To exit Fire condition, press button  at Access level 2 (see section 7.3.3).

7.2. LED and sound indication

In this condition the common light indicator  and the local indicators for fire condition in all lines that received alarm signal flash in red.

If the outputs for fire condition are suppressed by button , the LED indicator on the button will illuminate in continuous red light .

The local sounder produces continuous signal.

If the sound indication is suppressed by button  (Alarm), the LED indicator illuminates in continuous red light .

7.3. Using the buttons

7.3.1. Button (Alarm)

Press the button to:

- Switch off the local sounder if it is activated due to Fire condition or Fault condition;
- Activate the local sounder if the fire control panel is in Fire condition or Fault condition and the local sounder is previously deactivated by the same button.

The LED indicator  is illuminated if the local sounder is switched off for Fire condition or Fault condition.

The button does not affect and is not cancelled by the following events:

- Fire condition in new line ;
- New Fault condition will activate the local sounder.

Access to the button is allowed at Access level 2.

7.3.2. Button (Outputs)

The button operation depends on the current access level and on the status of the fire control panel.

Where lines in Fire condition are available, press the button to:

- In case of suppressed outputs for fire condition – to force activation of the outputs;
- In case of activated outputs for fire condition – to suppress the outputs.

The LED indicator  illuminates if outputs for fire condition are suppressed.

7.3.3. Button (Reset of line)

Press it to force the control panel to exit Fire condition and to reset the lines (cuts off the power supply for 3 seconds).

Access to the button is allowed at Access level 2.

8. Fault condition

8.1. Description

The fire control panel enters Fault Condition when any of the events below has been registered:

- System fault;
- Battery Low – backup batteries discharged due to interruption in mains supply;
- Fault in a line – removed fire detector, short circuit or break;
- Fault in a controllable output – short circuit or break;
- Fault in main supply;
- Fault in backup batteries power supply;
- Short circuit or leakage to ground wire;
- Fault in power supply to lines;
- Fault in power supply to external devices.

In System fault the main processor is not able to continue operation.

You can exit the fault condition only if you disconnect the control panel from the mains supply and send it for repairs.







All other faults are not fatal and switch off some of the periphery devices only. The fire control panel exits the status automatically 8 s after the fault condition is eliminated.



In Fault condition terminals C and CN of relay output REL Fault are connected; when no fault condition is registered, terminals C and NO of the same output are connected.

8.2. LED and sound indication

In *Low Battery* no LED indicator is illuminated. The local sounder produces discontinuous sound (1 s sound, 3 s pause). The backlight of the LCD is off.

In all other fault conditions the indicator  (Fault condition) flashes in yellow. Depending on the type of the fault condition the following indicators are illuminated:

- System fault - indicator  (System fault) is illuminated in yellow light;
- Fault in fire alarm line – separate indicator for fault condition flashes in yellow to indicate:
 - ♦ Short circuit - 1Hz frequency /slow flashing light/;
 - ♦ Break in a line - 4Hz frequency /quick flashing light/;
 - ♦ Removed fire detector - 4Hz frequency, 1 second pause /interrupted, quick flashing light/.
- Fault condition in controllable output - indicator  (Out of order / Disabled controllable output) flashes in yellow light;
- Fault in mains supply - indicator  (Fault in mains supply) is illuminated in yellow light;
- Fault in backup batteries - indicator  (Backup battery fault) is illuminated in yellow light;
- Fault in power supply to external devices - indicator  (Fault in internal power supply) is illuminated in yellow light;
- Short circuit or leakage to ground wire - indicator  (Fault in grounds) is illuminated in yellow light.

The local sounder is activated and produces discontinuous signal. If the sound indication has been suppressed by button  (Alarm), the LED indicator  is illuminated in continuous red light.

8.3. Using the buttons

No buttons are active in System fault.

In all other fault conditions button  (Alarm) is active only. Press the button to:

- Switch off the local sounder if it responded for Fire condition or Fault condition;
- Activate the local sounder if the Fire control panel is in Fire condition or Fault condition and the local sounder is previously suppressed by the same button.

The LED indicator  is illuminated, if the local sounder is switched off for Fire condition or Fault condition.

The button does not affect nor is its action cancelled by the following events:

- When new line enters Fire condition, the local sounder will be activated;
- When new fault condition is registered, the local sounder will be activated.

Access to the button is allowed at Access level 2.

9. Disabled component mode

9.1. Description

The fire control panel enters Disabled component mode after a component has been manually disabled – a fire alarm line or a controllable output. The condition is set through jumpers, for each line separately, and also for outputs for fire condition – controllable and relay outputs.

The disabled line is switched off (the power supply is cut off) and is not monitored for activated fire detector and faults. The disabled outputs are switched off (the executive device can not operate) and the controllable output is not monitored for faults.

9.2. To disable a line:



- fix J2 jumper of the line on position “DIS”;

- the separate LED for the line shall illuminate in continuous yellow light and the common indicator  (Disabled component) shall illuminate too, if not activated due to other disabled component.



9.3. To enable a line:

- move the J2 jumper of the line from position “DIS” to position “Normal”;
- the separate LED for the line shall extinguish, as well as the common indicator  (Disabled component) provided that no other components are disabled.

9.4. To disable outputs in Fire condition:

- fix J3 jumper on position “DIS”;
- indicator  (Out of order/disabled component) shall illuminate in continuous yellow light, as well as the common indicator  (Disabled component) if not activated due to other disabled component.

9.5. To enable outputs in Fire condition:

- move the J3 jumper from position “DIS” to position “Normal”;
- indicator  (Out of order/disabled component) shall extinguish, as well as the common indicator  (Disabled component) provided that no other components are disabled.

For Disabled component mode no sound indication is supported.

10. Test condition

10.1. Description

The fire control panel enters Test Mode after a fire alarm line has been manually set to operate in test condition. The Test condition shall be set, using jumpers, for each line separately.

When a fire alarm line is in test condition, the following operational changes are in effect:

- upon registration of Fire condition in this line the sound indications, light indications, associated outputs do not operate;
- upon registration of Fault in a line the sound indicators, light indicators and the relay output for fault condition do not operate;
- the line is being automatically reset (the power supply is interrupted for 3 s) every 64s.

10.2. Setting a line in Test condition

- fix J2 jumper of the line on position “TEST”.
- both separate LEDs for the line (red and yellow) shall start flashing with 1 Hz frequency as well as the common indicator  (Test), if not activated by another line, set to Test condition.

10.3. Removing the Test condition

- move the J2 jumper of the line from position “TEST” to position “Normal”.
- both separate LEDs for the line shall extinguish, as well as the common indicator  (Test) provided that no other lines are in Test condition.

11. Delay of outputs

11.1. Description

The fire control panel will register the delay time for the outputs after a time value is manually set. The time delay is set through a jumper and can be 1,2,3,4 or 5 minutes. At "0" position time delay will be eliminated.

11.2. Setting a time value for delay of outputs

- fix J1 jumper on desired time value for delay.
- indicator  (Delay of outputs) shall illuminate in continuous yellow light;

11.3. Disabling time delay of outputs

- fix J1 jumper on position "0".
- indicator  (Delay of outputs) shall extinguish.

12. Installation and initial start of the fire control panel

12.1. To mount the fire control panel :

- unpack the unit;
- open the unit after unlocking it with the key;
- put the dowels on the determined places;
- fasten the control panel to the dowels through the three holes provided on the chassis.

It is recommended to avoid installation of the control panel near sources of heat (radiators, conditioning systems etc.).

Feed the connecting cables for fire detectors, periphery devices and main supply to the control panel using the provided holes in the casing.

12.2. Periphery devices assembly

All connections are to be made by means of terminals, mounted on the printed circuit boards (Appendix 4). Be advised, that the total consumption of the voltage powering the external devices (terminal "+ 28V") shall not exceed 0.45A in heavy duty mode

12.2.1. Mounting periphery devices to controllable outputs

Terminals "+Out", "-Out" - controllable potential output, activated in Fire condition shall be used. The fire control panel constantly monitors the power supply line for Fault conditions (break or short circuit).

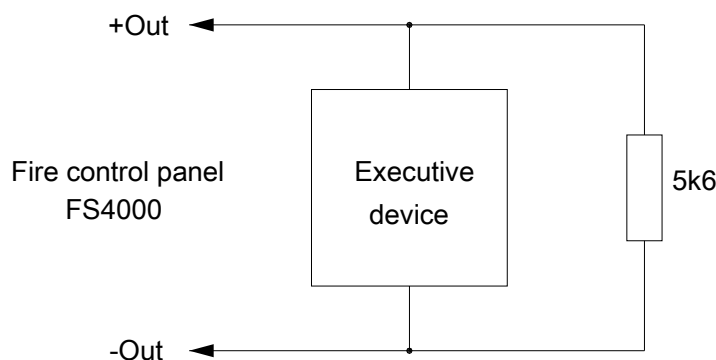

If the controllable output is not in use, fix a resistor 5k6/0,25W immediately to terminals "+Out", "-Out".

12.2.2. Mounting periphery devices to relay outputs

Use:

- terminal "+24V" – positive lead of the stabilized direct current supplying the external devices (light and sound signaling devices, executing devices and others);
- terminal "GND" – chassis ground (negative lead of the stabilized direct current supplying the external devices);

- terminals “Rel/C”, “Rel/NO” и “Rel/NC”, - potential free relay contacts, responding at Fire condition;
- terminals “REL Fault/C”, “REL Fault/NO” и “REL Fault/NC” - potential free relay contacts. Terminals “REL Fault/C” and “REL Fault/NO are connected where no fault condition is registered; terminals “REL Fault/C” and “REL Fault/NC” where fault condition is registered.

Fire control panel FS4000

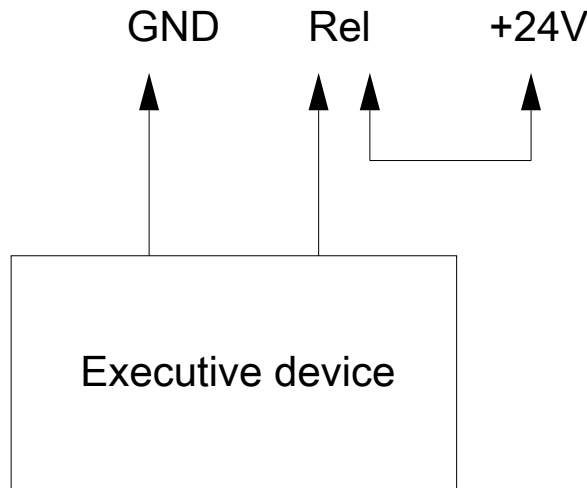

Unused relay outputs remain free (the terminals are not occupied).

12.3. Connecting fire detectors

Fire detectors are connected to the fire control panel by means of two-wire insulated line of total resistance up to 100Ω. Recommended cross section of the wires depending on the length of the line is:

- ◆ Up to 500 m -cable 2 x 0.5 mm²
- ◆ Up to 1000 m -cable 2 x 1.0 mm²
- ◆ Up to 1500 m -cable 2 x 1.5 mm²

Before connecting a fire alarm line to the control panel, run a check with measuring equipment. Where the installation is completed correctly (EOL module is mounted) between the + and the – of the cable, entering the control panel, a resistance of 5.6 kOhm (+/-10%) shall be measured. Also, check both cables to “GROUND” and the measuring equipment shall display that no leakage or connection is registered.

Complete the connection using the terminals of the corresponding modules (Appendix 4) “+L x” and “-L x” (where “x” is the number of the line); follow the designated polarity.

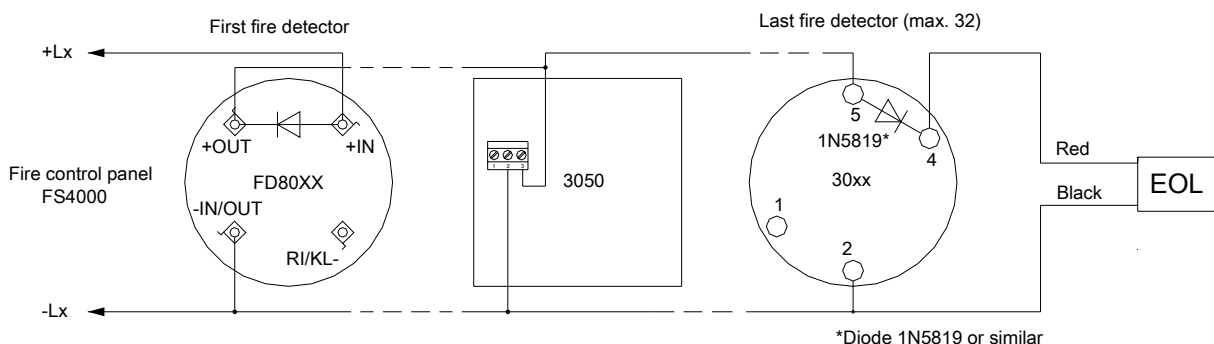

Automatic fire detectors of series FD3000 and FD8000 or compatible can be used. To enable detection of Fault condition *Removed fire detector* diodes shall be mounted – for example 1N5819, at

the indicated direction. The manual call points shall respond with current $\geq 40\text{mA}$ at voltage 24V. You can use FD3050 Manual Call Point or compatible.

Up to 32 fire detectors can be integrated in one fire alarm line regardless of their type.

End of line modules EOL shall be connected directly to the terminals of unused fire alarm lines, otherwise the lines will trigger Fault condition.

12.4. Connection to power supply

Take out the fuse from the terminal with mains fuse (Appendix 3).

Connect a feeding cable to the terminal with mains fuse, observing the following positions (Appendix 3):

- P – power wire “Phase”;
- N – power wire “Null”;
- GROUND - safety ground wire.

The cable shall be double insulated and of $0,5\text{mm}^2$ section for the power supply wires, and of $1,5\text{mm}^2$ section for the safety ground wire.

The other end of the feeding cable is connected to the mains power supply by means of junction box.

The mains power supply of the fire control panel shall be in a separate loop.

13. Fire control panel start up

Make sure that the connection to mains power supply is properly completed.

Make sure that the periphery devices are correctly connected.

Place the fuse in the terminal and all LEDs shall illuminate for a short time, then the control panel starts operation.

Connect the feeding cable and the backup batteries. Connect the red wire to the positive backup battery pole, and the blue wire - to the negative pole. The overall voltage of both batteries shall be more than 9.0 V, otherwise the fire control panel will not recognize them.

14. Conditions of operation, storage and transportation

14.1. Operation and storage

The fire control panel shall operate and be kept in closed premises, under the following conditions:

14.1.1. Temperature:

- | | |
|------------------|-----------------|
| - storage | - +5 to +35°C |
| - transportation | - -10 to +50°C |
| - operation | - -5°C to +40°C |

14.1.2. Relative humidity:

- | | |
|-------------|-------------|
| - storage | - up to 80% |
| - operation | - up to 93% |

14.2. Transportation

The fire control panel shall be transported by vehicles, in factory packing, in the above stated environmental conditions and at sinusoidal vibrations with acceleration amplitude not more than $4,9\text{m/s}^2$ in frequency range 10 to 150Hz.

15. Warranty

The producer guarantees compliance of the unit with BDS EN 54-2: 1997. The warrant period is 18 months from the date of the purchase, providing that

- the conditions of storage and transportation have been observed;
- the startup has been done by authorized personnel only;
- the requirements for operation stated herein have been observed.

UniPOS wishes you a successful work!

Appendix

Appendix 1

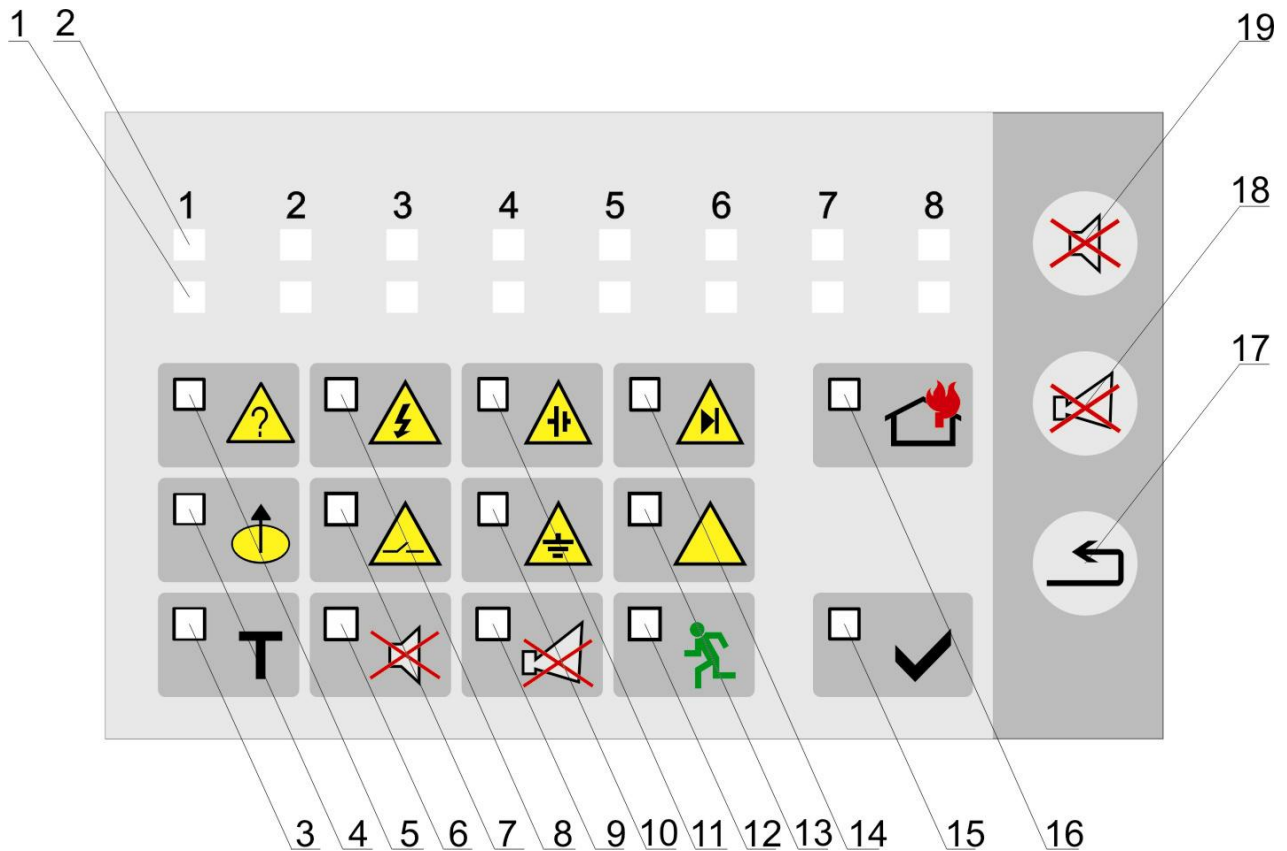

- 1 Separate indicators for fire condition
- 2 Separate indicators for fault condition
- 3 Indicator *Test condition*
- 4 Indicator *Disabled component*
- 5 Common indicator for fault condition
- 6 Indicator *Stop Alarm*
- 7 Indicator *Out of order/disabled controllable output*
- 8 Indicator *Fault in mains power supply*
- 9 Indicators *Suppress sounder*
- 10 Indicator *Fault in grounds*
- 11 Indicator *Fault in backup batteries*
- 12 Indicator *Delay of outputs*
- 13 Indicator *System fault*
- 14 Indicator *Fault in internal supply units*
- 15 Indicator *Power supply*
- 16 Common indicator *Fire condition*
- 17 Button *Reset Line*
- 18 Button "Enable/disable outputs"
- 19 Button "Enable/disable alarm"

Front panel of FS4000

Appendix 2

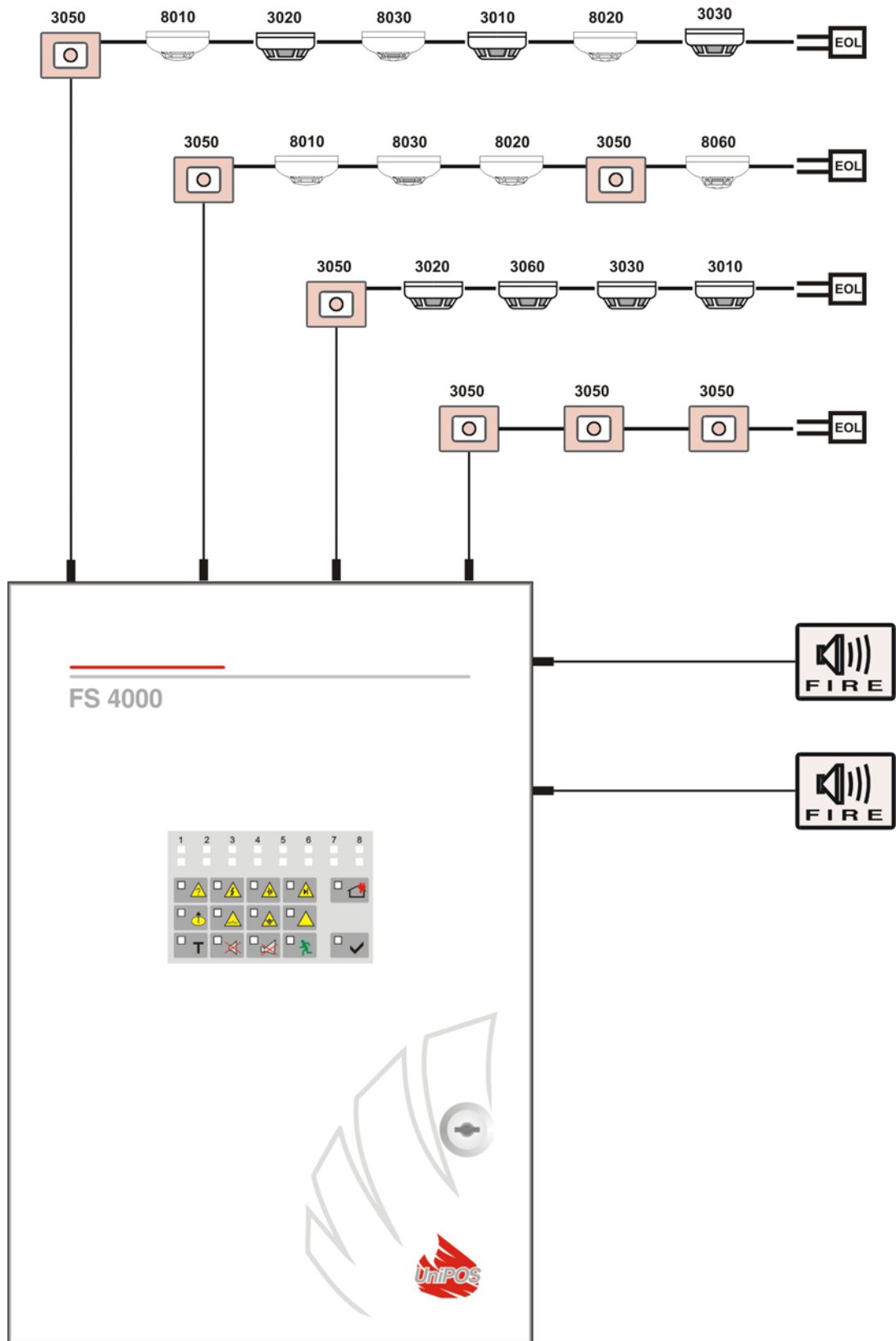

Diagram of fire alarm installation based on Fire control panel FS4000