

Cxi and Ci Printers

USER'S MANUAL



COGNITIVE **TPG**

Copyright © 2011, CognitiveTPG, Inc.

CognitiveTPG™, Cxi™, Ci™, and Compact Industrial™ are trademarks of CognitiveTPG. Microsoft® and Windows™ are trademarks of Microsoft Corporation. Other product and corporate names used in this document may be trademarks or registered trademarks of other companies, and are used only for explanation and to their owner's benefit, without intent to infringe.

All information in this document is subject to change without notice, and does not represent a commitment on the part of CognitiveTPG. No part of this document may be reproduced for any reason or in any form, including electronic storage and retrieval, without the expressed written permission of CognitiveTPG. All program listings in this document are copyrighted and are the property of CognitiveTPG and are provided without warranty.

To contact CognitiveTPG,
Write, email, or call:

CognitiveTPG, Inc.
25 Tri-State International
Suite 200
Lincolnshire, IL 60069

E-Mail: support@CognitiveTPG.com
Telephone: 800.732.8950
Direct: 607.274.2500 ext 4
Fax: 847.383.7949

Table of Contents

Chapter 1: Welcome	1
Chapter 2: Getting Started	2
Outside the Printer	2
Inside the Printer	3
Connection Ports and Power Connector.....	4
Setting Up the Cxi and Ci Printers.....	9
Chapter 3: Software Installation	35
Chapter 4: Using the Administrator Tool	36
Connect to the Printer.....	36
Change a Printer Setting	37
Connection Settings Tab	38
Printer Settings Tab	38
Label Positioning	39
Calibrating the Printer.....	39
Fonts/Objects.....	40
Profile Management	41
Firmware Upgrade.....	42
PCL Windowing	43
Script Editor	44
Chapter 5: USB-A HOST	45
Using USB Hubs, Keyboards and Scanners.....	45
Using a USB Flash Drive	45
Loading Settings Using a USB Flash Drive	46
Loading Objects Using a USB Flash Drive	46
Loading Firmware Using a USB Flash Drive.....	46
Chapter 6: Network Printing	48
Assigning a Static Address.....	48
Using Automatic Address Assignment	49
Verifying Network Settings	49
Configuring a Printer Driver for Network Use.....	50
Sharing the Printer on a Network	51
Network Support Materials.....	52
Chapter 7: Printing Standard Labels and Tags	53
Using Label Software	53
Using CPL Programming	53
Using Third-Party and Proprietary Applications	54
Setting Label Size	55
Creating a Label and Barcode	57
Printing a Label	58
Printing from Proprietary Applications.....	58

Chapter 8: Troubleshooting	59
Isolating Problems.....	59
Common Issues	60
General Troubleshooting Tips	62
Chapter 9: Printer Specifications	64
Standard Features.....	64
Optional Features	64
Printing Specifications	65
Media Specifications.....	65
Ribbon Specifications.....	66
Font Specifications	66
Bar Code Symbologies and Specifications	66
Cognitive Programming Language (CPL)	67
Communications Specifications.....	67
Electrical Specifications	67
International Environment Compliance	67
International Regulatory Compliance	67
Environmental Specifications.....	67
Physical Specifications	68
Software	68
Preventive Maintenance.....	68
Cleaning	68
Warranty.....	68
Chapter 10: Consumables	69
Compatible Media	69
Chapter 11: Cleaning and Preventive Maintenance	71
Cleaning Instructions	71
Printhead Assembly Removal and Replacement	72
Platen Assembly Removal and Replacement	76
Chapter 12: Support	85
Contacting Customer Support.....	85
Index	86

Chapter 1: Welcome

Congratulations on the purchase of a CognitiveTPG Compact Industrial C Series thermal label printer. With its 2-year warranty, mid-range performance, and customer service, the printer will provide you continuous label printing with very little downtime and at the highest quality. CognitiveTPG is committed to providing a high-performance and reliable user experience.

The following list of documents are located on the CognitiveTPG Web site at www.CognitiveTPG.com under the Download section:

This User's Manual: Provides information on how to install the printer and includes all necessary user support information.

Quick Start Guide: The Quick Start Guide provides illustrated Cxi and Ci high-level printer setup information including media loading, ribbon loading for thermal transfer models, and software/drivers installation instructions. A printed copy of this document is provided with every C Series printer. Chapter 2 of this User's Manual provides further instructions on setting up your Cxi and Ci printers.

Programmer's Guide: The Programmer's Guide provides information about how to program all CognitiveTPG printers. For up-to-date firmware release notes and to download the most recent firmware required for the Cxi and Ci printers visit: http://www.cognitivetpg.com/resources_Firmware.aspx

Ethernet Printer Information: The Ethernet Printer Information provides information for configuring and troubleshooting the internal Ethernet print server. The Ethernet Printer Information is a section of the Programmer's Guide.

Printer Drivers (Microsoft Windows® only): Printer drivers required for the C Series printers are provided available online at www.CognitiveTPG.com under the Download section.

Media Guide: To ensure full printhead warranty on all C Series printers, CognitiveTPG requires the use of CognitiveTPG approved media. For more information on CognitiveTPG's approved media, please call 800.732.8950 or 303.586.8358 or go to www.CognitiveTPG.com.

Marketing and Sales Support: The CognitiveTPG Web site (www.CognitiveTPG.com) has additional information and sales support such as product brochures, presentations, and product images. The files are available in many formats for easy-to-use downloads. For additional help, contact the marketing department at 800.732.8950 ext. 1 or e-mail marketing@CognitiveTPG.com.

Support: For technical support, please contact the Technical Support Team by calling toll free at 800.732.8950 ext. 4 or directly at 607.274.2500 ext. 4. Or e-mail support@CognitiveTPG.com.

Chapter 2: Getting Started

First, take a tour around the printer to understand its parts and functions.

Outside the Printer

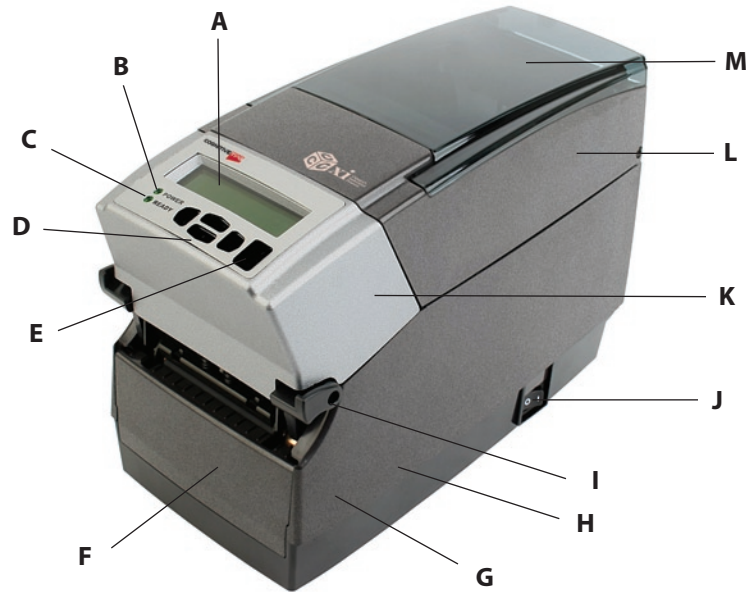

Figure 2-1. C Series Top and Front View

Device	Use
A – LCD control panel (Cxi only)	Back-lit, two-line, 16-character display with full menus to change setup options
B – POWER LED	Shows power status GREEN – Power switch is turned on
C – READY LED	Shows printer status GREEN – Printer ready to accept data RED – Printer error, empty media roll, or paused operation during batch mode processing
D – User interface menu buttons (Cxi only)	Controls user interface
E – FEED/Enter button	Advances print media/Enters user menu commands
F – Front bezel	Covers the front of the printer
G – Lower case	Covers the sides of the printer
H – Case base	Covers the base of the printer
I – High-lift printhead latches	Pushes upward to release the printhead
J – ON/OFF switch	Controls printer power
K – Cast metal user interface cover	Contains user interface buttons
L – Dust cover	Protects print media
M – Hinged media window	Contains a large clear window to view media

Inside the Printer

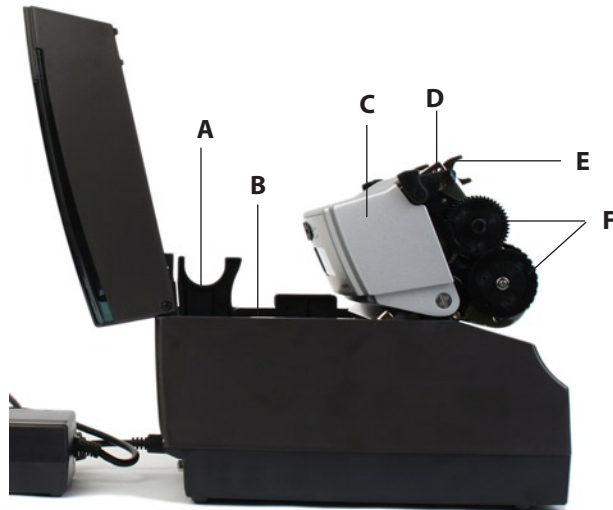

Figure 2-2. C Series Side View

Device	Use
A – Large roll spindle slot	Holds large roll media
B – Standard roll spindle slot	Holds standard roll media
C – Cast metal user interface cover	Contains user interface buttons
D – Printhead	Printing mechanism
E – Printhead bracket	Holds the printhead
F – Ribbon drive gears	Feeds ribbon through the printer

Paper Media Guide Bar



Figure 2-3. C Series Inner Side View of Media Bar



Figure 2-4. C Series Top View of Media Guide from Behind Printer

Device	Use
A – Media guide (silver bar)	Guides the labels through the printer

Connection Ports and Power Connector

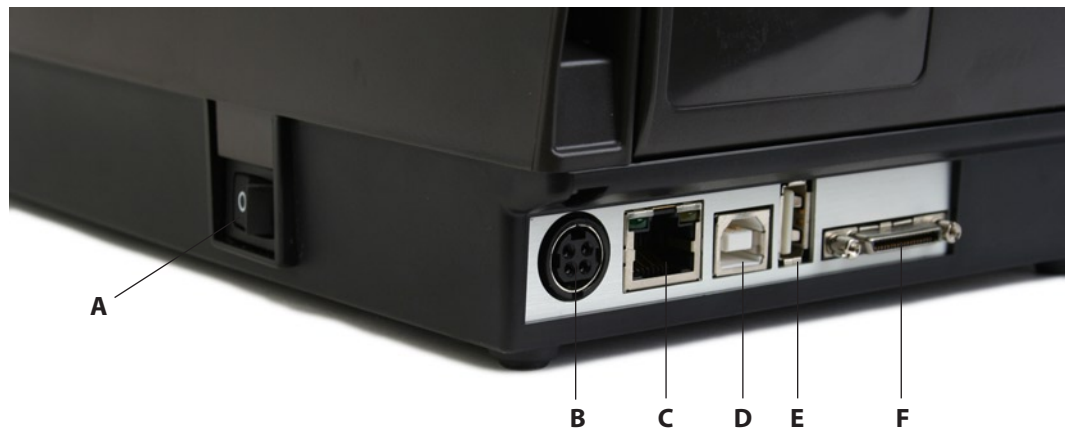

Figure 2-5. C Series Connections and Power (Back View)

Connector	Use
A – ON/OFF switch	Controls printer power
B – Power connector	Connects to power supply
C – Ethernet connector (RJ-45)	Ethernet communications port for network connectivity
D – USB-B device port	USB communications port
E – USB-A host port	USB communications port
F – Serial/Parallel port	Serial/parallel data communications port

Take Up Spindle and Take Up Clutch (Gears)

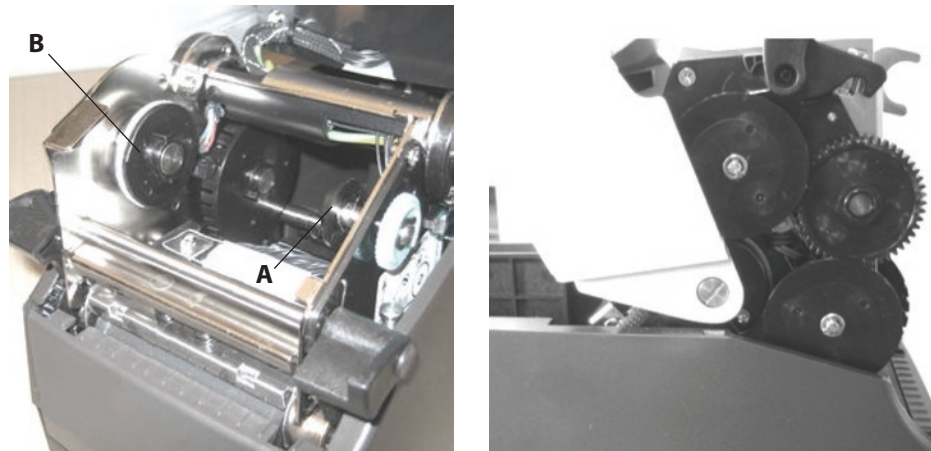

Figure 2-6. Take Up Spindle, Clutch, and Side view of Clutch Gears

Components	Description
A	Take Up Spindle
B	Take Up Clutch

Supply Spindle and Supply Clutch

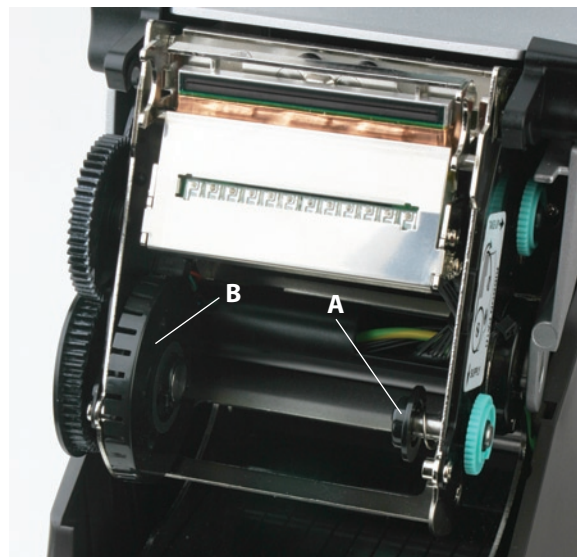

Figure 2-7. Supply Spindle and Clutch

Components	Description
A	Supply Spindle
B	Supply Clutch

Printhead Assembly (TPH, Shield, Bracket, and LED Array)

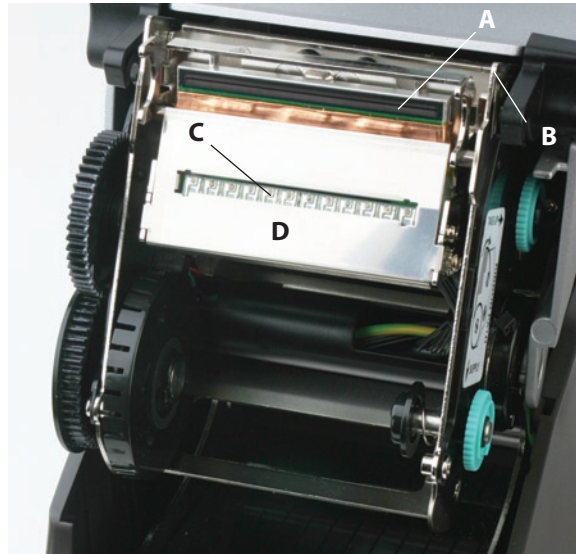

Figure 2-8. Printhead Assembly

Components	Description
A	Printhead
B	Bracket
C	LED Array
D	Shield

Platen and Index Sensor

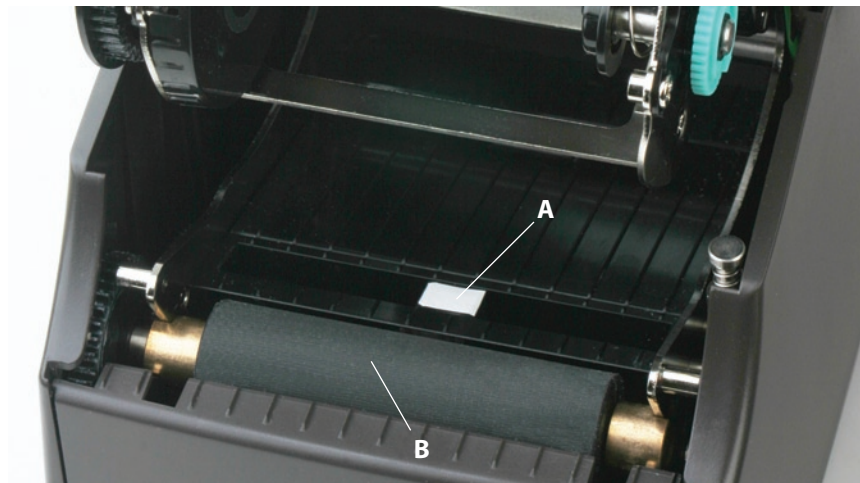

Figure 2-9. Platen Assembly and Index Sensor

Components	Description
A	Index Sensor
B	Platen

Understanding the Control Panel Buttons and LCD (Cxi Only)

When the printer is powered on, the LCD displays COGNITIVE CXI. After approximately 2 seconds, the LCD displays COGNITIVE. This is an indication that the menu is at its highest level.

From this menu level, the LEFT button displays the current status of the printer; either a READY condition, or the most recent error encountered.

To begin navigation through the menu, press the RIGHT button to enter the MAIN MENU. Pressing the UP/DOWN buttons and the ENTER button allows movement throughout the menu tree. Pressing the ENTER button selects a menu item, allowing navigation deeper into that menu. At any time, the LEFT button may be pressed to return to the previous menu level, or to escape without making a selection. Repeatedly pressing the LEFT button returns the user to the highest menu level.

Summary of the keypad button functions:



Figure 2-10. Cxi Printer User Interface Menu Buttons

LEFT button (B): Press the LEFT button to display the current printer status. From within the menu, pressing the LEFT button returns to the previous menu level.

UP (A) and DOWN (C) buttons: Allows menu navigation up and down through the menu tree, and allows the user to increase or decrease numeric values in some menu items.

RIGHT button (D): Allows the user to enter the menu system, and controls horizontal movement of the menu cursor for certain menu items.

ENTER button (E): In the menu mode, selects a menu item for further navigation. ENTER also selects a value in a menu item. The LCD displays the confirmation message **VALUE HAS BEEN SET.**

At the highest menu level, when COGNITIVE is displayed on the LCD, or when the printer is ready to print, this button acts as a FORM FEED.

When the ENTER button is pressed, a single label is fed if the printer is in an indexing mode. When the button is pressed continuously for longer than two seconds, the printer feeds labels until the button is released. When indexing is disabled, the printer feeds media continuously when the ENTER button is pressed.

Understanding the LCD Menu Structure

MAIN MENU			
USER MENU			
	LCD Contrast	Contrast 0 ... 8	
	Backlight Control	ON or OFF	
	Language Menu	English, Spanish, French, Russian	
	Beeper Volume	Volume 0 ... 3	
	Set Date and Time	Date (MM/DD/YY)	Time (HH:MM:SS)
SETUP MENU			
COMM Menu			
	Serial	BAUD	1200, 2400, 4800, 9600, 19200, 38400, 57600, 115200
		PARITY	Even, Odd, None
		DATA Bits	7 or 8
		STOP Bits	1 or 2
	Ethernet	DHCP	ON or OFF
		Set Static IP	XXX.XXX.XXX.XXX
		Set Subnet	XXX.XXX.XXX.XXX
		Set Gateway	XXX.XXX.XXX.XXX
	Transfer Mode	Direct Thermal or Thermal Transfer	
	Speed	High, Normal, Low	
	DPI Select	200dpi	Selectable 200 or 100 dpi
		300dpi	Selectable 300 or 150 dpi
	Index	Bar, Gap, Notch	
	Width	16 ... 425	Quick UP / DWN key press increments by 1; Press and hold increments by 10
	Top Of Form Adjust	0 ... 2000	Quick UP / DWN key press increments by 1; Press and hold increments by 10
	Darkness	-200 ... 813	Quick UP / DWN key press increments by 1; Press and hold increments by 10
	Feedback	ON or OFF	
	Report Level	0 = None, 1 = Serial, 2 = Label	
	Timeout	0 ... 65535	Quick UP / DWN key press increments by 1; Press and hold increments by 10
	Shift Left	-Printhead... +Printhead	Quick UP / DWN key press increments by 1; Press and hold increments by 10
	Present Label	ON or OFF	
		Advance	0 ... 2000 Quick UP / DWN key press increments by 1; Press and hold increments by 10
		Retract	0 ... 2000 Quick UP / DWN key press increments by 1; Press and hold increments by 10
		Time	0 ... 100 Quick UP / DWN key press increments by 1; Press and hold increments by 10
CALIBRATION MENU			
	Calibration Menu Start?	Based on Bar, Gap or Notch index setting	
TEST MENU			
	Label or Objects		
OPTIONS MENU			
	External 5 volts	ON or OFF	
SETTINGS MENU			
	Save Settings	Yes? Or No?	
	Read Settings	Yes? Or No?	
	Factory Defaults	Yes? Or No?	
CUSTOMER SUPPORT			
	Phone: 1-800-525-2785 Web: www.CognitiveTPG.com		
RETURN			
	Return to Main Menu		

Setting Up the Cxi and Ci Printers

Setting up a C Series printer is an easy process. This chapter describes printer requirements, printer controls, loading thermal transfer ribbon, and loading print media. The printer self test is also described. Be sure to follow all steps in sequential order as listed in this User's Manual to avoid electric shock or damage to the C Series printer.

Printer Requirements

The C Series printer has the following operational requirements.

- Communications
 - Serial – Standard RS-232 (requires a custom cable, refer to Chapter 10)
 - Parallel – Uni-directional parallel interface (requires a custom cable, refer to Chapter 10)
 - USB A Host Interface – USB cable, MSD, HID
 - USB B 2.0 Device Interface – USB cable
 - Ethernet 10/100 (Optional) – Standard 10Base-T interface cable
- Auto-detectable 90-264VAC, 24VDC 150W power supply
- Environment
 - Operating environment:
 - 41°F to 104°F (5°C to 40°C)
 - 20% to 85 % non-condensing R. H. (relative humidity)
 - Storage/transportation environment:
 - -4.0°F to 122°F (-20°C to 50°C)
 - 5% to 95% non-condensing R. H. (relative humidity)

Unpacking the Printer

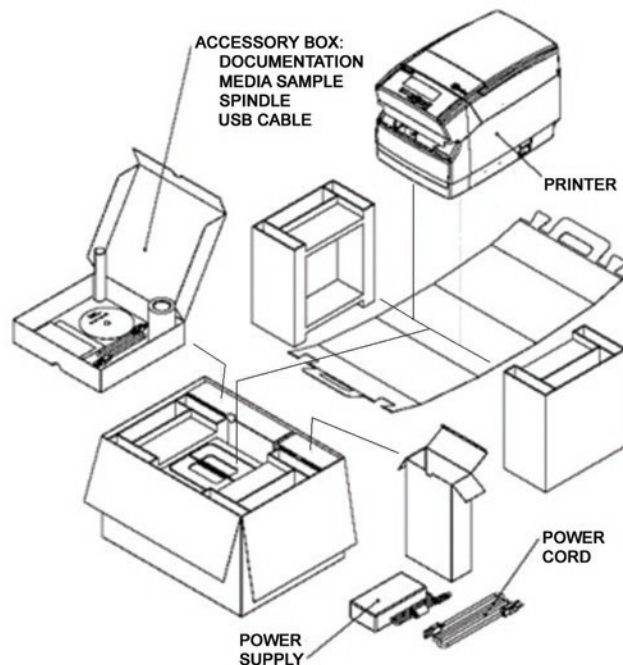

Figure 2-11. Packaging Diagram

Controls, Indicators, and Connectors

Controls and indicators for the C Series printer are located on the front panel and right side of the printer. Cxi printers also have an LCD display on the user interface.

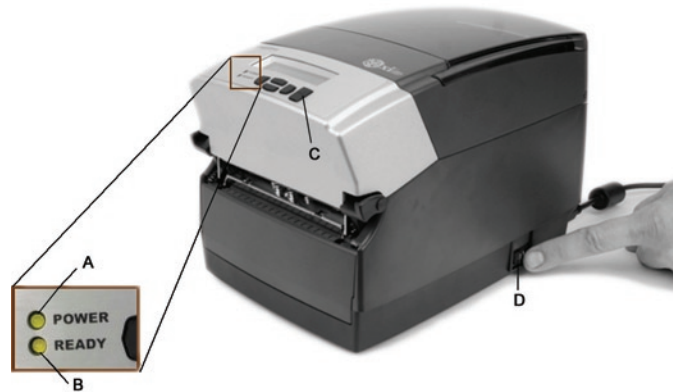

Figure 2-12. C Series Printer Controls and Indicators

Device	Primary Function	Use
A - POWER light	Shows power status	ON – printer on and ready to print OFF – no power applied
B - READY indicator	Shows printer status	GREEN – printer ready to accept data RED – printer error, empty media roll, or paused operation during batch mode processing OFF – no power applied
C - FEED button	Advances print media	Press to advance media Press and hold while turning unit on to initiate self test and print current configuration
D - ON/OFF switch	Controls printer power	Press to turn printer on and off

Connecting Data Cables to the Printer

Connect one of the following data cables to the matching located on the back of the C Series printer:

- Ethernet cable
- USB cable (compatible with both USB-A and USB-B)
- CognitiveTPG custom parallel cable
- CognitiveTPG custom serial cable or serial adapter cable

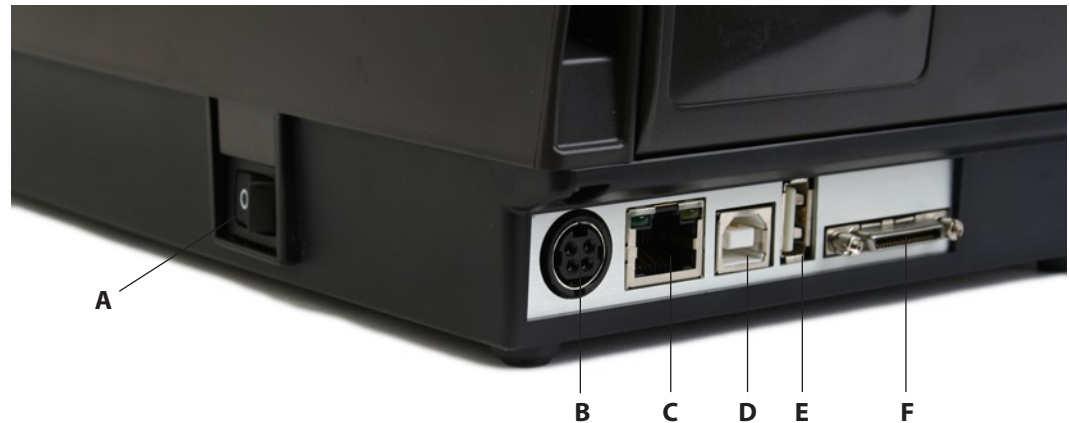

Figure 2-13. (Back View) Connections and Power

Connector	Use
A – ON/OFF switch	Controls printer power
B – Power connector	Connects to power supply
C – Ethernet connector (RJ-45)	Ethernet communications port for network connectivity
D – USB-B device port	USB communications port
E – USB-A host port	USB communications port
F – Serial/Parallel port	Serial/parallel data communications port

NOTE: FOR PARALLEL AND SERIAL CONNECTIONS, A CUSTOM CABLE IS REQUIRED. A STANDARD PARALLEL OR SERIAL CABLE WILL NOT WORK WITH THIS PRINTER. TO OBTAIN MORE INFORMATION ON HOW TO ORDER A CognitiveTPG CUSTOM SERIAL AND/OR PARALLEL CABLE COMPATIBLE WITH ALL C SERIES PRINTERS, PLEASE REFER TO CHAPTER 10 OF THIS USER'S MANUAL, THE PRODUCT GUIDE LOCATED ON THE WEB SITE, OR THE PRODUCT GUIDE ON THE COMPANION CD.

A STANDARD USB CABLE IS SHIPPED WITH ALL C SERIES PRINTERS. IT IS LOCATED IN THE ACCESSORIES BOX.

USB-A HOST Connectivity

The C Series printer supports hubs, USB keyboards, USB keyboard wedge scanners, and USB flash drives.

These devices can be used to input data directly to the printer. They are most commonly used in conjunction with CPL scripting language, for example, menus and stored formats, to produce labels.

The USB flash drive can be used upgrade printer firmware. This topic is discussed further in Chapter 5 "USB-A Host."

Connecting Power to the Printer

The next step is to provide power to the C Series printer. Use only the AC adapter

supplied with the printer. Using a power adapter not certified for use is both unsafe and voids the warranty on the printer.

IMPORTANT NOTE: FOLLOW THESE STEPS IN ORDER TO SAFELY CONNECT POWER TO THE PRINTER.

Connect the provided power supply cord into the power supply unit.



Figure 2-14. Connecting the Power Cord into the Power Supply

Connect the power supply cord into the power connector located in the back corner of the C Series printer. The flat end of the power supply cord, listed as B below in Figure 2-15, has an arrow to indicate which end is on top. There is also an indented key, shown as A below in Figure 2-15, to illustrate which end should be inserted upright into the C Series power connector.



Figure 2-15. Connecting the Power Supply to the Printer

Connect the power cord into the power source by carefully plugging the power cord into the wall outlet or other power source.

NOTE: ONCE THE POWER SUPPLY IS PLUGGED INTO THE WALL, THE GREEN LED ILLUMINATES ON THE POWER SUPPLY UNIT.



Figure 2-16. The Green Power Light on the Power Supply

Printer Power Test

The power supply indicates power with a green light. The next step verifies the printer is receiving power.

Press the power switch (D in Figure 2-17 below) to the ON position.

NOTE: THE POWER LIGHT ON THE TOP USER INTERFACE COVER TURNS GREEN TO INDICATE THE UNIT IS RECEIVING POWER.

THE READY LIGHT FIRST TURNS RED, THEN AUBURN, THEN GREEN WHEN THE PRINTER IS READY TO PRINT.



Figure 2-17: Powering ON the C Series Printer

Device	Primary Function	Use
A - POWER light	Shows power status	ON – printer on and ready to print OFF – no power applied
B - READY indicator	Shows printer status	GREEN – printer ready to accept data RED – printer error, empty media roll, or paused operation during batch mode processing OFF – no power applied
C - FEED button	Advances print media	Press to advance media Press and hold while turning unit on to initiate self test and print current configuration
D - ON/OFF switch	Controls printer power	Press to turn printer on and off

NOTE: (CXI PRINTERS ONLY) THE LCD BRIEFLY DISPLAYS **PRESS RIGHT ARROW FOR MENU**. THEN THE LCD DISPLAYS **COGNITIVE CXI** FOR ABOUT ONE SECOND. WHEN THE PRINTER IS READY TO PRINT, THE LCD DISPLAYS **COGNITIVE**. (SEE Figure 2-18 BELOW).



Figure 2-18: CXI Printer LCD Display when Printer is Powered ON

Press the Power Switch to OFF and confirm the Power and Ready Light turn off before proceeding to the next steps. Refer to Figure 2-12 in step 1 of the Power Test section of this manual to locate the power button on the printer.

NOTE: POWER OFF THE PRINTER BEFORE PROCEEDING.

Thermal Transfer Ribbon Loading (TT Printers Only)

To run the C Series printers in thermal transfer mode, a ribbon must be loaded properly into the C Series printer in order to print. This section details step-by-step instructions on how to load thermal transfer ribbon into the printer. There is a ribbon loading label on the side of the printhead mechanism for all thermal transfer C Series printers as shown in Figure 2-19 below.



For ribbon specifications and details please refer to the Consumables Guide.

Figure 2-19: Ribbon Loading Label

- 1) Lift the top hinged dust cover.



Figure 2-20. Lifting the Dust Cover

Remove the Test Sample from inside the printer, and file the test sample with the warranty and other C Series documentation for future reference.



Figure 2-21. Removing the Test Sample from the Printer

Place sample ribbon provided with printer in front of printer. Place large media end towards printer with small take up roll end facing away from printer as shown in Fig. 2-22 below. Gently remove tape from ribbon to prepare for loading.



Figure 2-22. Removing Tape Off of the Ribbon

Once the tape is removed, discard the tape, and spread the ribbon out so the text on the leader is facing down, as shown in Figure 2-23 below. Make sure the ribbon does not roll off the table when setting it down.



Figure 2-23. Ribbon Layout Before Loading Into the Printer

Next, unlatch the printhead mechanism to load the ribbon into the printer. To do this, pull up on the black latches with both hands. Refer to the figure below to release the printhead mechanism.

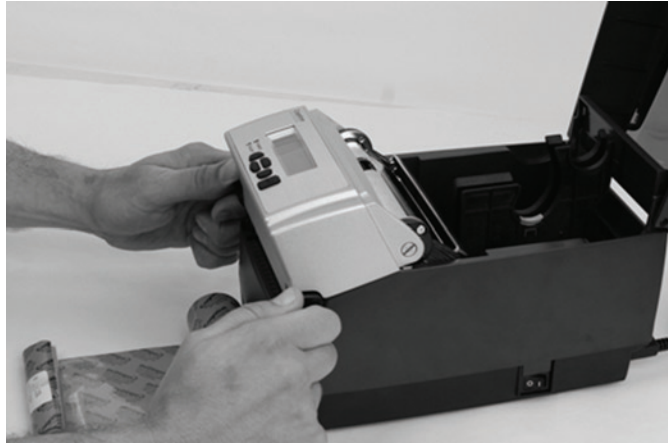

Figure 2-24. Unlatching the Printhead Mechanism

Next, raise the printhead mechanism fully. Refer to the figure below.

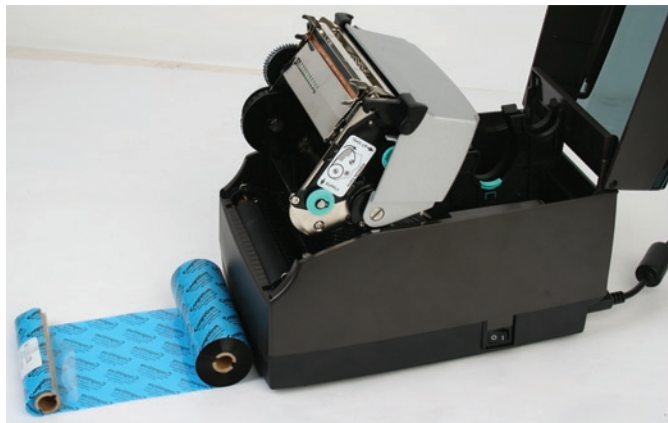

Figure 2-25. Fully Raised Printhead Mechanism

CLEANING NOTE: THIS IS THE IDEAL POSITION FOR CLEANING THE PRINthead, PRINthead SHIELD, AND PLATEN.

FOR MORE INFORMATION ABOUT CognitiveTPG APPROVED CLEANING SUPPLIES, PLEASE REFER TO THE CognitiveTPG WEB SITE.

Next, insert the ribbon supply roll. Lift the ribbon supply roll, as shown in Figure 2-26, with one hand as it currently is positioned with the CognitiveTPG leader text showing. Examine the ends of the ribbon supply roll and notice the notches on the roll. These notches fit into the printer. Refer to Figure 2-27 for clear pictures of the notches.



Figure 2-26. Ribbon Supply Core Notches



Figure 2-27. Lining up Ribbon Supply Core Notches with Supply Spindle Notches

While holding the ribbon in place, pull gently on the green supply spindle to insert the ribbon supply roll into place.



Figure 2-28. Pulling Out the Ribbon Supply Spindle

Place the ribbon supply roll into position as shown in Figure 2-29 below. Line up the notches on the ribbon supply roll with the printer supply spindle notches to secure the ribbon supply roll into place.



Figure 2-29. Lining up the Supply Roll Core with the Ribbon Spindle Notches

When the ribbon feels secure, gently push and rotate the green supply spindle clockwise, while holding the supply clutch hug, until the ribbon seats properly.

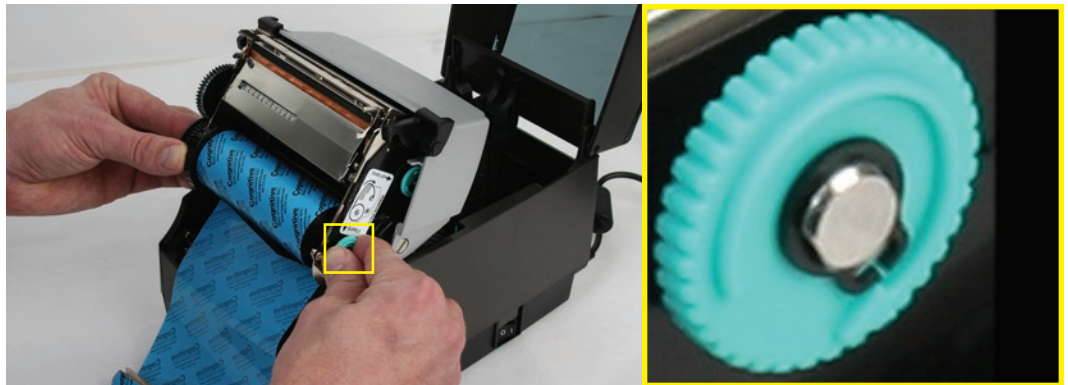

Figure 2-30. Supply Spindle Rotation to Secure Supply Roll In Place

Once the ribbon supply roll is loaded, gently lower the printhead mechanism down with one hand while holding the user interface cover with the other hand. **DO NOT LATCH** the printhead mechanism. Refer to Figure 2-31.

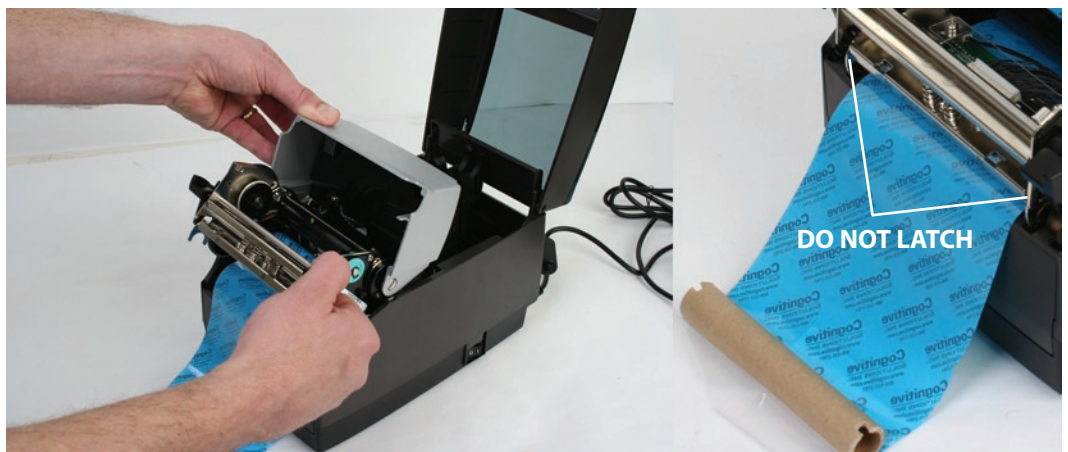

Figure 2-31. Separating and Lowering the Printhead Mechanism from the User Interface Without Latching the Mechanism

NOTE: IF THE PRINTHEAD MECHANISM LATCHES, A CLICKING NOISE WILL SOUND. IF PRINTHEAD MECHANISM IS LATCHED BY MISTAKE, PUSH UP THE BLACK PRINTHEAD LATCHES TO RELEASE THE PRINTHEAD MECHANISM AS SHOWN IN FIGURE 2-24.

Next, install the ribbon take up roll. Examine the ends of the ribbon take up core and notice the notches on the ribbon core. These notches fit into the printer. Refer to Figure 2-32 for clear pictures of the notches. Lift the ribbon take up roll as shown in the figures below.

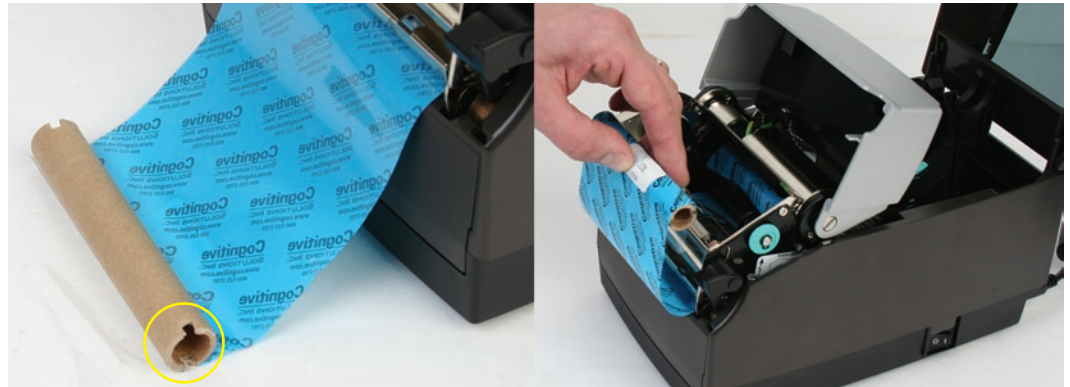

Figure 2-32. Take up Roll Notches and Loading the Take Up Roll

Pull gently on the green take up spindle to insert the ribbon take up roll into place. Line up the notches on the ribbon take up core with the printer take up spindle notches to secure the take up roll into place.



Figure 2-33. Pulling the Take Up Spindle Out to Insert Take Up Roll

Place the ribbon take up roll into position as shown in Figure 2-34. Once the ribbon feels secure, gently push and rotate the green take up spindle clockwise to make sure the ribbon take up core is engaged with the notches on the printer.

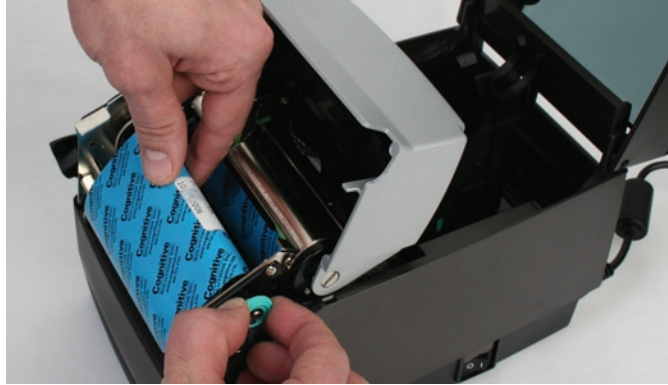

Figure 2-34. Seating the Ribbon Take Up Core Into the Take Up Spindle Notches

Once the ribbon take up core has been installed, turn the take up spindle clockwise to wind the ribbon leader onto the take up core. Rotate the green take up spindle clockwise until the black ribbon begins winding on the take up core as shown in Figure 2-35.

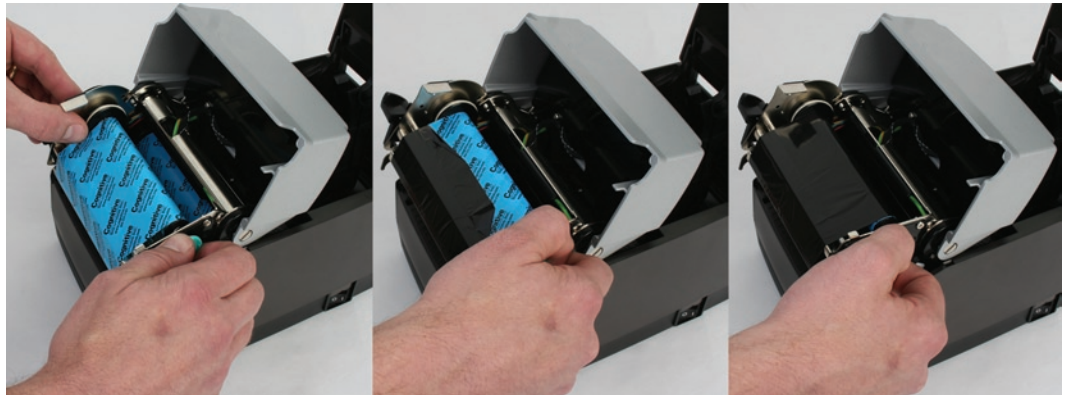

Figure 2-35. Winding the Ribbon Onto the Take Up Core

Gently lower the user interface but **DO NOT LATCH** the printer. Refer to Figure 2-36.



Figure 2-36. Lowering the User Interface without Latching the Mechanism

Loading Media

All C Series printers have media loading instruction labels on the bottom of the dust cover.

To increase the life of the printhead, CognitiveTPG recommends using CognitiveTPG approved media with all C Series printer models. The CognitiveTPG printhead warranty requires CognitiveTPG approved media. For more information regarding CognitiveTPG approved media please contact a local reseller or Customer Service.

Lift the top dust cover (Thermal Transfer printers have already completed this step in the ribbon loading section).



Figure 2-37. Lifting the Dust Cover

Remove the Manufacturing Test Sample from inside the printer and file the Manufacturing Test Sample with the warranty and other C Series documentation for future reference (Thermal Transfer printers have already completed this step in the ribbon loading section).



Figure 2-38. Removing the Manufacturing Test Sample from the Printer

Insert the spindle into the CognitiveTPG approved sample media roll (see inward and outward wound media figures below).



Figure 2-39a. Inserting the Spindle Into the CognitiveTPG Approved Inward Wound Media

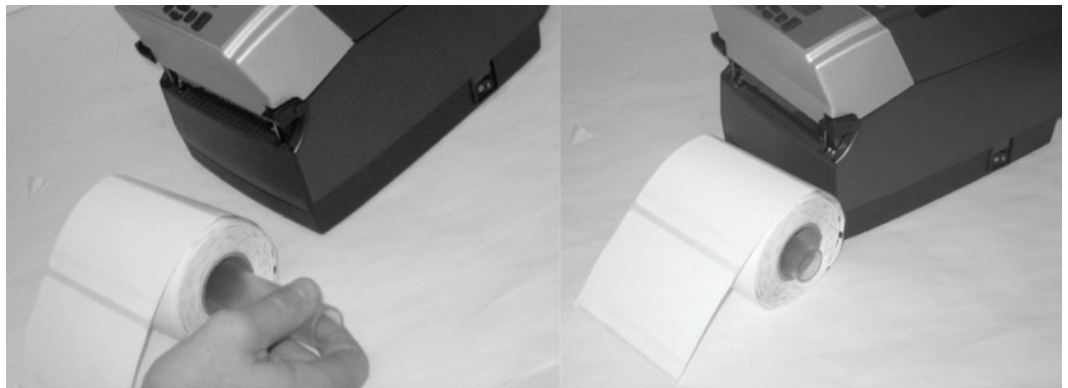

Figure 2-39b. Inserting the Spindle into Outward Wound Media

NOTE: FOR MORE INFORMATION REGARDING CognitiveTPG APPROVED MEDIA PLEASE CONTACT A LOCAL RESELLER OR CUSTOMER SERVICE AT +1.303.586.8340 OR TOLL FREE AT +1.800.732.8950.

Prior to loading media, take a moment to review operation of the media guides. The guides are spring loaded in order to provide proper media control during printing. The right media guide has a green locking tab as shown in Figure 2-40, that holds the guides in any position. This is useful if the same width media is often used. Once the guide is set to the width of the media, it can be locked in place and future loading of media is simplified.

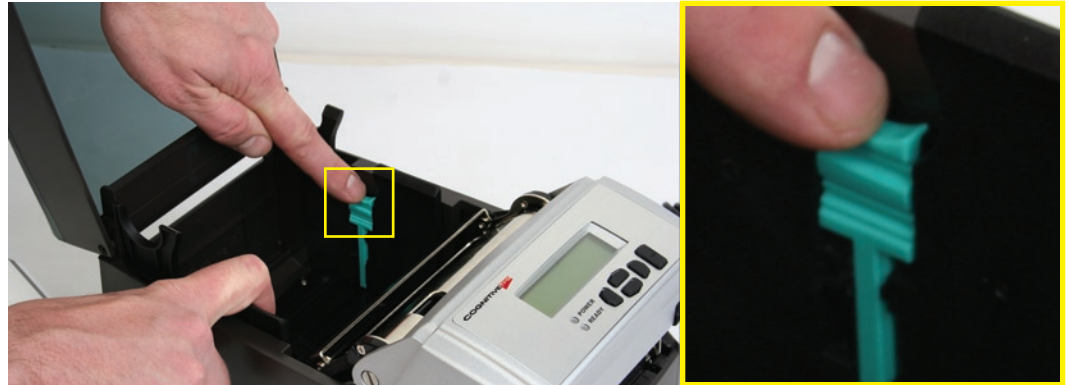

Figure 2-40. Media Guide Locking Tab

To initially set the media guides to the proper setting, try to push either guide to the outside of the printer. If the guide does not move, lift up slightly on the green lock until it stops in the upright position. Move the media guide to the outside of the printer as shown in Figure 2-41.



Figure 2-41. Spread the media guides apart

NOTE: THE LOCK CAN BE REMOVED IF IT IS PULLED UP TOO HARD. IF THIS HAPPENS, RE-INSERT THE LOCK IN THE MEDIA GUIDE.

Locate the media guide bar in the rear of the mechanism, indicated by the arrow in Figure 2-42 below. The media must be placed under the media guide bar, or media wandering can occur.



Figure 2-42. C Series Top View of Media Guide from Behind Printer

Device	Use
A – Media guide (silver bar)	Guides the labels through the printer

Unroll a few labels. Position the media, print side up, into the printer as shown in Figure 2-43.



Figure 2-43a. Media Print Side Must be Facing Up for Inward Wound Media



Figure 2-43b. Media Print Side Must be Facing Up for Outward Wound Media

Place the media under the media guide bar as shown in Figure 2-44.

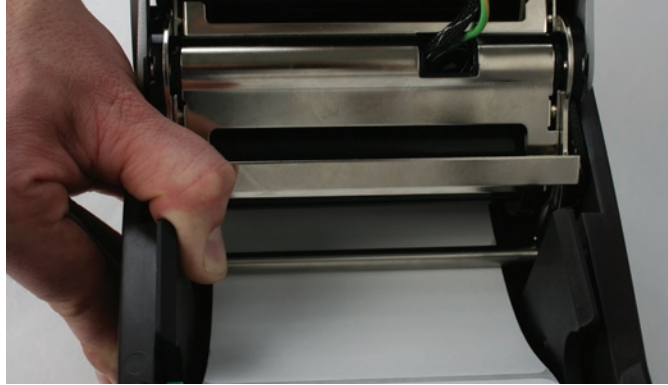

Figure 2-44. Place the Media Under the Media Guide Bar

Lower the media between the two media guides. Position the media as shown in Figure 2-45. Before completely lowering the spindle in the slots as shown, unlock the guides if they are locked so they can spring load against sides of the media roll.



Figure 2-45. Lower the Media Roll Into Lower Media Guide Slots

Once the guides are against the sides of the roll, push the roll down in the slot as shown in Figure 2-46. This locks the media guide in the proper position. The media should look as shown.

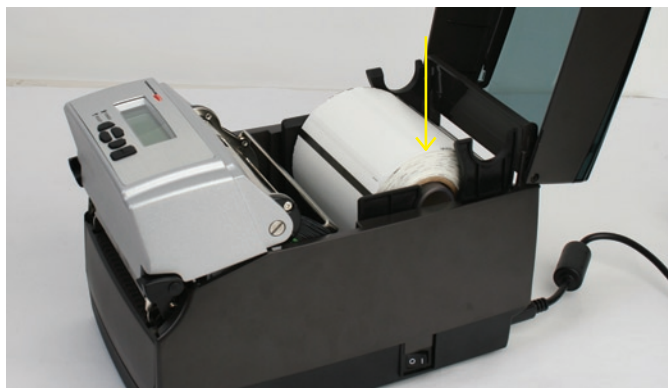

Figure 2-46. Push Down on the Right Side of the Roll to Lock the Media Guide

Lift the mechanism as shown in Figure 2-47.



Figure 2-47. Lift the Mechanism

The media should be visible as shown in Figure 2-48.

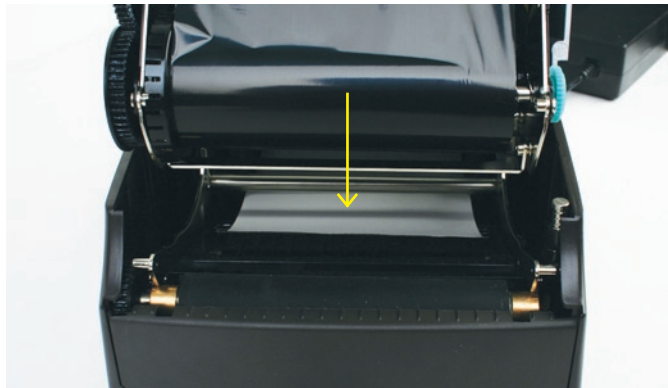

Figure 2-48. Front View of Media Being Loaded Under Media Guide

Pull the media forward three to four inches from within the mechanism, past the drive platen, as shown in Figure 2-49. Center the media on the platen before proceeding to the next step.



Figure 2-49. Pulling the Media Three to Four Inches then Centering on the Platen

Once the media is pulled forward three to four inches, latch the mechanism as shown in Figure 2-50.



Figure 2-50. Latching the Mechanism

Close the dust cover to enclose standard size media while printing.



Figure 2-51. Closed Dust Cover

Loading Large Roll OD Media

Locate the rear door screws at the rear of the printer as identified with the arrows in Figure 2-52. Remove the screws with a #2 Phillips screwdriver.

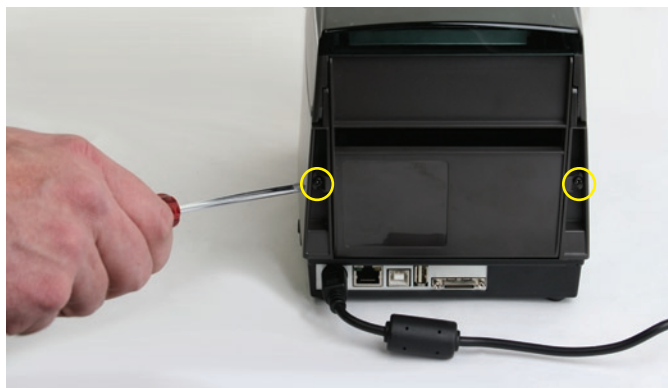

Figure 2-52. Rear Door Screws Identified by Circles

Open the rear door and leave it in the position shown in Figure 2-53.



Figure 2-53. Open Rear Door as Shown

Open the media covers as shown in Figure 2-54.

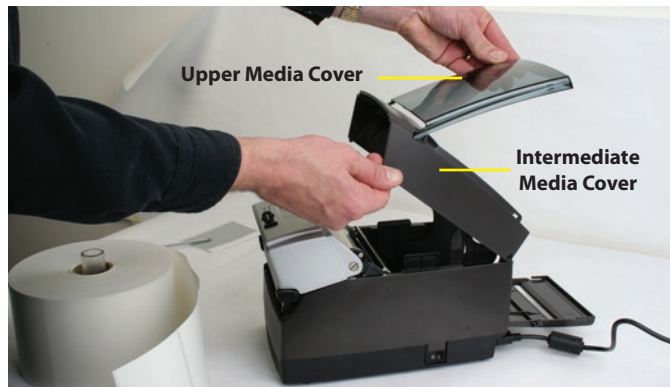

Figure 2-54. Open Media Covers

Remove the manufacturing test sample if this is the first time loading media, and take a moment to review operation of the media guides. The guides are spring loaded in order to provide proper media control during printing. The right guide has a green locking tab, shown in Figure 2-55 that holds the guides in any position. This is useful, if the same width media is often used. Once the guides are set to the width of the media, it can be locked in place for simplified future loading.



Figure 2-55. Media Guide Locking Tab

To initially set the media guides to the proper setting, try to push either guide to the outside of the printer. If the guide does not move, lift up slightly on the green locking tab until it stops in the upright position. Move the media guide to the outside of the printer as shown in Figure 2-56.



Figure 2-56. Opening the Media Guides

NOTE: THE LOCK CAN BE REMOVED IF IT IS PULLED UP TOO HARD. IF THIS HAPPENS, RE-INSERT THE LOCK IN THE MEDIA GUIDE.

Locate the media guide bar.

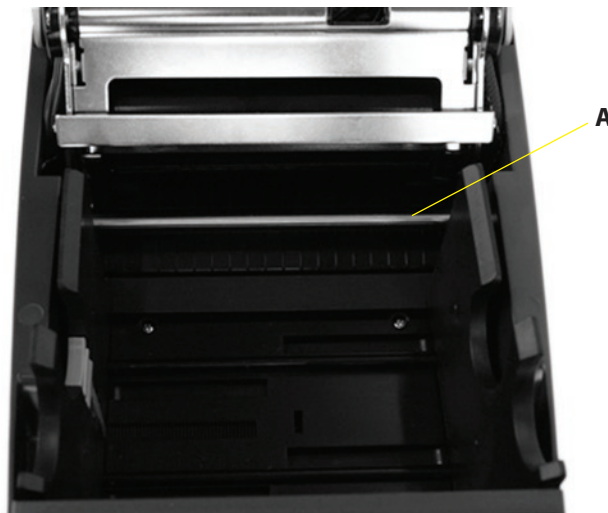

Figure 2-57. C Series Top View of Media Guide from Behind Printer

Device	Use
A – Media guide (silver bar)	Guides the labels through the printer

Before placing the roll in the printer, route the media, print side up, under the media guide bar as shown in Figure 2-58.

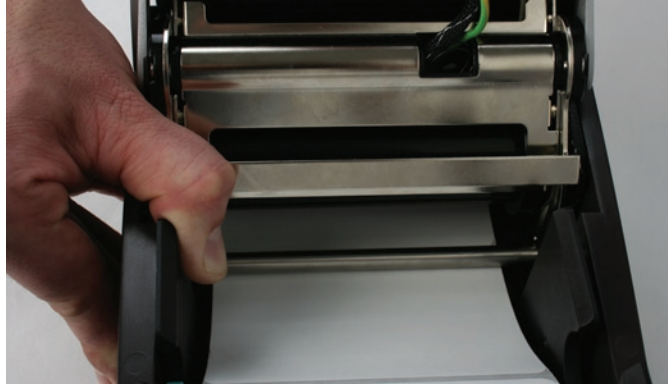

Figure 2-58. Load Media Under Media Guide Bar

If the locking tab is in the locked position, unlock it. Then, place a spindle in the core of the media roll, and position it in the printer, print side up, as shown in Figure 2-59 and Figure 2-60.

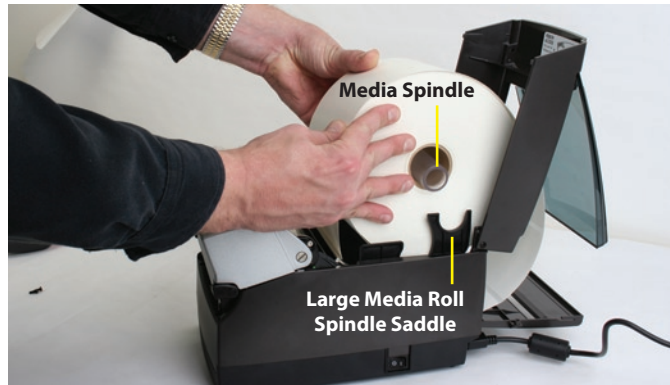

Figure 2-59. Loading Large Media Roll, Print Side Up

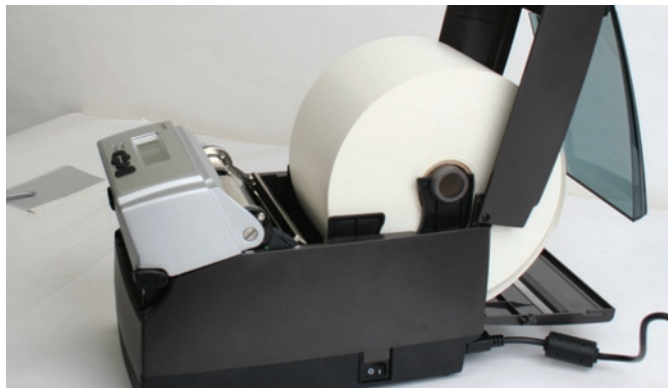

Figure 2-60. Large Media Roll in Position

Close the top cover and let the dust cover rest on the large media roll.



Figure 2-61. Closing the Top Cover

User Adjustable Sensor

The C Series printers have an adjustable index sensor system. By moving the reflective sensor laterally, shown in the next picture, the sensor system can accommodate a wide range of media index mark positions. The sensor has a spring detent feature. To adjust it to the position you require, simply slide it in its channel until it aligns with the feature you are trying to index.

Gap Mode

If you have a 2" wide printer, then the gap sensor is adjustable the entire width of the printer media path. See both pictures below.

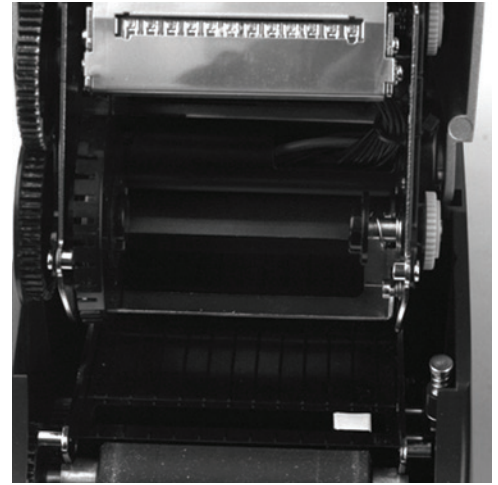
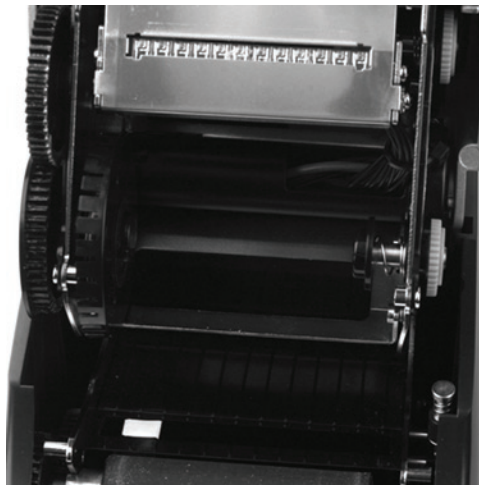

2" Printer with extreme settings of gap sensor positions. Sensor is highlighted with white to better show position.

If you have a 4" wide printer, then the gap sensor will be effectively adjustable for the left half of the media path as shown in the pictures below.



4" Printer shown with extreme settings for gap mode. Note that the sensor should only be adjusted to near center in its right-most setting.

Black Mark Mode

Both the 2" and 4" printers are adjustable the full width of the media path. Please see the C Series technical specification for the exact width of adjustment.

Performing the Self Test

The self test checks the printer's overall operability, and lists the printer's current settings. Refer to the figures and instructions below to perform the printer self test.



Figure 2-62. Performing the Printer Self Test

IMPORTANT! The printer should be loaded with media, connected to AC power, and turned on.

- 1) Press and hold the FEED button.
- 2) Turn the printer ON while holding the FEED button.
- 3) Release the FEED button when the self test starts to print.
- 4) Turn the printer off and then on again to return to normal printing operation.

IMPORTANT! AFTER PERFORMING THE SELF TEST, THE PRINTER IS IN HEXADECIMAL DUMP MODE AND CANNOT PRINT NORMALLY UNTIL THE POWER IS CYCLED (TURNED OFF, THEN TURNED ON AGAIN).

The output from the self test is described in the table below.

Setting	Description	Example (Actual settings may vary from examples listed below)
FW	Firmware version and date	FW: 195-170-120 V1.20
S/N	Printer serial number	S/N: P012345678
RAM, FLASH	RAM and FLASH size	RAM=18MB, FLASH=8MB
Inches Printed	Total inches printed	Inches Printed: 2911
Printhead	Printhead Designation	Printhead: KPC108_8TOA1
Printer Settings		
Aux. Power	Enable 5vdc output through Serial port	Aux. Power: OFF
Buffer Reset (1/10sec)	Enables or disables the buffer reset timer	Buffer Reset (1/10sec): 65535
Comm	Communications port configuration values (Baud, Parity, Data Bits, Stop Bits)	Comm: 9600,N,8,1,OFF
Darkness	Darkness setting of printer. First number is factory setting (not user modifiable). Second number is variable, user modifiable setting	Darkness: 0 (0)
Energy Offset	Adjusts the Energy Density	Energy Offset: 0 (0)
Feed Speed	Speed at which media is fed using the FEED button	Feed Speed : NORMAL
Index Enabled	Current state of Indexing. Either enabled or disabled (No Index)	Index Enabled
Feed Type	Current Indexing mode. GAP, BAR or Notch	Feed Type: GAP
DTBAR	Index sensor settings for Black Bar indexing in Direct Thermal print mode	DTBAR: R=56 T=13 G=0
TTBAR	Index sensor settings for Black Bar indexing in Thermal Transfer print mode	TTBAR: R=50 T=15 G=0
DTGAP	Index sensor settings for Gap indexing in Direct Thermal print mode	DTGAP: R=1 T=16 G=0
TTGAP	Index sensor settings for Gap indexing in Thermal Transfer print mode	TTGAP: R=1 T=40 G=0
DTNOTCH	Index sensor settings for Notch indexing in Direct Thermal print mode	DTNOTCH: R=20 T=5 G=0
TTNOTCH	Index sensor settings for Notch indexing in Thermal Transfer print mode	TTNOTCH: R=50 T=1 G=0
No Media (inches)	Distance (in inches) label travels before printer either attempts to recalibrate, or errors out with a red ready light. (Gap indexing mode only)	No Media (inches): 1
Pitch (dots)	Print density in dots per inch	Pitch (dots): 200
Present Label	When ON, Printer will advance and reverse distance specified below for each label printed	Present Label: ON
Advance	With PRESENTLABEL ON, the distance that a label is advanced, in hundredths of an inch	Advance: 15
Reverse	With PRESENTLABEL ON, the distance that a label is retracted, in hundredths of an inch	Reverse: 20
Print Mode	DT indicates direct thermal printing, TT indicates thermal transfer printing	Print Mode: DT (DT)
Print Speed	Displays the current printing speed setting.	Print Speed: HIGHSPEED
Report Level	Sets the manner in which the printer reports recoverable errors.	Report Level: 2
Shift left: (1/100) inches)	Distance the image is shifted to the left, in hundredths of an inch	Shift left: (1/100) inches): 0
Text Buffer:		
Size	Size of the text buffer	Size:65535
Overflow	Overflow value for the text buffer	Overflow: 1024
User Feedback	Shows the status of VARIABLE USER_FEEDBACK	User Feedback: OFF
Width	Default label width (approximate), in hundredths of an inch	Width: 425 (864 dots)
Auxiliary Language	Secondary Language Processor	Aux. Language: NONE

Chapter 3: Software Installation

Follow the CognitiveTPG Printer installation instructions at:
http://www.CognitiveTPG.com/resources_Utility.aspx for the C Series printer.

You can also follow this path: <http://www.CognitiveTPG.com> > Downloads > Utility. This process will also install the Windows drivers for the printer on your computer. Note that USB, Serial, or Ethernet connection is required for configuration via this utility.

When software installation is complete, follow the steps below to prepare your printer for normal usage.

1. Plug the printer in.
2. The Found New Hardware Wizard will appear.
3. The question "Can Windows connect to Windows Update to search for software?" will display. Select "No, not this time," and click "Next".
4. On the next screen select "Install from a list or specific location," and click "Next."
5. On the next screen select "Search for the best driver in these locations";
 - a. Un-check "Search removable media"
 - b. Check "Include this location in the search" and browse to C:\Program Files\Cognitive Solutions Printing Support\Driver Files
 - c. Click "Next."
6. At the Windows Logo testing warning, press "Continue Anyway."
7. Click "Finish."

Your printer is now ready to use. Proceed to Chapter 4 to learn how to configure and control it using the Administrator configuration tool.

Chapter 4: Using the Administrator Tool

Connect to the Printer

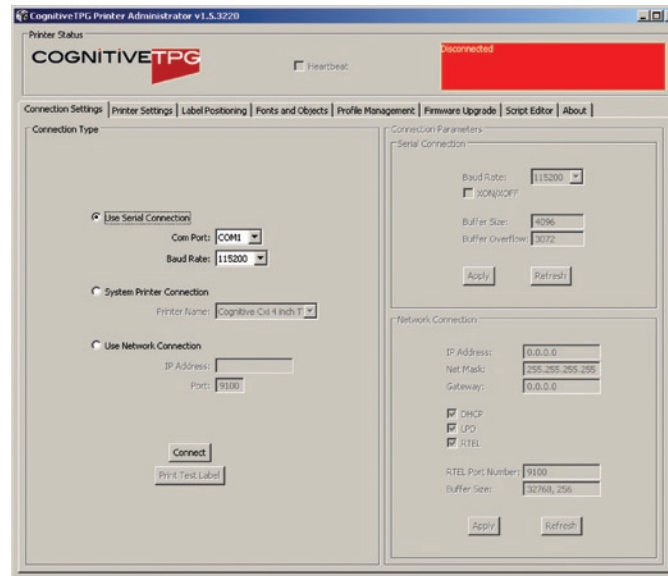

Select the connection method being used between computer and printer.

- If using serial, select the appropriate communication port and baud rate. The C Series default serial baud rate is 9600.
- If using USB, select the appropriate printer driver.

NOTE: REFER TO CHAPTER 3: SOFTWARE INSTALLATION FOR MORE DETAILS

- If using Network, select the correct IP address.

NOTE: REFER TO CHAPTER 6: NETWORK PRINTING AND CHAPTER 2: CONNECTING DATA CABLES TO THE PRINTER FOR MORE DETAILS

Once connected, the software will display the connection method in green with a “Connected” message as shown below. On the right side of the window, the printer’s settings will be displayed.

Next, print a self test label by selecting the “Print Self-Test Label” button located in the lower right of the window. This will verify connection to the printer.

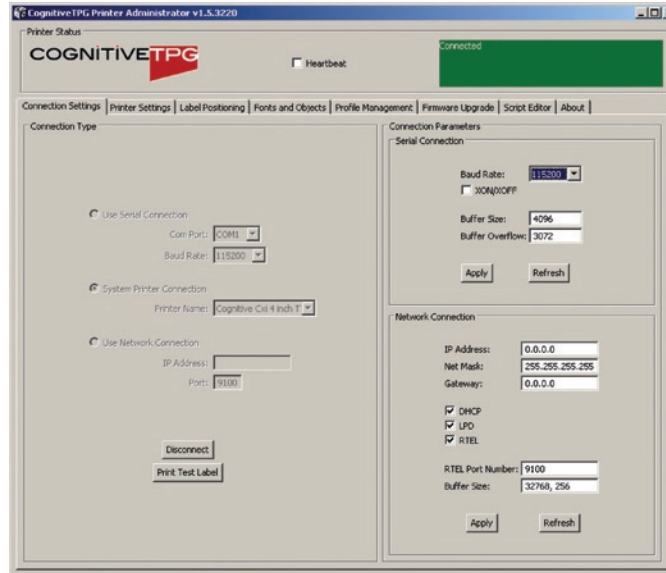

Change a Printer Setting

To change the printer's setting, select the section to change and either manually enter the new value, or select the new value from a list.

Select the Apply button to send the new setting to the printer.

Selecting the Refresh button will refresh the printer's current settings to verify the new change.

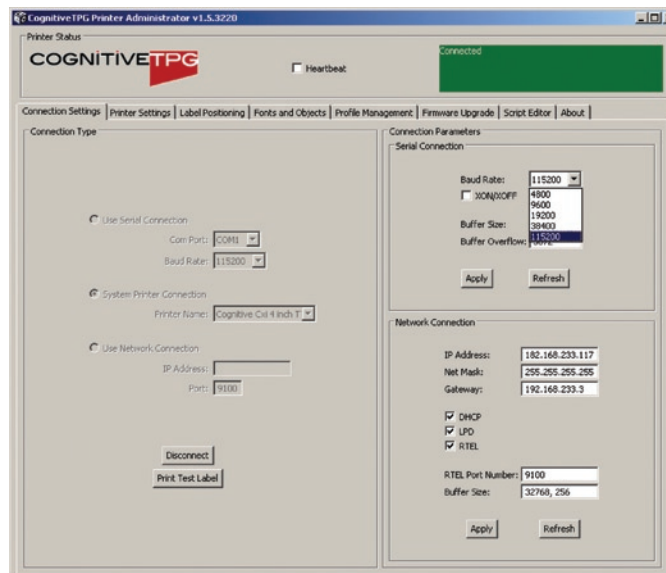

The CognitiveTPG Administrator is divided into tabs. Each tab represents different abilities that the software provides. Below is a brief description.

Connection Settings Tab

Controls Host PC to Printer communication options, Printer Serial and Network options, and Self-Test label printing.

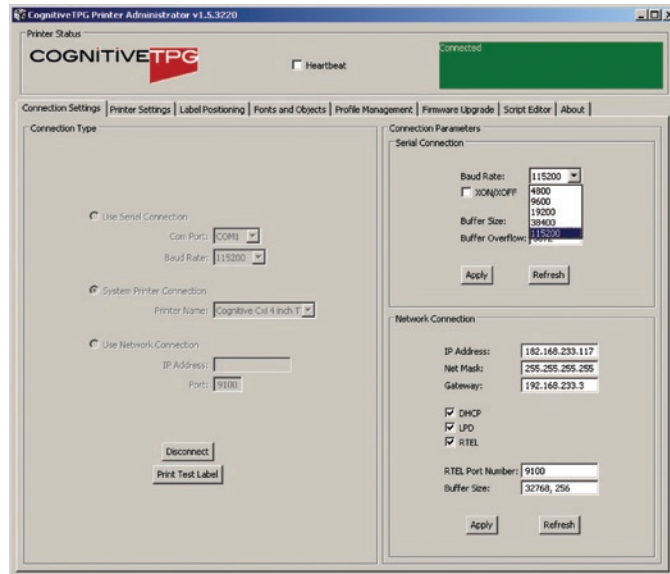

Printer Settings Tab

This tab is for settings such as thermal printing method, darkness, print speed, pitch, and real time clock settings, etc.

For more details on printer settings please refer to the CognitiveTPG Programmer's Guide installed on your computer under Start Menu | Cognitive Solutions Printing Support | Documentation. You may also download this document from: http://www.cognitivetpg.com/resources_Documentation.aspx

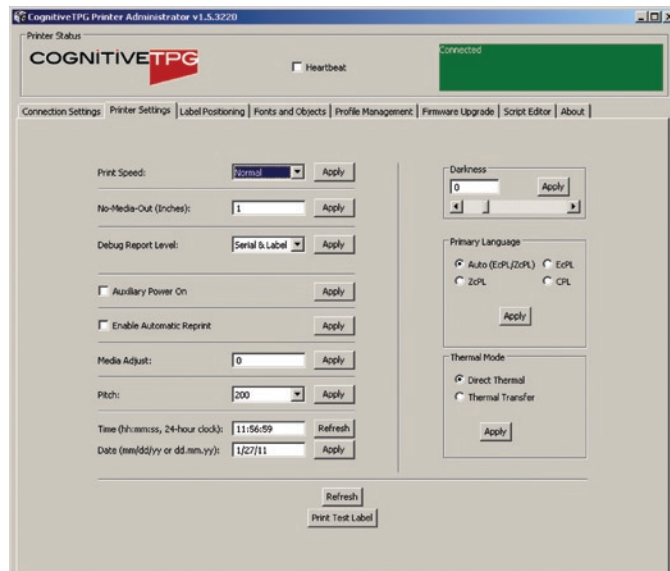

Label Positioning

The Label Positioning tab gives you control over settings that affect the position of the print-media in the printer and the position of the label image on the media. This includes setting the width of the media, the type of indexing, top-of-form, shift-left, label presentation, and calibration.

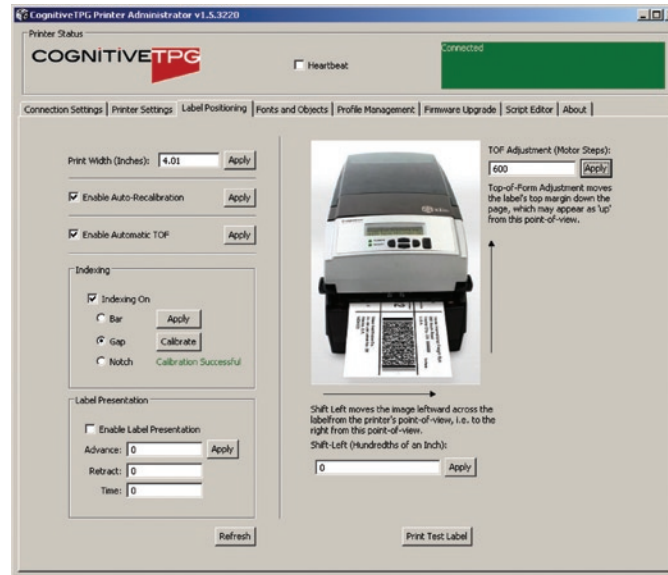

Calibrating the Printer

Calibrate the printer when the following occurs:

- Print media type changes
- Printer skips labels
- Printer feeds blank labels

CognitiveTPG recommends using Method 1 below to calibrate the printer. However, users may calibrate using any of the three listed methods below.

Method 1: Calibrate using the Administrator configuration software

In the Administrator's Label Positioning tab, find the Index Settings group of controls. Check the Indexing On check-box and select the appropriate indexing mechanism for your media (BAR, GAP, or Notch). Press Apply to save your setting, then press Calibrate to perform the calibration. The printer will respond with a 'Successful' or 'Unsuccessful'

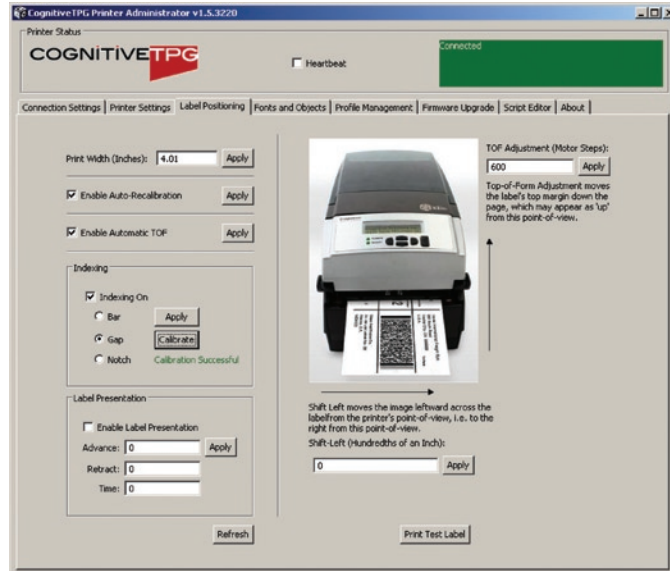

Method 2: Calibrate by Performing a Self Test (See Chapter 2 of this manual)

When the self test has finished printing the printer's default settings, the text Press Feed Switch Now to Calibrate Index prints on the media. Press the FEED button at this time to perform the calibration.

Once completed, the printer must be power cycled at this time to return to its proper printing state.

If calibration was successful, pressing the FEED button ejects only one label at a time.

Method 3: Calibrate Using Cognitive Programming Language (CPL)

Use the Administrator's CPL Editor tab (see below) to send the following commands to the printer.

```
! 0 0 0 0
VARIABLE INDEX ON
VARIABLE FEED_TYPE GAP
VARIABLE INDEX_SETTING CALIBRATE
VARIABLE WRITE
END
```

Notice the keyword GAP in the third line. This may be replaced by the keywords BAR or Notch as you need.

Fonts/Objects

View the printer's fonts, stored objects, and graphics. Deleting and loading objects are also available with this setting.

The printer will display the list of installed fonts, stored objects, and graphics.

To delete an item, highlight the item and click the Delete Selected Object button.

WARNING! IF AN ITEM IS DELETED, IT IS PERMANENTLY REMOVED FROM THE PRINTER.

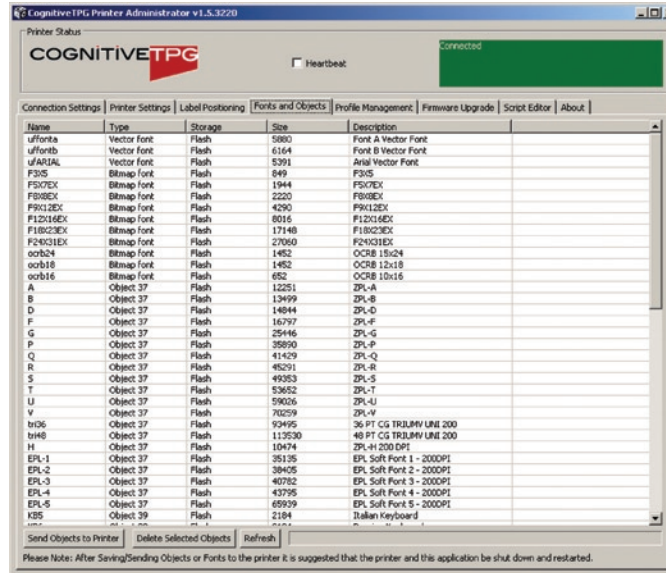

To load an item, select the Load Object to Printer button and browse to the location of the file on the host PC.

Profile Management

Profile Management provides the ability to download, save, open and apply printer profiles to printers. This is useful in updating multiple printers with the same settings.

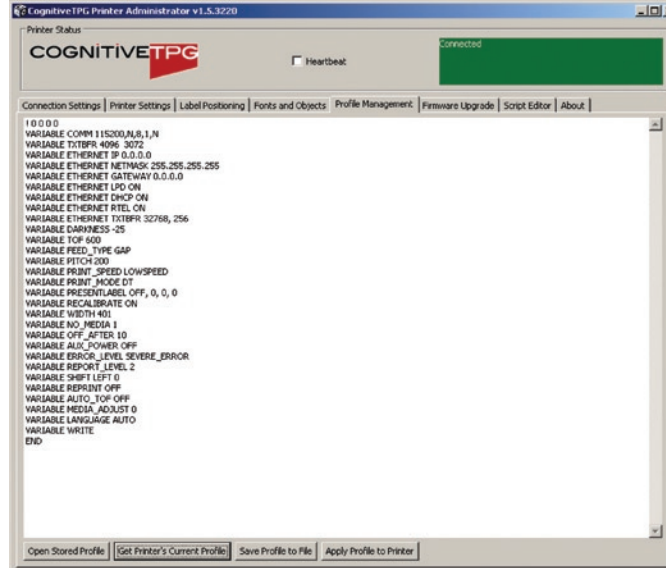

To load the printer's current profile, select "Get Current Printer's Profile". The printer will display its settings.

To save the printer's profile to a file, select "Save Profile to File". This creates a text file with a .pfl extension. This profile can later be opened and sent to other printers connected to the Administrator.

To open and previously saved file, select the “Open Stored Profile.”

To apply the displayed profile to a printer, select the “Apply Profile to Current Printer”

Firmware Upgrade

Ability to view the current firmware version as well as upgrade firmware.

The current firmware version displays automatically.

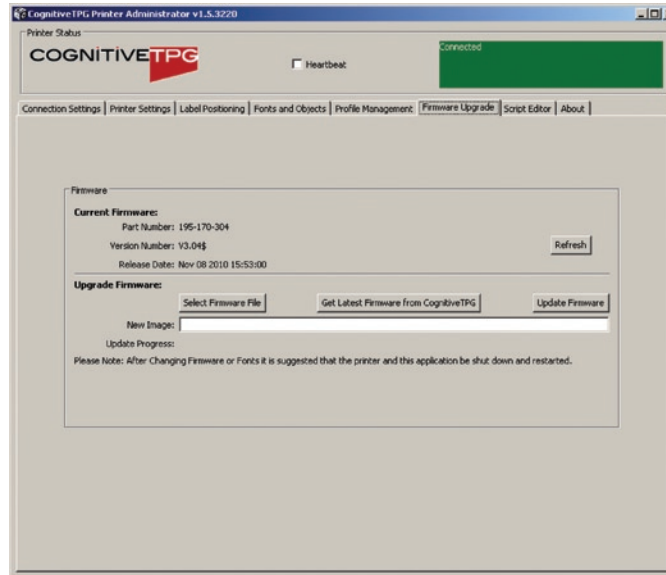

To upgrade firmware, click the Select Firmware From Local Machine button.

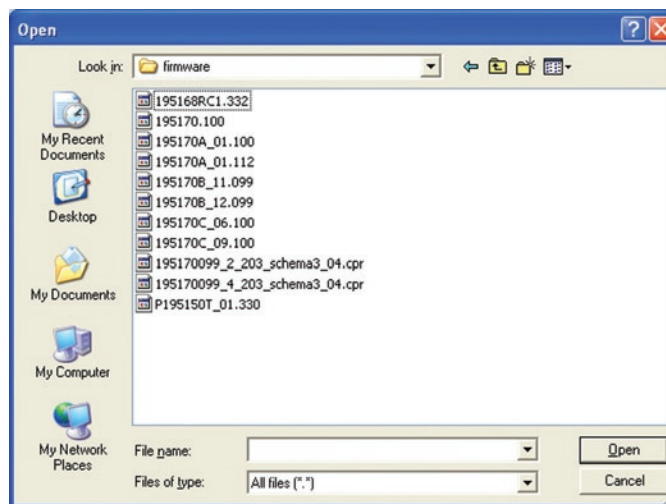

Change files of type to “All Files” and browse to the directory with the firmware. Select OK.

Select the Update Firmware button. This process can take 30 seconds to several minutes depending on connection speed. Please allow the firmware to full update.

PCL Windowing

This tab is useful only for PCL-equipped printers. It allows you to make a label out of a full-page PCL document by specifying the small region of that document you wish to print.

Since many PCL print images were designed to fit on 8-1/2"x11" paper, much of the image won't fit on a typical thermal printer label. Administrator provides a simple means of cropping the desired image area to send to your printer. Here's a quick example of how to do this:

In the "Label Window Parameters" area of the PCL Windowing page, simply enter the upper left corner coordinates of the desired windowed area you wish to print from your original image. View the page in portrait orientation when performing this operation.

Then, enter the length and width of the label you'll be using to print on with your C Series printer. A test print will appear to ensure your label size settings are correct. The box printed should fit within the edges of your label.

Test your PCL print file on the thermal printer by selecting the PCL file to be printed using the "Select PCL File" button, located in the "Print PCL File" section.

Note that Cognitive PCL is a true PCL HP5 compatible language. If the print file you're using is not compatible with PCL HP5, the print results may not be correct.

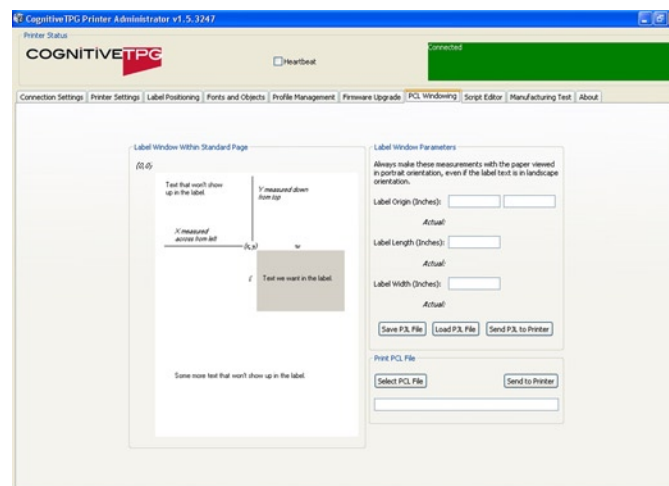

If the desired print position isn't correct, adjust the "Label Origin" values until the desired print is located correctly.

Script Editor

The CPL editor is a text editor/terminal program for communicating with the C Series printer. This editor allows the user to create, open, or save text files, and send them to the printer.

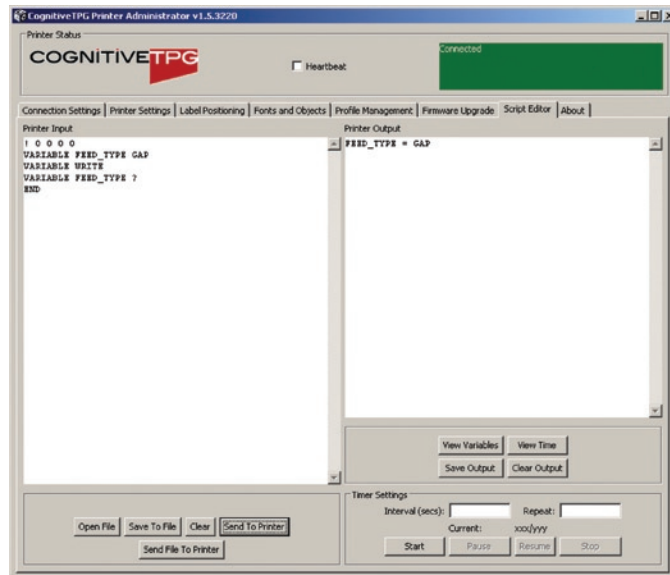

You can type commands to the printer in the Printer Input text area. You can also load commands from a file. The commands are displayed in the Printer Input text area as if you had manually typed them.

To send the data to the printer, select “Send to Printer.” Any response that the printer returns will be displayed in the Printer Indications text area.

To save any printer response, select “Save Output.”

To clear the response, select “Clear Output.”

Chapter 5: USB-A HOST

This chapter describes use of the USB-A connector (referred to as “E” below in Figure 5-1).



Figure 5-1. C Series Connections Including the USB A Host Port

Connector	Use
A – ON/OFF switch	Controls printer power
B – Power connector	Connects to power supply
C – Ethernet connector (RJ-45)	Ethernet communications port for network connectivity
D – USB-B device port	USB communications port
E – USB-A host port	USB communications port
F – Serial/Parallel port	Serial/parallel data communications port

Using USB Hubs, Keyboards and Scanners

The printer supports USB hubs, keyboards and scanners. Any USB hub, Windows™ keyboard or number pad can be used with the USB-A port. Only USB scanners that provide a keyboard-wedge interface can be used.

Keyboards and scanners can be used for menu navigation and data entry with menus and stored formats. This allows for a stand-alone application when used in conjunction with the printer’s LCD display.

Using a USB Flash Drive

This section describes use of a USB flash drive to load firmware, objects and settings to the printer using its USB-A connector. Note that the printer must be running version 1.30 or higher to load firmware and 1.40 or higher to load objects and settings. The printer loads files in the following order: 1) Settings, 2) Objects, and 3) Firmware.

NOTE: PLEASE REFER TO THE WEB SITE TO UPGRADE TO THE LATEST FIRMWARE VERSION AND USE THIS FEATURE:

http://www.cognitivetpg.com/resources_Firmware.aspx

Loading Settings Using a USB Flash Drive

This feature allows easy loading of settings. This feature is available starting with version 1.40 firmware. A settings file can contain any collection of VARIABLE commands including VARIABLE WRITE.

To load settings using the USB-A Host, follow these steps:

1. Create a folder on the flash drive at the root level named CognitiveTPG.
2. Inside this folder create a folder named Settings.
3. Copy the settings files in the Settings folder.
4. After the printer has fully booted and is displaying a ready state, insert the USB flash drive in the printer's USB-A connector.
5. The printer will load all files present in the CognitiveTPG\Settings folder.
6. Multiple files can be present in the folder.
7. Files are loaded in alphabetical order.

Loading Objects Using a USB Flash Drive

This feature allows easy loading of stored objects such as fonts, graphics, menus, and stored formats. This feature is available starting with version 1.40 firmware.

To load objects using the USB-A Host, follow these steps:

1. Create a folder on the flash drive at the root level named CognitiveTPG.
2. Inside this folder create a folder named Objects.
3. Copy the object files (fonts, formats, graphics) in the Objects folder.
4. After the printer has fully booted and is displaying a ready state, insert the USB flash drive in the printer's USB-A connector.
5. The printer will load all objects present in the CognitiveTPG\Objects folder.
6. Multiple files can be present in the folder.
7. Files are loaded in alphabetical order.

Loading Firmware Using a USB Flash Drive

This feature provides a firmware upgrade method using the USB flash drive. When the flash key is inserted, the file in the folder CognitiveTPG\Firmware is examined and used to upgrade printer firmware if it represents an upgrade. This feature is available starting with version 1.30 firmware.

To load firmware using the USB-A Host, follow these steps:

1. Create a folder on the flash drive at the root level named CognitiveTPG.
2. Inside this folder create a folder named Firmware.
3. Copy the firmware file (obtained, for example, from CognitiveTPG's Web site) in the Firmware folder.
4. After the printer has fully booted and is displaying a ready state, insert the USB flash drive in the printer's USB A connector.

5. The printer reads the file in the CognitiveTPG\Firmware folder, and determines if it contains a firmware upgrade.
6. If a firmware upgrade is needed, the printer reads the contents of the firmware file, then re-programs the printer flash memory, and finally reboots. At this time, the new firmware is loaded and executed in the C Series printer.

NOTES: THE PRINTER WILL ONLY READ THE CONTENTS OF THE USB FLASH DRIVE IF IT IS INSERTED AFTER THE PRINTER IS READY.

DO NOT MODIFY THE FIRMWARE FILE NAME AS DISTRIBUTED BY CognitiveTPG. THE PRINTER USES THE FILENAME TO KNOW WHETHER THE FIRMWARE IMAGE CONTAINED IN THE FILE REPRESENTS AN UPGRADE. CHANGING THE FILENAME WILL RESULT IN UNEXPECTED RESULTS.

TO GET CONSISTENT RESULTS, THERE SHOULD BE ONLY ONE FILE IN THE CognitiveTPG\FIRMWARE FOLDER.

IF THE FILE WILL NOT LOAD FROM THE USB FLASH DRIVE, IT MAY BE INCOMPATIBLE OR IT MAY CONTAIN FIRMWARE THAT IS EARLIER THAN WHAT IS CURRENTLY RUNNING. PLEASE VERIFY THAT THE FIRMWARE FILE CONTAINED IN THE FOLDER IS PROPER FOR THE PRINTER. IF IT STILL WILL NOT LOAD, USE THE ADMINISTRATOR CONFIGURING TOOL TO LOAD THE FIRMWARE.

Chapter 6: Network Printing

Network-enabled printers can be connected directly to a network, providing the flexibility of printing to the same printer from multiple workstations.

To configure the printer's network settings, connect to the Administrator program over a local USB or serial or parallel port. Refer to Chapter 4 for instructions on connecting to the printer using a local port.

With the Administrator communicating with the printer over a local port, select the Administrator's first tab, I/O Settings, and look at the lower-right section of the screen labeled Printer Ethernet Settings.

There are two ways to determine the printer's address on the network. One is to assign the printer an address by entering it in this settings window, and the other is to allow the network to automatically assign an address to the printer.

Assigning a Static Address

To assign a static address, first obtain an address from the network administrator. In addition to the address for the printer, the network administrator must report the proper net mask for the network and the address of the gateway for the network.

Type the printer's address in the IP ADDRESS field, type the net mask in the IP NET MASK field, and type the gateway address in the IP GATEWAY field.

Select the LPD and RTEL check boxes, and deselect the DHCP checkbox. Type 9100 in the RTEL Port Number field and type 32768 in the Ethernet Text Buffer Size field.

After typing in all the entries, click the Apply button.

The screen should look like this:

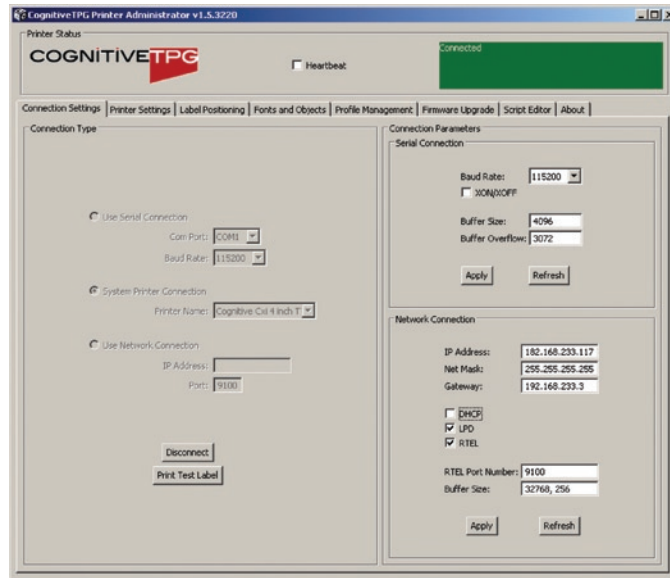

Using Automatic Address Assignment

Automatic address assignment, known as DHCP configuration, is only possible if the network being used supports it. If the network does support DHCP, put the C Series printer into DHCP mode by selecting the DHCP checkbox under the address fields in the Ethernet Settings area. It is not necessary to enter any addresses in the fields above.

In addition to the DHCP check box, select the LPD and RTEL check boxes. Type 9100 in the RTEL Port Number field and type 32768 in the Ethernet Text Buffer Size field.

For the printer to receive its address from the network, it must be connected to the network when it is turned on. If the printer is not connected to the network when set to DHCP mode, the mode setting will take effect, but the printer will not actually receive a new address until it is connected to the network and restarted.

Verifying Network Settings

When a static address was assigned or configured for DHCP, after clicking the Apply button, disconnect the Administrator from the printer, power-cycle the printer, and then connect to it once again using the USB, serial, or parallel port. Once the connection is established, the Printer Ethernet Settings fields will be populated either with the addresses entered (for static addressing) or with addresses received from the network (for DHCP configurations.) Make note of the printer's IP address.

Print a test label by clicking the Print Self-Test Label button at the bottom-right of the I/O Settings tab. The network settings are printed near the end of the test label.

Once network settings are made, disconnect printer from the USB/serial/parallel port (both physically and in Administrator). It is possible to physically relocate the printer and still be able to communicate with it as long as the printer has a network connection.

To connect to the printer using the Administrator through the network, go to the I/O Settings tab and select the Network Printer method of connection. Type the IP address assigned or received from the network, and click the Connect button. Once connected, the Administrator functions as it did with a local connection.

Configuring a Printer Driver for Network Use

To print using the driver, a new port must be configured within the printer driver.

- 1) Locate the appropriate driver in the Windows Printers folder.
- 2) Right-click on the driver and select Properties.
- 3) Click on the Ports tab.

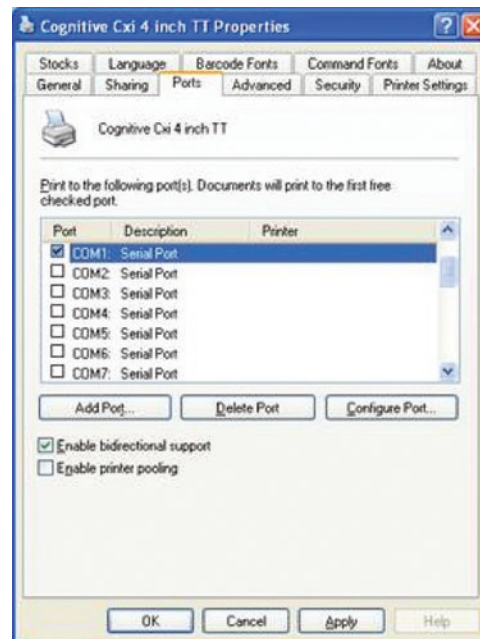

- 4) Choose Add Port.
- 5) Highlight Standard TCP/IP Port and click New Port.



- 6) Click Next.
- 7) In the Printer Name or IP Address box, enter the IP address assigned to the printer. The Port Name box is auto-populated. Click Next.

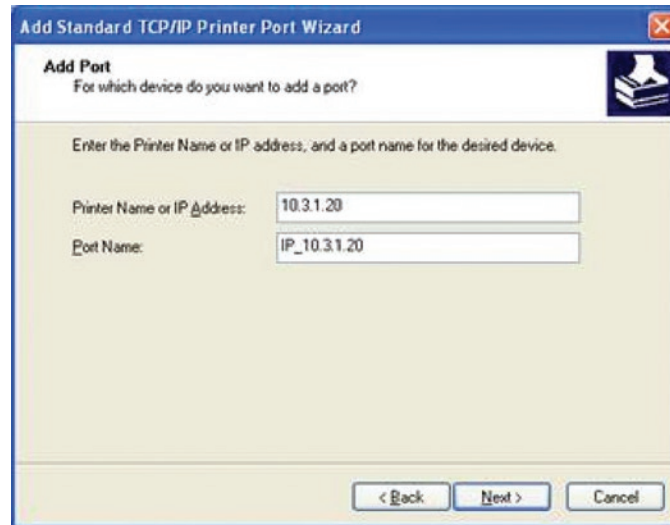

- 8) If necessary, choose Generic Network Card as shown below and then click Next.



- 9) Click Finished. The driver is now configured and ready to use.

Sharing the Printer on a Network

ASSUMPTION: IT IS ASSUMED THAT THE PRINTER IS CONNECTED TO A LOCAL MACHINE ALREADY ON A NETWORK.

- 1) Locate the appropriate CognitiveTPG Driver in the Windows Printers folder.
- 2) Right-click on the driver and select Properties.
- 3) Click on the Sharing tab.

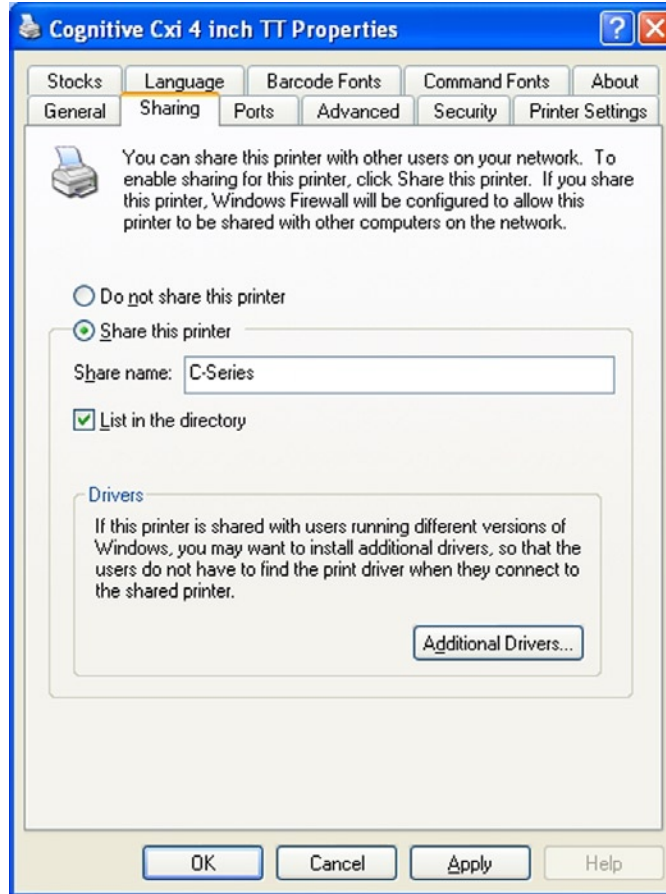

- 4) Select Share this printer and give the printer a Share name.
- 5) Once a share name has been typed, click Apply.

Network Support Materials

For more information on configuring Ethernet settings on CognitiveTPG printers, please refer to the Ethernet Printing Information section of the Programmer's Guide.

Chapter 7: Printing Standard Labels and Tags

Sources for printed label and tag data include the following:

- Label software
- CPL programming
- Third party applications or interfaces

Using Label Software

A version of NiceLabel labeling software, designed specially for CognitiveTPG printers, is available on www.CognitiveTPG.com. Please refer to Chapter 3: Software Installation. This software provides label printing and label design capabilities. Refer to the NiceLabel help files for information on how to use this product.

Using CPL Programming

A common method of printing labels is CPL programming. Commands and data are sent to the printer using the Administrator. These commands prepare the printer to receive the label, establish print position and characteristics, and terminate printing operation.

To begin, start the Administrator program and connect to the printer (see Chapter 4).

After connecting to the printer, select the CPL Editor tab and enter the following text in the Printer Input text area on the left.

```
! 0 100 100 1
WIDTH 224
PITCH 200
DRAW_BOX 20 0 200 30 2
TEXT 2 20 0 TEST LABEL
BARCODE CODE39 20 70 40 1234567894567
END
```

This series of CPL commands instructs the printer to print a simple label with text and a barcode. To print this label, after entering the text, click the Send To Printer button below the text area. The printer prints the following image.



To save this label format for future use, click the Save to File button. To reload it, or any other label format, click the Open File button.

For more detail on the CPL language, please refer to the CPL Programmers' Guide which can be found on the Web site:

http://www.cognitivetpg.com/resources_Documentation.aspx

Using Third-Party and Proprietary Applications

Labels are frequently printed from commercial software or proprietary applications.

Printing from Microsoft Word

The instructions below describe how to create both simple and complex labels using Microsoft Word software. The instructions assume the following conditions:

- The user has a basic understanding of Microsoft software and the Windows operating system
- Drivers are installed correctly
- The printer is connected, powered on, and ready to print

NOTE: EXAMPLES SHOWN HERE WERE CREATED USING MICROSOFT WINDOWS XP AND MICROSOFT WORD 2002.

To Configure the Software for a CognitiveTPG Printer

- 1) Open Microsoft Word.
- 2) Press Ctrl+P or, on the File menu, choose Print. The Print dialog box appears.

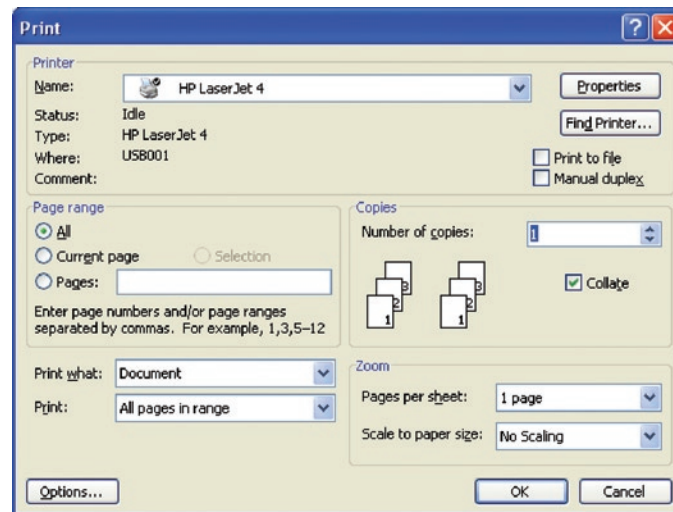

- 3) Select a CognitiveTPG printer.

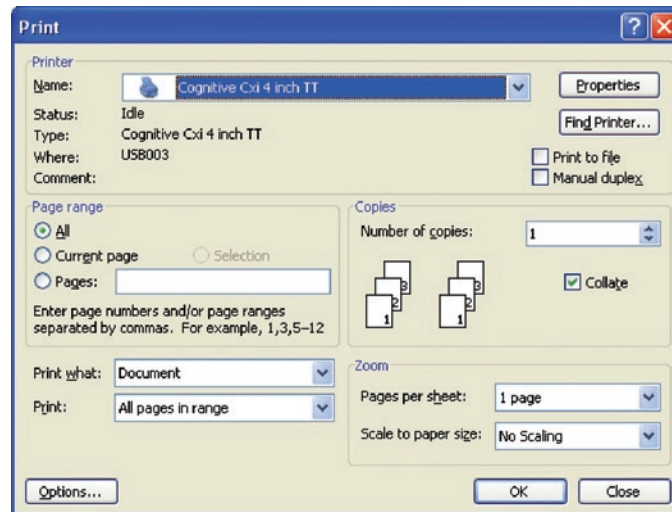

- 4) Click Close to close the Print dialog box.

Setting Label Size

Set up the Word document for the desired label size.

- 1) On the File menu, click Page Setup. The Page Setup dialog box displays.

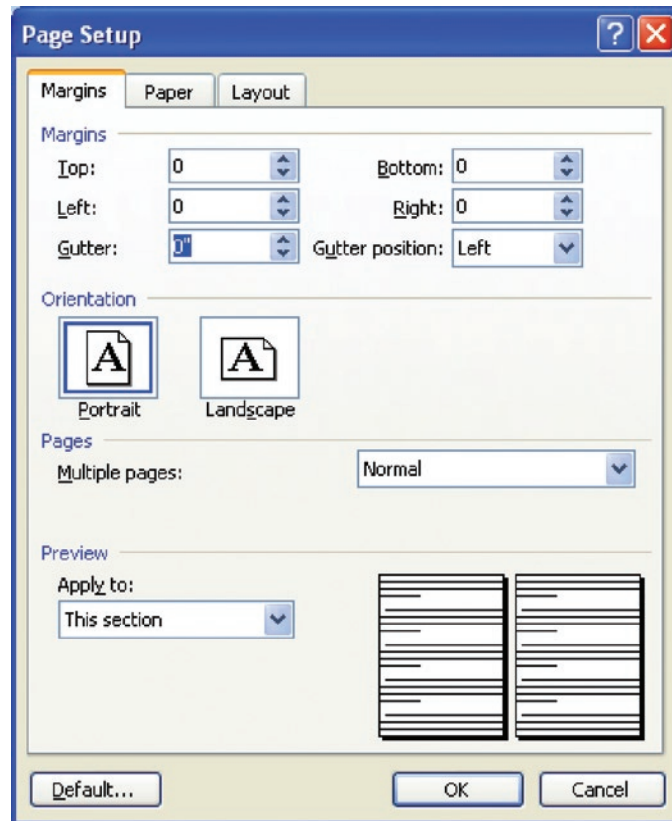

- 2) Set all margins to 0.
- 3) Click the Paper tab.

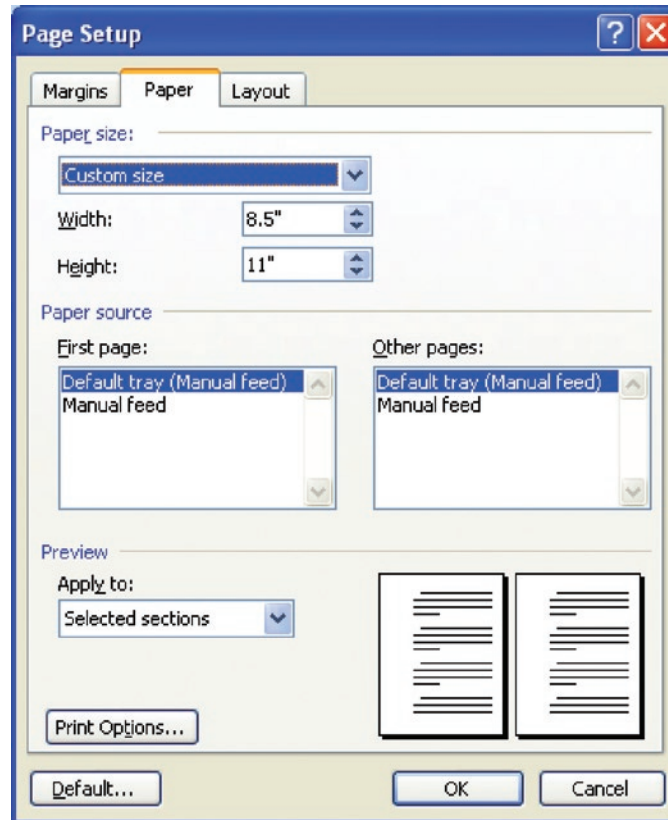

- 4) Set the correct width and height for the label. The example shows a 2.4" wide by 1" tall label.

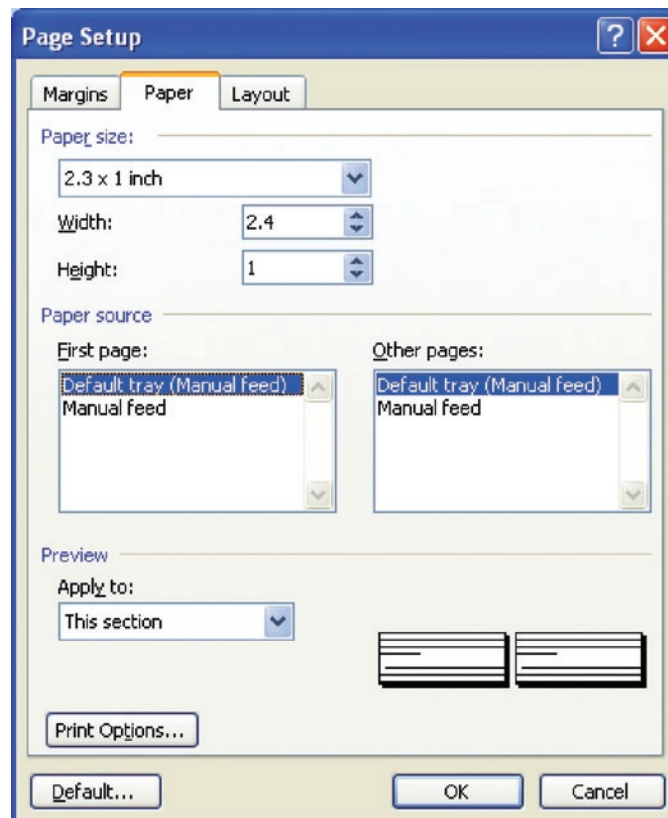

- 5) Click OK and, if necessary, Fix to reset the margins. The Word document should look similar to the figure below.

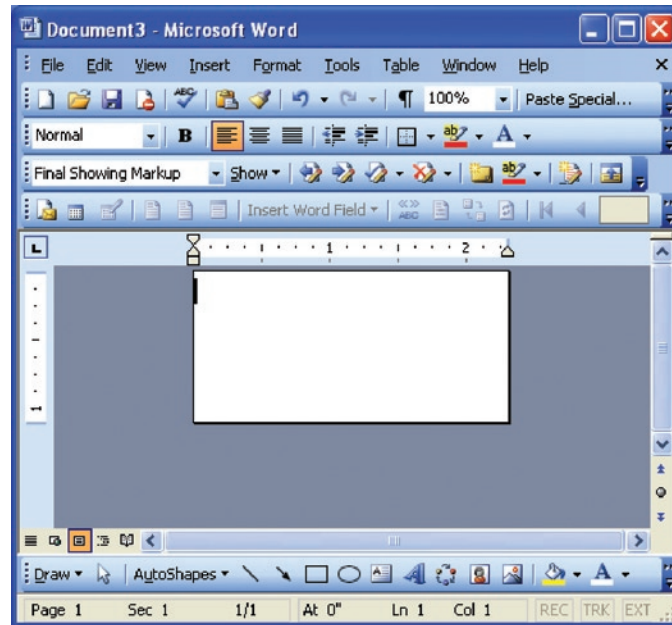

Creating a Label and Barcode

Design the label in a Word document. Use the following steps to design a barcode.

- 1) Select the desired Barcode Font/Type.

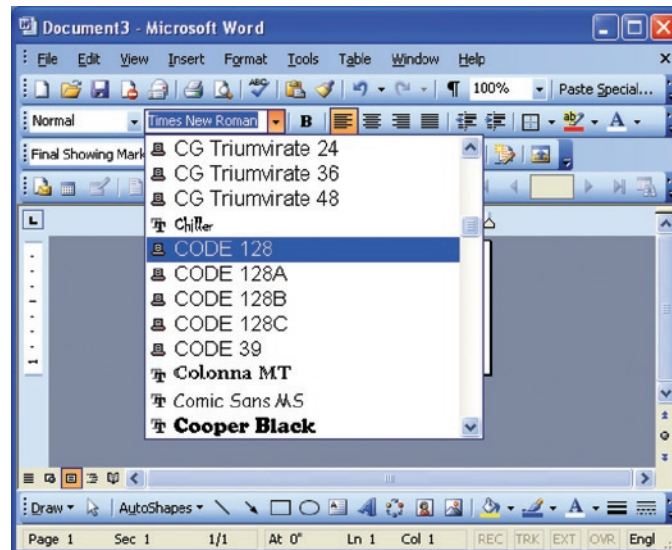

- 2) Enter the numbers for the barcode. A barcode will not display on the screen, but is printed on the label.
- 3) Set the height of the barcode by adjusting the font size. Use trial and error to adjust the size correctly.

Printing a Label

Make sure that the printer is connected to the computer and powered on. Ensure that the media is loaded correctly. Use the following steps to print the label:

- 1) Press Ctrl+P or, on the File menu, choose Print. The Print dialog appears.
- 2) Verify that the CognitiveTPG printer is selected.
- 3) Click OK.

Printing from Proprietary Applications

Refer to your software's documentation.

Chapter 8: Troubleshooting

C Series printers require minimal user maintenance. When problems do occur, however, it is important to isolate the root cause between hardware or programming issues.

Isolating Problems

Programming issues can often make problems appear hardware related. Use the following steps to determine the source of the problem.

Run a Printer Self Test

A self test will help determine possible printer hardware issues since the test is performed independently from all external software, cabling, and configurations.

To perform a printer self test please refer to Chapter 2.

NOTE: LEAVING THE PRINTER IN HEX DUMP MODE FOLLOWING A SELF TEST ALLOWS THE USER TO SEE EVERY CHARACTER THAT REACHES THE PRINTER. USE OF HEX DUMP MODE CAN HELP RESOLVE SOME PROGRAMMING PROBLEMS.

If the printer will not print a self test label, the problem is most likely hardware related and the printer will not respond to incoming data.

Please contact technical support as referenced in Chapter 9 of this User's Manual.

Print a Proven Label Format

Select a label format that has previously printed successfully on the system being used.

If the proven format will not print, inspect the system for possible communication problems. For example, ensure cables are connected properly and configuration settings are correct.

If the proven format prints successfully, then most possible hardware issues have been eliminated.

Print a New Label Format

If a known printable format is unavailable, then a new format may be created using an available text editor. Creating and sending the simple format listed below should help isolate the problem.

```
! 0 100 120 1
TEXT 2 25 25 This is a test
END
```

If the printer does not print this label but does print labels that were prepared on another system, the system being used may not be compatible with the printer. The most common cause of this is improper end-of-line termination.

“Comment Out” Portions of the Non-Working Label Format

Improper printer commands can be isolated by placing a “C” before selected CPL command lines. Begin by commenting out the most complex lines first and try printing the format again. If the problem persists, try commenting out every line between the header line and the END statement and then add lines one at a time until the problem recurs in order to see which lines are at fault.

Once the flawed portion of the format has been isolated, reference the Programmer’s Guide to examine the code for errors or test the code by itself in a simplified format. When examining label formats, look for instances where the letters “O” or “I” have been incorrectly entered for the numbers 0 and 1. These are very common typographical errors.

Common Issues

The following issues are based on technical support records of user questions.

Labels Skipping or Printer Feeding Blank Labels

Label skipping can frequently be corrected by performing a printer calibration. Refer to the calibration section of Chapter 4.

If label skipping continues to occur, inspect the label or software application to verify the page length being sent to the printer does not exceed the physical length of the label.

READY Light is Red

Make sure that the printhead mechanism is firmly latched into position on both sides.

Make sure that the printer is in the proper print mode and the correct accessories are installed. Thermal Transfer printers set to TT mode create errors when printing a label if a ribbon is not installed.

If the printer feeds out multiple blank labels, it needs to be calibrated. Refer to the calibration section of Chapter 4.

Make sure that the correct power supply for the printer is being used. The C Series printers use a 90-264VAC output power supply. The output voltage is printed on the power supply.

Printer Drivers

Printer drivers are available for download from the CognitiveTPG Web site. For more information on where to download printer drivers, please reference Chapter 3: Installing the Printer Drivers.

Setting Up an Ethernet Printer

Download the CognitiveTPG Administrator Configuration tool for easy access to setting these values. These settings can also be configured by connecting the printer to a PC using the parallel or serial port (Refer to Chapter 2 for details regarding parallel or serial port set up).

Type in the following commands to a text editor on the computer:

```
! 0 0 0 0 (Must use zero; space between each character)
VARIABLE ETHERNET IP xxx,xxx,xxx,xxx
VARIABLE NETMASK xxx,xxx,xxx,xxx
VARIABLE GATEWAY xxx,xxx,xxx,xxx
VARIABLE WRITE
VARIABLE ETHERNET RESET
END
```

Send this file to the printer by selecting File then selecting Print. The printer will not print anything but the ready light will blink on and off. Once a solid green ready light is visible, cycle the power to the printer. To verify the settings have taken effect, perform a self test and verify the settings are now set in the printer. For more instructions on performing a self test, please refer to Chapter 2 of this User's Manual.

Serial Communication

If a serial port will be used for printing to the C Series printer, a custom null-modem serial cable is required. Refer to the accessories section listed in Chapter 10 of this document.

The default serial communications settings are: 9600, N, 8, 1.

Parallel Communication

If a parallel port will be used for printing to the C Series printer, a custom uni-directional cable is required. Refer to the accessories section listed in Chapter 10 of this document.

When printing in parallel the port must be set up as an LPT port, not an ECP port. If the port is configured as ECP, printing may be inconsistent.

Printing Too Light

Download and install the C Series Administrator configuration software for simplified setting of these values from the CognitiveTPG Web site. These values may be changed using the Printhead Darkness setting located in the Printer Settings tab.

If unable to use the Administrator to configure this setting, type the following commands into a text editor on the computer:

```
! 0 0 0 0 (Must use zero; space between each)
VARIABLE DARKNESS ##
VARIABLE WRITE
END
```

The ## indicates the desired value to which the Darkness will be set. This should be a value slightly larger than the original one in order to increase the darkness.

For example, type the line as VARIABLE DARKNESS 20. Continue to gradually increase the number to 30, 40, 50, and so on until the desired darkness is achieved. The higher the number the darker the print will be.

Send this file to the printer by selecting File then selecting Print. The printer will not print anything but the ready light will blink on and off. Once a solid Green ready light is visible, cycle the power to the printer. To verify the settings have taken effect, perform a self test and verify the settings are now set in the printer. For more instructions on performing a self test, please refer to Chapter 2 of this User's Manual.

General Troubleshooting Tips

Equipment and Cabling

Make sure that all cables and connectors are installed and secure. Before printing, make sure there is media in the printer and the power and ready green lights are illuminated. If the C Series printer is a thermal transfer unit it requires ribbon to print, and a ribbon will need to be installed in the printer.

Printing a Diagnostic or Self Test Page

Please refer to the section on Performing a Self Test in Chapter 2 of this User's Manual for full detailed instructions.

Cleaning the Printhead

Refer to Chapter 11 of this User's Manual, Cleaning and Preventive Maintenance

Paper is Jammed in the Printer

Turn the printer off before attempting to un-jam the printer. If a label is jammed in the printer, unplug the printer from its power source and remove the jammed label by hand only. If needed, clean any remaining adhesive on the printer with a lint-free cloth, and 98% to 99 % pure isopropyl or denatured alcohol or a cleaning pen. Refer to Chapter 11: Cleaning Supplies for more information regarding suggesting cleaning and preventive maintenance.

Tips for Avoiding Paper Jams

Make sure the roll of media is aligned in the center of the printer and the printer's spring loaded media guides are firmly pressed against both sides of the roll.

Blank Label is Printing

Make sure all cables and connectors are installed and secure. Before printing, make sure media is loaded into the printer and both the power and ready green lights are on. If the C Series printer is a thermal transfer unit it requires ribbon to print, and a ribbon will need to be installed in the printer.

Chapter 9: Printer Specifications

Specifications are provided for reference and are based on printer tests using CognitiveTPG brand ribbons and labels. Results may vary in actual application settings or when using products other than recommended CognitiveTPG supplies. We recommend always qualifying any application with thorough testing. For updated C Series technical specifications please visit us online at:

http://www.cognitivetpg.com/specifications_16.aspx

Standard Features

- Compact Industrial™ printer design, small footprint high performance
- Administrator Configuration Software
- Bi-directional USB Drivers
- LCD control panel: Back-lit, 2 line, 16 characters (Cxi only)
- 200 MIPS, 180MHz, 32 bit RISC Processor
- 16 MB SDRAM memory
- 8 MB flash memory for firmware and stored objects.
- Hinged media cover to accommodate oversized rolls
- Double clamshell design for easy access user setup menus, easy ribbon loading and simple media loading
- Rugged die-cast metal user interface.
- Audible indicator for error warning or document alert
- Wide path indexing sensor range
- 203 dpi print resolution (8 dots/mm)
- 2" and 4" Print width models
- Upgradeable firmware and stored objects
- Direct thermal printing
- CPL programming language
- Parallel, Serial, USB-A, and USB-B communication ports
- USB-A Host Control
- Adjustable position transmissive and reflective index sensing technology to accommodate a wide variety of print media
- Printer driver for Windows™ NT, 2000, XP an Windows 7 operating systems
- NiceLabel® SE - Windows™ based WYSIWYG on-screen label design and print application demo software

Optional Features

- 300 dpi Print Resolution (12 dots/mm)
- Ethernet 10/100 Base-T interface
- Thermal Transfer Printing
- PCL (4" printers only)

Printing Specifications

Nominal Printer Size	2" Ci or Cxi		4" Ci or Cxi	
	Print Resolutions	203 dpi Standard	300 dpi Optional	203 dpi Standard
Max Print width	2.118" (53.8mm)	2.205" (56.0mm)	4.094" (104.0mm)	4.153" (105.5mm)
Print Speeds	4-6 ips Ci 4-8 ips Cxi	2-6 ips Ci 2-6 ips Cxi	4-6 ips Ci 4-8 ips Cxi	2-6 ips Ci 2-6 ips Cxi
Max Print Lengths	322" (8179mm)	218" (5537mm)	322" (8179mm)	153" (3886mm)
Print Position Tolerance	±0.0625" (1.6mm) Left and right			

Media Specifications

Media Types: Direct thermal or thermal transfer labels, tags, wristbands, static labels, and receipt paper.

Media Thickness: 0.010" thickness max.

Index types: Reflective and transmissive sensors to detect gaps between labels, die-cuts, black-marks, notches, and holes.

Media Format: Continuous fanfold (external) or roll with optional inter-sheet perforations for easy media separation.

Media Web Width (label and liner):

- 2" Printer: 0.5" (12.7mm) to 2.84" (72mm)
- 4" Printer: 2.4" (60.96mm) to 4.63" (117.6mm)
- Minimum label length: 0.375" (9.5mm) with .125" gap
- Maximum media roll size: 7.750" (194mm) O.D. on a 1.5" (38.1mm) ID. Core

Media Indexing

Indexing Sensing Methods: None, gap, bar, notch, and hole.

Gap and notch sensing standards: Minimum Inter-label gap: 0.125" (3.18mm)

Gap Sensing Width Range:

- 2" Printer: User adjustable 1" right of center to 1.2" left of center.
- 4" Printer: User adjustable from center to 2.2" left of center.

Black mark sensing standards: Black mark length (parallel to inside media edge): 0.125" (3.18mm)- 1.0" (2.54mm)

Black Mark Sensing Range: User adjustable in increments of 0.2" left and right to within 0.5" of edge of the maximum media web width.

Ribbon Specifications

Ribbon width:

- 2" Printer: 2.4" (61mm) Max.
- 2" Nominal Length: 6500" (165m) Max.
- 4" Printer: 4.25" (108mm) Max.
- 4" Nominal Length: 5500" (140m) Max.

Types: Available in Wax, Wax/Resin, and Premium Resin varieties

Label Roll Changes per Ribbon

Label Roll OD	Label Roll ID	2" Label Rolls per Ribbon Roll	4" Label Rolls per Ribbon Roll
5"	1.5"	2.4	2
7"	1.5"	1	.85

7" Label Roll OD = equivalent to 8" Roll

Font Specifications

Bitmapped: 7 styles with up to 10x10 magnification, variable boldness and spacing.

International AGFA Fonts: Sans-serif font in 7 pt. sizes, up to 4x4 magnification, variable boldness and spacing.

Scalable Vector Fonts: 3 ultra font styles for smooth characters in any size and boldness.

Rotations: 0, 90, 180, 270 degrees

Bar Code Symbolologies and Specifications

UPCA	ADD 2	EAN 8	128C
UPCE	ADD 5	EAN 13	CODE128
UPCE1	CODE 39	PLESSEY	EAN128
POSTNET	I 2OF5	128A	CODABAR
Maxicode mode 0	CODE 93	128B	MSI
PDF417	DataMatrix	QR Code	Aztec
UPCA+	MSI1	S20F5	D20F5
RSS			

Cognitive Programming Language (CPL)

- Communicates in printable ASCII characters
- Compatible with mainframe, mini, and PC hosts
- Downloadable objects include graphics and bitmap fonts
- Automatic serialization of fields
- Format inversion (white on black)
- Four position field rotation (0°, 90°, 180°, 270°)
- Programmable label quantities with print and pause control
- Status messages to host upon request

Communications Specifications

Parallel Interface: Centronics compatible parallel interface (requires cable).

High-speed serial interfaces:

- Serial RS-232 (requires cable)
- Configurable baud rate (1,200 – 115,200 baud), parity, and data bits. Stop bits at 1 or 2.
- Software (XON/XOFF) or hardware (DTR/DSR) communication handshake protocols
- USB 2.0 compatible interface
- Ethernet 10/100 Base-T interface (Optional)

Electrical Specifications

- Auto-detectable 90-264VAC, 24VDC 150W power supply

International Environment Compliance

- Compliant with the following international environmental directives:
- Directive 2002/95/EC on the restriction of Use of certain Hazardous Substances in Electrical and Electronic Components (RoHS)
- Directive 2002/96/EC on Waste Electrical and Electronic Equipment (WEEE)

International Regulatory Compliance

- Printer and Power Supply: UL, FCC Class A, CCC, CE, CiSPR22/CB.
- Power Supply Only: CSA GS/TUV/VDE/PSE

Environmental Specifications

Operating environment: 41° to 104°F (5° to 40°C) 20% to 85% non-condensing R.H.

Physical Specifications

Characteristic	2" Ci or Cxi Printer	4" Ci or Cxi Printer
Height	7.1" (181mm)	7.1" (181mm)
Width	5" (127mm)	6.9" (175mm)
Depth	10.04" (255mm)	10.04" (255mm)
DT Weight	5.02 lbs (Cxi) 4.91 lbs (Ci)	5.91 lbs (Cxi) 5.88 lbs (Ci)
TT Weight	5.23 lbs (Cxi) 5.00 lbs (Ci)	6.10 lbs (Cxi) 6.00 lbs (Ci)

Software

C Series Administrator: Printer with USB/Serial bi-directional configuration software, included with printer requires Windows driver installation.

C Clean Driver Utility: Self contained driver cleanup utility that entirely removes old drivers.

Windows™ OS Drivers: Printer drivers that allow applications running on Windows operating systems to print to CognitiveTPG printers.

Preventive Maintenance

CognitiveTPG recommends cleaning the printer on a regular basis using standard CognitiveTPG printer parts and cleaning supplies.

Cleaning

The exterior is cleaned with a lint-free cloth, and if necessary, a mild detergent solution in a damp cloth. It is recommended that interior components are cleaned with the authorized cleaning supplies listed below every 20,000 inches (508 m) or blown air to remove any particles. The printhead should be cleaned every 5000 inches if preprinted labels are used. The platen should be cleaned at the same interval, using the same cleaning materials as applied to the printhead. Please refer to Chapter 11 for more details on cleaning supplies.

Warranty

Printer: 24 months from date of purchase. (requires registration and excludes printheads)

Printhead: 6 months or 500,000 inches using CognitiveTPG's approved media

MTBF (Mean time between failures): 2,000,000 inches (Does not include printhead dots out condition)

Chapter 10: Consumables

Please refer to the online Media Guide for more information on consumables which are compatible with all C Series printer models.

Compatible Media

CognitiveTPG stocks a wide variety of labels, tags and ribbons for use in our thermal printers. Items range from paper labels to tags in various sizes. If the standard items will not fit your application needs, we offer custom options for CI/CXI-compatible labels and tags.

CognitiveTPG offers a full range of printing capabilities, from sequential numbering and barcodes to full-color labels. We use only the highest-quality facestocks and adhesives, and we also stock a wide range of paper, cardstock, and synthetic/film materials for thermal printers, along with specialized materials. Our adhesives range from super-aggressive to ultra-removable, plus specialty adhesives that can withstand extreme.

CognitiveTPG has a full selection of inks and specialty dyes that can be matched to any color with superior lamination and varnish options.

Ribbons

To learn more about the various ribbon types, please refer to our online Media Selection Tool at: <http://www.cognitivetpg.com/mediaselector.aspx>

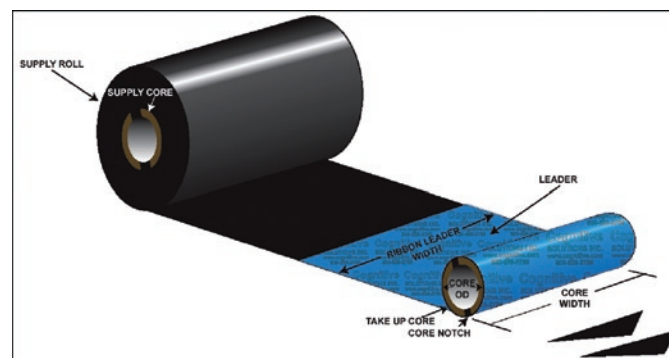

Figure 10-1. Ribbon Spec Diagram

- Wax ribbons are best for general purpose labeling.
- Wax/resin ribbons are a good choice for moderate scratch, abrasion and mild chemical resistance.
- Resin ribbons provide the best performance in harsh environmental conditions.

Width (Inches)	Length (Inches)	Formulation	Printer Compatibility	Stock item	Part #
2.4	5512	Wax	Del Sol/ C Series	Y	04-00-0044-01
4.25	5512	Wax	Del Sol/ C Series	Y	04-00-0041-01
2.4	6500	Wax	C Series	Y	04-00-0046-01
2.4	5512	Wax / Resin	Del Sol/ C Series	Y	04-00-0044-03
4.25	5512	Wax / Resin	Del Sol/ C Series	Y	04-00-0041-03
2.4	6500	Wax / Resin	C Series	Y	04-00-0046-03
2.4	5512	Premium Resin	Del Sol/ C Series	Y	04-00-0044-02
4.25	5512	Premium Resin	Del Sol/ C Series	Y	04-00-0041-02
2.4	6500	Premium Resin	C Series	Y	04-00-0046-02

Accessories

For more details on C Series accessories please visit our Web site under the C Series product page at: http://www.cognitivetpg.com/Accessories_16.aspx

For more details on CognitiveTPG cleaning supplies please refer to Chapter 12 of this User's Manual.

C Series Accessories

Product Model #	Description	2"	4"	DT	TT
370-006-01	Auto-Ranging power supply, UNIVERSAL, 100-240 VAC, 70W	✓	✓	✓	✓
006-1030000	US Power Cord (compatible w/370-006-01 power supply)	✓	✓	✓	✓
115-005-01	Cable USB A Male 2.0 to USB B Male 2.0,HS	✓	✓	✓	✓
115-008-02	Parallel cable	✓	✓	✓	✓
115-006-02	Serial cable 6'	✓	✓	✓	✓
115-007-02	Serial adapter (for 5VDC)	✓	✓	✓	✓
470-054-01	2" Spindle, Large Media Roll	✓		✓	✓
470-055-01	4" Spindle, Large Media Roll		✓	✓	✓
470-064-01	3" Adapter Cores for Large Media Rolls	✓	✓	✓	✓
006-1030003	Power Cord, European, C-Series	✓	✓	✓	✓
006-1030005	Power Cord, UK, C-Series	✓	✓	✓	✓

Chapter 11: Cleaning and Preventive Maintenance

The C Series printer is designed to provide exceptional service with a minimum of preventive maintenance. CognitiveTPG recommends cleaning the printer on a regular basis using standard CognitiveTPG printer parts and cleaning supplies.

Cleaning Instructions

C Series Cleaning Supplies

Part #	Size (inches)	Items per box	Description
14-00-0002	none	12	Cleaning pen

Exterior is cleaned with a lint-free cloth and, if necessary, a mild detergent solution.

Interior components (printhead, platen roller, media sensor, peel bar, ribbon, and media paths) are cleaned with a 98% to 99 % pure isopropyl or denatured alcohol or a cleaning pen every 20,000 inches (508 m) or blown air to remove any particles. The printhead should be cleaned every 5,000 inches if pre-printed labels are used.

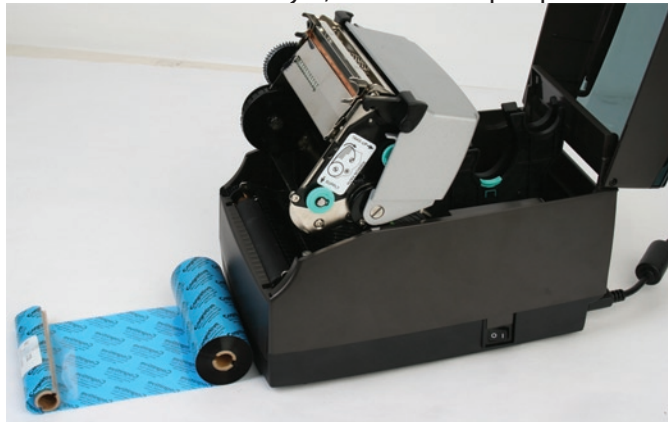

Figure 12-1. C SERIES Performing Printer Maintenance

- 1) Open the print mechanism. Turn the printer off when cleaning the printhead. Make sure the printhead is completely dry before turning the printer back on.

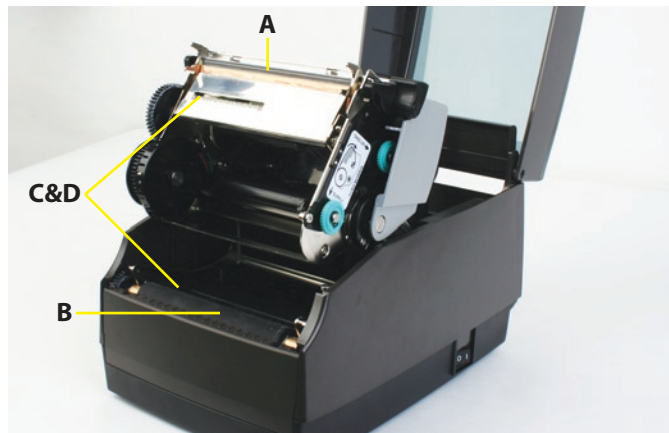

Figure 12-2. Cleaning the C Series Printer Parts

- 2) Clean the printhead (A), platen (B), and the index sensors (C and D) with a soft, lint-free cloth saturated with 99 percent isopropyl alcohol.
- 3) Turn the printer on and press the FEED button to clean all sides of the roller.

CAUTION! INCORRECTLY CLEANING THE PRINTER WILL CAUSE PERMANENT DAMAGE AND VOID THE PRINTER'S WARRANTY. CognitiveTPG RECOMMENDS USING A CERTIFIED CLEANING PEN FOR ALL THE PRINTER'S CLEANING REQUIREMENTS.

Please refer to Chapter 12 for technical support contact information and to find an authorized repair center near you.

Printhead Assembly Removal and Replacement

NOTE: IF THE C SERIES PRINTER IS WITHIN THE WARRANTY PERIOD, THE USER MUST SEND THE PRINTER IN TO AN AUTHORIZED REPAIR CENTER. ALL USERS MUST NOT REPLACE THE PRINthead ASSEMBLY OR PLATEN ASSEMBLY IF THE PRINTER IS UNDER WARRANTY.

Printhead Assembly Removal

- 1) Open the User Interface Cover and carefully cut the cable tie located on the right-hand side of the printhead bracket.



- 2) Remove the printhead assembly from the mechanism by lifting the left side printhead bracket tab off of the mechanism platform as shown.



- 3) Remove the screw holding the green ground wire to the bracket.



- 4) Remove the printhead cable harness from the printhead, and remove the two-wire LED harness from the LED connector.

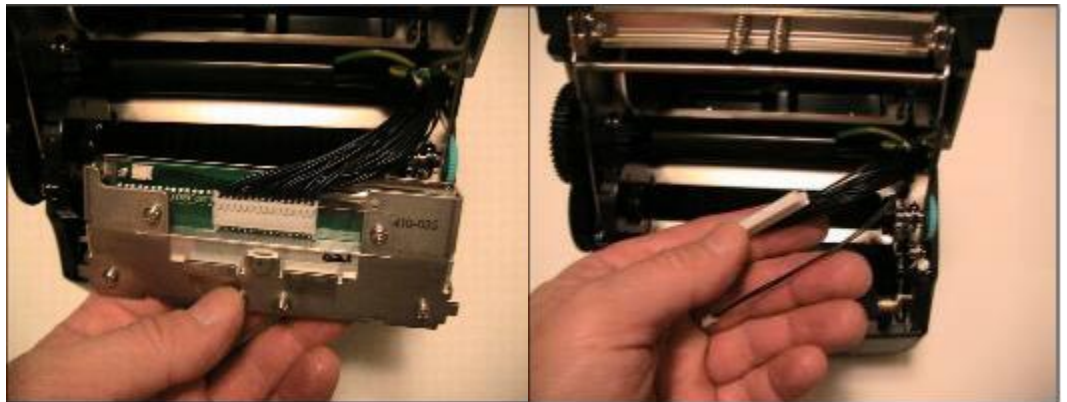

Printhead Assembly Replacement

NOTE: IF THE C SERIES PRINTER IS WITHIN THE WARRANTY PERIOD, THE USER MUST SEND THE PRINTER IN TO AN AUTHORIZED REPAIR CENTER. ALL USERS MUST NOT REPLACE THE PRINthead ASSEMBLY OR PLATEN ASSEMBLY IF THE PRINTER IS UNDER WARRANTY.

- 1) Attach the new printhead assembly to the printhead harness, and attach the LED harness to the LED connector.



- 2) Position a cable tie through the hole in the printhead bracket and around all wires.



- 3) Position and tighten the tie as shown. Clip off the excess tie.



- 4) Secure the ground wire to the bracket, ensuring that the lock washer is between the wire lug and the bracket shield. Tighten the screw to 3 in-lbs.



- 5) Position springs over spring guides on bracket, then slide the right printhead bracket support tab over the mechanism right side printhead support platform feature.

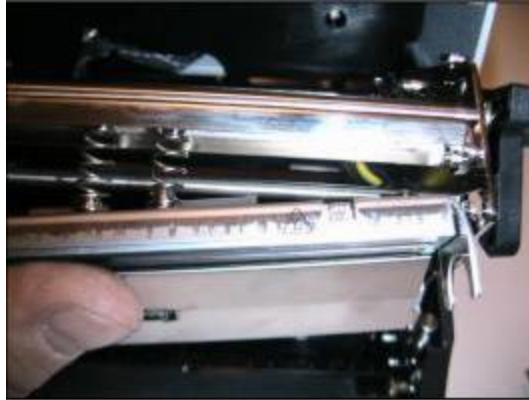

- 6) Keeping the right side tab on the platform, rotate the left side of the printhead forward so that it clears the left side printhead platform support.



- 7) Push the printhead up and back to position the left side printhead bracket support tab on the left side platform.



- 8) Ensure the printhead has free movement by pressing up in the center of the printhead assembly. The printhead assembly should move freely and evenly until the springs are fully compressed. If not, check the cabling for any binding during printhead movement.



Platen Assembly Removal and Replacement

NOTE: IF THE C SERIES PRINTER IS WITHIN THE WARRANTY PERIOD, THE USER MUST SEND THE PRINTER IN TO AN AUTHORIZED REPAIR CENTER. ALL USERS MUST NOT REPLACE THE PRINthead ASSEMBLY OR PLATEN ASSEMBLY IF THE PRINTER IS UNDER WARRANTY.

Platen Assembly Removal

- 1) Remove the front bezel by removing the two screws at the front, center, underside of the printer.



- 2) Slightly spread the enclosure away from the side of the bezel. Then, lift the bezel up and away from the printer.



- 3) Remove the three screws indicated.



- 4) Remove two screws at the rear of the printer.



- 5) Remove media guides by removing the four screws holding down media guide bottom plate.



- 6) Remove media guide gear and set aside. Unscrew 2 screws exposed after guides were removed.



- 7) Locate and remove screw behind head down switch on right side of mechanism.



- 8) Spread enclosure apart slightly, then lift enclosure back and up, away from printer. To access base portion of enclosure, refer to Mechanism Repair and GMC Repair in the repair guide. Remove both mechanism and GMC to access base enclosure.

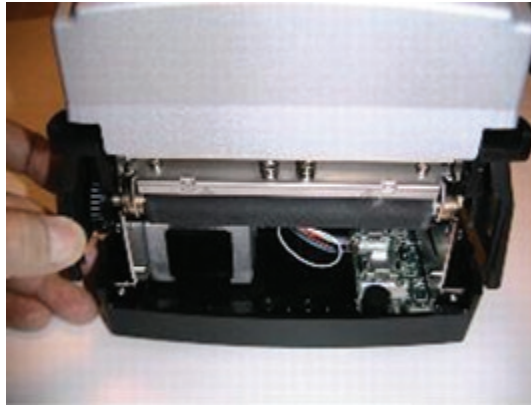

- 9) Remove front bezel. See front bezel removal section of enclosure removal section.



- 10) Slide right side platen bearing past its plastic snap, toward front of printer.



- 11) Slightly bias the enclosure away from the left side of the platen. Slide the left side of the platen out of its plastic snap, toward the front of the printer.



CAUTION: BE CAREFUL NOT TO LOSE THE BEARING FROM THE RIGHT SIDE OF THE PLATEN. THERE ARE NO RETENTION FEATURES WHICH WILL HOLD THE BEARING ON THE PLATEN SHAFT AFTER THE PLATEN HAS BEEN REMOVED.

Platen Assembly Replacement

NOTE: IF THE C SERIES PRINTER IS WITHIN THE WARRANTY PERIOD, THE USER MUST SEND THE PRINTER IN TO AN AUTHORIZED REPAIR CENTER. ALL USER'S MUST NOT REPLACE THE PRINTHEAD ASSEMBLY OR PLATEN ASSEMBLY IF THE PRINTER IS UNDER WARRANTY.

- 1) During installation of the platen, note the small diameter of the platen bearing snap feature. That area goes down into the platen bearing snaps.



- 2) Slightly bias the enclosure away from the left side of the platen. Slide the left side of the platen into its plastic snap.

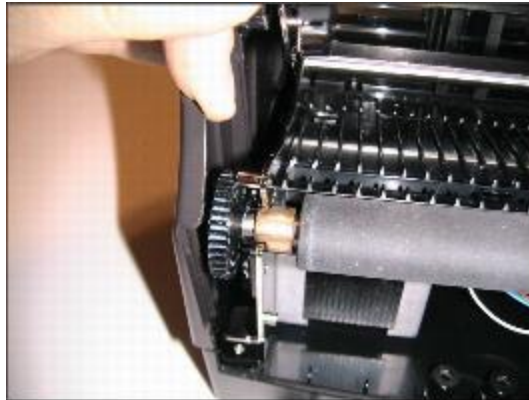

- 3) Slide right side platen bearing into its plastic snap. Ensure platen rotates in its bearings. There will be a small amount of resistance due to gears and motor.

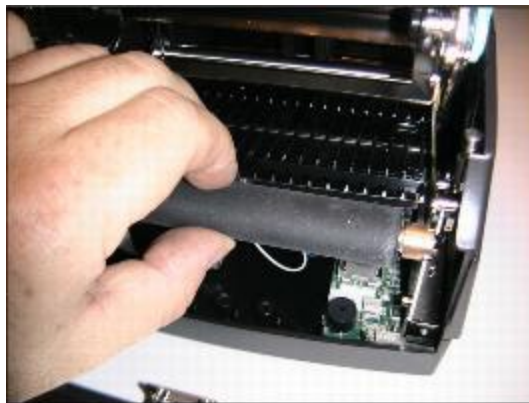

- 4) Install front bezel according to bezel installation section of enclosure document.



- 5) Slightly spread the front of the enclosure, and begin sliding it forward on the base. Ensure that the green ground wire shown at right is placed in the cavity of the enclosure as shown.

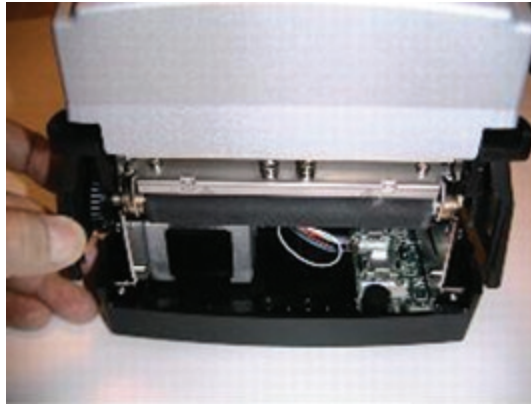

- 6) Ensure that the enclosure on-off switch tab is above the on-off switch as shown. That will help properly locate the enclosure on the base. Check the fit of the enclosure to the base. The User Interface Cover should rotate freely. That indicates proper location of the enclosure.



- 7) Install and torque the two screws shown at right. Torque to 2.5 in.-lbs.



- 8) Install and torque the mechanism screw located on the right side of the mechanism, behind the head down switch. Torque to 3 in.-lbs.

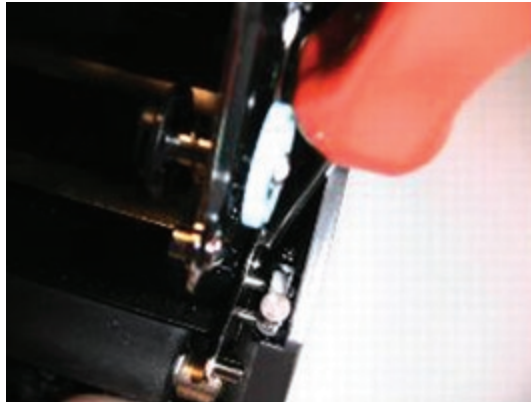

- 9) Expose the underside of the printer, install and torque the three screws at the locations shown. Torque to 3 in.-lbs.



- 10) Install and torque the two rear screws as shown.



11) Slightly separate the enclosure, and install the front bezel.



12) Snap the enclosure into position, and ensure a good fit between both sides of the enclosure and the front bezel.



13) Install and tighten the two bezel screws as shown. Torque to 3 in.-lbs.



Chapter 12: Support

Contacting Customer Support

If technical assistance is required for the C Series printer and the troubleshooting suggestions in this guide or our online Tech Support Tool (<http://www.cognitivetpg.com/techsupportpub.aspx>) do not solve the issue, please refer to the following support services to obtain assistance.

Telephone Technical Support

During the warranty period, please obtain assistance from our Service Center.

Service and Repair: Hours: 8AM-5PM Mountain Standard Time (MST).

Toll Free: 800.732.8950 ext. 4

Telephone: 607.274.2500 ext. 4

E-Mail: Support@CognitiveTPG.com

The Technical Support Team can answer questions regarding the setup, configuration, installation, and operation of the C Series printer. They can also help troubleshoot and diagnose printer problems and give instructions for service and repair.

For printers not covered under warranty, please contact the Service Center for a free repair estimate.

Finding Help on the Web

The CognitiveTPG Web site provides tips, tricks, and troubleshooting information for all CognitiveTPG printers, including the C Series printers.

Visit www.CognitiveTPG.com to find setup and firmware information for your specific C Series printer model.

Index

A

Accessories 70
Administrator 36
Automatic Address 49

B

Barcode 57

C

Cleaning 71
Communications 67
Compatible Media 69
Connectors 10
Controls 10
CPL Programming 53
Customer Support 85

D

DHCP 49
Dust cover 2

E

Ethernet connector 4

F

FEED 10
Firmware 42

H

Help on the Web 85

I

Index Sensor 6
Indicators 10

K

keypad button functions 7

L

Label Software 53
Large Roll OD Media 27
LCD control panel 2
LCD Menu Structure 8
Loading Media 21

M

Media Guide 3
Media Guide Locking Tab 23
menu navigation 7
Microsoft Word 54

N

Network Support Materials 52

O

ON/OFF switch 2
operational requirements 9

P

Platen 6
POWER LED 2
Printer Power Test 13
Printer Requirements 9
Printer Set Up 9
Printhead 3
Programmer's Guide 1

Q

Quick Start Guide 1

R

READY LED 2
Ribbon drive gears 3
Ribbon Loading 14
Ribbons 69
Ribbon Supply Core Notches 17

S

Self Test 32
Software Installation 35
spindle slot 3
Static Address 48
Supply Clutch 5
Supply Spindle 5

U

USB-A 11
USB-B 4