

Coaxial High Power Amplifier

ZHL-5W-422+

50Ω 5W 500 to 4200 MHz



ZHL-5W-422+



ZHL-5W-422X+

The Big Deal

- Very wide bandwidth, 500 to 4200 MHz
- High power, 5W
- Flat gain, ± 1.0 dB
- High efficiency, 30% typ. at saturation
- Built-in overvoltage and over-temperature protection

Product Overview

The ZHL-5W-422+ is a Class A, high-power amplifier providing very wide bandwidth for a broad array of military, commercial and testing applications. Excellent flatness across its entire operating frequency range makes it ideal for systems where consistent performance across frequency is required. The amplifier provides high-efficiency while withstanding open and short loads under full CW output power. The unit is unconditionally stable and features robust protection from high temperature extremes, overvoltages, and reverse polarity errors, making it suitable for demanding lab environments, satellite communications, line-of-sight links, defense applications, radio and television broadcast transmissions and more. Housed in an aluminum alloy case measuring 9.85 x 7.3 x 6.4", it features SMA connectors at both ports and an optional heat sink and fan for cooling.

Key Features

Feature	Advantages
Very wide bandwidth	Supports a broad range of system and test lab applications.
Flat gain, ± 1 dB	Provides consistent performance across frequency, minimizing the need for external equalizing networks in wideband applications.
High efficiency, 30% typ. at saturation	Delivers 5W output power with low DC power consumption for reliable, cost-efficient performance.
Built-in self-protection	In instances of potentially-damaging excessive drive current, heat buildup within the housing, unshorting of DC supply, and short or open loads at the output, an automatic sensing feature signals the unit to power down.
Unconditional stability	Provides reliable performance independent of input and load conditions.

Coaxial High Power Amplifier

ZHL-5W-422+

50Ω 5W 500 to 4200 MHz

Features

- High power, 5 Watt
- Excellent IP3, +45 dBm typ.
- Excellent IP2, +55 dBm typ.
- High efficiency, 30% typ. at saturation
- Class A amplifier
- No damage with an open or short output load under full CW output power¹
- Shuts off when base plate temperature exceeds +85°C
- Over voltage protection, shuts off above 35V
- Reverse Polarity Protected
- Unconditionally stable

Applications

- Transmitters
- Defense
- Amateur radio, FM, TV
- Laboratory use



Model No.	ZHL-5W-422+	▲ZHL-5W-422X+
Case Style	BT1896	
Connectors	SMA	

+RoHS Compliant

The +Suffix identifies RoHS Compliance. See our web site for RoHS Compliance methodologies and qualifications

Electrical Specifications at 25°C

Parameter	Condition (MHz)	ZHL-5W-422+ ▲ZHL-5W-422X+			Units
		Min.	Typ.	Max.	
Frequency Range		500	—	4200	MHz
Gain ³	500 - 4200	20	25	—	dB
Gain Flatness ³	500 - 4200	—	±1.0	±1.7	dB
Output Power at 1dB compression	500 - 4200	+34	+35	—	dBm
Output Power at 3dB compression	500 - 4200	+36	+37	—	dBm
Noise Figure	500 - 4200	—	7	12	dB
Output third order intercept point ²	500 - 4200	+40	+45	—	dBm
Output second order intercept point ²	500 - 4200	+50	+55	—	dBm
Input VSWR ³	500 - 4200	—	1.7	2.3	:1
Non-Harmonic Spurious at Pout=5W	500 - 4200	—	—	-60	dBc
Second and Third Harmonics at Pout=2.5W	500 - 4200	—	—	-20	dBc
DC Supply Voltage		—	28	30	V
Supply Current ⁴		—	2	3	A

1. At constant open or short load 28V nominal supply voltage
2. Measured with 2 tones, 1 MHz apart, +20 dBm/tone
3. Measurements with small signal, Pin=-15dBm input
4. Power supply should be capable of delivering 6A at start up.

▲ Heat sink and fan not included. Alternative heat sinking and heat removal must be provided by the user to limit maximum base-plate temperature to 85°C, in order to ensure proper performance. For reference, this requires thermal resistance of user's external heat sink to be 0.3°C/W max.

Maximum Ratings

Parameter	Ratings
Operating Temperature	-20°C to 50°C
Storage Temperature	-55°C to 100°C
Base Plate Temperature	85°C
Input RF Power (no damage)	+20 dBm

Permanent damage may occur if any of these limits are exceeded.

Outline Drawing for models with heatsink

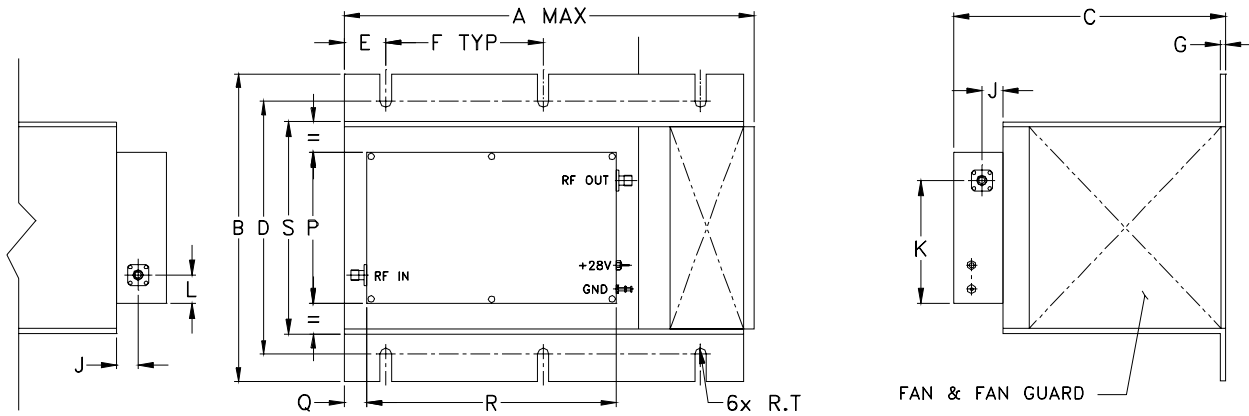

Outline Drawing for models without heatsink

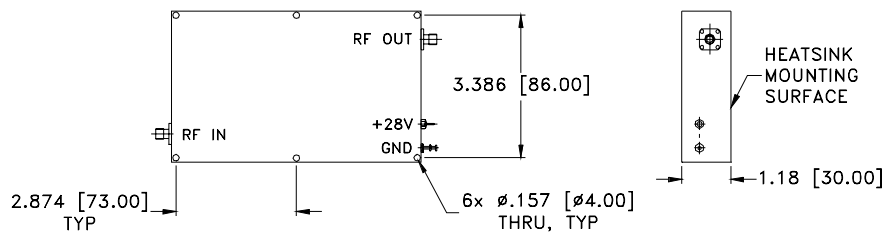

Outline Dimensions (inch/mm)

A	B	C	D	E	F	G	J	K	L	P	Q	R	S	T	wt
9.85	7.3	6.4	6.43	1.00	3.75	.13	.51	2.91	.67	3.58	.53	5.94	5.1	.135	grams*
250.19	185.42	162.56	163.32	25.40	95.25	3.30	12.95	73.91	17.02	90.93	13.46	150.88	129.54	3.43	4265

*580 grams without heatsink

FREQUENCY (MHz)	GAIN (dB)	DIRECTIVITY (dB)	VSWR (:1)		P _{OUT} at 1 dB COMPR. (dBm)	P _{OUT} at 3 dB COMPR. (dBm)	OUTPUT IP ₂ (dBm)	OUTPUT IP ₃ (dBm)
			IN	OUT				
500.00	25.10	70.74	1.67	4.26	37.30	38.08	60.31	46.80
800.00	25.19	68.10	1.36	7.25	36.77	38.09	60.04	46.79
1000.00	24.37	75.92	1.31	8.31	35.81	37.30	57.19	46.10
1200.00	23.90	66.09	1.31	8.95	35.47	37.13	53.89	45.93
1500.00	25.50	59.88	1.47	8.64	35.58	36.93	56.01	46.10
1800.00	25.75	56.97	1.38	6.39	35.94	37.22	61.72	47.32
2000.00	25.22	59.99	1.18	5.47	35.96	37.38	59.35	47.37
2200.00	23.77	60.57	1.05	5.07	36.52	37.89	56.82	46.02
2500.00	24.46	55.38	1.28	4.95	36.47	38.25	62.31	46.43
2800.00	23.86	55.41	1.58	4.02	36.04	37.69	63.70	46.75
3000.00	24.21	54.46	1.65	4.19	35.90	37.49	66.50	46.32
3500.00	24.45	51.99	1.17	2.74	37.52	38.90	74.41	47.25
3800.00	24.31	52.25	1.49	1.82	37.81	38.98	71.07	46.43
4000.00	24.54	50.28	1.70	1.45	38.89	39.66	67.76	47.03
4200.00	23.76	50.43	1.86	2.01	39.06	39.94	79.22	47.60

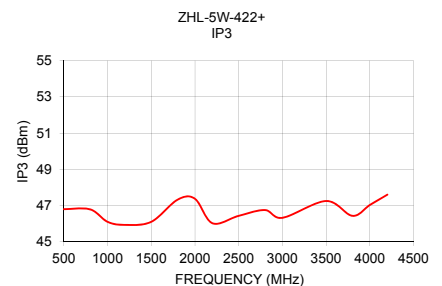
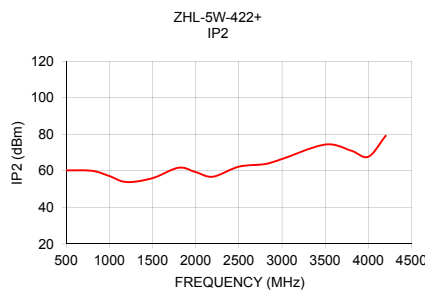
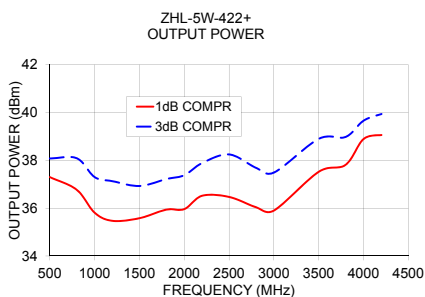
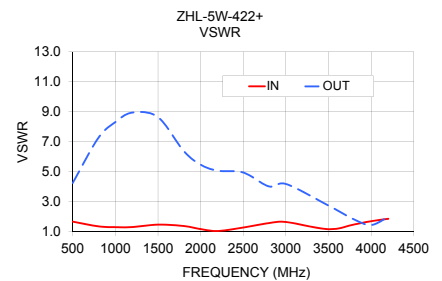
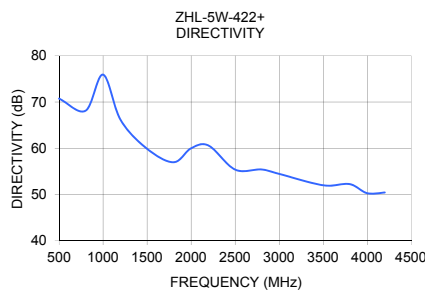
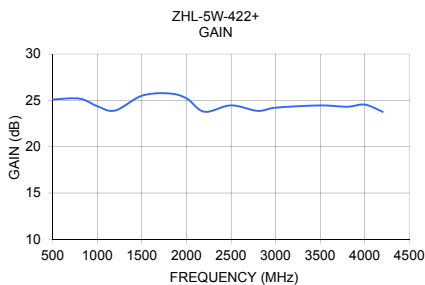

Additional Notes

- A. Performance and quality attributes and conditions not expressly stated in this specification document are intended to be excluded and do not form a part of this specification document.
- B. Electrical specifications and performance data contained in this specification document are based on Mini-Circuit's applicable established test performance criteria and measurement instructions.
- C. The parts covered by this specification document are subject to Mini-Circuits standard limited warranty and terms and conditions (collectively, "Standard Terms"); Purchasers of this part are entitled to the rights and benefits contained therein. For a full statement of the Standard Terms and the exclusive rights and remedies thereunder, please visit Mini-Circuits' website at www.minicircuits.com/MCLStore/terms.jsp