











Professional mounting solutions for the home and office

Focus | Display accessory arm VF-AT-AA

The Visidec VF-AT-AA is an accessory arm for the Focus desk mount range. It allows attachment of an additional monitor. The display height and position can be manipulated while the screen tilt/ pan and orientation can also be adjusted.

-  Suits 75x75mm & 100x100mm mounting (100x200mm optional)*
-  Max display weight 8kg (17.5lbs)
-  Articulated positional adjustment
-  Adjustable tilt and pan
-  Suits 12" or larger monitors
-  Tool-less height adjustment
-  Allows rotation around Pole
-  Adjustable screen orientation



Product key features:

- ✕ Articulated design with 3 pivot points for an extended reach, improved positional adjustment and a flush retracted position
- ✕ Designed for monitors 12" or larger up to 8kg (17.5lbs)
- ✕ Allows 360° rotation around pole
- ✕ Adjustable tilt: +/- 70°
- ✕ Adjustable pan: +/- 90°
- ✕ Allows landscape to portrait screen rotation
- ✕ Maximum arm reach: 413mm (16.25")
- ✕ Integrated cable management
- ✕ Comes with display mounting hardware
- ✕ Durable design with 10 year warranty

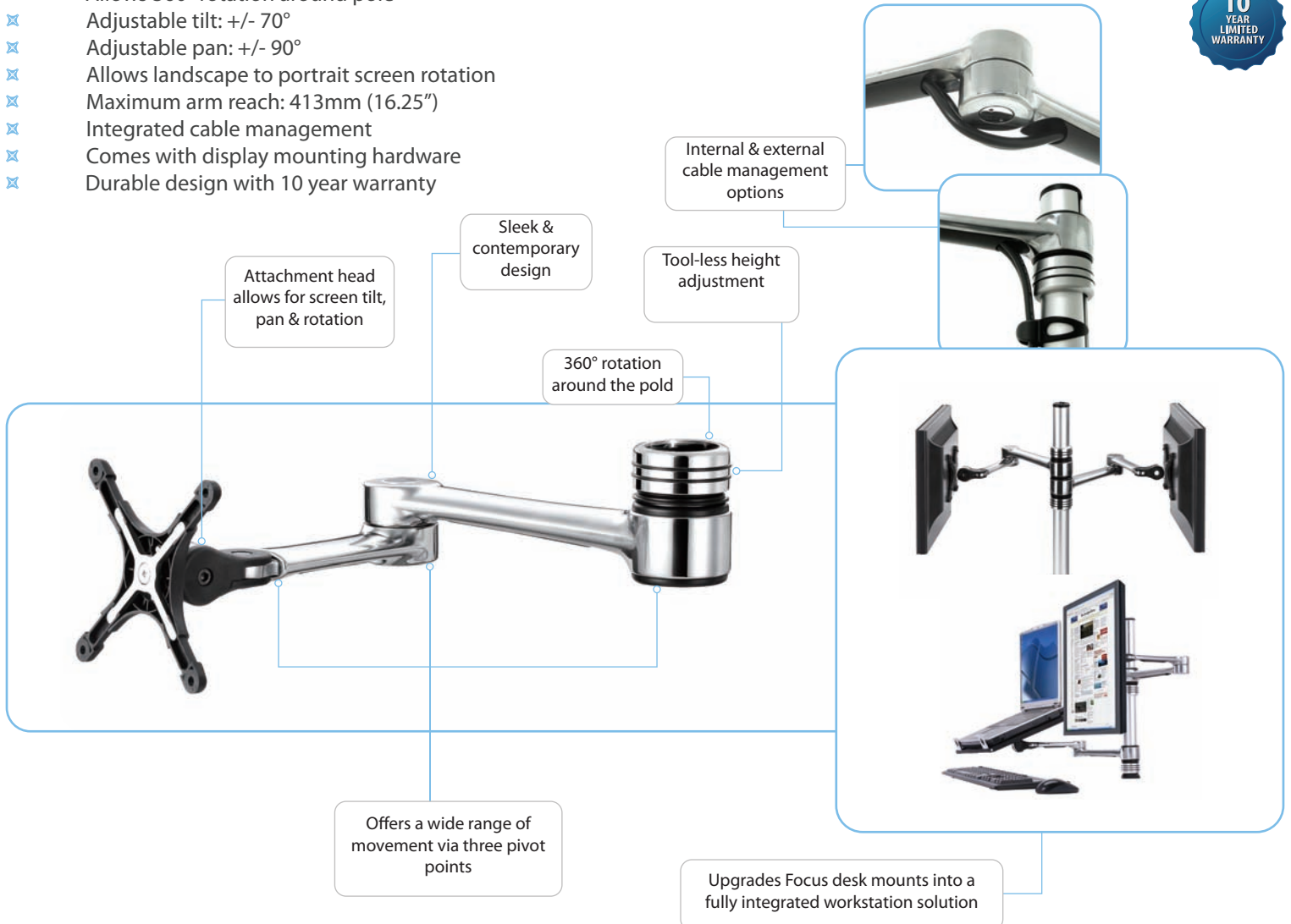

* 200x100 VESA mounting support via optional adaptor accessory



Global www.atdec.com.au
North America www.atdec.com

Product information, single unit

Load capacity	Material	Color
8kg (17.5lbs)	Aluminum	Polished

Package information, single unit

Size	Ship weight	UPC code	Contents
27.3cm x 14cm x 7cm (10.75" x 5.5" x 2.75")	0.8kg (2lbs)	881493005648	All hardware required for installation supplied

Package information, master pack

Size	Ship weight	UPC	Units per master pack
30.5cm x 29.2cm x 36.2cm (12" x 11.5" x 14.25")	8.73kg (19.2lbs)	881493005655	10

Technical drawings

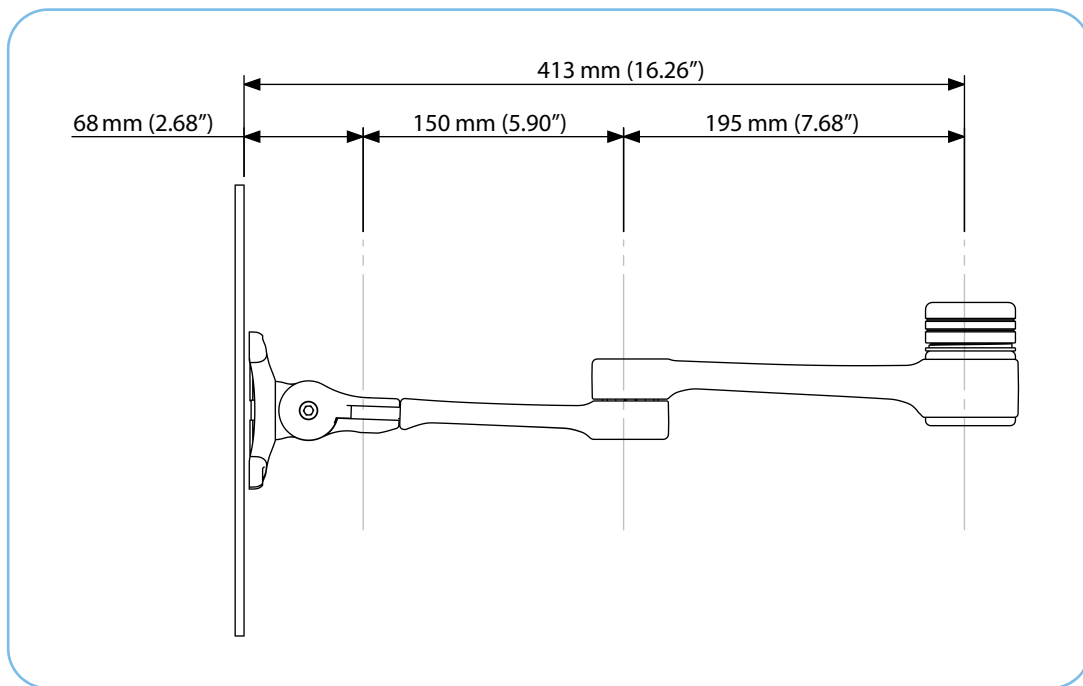

Related Products & Accessories

VF-AT	Desk mount with articulated display arm
VF-AT-D	Desk mount with dual articulated display arms
VF-M	Desk mount with micro display arm
VF-AT-NP	Desk mount with notebook tray
AC-AP-2010	100x200mm VESA Adaptor Accessory

Atdec mounts are designed, developed and tested in Australia. We manufacture an extensive range of display and projector mountings for a variety of user types and situations. While all efforts have been made to ensure the information in this brochure was correct as of the date of printing, we reserve the right to change specifications without notice. Please refer to the website for our full range along with the latest details on specifications, compatibility and dealer location. Atdec and telehookare registered trademarks with all rights reserved. Copyright May 2011 V2.0



Global www.atdec.com.au
North America www.atdec.com