

ASUS® P2B-D2
Dual Pentium® II Motherboard

USER'S MANUAL

USER'S NOTICE

No part of this manual, including the products and software described in it, may be reproduced, transmitted, transcribed, stored in a retrieval system, or translated into any language in any form or by any means, except documentation kept by the purchaser for backup purposes, without the express written permission of ASUSTeK COMPUTER INC. ("ASUS").

ASUS PROVIDES THIS MANUAL "AS IS" WITHOUT WARRANTY OF ANY KIND, EITHER EXPRESS OR IMPLIED, INCLUDING BUT NOT LIMITED TO THE IMPLIED WARRANTIES OR CONDITIONS OF MERCHANTABILITY OR FITNESS FOR A PARTICULAR PURPOSE. IN NO EVENT SHALL ASUS, ITS DIRECTORS, OFFICERS, EMPLOYEES OR AGENTS BE LIABLE FOR ANY INDIRECT, SPECIAL, INCIDENTAL, OR CONSEQUENTIAL DAMAGES (INCLUDING DAMAGES FOR LOSS OF PROFITS, LOSS OF BUSINESS, LOSS OF USE OR DATA, INTERRUPTION OF BUSINESS AND THE LIKE), EVEN IF ASUS HAS BEEN ADVISED OF THE POSSIBILITY OF SUCH DAMAGES ARISING FROM ANY DEFECT OR ERROR IN THIS MANUAL OR PRODUCT.

Product warranty or service will not be extended if: (1) the product is repaired, modified or altered, unless such repair, modification or alteration is authorized in writing by ASUS; or (2) the serial number of the product is defaced or missing.

Products and corporate names appearing in this manual may or may not be registered trademarks or copyrights of their respective companies, and are used only for identification or explanation and to the owners' benefit, without intent to infringe.

- Adobe and Acrobat are registered trademarks of Adobe Systems Incorporated.
- Adaptec, AHA, EZ-SCSI, and AIC is a registered trademark of Adaptec, Inc.
- Sound Blaster, SB16, AWE32, AWE64D and SB-LINK are trademarks of Creative Technology Ltd.
- Intel, LANDesk, and Pentium are registered trademarks of Intel Corporation.
- IBM and OS/2 are registered trademarks of International Business Machines.
- Windows and MS-DOS are registered trademarks of Microsoft Corporation.
- Trend and ChipAwayVirus are trademarks of Trend Micro, Inc.

The product name and revision number are both printed on the product itself. Manual revisions are released for each product design represented by the digit before and after the period of the manual revision number. Manual updates are represented by the third digit in the manual revision number.

For previous or updated manuals, BIOS, drivers, or product release information, contact ASUS at <http://www.asus.com.tw> or through any of the means indicated on the following page.

SPECIFICATIONS AND INFORMATION CONTAINED IN THIS MANUAL ARE FURNISHED FOR INFORMATIONAL USE ONLY, AND ARE SUBJECT TO CHANGE AT ANY TIME WITHOUT NOTICE, AND SHOULD NOT BE CONSTRUED AS A COMMITMENT BY ASUS. ASUS ASSUMES NO RESPONSIBILITY OR LIABILITY FOR ANY ERRORS OR INACCURACIES THAT MAY APPEAR IN THIS MANUAL, INCLUDING THE PRODUCTS AND SOFTWARE DESCRIBED IN IT.

Copyright © 1998 ASUSTeK COMPUTER INC. All Rights Reserved.

Product Name:	ASUS P2B-D2
Manual Revision:	1.03 E294
Release Date:	November 1998

ASUS CONTACT INFORMATION

ASUSTeK COMPUTER INC.

Marketing

Address: 150 Li-Te Road, Peitou, Taipei, Taiwan 112
Telephone: +886-2-2894-3447
Fax: +886-2-2894-3449
Email: info@asus.com.tw

Technical Support

Fax: +886-2-2895-9254
Email: tsd@asus.com.tw
WWW: www.asus.com.tw
FTP: ftp.asus.com.tw/pub/ASUS

ASUS COMPUTER INTERNATIONAL

Marketing

Address: 6737 Mowry Avenue, Mowry Business Center, Building 2
Newark, CA 94560, USA
Fax: +1-510-608-4555
Email: info-usa@asus.com.tw

Technical Support

Fax: +1-510-608-4555
BBS: +1-510-739-3774
Email: tsd-usa@asus.com.tw
WWW: www.asus.com
FTP: ftp.asus.com.tw/pub/ASUS

ASUS COMPUTER GmbH

Marketing

Address: Harkort Str. 25, 40880 Ratingen, BRD, Germany
Telephone: 49-2102-445011
Fax: 49-2102-442066
Email: info-ger@asus.com.tw

Technical Support

Hotline: 49-2102-499712
BBS: 49-2102-448690
Email: tsd-ger@asus.com.tw
WWW: www.asuscom.de
FTP: ftp.asuscom.de/pub/ASUSCOM

CONTENTS

I. INTRODUCTION	7
How this Manual is Organized	7
Item Checklist	7
II. FEATURES	8
Features	8
The ASUS P2B-D2 Motherboard	9
III. INSTALLATION	10
The ASUS P2B-D2 Motherboard Layout	10
Installation Steps	12
1. Jumpers	12
Jumper Settings	13
2. System Memory	16
Main Memory (DIMM).....	16
DIMM Memory Installation Procedures	17
i960 Memory (SIMM).....	18
SIMM Installation	18
3. Central Processing Unit (CPU).....	19
Pentium II Processor	19
Recommended Heatsinks	23
AAVID Heatsink	23
Elan Vital Heatsink	23
4. Expansion Cards	24
Expansion Card Installation Procedure	24
Assigning IRQs for Expansion Cards.....	24
Assigning DMA Channels for ISA Cards.....	25
ISA Cards and Hardware Monitor	25
5. External Connectors	26
Power Connection Procedures	37
IV. BIOS SOFTWARE	38
Flash Memory Writer Utility	38
Main Menu	38
Managing and Updating Your Motherboard's BIOS	40
6. BIOS Setup	41
Load Defaults	42
Standard CMOS Setup	42
Details of Standard CMOS Setup:.....	42
BIOS Features Setup	45
Details of BIOS Features Setup	45

CONTENTS

Chipset Features Setup	48
Details of Chipset Features Setup	48
Power Management Setup	51
Details of Power Management Setup	51
PNP and PCI Setup	54
Details of PNP and PCI Setup	54
Load BIOS Defaults	56
Load Setup Defaults	56
Supervisor Password and User Password	57
IDE HDD Auto Detection	58
Save & Exit Setup	59
Exit Without Saving	59
V. Support CD	61
Support CD Contents	61
Windows 98	63
Windows NT 4.0	77
IBM OS/2	91
Appendix	119
i. Network Interface	121
ii. SCSI BIOS	135
iii. EZ-SCSI Utility	136
iv. Desktop Management Interface	144
v. ASUS LAN Card	147

FCC & DOC COMPLIANCE

Federal Communications Commission Statement

This device complies with FCC Rules Part 15. Operation is subject to the following two conditions:

- This device may not cause harmful interference, and
- This device must accept any interference received, including interference that may cause undesired operation.

This equipment has been tested and found to comply with the limits for a Class B digital device, pursuant to Part 15 of the FCC Rules. These limits are designed to provide reasonable protection against harmful interference in a residential installation. This equipment generates, uses and can radiate radio frequency energy and, if not installed and used in accordance with manufacturer's instructions, may cause harmful interference to radio communications. However, there is no guarantee that interference will not occur in a particular installation. If this equipment does cause harmful interference to radio or television reception, which can be determined by turning the equipment off and on, the user is encouraged to try to correct the interference by one or more of the following measures:

- Re-orient or relocate the receiving antenna.
- Increase the separation between the equipment and receiver.
- Connect the equipment to an outlet on a circuit different from that to which the receiver is connected.
- Consult the dealer or an experienced radio/TV technician for help.

WARNING! The use of shielded cables for connection of the monitor to the graphics card is required to assure compliance with FCC regulations. Changes or modifications to this unit not expressly approved by the party responsible for compliance could void the user's authority to operate this equipment.

Canadian Department of Communications Statement

This digital apparatus does not exceed the Class B limits for radio noise emissions from digital apparatus set out in the Radio Interference Regulations of the Canadian Department of Communications.

I. INTRODUCTION

How this Manual is Organized

This manual is divided into the following sections:

I. Introduction	Manual information and checklist
II. Features	Information and specifications
III. Installation	Setting up the motherboard and jumpers
IV. BIOS Software	Setting up the BIOS software
V. Support CD	Information on the included support software

Item Checklist

Check that your package is complete. If you discover damaged or missing items, contact your retailer.

- (1) ASUS Motherboard
- (2) Processor Retention Mechanisms
- (2) Attach mount bridges (factory installed)
- (1) IDE ribbon cable for master and slave drives
- (1) Floppy ribbon cable for (1) 5.25inch floppy and (2) 3.5inch floppies
- (1) Bag of spare jumper caps
- (1) Support CD with drivers and utilities
- (1) User's Manual
- (1) ASUS C-P2T PC100 CPU termination card
- (1) Adaptec 7800 Family Manager Set User's Manual
- (1) Serial COM2 external connector
- 68-pin Ultra2 SCSI cable (optional)
- 50-pin Narrow SCSI cable (optional)
- Ultra2 SCSI terminator (optional)
- IrDA-compliant infrared module (optional)
- ASUS PCI-L101 Wake-On-LAN 10/100 Ethernet Card (optional)
- ASUS S-P2FAN or P2T-Cable for Slot 1 processors (optional)

II. FEATURES

Features

The ASUS P2B-D2 motherboard is carefully designed for the demanding PC user who wants advanced features processed by the fastest CPU.

- **Multi-Speed:** Supports Dual Intel Pentium® II processors from 233MHz to 450MHz.
- **I2O:** Includes Intel's i960RD I/O processor with 32KB NVRAM, 4x512KB Flash EEPROM, and 2 SIMM slots for up to 256MB of memory.
- **Intel Chipset:** Features Intel's 440BX AGPset with I/O subsystems and front-side bus (FSB) platform, which boosts the traditional 66-MHz internal bus speed to 100MHz.
- **Enhanced ACPI and Anti-Boot Virus BIOS:** Features a programmable BIOS, offering enhanced ACPI for Windows 98 compatibility, built-in hardware-based virus protection through Trend ChipAwayVirus, and autodetection of most devices for virtually automatic setup.
- **PC100 Memory Support:** Equipped with four DIMM sockets to support Intel PC100-compliant SDRAMs (8, 16, 32, 64, 128, or 256MB) up to 1GB. These new SDRAMs are necessary to meet the enhanced 100MHz bus speed requirement.
- **Onboard VGA:** Features the S3 Trio64V2/DX VGA chipset onboard for faster 2D and video acceleration.
- **Wake-On-LAN:** Supports Wake-On-LAN activity with the onboard network interface.
- **Network Interface:** Features the Intel 82558 Ethernet LAN Controller (fully integrated 10BASE-T/100BASE-TX).
- **Alert-On-LAN:** Supports Alert-On-LAN, which enables the host to send immediate alerts to the network administrators when there are hardware or operating system failures, or any evidence of tampering.
- **Adaptec SCSI Chipset:** Features Adaptec AIC-7890 Ultra2 SCSI chipset that supports a combination of 8-bit and 16-bit Ultra2, Ultra, and single-ended or standard SCSI devices and the AIC-3860 transceiver chipset that bridges the compatibility gap between these mixed environments without affecting system performance by taking advantage of the benefits of low-voltage differential (LVD) technology.
- **SB-Link™:** Features Creative's SB-Link™, allowing SB16 compatibility, using Intel's PC-PCI and serialized IRQ protocols, to AWE64D or compatible PCI audio cards.
- **SMBus:** Features the System Management Bus interface, which is used to physically transport commands and information between SMBus devices.
- **PCI & ISA Expansion Slots:** Provides one 16-bit ISA, three master 32-bit PCI, and three secondary 32-bit PCI slots.
- **Intelligence:** Supports Fan Status Monitoring and Alarm, Temperature Monitoring and Alert, Voltage Monitoring and Alert, System Resources Alert, and Virus Write Protection through the onboard Hardware Monitor, Intel LANDesk Client Manager (LDCM), and ASUS PC Probe software, and Alert-On-LAN function.
- **Super Multi-I/O:** Provides two high-speed UART compatible serial ports and one parallel port with EPP and ECP capabilities. UART2 can also be directed from COM2 to the Infrared Module for wireless connections.
- **Desktop Management Interface (DMI):** Supports DMI through BIOS, which allows hardware to communicate within a standard protocol creating a higher level of compatibility. (Requires DMI-enabled components.)
- **Ultra DMA/33 Bus Master IDE/Floppy:** Comes with an onboard PCI Bus Master IDE controller with two connectors that supports four IDE devices in two channels, supports UltraDMA/33, PIO Modes 3 and 4 and Bus Master IDE DMA Mode 2, and supports Enhanced IDE devices. Two floppy drives of either 5.25inch or 3.5inch (1.44MB or 2.88MB) are also supported without an external card. Supports Japanese standard "Floppy 3 mode" (3.5-inch disk drive: 1.44MB, 1.2MB, 720KB) and LS-120 floppy disk drives (3.5-inch disk drive: 120 MB). BIOS supports IDE CD-ROM or SCSI device boot-up.
- **IrDA:** Supports an optional infrared port module for wireless interface.
- **Concurrent PCI:** Allows multiple PCI transfers from PCI master buses to memory to CPU.

II. FEATURES

The ASUS P2B-D2 Motherboard

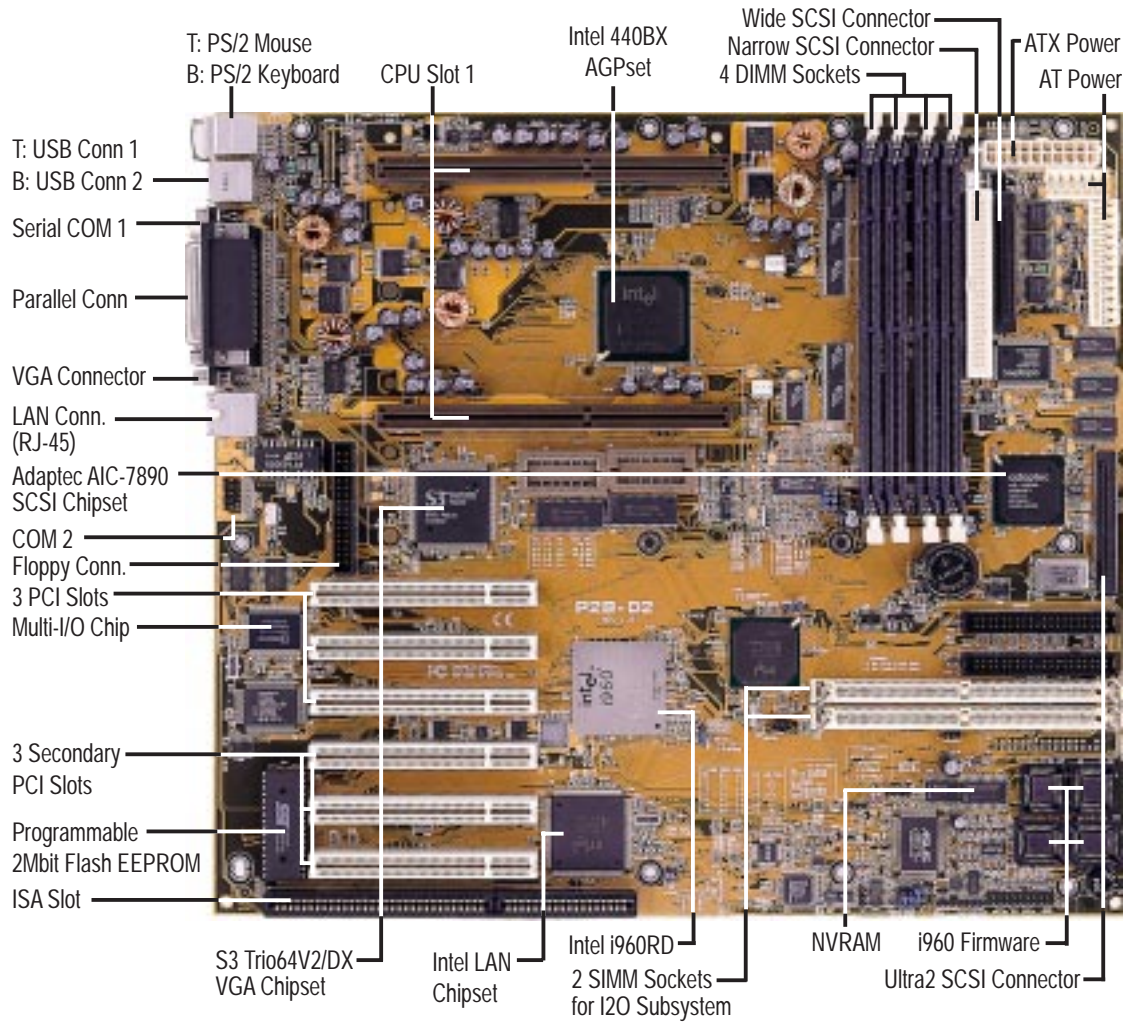

II. FEATURES
Motherboard Parts

III. INSTALLATION

The ASUS P2B-D2 Motherboard Layout

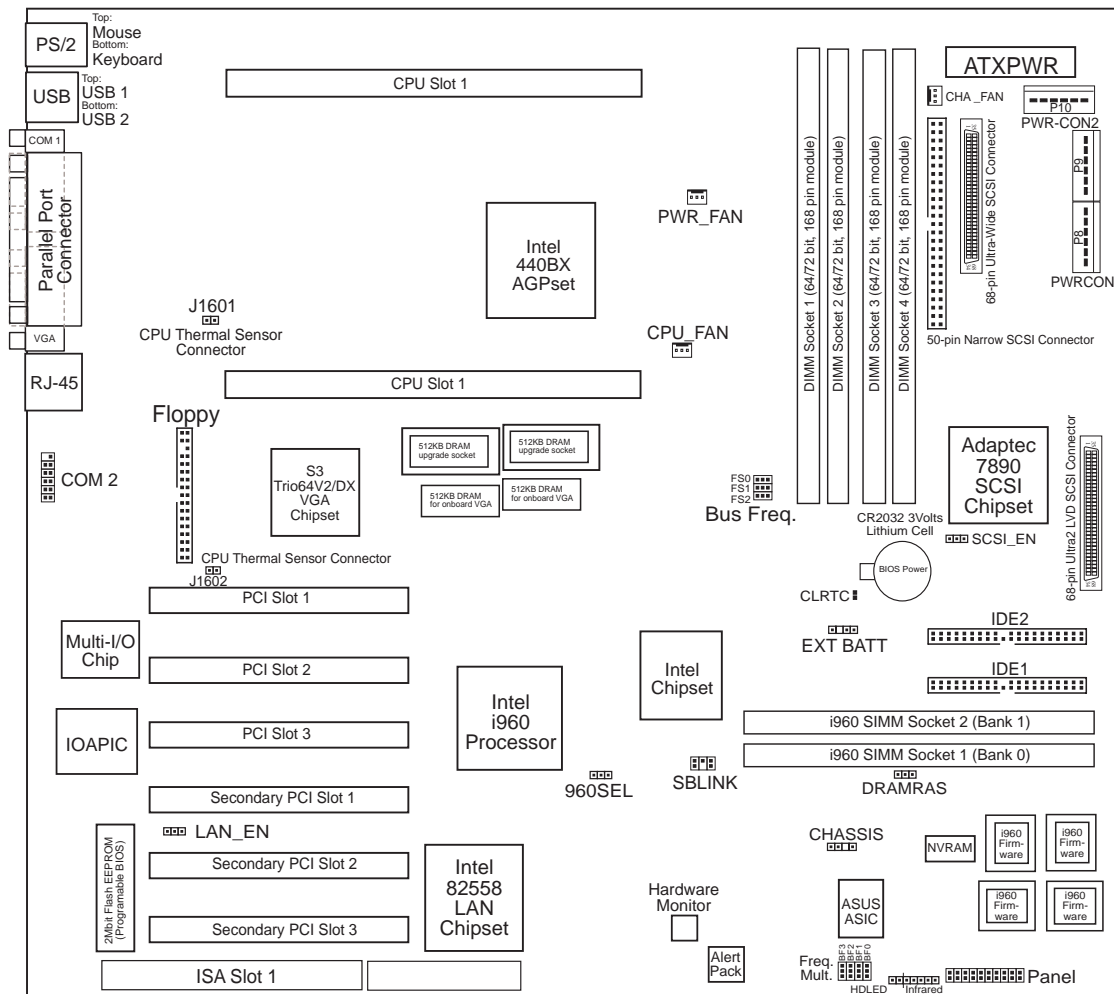

III. INSTALLATION
 Motherboard Layout

III. INSTALLATION

Jumpers

- | | |
|-----------------------|---|
| 1) CLRTC | p. 13 Clear Real Time Clock (RTC) RAM |
| 2) 960SEL | p. 13 i960 Setting (I2O/Bridge) |
| 3) DRAMRAS | p. 13 i960RD DRAM RAS Setting (Single/Double) |
| 4) FS0, FS1, FS2 | p. 14 CPU Bus Frequency |
| 5) BF0, BF1, BF2, BF3 | p. 14 CPU Core:Bus Frequency Multiple |
| 6) LAN_EN | p. 15 LAN Setting (Enable/Disable) |
| 7) SCSI_EN | p. 15 SCSI Setting (Enable/Disable) |

Expansion Slots/Sockets

- | | |
|---------------------------|--|
| 1) DIMM1-4 | p. 16 DIMM System Memory Sockets |
| 2) I-SIMM1, I-SIMM2 | p. 18 SIMM i960 Memory Sockets |
| 3) CPU Slot 1 | p. 19 Pentium® II CPU Support |
| 4) SLOT1 | p. 24 16-bit ISA Bus Expansion Slot* |
| 5) S-PCI1, S-PCI2, S-PCI3 | p. 25 32-bit Secondary PCI Bus Expansion Slots |
| 6) PCI1, PCI2, PCI3 | p. 25 32-bit PCI Bus Expansion Slots |

Hardware Monitor

- | | |
|-----------------|------------------------------------|
| 1) J1601, J1602 | p. 20 CPU Thermal Sensor Connector |
|-----------------|------------------------------------|

Connectors

- | | |
|-------------------------------|---|
| 1) PS2KBMS | p. 26 PS/2 Keyboard Port Connector (6-pin female) |
| 2) PS2MBMS | p. 26 PS/2 Mouse Port Connector (6-pin female) |
| 3) PRINTER | p. 27 Parallel (Printer) Port Connector (25-pin female) |
| 4) COM1 | p. 27 Serial Port COM1 Port Connector (two 9-pin male) |
| 5) VGA | p. 27 Monitor (VGA) Output Port Connector (15-pin female) |
| 6) USB | p. 28 Universal Serial BUS Ports 1 & 2 (two 4-pin female) |
| 7) RJ-45 | p. 28 RJ-45 Port Connector (8-pin female) |
| 8) IDELED | p. 28 IDE/SCSI LED Activity Light (2-pins) |
| 9) IDE1, IDE2 | p. 29 Primary/Secondary IDE Connector (40 pins) |
| 10) CHASSIS | p. 29 Chassis Intrusion Sensor Lead (4-1 pins) |
| 11) IR | p. 30 Infrared Port Module Connector (5 pins) |
| 12) CHA_/CPU_/PWR_FAN | p. 30 Chassis/CPU/Power Supply Fan Connectors (3 pins) |
| 13) PWRCON, PWR-CON2 | p. 31 AT Power Supply Connector (12 pins) |
| 14) ATXPWR | p. 31 ATX Motherboard Power Connector (20 pins) |
| 15) MSG.LED (PANEL) | p. 32 Message LED Lead (2 pins) |
| 16) SMI (PANEL) | p. 32 SMI Suspend Switch Lead (2 pins) |
| 17) PWR.SW (PANEL) | p. 32 ATX Power Switch / Soft Power Switch (2 pins) |
| 18) RESET (PANEL) | p. 32 Reset Switch Lead (2 pins) |
| 19) PWR.LED (PANEL) | p. 32 System Power LED (3-1 pins) |
| 20) KEY LOCK (PANEL) | p. 32 Keyboard Lock Switch Lead (2 pins) |
| 21) SPEAKER (PANEL) | p. 32 Speaker Connector (4 pins) |
| 22) SCSI-50/SCSI-68/ULTRA2-68 | p. 33 50-pin Narrow/68-pin Wide/68-pin Ultra2 SCSI Connectors |
| 23) SBLINK | p. 34 SB-LINK™ Port Connector (6-1 pins) |
| 24) FLOPPY | p. 34 Floppy Drive Port Connector (34-1 pins) |
| 25) COM2 | p. 34 Serial Port Connector (10-1 pins) |
| 26) VGA Memory | p. 35 VGA Memory Expansion Sockets |

*The onboard hardware monitor uses the address 290H-297H so legacy ISA cards must not use this address, otherwise conflicts will occur.

III. INSTALLATION

Installation Steps

Before using your computer, you must complete the following steps:

1. **Set Jumpers on the Motherboard**
2. **Install System Memory Modules**
3. **Install the Central Processing Unit (CPU)**
4. **Install Expansion Cards**
5. **Connect Ribbon Cables, Cabinet Wires, and Power Supply**
6. **Setup the BIOS Software**

1. Jumpers

WARNING! Computer motherboards, baseboards and components, such as SCSI cards, contain very delicate Integrated Circuit (IC) chips. To protect them against damage from static electricity, you should follow some precautions whenever you work on your computer.

1. Unplug your computer when working on the inside.
2. Use a grounded wrist strap before handling computer components. If you do not have one, touch both of your hands to a safely grounded object or to a metal object, such as the power supply case.
3. Hold components by the edges and try not to touch the IC chips, leads or connectors, or other components.
4. Place components on a grounded antistatic pad or on the bag that came with the component whenever the components are separated from the system.

III. INSTALLATION

Jumper Settings

1. Clear Real Time Clock (RTC) RAM (CLRRTC)

The CMOS RAM is powered by the onboard button cell battery. To clear the RTC data: (1) Turn off your computer and unplug its AC power, (2) Short the two solder points labeled CLRRTC, (3) Turn on your computer, (4) Hold down <Delete> during bootup and enter BIOS setup to re-enter user preferences.

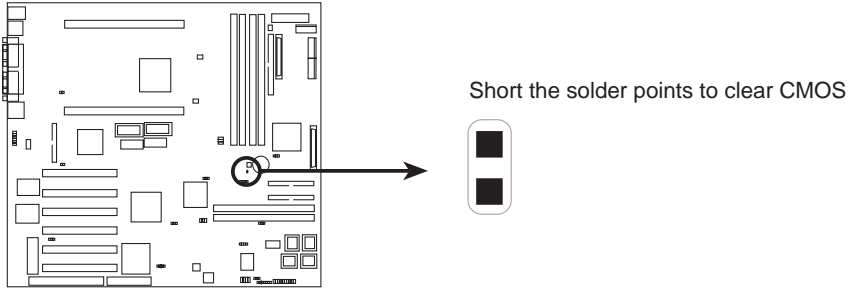

P2B-D2 Real Time Clock RAM (CLRRTC)

2. i960 Bridge Setting

The secondary PCI slots can function as standard PCI slots when the i960 is set to “Bridge” mode. When the i960 is set to “I2O” mode, the secondary PCI slots are controlled by the i960 and only intelligent I/O (I2O) cards can be used on the secondary PCI slots. An i960 memory module is required for the “I2O” mode.

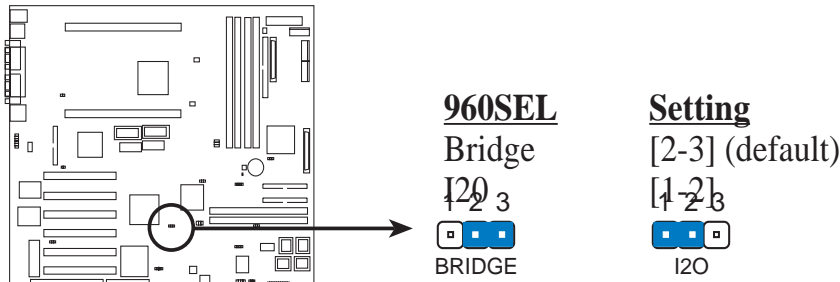

P2B-D2 i960 Setting

3. i960 Local DRAM RAS Setting

When the i960 is set to I2O mode, the i960 chip acts as a processor and at least one SIMM memory module is required. When using a single memory module, this jumper does not need setting but must be installed in i960 SIMM1. When using two memory modules, this jumper needs to be set according to the number of sides used by the chips mounted on the memory modules.

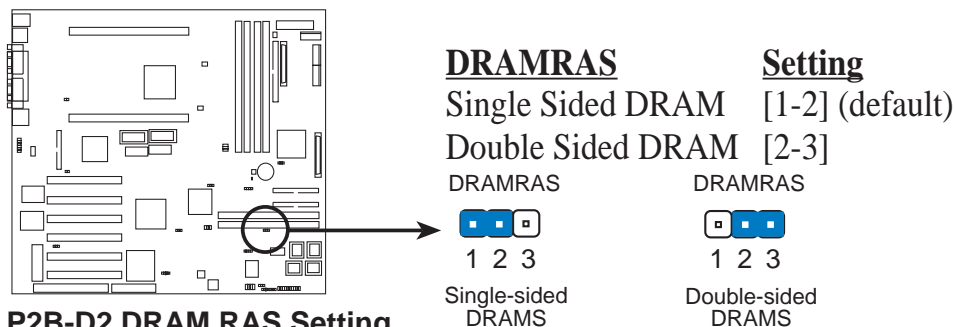

P2B-D2 DRAM RAS Setting

III. INSTALLATION

4. CPU Bus Frequency (FS0, FS1, FS2)

This option tells the clock generator what frequency to send to the CPU, DRAM, and 440BX AGPset. This allows the selection of the CPU's *External* frequency (or *BUS Clock*). The BUS Clock multiplied by the BUS Ratio equals the CPU's *Internal* frequency (the advertised CPU speed).

5. CPU Core:BUS Frequency Multiple (BF0, BF1, BF2, BF3)

This option sets the frequency multiple between the *Internal* frequency of the CPU and the CPU's *External* frequency. These must be set in conjunction with the *CPU Bus Frequency*.

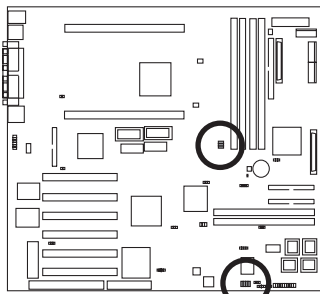

P2B-D2 CPU Settings

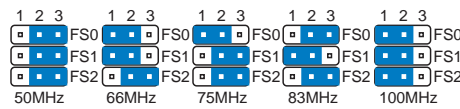

CPU Bus Frequency

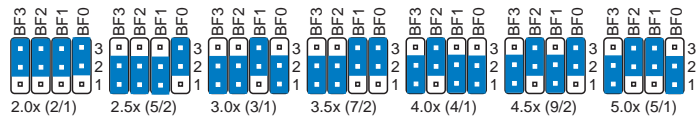

CPU Core:Bus Frequency Multiple

WARNING! Frequencies above 100MHz exceed the specifications for the on-board Intel Chipset and are not guaranteed to be stable.



Intel Pentium II Processor in an SEC cartridge (233-450MHz)

Set the jumpers by the Internal speed of your processor as follows:

Intel CPU Model	Freq.	Ratio	(BUS Freq.)				(Freq. Ratio)			
			BUS F.	FS2	FS1	FS0	BF3	BF2	BF1	BF0
Pentium II	450MHz	4.5x	100MHz	[1-2]	[1-2]	[1-2]	[1-2]	[2-3]	[1-2]	[2-3]
Pentium II	400MHz	4.0x	100MHz	[1-2]	[1-2]	[1-2]	[1-2]	[2-3]	[1-2]	[1-2]
Pentium II	350MHz	3.5x	100MHz	[1-2]	[1-2]	[1-2]	[1-2]	[1-2]	[2-3]	[2-3]
Pentium II	333MHz	5.0x	66MHz	[2-3]	[1-2]	[1-2]	[1-2]	[2-3]	[2-3]	[1-2]
Pentium II	300MHz	4.5x	66MHz	[2-3]	[1-2]	[1-2]	[1-2]	[2-3]	[1-2]	[2-3]
Pentium II	266MHz	4.0x	66MHz	[2-3]	[1-2]	[1-2]	[1-2]	[2-3]	[1-2]	[1-2]

NOTES: Overclocking your processor is not recommended. It may result in a slower speed. Voltage Regulator Output Selection (VID) is not needed for the Pentium II processor because it sends a VID signal directly to the onboard power controller.

III. INSTALLATION

6. LAN Setting (LAN_EN)

The onboard Intel 10/100 Fast Ethernet may be enabled or disabled using this jumper.

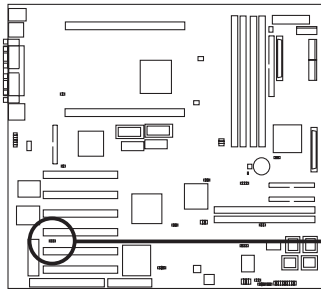

P2B-D2 Onboard LAN Setting

<u>LAN EN</u>	<u>Setting</u>
Enable	[2-3] (default)
Disable	[1-2]

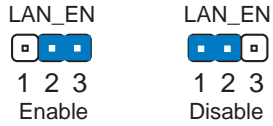

7. SCSI Setting (SCSI_EN)

The onboard Adaptec Fast/Wide/Ultra2 SCSI may be enabled or disabled using this jumper.

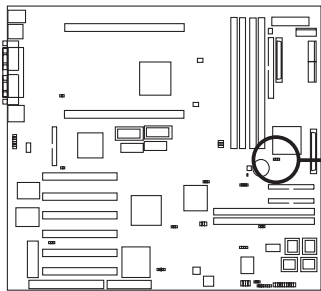

P2B-D2 Onboard SCSI Setting

<u>SCSI EN</u>	<u>Setting</u>
Enable	[2-3] (default)
Disable	[1-2]

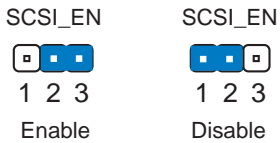

III. INSTALLATION

2. System Memory

Main Memory (DIMM)

This motherboard supports Dual Inline Memory Modules (DIMMs). Sockets are available for **3.3Volt** (power level) unbuffered Synchronous Dynamic Random Access Memory (SDRAM). One side (with memory chips) of the DIMM takes up one row on the motherboard.

To utilize the chipset's Error Checking and Correction (ECC) feature, you must use a DIMM module with 9 chips per side (standard 8 chips/side + 1 ECC chip) and make the proper settings through "Chipset Features Setup" in **BIOS SOFTWARE**.

Memory speed setup is recommended through *SDRAM Configuration* under "Chipset Features Setup".

IMPORTANT (see **General DIMM Notes** below)

- **SDRAMs used must be compatible with the current Intel PC100 SDRAM specification.**

Install memory in any combination as follows:

DIMM Location	168-pin DIMM Memory Modules		Total Memory
Socket 1 (Rows 0&1)	SDRAM 8, 16, 32, 64, 128, 256MB	x1	
Socket 2 (Rows 2&3)	SDRAM 8, 16, 32, 64, 128, 256MB	x1	
Socket 3 (Rows 4&5)	SDRAM 8, 16, 32, 64, 128, 256MB	x1	
Socket 4 (Rows 6&7)	SDRAM 8, 16, 32, 64, 128, 256MB	x1	
	Total System Memory (Max 1GB)	=	

General DIMM Notes

- **Use only PC100-compliant DIMMs.** This motherboard operates at 100MHz, thus most systems will not even boot if non-compliant modules are used because of the strict timing issues involved under this speed.
- Two possible memory chips are supported: SDRAM with and without ECC.
- SDRAM chips are generally thinner with higher pin density than EDO (Extended Data Output) chips.
- BIOS shows SDRAM memory on bootup screen.
- 8 chips/side modules do not support ECC, only 9 chips/side modules support ECC.
- Single-sided DIMMs come in 16, 32, 64, 128MB; double-sided come in 32, 64, 128, 256MB.

III. INSTALLATION

DIMM Memory Installation Procedures

Insert the module(s) as shown. Because the number of pins is different on either side of the breaks, the module will only fit in the orientation as shown. DRAM SIMM modules have the same pin contacts on both sides. SDRAM DIMMs have different pin contacts on each side and therefore have a higher pin density.

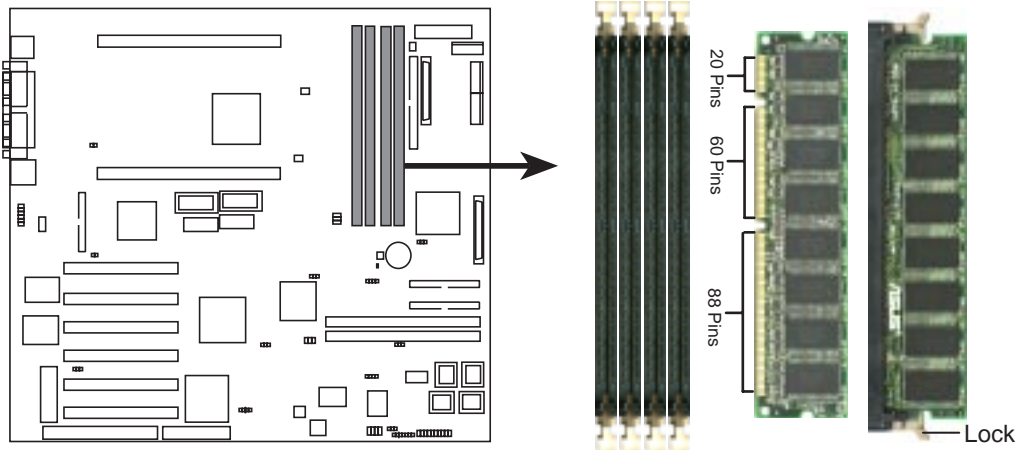

P2B-D2 168-Pin DIMM Memory Sockets

The DIMMs must be 3.3Volt unbuffered SDRAMs. To determine the DIMM type, check the notches on the DIMMs (see figure below).

168-Pin DIMM Notch Key Definitions (3.3V)

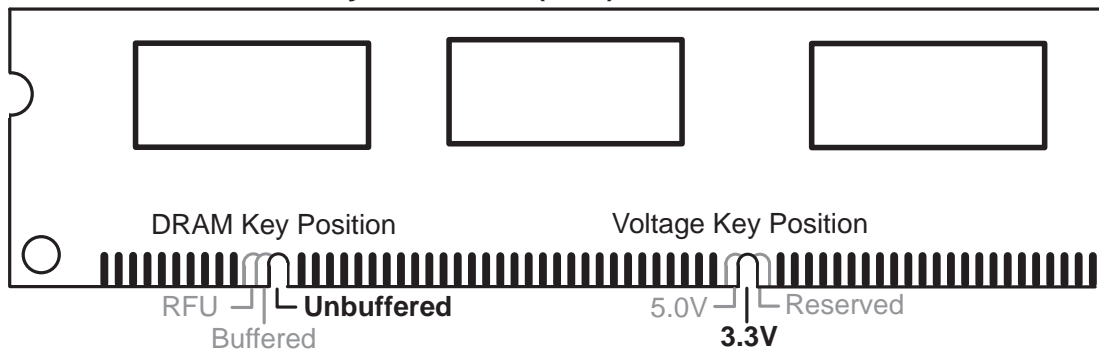

The notches on the DIMM will shift between left, center, or right to identify the type and also to prevent the wrong type from being inserted into the DIMM slot on the motherboard. You must tell your retailer the correct DIMM type before purchasing. This motherboard supports four clock signals.

III. INSTALLATION

i960 Memory (SIMM)

The i960 processor supports two 72-pin, 32-bit SIMMs (Single-Inline Memory Modules) of 4, 8, 16, 32, 64, or 128MB to form a memory size between 8MB to 256MB. Only Extended Data Output (EDO) DRAM, non-parity SIMMs can be supported by the i960 processor.

IMPORTANT: You must use i960 SIMM socket 1 when using only one module.

SIMM Installation

1. The SIMM memory modules will fit in only one orientation as shown because the plastic safety tab on one end of the SIMM sockets requires the notched end of the SIMM memory modules.

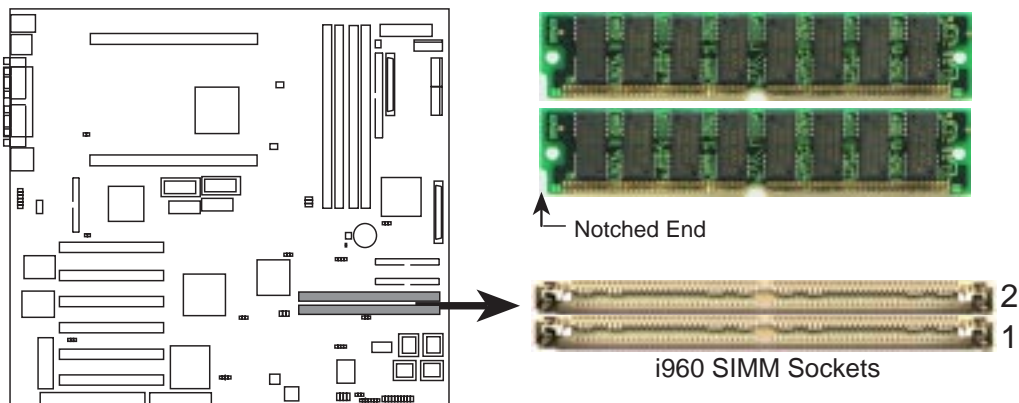

P2B-D2 72-Pin i960 SIMM Sockets

2. Press the memory module firmly into place starting from a 45-degree angle, making sure that all the contacts are aligned with the socket.
3. With your fingertips, rock the memory module into a vertical position so that it clicks into place. The plastic guides should go through the two mounting holes and the clips should snap.

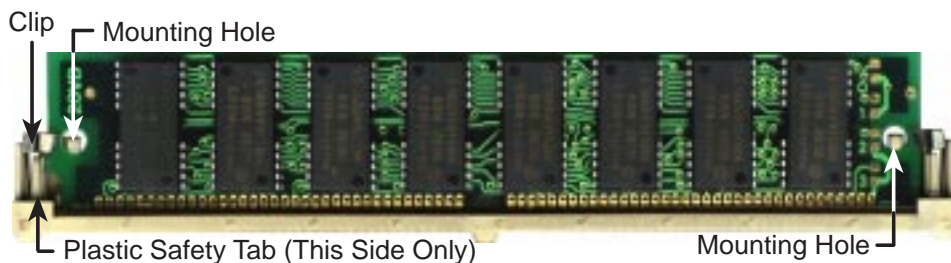

4. To release the memory module, push both clips outward and rock the module out of the clips.

III. INSTALLATION

3. Central Processing Unit (CPU)

This motherboard provides two CPU Slot 1s for Pentium II processors packaged in SEC cartridges.

Pentium II Processor

You should check to see that you have the following items:

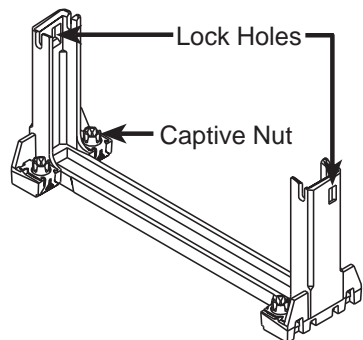

Two Pentium II Retention Mechanisms

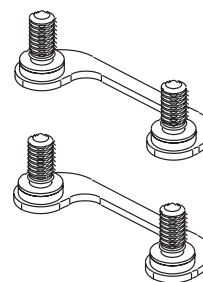

Two Attach Mount Bridges
(factory installed)

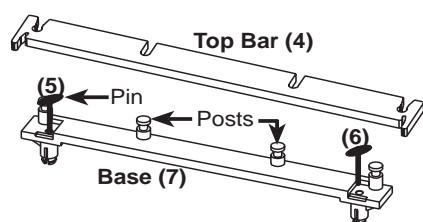

Heatsink Support Base/Top Bar

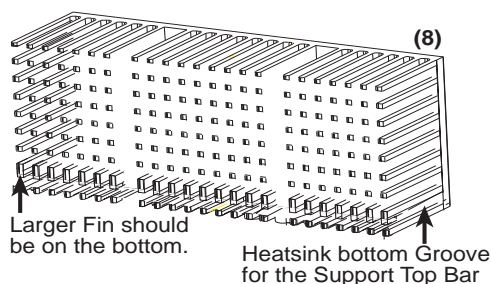

Pentium II Processor Heatsink

The recommended heatsinks (see section on recommended heatsinks for more information) for the Pentium II processor are those with three-pin fans that can be connected to the fan connectors on the motherboard.

WARNING! Be sure that there is sufficient air circulation across the processor's heatsink by regularly checking that your CPU fan is working. Without sufficient circulation, the processor could overheat and damage both the processor and the motherboard. You may install an auxiliary fan, if necessary.

Other Important Items

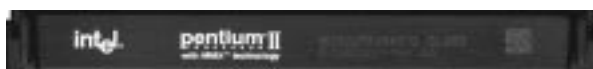

Intel Pentium II Processor in an SEC cartridge



ASUS C-P2T PC100 CPU Termination Card

III. INSTALLATION

Installing the Pentium II Processor

1. **Mount the Processor Retention Mechanism(s):** The processor retention mechanisms are designed to fit into the SEC slots only one way.

Be sure to align the notches in the retention mechanisms with the small ribs on each side of the slots and that the mechanism is properly seated on the board. Then, screw the captive nuts in place.

WARNING! Do not overtighten the captive nuts. Doing so could damage your motherboard. Tighten captive nuts to no more than 6±1 inch/pound.

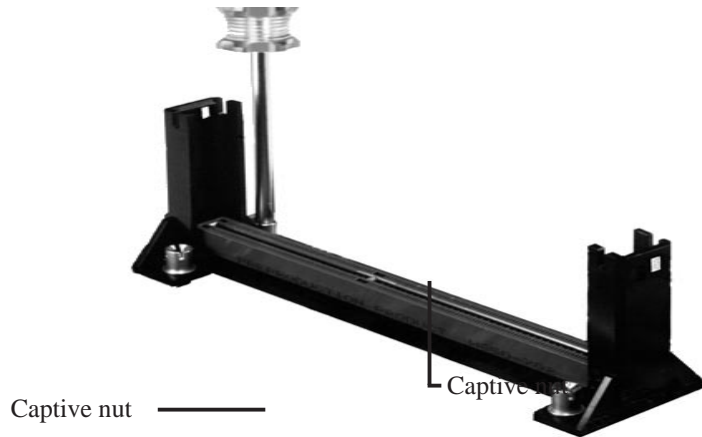

2. **Attach the Heatsink:** Place the SEC cartridge face down on a flat surface and lay the heatsink flush on the back (metal side) of the SEC cartridge. Be sure that the heatsink is firmly pressed against the SEC cartridge. When correctly installed, no light can be seen between the thermal pad of the heatsink and the SEC cartridge.

IMPORTANT: The heatsinks must not be more than 2.8 cm (1.1 inch) thick.

WARNING! If the heatsink is not mounted tightly against the SEC cartridge, the CPU will overheat. You may install an auxiliary fan to provide adequate circulation across the processor's passive heatsink.



III. INSTALLATION

- 3. Insert the SEC Cartridge:** Push the SEC cartridge's two locks inward until you hear a click (the preceding picture shows the locks in the outward position and inward in the picture below). With the heatsink facing the motherboard's chipset, press the cartridge gently but firmly until it is fully inserted. (**NOTE:** The procedures shown here are for installing the AAVID heatsink with fan.)

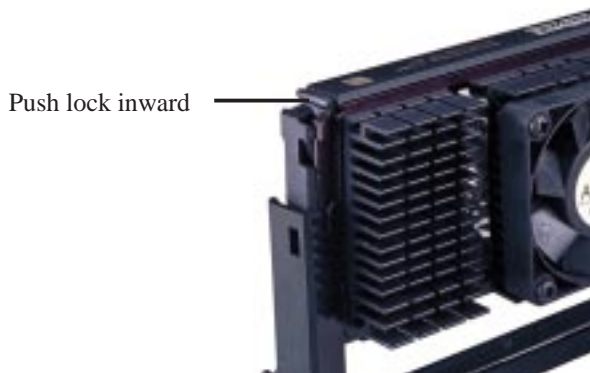

IMPORTANT: If you are installing only one processor, you must terminate the empty slot with the ASUS C-P2T PC100 CPU termination card to maintain signal strength.



ASUS C-P2T PC100 CPU Termination Card

IMPORTANT: Use only the ASUS C-P2T PC100 CPU termination card (Rev. 1.02 or later) to terminate the empty slot.

- 4. Secure the SEC Cartridge:** Secure the SEC cartridge in place by pushing the SEC cartridge locks outward so that the lock protrudes through the retention mechanism's lock holes.



- 5. Connect the Thermal Sensor Cables to J1601/J1602:** If you purchased the specially designed ASUS Smart Fans (ASUS S-P2FAN), which come with a thermal sensor built inside the CPU fan, or purchased separately the thermal sensor cables (ASUS P2T-Cable), you can connect the P2T-Cables to your motherboard's thermal sensor connectors. See the next page for information on ASUS Smart Thermal Solutions.

III. INSTALLATION

ASUS Smart Thermal Solutions

ASUS provides two smart solutions to Slot 1 CPU thermal problems: the **ASUS Smart Fan** or **ASUS S-P2FAN** and the **ASUS P2T-Cable**.

ASUS S-P2FAN

The optional ASUS Smart Fan or ASUS S-P2FAN is a CPU fan for a Pentium® II processor packaged in an SECC. Unlike other CPU thermal solutions, the ASUS S-P2FAN has

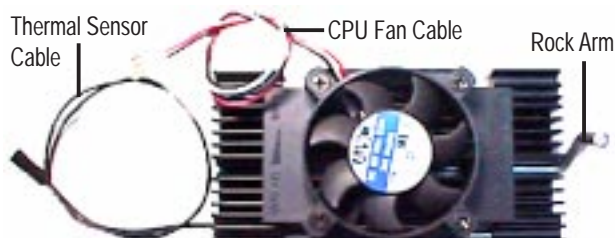

an integrated thermal sensor located near the center of the CPU heat source. The sensor is optimized by ASUS to give the most accurate reading of the CPU temperature, thus provides the best protection to your computer system.

To Use the ASUS S-P2FAN

See **2. Attach the Heatsink** on the preceding page for the relevant procedures. Note that the S-P2FAN comes with a rock arm design for easy FAN/CPU installation.

ASUS P2T-Cable

The optional ASUS P2T-Cable can be used for a Pentium® II processor packaged in an SECC/SECC2 or a Celeron™ processor packaged in an SEPP .

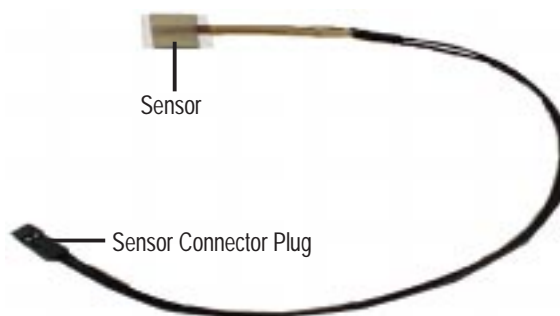

NOTE: The ASUS P2T-Cable can only be used in a Slot 1 motherboard with a 2-pin thermal sensor connector.

To Use the ASUS P2T-Cable

NOTE: The following procedures assume that you have properly attached a heatsink onto an SECC/SECC2/SEPP.

1. Simply peel off the tab from the sensor and then stick the sensor near the middle edge of the Intel boxed processor heatsink with fan (middle) or to either the upper or lower edge of the Celeron™ heatsink (right), as indicated.

III. INSTALLATION



WARNING! Do not insert the sensor between the processor and heatsink, otherwise, it will cause damage to the P2T-Cable.

IMPORTANT! ASUS guarantees accurate readings only for the ASUS Smart Fan and the Intel boxed processor heatsink with fan because both have similar heat distribution and heatsink material.

2. Connect the P2T-Cables to the CPU thermal sensor connectors (J1601/J1602).

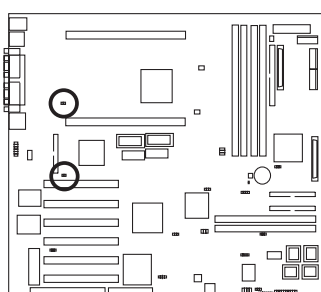

J1601
Thermal Sensor Connector for CPU 1

J1602
Thermal Sensor Connector for CPU 2

P2B-D2 CPU Thermal Sensor Connectors

NOTE: If you are installing only one processor, you may use the free connector to connect a power supply with thermal monitoring.

Recommended Heatsinks for Slot 1 Processors

The recommended heatsinks for the Slot 1 processors are those with three-pin fans, such as the ASUS Smart Fan, that can be connected to the motherboard’s CPU fan connector. These heatsinks, such as the Elan Vital Heatsink with Fan, dissipate heat more efficiently and with an optional hardware monitor, they can monitor the fan’s RPM and use the alert function with the Intel LANDesk Client Manager (LDCM) and the ASUS PC Probe software.

Elan Vital Heatsink with Fan

To install, simply follow the procedures for **Installing the Processor**. The Elan Vital heatsink, however, comes with a lever to clamp the heatsink into the SEC cartridge. Mount the heatsink in the orientation as shown then flip the lever from “Unlock” to “Lock.”



III. INSTALLATION

4. Expansion Cards

WARNING! Unplug your power supply when adding or removing expansion cards or other system components. Failure to do so may cause severe damage to both your motherboard and expansion cards.

Expansion Card Installation Procedure

1. Read the documentation for your expansion card and make any necessary hardware or software settings for your expansion card, such as jumpers.
2. Remove your computer system's cover and the bracket plate on the slot you intend to use. Keep the bracket for possible future use.
3. Carefully align the card's connectors and press firmly.
4. Secure the card on the slot with the screw you removed above.
5. Replace the computer system's cover.
6. Set up the BIOS if necessary
(such as *IRQ xx Used By ISA: Yes* in PNP AND PCI SETUP)
7. Install the necessary software drivers for your expansion card.

Assigning IRQs for Expansion Cards

IMPORTANT: Interrupt requests are shared as shown by the following table:

	INT-A	INT-B	INT-C	INT-D
PCI slot 1	shared	--	--	--
PCI slot 2	--	shared	--	--
PCI slot 3	--	--	shared	--
Onboard VGA	--	--	shared	--
7890 SCSI	--	shared	--	--
i960 processor	--	--	--	shared
2nd-PCI slot 1	--	--	--	shared
2nd-PCI slot 2	shared	--	--	--
2nd-PCI slot 3	--	shared	--	--
Onboard LAN	--	--	shared	--

If using PCI cards on shared slots, make sure that the drivers support "Share IRQ" or that the cards do not need IRQ assignments. Conflicts will arise between the two PCI groups that will make the system unstable or cards inoperable.

Some expansion cards need to use an IRQ to operate. Generally, an IRQ must be exclusively assigned to one use. In a standard design, there are 16 IRQs available but most of them are already in use, leaving 6 IRQs free for expansion cards. If your motherboard has audio onboard, an extra 3 IRQs will be used, leaving 3 IRQs free.

III. INSTALLATION

Both ISA and PCI expansion cards may require to use IRQs. System IRQs are available to cards installed in the ISA expansion bus first, then any remaining IRQs are available to PCI cards. Currently, there are two types of ISA cards. The original ISA expansion card design, now referred to as legacy ISA cards, requires that you configure the card's jumpers manually and then install it in any available slot on the ISA bus. You may use the Microsoft Diagnostics (MSD.EXE) utility located in the Windows directory to see a map of your used and free IRQs. If you use Windows 95, the **Resources** tab under **Device Manager** displays the resource settings being used by a particular device (to gain access, double-click the **System** icon under the **Control Panel** program). Ensure that no two devices share the same IRQs or your computer will experience problems when those two devices are in use at the same time.

To simplify this process, this motherboard complies with the Plug and Play (PnP) specification, which was developed to allow automatic system configuration whenever a PnP-compliant card is added to the system. For PnP cards, IRQs are assigned automatically from those available.

If the system has both legacy and PnP ISA cards installed, IRQs are assigned to PnP cards from those not used by legacy cards. The PCI and PNP configuration section of the BIOS setup utility can be used to assign which IRQs are being used by legacy cards. For older legacy cards that do not work with the BIOS, you may contact your vendor for an ISA Configuration Utility.

An IRQ number is automatically assigned to PCI expansion cards after those used by legacy and PnP ISA cards. In the PCI bus design, the BIOS automatically assigns an IRQ to a PCI slot that contains a card requiring an IRQ. To install a PCI card, you need to set the INT (interrupt) assignment. Since all the PCI slots on this motherboard use an INTA #, set the jumpers on your PCI cards to INT A.

Assigning DMA Channels for ISA Cards

Some ISA cards, both legacy and PnP, may also need to use a DMA (Direct Memory Access) channel. DMA assignments for this motherboard are handled the same way as the IRQ assignment process described earlier. You can select a DMA channel in the PCI and PnP configuration section of the BIOS Setup utility.

IMPORTANT: To avoid conflicts, reserve the necessary IRQs and DMAs for legacy ISA cards (under PNP AND PCI SETUP of the BIOS SOFTWARE, choose *Yes* in *IRQ xx Used By ISA* and *DMA x Used By ISA* for those IRQs and DMAs you want to reserve).

ISA Cards and Hardware Monitor

The onboard hardware monitor uses the address 290H-297H so legacy ISA cards must not use this address or else conflicts will occur.

III. INSTALLATION

5. External Connectors

WARNING! Some pins are used for connectors or power sources. Placing jumper caps over these will cause damage to your motherboard.

IMPORTANT: Ribbon cables should always be connected with the red stripe on the Pin 1 side of the connector. The four corners of the connectors are labeled on the motherboard. Pin 1 is the side closest to the power connector on hard drives and floppy drives. IDE ribbon cable must be less than 46cm (18in), with the second drive connector no more than 15cm (6in) from the first connector.

1. PS/2 Keyboard Connector (6-pin PS2KBMS)

This connection is for a standard keyboard using an PS/2 plug (mini DIN). **This connector will not allow standard AT size (large DIN) keyboard plugs. You may use a DIN to mini DIN adapter on standard AT keyboards.**

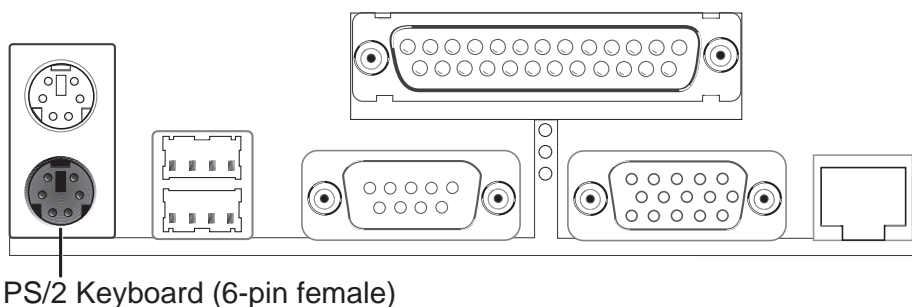

2. PS/2 Mouse Connector (6-pin PS2KBMS)

The system will direct IRQ12 to the PS/2 mouse if one is detected. If not detected, expansion cards can use IRQ12. See “PS/2 Mouse Function Control” in BIOS Features Setup of the BIOS SOFTWARE.

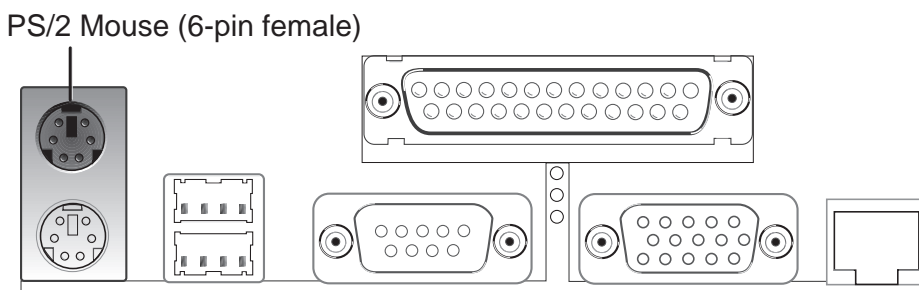

III. INSTALLATION

3. Parallel Connector (25-pin PRINTER)

You can enable the parallel port and choose the IRQ through “Onboard Parallel Port” in Chipset Features Setup of the BIOS SOFTWARE. **NOTE:** Serial printers must be connected to the serial port.

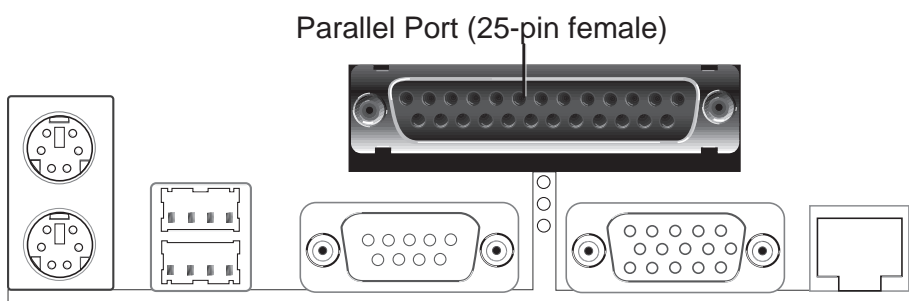

4. Serial Port Connector (9-pin COM1)

One serial port is ready for a mouse or other serial devices. A second serial port is available using a serial port bracket connected from the motherboard to an expansion slot opening. See “Onboard Serial Port” in Chipset Features Setup of the BIOS SOFTWARE for settings.

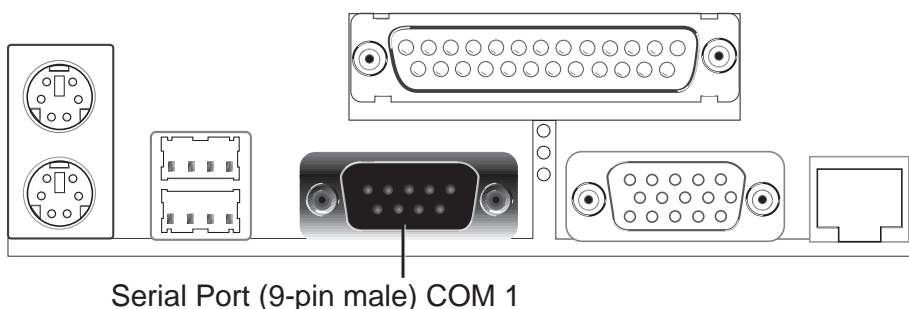

5. Monitor Output Connector (15-pin VGA)

This connector is for output to a VGA-compatible device.

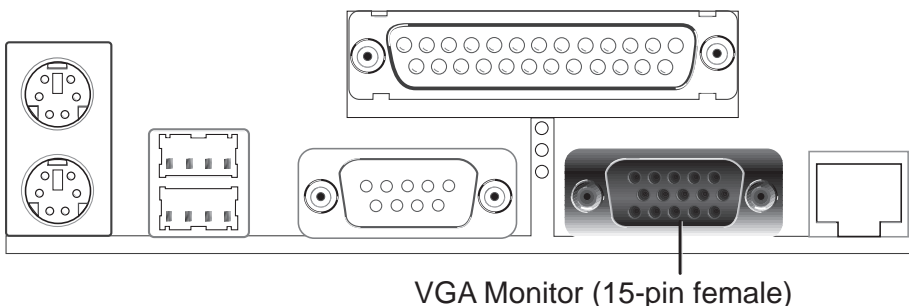

III. INSTALLATION

6. Universal Serial BUS Connectors 1 & 2 (Two 4-pin USB)

Two USB ports are available for connecting USB devices.

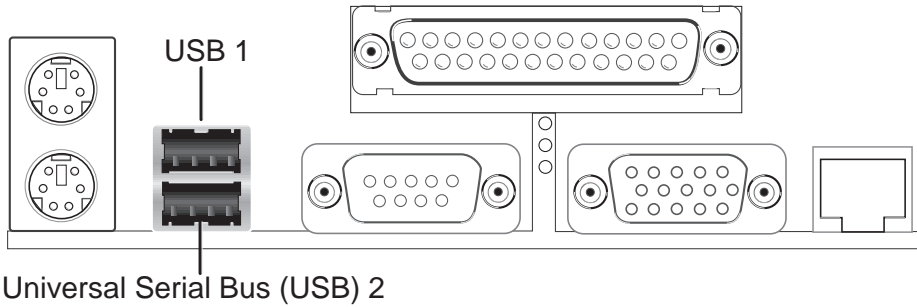

7. LAN Connector (8-pin RJ-45)

This connector can be used to connect the onboard 32-bit 10/100 Mbps Ethernet LAN Controller (optional) to a host or a hub.

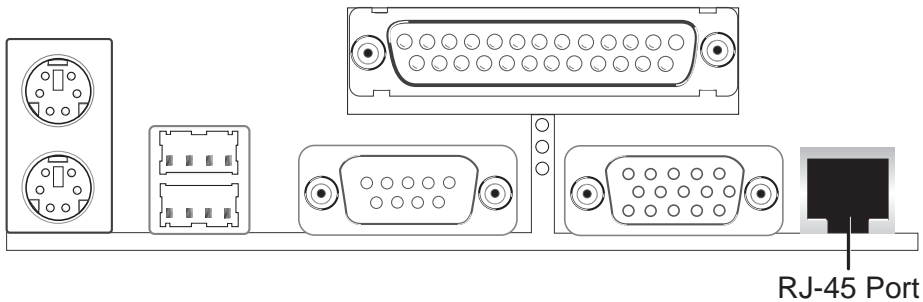

8. Hard Disk Activity LED (2-pin IDELED)

This connector supplies power to the cabinet's hard disk or IDE activity LED. Read and write activity by devices connected to the Primary or Secondary IDE connectors will cause the LED to light up.

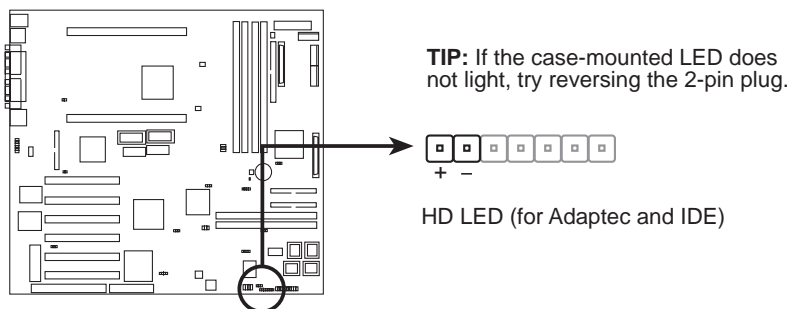

P2B-D2 IDE Activity LED Lead

III. INSTALLATION

9. Primary / Secondary IDE Connectors (Two 40-1 pin IDE)

These connectors support the provided IDE hard disk ribbon cable. After connecting the single end to the board, connect the two plugs at the other end to your hard disk(s). If you install two hard disks, you must configure the second drive to Slave mode by setting its jumper accordingly. Please refer to the documentation of your hard disk for the jumper settings. BIOS now supports SCSI device or IDE CD-ROM bootup (see “HDD Sequence SCSI/IDE First” & “Boot Sequence” in the **BIOS Features Setup** of the BIOS SOFTWARE) (**Pin 20 is removed to prevent inserting in the wrong orientation when using ribbon cables with pin 20 plugged**).

TIP: You may configure two hard disks to be both Masters using one ribbon cable on the primary IDE connector and another ribbon cable on the secondary IDE connector. You may install one operating system on an IDE drive and another on a SCSI drive and select the boot disk through BIOS Features Setup.

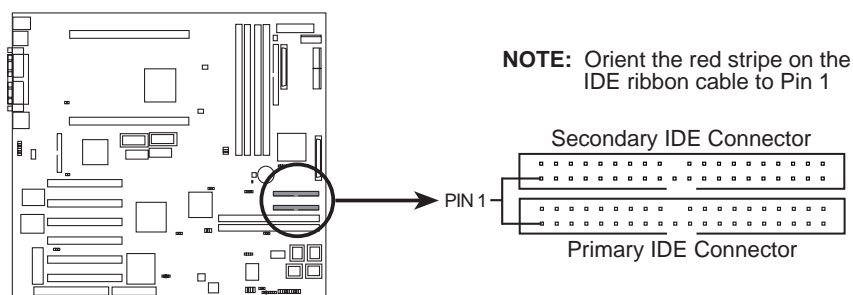

P2B-D2 IDE Connectors

10. Chassis Intrusion Sensor Lead (4-1 pin CHASSIS)

This lead is for a chassis intrusion monitor or sensor. The sensor is triggered when a high level signal is sent to the “chassis signal” lead. This occurs when a panel switch or light detector is triggered. This function requires optional trigger switches to be installed.

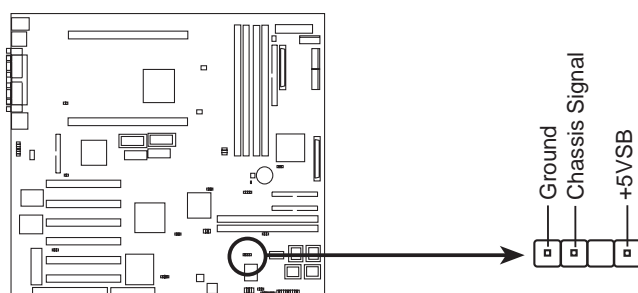

P2B-D2 Chassis Open Alarm Lead

III. INSTALLATION

11. IrDA-Compliant infrared module connector (5-pin IR)

This connector supports the optional wireless transmitting and receiving infrared module. This module mounts to a small opening on system cases that support this feature. You must also configure the setting through “UART2 Use Infrared” in **Chipset Features Setup** to select whether UART2 is directed for use with COM2 or IrDA. Use the five pins as shown on the Back View and connect a ribbon cable from the module to the motherboard according to the pin definitions.

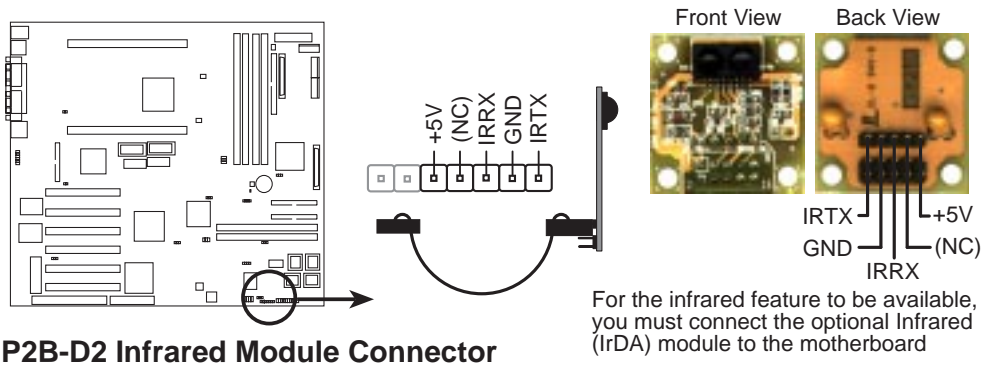

P2B-D2 Infrared Module Connector

12. Chassis, CPU, & Power Supply Fan Connectors (3-pin FAN)

These connectors support cooling fans of 500mA (6W) or less. Orientate the fans so that the heat sink fins allow airflow to go across the onboard heatsink(s) instead of the expansion slots. Depending on the fan manufacturer, the wiring and plug may be different. The red wire should be positive, while the black should be ground. Connect the fan's plug to the board taking into consideration the polarity of the this connector.

NOTE: The “Rotation” signal must only be used with fans specially designed with rotation signal.

WARNING! The CPU and/or motherboard will overheat if there is no airflow across the CPU and onboard heatsinks. Damage may occur to the motherboard and/or the CPU fan if these pins are incorrectly used. **These are not jumpers, do not place jumper caps over these pins.**

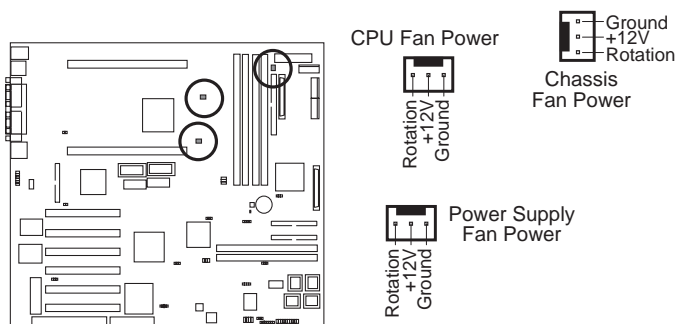

P2B-D2 12Volt Cooling Fan Power

III. INSTALLATION

13. Main and Auxilliary AT Power Connectors (12-pin & 6-pin PWRCON)

This connector connects to a standard 5 Volt power supply. To connect the leads from the power supply, ensure first that the power supply is not plugged into an AC outlet. Most power supplies provide two plugs (P8 and P9), each containing six wires, two of which are black. An auxilliary connector (P10) is provided in case the power supplied through the main connectors are insufficient. Orient the main connectors so that the black wires are located in the middle.

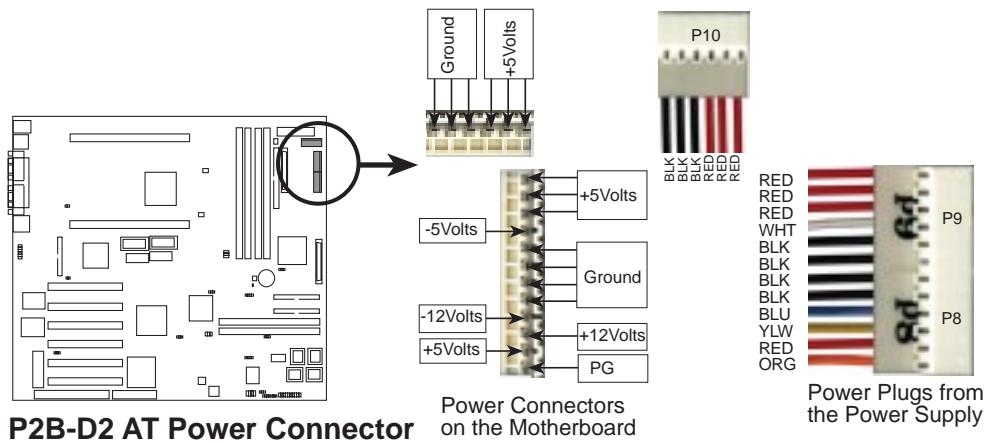

Using a slight angle, align the plastic guide pins on the lead to their receptacles on the connector. Once aligned, press the lead onto the connector until the lead locks into place.

14. ATX Power Supply Connector (20-pin ATXPWR)

This connector connects to an ATX power supply. The plug from the power supply will only insert in one orientation because of the different hole sizes. Find the proper orientation and push down firmly but gently making sure that the pins are aligned.

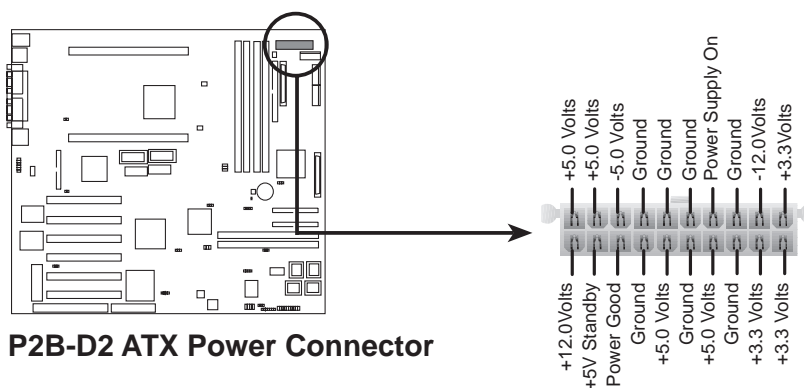

IMPORTANT: Make sure that your ATX power supply can supply at least 10mA on the 5-volt standby lead (+5VSB). You may experience difficulty in powering on your system if your power supply cannot support the load. For Wake-On-LAN support, your ATX power supply must supply at least 720mA (+5VSB).

III. INSTALLATION

15. Message LED Lead (2-pin MSG.LED)

This indicates whether a message has been received from a fax/modem. The LED will remain lit when there is no signal and blink when there is data transfer or waiting in the inbox. This function requires ACPI OS and driver support.

16. System Management Interrupt Lead (2-pin SMI)

This allows the user to manually place the system into a suspend mode or “Green” mode where system activity is decreased to save electricity and expand the life of certain components when the system is not in use. This 2-pin connector connects to the case-mounted suspend switch. If you do not have a switch for the connector, you may use the “Turbo Switch”. SMI is activated when it detects a *short to open* moment and therefore leaving it shorted will not cause any problems. This may require one or two presses depending on the position of the switch. Wake-up can be controlled by settings in the BIOS but the keyboard will always allow wake-up (the SMI lead cannot wake up the system). If you want to use this connector, set “Suspend Mode” under the **Power Management Setup** of the BIOS SOFTWARE section to the preferred time after which the system must go into suspend mode when you press the switch.

17. ATX Power Switch / Soft Power Switch (2-pin PWR.SW)

The system power is controlled by a momentary switch connected to this lead. Pressing the button once will switch the system between ON and SLEEP or ON and SOFT OFF depending on the “PWR Button” setting under the **Power Management Setup** of the BIOS SOFTWARE section. Pressing the switch while in the ON mode for more than 4 seconds will turn the system off. The system power LED shows the status of the system’s power.

18. Reset Switch Lead (2-pin RESET)

This 2-pin connector connects to the case-mounted reset switch for rebooting your computer without having to turn off your power switch. This is a preferred method of rebooting to prolong the life of the system’s power supply.

19. System Power LED (3-1 pin PWR.LED)

This 3-1 pin connector connects the system power LED, which lights when the system is powered on and blinks when it is in sleep mode.

20. Keyboard Lock Switch Lead (2-pin KEY LOCK)

This 2-pin connector connects to the case-mounted key switch to allow keyboard locking.

21. Speaker Connector (4-pin SPEAKER)

This 4-pin connector connects to the case-mounted speaker.

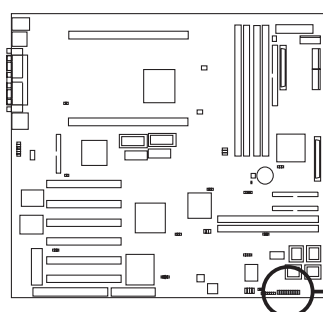

P2B-D2 System Panel Connections

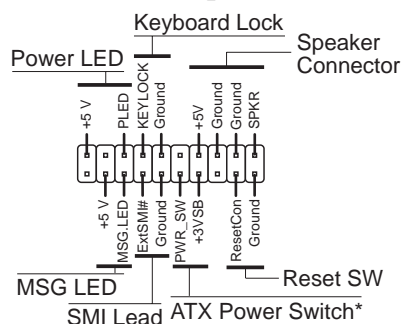

* Requires an ATX power supply.

III. INSTALLATION

22. 50-pin Narrow/68-pin Wide/68-pin Ultra2 SCSI Connectors

This motherboard has onboard 50-Pin Narrow SCSI connector for 8-bit SCSI devices, 68-Pin Wide SCSI connector for 16-bit SCSI devices, and 68-Pin Ultra2 SCSI connector for 16-bit differential SCSI devices.

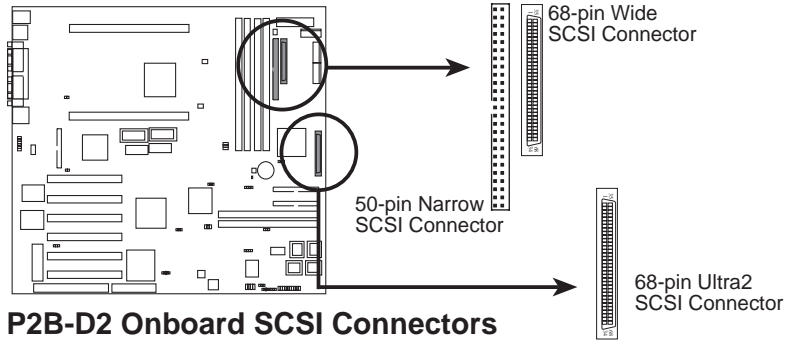

NOTE: A maximum of 15 devices can be connected using any combination of 50-pin Narrow SCSI, 68-pin Wide SCSI, and 68-pin Ultra2 SCSI devices.

The onboard Adaptec AIC-7890AB chipset incorporates an advanced multimode I/O cell that supports both single-ended (SE) and Ultra2 devices. With Ultra2 devices, the SCSI bus platform performs at full Ultra2 speeds (up to 40 MB/sec in 8-bit mode and up to 80 MB/sec in 16-bit mode) and extended cabling 12m (or 25m in a point-to-point configuration). When an SE device is attached, the bus defaults to an SE speed and cable length.

In mixed environments of Ultra2 and SE devices, the onboard host adapter can be coupled with the Adaptec AIC-3860 transceiver chipset to bridge the compatibility gap. By dividing the SCSI bus into independent SE and low voltage differential (LVD) segments, the transceiver chipset supports legacy devices without limiting performance and cable length on the LVD segment.

IMPORTANT: Connect SCSI devices as shown. Mixing SCSI devices will lower performance.

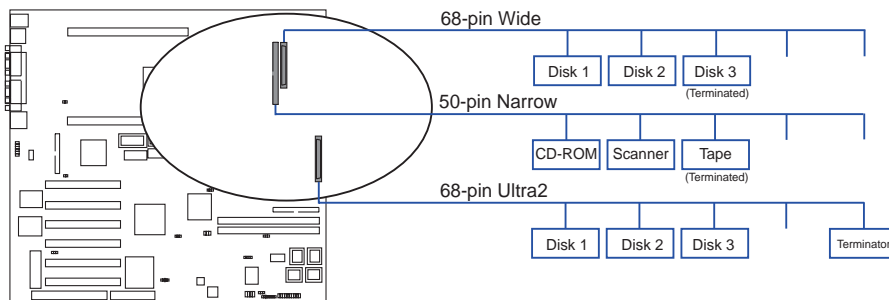

NOTE: Ultra2 devices do not have termination jumpers and must use a separate terminator on the last connector.

III. INSTALLATION

23. SB-Link™ Connector (6-1 pin SBLINK)

Using Intel's PC-PCI and serialized IRQ protocols found in this motherboard's AGPset, this connector allows Sound Blaster 16 compatibility to AWE64D (Digital) or other PCI audio cards, enabling users to play Real-mode DOS games and multimedia applications. SB-Link acts as a bridge between the motherboard and the PCI audio card by providing the DMA and IRQ signals present in the ISA bus but not available on the PCI bus.

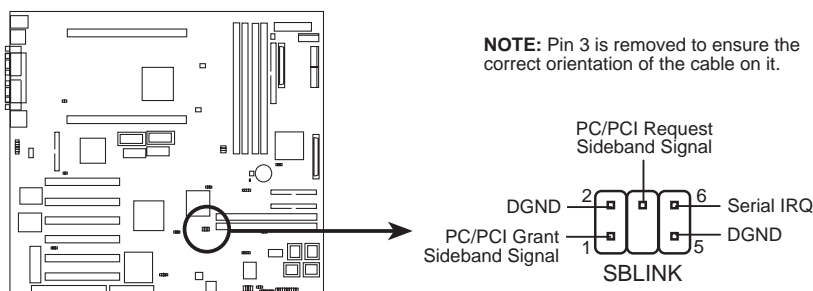

NOTE: Pin 3 is removed to ensure the correct orientation of the cable on it.

P2B-D2 SB-Link™ Connector

24. Floppy Disk Drive Connector (34-1pin FLOPPY)

This connector supports the provided floppy disk drive ribbon cable. After connecting the single end to the board, connect the two plugs on the other end to the floppy drives. **(Pin 5 is removed to prevent inserting in the wrong orientation when using ribbon cables with pin 5 plugged).**

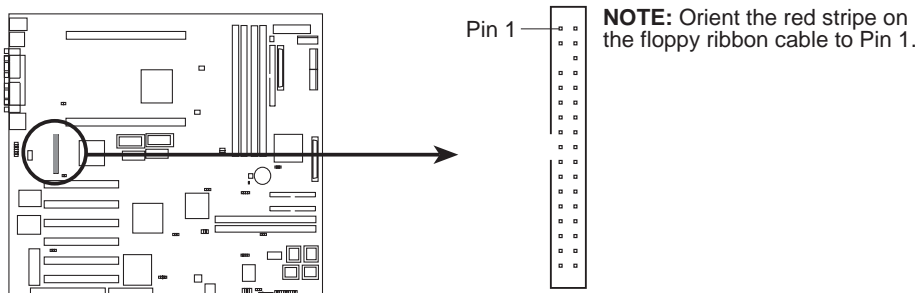

NOTE: Orient the red stripe on the floppy ribbon cable to Pin 1.

P2B-D2 Floppy Disk Drive Connector

25. Serial Port Header (10-1 pin COM2)

The serial port bracket can be used to add an additional serial port for additional serial devices.

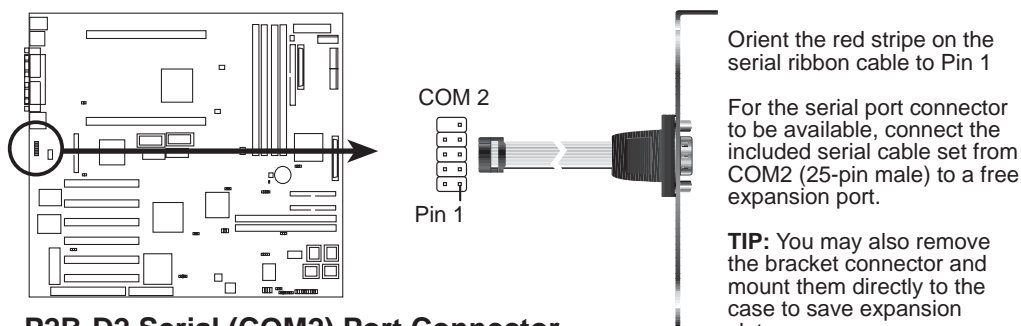

Orient the red stripe on the serial ribbon cable to Pin 1

For the serial port connector to be available, connect the included serial cable set from COM2 (25-pin male) to a free expansion port.

TIP: You may also remove the bracket connector and mount them directly to the case to save expansion slot space.

P2B-D2 Serial (COM2) Port Connector

III. INSTALLATION

26. VGA Memory Upgrade Sockets

This motherboard comes with 1MB VGA memory onboard. Two sockets are provided to upgrade the VGA memory to 2MB by adding two EDO DRAMs.

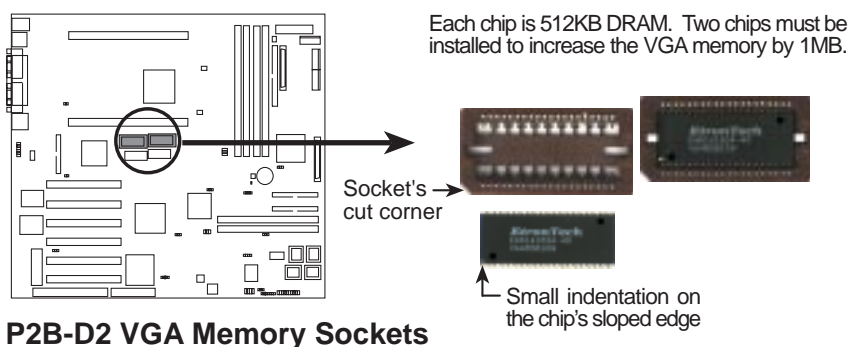

NOTE: The indentations are shown white for visibility, they are normally black.

Match the small indentation on the chip's sloped edge with the socket's cut corner. Place the chip flat and evenly into the socket and press firmly but carefully so that the chip enters evenly. When installed, the chip should be flush with the socket.

III. INSTALLATION

(This page was intentionally left blank.)



III. INSTALLATION

Power Connection Procedures

1. After all connections are made, close the system case cover.
 2. Be sure that all switches are off (in some systems, marked with ○).
 3. Connect the power supply cord into the power supply located on the back of your system case according to your system user's manual.
 4. Connect the power cord into a power outlet that is equipped with a surge protector.
 5. You may then turn on your devices in the following order:
 - a. Your monitor
 - b. External SCSI devices (starting with the last device on the chain)
 - c. Your system power. For ATX power supplies, you need to switch on the power supply as well as press the ATX power switch on the front of the case.
 6. The power LED on the front panel of the system case will light. For ATX power supplies, the system LED will light when the ATX power switch is pressed. The LED on the monitor may light up or switch between orange and green after the system's if it complies with "green" standards or if it has a power standby feature. The system will then run power-on tests. While the tests are running, additional messages will appear on the screen. If you do not see anything within 30 seconds from the time you turn on the power, the system may have failed a power-on test. Check your jumper settings and connections or call your retailer for assistance.
 7. During power-on, hold down <Delete> to enter BIOS setup. Follow the instructions in the next section, **BIOS SOFTWARE**.
- * **Powering Off your computer:** You must first exit or shut down your operating system before switching off the power switch. For ATX power supplies, you can press the ATX power switch after exiting or shutting down your operating system. If you use Windows 95, click the **Start** button, click **Shut Down**, and then click **Shut down the computer?**. The system will then power off after Windows shuts down.

NOTE: The message "You can now safely turn off your computer" will not appear when shutting down with ATX power supplies.

IV. BIOS SOFTWARE

Flash Memory Writer Utility

AFLASH.EXE: This is the Flash Memory Writer utility that updates the BIOS by uploading a new BIOS file to the programmable flash ROM chip on the motherboard. To determine the BIOS version of your motherboard, check the last four numbers of the code displayed on the upper left-hand corner of your screen during bootup. Larger numbers represent a newer BIOS file. This file works only in DOS mode.

NOTE: The following screen displays are provided as examples only and may not reflect the screen contents displayed on your system.

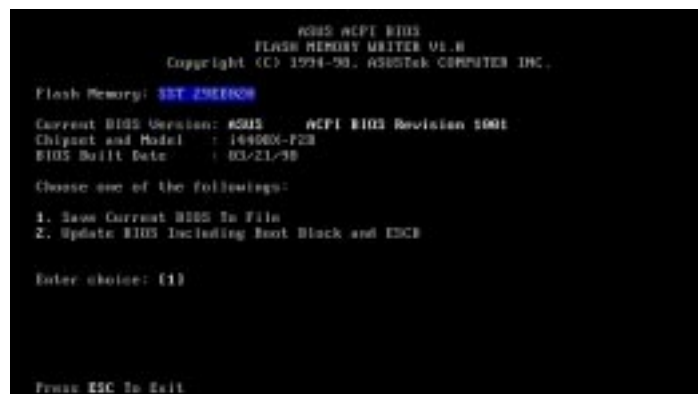

```
ACPI BIOS
FLASH MEMORY WRITER V1.0
Copyright (C) 1994-99, ASUS/ASUS COMPUTER INC.

Flash Memory: 327.2501028

Current BIOS Version: 6005 ACPI BIOS Revision 5001
Chipset and Model : 144000-F23
BIOS Build Date : 03/21/98

Choose one of the following:
1. Save Current BIOS To File
2. Update BIOS Including Boot Block and ESCD

Enter choice: [1]

Press ESC To Exit
```

WARNING! If “unknown” is displayed after **Flash Memory:**, the memory chip is either not programmable or is not supported by the ACPI BIOS and therefore, cannot be programmed by the Flash Memory Writer utility.

Main Menu

1. Save Current BIOS To File

This option allows you to save a copy of the original motherboard BIOS in case you need to reinstall it. It is recommended that you save **AFLASH.EXE** and the BIOS file to a bootable floppy disk.

To save your current BIOS, type [1] at the **Main Menu** and then press <Enter>. The **Save Current BIOS To File** screen appears. Type a filename and the path, for example, **A:\XXXXX-X** and then press <Enter>.

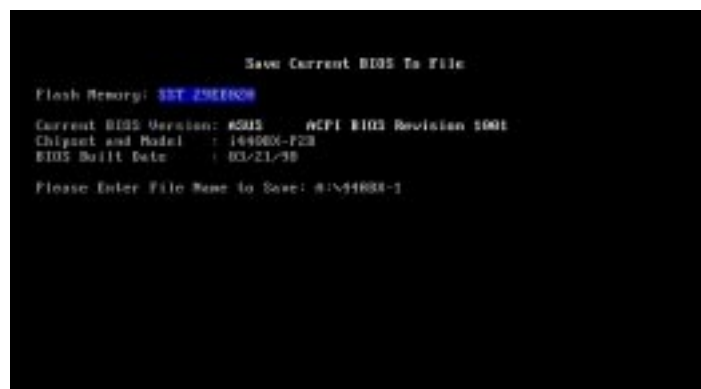

```
Save Current BIOS To File

Flash Memory: 327.2501028

Current BIOS Version: 6005 ACPI BIOS Revision 5001
Chipset and Model : 144000-F23
BIOS Build Date : 03/21/98

Please Enter File Name to Save: A:\41688-1
```

IV. BIOS SOFTWARE

2. Update BIOS Including Boot Block and ESCD

This option updates the boot block, the baseboard BIOS, and the ACPI extended system configuration data (ESCD) parameter block from a new BIOS file. See the next page for procedures on downloading an updated BIOS file.

To update your current BIOS, type [2] at the **Main Menu** and then press <Enter>. The **Update BIOS Including Boot Block and ESCD** screen appears. Type the filename of your new BIOS and the path, for example, **A:\XXXXX.AWD**, and then press <Enter>.

When prompted to confirm the BIOS update, press **Y** to start the update.

The utility starts to program the new BIOS information into the flash ROM. When the programming is finished, *Flashed Successfully* will be displayed.

Follow the onscreen instructions to continue.

```
Update BIOS Including Boot Block and ESCD
Flash Memory: SST-25C1020
Current BIOS Version: #0215 ACPI BIOS Revision 1001
Chipset and Model : 14400X-P2B
BIOS Build Date : 03/21/98
Please Enter File Name for NEW BIOS: 0\N0G211002.AWD
```

```
Update BIOS Including Boot Block and ESCD
Flash Memory: SST-25C1020
BIOS Version
I CURRENT I #0215 ACPI BIOS Revision 1001
IDG211002.AWD #0215 ACPI BIOS Revision 1002
Chipset and Model
I CURRENT I 14400X-<CP2B>-B
IDG211002.AWD 14400X-<CP2B>-B
Date of BIOS Build
I CURRENT I 03/21/98
IDG211002.AWD 03/25/98
Are you sure (Y/N) ? [Y]
```

```
Update BIOS Including Boot Block and ESCD
Flash Memory: SST-25C1020
BIOS Version
I CURRENT I #0215 ACPI BIOS Revision 1001
IDG211002.AWD #0215 ACPI BIOS Revision 1002
Chipset and Model
I CURRENT I 14400X-<CP2B>-B
IDG211002.AWD 14400X-<CP2B>-B
Date of BIOS Build
I CURRENT I 03/21/98
IDG211002.AWD 03/25/98
Are you sure (Y/N) ? [Y]
Programming -- 3FFF
Flashed Successfully
Press ESC To Return to Main Menu
```

```
ASUS ACPI BIOS
FLASH MEMORY WRITER V1.0
Copyright (C) 1994-98, ASUSTek COMPUTER INC.
Flash Memory: SST-25C1020
Current BIOS Version: #0215 ACPI BIOS Revision 1001
Chipset and Model : 14400X-P2B
BIOS Build Date : 03/21/98
Choose one of the followings:
1. Save Current BIOS To File
2. Update BIOS Including Boot Block and ESCD
Enter choice: [1]
You have flashed the EPROM! It is recommended that you turn off
the power, enter SETUP and Load Setup Defaults to have CMOS
updated with new BIOS when exits.
Press ESC To Exit
```

IV. BIOS
Flash Memory Writer

IV. BIOS SOFTWARE

Managing and Updating Your Motherboard's BIOS

Upon First Use of the Computer System

1. Create a bootable system floppy disk by typing [FORMAT A:/S] from the DOS prompt without creating "AUTOEXEC.BAT" and "CONFIG.SYS" files.
2. Copy AFLASH.EXE to the just created boot disk.
3. Run AFLASH.EXE from this new disk and select option **1. Save Current BIOS to File**. See **1. Save Current BIOS To File** on the previous page for more details and the rest of the steps.

Updating BIOS Procedures (only when necessary)

1. Download an updated ASUS BIOS file from the Internet (WWW or FTP) or a BBS (Bulletin Board Service) (see ASUS CONTACT INFORMATION on page 3 for details) and save to the disk you created earlier.
2. Boot from the disk you created earlier.
3. At the "A:\\" prompt, type **AFLASH** and then press <Enter>.
4. At the **Main Menu**, type **2** and then press <Enter>. See **2. Update BIOS Including Boot Block and ESCD** on the previous page for more details and the rest of the steps.

WARNING! If you encounter problems while updating the new BIOS, DO NOT turn off your system since this might prevent your system from booting up. Just repeat the process, and if the problem still persists, update the original BIOS file you saved to disk above. If the Flash Memory Writer utility was not able to successfully update a complete BIOS file, your system may not be able to boot up. If this happens, your system will need service.

IV. BIOS SOFTWARE

6. BIOS Setup

The motherboard supports two programmable Flash ROM chips: 5-Volt and 12-Volt. Either of these memory chips can be updated when BIOS upgrades are released. Use the Flash Memory Writer utility to download the new BIOS file into the ROM chip as described in detail in this section.

All computer motherboards provide a Setup utility program for specifying the system configuration and settings. If your motherboard came in a computer system, the proper configuration entries may have already been made. If so, invoke the Setup utility, as described later, and take note of the configuration settings for future reference; in particular, the hard disk specifications.

If you are installing the motherboard, reconfiguring your system or you receive a Run Setup message, you will need to enter new setup information. This section describes how to configure your system using this utility.

The BIOS ROM of the system stores the Setup utility. When you turn on the computer, the system provides you with the opportunity to run this program. This appears during the Power-On Self Test (POST). Press <Delete> to call up the Setup utility. If you are a little bit late pressing the mentioned key(s), POST will continue with its test routines, thus preventing you from calling up Setup. If you still need to call Setup, reset the system by pressing <Ctrl> + <Alt> + <Delete>, or by pressing the Reset button on the system case. You can also restart by turning the system off and then back on again. But do so only if the first two methods fail.

When you invoke Setup, the CMOS SETUP UTILITY main program screen will appear with the following options:



IV. BIOS SOFTWARE

Load Defaults

The “Load BIOS Defaults” option loads the minimum settings for troubleshooting. **Load Setup Defaults**, on the other hand, is for loading optimized defaults for regular use. Choosing defaults at this level, will modify all applicable settings.

A section at the bottom of the above screen displays the control keys for this screen. Take note of these keys and their respective uses. Another section just below the control keys section displays information on the currently highlighted item in the list.

Standard CMOS Setup

The “Standard CMOS Setup” option allows you to record some basic system hardware configuration and set the system clock and error handling. If the motherboard is already installed in a working system, you will not need to select this option anymore. However, if the configuration stored in the CMOS memory on the board gets lost or damaged, or if you change your system hardware configuration, you will need to respecify the configuration values. The configuration values usually get lost or corrupted when the power of the onboard CMOS battery weakens.



The preceding screen provides you with a list of options. At the bottom of this screen are the control keys for this screen. Take note of these keys and their respective uses.

User-configurable fields appear in a different color. If you need information on the selected field, press <F1>. The help menu will then appear to provide you with the information you need. The memory display at the lower right-hand side of the screen is read-only and automatically adjusts accordingly.

Details of Standard CMOS Setup:

Date

To set the date, highlight the “Date” field and then press either <Page Up>/<Page Down> or <+>/<-> to set the current date. Follow the month, day and year format. Valid values for month, day and year are: **Month: (1 to 12), Day: (1 to 31), Year: (up to 2079).**

IV. BIOS SOFTWARE

Time

To set the time, highlight the “Time” field and then press either <Page Up>/<Page Down> or <+>/<-> to set the current time. Follow the hour, minute and second format. Valid values for hour, minute and second are: **(Hour: (00 to 23), Minute: (00 to 59), Second: (00 to 59))**.

NOTE: You can bypass the date and time prompts by creating an AUTOEXEC.BAT file. For information on how to create this file, please refer to the MS-DOS manual.

Hard Disks

This field records the specifications for all non-SCSI hard disk drives installed in your system. The onboard PCI IDE connectors provide Primary and Secondary channels for connecting up to four IDE hard disks or other IDE devices. Each channel can support up to two hard disks; the first of which is the “master” and the second is the “slave”.

Specifications for SCSI hard disks need not to be entered here since they operate using device drivers and are not supported by the BIOS. If you install other SCSI controller cards, refer to their respective documentations on how to install the required SCSI drivers.

For IDE hard disk drive setup, you can:

- Use the *Auto* setting for detection during bootup.
- Use the IDE HDD AUTO DETECTION in the main menu to automatically enter the drive specifications.
- Enter the specifications yourself manually by using the “User” option.

The entries for specifying the hard disk type include **CYLS** (number of cylinders), **HEAD** (number of read/write heads), **PRECOMP** (write precompensation), **LANDZ** (landing zone), **SECTOR** (number of sectors) and **MODE**. The **SIZE** field automatically adjusts according to the configuration you specify. The documentation that comes with your hard disk should provide you with the information regarding the drive specifications.

The **MODE** entry is for IDE hard disks only, and can be ignored for MFM and ESDI drives. This entry provides three options: *Normal*, *Large*, *LBA*, or *Auto* (see below). Set **MODE** to the *Normal* for IDE hard disk drives smaller than 528MB; set it to *LBA* for drives over 528MB that support Logical Block Addressing (LBA) to allow larger IDE hard disks; set it to *Large* for drives over 528MB that do not support LBA. *Large* type of drive can only be used with MS-DOS and is very uncommon. Most IDE drives over 528MB support the *LBA* mode.

IV. BIOS SOFTWARE

Auto detection of hard disks on bootup

For each field: Primary Master, Primary Slave, Secondary Master, and Secondary Slave, you can select *Auto* under the TYPE and MODE fields. This will enable auto detection of your IDE hard disk during bootup. This will allow you to change your hard disks (with the power off) and then power on without having to reconfigure your hard disk type. If you use older hard disks that do not support this feature, then you must configure the hard disk in the standard method as described earlier by the “User” option.

NOTE: After the IDE hard disk drive information has been entered into BIOS, new IDE hard disk drives must be partitioned (such as with FDISK) and then formatted before data can be read from and write on. Primary IDE hard disk drives must have its partition set to *active* (also possible with FDISK).

NOTE: SETUP Defaults are noted in parenthesis next to each function heading.

Drive A / Drive B (None)

These fields record the types of floppy disk drives installed in your system. The available options for drives A and B are: *360K, 5.25 in.; 1.2M, 5.25 in.; 720K, 3.5 in.; 1.44M, 3.5 in.; 2.88M, 3.5 in.; None*

To enter the configuration value for a particular drive, highlight its corresponding field and then select the drive type using the left- or right-arrow keys.

Floppy 3 Mode Support (Disabled)

This is the Japanese standard floppy drive. The standard stores 1.2MB in a 3.5inch diskette. This is normally disabled but you may choose from either: *Drive A, Drive B, Both, and Disabled*

Video (EGA/VGA)

Set this field to the type of video display card installed in your system. The options are *EGA/VGA, CGA 40, CGA 80, and MONO* (for Hercules or MDA).

If you are using a VGA or any higher resolution card, choose *EGA/VGA*.

Halt On (All Errors)

This field determines which types of errors will cause the system to halt. Choose from *All Errors; No Errors; All,But Keyboard, All,But Diskette; and All,But Disk/Key*.

IV. BIOS SOFTWARE

BIOS Features Setup

The “BIOS Features Setup” option consists of configuration entries that allow you to improve your system performance, or let you set up some system features according to your preference. Some entries are required by the motherboard’s design to remain in their default settings.



A section at the lower right of the screen displays the control keys you can use. Take note of these keys and their respective uses. If you need information on a particular entry, highlight it and then press <F1>. A pop-up help menu will appear to provide you with the information you need. <F5> loads the last set values, <F6> and <F7> loads the BIOS default values and Setup default values, respectively.

NOTE: SETUP Defaults are noted in parenthesis next to each function heading.

Details of BIOS Features Setup

CPU Internal Core Speed

This function is reserved for future use and is currently disabled.

Boot Virus Detection (Enabled)

This field allows you to set boot virus detection, ensuring a virus-free boot sector. This new antivirus solution is unlike native BIOS tools, which offer limited virus protection typically by write-protecting the partition table. With this new solution, your computer is protected against boot virus threats earlier in the boot cycle, that is, before they have a chance to load into your system. This ensures your computer boots to a clean operating system. The system halts and displays a warning message when it detects a virus. If this occurs, you can either allow the operation to continue or use a virus-free bootable floppy disk to restart and investigate your system. Because of conflicts with new operating systems, for example, during installation of new software, you may have to set this to *Disabled* to prevent write errors.

IV. BIOS SOFTWARE

CPU Level 1 Cache / CPU Level 2 Cache (Enabled)

These fields allow you to choose from the default of *Enabled* or choose *Disabled* to turn on or off the CPU's Level 1 and Level 2 built-in cache.

CPU Level 2 Cache ECC Check (Disabled)

This function controls the ECC check capability in the CPU level 2 cache.

BIOS Update (Enabled)

This functions as an update loader integrated into the BIOS to supply the processor with the required data. The BIOS will load the update on all processors during system bootup in the default position of *Enabled*.

Turbo Mode (Disabled)

Leave on default setting for best performance.

Quick Power On Self Test (Enabled)

This field speeds up the Power-On Self Test (POST) routine by skipping retesting a second, third, and fourth time. Setup default setting for this field is *Enabled*. A complete test of the system is done on each test.

HDD Sequence SCSI/IDE First (IDE)

When using both SCSI and IDE hard disk drives, IDE is always the boot disk using drive letter C (default setting of *IDE*). This new feature allows a SCSI hard disk drive to be the boot disk when set to *SCSI*. This allows multiple operating systems to be used on both IDE and SCSI drives or the primary operating system to boot using a SCSI hard disk drive.

Boot Sequence (A,C)

This field determines where the system looks first for an operating system. Options are *A,C*; *C,A*; *A,CDROM,C*; *CDROM,C,A*; *D,A*; *E,A*; *F,A*; *C only*; *LS/ZIP, C*; *LAN, A, C*; and *LAN, C, A*. The setup default setting, *A, C*, is to check first the floppy disk and then the hard disk drive.

Boot Up Floppy Seek (Disabled)

When enabled, the BIOS will seek drive A once.

Floppy Disk Access Control (R/W)

This allows protection of files from the computer system to be copied to floppy disks by allowing the setting of *Read Only* to only allow reads from the floppy disk drive but not writes. The setup default *R/W* allows both reads and writes.

IDE HDD Block Mode Sectors (HDD MAX)

This field enhances hard disk performance by making multi-sector transfers instead of one sector per transfer. Most IDE drives, except older versions, can utilize this feature. Selections are *HDD MAX*, *Disabled*, *2*, *4*, *8*, *16*, and *32*.

HDD S.M.A.R.T. capability (Disabled)

This allows the enabling or disabling of the S.M.A.R.T. (Self-Monitoring, Analysis and Reporting Technology) system which utilizes internal hard disk drive monitoring technology. This feature is normally disabled because system resources used in this feature may decrease system performance.

IV. BIOS SOFTWARE

PS/2 Mouse Function Control (Auto)

The default of *Auto* allows the system to detect a PS/2 mouse on bootup. If detected, IRQ12 will be used for the PS/2 mouse. IRQ12 will be reserved for expansion cards if a PS/2 mouse is not detected. *Enabled* will always reserve IRQ12, whether on bootup a PS/2 mouse is detected or not.

OS/2 Onboard Memory > 64M (Disabled)

When using OS/2 operating systems with installed DRAM of greater than 64MB, you need to set this option to *Enabled* otherwise leave this on *Disabled*.

MPS 1.4 Support (Disabled)

Leave on default setting for best performance.

.....

PCI/VGA Palette Snoop (Disabled)

Some display cards that are nonstandard VGA such as graphics accelerators or MPEG Video Cards may not show colors properly. The setting *Enabled* should correct this problem. Otherwise leave this on the setup default setting of *Disabled*.

Video ROM BIOS Shadow (Enabled)

This field allows you to change the video BIOS location from ROM to RAM. Relocating to RAM enhances system performance, as information access is faster than the ROM.

C8000-CBFFF to DC000-DFFFF (Disabled)

These fields are used for shadowing other expansion card ROMs. If you install other expansion cards with ROMs on them, you will need to know which addresses the ROMs use to shadow them specifically. Shadowing a ROM reduces the memory available between 640K and 1024K by the amount used for this purpose.

Boot Up NumLock Status (On)

This field allows users to activate the Number Lock function upon system boot.

Typematic Rate Setting (Disabled)

When enabled, you can set the two typematic controls listed next. Setup default setting is *Disabled*.

Typematic Rate (Chars/Sec) (6)

This field controls the speed at which the system registers repeated keystrokes. Options range from 6 to 30 characters per second. Setup default setting is **6**; other settings are 8, 10, 12, 15, 20, 24, and 30.

Typematic Delay (Msec) (250)

This field sets the time interval for displaying the first and second characters. Four delay rate options are available: 250, 500, 750, and 1000.

Security Option (System)

When you specify a *Supervisor Password* and/or *User Password* (explained later in this section), the Security Option field determines when the system prompts for the password. *System* prompts for the User Password every time you start your system. *Setup* prompts for the Supervisor Password only when entering the BIOS Setup utility.

IV. BIOS SOFTWARE

Chipset Features Setup

The “Chipset Features Setup” option controls the configuration of the board’s chipset.



NOTE: SETUP Defaults are noted in parenthesis next to each function heading.

Details of Chipset Features Setup

SDRAM Configuration (By SPD)

This sets the optimal timings of settings for items 2–5, depending on the memory modules that you are using. Default setting is *By SPD*, which configures items 2–5 by reading the contents in the SPD (Serial Presence Detect) device. This 8-pin serial EEPROM device stores critical parameter information about the module, such as memory type, size, speed, voltage interface, and module banks.

SDRAM CAS Latency

This controls the latency between SDRAM read command and the time that the data actually becomes available. Leave on default setting.

SDRAM RAS to CAS Delay

This controls the latency between SDRAM active command and the read/write command. Leave on default setting.

SDRAM RAS Precharge Time

This controls the idle clocks after issuing a precharge command to SDRAM. Leave on default setting.

DRAM Idle Timer

This controls the idle clocks before closing an opened SDRAM page. Leave on default setting.

SDRAM MA Wait State (Normal)

This controls the leadoff clocks for CPU read cycles. Leave on default setting.

Snoop Ahead (Enabled)

Enabled will allow PCI streaming. Leave on default setting.

Host Bus Fast Data Ready (Disabled)

Leave on default setting.

IV. BIOS SOFTWARE

16-bit I/O Recovery Time (1 BUSCLK) / 8-bit I/O Recovery Time (1 BUSCLK)
Timing for 16-bit and 8-bit ISA cards, respectively. Leave on default setting.

Graphics Aperture Size (64MB)

Memory-mapped, graphics data structures can reside in a Graphics Aperture. Leave on default setting.

Video Memory Cache Mode (UC)

USWC (uncacheable, speculative write combining) is a new cache technology for the video memory of the processor. It can greatly improve the display speed by caching the display data. You must leave this on the default setting of *UC* (uncacheable) if your display card cannot support this feature, otherwise your system may not boot.

PCI 2.1 Support (Enabled)

This function allows you to enable or disable PCI 2.1 features including passive release and delayed transaction. Leave *Enabled* (default setting) for PCI 2.1 compliancy.

Memory Hole At 15M–16M (Disabled)

Enabling this feature reserves 15MB to 16MB memory address space to ISA expansion cards that specifically require this setting. This makes the memory from 15MB and up unavailable to the system. Expansion cards can only access memory up to 16MB. The default is *Disabled*.

DRAM are xx bits wide

If all your DIMMs have ECC (e.g., 8 chips + 1 ECC chip), they are considered 72bits and the following will be displayed:

```
DRIM are 72 bits wide      ESC : Quit          F10+ : Select Item
Data Integrity Mode      : ECC    F1  : Help          F10/P10/+/- : Modify
                               F5  : Old Values   (Shift)F2 : Color
                               F6  : Load BIOS   Defaults
                               F7  : Load Setup  Defaults
```

If your DIMMs do not have ECC (e.g., 8 chips), they are considered 64 bits and the following will be displayed instead:

```
DRIM are 64 (that 72) bits wide  ESC : Quit          F10+ : Select Item
Data Integrity Mode              : Non-ECC F1  : Help          F10/P10/+/- : Modify
                               F5  : Old Values   (Shift)F2 : Color
                               F6  : Load BIOS   Defaults
                               F7  : Load Setup  Defaults
```

Data Integrity Mode (Non-ECC)

Non-ECC has byte-wise write capability but no provision for protecting data integrity in the memory module array. *EC-Only* data errors are detected but not corrected. *ECC* with hardware scrubbing allows a detection of single-bit and multiple-bit errors and recovery of single-bit errors. (See **2. System Memory**, section III for more information on memory modules.)

Onboard FDC Controller (Enabled)

When *Enabled*, this field allows you to connect your floppy disk drives to the onboard floppy disk drive connector instead of a separate controller card. If you want to use a different controller card to connect the floppy disk drives, set this field to *Disabled*.

IV. BIOS SOFTWARE

Onboard FDC Swap A & B (No Swap)

This field allows you to reverse the hardware drive letter assignments of your floppy disk drives. Two options are available: *No Swap* and *Swap AB*. If you want to switch drive letter assignments through the onboard chipset, set this field to *Swap AB*.

Onboard Serial Port 1 (3F8H/IRQ4)

Settings are *3F8H/IRQ4*, *2F8H/IRQ3*, *3E8H/IRQ4*, *2E8H/IRQ10*, and *Disabled* for the onboard serial connector.

Onboard Serial Port 2 (2F8H/IRQ3)

Settings are *3F8H/IRQ4*, *2F8H/IRQ3*, *3E8H/IRQ4*, *2E8H/IRQ10*, and *Disabled* for the onboard serial connector.

Onboard Parallel Port (378H/IRQ7)

This field sets the address of the onboard parallel port connector. You can select either: *3BCH/IRQ 7*, *378H/IRQ 7*, *278H/IRQ 5*, *Disabled*. If you install an I/O card with a parallel port, ensure that there is no conflict in the address assignments. The PC can support up to three parallel ports as long as there are no conflicts for each port.

Parallel Port Mode (ECP+EPP)

This field allows you to set the operation mode of the parallel port. The setting *Normal*, allows normal-speed operation but in one direction only; *EPP* allows bidirectional parallel port operation at maximum speed; *ECP* allows the parallel port to operate in bidirectional mode and at a speed faster than the maximum unidirectional data transfer rate; *ECP+EPP* allows normal speed operation in a two-way mode.

ECP DMA Select (3)

This selection is available only if you select *ECP* or *ECP+EPP* in the **Parallel Port Mode**. Select either DMA Channel *1*, *3*, or *Disable*.

UART2 Use Infrared (Disabled)

When enabled, this field activates the onboard infrared feature and sets the second serial UART to support the infrared module connector on the motherboard. If your system already has a second serial port connected to the onboard COM2 connector, it will no longer work if you enable the infrared feature. By default, this field is set to *Disabled*, which leaves the second serial port UART to support the COM2 serial port connector. See **IrDA-compliant infrared module connector** under section III.

Onboard PCI IDE Enable (Both)

You can select to enable the *primary* IDE channel, *secondary* IDE channel, *both*, or *disable* both channels (for systems with only SCSI drives).

IDE Ultra DMA Mode (Auto)

This field autodetects Ultra DMA capability (for improved transfer speeds and data integrity) for compatible IDE devices. Set to *Disable* to suppress Ultra DMA capability.

IDE 0 Master/Slave PIO/DMA Mode, IDE 1 Master/Slave PIO/DMA Mode (Auto)

Each channel (0 and 1) has both a master and a slave making four IDE devices possible. Because each IDE device may have a different Mode timing (*0*, *1*, *2*, *3*, *4*), it is necessary for these to be independent. The default setting of *Auto* will allow autodetection to ensure optimal performance.

IV. BIOS SOFTWARE

Power Management Setup

The “Power Management Setup” option allows you to reduce power consumption. This feature turns off the video display and shuts down the hard disk after a period of inactivity.



NOTE: SETUP Defaults are noted in parenthesis next to each function heading.

Details of Power Management Setup

Power Management (User Define)

This field acts as the master control for the power management modes. *Max Saving* puts the system into power saving mode after a brief period of system inactivity; *Min Saving* is almost the same as *Max Saving* except that this time the system inactivity period is longer; *Disable* disables the power saving features; *User Define* allows you to set power saving options according to your preference.

IMPORTANT: Advanced Power Management (APM) should be installed to keep the system time updated when the computer enters suspend mode activated by the BIOS Power Management. For DOS environments, you need to add the statement, `DEVICE=C:\DOS\POWER.EXE`, in your `CONFIG.SYS`. For Windows 3.x and Windows 95, you need to install Windows with the APM feature. A battery and power cord icon labeled “Power” will appear in the “Control Panel.” Choose “Advanced” in the Power Management Field.

Video Off Option (Suspend -> Off)

This field determines when to activate the video off feature for monitor power management. The settings are *Always On* and *Suspend -> Off*.

IV. BIOS SOFTWARE

Video Off Method (DPMS OFF)

This field defines the video off features. The following options are available: *DPMS OFF*, *DPMS Reduce ON*, *Blank Screen*, *V/H SYNC+Blank*, *DPMS Standby*, and *DPMS Suspend*. The DPMS (Display Power Management System) features allow the BIOS to control the video display card if it supports the DPMS feature. *Blank Screen* only blanks the screen (use this for monitors without power management or “green” features. If set up in your system, your screen saver will not display with *Blank Screen* selected). *V/H SYNC+Blank* blanks the screen and turns off vertical and horizontal scanning.

.....

PM Timers

This section controls the time-out settings for the Power Management scheme. The fields included in this section are “HDD Power Down”, which places the hard disk into its lowest power consumption mode, and the “Suspend Mode” which suspends the CPU.

The system automatically “wakes up” from any power saving mode when there is system activity such as when a key is pressed from the keyboard, or when there is activity detected from the enabled IRQ channels.

HDD Power Down (Disable)

Shuts down any IDE hard disk drives in the system after a period of inactivity. This time period is user-configurable to *1–15 Min* or *Disable*. This feature does not affect SCSI hard drives.

Suspend Mode (Disable)

Sets the period of time after which each of these modes activate: *30 sec*, *1 Min*, *2 Min*, *4 Min*, *8 Min*, *20 Min*, *30 Min*, *40 Min*, *1 Hour*, and *Disable*.

.....

Power Up Control

This section determines the ways the system can be controlled when it is started or restarted, when modem activity is detected, or when power to the computer is interrupted and reapplied. The Soft-Off mode refers to powering off the system through a momentary button switch (ATX switch) or through the software as opposed to disconnecting the AC power by way of a rocker switch or other means.

PWR Button < 4 Secs (Soft Off)

When set to *Soft Off*, the ATX switch can be used as a normal system power-off button when pressed for less than 4 seconds. *Suspend* allows the button to have a dual function where pressing less than 4 seconds will place the system in sleep mode. Regardless of the setting, holding the ATX switch for more than 4 seconds will power off the system.

IV. BIOS SOFTWARE

PWR Up On Modem Act (Enabled)

This allows either settings of *Enabled* or *Disabled* for powering up the computer (turns the ATX power supply on) when the modem receives a call while the computer is Soft-off.

NOTE: The computer cannot receive or transmit data until the computer and applications are fully running, thus connection cannot be made on the first try. Turning an external modem off and then back on while the computer is off causes an initialization string that will also cause the system to power on.

AC PWR Loss Restart (Disabled)

This allows you to set whether you want your system to boot up after the power has been interrupted. *Disabled* leaves your system off after reapplying power and *Enabled* boots up your system after reapplying power.

Wake On LAN (Enabled)

This allows you to remotely power up your system through your network by sending a wake-up frame or signal. With this feature, you can remotely upload/download data to/from systems during off-peak hours. *Enabled* sets this feature.

IMPORTANT: This feature requires the optional network interface (see **Network Interface**) and an ATX power supply with at least 720mA +5V standby power.

Automatic Power Up (Disabled)

This allows you to have an unattended or automatic power up of your system. You may configure your system to power up at a certain time of the day by selecting *Everyday*, which will allow you to set the time or at a certain time and day by selecting *By Date*.

.....

Fan Monitor (xxxxRPM)

The onboard hardware monitor is able to detect the Chassis Fan Speed, CPU Fan Speed, and the Power Supply Fan Speed in Rotations Per Minute (RPM). Set to *Ignore* if one of these are not used so that error messages will not be given.

.....

Thermal Monitor (xxxC/xxxF)

The onboard hardware monitor is able to detect the CPU and MB (motherboard) temperatures. Set to *Ignore* only if necessary.

.....

Voltage Monitor (xx.xV)

The onboard hardware monitor is able to detect the voltages put out by the voltage regulators. Set to *Ignore* only if necessary.

NOTE: If any of the monitored items are out of range, an error message will appear: "Hardware Monitor found an error, enter POWER MANAGEMENT SETUP for details". You will then be prompted to "Press **F1** to continue, **DEL** to enter SETUP".

IV. BIOS SOFTWARE

PNP and PCI Setup

The “PNP and PCI Setup” option configures the PCI bus slots. All PCI bus slots on the system use INTA#, thus all installed PCI cards must be set to this value.



NOTE: SETUP Defaults are noted in parenthesis next to each function heading.

Details of PNP and PCI Setup

PNP OS Installed (No)

This field allows you to use a Plug-and-Play (PnP) operating system to configure the PCI bus slots instead of using the BIOS. Thus interrupts may be reassigned by the OS when *Yes* is selected. When a non-PnP OS is installed or to prevent reassigning of interrupt settings, select the default setting of *No*.

Slot 1 IRQ to Slot 3 IRQ (Auto)

These fields set how IRQ use is determined for each PCI slot. The default setting for each field is *Auto*, which uses auto-routing to determine IRQ use. The other options are manual settings of *NA*, *5*, *7*, *9*, *10*, *11*, *12*, *14* or *15* for each slot.

PCI Latency Timer (32 PCI Clock)

The default setting of *32 PCI Clock* enables maximum PCI performance for this motherboard.

IRQ xx Used By ISA (No/ICU)

These fields indicate whether or not the displayed IRQ for each field is being used by a legacy (non-PnP) ISA card. Two options are available: *No/ICU* and *Yes*. The first option, the default value, indicates either that the displayed IRQ is not used or an ISA Configuration Utility (ICU) is being used to determine if an ISA card is using that IRQ. If you install a legacy ISA card that requires a unique IRQ, and you are not using an ICU, you must set the field for that IRQ to *Yes*. For example: If you install a legacy ISA card that requires IRQ 10, then set **IRQ10 Used By ISA** to *Yes*.

IV. BIOS SOFTWARE

DMA x Used By ISA (No/ICU)

These fields indicate whether or not the displayed DMA channel for each field is being used by a legacy (non-PnP) ISA card. Available options include: *No/ICU* and *Yes*. The first option, the default setting, indicates either that the displayed DMA channel is not used or an ICU is being used to determine if an ISA card is using that channel. If you install a legacy ISA card that requires a unique DMA channel, and you are not using an ICU, you must set the field for that channel to *Yes*.

ISA MEM Block BASE (No/ICU)

This field allows you to set the base address and block size of a legacy ISA card that uses any memory segment within the C800H and DFFFH address range. If you have such a card, and you are not using an ICU to specify its address range, select a base address from the six available options; the **ISA MEM Block SIZE** field will then appear for selecting the block size. If you have more than one legacy ISA card in your system that requires to use this address range, you can increase the block size to either 8K, 16K, 36K, or 64K. If you are using an ICU to accomplish this task, leave **ISA MEM Block BASE** to its default setting of *No/ICU*.

Onboard AHA BIOS (Auto)

The default uses *Auto* settings for the onboard Adaptec 7890 SCSI BIOS. If you do not want to use the onboard Adaptec 7890 SCSI BIOS, choose *Disabled*.

ONB AHA BIOS First (No)

This field allows giving priority to the onboard SCSI BIOS for SCSI functions over other add-on SCSI controllers. The default is *No*.

ONB SCSI SE Term. (Enabled)

This allows you to enable or disable the onboard termination for single-ended (SE) devices, such as scanners, CD-ROMs, or tape drives. The default is *Enabled*.

ONB SCSI LVD Term. (Enabled)

This allows you to enable or disable the onboard termination for Ultra2 devices, such as disk drives, using low voltage differential (LVD) technology. The default for this field is *Enabled*.

USB IRQ (Enabled)

Enabled reserves an IRQ# for the USB to work, *Disabled* does not allow the USB to have an IRQ# and therefore prevents the USB from functioning. If you are not using any USB devices, you may set this feature to *Disabled* to save an extra IRQ# for expansion cards.

VGA BIOS Sequence (PCI/AGP)

You can select the search order for your VGA card(s). *PCI/AGP* will detect PCI VGA cards before AGP, and *AGP/PCI* will detect AGP cards before PCI VGA.

IV. BIOS SOFTWARE

Load BIOS Defaults

The “Load BIOS Defaults” option allows you to load the troubleshooting default values permanently stored in the BIOS ROM. These default settings are non-optimal and disable all high performance features. To load these default settings, highlight “Load BIOS Defaults” on the main screen and then press <Enter>. The system displays a confirmation message on the screen. Press <Y> and then <Enter> to confirm. Press <N> and then <Enter> to abort. This feature does not affect the fields on the Standard CMOS Setup screen.

Load Setup Defaults

The “Load Setup Defaults” option allows you to load the default values to the system configuration fields. These default values are the optimized configuration settings for the system. To load these default values, highlight “Load Setup Defaults” on the main screen and then press <Enter>. The system displays a confirmation message on the screen. Press <Y> and then <Enter> to confirm. Press <N> and then <Enter> to abort. This feature does not affect the fields on the Standard CMOS Setup screen.



IV. BIOS SOFTWARE

Supervisor Password and User Password

These two options set the system passwords. “Supervisor Password” sets a password that will be used to protect the system and the Setup utility; “User Password” sets a password that will be used exclusively on the system. By default, the system comes without any passwords. To specify a password, highlight the type you want and then press <Enter>. A password prompt appears on the screen. Taking note that the password is case sensitive, and can be up to 8 alphanumeric characters long, type in your password and then press <Enter>. The system confirms your password by asking you to type it again. After setting a password, the screen automatically reverts to the main screen.



To implement password protection, specify in the “Security Option” field of the BIOS Features Setup screen when the system will prompt for the password. If you want to disable either password, press <Enter> instead of entering a new password when the “Enter Password” prompt appears. A message confirms the password has been disabled.

NOTE: If you forget the password, see **Clear Time Clock (Jumpers)** in section III for procedures on clearing the CMOS.

IV. BIOS SOFTWARE

IDE HDD Auto Detection

The “IDE HDD Auto Detection” option detects the parameters of an IDE hard disk drive, and automatically enters them into the Standard CMOS Setup screen.

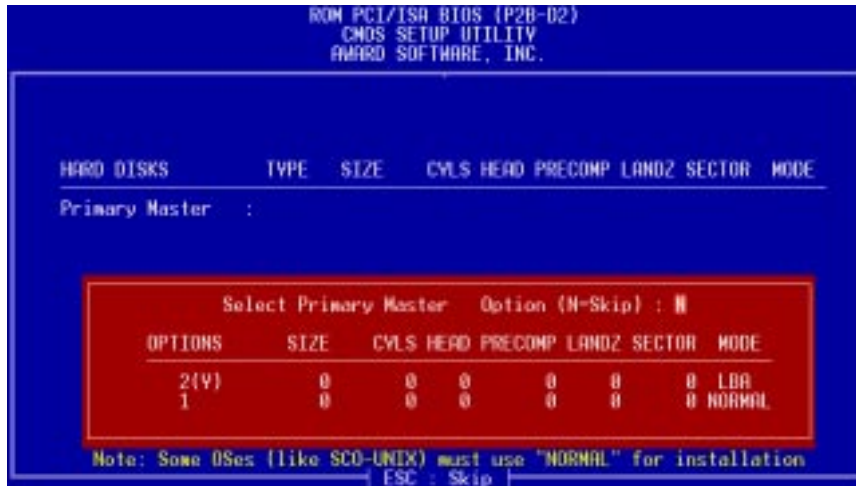

Up to four IDE drives can be detected, with parameters for each listed inside the box. To accept the optimal entries, press <Y> or else select from the numbers displayed under the OPTIONS field (2, 1, 3 in this case); to skip to the next drive, press <N>. If you accept the values, the parameters will appear listed beside the drive letter on the screen. The process then proceeds to the next drive letter. Pressing <N> to skip rather than to accept a set of parameters causes the program to enter zeros after that drive letter.

Remember that if you are using another IDE controller that does not feature Enhanced IDE support for four devices, you can only install two IDE hard disk drives. Your IDE controller must support the Enhanced IDE features in order to use Drive E and Drive F. The onboard PCI IDE controller supports Enhanced IDE, with two connectors for connecting up to four IDE devices. If you want to use another controller that supports four drives, you must disable the onboard IDE controller in the Chipset Features Setup screen.

When auto-detection is completed, the program automatically enters all entries you accepted on the field for that drive in the Standard CMOS Setup screen. Skipped entries are ignored and are not entered in the screen.

If you are auto-detecting a hard disk that supports the LBA mode, three lines will appear in the parameter box. Choose the line that lists LBA for an LBA drive. Do not select Large or Normal.

The auto-detection feature can only detect one set of parameters for a particular IDE hard drive. Some IDE drives can use more than one set. This is not a problem if the drive is new and empty.

IV. BIOS SOFTWARE

IMPORTANT: If your hard disk was already formatted on an older previous system, incorrect parameters may be detected. You will need to enter the correct parameters manually or use low-level format if you do not need the data stored on the hard disk.

If the parameters listed differ from the ones used when the disk was formatted, the disk will not be readable. If the auto-detected parameters do not match the ones that should be used for your disk, do not accept them. Press <N> to reject the presented settings and enter the correct ones manually from the Standard CMOS Setup screen.

Save & Exit Setup

Select this option to save into the CMOS memory all modifications you specified during the current session. To save the configuration changes, highlight the “Save & Exit Setup” option on the main screen, type “Y”, and then press <Enter>.



Exit Without Saving

Select this option to exit the Setup utility without saving the modifications you specify during the current session. To exit without saving, highlight the “Exit Without Saving” option on the main screen and then press <Enter>.

(This page was intentionally left blank.)

V. SUPPORT CD



V. Support CD

V. SUPPORT CD

V. SUPPORT CD	61
WINDOWS 98	64
A. Install Intel LAN Driver	64
B. Install S3 VGA Driver	66
Installing the Driver When Installing Windows 98	66
Updating the Driver	66
Installing DirectX	67
C. Install Adaptec AIC-7890 Driver	68
D. BusMaster	69
E. Install Patch for PIIX4 Chipset	71
F. PC-cillin Anti-virus Setup	73
WINDOWS NT 4.0	77
Windows NT 4.0 Support CD Main Menu	77
A. Making an I2O SAC Utility Boot Diskette	78
B. Install Intel LAN Driver	81
C. Installing the S3 VGA Driver	83
D. Install Adaptec AIC-7890 Driver	85
Installing Windows NT v4.0 with the FMS Driver	85
Updating the FMS Driver under Windows NT v4.0	86
Removing a Host Adapter from Windows NT v4.0	87
Swapping a Host Adapter for v4.0	88
E. BusMaster	89
Verifying Driver Installation in Windows NT 4.0	90
IBM OS/2	91
A. Install S3 VGA Driver	91
B. Install Adaptec AIC-7890 Driver	97
Installing a New Driver or Updating an Existing Driver for IBM OS/2 2.1X/Warp/SMP	97
First-Time Installation of IBM OS/2 2.1X/Warp/SMP From Floppy Diskette	98
First-Time Installation of IBM OS/2 2.1X From CD-ROM	100
First-Time Installation of IBM OS/2 Warp 3.x, 4.0 or 4.0 SMP From CD-ROM	102
C. BusMaster	109

V. SUPPORT CD

Windows 98 Support CD Main Menu

Insert your support CD or double-click your CD drive icon in “My Computer” to bring up the autorun menu or run Setup.exe in the root directory of the ASUS support CD.

NOTE: The CD version and contents are constantly modified without notice.

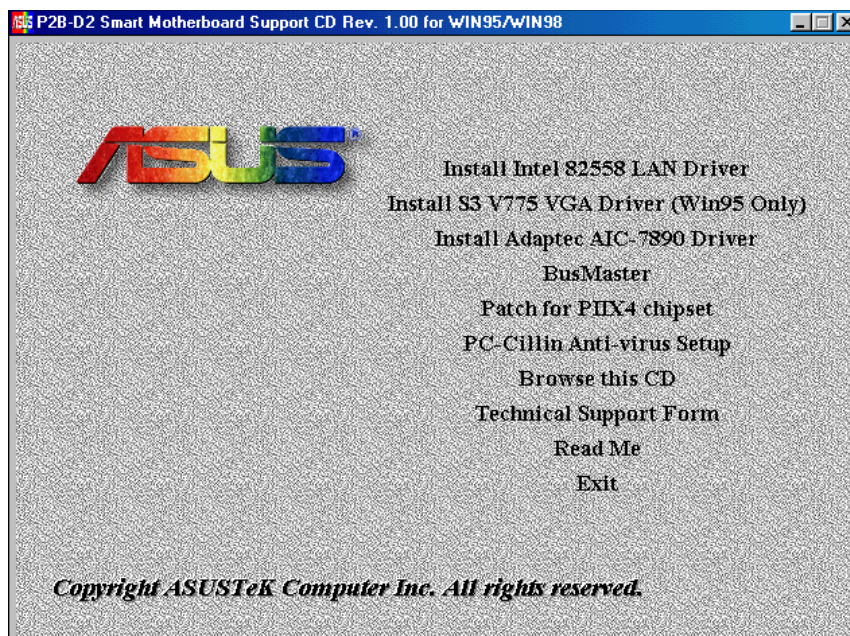

- A. Install Intel 82558 LAN Driver:** Installs the EtherExpress™ PRO/100+ adapter driver.
- B. Install S3 V775 VGA Driver (Win95 only):** Installs the video driver for the onboard VGA chipset.
- C. Install Adaptec AIC-7890 Driver:** Installs the driver that enables the Adaptec Family host adapter to communicate with your computer.
- D. BusMaster:** Installs the Intel BusMaster IDE drivers.
- E. Patch for PIIX4 chipset:** Installs the necessary drivers for PCI card and PCI bridge for Windows 95/95a (OSR1) and 95b (OSR2) for ASUS motherboards. **NOTE:** This is for Windows 95 only.
- F. PCCillin Anti-virus Setup:** Installs “PC-cillin” virus protection software. View the online help if you have any questions.
- G. Browse this CD:** Allows you to see the contents of the ASUS support CD.
- H. Technical Support Form:** Allows you to view the Technical Support Form (with a text editor, such as Notepad).
- I. Read Me:** View additional notes with Notepad.
- J. Exit:** Exit the selection menu.

Additional CD Contents: DMI Configuration Utility in the **DMI** directory and Flash BIOS writer in the **AFLASH** directory.

A. Install Intel LAN Driver

Automatic Configuration

Some computers automatically detect and configure adapters or interfaces while booting. The network interface's IRQ level and I/O address of this motherboard are automatically set by the BIOS each time you start your computer.

Start your computer to automatically configure the network interface or adapter. Configuration is complete when Windows 98 starts. If your computer displays an error while booting, it may require additional steps to configure.

1. Start the system with Windows 98 installed.
2. From "Start", point to **Settings**, and then click on the **Control Panel** icon.
3. In Control Panel, double-click the **System** icon.
4. Select **Device Manager**, and then double-click **Network adapters**.
5. Select the driver, and then click **Update Driver**.
6. Click **Next**.
7. Select **Search for a better driver than the one your device is using now. (Recommended)**, and then click **Next**.
8. Select **Specify a Location**, and insert the ASUS P2B-D2 CD. Browse or type the path to E:\LAN (Where E is your CD-ROM drive), and then click **Next**.
9. Select **The update driver (Recommended)**, and then click **Next**.
NOTE: If you don't see this message, click **Back**. Check that the ASUS P2B-D2 CD is inserted and the path is correct, and follow then go back to step 8.
10. If the step is correct, you will see the message "Location of driver: ASUS E:\LAN\NET82557.INF". Click **Next**.
11. Click **Finish**.
12. Close the *Update Driver* window.
13. Close the *System Properties* window.
14. Restart your computer.

After restarting Windows 98, you should be able to connect to your network by double-clicking Network Neighborhood.

WINDOWS 98

Troubleshooting

If you can't connect to a server or if Windows 98 reports an error after you double-click Network Neighborhood, try the suggestions here first, then the Troubleshooting section if necessary.

- Make sure you're using the drivers that are on the Support CD that ships with this network interface or adapter.
- Make sure the driver is loaded and the protocols are bound. Check the *Device Properties* list for trouble indicators (an X or ! symbol).
- Check with your LAN administrator — you may need to install supplemental networking software.

NetWare Server, Client 32, UNIX, OS/2, Banyan, and Other Operating Systems

For these, refer to our online documents. On a DOS computer, view the appropriate README file for information on installing your network driver.

B. Install S3 VGA Driver

Installing the Driver When Installing Windows 98

Windows 98 will automatically detect and install the correct VGA driver.

Updating the Driver

1. Right-click **My Computer** and click **Properties**.
2. Click the **Device Manager** tab.
3. Double-click **Display adapters** and double-click the driver you wish to update. If a yellow question mark is displayed, double-click the question mark.
4. Click the **Driver** tab and click **Update Driver**. The *Update Device Driver Wizard* window appears.
5. Click **Next**.



6. Select the **Search for a better driver than the one...** option and click **Next**.
7. Insert your Windows 98 Installation CD into your CD-ROM drive.
8. Select **Specify a Location**, type or browse to **D:\DRIVERS\DISPLAY\S3\86C260M5**, and click **Next**.



9. Follow the onscreen instruction to complete the installation.



WINDOWS 98

Installing DirectX

Microsoft DirectX allows Direct3D support in Windows.

1. Insert the ASUS Support CD or double-click on your CD drive icon in My Computer to bring up the autorun screen or run Setup.exe in the root directory of the CD.
2. Click **Browse this CD**.



3. Double-click **Dxsetup.exe** located in **E:\Vga\Dx3a\DirectX**.
4. Click the **ReInstall DirectX** button in the *DirectX(tm) Setup* window.

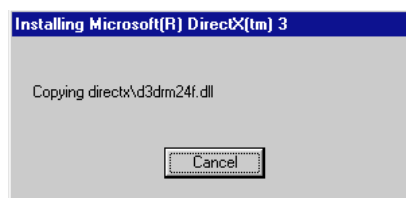

5. After Setup is finished, you will be prompted to restart your computer. Click **OK** to restart and to complete Setup.



C. Install Adaptec AIC-7890 Driver

1. Start the system with Windows 98 installed.
2. From "Start", point to **Settings**, and then click on the **Control Panel** icon.
3. In Control Panel, double-click the **System** icon.
4. Select **Device Manager**, double-click **SCSI controllers**, and then double-click **Adaptec AHA-2940U2/AHA-2940U2W PCI SCSI Controller**.
5. Select the driver, and then click **Update Driver**.
6. Click **Next**.
7. Select **Search for a better driver than the one your device is using now. (Recommended)**, and then click **Next**.
8. Select **Specify a Location**, and insert the ASUS P2B-D2 CD. Browse or type the path to E:\SCSI\WIN98 (Where E is your CD-ROM drive), and then click **Next**.
9. If the step is correct, you will see the message "location of driver: ASUS D:\SCSI\WIN95\AIC78XX.INF". Click **Next**.
10. If you see the *Version Conflict* window, click **Yes** to keep the files.
11. Click **Finish**.
12. Click **Yes** to restart your computer.

D. BusMaster

1. Insert the ASUS Support CD into your CD-ROM drive or double-click the CD drive icon in My Computer to bring up the autorun screen or run Setup.exe in the root directory of your CD-ROM drive.

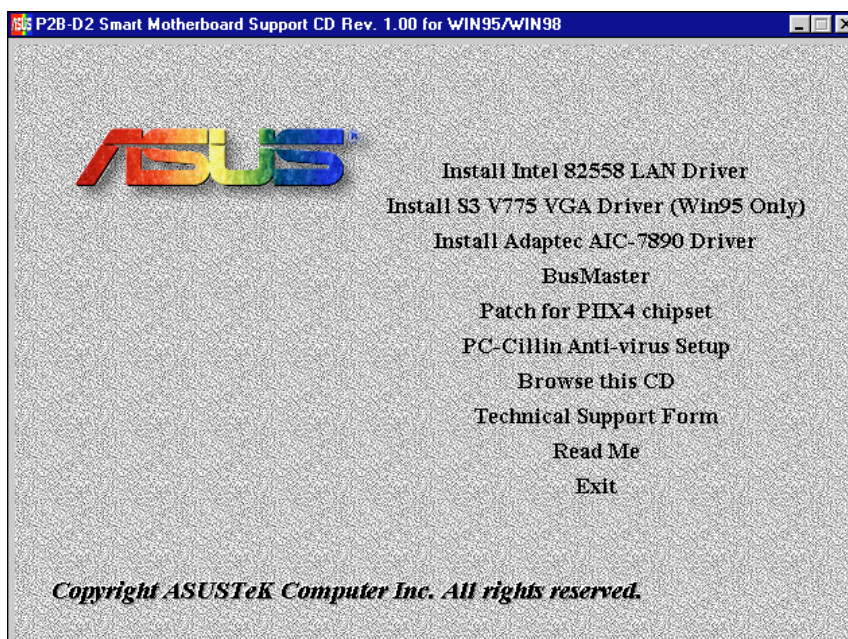

2. Click **BusMaster** on the autorun screen. The *Welcome* window appears.

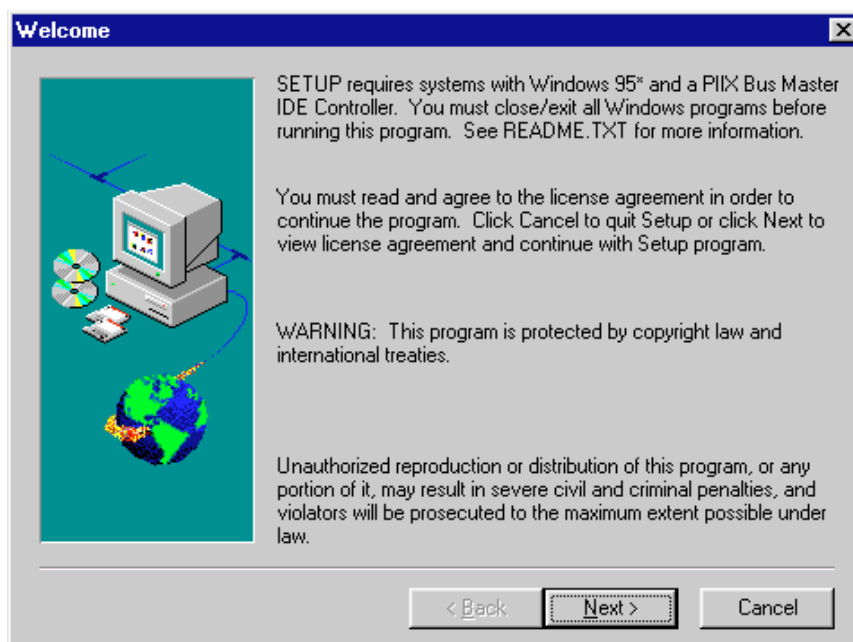

3. Click **Next** and the Software Use and Distribution Licence Agreement appears.

WINDOWS 98

4. Close the file after carefully reading the agreement. The following window will appear.

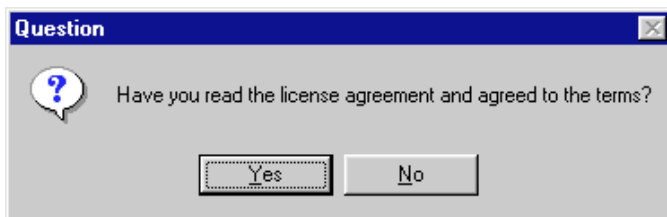

5. Click **Yes**, and the *Select Components* window opens.

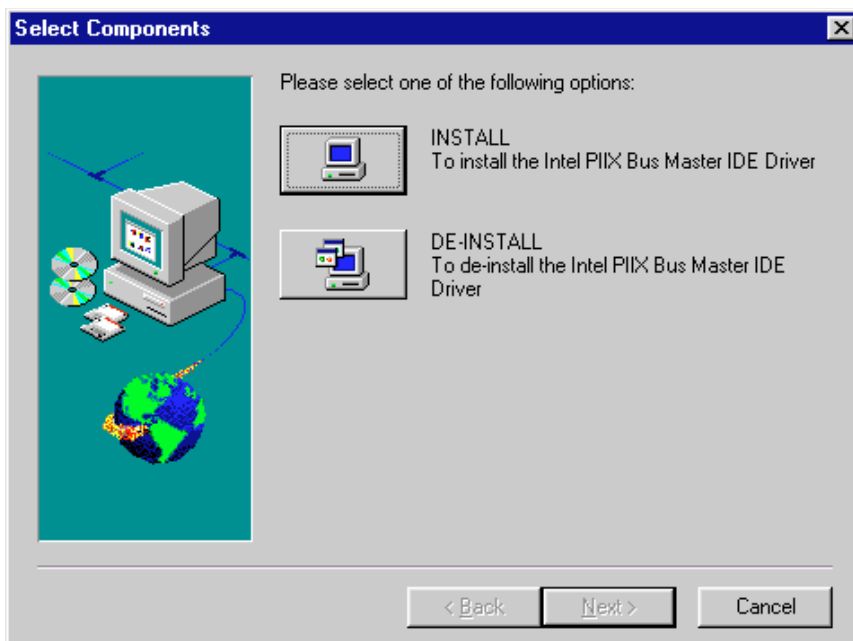

6. Click the **Install** button.

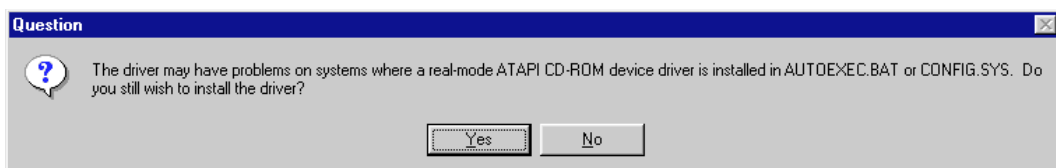

7. Click **Yes** to begin installation. When installation is finished, you will be asked to restart.

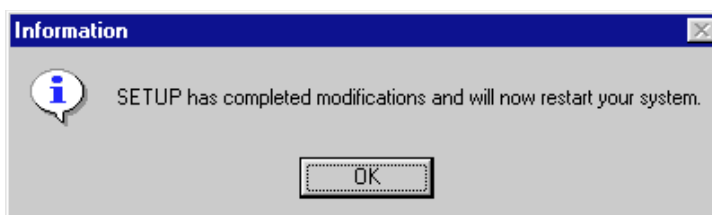

8. Click **OK** to restart.

WINDOWS 98

E. Install Patch for PIIX4 Chipset

NOTE: This is required for Windows 95 only.

1. Insert the ASUS Support CD into your CD-ROM drive or double-click the CD drive icon in My Computer to bring up the autorun screen or run Setup.exe in the root directory of your CD-ROM drive.

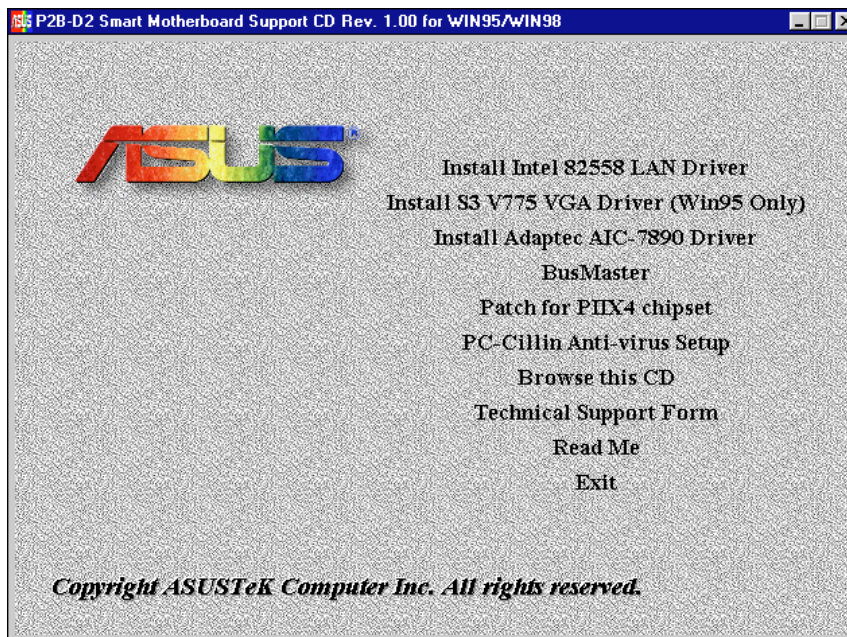

2. Click **Patch for PIIX4 chipset**, The *Setup Utility* window appears.

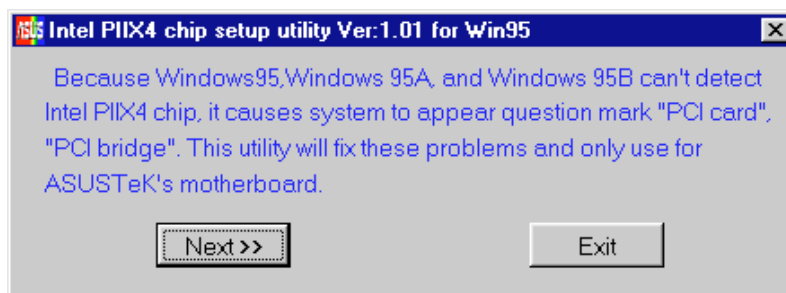

WINDOWS 98

3. Click **Next**.

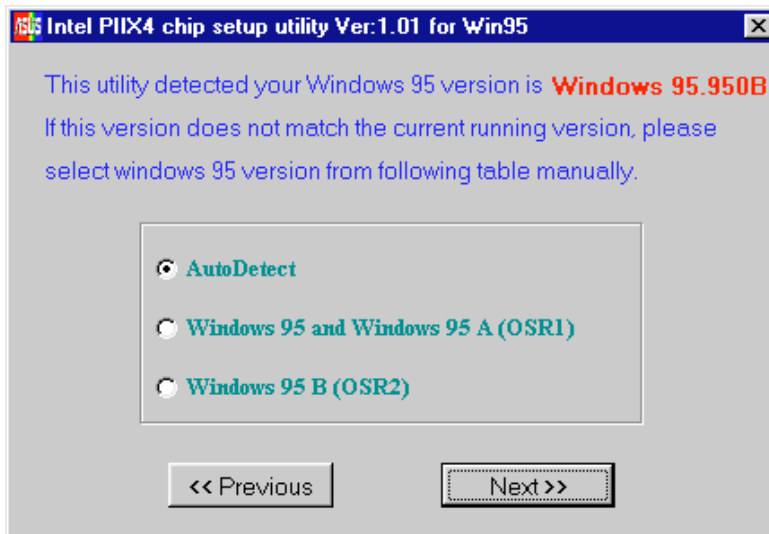

4. Select **AutoDetect** and then click **Next**.



5. When prompted to restart, click **Restart Now**.

F. PC-cillin Anti-virus Setup

1. Insert the ASUS Support CD into your CD-ROM drive or double-click the CD drive icon in My Computer to bring up the autorun screen or run Setup.exe in the root directory of your CD-ROM drive.



2. Click **PC-Cillin Anti-virus Setup**. The *PC-cillin Welcome* window appears.



3. Click **Next** to start the pre-installation virus scan.



WINDOWS 98

3. Once PC-cillin has finished scanning your system for viruses, the *Registration* window appears.

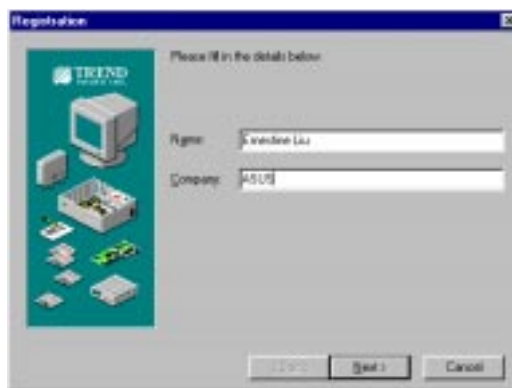

4. Fill in your name and organization and click **Next**. The *Choose Destination Location* window appears.



5. To install to the default directory, click **Next**.
To install to a different directory, click **Browse**.

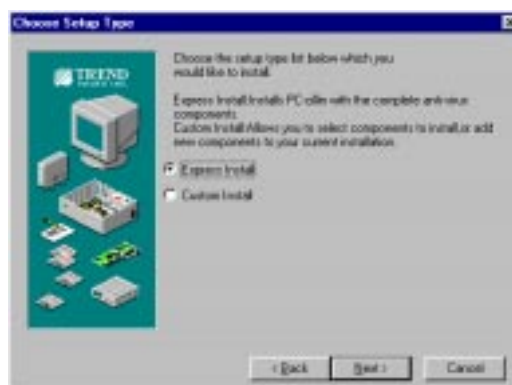

6. Select **Express Install**, and then click **Next**. The program files will then be copied to your hard disk drive.

WINDOWS 98

7. When the *Create Emergency Clean Disk* window appears, insert a floppy disk into your floppy disk drive and click **Start**.

NOTE: To create this bootable disk later after the installation is complete, click **Skip**.

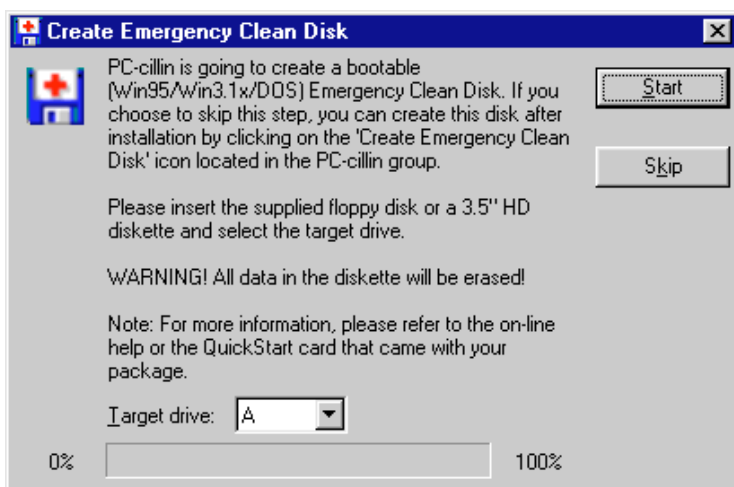

8. Once the Emergency Clean disk is created, click **OK** and remove your floppy disk.



9. When the *Setup Complete* windows appears, click **Finish** and follow the online instructions to complete installation.

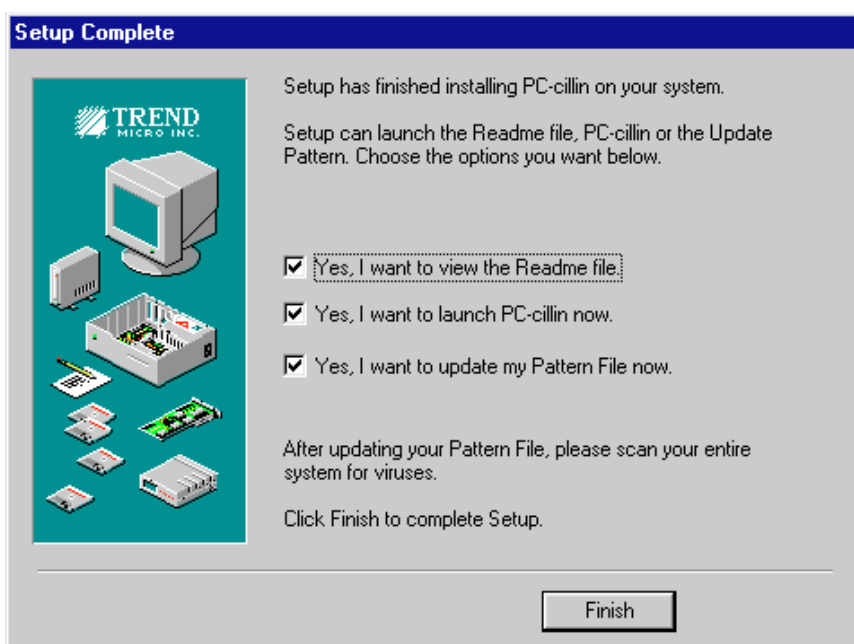

WINDOWS 98

(This page was intentionally left blank)

WINDOWS NT 4.0

Windows NT 4.0 Support CD Main Menu

Insert your support CD or double-click your CD drive icon in “My Computer” to bring up the autorun menu or run Setup.exe in the root directory of the ASUS support CD.

NOTE: The CD version and contents are constantly modified without notice.

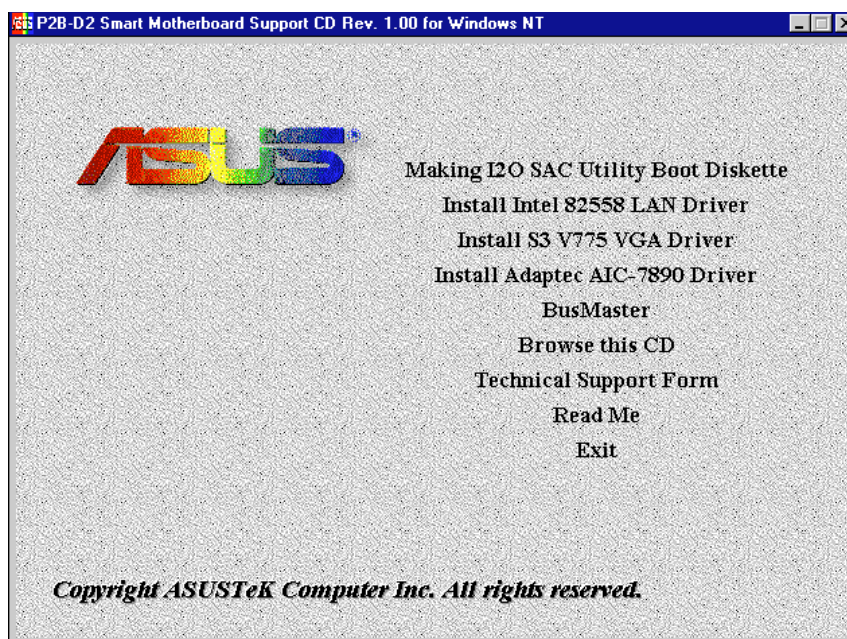

- A. **Making I2O SAC Utility Boot Diskette:** Installs the EtherExpress™ PRO/100+ adapter driver.
- B. **Install Intel 82558 LAN Driver:** Installs the EtherExpress™ PRO/100+ adapter driver.
- C. **Install S3 V775 VGA Driver:** Installs the video driver for the onboard VGA chipset.
- D. **Install Adaptec AIC-7890 Driver:** Installs the driver that enables your Adaptec 7800 Family host adapter to communicate with your computer.
- E. **BusMaster:** Installs the Intel BusMaster IDE drivers.
- F. **Browse this CD:** Allows you to see the contents of the ASUS support CD.
- G. **Technical Support Form:** Allows you to view the Technical Support Form (with a text editor, such as Notepad).
- H. **Read Me:** View additional notes with Notepad.
- I. **Exit:** Exit the selection menu.

Additional CD Contents: DMI Configuration Utility in the **DMI** directory and Flash BIOS writer in the **AFLASH** directory.

WINDOWS NT 4.0

A. Making an I2O SAC Utility Boot Diskette

1. The software is distributed in the form of either a self-extracting .exe file, sac.exe, or a set of files on a floppy disk. In the case of a self-extracting .exe file, copy the sac.exe file to a temporary directory, change directories to the temporary directory, and type `SAC.EXE` to extract the distribution files. In the case of a floppy disk distribution, copy the files to a temporary directory and change directories to the temporary directory.
2. Use a text editor to read the license information in the file license.txt.
3. Create a DOS bootable disk. (For this example, a floppy disk is assumed to be the boot device.) To format a diskette, type the following command:
`FORMAT /S /V A:`
4. In the root directory of the boot disk, use a text editor such as Notepad to create a config.sys file that contains the following commands:
`files=20`
`buffers=30`
`device=a:\dit.exe /e /t:200`
5. Type `INSTALL.BAT A:` to install the program files to the floppy disk. This won't install the source files. For information on installing the program files and the source files, type `INSTALL`.

NOTE: This is the first official release of the SAC utilities. All previous versions and associated files will no longer be supported. Please do not use any of the files from previous versions.

WINDOWS NT 4.0

Using I2O

1. Make sure that the iRTOS embedded in all IOPs properly supports the operations that the SAC utilities provide. For example, iRTOS upgrade is supported in some iRTOS versions and not in others. Consult your iRTOS vendor's documentation for details on supported and unsupported I2O(R) messages. The typical messages of concern are ExecSwDownload and ExecConfigValidate.
2. Boot off of the bootable disk.
3. Type "iopsetup main.htm".

NOTES:

- * Many early PCI systems, especially desktop systems, did not include support for PCI-to-PCI bridging or multi-function PCI devices in the system BIOS. Depending on the system manufacturer, it may be possible to get a BIOS upgrade that includes support for these features. Intel strongly urges you to contact the system or motherboard manufacturer or BIOS vendor to verify whether or not the system can support these features.
- * The REBOOT HTML page is the preferred method for rebooting the host system after completing configuration operations. However, this may not work on all host systems. If the REBOOT HTML page doesn't work, use the host system's reset switch or power switch to reset the host system.
- * The utility has only been tested with MSDOS 6.22, 5.0, and ROMDOS 6.22. It is unknown if it will function correctly under other versions.
- * DDM and iRTOS download and DDM validation operations are the only software module operations known to operate correctly and thus are the only ones allowed.
- * If a form is continually submitted with no changes in form data, on the third and subsequent times the form is cached. Because the cursor isn't moved at this time, the browser appears to be hung up, but it is actually operational. If any form data is changed and the form is re-submitted, normal operation resumes.
- * The browser always updates the SOFTWARE MODULE OPERATIONS menu when a change in form data occurs. This means that you will rarely need to use the "REFRESH MENU" submit option. You need to use this option only when a removable media for the currently selected drive has been removed and replaced with a different one. In this case, use the "REFRESH MENU" submit button to update the directory and files lists.
- * The SAC utilities have been tested against IOPs that are running an iRTOS that implements Version 1.5 of the Intelligent I/O (I2O Architecture Specification). The SAC utilities may not function correctly when running with iRTOSs that implement future versions of the specification.

WINDOWS NT 4.0

Troubleshooting

- * If you experience problems while using the utilities, it may become necessary to determine if the problem is occurring with DIT alone or with DIT and iopsetup.exe. This is important because if the DIT experiences any problems during initialization, iopsetup.exe will not work correctly, even though iopsetup.exe is running correctly.
- * To isolate the problem to either the DIT or iopsetup.exe, first disable your autoexec.bat file by renaming it (e.g., autoexec.sav). Then reset the system. If the problem occurs before the DOS prompt displays, then DIT is experiencing the problem, not iopsetup.exe since iopsetup.exe isn't running yet. If the problem occurs after the DOS prompt appears, start iopsetup.exe by typing "iopsetup main.htm". If the problem is experienced after iopsetup.exe is started, the problem could either be an iopsetup.exe problem or a DIT problem.
- * The following describes the DDM download and iRTOS upgrade capabilities of the Cyclone IQ80960RP and IQ80960RD66 boards:

Board	iRTOS upgrade	DDM download
IQ80960RP	Yes	No
IQ80960RD66	No	Yes

NOTE: For the IQ80960RP board, the VPP switch and SW1 must be set to ON in order for iRTOS upgrade to work. To determine the capabilities for other hardware, please consult the board's documentation or contact the board manufacturer.

WINDOWS NT 4.0

B. Install Intel LAN Driver

NOTE: Do not install the LAN driver directly from the P2B-D2 Support CD! You must copy all subdirectories and files that are under E:\LAN (assume E is the CD-ROM drive) to a floppy disk or hard disk and then install the LAN driver from it.

1. Start system with the Windows NT 4.0 installed.
2. Copy all subdirectories and files that are under E:\LAN (assume E is the CD-ROM) to a floppy disk or hard disk.
3. From "Start", point to **Settings**, and then click **Control Panel**.
4. In Control Panel, double-click on the **Network** icon.
5. Select the **Adapters** tab. Select **Intel 82557-based 10/100 Ethernet PCI Adapter** and then click **Remove**.

NOTE: When you install Windows NT4.0, it auto detects the Network card and will install the "Intel 82557-based 10/100 Ethernet PCI Adapter". However, this adapter will not work in NT4.0, so you must "remove" this driver before you adding a new driver.

6. Click **Add**. The *Select Network Adapter* window appears.

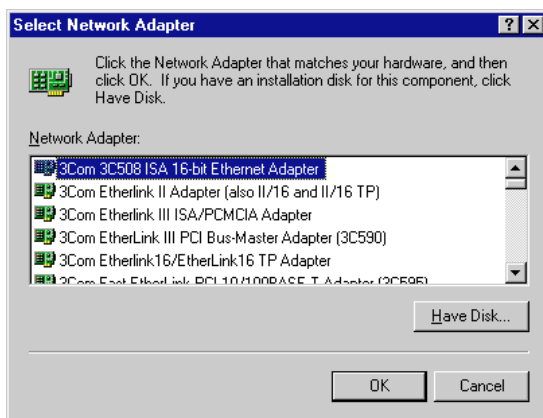

7. Click **Have disk**.

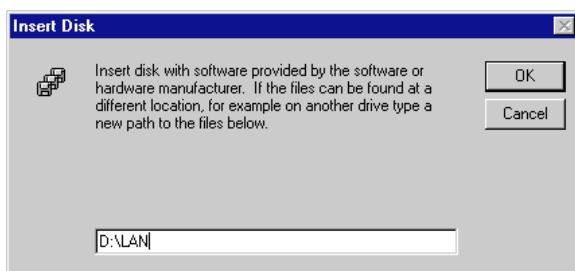

WINDOWS NT 4.0

8. Type the path to A:\LAN or C:\LAN, and then click **OK**. The *Select OEM Option* window appears.

NOTE: You must copy all subdirectories and files that are under E:\LAN (assume E is the CD-ROM drive) to a floppy disk or hard disk.

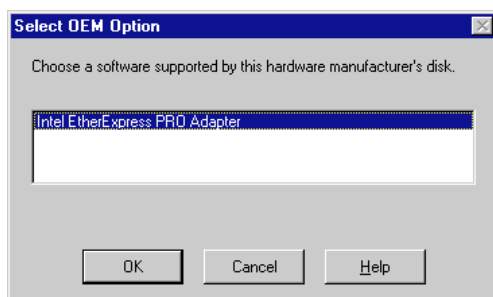

9. Select **Intel EtherExpress PRO Adapter**, and then click **OK**.
10. Click **Close** to close the *Network* window.
11. When you see the *Microsoft TCP/IP Properties* window, you must set the correct values based on your network environment.
12. Click **Yes** to restart your computer.

After restarting Windows NT, you should be able to connect to your network by double-clicking **Network Neighborhood**.

Troubleshooting

If you can't connect to a server or if Windows NT reports an error after you double-click Network Neighborhood, try the suggestions here first, then the Troubleshooting section if necessary.

- Make sure you're using the drivers that are on the Support CD that ships with this network interface or adapter.
- Make sure the driver is loaded and the protocols are bound. Check the *Device Properties* list for trouble indicators (an X or ! symbol).
- Check with your LAN administrator — you may need to install supplemental networking software.

NetWare Server, Client 32, UNIX, OS/2, Banyan, and Other Operating Systems

For these, refer to our online documents. On a DOS computer, view the appropriate README file for information on installing your network driver.

WINDOWS NT 4.0

C. Install S3 V775 VGA Driver

1. Start the system with Windows NT 4.0 installed.
IMPORTANT: Select Windows NT Workstation Version 4.00 [VGA mode], when the message, "Please select the operating system...", appears.
2. From "Start", point to **Settings**, and then click on the **Control Panel** icon.
3. In Control Panel, double-click the **Display** icon and click the **Settings** tab.

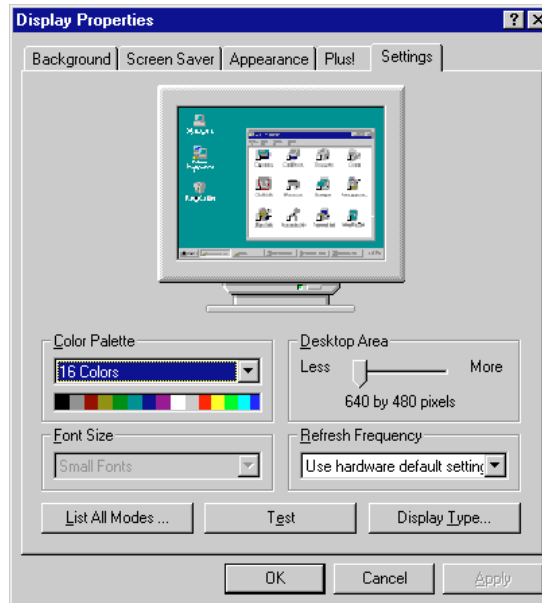

4. Click **Display Type**. The *Display Type* window appears.
5. Click **Change**. The *Change Display* window appears.
6. Click **Have Disk**.
7. Insert the ASUS Support CD into your CD-ROM drive, type **E:\VGA\NT40** in the entry box, and click **OK**.
8. From the list of displayed devices, select **ASUS PCI-V775V2 V1.04**. and then click **OK**. The *Third Party Drivers* window appears.

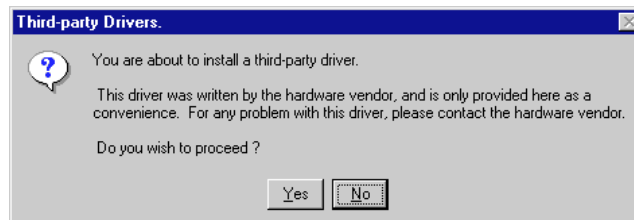

9. Click **Yes** to proceed.

WINDOWS NT 4.0

10. If a message appears stating the driver is already installed on the system and asks if you want to use the current or new drivers, be sure to select **New**.
11. If prompted for the driver diskette a second time, click **Continue**.
12. When the message "The drivers were successfully installed" is displayed, remove the CD, and then click **OK**.
13. Close the *Display Type* window.
14. Close the *Display Properties* window. The *System Settings Change* window will appear.

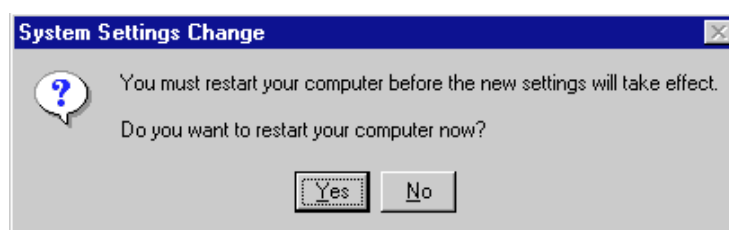

15. Click **Yes** to restart your computer.

NOTE: If installing Windows NT 4.0 with the ASUS device currently installed in the system, proceed through the Windows NT installation as normal. When the installation program prompts the user to choose a display mode, choose **Cancel** from the *Display Settings* window to ignore this step for now. Finish the installation and when you restart Windows, follow the steps outlined above to install the driver for your ASUS device.

WINDOWS NT 4.0

D. Install Adaptec AIC-7890 Driver

If you are performing a first time Windows NT installation, see the "Installing Windows NT v4.0 with the FMS Driver" sections below.

If Windows NT is already installed on your system, see the "Updating the FMS Driver under Windows NT v4.0" sections below.

Installing Windows NT v4.0 with the FMS Driver

The following instructions explain how to install the Adaptec 7800 Family Manager Set v3.01, while installing Windows NT v4.0.

1. Start your system with the Windows NT Boot Diskette in the floppy drive.
2. Insert diskette #2 when prompted. After a few moments you will see a blue screen. To setup Windows NT now, press ENTER.
3. Press S to skip Windows NT Setup's auto detection of your SCSI adapter.
4. Press S again to specify an additional device.
5. Press ENTER to select Others, and insert the Adaptec 7800 Family Manager Set v3.01 diskette.
- 6a. For non-Ultra2 host adapters, Select the "Adaptec AHA290x/291x/294x/394x/4944/AIC78xx PCI SCSI Controller(NT 4.0)" and press ENTER or
- 6b. For Ultra2 host adapters, Select the "Adaptec AHA-294xU2/AIC-7890/91 PCI Ultra2 SCSI Controller(NT 4.0)" and press ENTER.
7. If you want to add other host adapters (that are not a part of the 7800 Family), do so at this time by pressing 'S' and repeating step 5 for each additional adapter and inserting the appropriate disk provided by the hardware manufacturer. The Adaptec 7800 Family host adapters use the same driver; it is not necessary to install the AIC78XX.SYS or AIC78U2.SYS driver again.
8. Press ENTER to continue with the Windows NT operating system setup. Follow the instructions given on screen and in the Windows NT installation documentation.

WINDOWS NT 4.0

Updating the FMS Driver under Windows NT v4.0

Follow these instructions only if Windows NT v4.0 is already installed.

1. Click the **Start** button on the Windows NT task bar, and point to **Settings**.
2. Open the Control Panel, double-click **SCSI Adapters**.
3. Select the **Drivers** tab, and click **Add**.
4. In the *Install Driver window*, click **Have Disk**.
5. Insert the ASUS P2B-D2 CD.
6. At the *Copy manufacturer's files from* text box, type `E:\SCSI\WINNT\4_0` (Where E is your CD-ROM drive), and click **OK**.
7. At the *Install Driver* window, select the driver, **Adaptec AHA-294xU2/295xU2/AIC-789x PCI Ultra2 SCSI Controller [NT4.0]**, and then click **OK**.
8. In response to "Do you want to use the currently installed driver(s) or install new one(s)", select **New**.
9. Again type `E:\SCSI\WINNT\4_0` and click **Continue**. The driver is now installed.
10. You must restart your computer for the changes to take effect. Click **Yes** to restart your computer. Click **No** to return to the SCSI Adapters window.

WINDOWS NT 4.0

Removing a Host Adapter from Windows NT v4.0

Removing a host adapter can be as simple as physically removing it from the slot when your computer is shut down. Windows NT boots and functions properly in this configuration, but a warning message is generated every time you boot Windows NT.

CAUTION! If you have removed a host adapter but still have other host adapters of the same type installed in your computer, do not use Windows NT Setup to remove the device driver.)

To eliminate the warning message, you must update the Windows NT software configuration, as described in the following steps:

1. Open the Control Panel, double-click on SCSI Adapters.
2. Select the Drivers tab.
3. Select the Driver you wish to remove.

- a. For non-Ultra2 host adapters:

Select the driver you plan on removing and click **Remove**. The driver will appear as one of the following:

Adaptec AHA290x/291x/294x/394x/4944/AIC78xx PCI SCSI Controller (NT 4.0)

or

Adaptec AHA-294x/AHA-394x/AHA-4944 or AIC-78xx PCI SCSI Controller (NT 4.0)

or

Adaptec AHA-294X/AHA-394X or AIC-78XX PCI SCSI Controller

- b. For Ultra2 host adapters:

Select the driver you plan on removing and click **Remove**. The driver will appear as one of the following:

Adaptec AHA-294xU2/AIC-7890/91 PCI Ultra2 SCSI Controller(NT 4.0)

4. If you are sure you are removing the correct host adapter type, click **Yes**.
5. You must restart your computer for the changes to take effect. Click **Yes** to restart your computer. Click **No** to return to the SCSI Adapters window.

WINDOWS NT 4.0

Swapping a Host Adapter for v4.0

Swapping one type of host adapter for another is similar to the procedure for adding a host adapter. The important distinction is that you make all software configuration changes while Windows NT is running and before you make the hardware changes.

NOTE: If you do not install the driver that comes with the new host adapter, it may result in Windows NT failing to boot.

1. Install the driver for the new host adapter by following the steps in the section on “Updating Windows NT with the Driver”.

It is not essential to remove the device driver for the host adapter you are replacing. Windows NT dynamically detects the absence or presence of host adapter hardware, and no problems should arise if you leave the existing device driver installed. You may remove the device driver later, after you have successfully rebooted Windows NT. However, if you leave the driver in, the system alerts you with an error message of the extra device driver every time you boot. See section on “Removing a Host Adapter”.

2. Once the new device driver is installed, shut down Windows NT and replace the existing host adapter.
3. Restart your computer and Windows NT. It is possible that some drive letter assignments may change from the previous configuration.

E. BusMaster

This subsection describes how to install the software on a system where Windows NT Version 4.0 is installed.

NOTE: This procedure assumes that the driver (PIIXIDE.SYS), installation file (OEMSETUP.INF) and tag file (DISK1.NT) are located in the same directory. Record the locations of the driver installation and Windows NT directories before installing the driver. If the driver is installed on the system, un-install the driver (following the directions in the "Un-installing the Software" section) PRIOR to re-installing the driver.

1. Check the System Requirements. Windows NT must be fully installed and running on the system prior to installing the driver.
2. Close any running applications.
3. Select **My Computer**.
4. Open the **Control Panel** Folder.
5. Invoke the **SCSI Adapters** applet.
6. Click the **Drivers** tab. The currently installed SCSI adapter drivers will be listed in the Drivers menu. The display MAY list the default driver, "IDE CD-ROM (Atapi 1.2) / Dual-Channel PCI IDE Controller" OR a previously installed PIIX Bus Master IDE driver, "Intel PIIX PCI Bus Master IDE Controller". **NOTE:** this text may vary according to the release of Windows NT*. If NONE of these adapter drivers are listed, go to step 9.
7. If the "Intel PIIX PCI Bus Master IDE Controller" driver is listed, select it. Then, select **Remove** to remove the driver.
8. If the default driver "IDE CD-ROM (Atapi 1.2) / Dual-Channel PCI IDE" is listed, select it. Then, select **Remove** to remove the driver.
9. Select **Add** to add a new driver.
10. From the *Install Disk* window, select **Have Disk**.
11. The *Windows NT Setup* dialog box will appear prompting for the path of the installation files. Specify the location of the driver installation directory when prompted to do so.

NOTE: This procedure assumes that the driver (PIIXIDE.SYS), installation file (OEMSETUP.INF) and tag file (DISK1.NT) are located in the same directory.
12. Click **Intel PIIX PCI Bus Master IDE Controller** and then click **OK**.

NOTE: If the driver was previously installed on the system, a dialog box will appear that states that driver for the "Intel PIIX PCI Bus Master IDE Controller" is already on the system. If this occurs, select **New** to install the new driver.
13. When prompted, reboot the system as directed in order for the changes to take effect.

WINDOWS NT 4.0

Verifying Driver Installation in Windows NT 4.0

In order to verify the installation of the driver:

1. Double-click **My Computer**.
2. Open the **Control Panel** Folder.
3. Invoke the SCSI Adapters applet.
4. A list of active SCSI adapters and connected devices will be displayed. One or more instances of the PIIX Bus Master IDE Driver, "Intel PIIX PCI Bus Master IDE Controller" should be listed. The default driver, "IDE CD-ROM (Atapi 1.2) / Dual-Channel PCI IDE Controller" should not be listed.

NOTE: This text may vary according to the release of Windows NT*

One instance will be listed for each controller interface of the PIIX that is currently enabled with devices connected to it.

A. Install S3 VGA Driver

This package contains an OS/2 graphics-accelerator device driver supporting the Trio32(732), Trio64(764), Trio64V+(765), and Trio64V2 DX/GX (775/785) chip sets from S3 Incorporated.

IMPORTANT:

- "S3 DRV1" and "S3 DRV2" must be the label on the installation diskettes in this package. This label can be applied using the DOS or OS/2 LABEL command. The installation will fail without this step.
- Disk 2 is used only for 864/964 installs.
- Read this entire document before beginning the device driver installation.

Supported Features

This Vision864/964/868/968/Trio32/64/64V+/64V2 graphics-accelerator device driver provides seamless support for accelerated display graphics and advanced color resolutions when used with the minimum required video memory. It conforms to the OS/2 32-bit, flat memory model and is designed to function as a 32-bit Presentation Manager graphics-display device driver under the OS/2 32-bit graphics engine. This device driver supports setting the refresh rate using the System - Settings notebook (page 2 of the Screen tab) in the OS/2 System Setup folder, and monitor detection using Display Data Channel (DDC) protocols.

IBM OS/2

Supported Resolutions

Mode	Resolution	Mem. Req'd	Trio Family	
			764/765/732	775/785
101	640x480x8	1 MB	Y	Y
103	800x600x8	1 MB	Y	Y
105	1024x768x8	1 MB	Y	Y
107	1280x1024x8	2 MB	Y	Y
111	640x480x16	1 MB	Y	Y
114	800x600x16	2 MB	Y	Y
116	1024x768x16	2 MB	Y	Y
212	640x480x24	1 MB	N/S	N/S
112	640x480x32	2 MB	Y	Y
115	800x600x32	4 MB	N/A	Y
118	1024x768x32	4 MB	N/A	Y
11A	1280x1024x16	4 MB	N/A	Y
120	600X1200x8	4 MB	N/A	Y

NOTES:

- Y = Supported; N/S = Not Supported.
- 1 MB only - 640x480x24 is supported for 1 MB memory configuration only; for 2 MB and above, 32 bits per pixel (bpp) is supported.
- S3 BIOS supports 800x600x16 with 1 MB; S3 OS/2 device driver needs 2 MB of memory.

The 32 bpp device driver might need a large swap space on the hard disk, for example, 15 MB.

Compatibility

This graphics-accelerator device driver is compatible with OS/2 2.11, OS/2 Warp 3.0, and OS/2 Warp (Merlin) 4.0.

DDC Monitor Support

VESA Display Data Channel (DDC) 1 and 2B protocols are supported, allowing similarly enabled computers and operating system software to identify the monitor and its capabilities. This device driver automatically detects DDC monitor capabilities and sets the display to the maximum refresh rate supported by the monitor. If, after installing this device driver, you switch from a non-DDC monitor to a DDC monitor or switch to a different DDC monitor, you must run the DDC Display Setup program in the System Setup folder.

Use the following procedures when installing a DDC monitor

1. Reset the display to the lowest refresh rate available. This will prevent the system from attempting to display at a refresh rate higher than that supported by the new monitor.
2. Shut down your system and install the new monitor.
3. Restart your system.
4. Select the "DDC Display Setup" icon in the OS/2 System Folder.
5. When you are instructed to do so, shut down your system and restart it.

Preliminary Steps

The following steps must be performed before you install the Vision864/964/868/968/Trio32/64/64V+/64V2 graphics-accelerator device driver:

1. You must have OS/2 DOS Support installed.
2. If you previously installed SVGA support, you must reset the resolution to VGA mode, using the procedures in "Setting Your Display to VGA Mode" (section 5.0 in this README).
3. The device driver diskettes must be labeled "S3 DRV1" and "S3 DRV2".

IBM OS/2

4. After driver installation, the OS/2 SYSLEVEL command may be used to confirm the new driver version level. It may also be used prior to installation to verify the current driver version, however, some previous device drivers did not provide this information. Following execution of the SYSLEVEL command look for the following information:

C:\OS2\INSTALLATION\SYSLEVEL.VID
Vision864/964/868/968/Trio32/64/64V+/64V2
Version 2.81 Component ID 562107701
Current CSD level: S330302
Prior CSD level: S328414

In this case the current version level is S3 3.03.02.

5. In some situations, installing this driver over 2.80.xx and 2.81.xx versions of the driver can result in duplicated icons. To prevent this problem, you should delete the "S3 Windows Font Size" and "DDC Display Setup" icons from the System Setup Folder prior to installing this driver.

IBM OS/2

Setting Your Display to VGA Mode

Use the following procedures to reset to VGA mode.

NOTE: If your display is out of sync, start OS/2 using the OS/2 Installation Diskette. Insert Diskette 1 when prompted, press F3 to display a command prompt, and then use the following instructions to reset your display mode.

- If you are installing this driver on OS/2 2.11 or OS/2 for Windows, and you installed from diskettes, do the following:

1. Under OS/2 2.1/2.11, before running RSPDSPI, delete the following file:

```
[OS2 DRIVE]:\OS2\INSTALL\00S3.DSC
```

2. Be sure RSPDSPI.EXE is in the \OS2\INSTALL directory. If it is, go to step 5. If it is not, insert Diskette 8 into drive A and unpack RSPDSPI.EXE with the following command:

```
C:\OS2\UNPACK A:\INSTAID C: /N:RSPDSPI.EXE
```

where A: is the drive containing Diskette 8, and C: is the drive where OS/2 is installed.

3. Type **C:** and then press <Enter>.
4. Type **CD C:\OS2\INSTALL** and then press <Enter>.
5. Type the following:

```
RSPDSPI /PK:VGA /SK:NONE /S:A: /T:C:
```

In /T:C:, C: is the target drive where OS/2 is installed. In /S:A:, A: is the source diskette drive for installing the device driver. Then press Enter.

6. Perform a shutdown and restart your computer.
- If you are installing this driver on OS/2 2.11 or OS/2 for Windows, and you installed from CD-ROM or a LAN, do the following:

1. Under OS/2 2.1/2.11, before running RSPDSPI, delete the following file:

```
[OS2 DRIVE]:\OS2\INSTALL\00S3.DSC
```

2. Be sure RSPDSPI.EXE is in the \OS2\INSTALL directory. If it is, go to step 6. If it is not, unpack RSPDSPI.EXE with the following command:

```
C:\OS2\UNPACK E:\DISK_8\INSTAID C: /N:RSPDSPI.EXE
```

where C: is the drive where OS/2 is installed, and E: is the CD-ROM or LAN drive.

3. Type **C:** and then press <Enter>.
4. Type **CD C:\OS2\INSTALL** and then press <Enter>.

IBM OS/2

6. Type the following:

RSPDSPI /PK:VGA /SK:NONE /S:E:\OS2SE21\ /T:C:

In /T:C;, C: is the target drive where OS/2 is installed. In /S:E;, E: is the source CD-ROM or LAN drive. Then press Enter.

7. Perform a shutdown and restart your computer.

- If you are installing this driver on OS/2 Warp 3.0, do the following:

1. Restart your computer.
2. Simultaneously press Alt and F1 key immediately when a square block appears in the top left hand corner.
3. Press 'v' key for VGA.

- If you are installing this driver on OS/2 Warp (Merlin) 4.0, do the following:

1. Restart your computer.
2. Simultaneously press Alt and F1 key immediately when a square block appears in the top left hand corner.
3. Press F3 key for VGA.

Installing from Diskette

To install the Vision864/964/868/968/Trio32/64/64V+/64V2 device driver from diskette, do the following:

1. If system is not in VGA mode, select VGA mode.
2. Insert the Vision864/964/868/968/Trio32/64/64V+/64V2 diskette into drive A (or any other diskette drive).

NOTE: "S3 DRV1" must be the volume label of this diskette. To verify the label, use "Label A:".

3. Open an OS/2 full-screen or OS/2 window session.
4. At the OS/2 command prompt, type the following command to copy all necessary files to the OS/2 drive:

A:SETUP (where A: is the diskette drive)

Then press <Enter>.

Setup will then identify your chipset. When prompted to do so, press <Enter> to continue. Due to the limitations with a single pass installation, a dialog box may come up during installation with the message, "The installed adapter does not support the selected display driver. Do you wish to continue?". Please continue the installation by selecting the **Yes** button.

5. When the Monitor Configuration/Selection Utility window appears, the "Install Using Defaults for Monitor Type" choice is preselected. Select OK. Do not select "Install Using Display Adapter Utility Program" since this method of setting refresh rates is not supported anymore.

NOTE: DSPINSTL determines the hardware configuration by creating the \OS2\SVGADATA.PMI file. If the \OS2\SVGADATA.PMI file has not been created, the adapter will not be supported. This process can take several seconds and will black-out the screen.

6. When the Source Directory pop-up window requests the Vision868/968/Trio32/64/64V+/64V2 diskette insert the diskette labelled "S3 DRV1". If the Source Directory pop-up window requests the -CHIPDESC2- diskette insert the diskette labelled "S3 DRV2". Then select **Install**.
7. When prompted to do so, select OK to perform a shutdown, and then restart your computer. Make sure the diskette has been removed from the install drive.

IBM OS/2

8. When the system has restarted:
 - a) Open the OS/2 System folder.
 - b) Open the System Setup folder.
 - c) Open the System object.
 - d) When the Settings notebook appears, select the Screen tab. If your monitor has been detected as Plug and-Play (DDC) compatible, go to step 10.
9. On Screen page 2, select your display from the display list. If your display does not appear in the list, select Default. It might be necessary to restart your computer to have all refresh rate options available.
10. When the system has restarted:
 - a) Open the System object and select Screen page 1, as in step 8.
 - b) Select a screen resolution and a screen refresh rate.
 - c) Close the Settings notebook.
 - d) Perform a shutdown and restart your computer.

NOTES:

- If the selected vertical refresh rate is not supported by your monitor, delete \OS2\VIDEO.CFG file and reboot. This will set the refresh rate to the default value. A new refresh rate can now be selected using the procedure described above.
- During the installation of this driver, DISPLAY.LOG and DSPINSTL.LOG files are created in the OS/2\INSTALL directory. These files identify the OS/2 system files that were updated and indicate whether the installation was successful. The contents of these files might be useful if you need to report an installation problem to IBM.
- If the video memory size is changed after the device driver is installed, the device driver must be reinstalled in order for the system to recognize the change. Not reinstalling the driver might result in serious system problems.
- When starting a WIN-OS/2 session it is recommended that the user launch the session via one of the WIN-OS/2 icons located in the "Command Prompts" folder within the "OS/2 System" icon. For additional information see section 10.0 Limitations.

IBM OS/2

Installing in a CID Environment

NOTES:

- The server must contain a directory named S3_DRVS on the same drive where the OS/2 diskettes reside. The S3_DRVS directory must contain all of the files from the Vision864/964/868/968/Trio32/64/64V+/64V2 device driver diskette.
- OS/2 must have been successfully installed on the client using the CID (Configuration Installation Distribution) method.

To install the Vision864/964/868/968/Trio32/64/64V+/64V2 graphics-accelerator device driver using CID, use the following information to modify your LCU command file.

NOTE: The following information is meant as a guide.

Your LCU command file might be different.

```

/*****/
/*          LCU PRODUCT DATA SECTION          */
/*****/

.
.
.

x.s3video = 15
x.15.name='S3 Video'
x.15.statevar = 'CAS_' || x.15.name
x.15.instprog = 'x:\img\s3_drvs\SETUP.CMD',
               '/u /s:x:\img\s3_drvs'

x.15.rspdir = "
x.15.default = "

/*****/
/*          NUMBER OF PROGRAMS SET UP IN THE          */
/*          PRODUCT DATA SECTION                    */
/*****/

NUM_INSTALL_PROGS = 15
```

IBM OS/2

```
/*
INSTALLATION SECTION
*/
```

```
.
.
when OVERALL_STATE = 2 then do
  if RunInstall(x.s3video) == BAD_RC then exit
  Call RebootAndGotoState(3)
end
when OVERALL_STATE = 3 then do
  if RunInstall(x.s3dspinstl) == BAD_RC then exit
  Call CheckBoot
end
```

```
/*
ROUTINE SECTION
*/
/* The following information should already exist in the LCU command file. */
/*
```

```
.
.
RebootAndGotoState:
parse arg new_state, other
rc2 = SetState(new_state, 'RebootAndGotoState', 1) /* Set the state */
/* to go to in */
/* OVERALL_STATE */
Call SaveStates /* Save the environment vars */
Call Reboot /* Reboot the machine */
return
```

IBM OS/2

```
/*
/*          END OF LCU INFORMATION TO BE ADDED          */
/*
```

Following is an explanation of the line that is executed in the LCU command file:

C:\OS2\INSTALL\DSPINSTL /pd:c:\os2\install\00S3.dsc

/S:X:\img\s3_drvs /T:C: /res:640x480x256 /u

/pd:c:\os2\install\00S3.dsc

is the dsc laid down during setup phase.

/S:X:\img\s3_drvs

where X:\img\s3_drvs is the redirected source path.

/T:C:

where C: is the drive where OS/2 is installed.

/res:640x480x256

is a resolution/color depth from the list of "Supported Resolutions" that appears earlier in this README.

/u

means Unattended installation.

NOTES:

- Be sure you have the stated video memory required, as listed in "Supported Resolutions" earlier in this README. A safe choice is 640x480x256. Any of the listed resolutions can be selected, but your display might be damaged if you select a resolution that your display does not support.
- To select a refresh rate, SVGA.EXE can be executed again separately after DSPINSTL. Example, SVGA ON INIT 1024 75 This will create another \OS2\VIDEO.CFG file with 75Hz as the default at 1024x768 resolution. The prior \OS2\VIDEO.CFG file should be deleted first.
- After the Vision864/964/868/968/Trio32/64/64V+/64V2 device driver has been successfully installed on the client machine using the CID method and the client machine is restarted, the resolution will be as specified by command line argument.
- After the CID installation, refer the end user to section 6.0 "Installation from Diskette," step 12.

IBM OS/2

Selecting Small or Large Fonts for Windows

The default font sizes for Windows sessions are listed below.

<u>Resolution</u>	<u>Default Font Size</u>
640x480	Small
800x600	Small
1024x768	Large
1280x1024	Large
1600x1200	Large

NOTE: Large fonts are not available for 640x480 resolution.

Use the following procedures to select small or large fonts for Windows sessions.

1. Select the "S3 Windows Font Size" object in the OS/2 System Setup Folder.
2. Click the radio button next to the font size you wish to select.
3. Click the **OK** button.
4. A message will display saying that the new settings will take effect the next time you restart your Windows session. Currently open sessions will not be affected by the new settings.
5. Click the **OK** button.
6. Start any WIN-OS/2 window or full-screen session.

The setting you select will remain in effect until you explicitly change it, you change your display resolution, or you install a new display driver.

IBM OS/2

Features and Fixes Included in this Driver

- "System - Settings" notebook support for setting refresh rate
- Capabilities button of page 1 of the "System - Settings" notebook for large/small/automatic resource size selection (changes WIN-OS/2) font sizes as well
- DDC monitor detection support
- Windows "Large font" and "Small font" support in high resolutions
- WIN-OS/2 based on latest S3 Windows 3.1 drivers
- Two-diskette package
- One boot install
- EnDIVE support for Trio64V+ and Trio64V2 on certain video modes
- CID install allow preselected refresh rate

Limitations

1. CID install pauses due to SVGA.EXE loading in the background.

Workaround: In the CID install script, do not initiate any other processes until DISPINSTL completes execution. Ensure that no other processes are running during CID install. This can be accomplished by adding the following line to the CONFIGSYSLINE keyword of the CID response file:

```
SET RESTARTOBJECTS=STARTUPFOLDERONLY
```

2. During CID install of IBM AntiVirus when using NetView DM/2, the OS/2 full screen is displayed as a black screen.

Workaround: Perform CID install under VGA.

3. DISPINSTL does not allow CID selection of monitor and refresh rate. The workaround is as follows:

Requirements:

A system with the same graphics card and monitor configured with the S3 driver version 2.81.05, the correct display type, the desired resolution, and the desired refresh rate.

Step 1: Copy Configured Video/Display Data Files

Copy the video and display data files containing information about the display type, resolution and refresh rate to the CID server (\img\svgadata).

```
> copy \os2\svgadata.pmi x:\img\svgadata
```

```
> copy \os2\video.cfg x:\img\svgadata
```

Step 2: Create CID Command File

Create a command file to copy svgadata.pmi and video.cfg to the client system's \os2 directory via CID. Reboot the client system. The client system will be configured with the correct driver, display type, resolution and refresh rate. Another work around is to delete \OS2\VIDEO.CFG and to execute SVGA.EXE again after DISPINSTL completes. Example: SVGA ON INIT 1024 75 to set 75Hz as the default refresh rate at 1024x768.

IBM OS/2

4. In all modes, video corruption or out-of-sync screen is displayed when using Alt+Esc to switch between WIN-OS/2, OS/2, and DOS window and full-screen sessions started from the Startup folder. To avoid this situation, do not start sessions from the Startup folder or press Alt+Esc several times to restore.
5. Some programs, such as WINBENCH95, WINBENCH96, and After Dark 3.0, were written specifically for the Windows environment. In the Windows environment, these programs prevent any keystrokes from interfering with their proper execution. However, in the OS/2 environment, it is possible to switch context away from the Windows session without notifying these programs. General Protection Faults (GPFs) may result. Therefore, context switching during the execution of WINBENCH95 and WINBENCH96 tests is not recommended. Also, context switching during the execution of the After Dark 3.0 demo is not recommended.
6. When attempting to start a WIN-OS/2 session from an OS/2 Full Screen session by typing "WIN" or "WINOS2" at the command prompt, it will not execute with the settings needed to support WIN-OS/2, and will result in video corruption and/or a system lockup. It is recommended that the user launch all Windows sessions via one of the WIN-OS/2 icons located in the "Command Prompts" folder within the "OS/2 System" icon.
7. When attempting to start a WIN-OS/2 session from a DOS Full screen or DOS Window by typing the "WIN" or "WINOS2" command, the user must first be sure that the video settings of the session are changed to enable this feature. These settings can be changed using the following procedure:
 - a) Place mouse pointer over the DOS Full Screen icon (or any DOS session icon you want to alter). Press mouse button 2 (MB2), the right button, to bring up a context sensitive menu.
 - b) Place mouse pointer over "Setting" and press MB1. Next, place mouse pointer over the tab labeled "Session" and press MB1 again.
 - c) Use MB1 to chose the "DOS Setting" button.
 - d) Use MB1 to chose the "DOS video settings" option, and then click OK.
 - e) From the list of settings which appear ensure that "VIDEO_8514A_XGA_IOTRAP" is switched OFF, AND "VIDEO_SWITCH_NOTIFICATION" is switched to ON, then "save" these settings using MB1.

IBM OS/2

B. Install Adaptec AIC-7890 Driver

The AIC78U2.ADD Ultra2SCSI driver only supports IBM OS/2 Warp 3.x, 4.0 and 4.0 SMP. The AIC7870.ADD UltraSCSI or earlier driver also supports IBM OS/2 version 2.1x in addition to versions 3.x, 4.0 and 4.0 SMP.

Installing a New Driver or Updating an Existing Driver for IBM OS/2 2.1X/Warp/SMP

1. Open the IBM OS/2 System Folder, then open the System Setup folder.
2. If running IBM OS/2 Warp 4.0, open the Install/Remove Folder.
3. Double-click on Device Driver Install.
4. Insert the Adaptec 7800 Family Manager Set v3.00 floppy in the appropriate drive.
5. Change to the directory where the driver is located.
 - a) For Ultra2SCSI host adapters, the driver will be located in
 \OS2\AIC78U2
 - b) For UltraSCSI or earlier host adapters, the driver will be located in
 \OS2\AIC7870
6.
 - a) For Ultra2SCSI host adapters,
 When you find the driver (AIC78U2.ADD), select INSTALL.
 - b) For UltraSCSI or earlier host adapters,
 When you find the driver (AIC7870.ADD), select INSTALL.
7. After the install finishes, select EXIT and reboot the computer.
NOTE: Be sure to plug in the Ultra2SCSI card if updating from UltraSCSI or earlier host adapters to the Ultra2SCSI host adapter. You may also install the driver manually.

For Ultra2SCSI host adapters:

Copy AIC78U2.ADD to C:\OS2\BOOT.

Add a line to your CONFIG.SYS that says BASEDEV=AIC78U2.ADD /V.

For UltraSCSI or earlier host adapters:

Copy AIC7870.ADD to C:\OS2\BOOT.

Add a line to your config.sys that says BASEDEV=AIC7870.ADD /V.

IBM OS/2

First-Time Installation of IBM OS/2 2.1X/Warp/SMP From Floppy Diskette

NOTE: To install the driver, it is necessary to copy the driver from the Adaptec 7800 Family Manager Set v3.00 diskette for IBM OS/2 on to the IBM OS/2 Diskette #1. However, before you can copy the driver, you must first remove various files from the IBM OS/2 Diskette #1, as explained in step 2 below.)

1. Make backup copies of the Installation Diskette and Disk #1.
2. Delete some of the existing files on the backup copy of the IBM OS/2 diskette #1 so that approximately 140 KB of disk space is available on the diskette. Use the following information to help you decide which files to delete.
 - a) If the Adaptec 7800 Family host adapter is the only Adaptec host adapter installed in your system, delete all other Adaptec drivers (aha152x.add, aha154x.add, aha164x.add, aha174x.add, aic7770.add, aic7870.add, and fd16-700.add).
 - b) If you have an Adaptec host adapter that is not part of the 7800 Family , delete all of the Adaptec drivers not used by that particular host adapter. For example, if you have an Adaptec AHA-1540CP host adapter installed in your computer, delete all Adaptec drivers except for the aha154x.add driver.
 - c) If you have deleted the suggested Adaptec drivers above, and if you do not have a Microchannel architecture system, and you still do not have approximately 140 KB of disk space available on the diskette, delete these files: ibm2flpy.add, ibm2adsk.add, and ibm2scsi.add.

NOTE: If you have a combination PCI/Microchannel architecture system, you need to delete third-party driver files not required.)

3. If you are installing IBM OS/2 2.1X, use the backup copies of the Installation Diskette and Disk #1 to do the following:
 - a) Copy OS2LDR from the Adaptec 7800 Family Manager Set v3.00 diskette onto the Installation Diskette.
 - b) Copy IBMINT13.I13 from the Adaptec 7800 Family Manager Set v3.00 diskette onto Disk #1.

NOTE: You do not need these files when installing IBM OS/2 Warp or SMP.

IBM OS/2

4. Add the following lines to the config.sys file on IBM OS/2 diskette #1:
 - a) For Ultra2SCSI host adapters:
BASEDEV=AIC78U2.ADD
Set CopyFromFloppy=1
 - b) For UltraSCSI or earlier host adapters:
BASEDEV=AIC7870.ADD
Set CopyFromFloppy=1
5. Install IBM OS/2 using the backup diskettes and the remainder of the standard IBM OS/2 diskettes.
6. When installation has completed, reboot the system
7. After the system has rebooted, follow the instructions for installing the driver on a system containing IBM OS/2.

IBM OS/2

First-Time Installation of IBM OS/2 2.1X From CD-ROM

Only the AIC7870.ADD driver is supported under IBM OS/2 2.1X. The Ultra2SCSI AIC78U2.ADD driver is not supported under IBM OS/2 2.1X.

NOTE: To install the aic7870.add driver, it is necessary to copy the driver from the Adaptec 7800 Family Manager Set v3.00 diskette for IBM OS/2 on to the IBM OS/2 Diskette #1. However, before you can copy the driver, you must first remove various files from the IBM OS/2 Diskette #1, as explained in step 2 below.)

1. Use diskcopy to make backup copies of all IBM OS/2 and Adaptec supplied diskettes. Use the backup copies as your working diskettes.
2. Delete some of the existing files on the backup copy of the IBM OS/2 diskette #1 so that approximately 140 KB of disk space is available on the diskette. Use the following information to help you decide which files to delete.
 - a) If the Adaptec 7800 Family host adapter is the only Adaptec host adapter installed in your system, delete all other Adaptec drivers (aha152x.add, aha154x.add, aha164x.add, aha174x.add, aic7770.add and fd16-700.add).
 - b) If you have an Adaptec host adapter that is not part of the 7800 Family, delete all of the Adaptec drivers not used by that particular host adapter. For example, if you have an Adaptec AHA-1540CP host adapter installed in your computer, delete all Adaptec drivers except for the aha154x.add driver.
 - c) If you have deleted the suggested Adaptec drivers above, and if you do not have a Microchannel architecture system, and you still do not have approximately 140 KB of disk space available on the diskette, delete these files: ibm2flpy.add, ibm2adsk.add, and ibm2scsi.add.
3. Copy the OS2LDR file from the Adaptec 7800 Family Manager Set v3.00 diskette (i.e., \OS2\AIC7870\OS2LDR) onto the IBM OS/2 installation diskette. This overwrites the existing IBM OS/2 loader on the diskette.
4. Copy the IBMINT13.I13 driver from the Adaptec 7800 Family Manager Set v3.00 diskette (i.e., \OS2\AIC7870\IBMINT13.I13) onto the IBM OS/2 installation diskette #1. This overwrites any existing version of the driver included on diskette #1.
5. Copy the AIC7870.ADD driver from the Adaptec 7800 Family Manager Set v3.00 diskette (i.e., \OS2\AIC7870\AIC7870.ADD) onto the IBM OS/2 installation diskette #1. This overwrites any existing version of the driver included on diskette #1.

NOTE: If you have a combination PCI/Microchannel architecture system, you need to delete third-party driver files not required.

IBM OS/2

6. Modify the CONFIG.SYS file on diskette #1 to include the following line:
BASEDEV=AIC7870.ADD
7. Run the IBM OS/2 installation program; follow the instructions in your IBM OS/2 documentation.
8. At the end of the installation process, follow the on screen instructions to remove the last IBM OS/2 distribution diskette and reboot the computer. If the computer fails to boot up, and locks up while displaying the IBM OS/2 logo screen, you may use one of the following options to get to the command prompt:
 - a) If you installed IBM OS/2 using the FAT Filesystem, boot up MS-DOS to get to the command prompt.
 - b) If you installed IBM OS/2 using the HPFS Filesystem, insert the Installation Diskette and boot up the computer from this diskette. When the IBM screen is displayed, remove the Installation diskette and insert Diskette #1 as instructed to do so. After a while, a screen will be displayed asking which installation method you wish to choose. At this point, press the F3 key to get to the command prompt. Once you get to the command prompt, change to the drive where the IBM OS/2 system files are located (usually Drive C:). You may now use a text editor to again modify the IBM OS/2 CONFIG.SYS file on the hard drive to add the /!PCIHW switch to the BASEDEV=AIC7870.ADD line. IBM OS/2 should then boot normally from the hard disk.
9. After the computer has restarted, IBM OS/2 displays a screen. You have the option to view online information while the IBM OS/2 desktop is building. Allow IBM OS/2 to finish building, and follow the on screen instructions to restart the computer. Again, if the computer fails to boot up, and locks up while displaying the IBM OS/2 logo screen, repeat the process specified in step 8 to correct the problem.

NOTE: The CONFIG.SYS, IBMINT13.I13, and OS2LDR files may be overwritten by equivalent files from the CD-ROM. If this occurs, follow step 8 above to recover those files.

IBM OS/2

First-Time Installation of IBM OS/2 Warp 3.x, 4.0 or 4.0 SMP From CD-ROM

NOTE: To install the driver, it is necessary to copy the driver from the Adaptec 7800 Family Manager Set v3.00 diskette for IBM OS/2 on to the IBM OS/2 Diskette #1. However, before you can copy the driver, you must first remove various files from the IBM OS/2 Diskette #1, as explained in step 2 below.)

1. Use diskcopy to make backup copies of all IBM OS/2 and Adaptec supplied diskettes. Use the backup copies as your working diskettes.
2. Delete some of the existing files on the backup copy of the IBM OS/2 diskette #1 so that approximately 140 KB of disk space is available on the diskette. Use the following information to help you decide which files to delete.

a) If the Adaptec 7800 Family host adapter is the only Adaptec host adapter installed in your system, delete all other Adaptec drivers (aha152x.add, aha154x.add, aha164x.add, aha174x.add, aic7770.add, and fd16-700.add).

NOTE: If you are installing the Ultra2SCSI host adapter, delete the aic7870.add driver as well.

b) If you have an Adaptec host adapter that is not part of the 7800 Family, delete all of the Adaptec drivers not used by that particular host adapter. For example, if you have an Adaptec AHA-1540CP host adapter installed in your computer, delete all Adaptec drivers except for the aha154x.add driver.

c) If you have deleted the suggested Adaptec drivers above, and if you do not have a Microchannel architecture system, and you still do not have approximately 140 KB of disk space available on the diskette, delete these files: ibm2flpy.add, ibm2adsk.add, and ibm2scsi.add.

NOTE: If you have a combination PCI/Microchannel architecture system, you need to delete third-party driver files not required.)

3. Copy the driver from the Adaptec 7800 Family Manager Set diskette for IBM OS/2 onto the IBM OS/2 installation diskette #1.
 - a) For Ultra2SCSI host adapters, the driver (AIC78U2.ADD) will be located in \OS2\AIC787U2 directory.
 - b) For UltraSCSI or earlier host adapters, the driver (AIC7870.ADD) will be located in \OS2\AIC7870 directoy

IBM OS/2

4. For each driver removed from the IBM OS/2 diskette #1, remove its corresponding line in the config.sys file (also on IBM OS/2 diskette #1).

For example, if you deleted all Adaptec drivers, as explained in step 2a, above, remove the following lines from config.sys:

basedev=aha152x.add

basedev=aha154x.add

basedev=aha164x.add

basedev=aha174x.add

basedev=aic7770.add

basedev=fd16-700.add

NOTE: If you are installing the Ultra2SCSI host adapter, then remove the basedev=aic7870.add statement as well.)

5. In the config.sys file on IBM OS/2 diskette #1, add the line "set copyfromfloppy=1".

This line should be added so that the install process copies the aic78U2.add or aic7870.add driver from the IBM OS/2 diskette #1, rather than the driver included on your IBM OS/2 CD-ROM.

NOTE: a. For Ultra2SCSI host adapters, Add "BASEDEV=aic78U2.add" to the top line of config.sys on IBM OS/2 diskette #1. This may result in two "BASEDEV=aic78U2.add" statements in the config.sys file.

b. For UltraSCSI or earlier host adapters, add "BASEDEV=aic7870.add" to the top line of config.sys on IBM OS/2 diskette #1. This will result in two "BASEDEV=aic7870.add" statements in the config.sys file.)

6. Run the IBM OS/2 installation program; follow the instructions in your IBM OS/2 documentation, until you reach the System Configuration window.
7. In the System Configuration window, click the SCSI Adapter Support icon.
8. Deselect any highlighted adapters (including the Adaptec 294x, 394x, AIC7870 PCI SCSI), and click OK. The text box for SCSI Adapter Support should say "None".

NOTE: If these adapters are not deselected, the driver included on the CD-ROM will be copied over the driver being installed.)

9. Follow the instructions in your IBM OS/2 documentation to complete the installation.

NOTE: Verify after installation is complete, that only one "BASEDEV=aic78U2.add" or "BASEDEV=aic7870.add" statement exists in your config.sys file on your hard drive. Remove other instances if more than one is found.

Known Issues

- This version of the Adaptec 7800 Family Manager Set v3.00 driver added a new switch named `!/PCIHW` which enables the driver to skip accessing the PCI hardware registers directly, and use PCI BIOS instead. This switch could be useful for users having problems loading the driver included with IBM OS/2 Warp or SMP. Modify the CONFIG.SYS file to include the following line:
 - a. For Ultra2SCSI host adapters:

```
BASEDEV=AIC78U2.ADD !/PCIHW
```
 - b. For UltraSCSI or earlier host adapters:

```
BASEDEV=AIC7870.ADD !/PCIHW
```
- Intel Errata #8511 lists known data integrity issues with the processor cache on the Saturn-1 chipset (82424TX). For this reason, Adaptec recommends that processor cache be disabled via the CMOS setup to avoid data corruption. For more information, see Intel Errata #8511. You may get this from Intel's FaxBack system at 800.628.2283 or 916.356.3105. For more detailed information see Errata #8512 and #8513.
- Can't install on the maximum hard disk drive partition size supported by IBM OS/2 v3.0. On IBM OS/2 v3.0 it is a known problem. Refer to IBM for further info. IBM's APARs PJ15988 and PJ 6151 deal with this issue.

Additional Notes

- This version of the Adaptec 7800 Family Manager Set v3.00 driver supports the AIC-7800 Family of Host Adapters. Adapter numbers are first assigned to boards with their BIOS enabled. The numbers are assigned from lowest BIOS address to highest address. Any remaining boards are assigned numbers by scanning slots. Each slot is a combination of a bus number and a device number pair starting from lowest to highest numbers, and the adapters are assigned a number in the order they are found.

Example: Bus 0, device 0 assigned as adapter 0,
 Bus 1, device 1 assigned as adapter 1, etc.

IBM OS/2

- On some PCI systems, users may sometimes have problems loading the driver when the host adapter board is seated in a particular slot. Moving the host adapter board to another slot may solve the problem. If the problem still persists, it may be occurring because the Adaptec 7800 Family Manager Set v3.00 driver is unable to access the PCI hardware registers directly. To overcome this, users should use the `!/PCIHW` switch. Modify the `CONFIG.SYS` file to include the following line:
 - a. For Ultra2SCSI host adapters:

```
BASEDEV=AIC78U2.ADD !/PCIHW
```
 - b. For UltraSCSI or earlier host adapters:

```
BASEDEV=AIC7870.ADD !/PCIHW
```
- There are no switches for controlling `OS2ASPI.DMD` directly. IBM did not define them in their specification and we cannot be sure that other host adapters will have the same switches.
- `OS2SCSI.DMD` will only allocate devices when a device driver requests it, but this will prevent `OS2ASPI` from accessing it. There is nothing in the `ASPI` specification regarding device allocation so `OS2ASPI` must rely on other managers to fairly share targets. This should only be a problem if you have two drivers that use different managers and you want them both to access the same target at the same time.
- Do NOT disable DASD manager access to target 0 if you are booting from your SCSI host adapter. This will prevent the system from booting!
- Fault Tolerance is supported in the driver. However, `ABORT` and `SCSI BUS RESET` will only work for targets that are properly behaved.
- IBM does not support installing the operating system onto magneto optical devices. Additionally, `OPTICAL.SYS` (IBM OS/2 V3.0) or `OPTICAL.DMD` (IBM OS/2 V4.0) allows magneto optical devices to be supported as though they were large floppy devices. `LOCKDRV.FLT` allows removable media such as MO's to be supported as though they were fixed hard drives.
- It is not possible to install IBM OS/2 3.0 on drives with capacity greater than 8 GB, nor in a partition greater than 4 GB. Contact IBM support for the appropriate fixes.

Command Line Options

IBM OS/2 adapter device drivers (.ADD files) are normally installed automatically and require no further information from the user. However, in certain situations the user may wish to modify the behavior of the driver to meet their specific needs.

IMPORTANT: Please proceed cautiously with the following information.

The standard format for command line switches is :

1. For Ultra2SCSI host adapter:

BASEDEV=AIC78U2.ADD [Universal Parameter][Adapter ID][Unit Parameter] {SCSI Target ID}

2. For UltraSCSI or earlier host adapters:

BASEDEV=AIC7870.ADD [Universal Parameter][Adapter ID][Unit Parameter] {SCSI Target ID}

- [Universal Parameter] - An option that applies to all adapters controlled by the driver.
- [Adapter ID] - /A:n, where n is the number (zero relative) of the adapter installed in the system. The adapter ID is determined when the driver is loaded based on the order that adapters are found in the system. (Refer to the Configuration Examples in the "General Unit Parameters" section below for information on how to use this option.)
- [Unit Parameter] - Modifies the behavior of the selected host adapter
- [SCSI Target ID] - The targets to which the Unit Parameter will be applied. This parameter may be a single ID (d) or list of IDs (d,d,d).

Universal Parameters:

- /ET -- Allow embedded targets. This parameter indicates that the ADD should assume that all targets have more than one logical unit (LUN) defined.
- /!ET -- Do not allow embedded targets (DEFAULT). This parameter indicates that the ADD should assume that all targets have only one logical unit (LUN) defined.
- /V -- Load driver verbosely. This parameter will display the driver name as well as the version number and Adaptec copyright if the driver loads successfully. Information on all targets found in the system will also be displayed.
- /PCIHW -- Enables driver to access PCI configuration hardware registers. This switch is implemented because in some PCI systems, accessing PCI configuration space through PCI BIOS function calls causes problems. This switch is enabled by default.
- /!PCIHW -- Disables the PCIHW switch. This parameter will cause the driver to access the PCI configuration space through PCI BIOS function calls.

General Unit Parameters:

- /I -- Ignore the specified adapter. This allows another driver to share the adapters that the ADD would normally use.
- /DM -- Enable DASD manager support (DEFAULT). This parameter allows OS2DASD.DMD to control the specified target(s) if they are identified as DASD (hard disk) devices.
- /!DM -- Disable DASD manager support. This parameter prevents OS2DASD.DMD from controlling the specified target(s).
- /SM -- Enable SCSI manager support (DEFAULT). This parameter allows OS2SCSI.DMD to control the specified target(s) if they are identified as NON-DASD SCSI devices. All SCSI hard drives will be controlled by OS2DASD.DMD.
- /!SM -- Disable SCSI manager support. This parameter prevents OS2SCSI.DMD from controlling the specified target(s).
- /TAG -- Specifies the maximum number of tagged commands for all target devices on the host adapter (1-16). A value of 1 disables tagged queuing. The maximum number allowed is 16. (The default is 8.)
- /UR -- Enables reporting of under runs (DEFAULT).
- /!UR -- Disables reporting of under runs.

Configuration Examples:

Example 1:

Suppose that you had a removable hard drive as target 3 and you wanted to control the hard drive with an ASPI application and driver. Normally OS2DASD will allocate this device, treat it as a large floppy and prevent you from sending any SCSI commands via ASPI.

The following command line will prevent OS2DASD.DMD from accessing the target and still allow OS2SCSI.DMD and OS2ASPI.DMD to share access to it.

```
BASEDEV=AIC78U2.ADD /A:0 /!DM:3
```

Example 2:

Suppose that you had a multi-disk CD-ROM as target 4 on host adapter 0 and two DASD devices as targets 1 and 5 on host adapter 1. The following command line will prevent OS2SCSI.DMD from accessing the CD-ROM and prevent OS2DASD.DMD from controlling the DASD devices. The driver will also search for multiple LUNs on all host adapters.

```
BASEDEV=AIC7870.ADD /ET /A:0 /!SM:4 /A:1 /!DM:1,5
```

IBM OS/2

Special Unit Parameters:

- `/TAG: --` Sets the number (1-16) of tagged commands for all target devices on the host adapter. A value of one disables tagged queuing 16 is the maximum number allowed and 8 is the default value.
- `/TAG:1 --` Disables tagged queuing for all target devices on a given host adapter. The driver maintains a maximum of 2 non-tagged commands per target internally. The driver treats all target devices as non-tagged devices, and sends only one command at a time per target to the host adapter.

Example:

BASEDEV=AIC78U2.ADD /A:0/TAG:8 will set the number of tagged commands for all target devices on the first host adapter to 8.

Diskette Contents

The following files are included in this diskette:

- `\OS2\README.TXT` - This file
For Ultra2SCSI host adapters:
- `\OS2\AIC78U2\AIC78U2.ADD` - The Adaptec Ultra2SCSI driver for the 7800 Family Manager Set v3.00
- `\OS2\AIC78U2\AIC78U2.DDP` - Install script used by the IBM OS/2 Install utility
- `\OS2\AIC78U2\78U2PRES.EXE` - Adapter Presence Check program used by the Install script

For UltraSCSI or earlier host adapters:

- `\OS2\AIC7870\AIC7870.ADD` - The UltraSCSI Adaptec driver for the 7800 Family Manager Set v3.00
- `\OS2\AIC7870\AIC7870.DDP` - Install script used by the IBM OS/2 Install utility
- `\OS2\AIC7870\7870PRES.EXE` - Adapter Presence Check program used by the Install script
- `\OS2\AIC7870\IBMINT13.I13` - Used for a first time install of IBM OS/2 2.1x
- `\OS2\AIC7870\OS2LDR` - Used for a first time install of IBM OS/2 2.1x

C. BusMaster

1. After running SETUP.EXE, copy PIIXIDE.ADD and PIIXIDE.FLT to the \OS2 directory on the boot drive.
2. Make the following changes to the CONFIG.SYS file:
Replace: With:
BASEDEV=IBM1S506.ADD BASEDEV=PIIXIDE.ADD
Replace: With:
BASEDEV=IBMIDECD.ADD BASEDEV=PIIXIDE.FLT
3. Shutdown and reboot the system.

NOTE: PIIXIDE.ADD auto-detects DMA capable hard disk drives and configures them and the Intel PCIset for bus master DMA transfers.

IBM OS/2

(This page was intentionally left blank.)

Appendix

i. Network Interface	121
Features	121
Software Driver Support	121
LED Connectors	122
DOS and Windows 3.1 Setup for Novell	123
<i>Automatic configuration</i>	123
<i>Run Setup to install network drivers</i>	123
<i>Troubleshooting</i>	124
<i>Responder testing on the network (optional)</i>	124
Windows NT Server or Workstation	124
<i>Automatic configuration</i>	124
<i>Install network drivers - Windows NT Version 4.0 only</i>	124
<i>Install network drivers - Windows NT Version 3.5x only</i>	125
<i>Troubleshooting</i>	125
Windows 95	126
<i>Automatic Configuration</i>	126
<i>Install Network Drivers from Diskette</i>	126
<i>Troubleshooting</i>	126
Select Duplex Mode (optional)	127
<i>Manually Configuring for Full Duplex</i>	127
<i>NetWare server</i>	128
<i>Windows NT</i>	128
<i>Windows 95</i>	128
<i>Other operating systems</i>	128
Troubleshooting	129
<i>If the interface can't connect to the network</i>	129
<i>Testing the network interface or adapter</i>	130
<i>Common problems and solutions</i>	130
Technical Information	132
<i>Fast Ethernet Wiring</i>	132
<i>Fast Ethernet Hubs and Switches</i>	132
Using Wake-On-LAN	133
<i>Question and Answer</i>	133
Glossary	134
ii. SCSI BIOS	135
Configuring the SCSI Adapter	135
<i>SCSI Disk Utilities</i>	135

Appendix

iii. EZ-SCSI Utility	136
Quick Start Instructions	136
<i>Windows95 or WindowsNT</i>	<i>136</i>
<i>Windows/Windows for Workgroups 3.1x</i>	<i>136</i>
<i>DOS</i>	<i>136</i>
Troubleshooting Tips	137
<i>SCSI Device Troubleshooting</i>	<i>137</i>
<i>Windows95/WindowsNT Troubleshooting</i>	<i>137</i>
Information for DOS/Windows 3.1x Users	140
<i>DOS and Windows3.1x Device Drivers</i>	<i>140</i>
<i>DOS and Windows3.1x ASPI Managers</i>	<i>140</i>
<i>DOS Formatting Utilities</i>	<i>141</i>
<i>Low-level Formatter (scsifmt)</i>	<i>141</i>
iv. Desktop Management Interface (DMI)	144
<i>Introducing the ASUS DMI Configuration Utility</i>	<i>144</i>
<i>System Requirements</i>	<i>144</i>
<i>Using the ASUS DMI Configuration Utility</i>	<i>145</i>
v. ASUS PCI-L101 Fast Ethernet Card	147
Features	148
Software Driver Support	148
Question and Answer	148

Appendix

i. Network Interface

This motherboard features an optional 32-bit 10/100Mbps Ethernet network interface. This interface supports the bus mastering architecture and auto-negotiation feature, which makes it possible to use the common twisted-pair cabling with RJ45 connectors for both 10Mbps and 100Mbps connections. Extensive driver support for commonly-used network systems is also provided.

Features

- Intel 82558 Ethernet LAN Controller (Fully integrated 10BASE-T/100BASE-TX)
- Wake-On-LAN Remote Control Function Supported
- PCI Bus Master Complies to PCI Rev. 2.1
- Consists of MAC & PHY (10/100Mbps) interfaces
- Complies to IEEE 802.3 10BASE-T and IEEE 802.3U 100BASE-TX interfaces
- Fully supports 10BASE-T & 100BASE-TX operations
- Single RJ-45 Connector: Auto-Detection of 10Mbps or 100Mbps Network Data Transfer Rates and Connected Cable Types
- 32 bit Bus Master Technology / PCI Rev. 2.1
- Plug and Play
- Enhancements on ACPI & APM
- Adheres to PCI Bus Power Management Interface Rev. 1.0, ACPI Rev. 1.0, and Device Class Power Management Rev. 1.0

Software Driver Support

- **NetWare ODI Drivers** - Novell Netware 3.x, 4.x, DOS, OS/2 Client
- **NDIS 2.01 Drivers** - Microsoft LAN Manager, Microsoft Windows 3.11, IBM LAN Server
- **NDIS 3.0 Drivers** - Microsoft Windows NT, Microsoft Windows 95, Microsoft Windows 3.11

Appendix

LED Connectors

Link Indicator: This connects to an LED to monitor 10Base-T and 100Base-TX connections. The LED lights to indicate a successful network connection, and remains steady if the connection is stable. If this indicator is off, the cable connection between the hub and the computer may be faulty or the driver configuration may be faulty.

Activity Indicator: This connects to an LED to monitor network activity. The LED lights when there are network packets sent or received through the RJ45 port. The rate of flashing is proportional to the amount of network traffic. If this is off, the computer is not sending or receiving network data.

Speed Indicator: This connects to an LED to monitor connection speed. The LED lights (**On**) when connection is made to a 100Base-TX host. If **Off**, the network connection is operating at 10Mbps.

Network Cable Connection

Twisted Pair Ethernet (TPE) - Connect a single network cable to the RJ45 connector. For 100BASE-TX, your network cable must be category 5 (not category 3), twisted-pair wiring with RJ45 connectors. If you plan on running the interface at 100 Mbps, it must be connected to a 100BASE-TX hub (not a 100BASE-T4 hub). For 10BASE-T, use category 3, 4, or 5 twisted-pair wiring.

Twisted-Pair Cable

The cable used to connect the Ethernet card to a host (generally a Hub) is called a straight-through twisted-pair. The end connectors are called RJ45 connectors, which are not compatible with the standard RJ11 telephone connectors. The illustration shows a connection between a typical Hub and this motherboard's network interface.

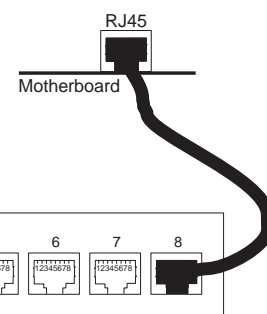

Straight-Through Cable

Hub	Card
1 IRD+	1 OTD+
2 IRD-	2 OTD-
3 OTD+	3 IRD+
6 OTD-	6 IRD-

RJ45 Connector

Pin 1	Output Transmit Data +
Pin 2	Output Transmit Data -
Pin 3	Input Receive Data +
Pin 6	Input Receive Data -
Pins 4,5,7,8	(Reserved)

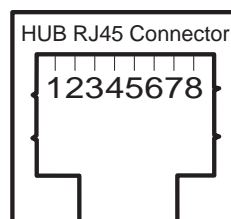

Appendix

DOS and Windows 3.1 Setup for Novell

Automatic configuration

Some computers automatically detect and configure adapters and interfaces while booting. The network interface's IRQ level and I/O memory address of this motherboard are automatically set by the BIOS each time you start your computer.

Start your computer to automatically configure the network interface. Configuration is complete when the DOS prompt appears. You can now continue with the procedure below.

If your computer displays an error while booting, it may require additional steps.

Run Setup to install network drivers

Setup can automatically install NetWare DOS ODI client drivers for you or display a README file with installation instructions for other NOS drivers.

1. If your computer already has network drivers installed, restart the computer without loading them. If the drivers are loaded from the AUTOEXEC.BAT or CONFIG.SYS file, type REM in front of each line that loads a network driver. Or, with DOS 6.x or later press "F5" as DOS starts, to bypass the drivers.
2. Insert the ASUS Configuration and Drivers disk in a floppy drive, switch to that drive, and at the DOS prompt, type "SETUP".
3. If you have another network adapter in your computer, an adapter selection menu appears on the screen. Select the adapter you want by noting the Ethernet address.
4. Select Automatic Setup from the Main menu. Then follow the instructions on the screen. (If you want to test the interface with a responder on the network, see the next procedure.) Setup displays the configuration, then runs a series of diagnostic tests that makes sure the network interface or adapter and network are functioning properly. If Setup finds a problem, it displays the results and some possible solutions.
5. When Setup finishes the tests, you'll see the Install Network Drivers screen.
6. Select the driver you want to install. Setup can install a NetWare client driver for you. If you're installing other drivers, Setup displays a README file with installation instructions.

Appendix

Troubleshooting

If you can't connect to a server, first try the suggestions here, then turn to the Troubleshooting section if necessary.

- Make sure you're using the drivers for this interface. The driver filename contains the letter B (for example, E100BODI.COM).
- If you're replacing an existing adapter, make sure the LINK statement in your NET.CFG is correct for the new interface or adapter. For example, the LINK statement for a NetWare client should be: "LINK DRIVER E100BODI"
- Verify that the frame type in your NET.CFG file matches your network.
- If setting up a server, check your LOAD and BIND statements.
- Test the interface by running diagnostics in Setup. Additional testing is available by using a responder.
- Check the README files.

Responder testing on the network (optional)

Setup can test the interface more thoroughly if you have a responder on the network while running the tests.

1. Go to a computer on the network with any EtherExpress adapter or interface installed (except EtherExpress 32 or EtherExpress 16 MCA).
2. Run the appropriate configuration program for the installed interface and set it up as a responder.
3. Return to the computer with the new adapter or interface. Run Setup and make the new interface the sender. Test the interface.

Windows NT Server or Workstation

Automatic configuration

Some computers automatically detect and configure adapters or interfaces while booting. The network interface's IRQ level and I/O address are automatically set by the BIOS each time you start your computer.

Start your computer to automatically configure the network interface. Configuration is complete when Windows NT starts or the DOS prompt appears.

If your computer displays an error while booting, it may require additional steps to configure.

Install network drivers - Windows NT Version 4.0 only

After starting Windows NT, you need to install the device drivers. Have the Windows NT CD-ROM disk available for this procedure.

Appendix

NOTE: If you are installing Windows NT 4.0 at this time, click the Start Search button when the network network interface or adapter installation window appears. This allows NT to autodetect the network interface or adapter. You may then skip steps 1 - 4 below.

1. Double-click the Network icon in the Control Panel.
2. Click the **Adapters** tab in the window that appears.
3. Click **Add**. A list of network interface or adapter appears.
4. Select “Intel EtherExpress PRO Adapter” and click **OK**.

Install network drivers - Windows NT Version 3.5x only.

After setting up the network interface and starting Windows NT, you need to install the Intel drivers and test the network interface or adapter.

1. Double-click the Network icon in the Control Panel.
2. Click **Add Adapter**.
3. When the list of adapters appears, scroll to the end of the list and select <Other> Requires disk from manufacturer.
4. Insert the ASUS Configuration and Drivers disk in the A: drive and click **OK**.
5. Select the “Intel EtherExpress PRO Adapter” and click **OK**.
6. Click **OK** in the Network Settings dialog box and remove the installation disk. When prompted, restart Windows NT.

To install multiple network interface or adapters, repeat this procedure for each new network interface or adapter.

Troubleshooting

If Windows NT reports an error or you can't connect to the network, try the suggestions here first, then turn to the Troubleshooting section if necessary.

- Make sure you're using the drivers for this network interface or adapter. Drivers are located on the Windows NT CD-ROM or on the ASUS Drivers and Configuration disk.
- Make sure the driver is loaded and the protocols are bound. Check the Network Bindings dialog box in Windows NT.
- Check the Windows NT Event Viewer for error messages.
- If you are attaching to a NetWare network, check your frame type and verify that NetWare client software has been installed.
- Check with your LAN administrator — you may need to install supplemental networking software.

Appendix

Windows 95

Automatic Configuration

Some computers automatically detect and configure adapters or interfaces while booting. The network interface's IRQ level and I/O address of this motherboard are automatically set by the BIOS each time you start your computer.

Start your computer to automatically configure the network interface or adapter. Configuration is complete when Windows 95 starts. If your computer displays an error while booting, it may require additional steps to configure.

Install Network Drivers from Diskette

Have your Windows 95 installation CD-ROM or disks available, as Windows 95 prompts for them when you install the new network interface or adapter.

1. After you have set up your motherboard for network use, start Windows 95. The *New Hardware Found* dialog box appears. If this box does not appear and Windows 95 starts normally, you may need to manually add the network interface or adapter.
2. Click "Driver from disk provided by hardware manufacturer," then click **OK**. The *Install From Disk* dialog box appears.
3. Insert the ASUS Configuration and Drivers disk.
4. Specify A:\ (or B:\) as the path, then click **OK**.
5. Follow prompts for any Windows 95 installation disks and restart when prompted. (If you installed from CD-ROM, the installation files are typically located at D:\Win95, where D is your CD-ROM drive.)

After restarting Windows 95, you should be able to connect to your network by double-clicking the Network Neighborhood.

Troubleshooting

If you can't connect to a server or if Windows 95 reports an error after you double-click Network Neighborhood, try the suggestions here first, then the Troubleshooting section if necessary.

- Make sure you're using the drivers that are on the drivers diskette that ships with this network interface or adapter.
- Make sure the driver is loaded and the protocols are bound. Check Device Properties list for trouble indicators (an X or ! symbol).
- Check with your LAN administrator — you may need to install supplemental networking software.

NetWare Server, Client 32, UNIX, OS/2, Banyan, and Other Operating Systems

For these, refer to our online documents. On a DOS computer, view the appropriate README file for information on installing your network driver.

Appendix

Select Duplex Mode (optional)

Duplexing is a performance option that lets you choose how the network interface or adapter sends and receives data packets over the network. This motherboard's network interface can operate at full duplex only when connected to a full duplex 10BASE-T, 100BASE-TX switching hub, or another full duplex network interface or adapter. To summarize:

- **Auto (requires a full duplex network interface or adapter or switching hub with auto-negotiation capability).** The network interface or adapter negotiates with the hub to send and receive packets at the highest rate. This is the default setting. If the hub does not provide auto-negotiation, the network interface or adapter runs at half duplex.
- **Full duplex (requires a full duplex switching hub or network interface or adapter).** The network interface or adapter can send and receive packets at the same time. This mode can increase network interface or adapter performance capability. If the full duplex hub provides auto-negotiation, the network interface or adapter runs at full duplex. If the full duplex hub does not provide auto-negotiation, you need to set the network interface or adapter duplex mode manually (see following paragraphs)
- **Half duplex.** The network interface or adapter performs one operation at a time; it either sends or receives.

NOTE: If your hub is running at 100 Mbps and half duplex, your potential bandwidth is higher than if you run at 10 Mbps and full duplex.

Manually Configuring for Full Duplex

If your switch supports auto-negotiation with the N-way standard, duplex configuration is automatic and no action is required on your part. However, few switches in the current installed base support auto-negotiation. Check with your network system administrator to verify. Most installations will require manual configuration to change to full duplex.

Configuration is specific to the driver you're loading for your network operating system (NOS), as shown in the following paragraphs. To set up the duplex mode, refer to the section below that corresponds to your operating system. The performance of the network interface or adapter may suffer or your network interface or adapter may not operate if your hub does not support full duplex and you configure the network interface or adapter to full duplex. Leave the network interface or adapter on half duplex if you are not sure what type of hub you are connected to.

DOS ODI, NDIS 2.01 Clients

Edit the NET.CFG or PROTOCOL.INI file. Add keywords to Link Driver section:

```
FORCEDUPLEX 2  
SPEED 100 (or 10 if 10BASE-T)
```

Appendix

NetWare server

In AUTOEXEC.NCF, Load E100B.LAN and add the following statement (you must include the equal sign for servers):

```
FORCEDUPLEX=2  
SPEED=100 (or 10 if 10BASE-T)
```

For more information, see the README file for NetWare servers.

Windows NT

While running Windows NT:

1. From the Control Panel, double-click the Intel PROSet icon.
2. PROSet examines your system and displays the Adapter Setup window.

Windows 95

While running Windows 95:

1. From the Control Panel, double-click the Intel PROSet icon.
2. PROSet examines your system and displays the Adapter Setup window. If you have multiple adapters, click the adapter you are configuring (you can identify it by its Ethernet address). Each adapter must be configured separately.
3. From the window that appears, click **Change**.
4. From the Adapter Setup window, click the menu for Network Speed.
5. Click **100** or **10 Mbps**, depending on your hub speed.
6. Click the menu for Duplex Mode
7. Click **Full**.
8. Click **OK** when finished.
9. Click **OK** to restart Windows 95.

Other operating systems

See the *Adapter Installation and Special Configurations* README file. "Push" Installation for Windows 95

If you are a LAN Administrator setting up server-based push installation of Windows 95 as defined in Microsoft Windows 95 Resource Kit, additional steps are required for this network interface or adapter.

Appendix

Troubleshooting

If the interface can't connect to the network

Make sure the cable is installed properly.

The network cable must be securely attached at both RJ-45 connections (interface and hub). If the cable is attached but the problem persists, try a different cable. The maximum allowable distance from network interface or adapter or interface to hub is 100 meters.

If you're directly connecting two computers (no hub), use a crossover cable. Most hubs require a straight-through cable, while most switches require a crossover cable (see your hub or switch documentation to verify).

Check the LED lights on the network interface or adapter.

The optional network condition connector module has three diagnostic LEDs. These lights help indicate if there's a problem with the connector, cable, or hub. The table below describes the LEDs.

LED	Indication	Meaning
LNK	On	The interface and hub have acknowledged a connection; the link between the hub and interface is good.
	Off	The cable connection between the hub and interface is faulty; or you have a driver configuration problem.
ACT	On or flashing	The interface is sending or receiving network data. The frequency of the flashes varies with the amount of network traffic.
	Off	The interface is not sending or receiving network data.
SPD	On	Network connection operating at 100 Mbps.
	Off	Network connection operating at 10 Mbps.

Make sure you're using the correct drivers.

Make sure you're using the drivers that come with your motherboard. The driver filename contains the letter B (for example, E100BODI.DOS).

Make sure the hub port and the network interface or adapter have the same duplex setting.

If you configured the network interface for full duplex, make sure the hub port is also configured for full duplex. Setting the wrong duplex mode can degrade performance, cause data loss, or result in lost connections.

Appendix

Testing the network interface or adapter

Test the network interface or adapter by running Intel diagnostics. For DOS or Windows 3.1 computers, run Setup on the ASUS Configuration and Drivers disk. For Windows NT and Windows 95 run Intel PROSet by double-clicking the Intel PROSet Icon in the Control Panel. Click Help from the main PROSet window to get complete diagnostics information and instructions.

Common problems and solutions

SETUP.EXE reports the network interface or adapter is “Not enabled by BIOS”.

- The PCI BIOS isn't configuring the network interface or adapter correctly. Try the PCI installation tips.

The computer hangs when the drivers are loaded.

- Change the PCI BIOS interrupt settings. See the next page for PCI installation tips.
- If you are using EMM386, it must be version 4.49 or newer (this version ships with MS-DOS 6.22 or newer).

Diagnostics pass, but the connection fails or errors occur.

- At 100 Mbps use category 5 wiring and make sure the network cable is securely attached.
- For NetWare clients, make sure you specify the correct frame type in the NET.CFG file.
- Make sure the duplex mode setting on the network interface or adapter matches the setting on the hub.
- At 100 Mbps, connect to a 100BASE-TX hub only (not T4).

The LNK LED doesn't light.

- Make sure you've loaded the network drivers.
- Check all connections at the network interface or adapter and the hub.
- Try another port on the hub.
- Make sure the duplex mode setting on the network interface or adapter matches the setting on the hub.
- Make sure you have the correct type of cable between the network interface or adapter and the hub. 100 BASE-TX requires two pairs. Some hubs require a cross-over cable while others require a straight-through cable. See the *Cabling* README file for more information on cabling.

The ACT LED doesn't light.

- Make sure you've loaded the correct network drivers.
- The network may be idle. Try accessing a server.
- The network interface or adapter isn't transmitting or receiving data. Try another network interface or adapter.
- May not be using four-pair cable for TX wiring.

Appendix

The network interface or adapter stopped working when another network interface or adapter was added to the computer.

- Make sure the cable is connected to the motherboard's network interface or RJ45 port.
- Make sure your PCI BIOS is current.
- Make sure the other network interface or adapter supports shared interrupts. Also, make sure your operating system supports shared interrupts — OS/2* doesn't.

The interface stopped working without apparent cause.

- Try reconnecting the cable to the RJ45 port first.
- The network driver files may be corrupt or deleted. Delete and then reinstall the drivers.
- Try another motherboard of the same model.
- Run the diagnostics.

The Wake On LAN feature is not working.

- Make sure the WOL cable is attached and power is applied to the computer.
- Check the BIOS for its WOL setting. Some computers may need to be configured to WOL.
- Make sure the network cable is fully attached to the network interface or adapter.

Link LED does not light when power is connected.

- Make sure WOL cable is attached and power is applied to computer.
- Make sure network cable is attached at both ends.

Appendix

Technical Information

Fast Ethernet Wiring

100BASE-TX Specification: The 100BASE-TX specification supports 100 Mbps transmission over two pairs of category 5 twisted-pair Ethernet (TPE) wiring. One pair is for transmit operations and the other for receive operations. Segment lengths are limited to 100 meters with 100BASE-TX for signal timing reasons. This complies with the EIA 568 wiring standard.

Fast Ethernet Hubs and Switches

The two basic types of hubs are shared hubs and switching hubs. This motherboard's network interface can be used with either type of hub for 10 Mbps. At 100 Mbps, a TX hub or switch is required.

Shared hubs

In a shared network environment, computers are connected to hubs called repeaters. All ports of the repeater hub share a fixed amount of bandwidth, or data capacity. On a 100 Mbps shared hub, all nodes on the hub must share the 100 Mbps of bandwidth. As stations are added to the hub, the effective bandwidth available to any individual station gets smaller. Shared hubs do not support full duplex.

Think of a shared repeater hub as a single-lane highway that everyone shares. As the number of vehicles on the highway increases, the traffic becomes congested and transit time increases for individual cars.

On a shared hub all nodes must operate at the same speed, either 10 Mbps or 100 Mbps. Fast Ethernet repeaters provide 100 Mbps of available bandwidth, ten times more than what's available with a 10BASE-T repeater.

Repeaters use a well-established, uncomplicated design, making them highly cost effective for connecting PCs within a workgroup. These are the most common type of Ethernet hubs in the installed base.

Switching hubs

In a switched network environment, each port gets a fixed, dedicated amount of bandwidth. In the highway scenario, each car has its own lane on a multi-lane highway and there is no sharing.

In a switched environment, data is sent only to the port that leads to the proper destination station. Network bandwidth is not shared among all stations, and each new station added to the hub gets access to the full bandwidth of the network.

If a new user is added to a 100 Mbps switching hub, the new station receives its own dedicated 100 Mbps link and doesn't impact the 100 Mbps bandwidth of another station. Switching hubs can effectively increase the overall bandwidth available on the network, significantly improving performance. Switching hubs can also support full duplex.

Appendix

Using Wake-On-LAN

The Wake-On-LAN feature operates according to a published specification. In simple terms, the specification allows designers to build network adapters or interfaces that are capable of “listening to” network activity even when the computer is turned off. WOL adapters or interfaces have a special low power standby mode that is active when the rest of the computer is without power. The network interface or adapter will respond to a special “wake-up” packet sent by another computer or network device. Typically this wake-up packet causes the network interface or adapter to signal the computer to power up and run a pre-defined program.

Question and Answer

Q: What is Wake-On-LAN ?

A: The Wake-On-LAN feature provides the capability to remotely power on systems supporting Wake-On-LAN by simply sending a wake-up frame. With this feature, remotely uploading/downloading data to/from systems during off-peak hours will be feasible.

Q: What can Wake-On-LAN do for you ?

A: Wake-On-LAN is a remote management tool with advantages that can reduce system management workload, provide flexibility to the system administrator’s job, and then of course save you time-consuming efforts and costs.

Q: What components does Wake-On-LAN require to be enable?

A: To enable Wake-On-LAN function, your system requires an Ethernet LAN adapter card or interface that can activate the Wake-On-LAN function, a client with Wake-On-LAN capability, and software such as LDCM Rev. 3.10 or up that can trigger the wake-up frame.

Appendix

Glossary

100Base-TX

IEEE's specification for running 100Mbps Ethernet using twisted-pair cables.

10Base-T

IEEE's specification for running 10Mbps Ethernet using twisted-pair cables.

10Base2

IEEE's specification for running Ethernet using thick coaxial cables.

BNC

A connector with a half-twick locking shell typically used for thin coaxial cables.

Boot ROM

Read-only memory chip that allows a workstation to communicate with LAN cards or other network interfaces.

Driver

A program that enables the network operating system to communicate with LAN cards.

IEEE 802.3 standard

Standard for the physical and electrical connections in local area networks developed by the IEEE (Institute of Electrical and Electronics Engineers).

IEEE 802.3u standard

IEEE standard for Local Area Networks (LAN) employing CSMA/CD as the access method. This standard is intended to encompass several media types and techniques for signal rates from 1Mb/s to 100Mb/s.

Interrupt (IRQ)

Signal suspending a program temporarily and transfers control to the operating system when input or output is required.

LED

Light emitting diode

Mbps

Megabits per second

Appendix

ii. SCSI BIOS

Configuring the SCSI Adapter

Access the SCSI BIOS by holding down both **CTRL** and **A** keys when you see the BIOS banner message listing the driver name and the attached devices. For example:

Adaptec AIC-7890 SCSI BIOS Build 20107
(c) 1998 Adaptec, Inc. All Rights Reserved.

<<< Press <Ctrl><A> for SCSISelect(TM) Utility! >>>

The *SCSISelect* screen will come up. Instructions on how to move the cursor and select options are listed on the bottom of the program windows.

SCSI Disk Utilities

The SCSI Disk Utilities option displays information on SCSI IDs 0 through 15, listing all devices on the bus including non-disk devices. When you select a device from the list and press Enter key, another window appears giving you the option of selecting one of two sub-utilities, **Format Disk** or **Verify Media**. These utilities are used for hard disk drives only and will have no effect on other non-disk SCSI devices.

Format Disk - low-level formats your SCSI hard disks. In general, SCSI hard disks have already been low-level formatted when you get them, so you generally do not need to use this function.

Verify Media - scans the selected drive media for defects, notifies you of any defects found and gives you the option of reassigning bad blocks so that data will not be written to them. This utility is only necessary if you suspect that your SCSI disk drive has a problem.

Appendix

iii. EZ-SCSI Utility

Welcome to Adaptec EZSCSIVI, ADAPTEC EZ-SCSI UTILITY 4.03. Adaptec EZSCSI gives you what you need to use SCSI devices in DOS, Windows[®]3.1x, or Windows for Workgroups3.1x.

NOTE: The ADAPTEC EZ-SCSI UTILITY does not provide drivers for Windows[®]95 and WindowsNT[™].

Quick Start Instructions

First, install SCSI devices (see the hardware documentation for details). Then follow the instructions for your operating system software in one of the following sections. We recommend that after you install Adaptec EZSCSI, you run SCsITutor to learn more about the features of SCSI.

Windows95 or WindowsNT

If you want to install Windows95 or WindowsNT on a new computer system, you may not be able to access your SCSI CDROM drive at first. (Usually, you install Windows95 and WindowsNT from a CDROM disc.) To gain access to your CDROM drive, follow the DOS Quick Start instructions.

Windows/Windows for Workgroups 3.1x

1. Install Windows 3.1x or Windows for Workgroups 3.1x and start it running on your computer.
2. Insert the Adaptec EZSCSI Setup Disk into your floppy disk drive.
3. Select **File/Run** from the Program Manager menu.
4. When the Run dialog box appears, type **a:\setup** if you are using the A drive or **b:\setup** if you are using the B drive. Then click OK.
5. Follow the onscreen instructions.

DOS

1. Install DOS 6.x or later and start it running on your computer.
2. Insert the Adaptec EZSCSI Setup Disk into your floppy disk drive.
3. At the DOS prompt, type a:\install (assuming your 3.5" floppy is A: drive). Then press <Enter>.
4. Follow the onscreen instructions.

Appendix

Troubleshooting Tips

SCSI Device Troubleshooting

Review this checklist if your newly-installed SCSI disk drives, CDROM drives, and other devices do not seem to work properly:

- Be sure that termination is correctly set for all devices on the SCSI bus, as described in your host adapter documentation.
- Be sure there are no hardware conflicts such as devices in your computer trying to use the same interrupts (IRQs) or DMA channels.
- Be sure the cables connecting the external and internal SCSI devices and the host adapter are attached securely. Also be sure the pin-1 orientation is correct for internal cables. See the host adapter documentation for more information.
- Be sure that each SCSI device connected to the host adapter has a unique SCSI ID.
- Be sure CD-ROM drives and other SCSI devices are attached to a power source and are turned ON.

Windows95/WindowsNT Troubleshooting

What is a miniport driver, and how do I make sure that the miniport driver is installed correctly?

Miniport drivers are a new kind of 32bit protect mode device driver used by Windows95 and WindowsNT to control host adapters and other kinds of devices. Windows95 and WindowsNT include a set of miniport drivers for various types of SCSI host adapters. The host adapter miniport driver is automatically installed and configured during Windows95 and WindowsNT installation if your host adapter is already installed. To make sure the driver is installed correctly in systems running Windows95, open the Control Panel, double-click on System, and click the Device Manager tab. Then double-click the SCSI Controllers icon; you should see the model name of the SCSI host adapter(s) installed in your system.

What if there is no SCSI controllers icon under Device Manager, or the model name of the SCSI chipset does not appear under Device Manager?

If the SCSI controllers icon or your host adapter's model name do not appear, open Control Panel and double-click the Add New Hardware icon. Let Windows search for the host adapter by selecting Yes on the second screen of the Add New Hardware Wizard.

If Windows does not detect the host adapter, run the Add New Hardware Wizard again. This time, select No on the second screen of the wizard, then select SCSI controllers on the next screen. Select the name of your host adapter when it appears.

Appendix

If the name of your SCSI chipset does not appear, you may be able to find its miniport driver on the Windows95 CD-ROM. Follow these steps:

1. Place the Windows 95 CD-ROM in your CDROM drive and run the Add New Hardware wizard.
2. Select **No** on the second screen, and select **SCSI controllers** on the next screen.
3. Click on the **Have Disk** button, then click the **Browse** button.
4. Look in the \drivers\storage directory of the CDROM and select the name of your SCSI host adapter if it appears.

What if a yellow exclamation point or a red X appears in Device Manager in front of my host adapter?

This means there is some kind of resource problem. First, see if the names of any host adapters appear that are not actually installed in your computer. If so, select the name and click Remove. If a red X appears in front of your host adapter name, remove all the host adapter references under SCSI Controllers and run Add New Hardware, as described in the previous question/answer. If a yellow exclamation point appears in front of your host adapter name, the resources that the driver uses probably do not match the resources used by the hardware. Double-click the host adapter name, then click on the Resource tab. Deselect the Use automatic settings box and edit the resources (Interrupt Request, Direct Memory Access, etc.) so they match those used by the host adapter. If the problem still remains, there is probably a hardware resource conflict between the host adapter and other hardware in your computer. You can fix this by changing the hardware resource settings. (See your hardware documentation.)

What do I need to do if I want to use another host adapter?

1. Open the Control Panel, double-click **System**, and click the **Device Manager** tab.
2. Double-click the **SCSI Controllers** icon, select the name of the old host adapter, and click **Remove**.
3. Turn OFF the computer and physically remove the currently installed host adapter.
4. Install the new host adapter according to the instructions in the hardware documentation.
5. Turn the computer ON. If the new host adapter supports Plug and Play, Windows will install and configure it automatically. Otherwise, run Add New Hardware to make sure the new driver is loaded.

Appendix

If I am running under Windows95, do I need lines for the Adaptec real mode ASPI drivers and mscdex in my CONFIG.SYS and AUTOEXEC.BAT files?

Usually, you do not need to use these real mode ASPI drivers, because the new Windows miniport drivers support most SCSI host adapters and SCSI devices. However, you need to load the drivers (including mscdex, if you have a CDROM drive) if any of the following is true:

- You are running in MSDOS mode
- You are using a scanner or another SCSI device with CONFIG.SYS- or AUTOEXEC.BAT-based drivers, such as HP's sjix.sys
- You have an older model SCSI-1 CDROM drive that Windows95 does not support
- You are using a CD-Recorder drive (however, some newer models of CD-Recorder drives can use the embedded Windows miniport drivers)

To install the Adaptec EZSCSI DOS drivers, click the Start button and select **Restart the computer in MS-DOS mode**. When the DOS prompt appears, follow the Quick Start instructions for DOS.

My CD-ROM drive doesn't work properly under Windows95.

Some older models of SCSI CDROM drives are not compatible with the embedded Windows95 CDROM driver. You can add support for the CDROM drive by doing the following:

1. Click the **Start** button and select **Restart the computer in MS-DOS mode**.
2. When the DOS prompt appears, follow the Quick Start instructions for DOS.
3. When you are finished running Adaptec EZSCSI for DOS, find the file named `cdtsd.vxd` in the `windows\system\iosubsys` directory and rename it `cdtsd.sav`.

My CD-ROM drive shows up as more than one icon under My Computer.

The mapping between mscdex, which runs in real mode, and the Windows95 CDROM driver does not match. You can correct this in one of two ways:

- Comment out the line that loads `mscdex.exe` in the `AUTOEXEC.BAT` file.
- Change the `/L` switch on the line that loads `mscdex.exe` in the `AUTOEXEC.BAT` file so it assigns the CDROM drive the next highest logical drive letter after the hard disk drives.

Appendix

Information for DOS/Windows 3.1x Users

The following information may be useful if you install Adaptec EZSCSI on a computer running DOS, Windows 3.1x, or Windows for Workgroups 3.1x.

NOTE: The Windows95/WindowsNT Troubleshooting section on page 6 describes a few situations when you may need to use the DOS/Windows3.1x drivers and ASPI managers under Windows95 or WindowsNT.

DOS and Windows3.1x Device Drivers

Device drivers are software programs that enable your computer to communicate with SCSI devices such as hard disk drives, CDROM drives, and scanners. Each kind of device requires a different device driver. Adaptec EZSCSI includes several DOS/Windows3.1x device drivers that are copied to your hard disk during installation. Adaptec EZSCSI adds command lines to your CONFIG.SYS and AUTOEXEC.BAT files to load these device drivers if it finds these kinds of devices on your computer.

To learn more about the Adaptec EZSCSI device drivers, including their command line option information, see the online Adaptec EZSCSI Online Reference, a Windows Help application.

DOS and Windows3.1x ASPI Managers

ASPI (Advanced SCSI Programming Interface) managers are software programs that enable the SCSI device drivers, your host adapter, and your SCSI devices to communicate with each other. ASPI managers are written for a specific operating system, such as DOS, and a specific family of Adaptec host adapters.

Adaptec EZSCSI includes several ASPI managers for DOS/Windows3.1x. When you install Adaptec EZSCSI on these operating systems, it detects what kind of host adapter is installed in your computer and automatically configures your system with the correct ASPI manager. To learn more about these ASPI managers, including their command line option information, see the Adaptec EZSCSI Online Reference, a Windows Help application.

Appendix

DOS Formatting Utilities

Adaptec EZSCSI includes several DOS-based formatting utilities:

Low-level Formatter (*scsifmt*)

Use the DOS-based *scsifmt* utility for low-level formatting of SCSI hard disk drives, removable media, Floptical[®] drives, and magneto-optical drives. You can also use it to scan a disk device for surface defects before you store data on it.

Run *scsifmt* from the DOS prompt, not from the Windows MSDOS prompt. Before you run it, be sure the disk devices you want to format are connected to the host adapter and that they are powered. Then follow these steps:

1. Change to the directory where *scsifmt.exe* is located (usually `c:\scsi`), type *scsifmt* at the DOS prompt, and press Enter.
NOTE: If you are formatting a SCSI disk device that supports more than one LUN (for example, Iomega's Bernoulli dual multdrive) type *scsifmt /L* at the command line.
2. When the first screen appears, read it and press Enter to continue. (Press F1 at any time to view Help.) Information about your SCSI disk devices appears on the screen.
3. Use the arrow keys to move the highlight bar to a disk device you want to format or verify, then press <Enter>.
4. When the next screen appears, select either Format or Verify (to verify that the disk is free of surface defects), then press Enter.

WARNING! Back up important data before you format the disk device!
A low-level format erases all data from the disk.

5. If you select Format, confirm that you want to format the disk, then wait while the disk device is formatted. This may take a long time if the disk is large.
If you select Verify, you can press Esc at any time to stop the verification process. (This does not damage the disk.) If the utility finds bad blocks on the disk, it displays information about them. You can reassign the bad block(s) to prevent data from being stored there.
6. Repeat steps 3, 4, and 5, as needed, to format or verify other disk devices. When you are finished, press Esc to exit.

Appendix

Formatter and Partitioner (afdisk)

Use the DOS-based afdisk utility to partition and format SCSI hard disk drives, Floptical drives, and magneto-optical drives. You can also use afdisk to remove DOS and non-DOS partitions from a disk drive and to format removable media in standard hard disk format, OS/2 floppy format, or DOS V (Japanese) format.

NOTE: Use afdisk only if the disk device is not controlled by the host adapter BIOS—that is, if the host adapter does not have a BIOS or if its BIOS is not enabled. If the disk device is controlled by the host adapter BIOS, use the DOS fdisk utility to partition and format the disk device. (See the MSDOS documentation.)

Run **AFDISK** from the DOS prompt only, not from the Windows MSDOS prompt. Before you run it, be sure the disk devices you want to format and partition are connected to the host adapter and that they are powered. Then follow these steps:

1. Change to the directory where afdisk.exe is located (usually c:\scsi), type **AFDISK** at the DOS prompt, and press <Enter>. Information about your SCSI disk devices appears on the screen. (The number that appears after Target is the device's SCSI ID.)
2. Use the arrow keys to move the highlight bar to the disk device you want to partition, then press <Enter>.
 - If the selected disk device is controlled by the host adapter BIOS, you can view information about it but you cannot partition it with afdisk (Use the DOS fdisk and format utilities.)
 - If the selected disk device is unpartitioned, you must partition it before you can format it. To do this, follow the instructions on the screen. (Press F1 to see an explanation of the partitioning options.)

Information about the selected disk device appears in the lower left of the screen. Disks smaller than 1 Gigabyte have 64 heads, 32 sectors per track, and cylinders equal to the number of MB of available capacity. Disks larger than 1 Gigabyte have 255 heads, 63 sectors per track, and one cylinder per 8 MB of available capacity.

Appendix

- To create a new partition on the disk device, press <Ins>. A screen similar to this appears:

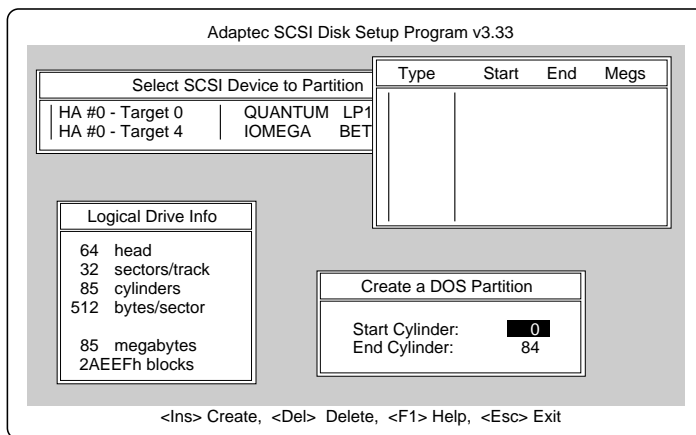

The *Create a DOS Partition* window suggests that you create one partition on the disk device, equal to its entire capacity. If this is what you want to do, skip to step 5.

- To change the size of the partition, use the arrow keys to select Start Cylinder and End Cylinder, and type in the numbers you want. Partitions up to 2 Gigabytes are supported.
- When the number of cylinders is what you want, press <Esc>. When the confirmation prompt appears, select **Yes** and press <Enter> to create the partition. To create more partitions on the same disk device, repeat steps 3, 4, and 5. As you create partitions on the disk, they are added to the window at the upper right of the screen, as shown here:

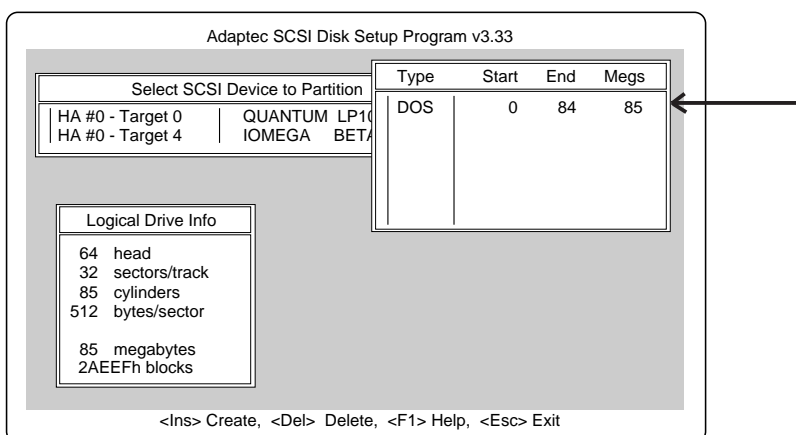

- Press <Esc> to return to the *Select SCSI Device to Partition* window. If you want to partition a different disk device, select the device from the list and repeat the earlier steps.
- To quit afdisk, press <Esc> and select **Yes** to confirm that you want to quit.

Appendix

iv. Desktop Management Interface (DMI)

Introducing the ASUS DMI Configuration Utility

This motherboard supports DMI within the BIOS level and provides a DMI Configuration Utility to maintain the Management Information Format Database (MIFD). DMI is able to auto-detect and record information pertinent to a computer's system such as the CPU type, CPU speed, and internal/external frequencies, and memory size. The onboard BIOS will detect as many system information as possible and store those collected information in a 4KB block in the motherboard's Flash EPROM and allow the DMI to retrieve data from this database. Unlike other BIOS software, the BIOS on this motherboard uses the same technology implemented for Plug and Play to allow dynamic real-time updating of DMI information versus creating a new BIOS image file and requiring the user to update the whole BIOS. This DMI Configuration Utility also allows the system integrator or end user to add additional information into the MIFD such as serial numbers, housing configurations, and vendor information. Those information not detected by the motherboard BIOS and has to be manually entered through the DMI Configuration Utility and updated into the MIFD. This DMI Configuration Utility provides the same reliability as PnP updating and will prevent the refreshing failures associated with updating the entire BIOS.

System Requirements

The DMI Configuration Utility (DMICFG2.EXE) must be used in real mode in order for the program to run, the base memory must be at least 180K. Memory managers like HIMEM.SYS (required by windows) must not be installed. You can boot up from a system diskette without AUTOEXEC.BAT and CONFIG.SYS files, "REM" HIMEM.SYS in the CONFIG.SYS, or press <Shift>+<F5> during bootup to bypass your AUTOEXEC.BAT and CONFIG.SYS files.

1. In Windows, copy DMICFG.EXE to your hard disk drive.
2. Restart your computer and press <Shift>+<F5> during bootup to enter safe mode command prompt.
3. Go to the directory containing DMICFG.EXE.
4. Type DMICFG and press <Enter> to run.

Appendix

Using the ASUS DMI Configuration Utility

NOTE: The following screen displays are provided as examples only and may not reflect the screen contents on your system.

Edit DMI (or delete)



Appendix
iv. DMI Utility

Use the ←→ (left-right) cursors to move the top menu items and the ↑↓ (up-down) cursor to move between the left hand menu items. The bottom of the screen will show the available keys for each screen. Press enter at the menu item to enter the right hand screen for editing. “Edit component” appears on top. The reversed color field is the current cursor position and the blue text are available for editing. The orange text shows auto-detected information and are not available for editing. The blue text “Press [ENTER] for detail” contains a second pop-up menu is available, use the + - (plus-minus) keys to change the settings. Enter to exit *and save*, ESC to exit *and not save*.

If the user has made changes, ESC will prompt you to answer Y or N. Enter Y to go back to the left-hand screen *and save*, enter N to go back to left-hand screen and *not save*. If editing has not been made, ESC will send you back to the left hand menu without any messages.

Notes

A heading, *** BIOS Auto Detect *** appears on the right for each menu item on the left side that has been auto detected by the system BIOS.

A heading, *** User Modified *** will appear on the right for menu items that have been modified by the user.



Appendix

Save MIFD



You can save the MIFD (normally only saved to flash ROM) to a file by entering the drive and path here. If you want to cancel save, you may press ESC and a message “Bad File Name” appears here to show it was not saved.

Load MIFD



You can load the disk file to memory by entering a drive and path and file name here.

Load BIOS Defaults



You can load the BIOS defaults from a MIFD file and can clear all user modified and added data. You must reboot your computer in order for the defaults to be saved back into the Flash BIOS.

Appendix

v. ASUS PCI-L101 Fast Ethernet Card

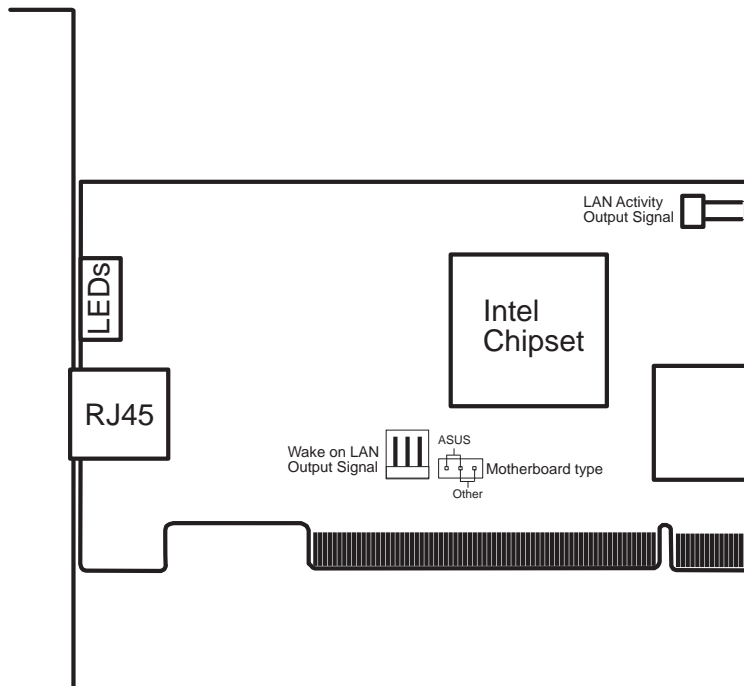
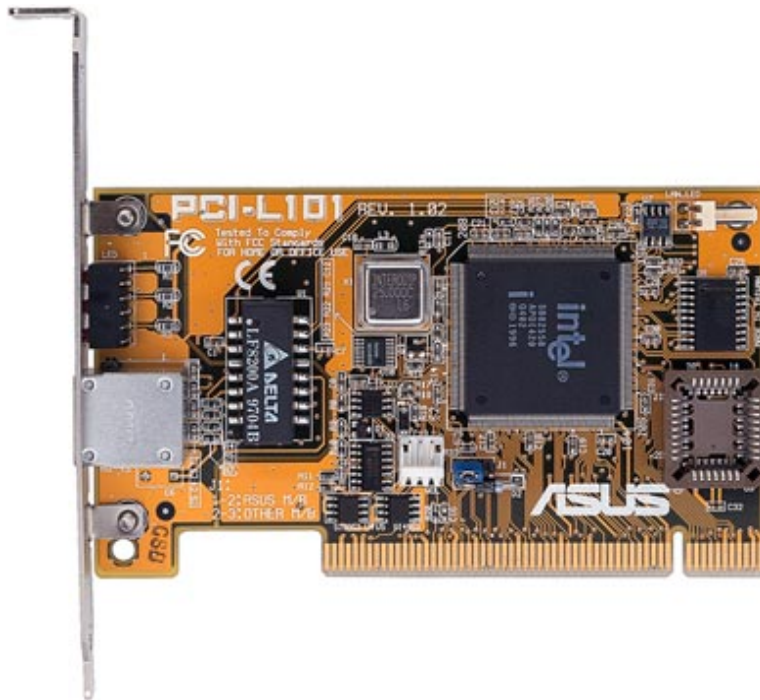

If you are using the ASUS PCI-L101 on an ASUS motherboard, leave the jumper on its default setting of “ASUS.” If you are using another brand of motherboard, set the jumper to “Other.” Connect the Wake on LAN (WOL) output signal to the motherboard’s WOL_CON in order to utilize the wake on LAN feature of the motherboard. Connect the LAN activity output signal (LAN_LED) to the system cabinet’s front panel LAN_LED in order to display the LAN data activity.

Appendix

Features

- Intel 82558 Ethernet LAN Controller (Fully integrated 10BASE-T/100BASE-TX)
- Wake-On-LAN Remote Control Function Supported
- PCI Bus Master Complies to PCI Local Bus Rev. 2.1 specifications
- Consists of MAC & PHY (10/100Mbps) interfaces
- Complies to IEEE 802.3 10BASE-T and IEEE 802.3u 100BASE-TX interfaces
- Fully supports 10BASE-T & 100BASE-TX operations through a single RJ45 port
- Supports 32-bit Bus Master Technology / PCI Rev. 2.1
- Enhancements on ACPI & APM
- Adheres to PCI Bus Power Management Interface Rev. 1.0, ACPI Rev. 1.0, and Device Class Power Management Rev. 1.0
- IEEE 802.3u auto-negotiation for 10Mbps/100Mbps Network Data Transfer Rates.
- Provides LED indicators for monitoring network conditions
- Plug and Play

Software Driver Support

- **NetWare ODI Drivers** - Novell Netware 3.x, 4.x, DOS, OS/2 Client
- **NDIS 2.01 Drivers** - Microsoft LAN Manager, Microsoft Windows 3.11, IBM LAN Server
- **NDIS 3.0 Drivers** - Microsoft Windows NT, Microsoft Windows 95, Microsoft Windows 3.11

Question and Answer

Q: What is Wake-On-LAN ?

A: The Wake-On-LAN feature provides the capability to remotely power on systems supporting Wake-On-LAN by simply sending a wake-up frame. With this feature, remotely uploading/downloading data to/from systems during off-peak hours will be feasible.

Q: What can Wake-On-LAN do for you ?

A: Wake-On-LAN is a remote management tool with advantages that can reduce system management workload, provide flexibility to the system administrator's job, and then of course save you time-consuming efforts and costs.

Q: What components does Wake-On-LAN require to be enable?

A: To enable Wake-On-LAN function, your system requires Ethernet LAN adapter card that can activate Wake-On-LAN function, a client with Wake-On-LAN capability, and software such as LDCM Rev. 3.10 or up that can trigger wake-up frame.

Appendix

(This page was intentionally left blank.)

Appendix

(This page was intentionally left blank.)

Appendix

(This page was intentionally left blank.)

Appendix

(This page was intentionally left blank.)