

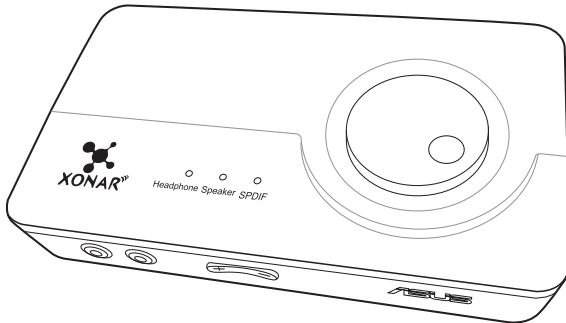

E7856  
First Edition (V1)  
November 2012

# Xonar U7

*7.1-Channel USB Audio Card*



## Quick Start Guide

## Table of content

|                        |            |
|------------------------|------------|
| <b>English</b> .....   | <b>1</b>   |
| <b>Français</b> .....  | <b>16</b>  |
| <b>Deutsch</b> .....   | <b>29</b>  |
| <b>Italiano</b> .....  | <b>42</b>  |
| <b>Português</b> ..... | <b>55</b>  |
| <b>Русский</b> .....   | <b>68</b>  |
| <b>Español</b> .....   | <b>81</b>  |
| <b>Türkçe</b> .....    | <b>94</b>  |
| <b>HRVATSKI</b> .....  | <b>107</b> |

# 1. Introduction

## 1.1 Package contents

Check your ASUS Xonar™ U7 audio card package for the following items:

- ASUS Xonar™ U7 7.1-Channel USB Audio Card
- Driver CD
- S/PDIF TOSLINK optical adapter x 1
- Quick Start Guide

## 1.2 System requirements

To ensure a successful installation of the Xonar U7 audio card, ensure that your computer must meet the following requirements:

- IBM compatible PC with one USB1.1 (or higher) compatible port for the USB audio device
- Microsoft® Windows® XP (32/64bit) / Windows® 7 (32/64bit) / Windows® 8 (32/64bit)
- Intel® Pentium® 4 1.4GHz, AMD Athlon 1400 CPU, or faster CPU
- More than 256 MB system memory
- More than 60 MB available storage space for driver installation
- CD-ROM drive (or DVD-ROM drive) for software installation
- High-quality headphones, powered analog speakers, or a Dolby Digital decoder, to enjoy the audio card's high fidelity sound

## 2. Hardware

### Xonar U7 Audio Card

#### Top view

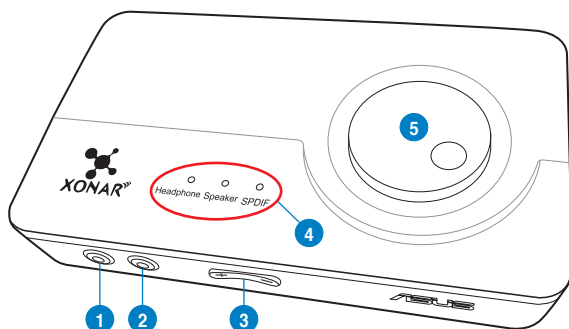

#### Rear view

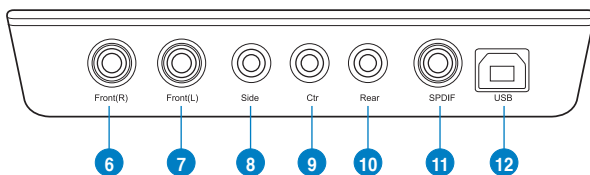

#### Bottom view

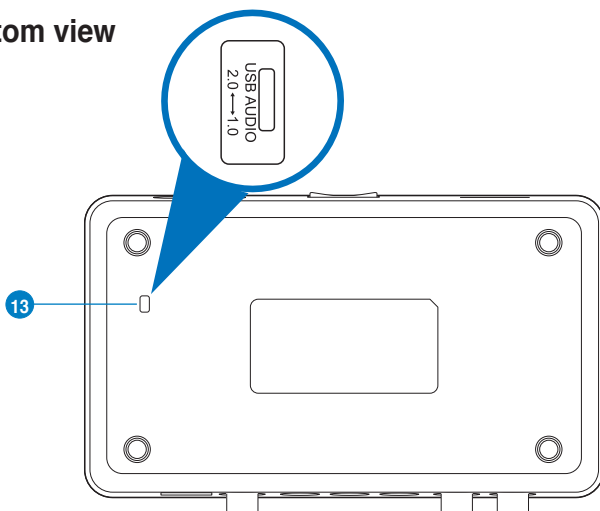

| No | Item                             | Description  |
|----|----------------------------------|--|
| 1  | Headphone Out port               | Connect your headphone to this port.   |
| 2  | Microphone In port               | Connect your external PC microphone to this 3.5mm port for voice input. Built-in high-quality Microphone pre-amplifier.  |
|    | Line In port                     | Connect analog devices like MP3 players, CD players, music synthesizers, and other line-level sound sources to this 3.5mm port for audio recording or processing.  |
| 3  | Microphone Volume Control        | Press to increase or decrease microphone volume.   |
| 4  | Output Selection Indicator       | LED indicator indicates different output selection (Headphone/Speaker/S/PDIF).   |
| 5  | Output Selection/ Volume Control | Rotate to adjust the playback volume. Press to select an output source.  |
| 6  | Front (R) Out port               | For 2/4/5.1/7.1 channel speaker systems, connects to the front right input on the powered speakers.  |
| 7  | Front (L) Out port               | For 2/4/5.1/7.1 channel speaker systems, connects to the front left input on the powered speakers.   |
| 8  | Side Surround Out port           | Connects to the surround channel input on 7.1 powered analog speakers.   |
| 9  | Center/Subwoofer Out port        | Connects to the center/subwoofer input on 5.1/7.1 powered analog speakers.   |
| 10 | Rear Out port                    | Connects to the back surround input on 4/5.1/7.1 powered analog speakers.  |
| 11 | S/PDIF Out port                  | Coaxial digital output port. Connects to an external digital decoder or digital speaker systems, Home Theater systems, AV receivers for outputting digital audio including PCM, Dolby Digital, DTS, WMA-Pro, etc. Connects to the surround channel input on 4/5.1/7.1 powered analog speakers. |
| 12 | USB Port                         | Connects to your computer using a USB Type B-A lead.   |
| 13 | USB Audio 1.0/2.0 switch         | Move this switch to toggle between USB Audio 2.0 and USB Audio 1.0 connection. Use USB Audio 1.0 for plug and play. Use USB Audio 2.0 on a mac (Apple computer).   |



USB Audio 1.0/2.0 switch is located at the bottom side of the audio card. USB Audio 1.0 connection has the following limitations:

- Only supports playback features.
- 7.1 speakers, Headphone, Mic In / Line-In, and SPDIF Out can only support sample rates of 44.1KHz/48KHz @ 16-bit.

## 3. Driver Installation

### 3.1 Installing the Xonar U7 Card Driver

After installing the Xonar U7 audio card on your computer, you need to install the device driver that enables the Xonar U7 audio card to work with Windows operating system.



---

The version and content of the support CD are subject to change without notice.

---

To install the device driver:

1. Insert the ASUS Xonar U7 support CD into your optical drive. If Autorun is enabled, the ASUS Xonar Card Driver screen appears automatically. Go to step 4. If Autorun is not enabled in your computer, perform step 2.
2. Click **Computer** on your desktop and double-click the optical drive icon.
3. Double-click **setup.exe** located on the optical drive.
4. Follow the on-screen instructions to complete the installation. Read, understand, and accept the **END USER LICENSE AGREEMENT** before continuing the installation.
5. When the installation finishes, you may be prompted to restart your computer. You can choose to restart the computer at a later time.

### 3.2 Uninstalling or Reinstalling the Xonar U7 Card Driver

#### 3.2.1 Uninstalling the Xonar U7 Card Driver

To uninstall the Xonar U7 card driver:

1. Click **Start > Control Panel > Programs and Features**.
2. Right-click the driver you want to remove, and then click **Uninstall**.
3. In the **InstallShield Wizard** dialog box, select **Remove**.
4. Restart your computer when prompted.

#### 3.2.2 Reinstalling the Xonar U7 Card Driver

To reinstall the Xonar U7 card driver:

1. Uninstall the existing software or driver.
2. Follow the installation process to reinstall the driver.

## 4. Connecting Speakers and Peripherals

### 4.1 Input connection

#### 4.1.1 Connecting to a USB 2.0 port on your computer

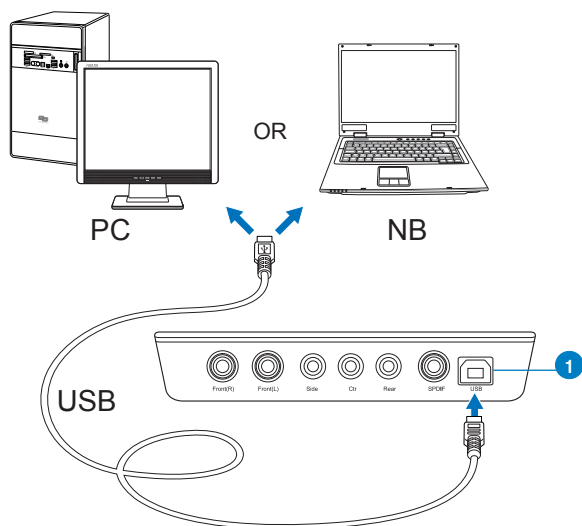

| No | Item     | Description  |
|----|----------|--|
| 1  | USB Port | Connects to your computer using a USB Type B-A lead. |

## 4.1.2 Connecting digital audio systems

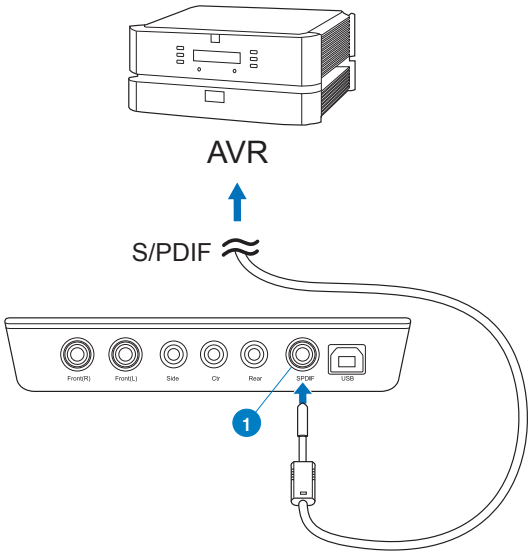

| No | Item            | Description   |
|----|-----------------|---|
| 1  | S/PDIF Out port | Connect an AVR (Audio/Video Receiver) to this S/PDIF output port. |



### 4.1.3 Connecting microphone / Line-In

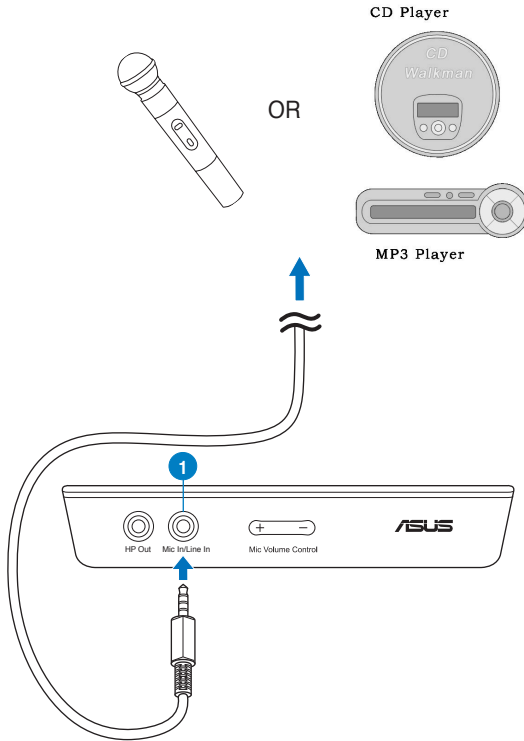

| No | Item                                | Description  |
|----|-------------------------------------|--|
| 1  | <b>Microphone In / Line In port</b> | <p>Connect the microphone's 3.5mm plug into this Mic-In port for voice communication, recording, or karaoke.</p> <p>Connect the 3.5mm plug of the CD/MP3 Player or any other Line level analog audio sources into this Line-In port for sound recording.</p> |

## 4.2 Output connection

### 4.2.1 Connecting Stereo Headphones

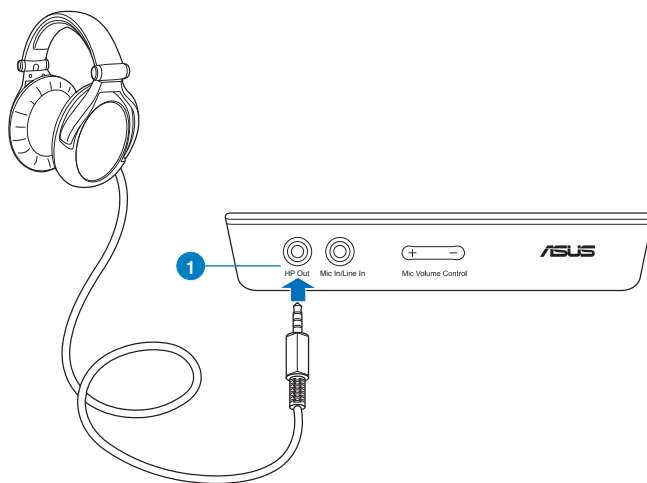

| No | Item               | Description   |
|----|--------------------|---|
| 1  | Headphone Out Port | The Headphone Out port has a built-in high-quality amplifier to drive headphones. Connect your stereo headphones directly to this port. |

## 4.2.2 Connecting 5.1 channel headphones

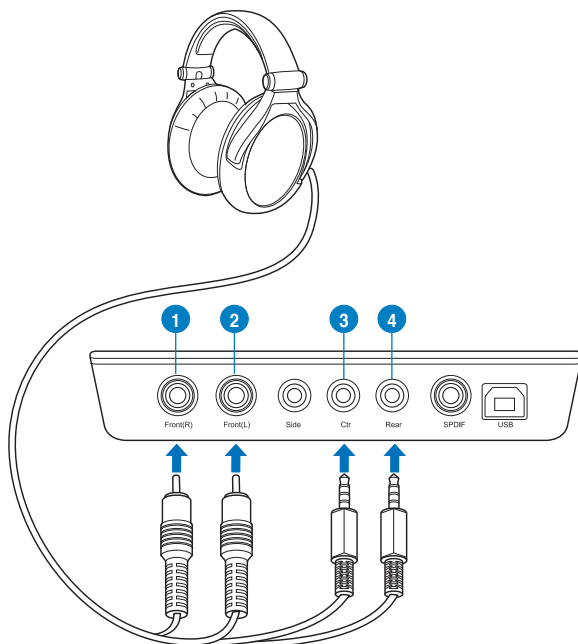

| No | Item                      | Description  |
|----|---------------------------|--|
| 1  | Front (R) Out port        | Connects to the front right input port of 5.1 channel headphones using the RCA cable.    |
| 2  | Front (L) Out port        | Connects to the front left input port of 5.1 channel headphones using the RCA cable.     |
| 3  | Center/Subwoofer Out port | Connect the Center/Bass-channel 3.5mm plug of your 5.1 channel headphone into this jack. |
| 4  | Rear Surround Out port    | Connects to the rear surround input port of your 5.1 channel headphone.                  |

## 4.2.3 Connecting analog speaker systems

### Connecting 2 channel speakers

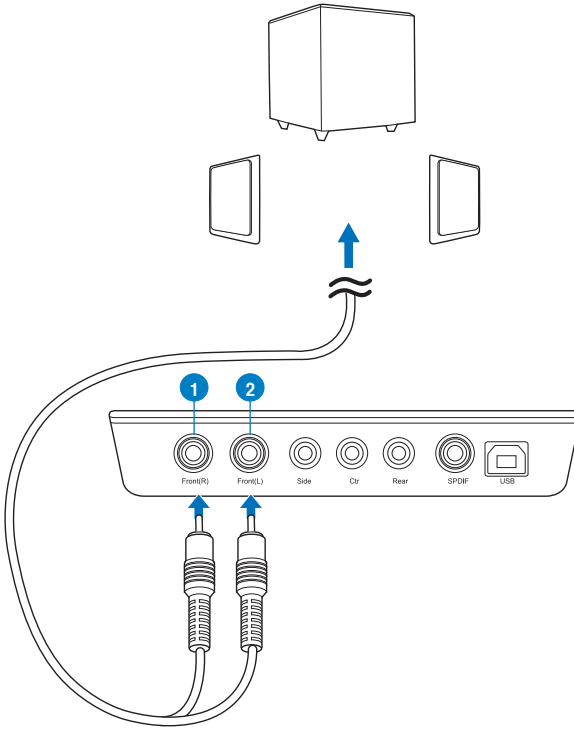

| No | Item               | Description   |
|----|--------------------|---|
| 1  | Front (R) Out port | Connects to the front right input port of 2 channel speakers using the RCA cable. |
| 2  | Front (L) Out port | Connects to the front left input port of 2 channel speakers using the RCA cable.  |

## Connecting 4.1 channel speakers / power amplifier

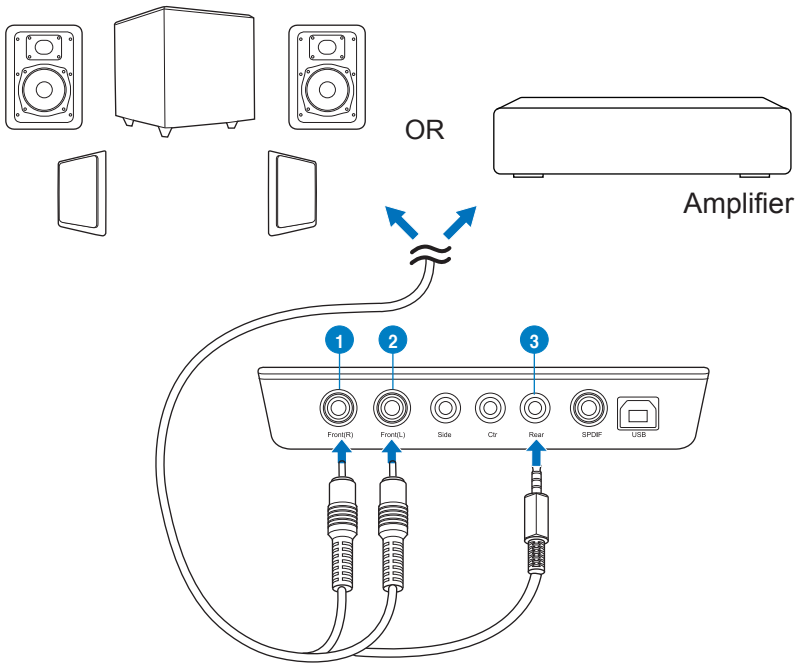

| No | Item                   | Description   |
|----|------------------------|---|
| 1  | Front (R) Out port     | Connects to the front right input port of 4.1 channel speakers.   |
| 2  | Front (L) Out port     | Connects to the front left input port of 4.1 channel speakers.    |
| 3  | Rear Surround Out port | Connects to the rear surround input port of 4.1 channel speakers. |

## Connecting 5.1 channel speakers

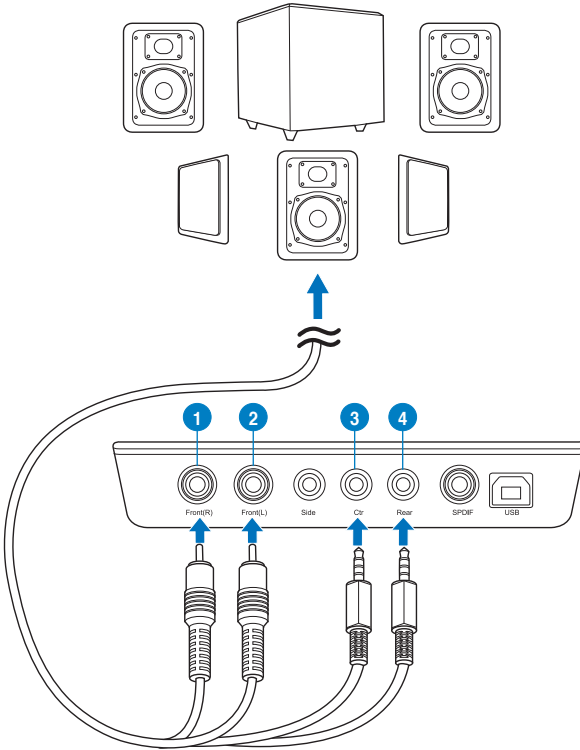

| No | Item                      | Description   |
|----|---------------------------|---|
| 1  | Front (R) Out port        | Connects to the front right input port of 5.1 channel speakers.           |
| 2  | Front (L) Out port        | Connects to the front left input port of 5.1 channel speakers.            |
| 3  | Center/Subwoofer Out port | Connects to the Center and Subwoofer input ports of 5.1 channel speakers. |
| 4  | Rear Surround Out port    | Connects to the rear surround input port of 5.1 channel speakers.         |

## Connecting 7.1 channel speakers

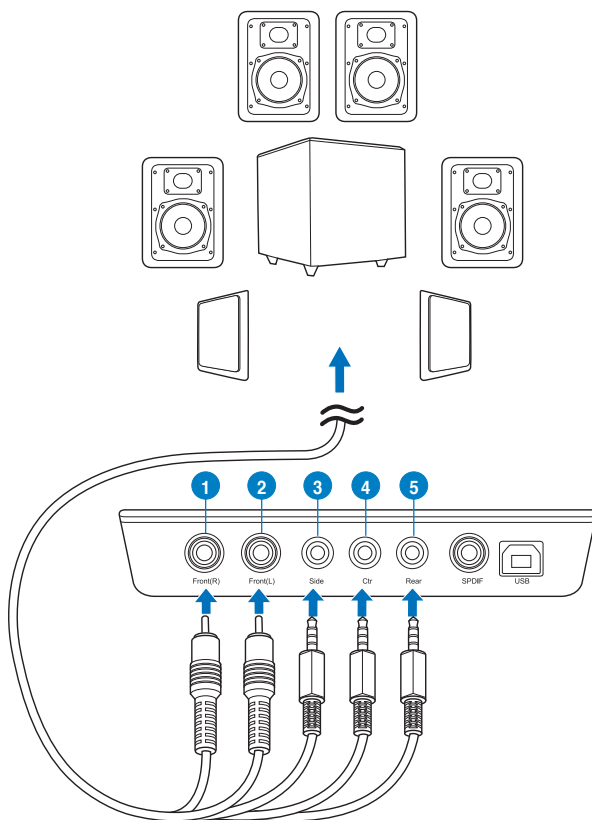

| No | Item                      | Description  |
|----|---------------------------|--|
| 1  | Front (R) Out port        | Connects to the front right input port of 7.1 channel speakers.                                |
| 2  | Front (L) Out port        | Connects to the front left input port of 7.1 channel speakers.                                 |
| 3  | Side Surround Out port    | Connects to the Left surround and Right surround input ports of 7.1 channel speakers.          |
| 4  | Center/Subwoofer Out port | Connects to the Center/Subwoofer input port of 7.1 channel speakers using the mini-jack cable. |
| 5  | Rear Surround Out port    | Connects to the rear surround input port of 7.1 channel speakers.                              |

# 1. Introduction

## 1.1 Contenu de la boîte

Vérifiez que la boîte de votre carte son ASUS Xonar U7 contient bien les éléments suivants :

- Carte son USB ASUS Xonar U7 (7.1 canaux)
- Adaptateur S/PDIF optique TOSLINK x 1
- CD de support (incluant le guide d'utilisation et le pilote) x 1
- Guide de démarrage rapide x 1

## 1.2 Pré-requis système

Avant d'installer la carte son Xonar U7, assurez-vous que votre ordinateur puisse satisfaire aux critères suivants :

- Ordinateur intégrant un port USB 2.0/1.1 (ou supérieur) disponible pour la carte son USB
- Microsoft® Windows® XP (32/64bit) / Windows® 7 (32/64bit)/ Windows® 8 (32/64bit)
- Un processeur Intel® Pentium® 4 1.4GHz ou AMD Athlon 1400 ou supérieur
- Mémoire DRAM supérieure ou égale à 256 Mo
- 60 Mo d'espace disque disponible pour l'installation du pilote audio
- Lecteur de CD-ROM (ou DVD-ROM) pour l'installation des logiciels
- Des écouteurs de haute qualité, un décodeur Dolby Digital ou un système d'enceintes analogiques alimentées pour profiter pleinement de la qualité audio offerte par la carte son



## 2. Matériel

### Carte son Xonar U7

#### Vue avant

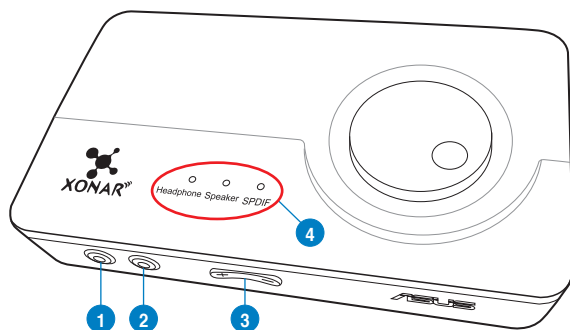

#### Vue arrière

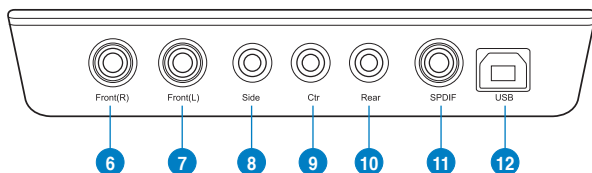

#### Vue de dessous

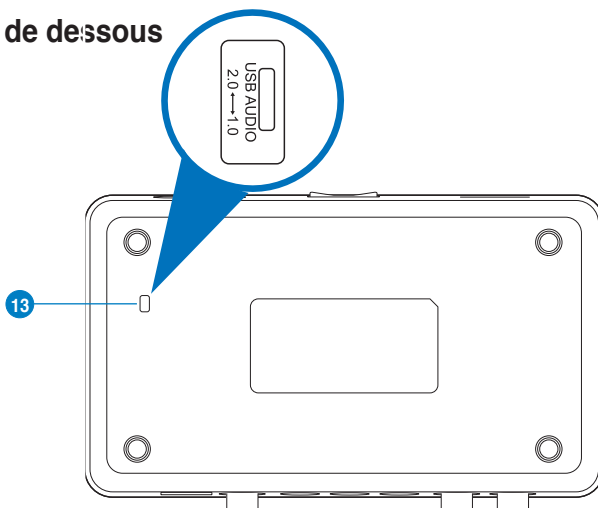

| N° | Élément                                    | Description  |
|----|--|--|
| 1  | Prise casque                               | Connectez votre casque audio sur ce port.  |
| 2  | Port d'entrée microphone                   | Connectez le port microphone externe de votre PC sur ce port 3.5mm. Intègre un préamplificateur de microphone de haute qualité.  |
|    | Port d'entrée audio                        | Connectez des périphériques analogiques (lecteur MP3, lecteur CD, etc) ou autres sources audio sur ce port 3.5mm.  |
| 3  | Contrôle de volume du microphone           | Permet d'ajuster le volume du microphone.  |
| 4  | Indicateur de sélection de sortie          | Permet d'indiquer le type de sortie audio utilisé (casque/enceintes/S/PDIF).   |
| 5  | Sélection de sortie/<br>Contrôle de volume | Tournez pour ajuster le volume. Appuyez pour sélectionner la source de sortie audio.   |
| 6  | Sortie audio avant (D)                     | Pour les haut-parleurs 2.0/4.0/5.1/7.1, se connecte aux prises audio du haut-parleur avant droit.  |
| 7  | Sortie audio avant (G)                     | Pour les haut-parleurs 2.0/4.0/5.1/7.1, se connecte aux prises audio du haut-parleur avant gauche.   |
| 8  | Sortie surround latérale                   | Connectez la prise de votre casque 7.1 dédiée au son surround latéral à ce port.   |
| 9  | Sortie centrale/<br>caisson de basses      | Connectez la prise de votre casque 5.1/7.1 dédiée au son surround latéral / caisson de basses à ce port.   |
| 10 | Port de sortie arrière                     | Se connecte au port d'entrée Surround arrière des systèmes de haut-parleurs analogiques alimentés 4/5.1/7.1  |
| 11 | Sortie S/PDIF                              | Port de sortie numérique. Se connecte à un décodeur numérique externe, un home cinéma, un système de haut-parleurs numériques ou un récepteur pour la transmission d'un signal audio numérique supportant les technologies PCM, Dolby Digital, DTS, WMA-Pro, etc. Se connecte au port d'entrée Surround des systèmes de haut-parleurs analogiques alimentés 4/5.1/7.1. |
| 12 | Port USB                                   | Connexion à un ordinateur doté d'un port USB B-A.  |
| 13 | Interrupteur USB Audio 1.0/2.0             | Sélection de connexion USB Audio 2.0 ou USB Audio 1.0. L'USB Audio 1.0 est dédié au Plug'n'Play et l'USB Audio 2.0 pour les ordinateurs MAC (Apple).   |



L'interrupteur USB Audio 1.0/2.0 est localisé sous la carte son. L'USB Audio 1.0 possède les limitations suivantes :

- Ne prend en charge que les fonctions de lecture.
- Les enceintes 7.1, les casques, l'entrée micro/audio et la sortie SPDIF ne sont compatibles qu'avec le taux d'échantillonnage 44.1KHz/48KHz @16-bits.

## 3. Installation du pilote de la carte son

### 3.1 Installer le pilote de la carte Xonar U7

Une fois la carte son USB Xonar U7 installée sur votre ordinateur, vous devrez installer le pilote permettant à la carte son de fonctionner sous un système d'exploitation Windows.



---

La version et le contenu du CD de support peuvent changer sans avertissement préalable.

---

Pour installer le pilote audio de la carte son :

1. Insérez le CD de support dans votre lecteur optique. Si l'Exécution automatique est activée, le processus de configuration démarre automatiquement. Si ce n'est pas le cas, passez à l'étape 2 sur le fichier **setup.exe** contenu dans le CD de support.
2. Cliquez sur **Ordinateur** et double-cliquez sur l'icône de votre lecteur optique.
3. localisez et double-cliquez sur le fichier **setup.exe**.
4. Suivez les instructions à l'écran pour terminer l'installation. Lisez et acceptez le **CONTRAT DE LICENCE DE L'UTILISATEUR FINAL** avant de continuer.
5. Redémarrez votre ordinateur.

### 3.2 Désinstaller ou réinstaller le pilote

#### 3.2.1 Désinstaller le pilote

Pour désinstaller le pilote de la carte son U7 :

1. Dans le Bureau de Windows®, cliquez sur **Démarrer > Panneau de configuration > Programmes et fonctionnalités**.
2. Faites un clic droit sur le pilote à supprimer, puis cliquez **Supprimer**.
3. À l'apparition de l'assistant d'installation, sélectionnez l'option **Remove** (Supprimer).
4. Redémarrez votre ordinateur.

#### 3.2.2 Réinstaller le pilote

Pour réinstaller le pilote de la carte son :

1. Désinstallez le pilote et le logiciel audio précédent de l'ordinateur.
2. Suivez les instructions à l'écran pour terminer.

## 4. Connexion de haut-parleurs et de périphériques

### 4.1 Connexion d'entrée

#### 4.1.1 Connecter la carte son au port USB d'un ordinateur

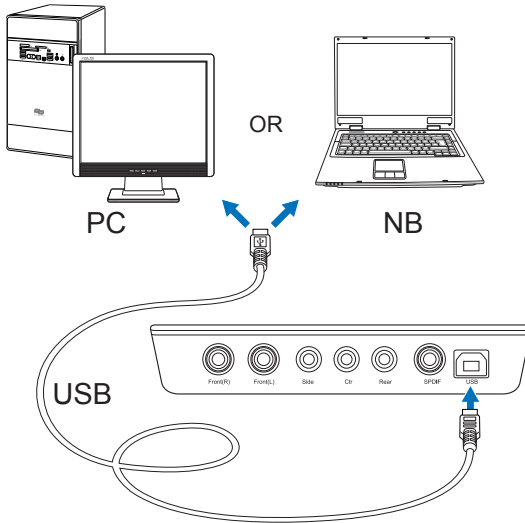

| N° | Élément  | Description                                       |
|----|----------|---|
| 1  | Port USB | Connexion à un ordinateur doté d'un port USB B-A. |

## 4.1.2 Connecter un système audio numérique

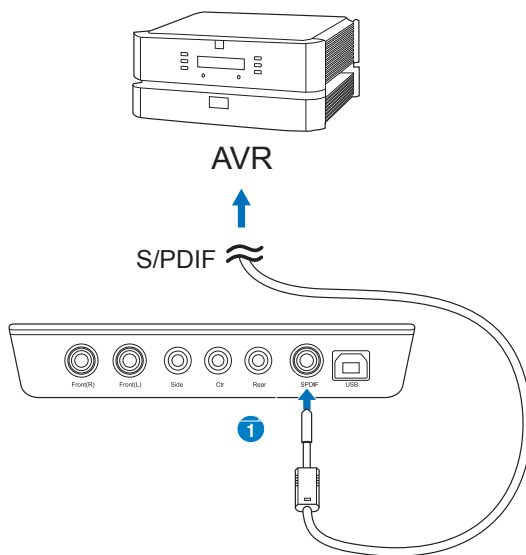

| N° | Élément               | Description  |
|----|-----------------------|--|
| 1  | Port de sortie S/PDIF | Connectez un récepteur audio/vidéo sur cette interface de sortie S/PDIF. |

### 4.1.3 Connecter un microphone ou une source audio externe

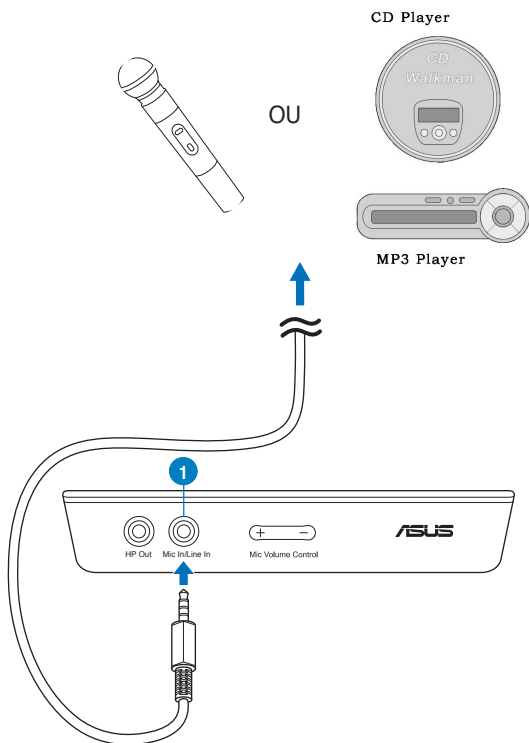

| N° | Élément  | Description   |
|----|--|---|
| 1  | Port d'entrée microphone / Port d'entrée audio | <p>Reliez le microphone à cette prise 3.5mm pour les enregistrements audio ou les communications vocales.</p> <p>Connectez la prise 3.5mm d'un lecteur CD/MP3 ou de toute autre source audio sur ce port.</p> |

## 4.2 Connexion de sortie

### 4.2.1 Connecter un casque stéréo

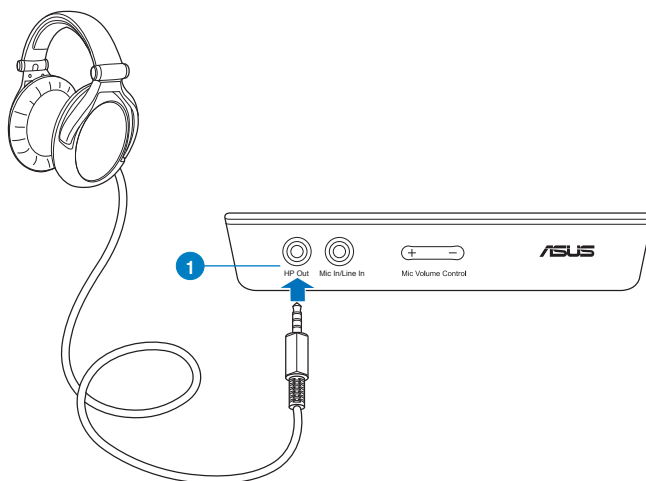

| N° | Élément              | Description   |
|----|----------------------|---|
| 1  | Port casque (sortie) | Cette prise est dotée d'un amplificateur de haute qualité dédié aux casques audio. Branchez directement votre casque sur ce port. |

## 4.2.2 Connecter un casque 5.1

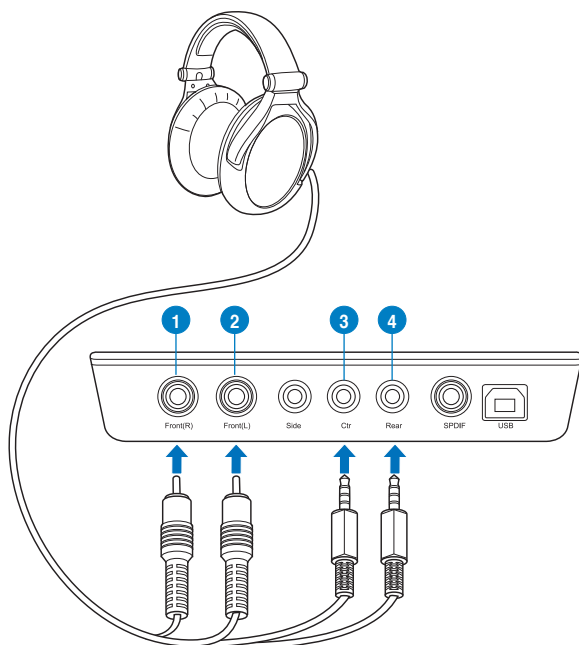

| N° | Élément                            | Description   |
|----|------------------------------------|---|
| 1  | Sortie audio avant (D)             | Se connecte aux prises audio du haut-parleur avant droit.   |
| 2  | Sortie audio avant (G)             | Se connecte aux prises audio du haut-parleur avant gauche.  |
| 3  | Sortie centrale/ caisson de basses | Se connecte aux prises audio de l'amplificateur dédiées au haut-parleur central et au caisson de basses via un câble audio RCA. |
| 4  | Sortie surround arrière            | Connectez la prise de votre casque 5.1 dédiée au son surround arrière à ce port.  |



### 4.2.3 Connecter un système d'enceintes analogiques

#### Système à 2 enceintes

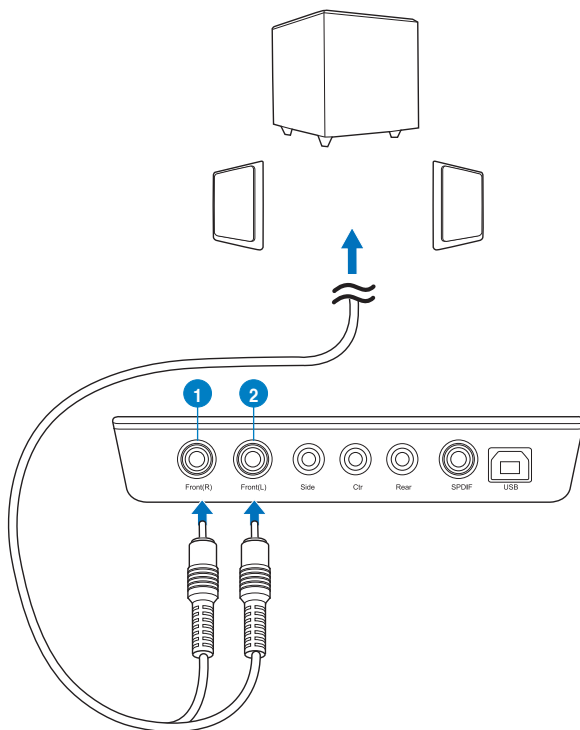

| N° | Élément                | Description  |
|----|------------------------|--|
| 1  | Sortie audio avant (D) | Se connecte aux prises audio du haut-parleur avant droit.  |
| 2  | Sortie audio avant (G) | Se connecte aux prises audio du haut-parleur avant gauche. |

## Connexion à un système d'enceintes / amplificateur audio

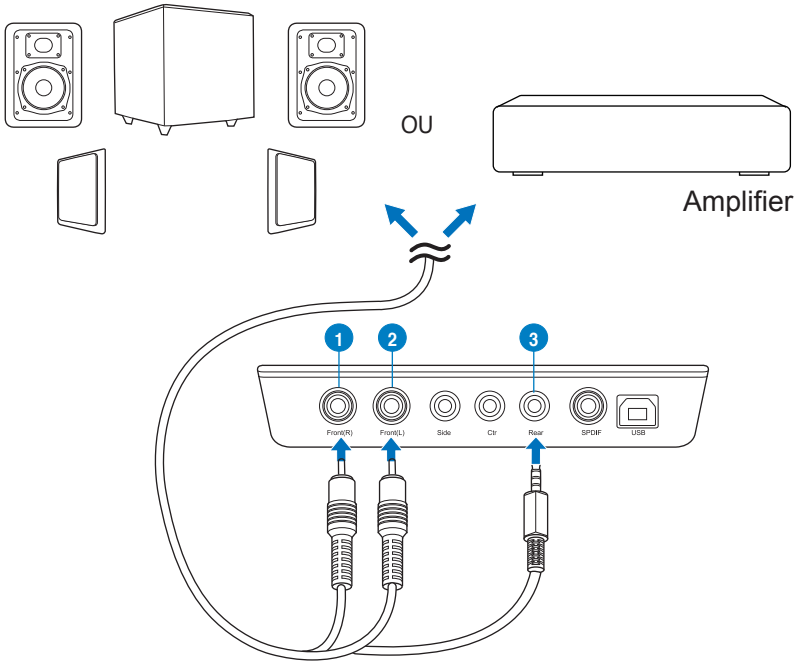

| N° | Élément                 | Description  |
|----|-------------------------|--|
| 1  | Sortie audio avant (D)  | Se connecte aux prises audio du haut-parleur avant droit.                        |
| 2  | Sortie audio avant (G)  | Se connecte aux prises audio du haut-parleur avant gauche.                       |
| 3  | Sortie surround arrière | Connectez la prise de votre casque 5.1 dédiée au son surround arrière à ce port. |

## Connexion à un système d'enceintes 5.1

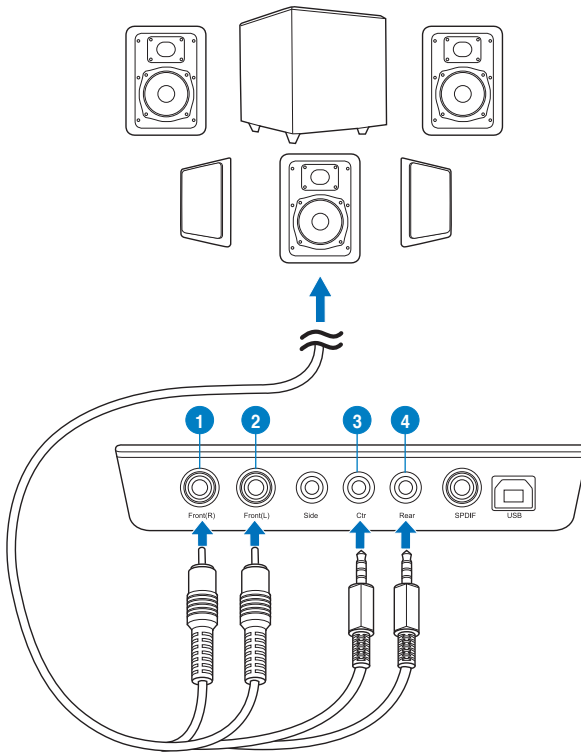

| N° | Élément                            | Description   |
|----|------------------------------------|---|
| 1  | Sortie audio avant (D)             | Se connecte aux prises audio du haut-parleur avant droit.   |
| 2  | Sortie audio avant (G)             | Se connecte aux prises audio du haut-parleur avant gauche.  |
| 3  | Sortie centrale/ caisson de basses | Se connecte aux prises audio de l'amplificateur dédiées au haut-parleur central et au caisson de basses via un câble audio RCA. |
| 4  | Sortie surround arrière            | Connectez la prise dédiée au son surround arrière à ce port.  |

## Connexion à un système d'enceintes 7.1

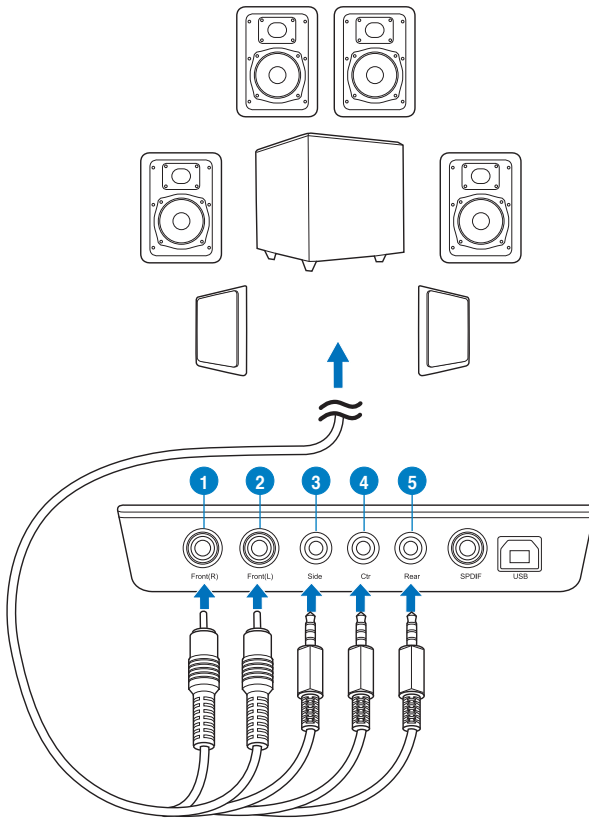

| N° | Élément                            | Description   |
|----|------------------------------------|---|
| 1  | Sortie audio avant (D)             | Se connecte aux prises audio du haut-parleur avant droit.   |
| 2  | Sortie audio avant (G)             | Se connecte aux prises audio du haut-parleur avant gauche.  |
| 3  | Sortie surround latérale           | Connectez la prise de votre casque 7.1 dédiée au son surround latéral à ce port.  |
| 4  | Sortie centrale/ caisson de basses | Se connecte aux prises audio de l'amplificateur dédiées au haut-parleur central et au caisson de basses via un câble audio RCA. |
| 5  | Sortie surround arrière            | Connectez la prise dédiée au son surround arrière à ce port.  |

# 1. Einführung

## 1.1 Verpackungsinhalt

Überprüfen Sie Ihre ASUS Xonar™ U7-Audio-Kartenverpackung auf folgenden Inhalt:

- ASUS Xonar™ U7 – 7.1-Kanal-USB-Soundkarte
- Treiber-CD
- 1x optischer S/PDIF-TOSLINK-Adapter
- Schnellstartanleitung

## 1.2 Systemanforderungen

Um eine erfolgreiche Installation der Xonar U7-Audiokarte sicherzustellen, muss Ihr Computer folgende Anforderungen erfüllen:

- IBM kompatibler PC mit einem USB1.1 (oder höher) -kompatiblen Anschluß für das USB-Audiogerät
- Microsoft® Windows® XP (32/64bit) / Windows® 7 (32/64bit)/ Windows® 8 (32/64bit)
- Intel® Pentium® 4 1.4GHz oder AMD Athlon 1400 CPU oder schneller
- 256 MB (oder mehr) Systemspeicher
- 60 MB freier Festplattenspeicher für die Treiberinstallation
- CD-ROM-Laufwerk (oder DVD-ROM-Laufwerk) für die Software-Installation
- Hochwertige Kopfhörer, aktive Analoglautsprecher oder ein Dolby Digital-Decoder, um den HiFi-Sound der Karte zu genießen

## 2. Hardware

### Xonar U7-Soundkarte

#### Ansicht von oben

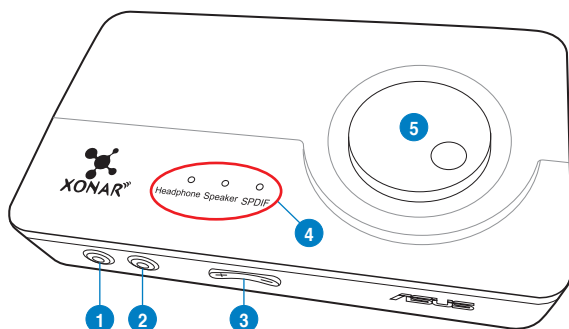

#### Ansicht von hinten

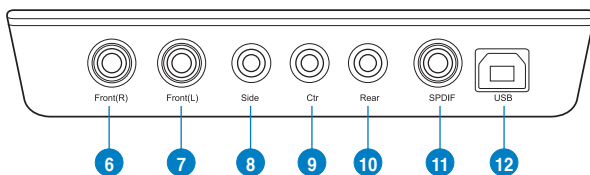

#### Ansicht von unten

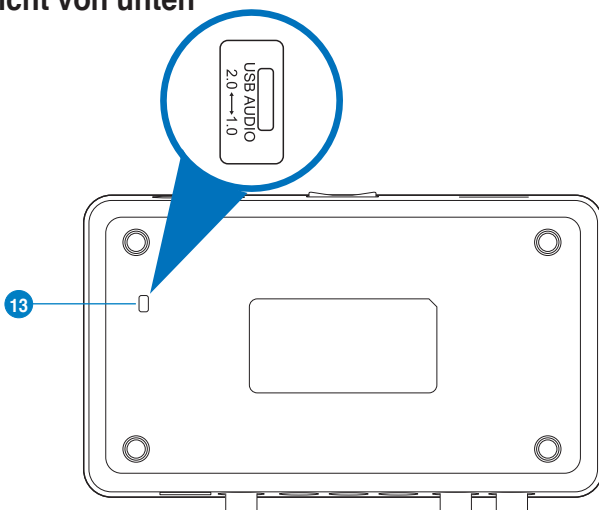

| Nr. | Element                           | Beschreibung  |
|-----|-----------------------------------|---|
| 1   | Kopfhörerausgang                  | Verbinden Sie Ihren Kopfhörer mit diesem 3,5mm-Anschluss.   |
| 2   | Mikrofoneingang                   | Schließen Sie Ihr externes PC-Mikrofon zur Spracheingabe an diesem Anschluss an. Eingebauter Mikrofonvorverstärker.   |
|     | Line In-Port                      | Anschluss für analoge Geräte, z.B. MP3-Player, CD-Player, Musiksynthesizer und andere Line-Tonwiedergabegeräte, um Tonaufnahmen oder Tonberechnung durchzuführen. (Über Ultra HiFi 118dB SNR A-D-Konverter) |
| 3   | Mikrofonlautstärkeregler          | Zum Erhöhen oder Verringern der Mikrofonlautstärke drücken.   |
| 4   | Ausgangsauswahlanzeige            | LED-Anzeige; zeigt verschiedene Ausgangsauswahlen (Kopfhörer, Lautsprecher, S/PDIF).  |
| 5   | Ausgangsauswahl-/Lautstärkeregler | Zum Anpassen der Wiedergabelautstärke drehen. Zur Auswahl einer Ausgangsquelle drücken.   |
| 6   | Frontausgang(R)                   | Bei 2/4/5.1/7.1-Kanalsystemen verbinden Sie diesen Ausgang mit den rechten Frontlautsprecheranschluss der aktiven Lautsprechers.  |
| 7   | Frontausgang(L)                   | Bei 2/4/5.1/7.1-Kanalsystemen verbinden Sie diesen Ausgang mit den linken Frontlautsprecheranschluss der aktiven Lautsprechers.   |
| 8   | Seitlicher Surround-Ausgang       | Anschluss für die surround-Kanal an aktiven 7.1-Analoglautsprechern.  |
| 9   | Center/Subwoofer-Ausgang          | Anschluss für den Center/Subwoofer-Eingang an aktiven 5.1/7.1-Amaloglautsprechern.  |
| 10  | Rück-Surround-Ausgang             | Anschluss für die Eingänge an aktiven 4/5.1/7.1-Analoglautsprechern.  |
| 11  | S/PDIF-/Seiten-Ausgang            | Digitaler Ausgang. Anschluss für einen externen Digitaldekoder oder -Lautsprechersystem, Heimkinosystem, AV-Receiver zur Ausgabe von digitalen Audio, eingeschlossen PCM, DTS Digital, DTS, WMA-Pro, usw.   |
| 12  | USB-Port                          | Zum Anschließen an Ihren Computer per USB-Kabel (Typ B/A).  |
| 13  | USB Audio 1.0/2.0 switch          | Schalten zum Umschalten zwischen USB Audio 2.0- und USB Audio 1.0-Verbindung verschieben. USB Audio 1.0 bietet Plug-and-Play. USB Audio 2.0 verwenden Sie bei Mac-Computern (Apple).                        |



Der USB Audio 1.0/2.0-Schalter befindet sich an der Unterseite des Soundkarte. Die USB Audio 1.0-Verbindung hat folgende Beschränkungen:

- Unterstützt nur Wiedergabefunktionen.
- 7.1-Lautsprecher, Kopfhörer, Mikrofoneingang / Line-in und S/PDIF-Ausgang unterstützen nur Abtastraten von 44,1 kHz / 48 kHz bei 16 Bit.

## 3. Treiberinstallation

### 3.1 Xonar U7-Kartentreiber installieren

Nach dem Anschluß des externen Xonar U7 USB-Adapters an Ihren Computer müssen Sie die Gerätetreiber installieren, damit der Xonar U7 USB-Adapter unter Windows arbeiten kann.



---

Die Version und der Inhalt der Treiber-CD können ohne vorherige Ankündigung geändert werden..

---

So installieren Sie die Gerätetreiber:

1. Legen Sie die ASUS Xonar U3-Hilfs-CD in das optische Laufwerk ein.  
Wenn Autorun aktiviert ist, erscheint das Fenster für die ASUS Xonar-Treiber automatisch und Sie können mit Schritt 4 fortfahren.  
Wenn Autorun nicht aktiviert ist fahren Sie mit Schritt 2 fort.
2. Klicken Sie auf Ihrem Bildschirm auf **Computer** und doppelklicken Sie auf das Symbol Ihres optischen Laufwerks.
3. Doppelklicken Sie auf die Datei **setup.exe**.
4. Folgen Sie den Bildschirmanweisungen, um die Installation abzuschließen. Lesen Sie die **LIZENZVEREINBARUNG** und vergewissern Sie sich, dass Sie den Inhalt verstanden und akzeptiert haben, bevor Sie mit der Installation fortfahren.
5. Wenn die Installation beendet ist, müssen Sie möglicherweise Ihren Computer neu starten. Falls gewünscht können Sie auswählen, den Computer später neu zu starten.

### 3.2 Deinstallieren oder Neuinstallation der Xonar U7-Kartentreiber

#### 3.2.1 Deinstallieren der Xonar U7-Kartentreiber

So deinstallieren Sie die Xonar U7-Kartentreiber:

1. Klicken Sie auf **Start > Control Panel (Systemsteuerung) > Programs and Features (Programme und Funktionen)**.
2. Rechtsklicken Sie auf den Treiber, den Sie entfernen möchten; klicken Sie dann auf Uninstall (**Deinstallieren**)
3. Wählen Sie im Installationsassistenten die Option **Entfernen**.
4. Starten Sie Ihren Computer neu, wenn Sie dazu aufgefordert werden.

#### 3.2.2 Neuinstallation der Xonar U7-Kartentreiber

So installieren Sie die Xonar U7-Kartentreiber neu:

1. Deinstallieren Sie die/den vorhandene(n) Software/Treiber.
2. Befolgen Sie die Installationsschritte zur Neuinstallation des Treibers.



## 4. Anschluß der Lautsprecher und Peripheriegeräte

### 4.1 Eingangsverbindung

#### 4.1.1 4.1.1 An einen USB 2.0-Port Ihres Computers anschließen

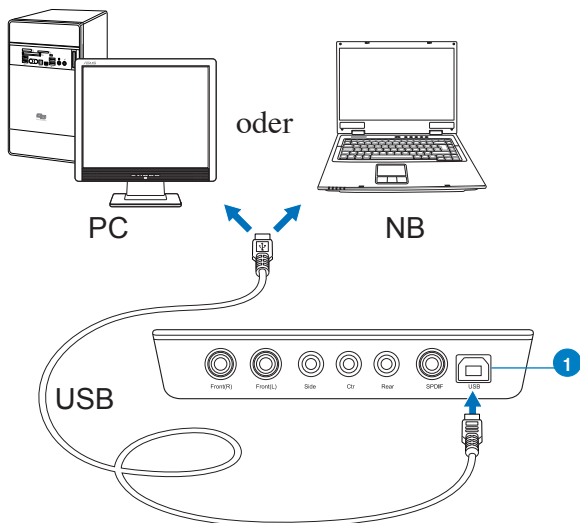

| Nr. | Element                  | Beschreibung   |
|-----|--------------------------|--|
| 1   | USB Audio 1.0/2.0 switch | Schalten zum Umschalten zwischen USB Audio 2.0- und USB Audio 1.0-Verbindung verschieben. USB Audio 1.0 bietet Plug-and-Play. USB Audio 2.0 verwenden Sie bei Mac-Computern (Apple). |

## 4.1.2 Digitale Audiosysteme anschließen

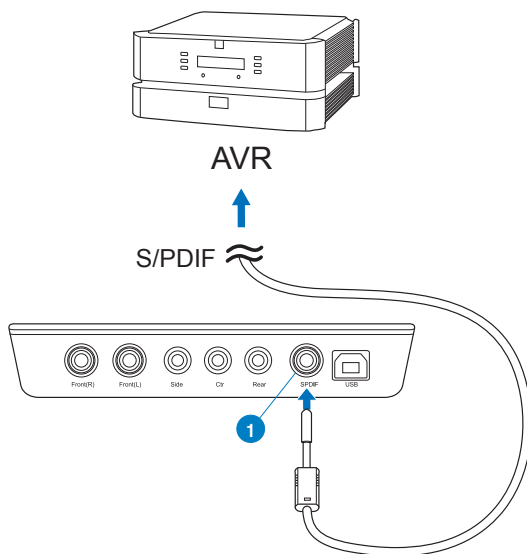

| Nr. | Element                | Beschreibung  |
|-----|------------------------|---|
| 1   | S/PDIF-/Seiten-Ausgang | Schließen Sie an diesem S/PDIF-Ausgang einen AVR (Audio-Video-Receiver) an. |

### 4.1.3 Mikrofon / Line-in anschließen

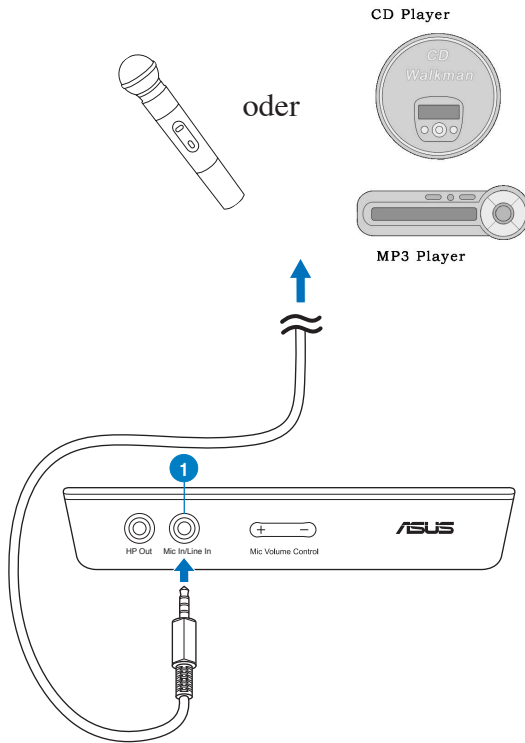

| Nr. | Element                        | Beschreibung  |
|-----|--------------------------------|---|
| 1   | Mikrofoneingang / Line-in-Port | <p>Schließen Sie den 3,5-mm-Stecker (Klinke) des Mikrofons zur Sprachkommunikation, Aufnahme oder für Karaokeanwendungen am Mikrofoneingang an.</p> <p>Schließen Sie den 3,5-mm-Stecker (Klinke) des CD/MP3-Players oder einer anderen analogen Line-Audioquelle zur Tonaufnahme am Line-in-Anschluss an.</p> |

## 4.2 Ausgangsverbindung

### 4.2.1 Stereo-Kopfhörer anschließen

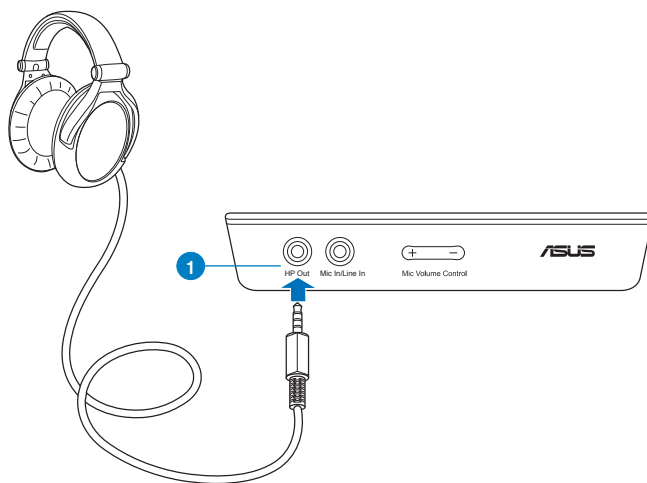

| Nr. | Element          | Beschreibung  |
|-----|------------------|---|
| 1   | Kopfhörerausgang | Der Kopfhörerausgang hat einen integrierten hochwertigen Verstärker zur Verbesserung der Ausgabe per Kopfhörer. Schließen Sie Ihre Stereo-Kopfhörer direkt an diesem Port an. |

## 4.2.2 5.1-Kanal-Kopfhörer anschließen

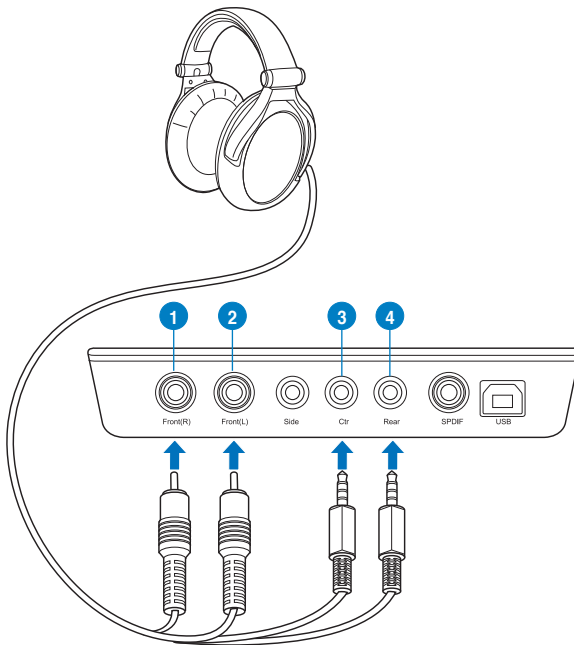

| Nr. | Element                          | Beschreibung  |
|-----|----------------------------------|---|
| 1   | Frontausgang(R)                  | Hier schließen Sie den vorderen rechten Eingang von 5.1-Kanal-Kopfhörern per Cinch-Kabel an.          |
| 2   | Frontausgang(L)                  | Hier schließen Sie den vorderen linken Eingang von 5.1-Kanal-Kopfhörern per Cinch-Kabel an.           |
| 3   | Center/<br>Subwoofer-<br>Ausgang | Verbinden Sie den 3,5-mm-Stecker (Mittel/Bass-Kanal) Ihres 5.1-Kanal-Kopfhörers mit diesem Anschluss. |
| 4   | Hinterer<br>Surround-<br>Ausgang | Schließen Sie hier den hinteren Surround-Eingang Ihres 5.1-Kanal-Kopfhörers an.                       |

## 4.2.3 Analoge Lautsprechersysteme anschließen

### 2-Kanal-Lautsprecher anschließen

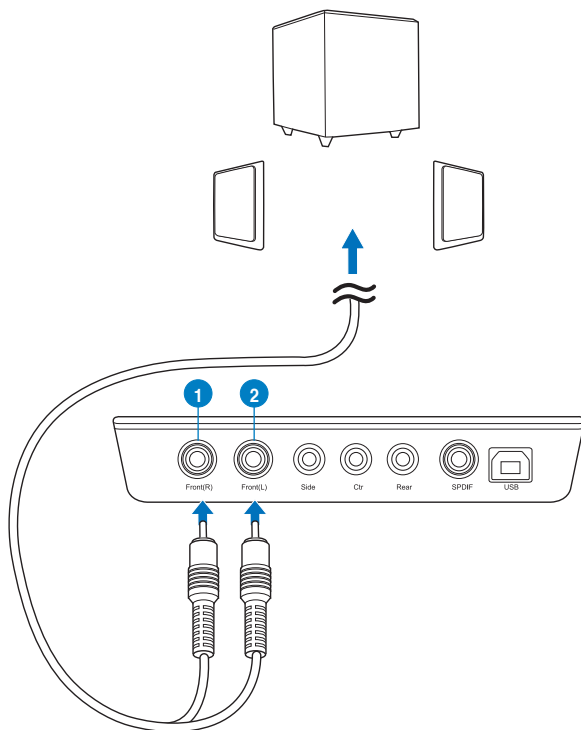

| Nr. | Element         | Beschreibung  |
|-----|-----------------|---|
| 1   | Frontausgang(R) | Bei 2-Kanalsystemen verbinden Sie diesen Ausgang mit den rechten Frontlautsprecheranschluss per Cinch-Kabel an. |
| 2   | Frontausgang(L) | Bei 2-Kanalsystemen verbinden Sie diesen Ausgang mit den linken Frontlautsprecheranschluss per Cinch-Kabel an.  |

#### 4.1-Kanal-Lautsprecher / Leistungsverstärker anschließen

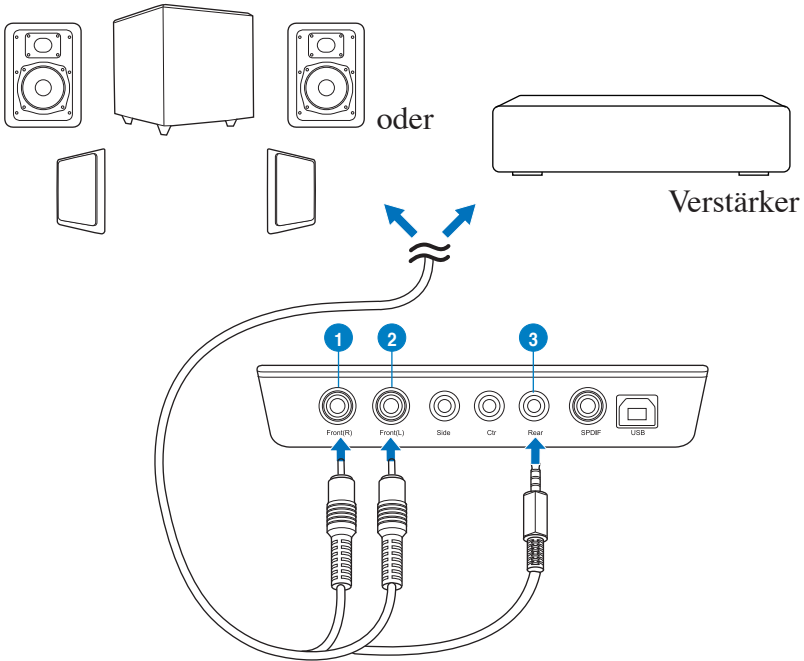

| Nr. | Element                   | Beschreibung  |
|-----|---------------------------|---|
| 1   | Frontausgang(R)           | Hier schließen Sie den vorderen rechten Eingang der 4.1-Kanal-Lautsprecher an.  |
| 2   | Frontausgang(L)           | Hier schließen Sie den vorderen linken Eingang der 4.1-Kanal-Lautsprecher an.   |
| 3   | Hinterer Surround-Ausgang | Hier schließen Sie den hinteren Surround-Eingang der 4.1-Kanal-Lautsprecher an. |

## 5.1-Kanal-Lautsprecher

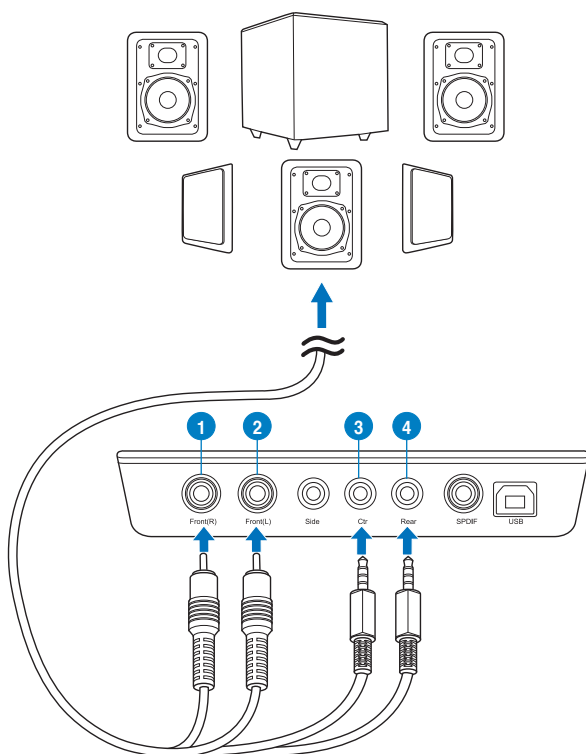

| Nr. | Element                          | Beschreibung   |
|-----|----------------------------------|--|
| 1   | Frontausgang(R)                  | Bei 5.1-Kanalsystemen verbinden Sie diesen Ausgang mit den rechten Frontlautsprecheranschluss der aktiven Lautsprechers. |
| 2   | Frontausgang(L)                  | Bei 5.1-Kanalsystemen verbinden Sie diesen Ausgang mit den linken Frontlautsprecheranschluss der aktiven Lautsprechers.  |
| 3   | Center/<br>Subwoofer-<br>Ausgang | Hier schließen Sie die Mittel- und Subwoofer-Eingänge der 5.1-Kanal-Lautsprecher an.                                     |
| 4   | Hinterer<br>Surround-<br>Ausgang | Schließen Sie hier den hinteren Surround-Eingang Ihres 5.1-Kanal-Kopfhörers an.  |



## 7.1-Kanal-Lautsprecher

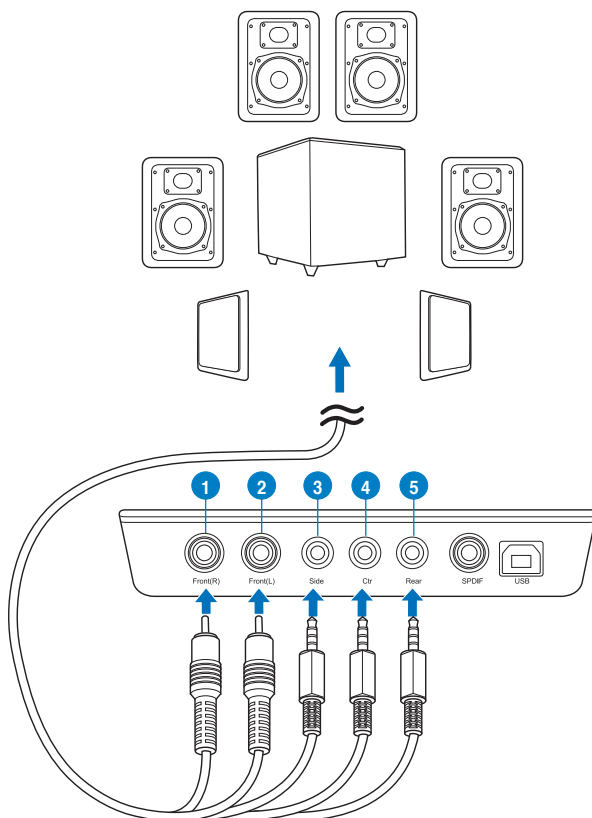

| Nr. | Element                     | Beschreibung  |
|-----|-----------------------------|---|
| 1   | Frontausgang(R)             | Bei 7.1-Kanal-Systemen verbinden Sie diesen Ausgang mit den rechten Frontlautsprecheranschluss der aktiven Lautsprechers. |
| 2   | Frontausgang(L)             | Bei 7.1-Kanal-Systemen verbinden Sie diesen Ausgang mit den linken Frontlautsprecheranschluss der aktiven Lautsprechers.  |
| 3   | Seitlicher Surround-Ausgang | Hier schließen Sie die linken und rechten Surround-Eingänge von 7.1-Kanal-Lautsprechern an.                               |
| 4   | Center/Subwoofer-Ausgang    | Hier schließen Sie den Mittel/Subwoofer-Eingang von 7.1-Kanal-Lautsprechern per Miniklinkenkabel an.                      |
| 5   | Hinterer Surround-Ausgang   | Schließen Sie hier den hinteren Surround-Eingang Ihres 7.1-Kanal-Kopfhörers an.   |

# 1. Introduzione

## 1.1 Contenuto della Confezione

Controllare che nella confezione della scheda audio ASUS Xonar™ U7 siano contenuti i seguenti articoli:

- Scheda audio USB ASUS Xonar™ U7 a 7.1 canali
- CD Driver
- Adattatore ottico S/PDIF TOSLINK x 1
- Guida Rapida

## 1.2 Requisiti del sistema

Per garantire una corretta installazione della scheda Xonar U7, il computer deve soddisfare i seguenti requisiti:

- PC compatibile IBM con una porta compatibile USB1.1 (o superiore) per la periferica audio USB.
- Connettore cavo di alimentazione periferico a 6-pin proveniente dall'unità di alimentazione del computer (PSU)
- Microsoft® Windows® XP (32/64bit) / Windows® 7 (32/64bit)/ Windows® 8 (32/64bit)
- CPU Intel® Pentium® 4 1.4 GHz o AMD® Athlon 1400 CPU più potente.
- Memoria di sistema superiore a 256 MB.
- Oltre 60 MB di spazio libero per l'installazione dei driver.
- Drive CD-ROM (oppure DVD-ROM) per l'installazione del software.
- Cuffie di alta qualità, altoparlanti analogici alimentati o decodificatore Dolby Digital, per una riproduzione audio ad altissima fedeltà.

## 2. Hardware

### Scheda audio Xonar U7

#### Vista superiore

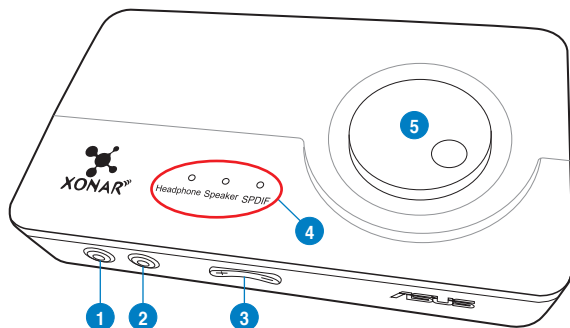

#### Vista posteriore

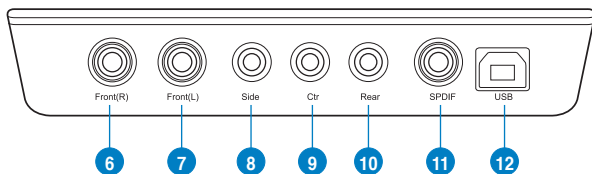

#### Vista inferiore

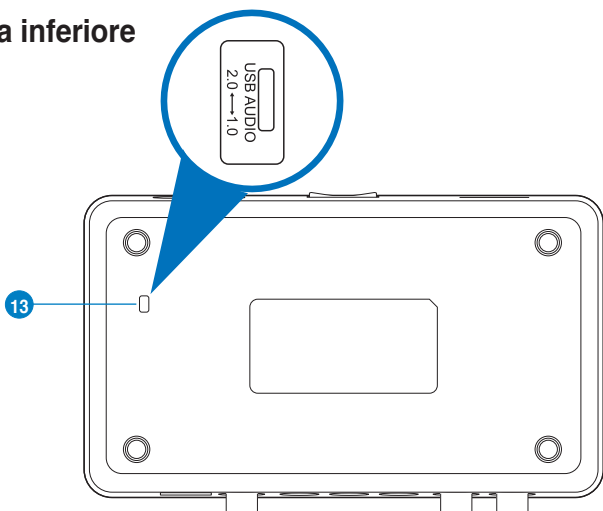

| No | Elemento                                    | Descrizione   |
|----|---|---|
| 1  | Porta Uscita Cuffie                         | Collegare le cuffie a questa porta.   |
| 2  | Porta Ingresso Microfono                    | Collegare il microfono esterno del PC a questa porta da 3.5mm per l'ingresso vocale. Pre-amplificatore integrato di alta qualità per microfono.   |
|    | Porta ingresso linea audio                  | Collegare dispositivi analogici, come lettori MP3, lettori di CD, sintetizzatori musicali e altre sorgenti audio a livello di linea a questa porta da 3.5mm per registrazioni o elaborazioni audio.   |
| 3  | Controllo volume microfono                  | Premere per aumentare o diminuire il volume del microfono.  |
| 4  | Indicatore di selezione uscita              | Il LED indica varie selezioni di uscita (Headphone/Speaker/S/PDIF) (Cuffie/Altoparlante/S/PDIF).  |
| 5  | Selezione uscita/Controllo volume           | Ruotare per regolare il volume di riproduzione. Premere per selezionare una sorgente di uscita.   |
| 6  | Porta Uscita Frontale (D)                   | Nei sistemi di altoparlanti a 2/4/5.1/7.1 canali, collega all'ingresso di destra e frontale su altoparlanti alimentati.   |
| 7  | Porta Uscita Frontale (S)                   | Nei sistemi di altoparlanti a 2/4/5/7.1 canali, collega all'ingresso di sinistra e frontale su altoparlanti alimentati.   |
| 8  | Porta di uscita surround laterale           | Collegare questa porta all'ingresso del canale laterale surround su altoparlanti analogici alimentati 7.1.  |
| 9  | Porta Uscita Centro/Subwoofer               | Collegare questa porta all'ingresso del canale laterale surround su altoparlanti analogici alimentati 5.1/7.1.  |
| 10 | Porta Uscita Posteriore                     | Collega all'ingresso surround posteriore su altoparlanti analogici alimentati 4/5.1/7.1.  |
| 11 | Uscita altoparlanti laterali/ Uscita S/PDIF | Uscita digitale coassiale. Collega ad un decodificatore digitale esterno o a sistemi di altoparlanti digitali, sistemi Home Theater, ricevitori AV per l'uscita audio digitale, fra cui PCM, Dolby Digital, DTS, WMA-Pro, ecc. Collegare questa porta all'ingresso del canale laterale surround su altoparlanti analogici alimentati 4/5.1/7.1. |
| 12 | Porta USB                                   | Si collega al computer tramite un cavo USB tipo B-A.  |
| 13 | Interruttore USB Audio 1.0/2.0              | Spostare l'interruttore per passare tra le connessioni USB Audio 2.0 e USB Audio 1.0. Usare USB Audio 1.0 per plug-and-play. Usare USB Audio 2.0 su Mac (computer Apple).   |



L'interruttore USB Audio 1.0/2.0 si trova nella parte inferiore della scheda audio. La connessione USB Audio 1.0 presenta i seguenti limiti:

- Supporta solo funzioni di riproduzione:
- Altoparlanti 7.1, cuffie, ingresso microfono/ingresso linea e uscita SPDIF supportano solo frequenze di campionamento di 44,1 KHz / 48 KHz @ 16 bit.

## 3. Installazione Driver

### 3.1 Installazione del driver della scheda Xonar U7

Dopo aver installato la scheda audio esterna USB ASUS Xonar U7 nel computer, è necessario installare il driver del dispositivo che abilita la scheda a funzionare con il sistema operativo Windows.



La versione e il contenuto del CD di supporto sono soggetti a modifiche senza preavviso.

Per installare il driver del dispositivo:

1. Inserire il CD di supporto di ASUS Xonar U7 nell'unità ottica. Se la funzione d'esecuzione automatica è abilitata, appare automaticamente la schermata ASUS Xonar Card Driver. In questo caso, passare al punto 4, altrimenti, seguire le istruzioni indicate al punto 2.
2. Cliccare su **Computer** del desktop e fare doppio clic sull'icona dell'unità ottica.
3. Fare doppio clic sull'icona setup.exe dell'unità ottica.
4. Seguire le istruzioni su schermo per completare l'installazione. Leggere il contenuto del "**CONTRATTO DI LICENZA ALL'UTENTE FINALE**" ed assicurarsi di averlo capito, prima di accettarlo e continuare con l'installazione.
5. Al termine dell'installazione, potrebbe essere richiesto di riavviare il computer. E' possibile scegliere di riavviare in un secondo tempo.

### 3.2 Rimozione o reinstallazione dei driver della scheda Xonar U7

#### 3.2.1 Rimozione del driver della scheda Xonar U7

Per installare i driver della scheda Xonar U7:

1. Andare a **Start > Control Panel (Pannello di controllo) > Programs and Features (Programmi e funzionalità)**.
2. Fare clic con il tasto destro sul driver da rimuovere, quindi fare clic su **Uninstall (Disinstalla)**.
3. Nella finestra di dialogo **InstallShield Wizard**, selezionare l'opzione **Remove**.
4. A richiesta, riavviare il computer.

#### 3.2.2 Reinstallazione dei driver della scheda Xonar U7

Per reinstallare i driver della scheda Xonar U7:

1. Disinstallare il software o il driver esistente.
2. Osservare la procedura di installazione del driver.

## 4. Connessione di altoparlanti e periferiche

### 4.1 Collegamento ingresso

#### 4.1.1 Collegamento ad una porta USB 2.0 del computer

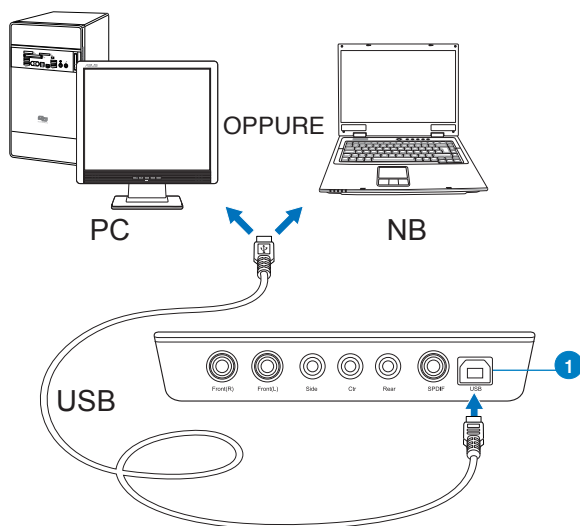

| No | Elemento  | Descrizione  |
|----|-----------|--|
| 1  | Porta USB | Si collega al computer tramite un cavo USB tipo B-A. |

## 4.1.2 Collegamento di sistemi audio digitali

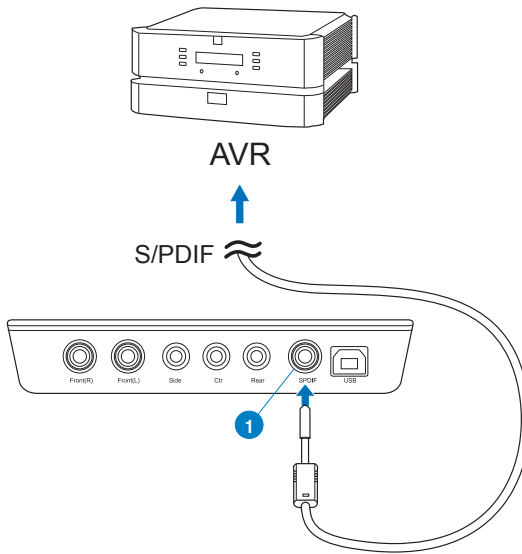

| No | Elemento                                    | Descrizione  |
|----|---|--|
| 1  | Uscita altoparlanti laterali/ Uscita S/PDIF | Collegare un AVR (ricevitore audio/video) a questa porta di uscita S/PDIF. |

### 4.1.3 Collegamento del microfono / Line-In

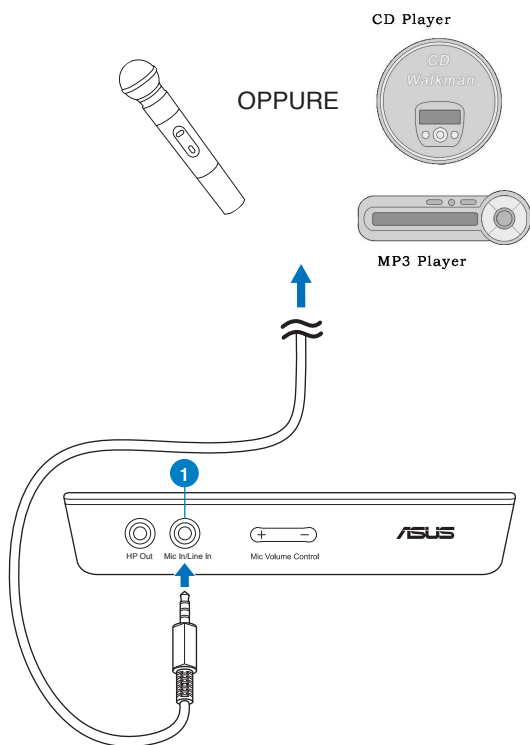

| No | Elemento                                   | Descrizione   |
|----|--|---|
| 1  | Porta di ingresso microfono/ingresso linea | <p>Collegare lo spinotto da 3,5 mm del microfono alla porta Mic-In per comunicazione vocale, registrazione o karaoke.</p> <p>Collegare lo spinotto da 3,5 mm del lettore CD/MP3 o di altre sorgenti audio analogiche di linea alla porta Line-In per la registrazione di audio.</p> |



## 4.2 Collegamento uscita

### 4.2.1 Collegamento di cuffie stereo

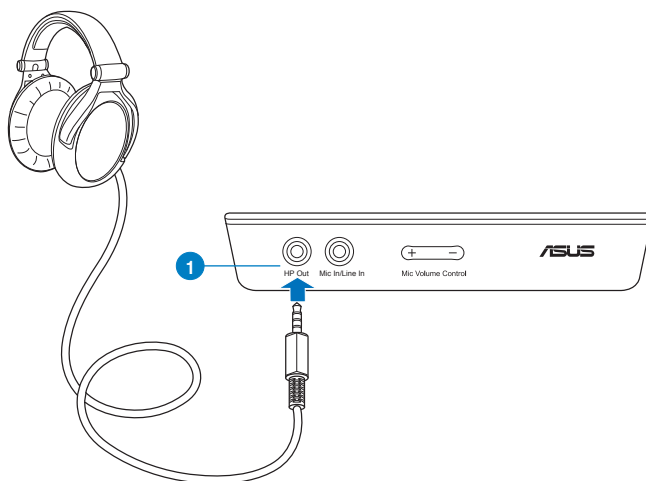

| No | Elemento            | Descrizione  |
|----|---------------------|--|
| 1  | Porta Uscita Cuffie | La porta di uscita cuffie dispone di un amplificatore di alta qualità integrato per l'utilizzo delle cuffie. Collegare le cuffie stereo direttamente a questa porta. |

## 4.2.2 Collegamento di cuffie a 5.1 canali

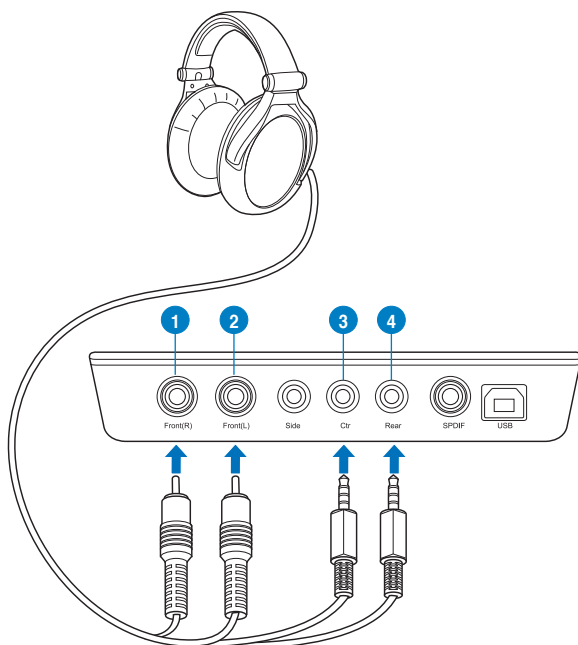

| No | Elemento                            | Descrizione   |
|----|-------------------------------------|---|
| 1  | Porta Uscita Frontale (D)           | Si collega alla porta di ingresso anteriore destra delle cuffie a 5.1 canali tramite il cavo RCA.   |
| 2  | Porta Uscita Frontale (S)           | Si collega alla porta di ingresso anteriore sinistra delle cuffie a 5.1 canali tramite il cavo RCA. |
| 3  | Porta Uscita Centro/Subwoofer       | Collegare lo spinotto da 3,5 mm del canale centrale/bassi delle cuffie a 5.1 canali in questo jack. |
| 4  | Porta di uscita surround posteriore | Si collega alla porta di ingresso surround posteriore delle cuffie a 5.1 canali.                    |

### 4.2.3 Collegamento di sistemi di altoparlanti analogici

#### Collegamento di altoparlanti a 2 canali

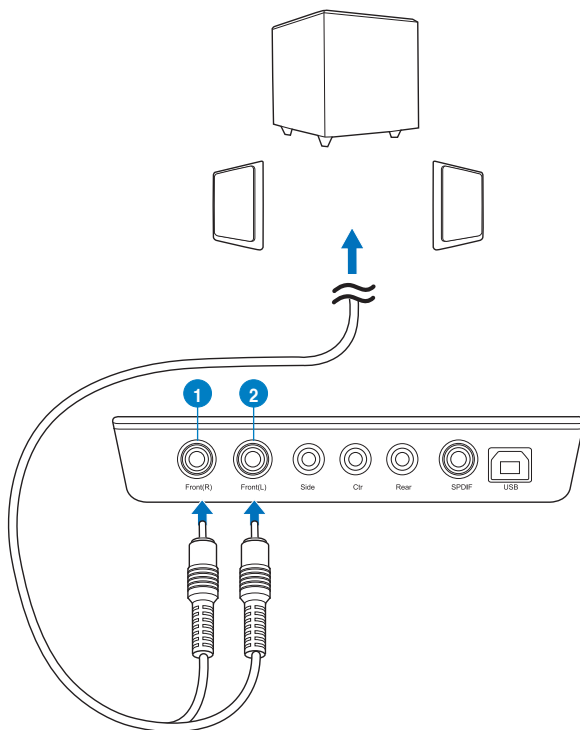

| No | Elemento                  | Descrizione   |
|----|---------------------------|---|
| 1  | Porta Uscita Frontale (D) | Si collega alla porta di ingresso anteriore destra degli altoparlanti a 2 canali tramite il cavo RCA.   |
| 2  | Porta Uscita Frontale (S) | Si collega alla porta di ingresso anteriore sinistra degli altoparlanti a 2 canali tramite il cavo RCA. |

## Collegamento di altoparlanti a 4.1 canali/amplificatore di potenza

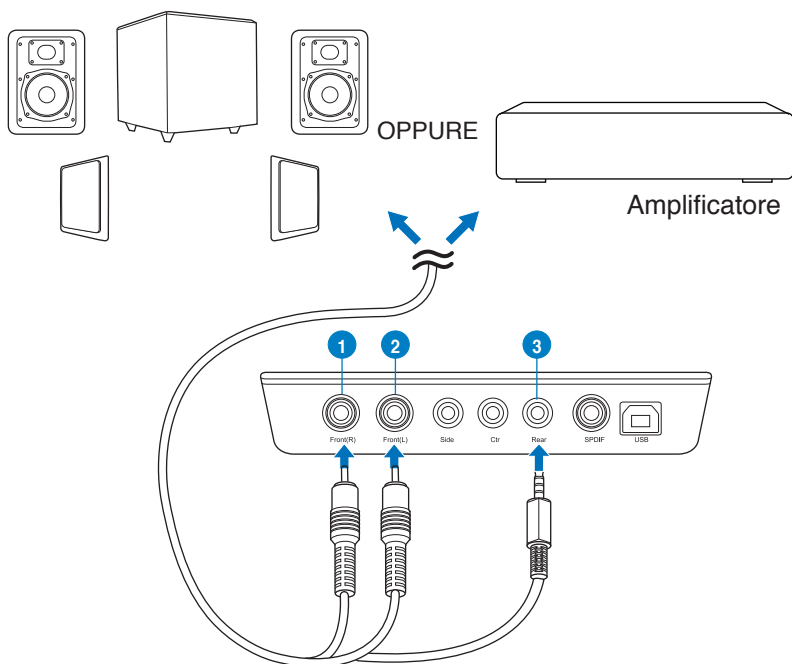

| No | Elemento                            | Descrizione  |
|----|-------------------------------------|--|
| 1  | Porta Uscita Frontale (D)           | Si collega alla porta di ingresso anteriore destra degli altoparlanti a 4.1 canali.    |
| 2  | Porta Uscita Frontale (S)           | Si collega alla porta di ingresso anteriore sinistra degli altoparlanti a 4.1 canali.  |
| 3  | Porta di uscita surround posteriore | Si collega alla porta di ingresso surround posteriore degli altoparlanti a 4.1 canali. |

## Collegamento di altoparlanti a 5.1 canali

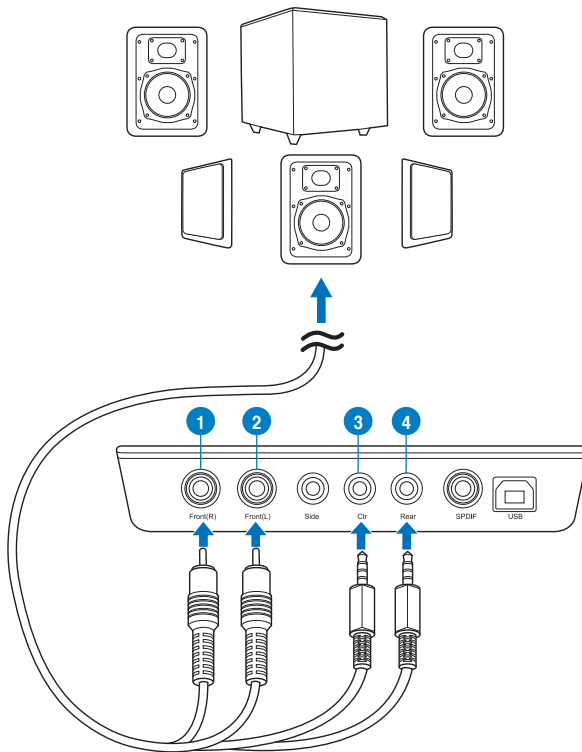

| No | Elemento                            | Descrizione   |
|----|-------------------------------------|---|
| 1  | Porta Uscita Frontale (D)           | Si collega alla porta di ingresso anteriore destra degli altoparlanti a 5.1 canali.     |
| 2  | Porta Uscita Frontale (S)           | Si collega alla porta di ingresso anteriore sinistra degli altoparlanti a 5.1 canali.   |
| 3  | Porta Uscita Centro/Subwoofer       | Si collega alle porte di ingresso centrale e subwoofer degli altoparlanti a 5.1 canali. |
| 4  | Porta di uscita surround posteriore | Si collega alla porta di ingresso surround posteriore degli altoparlanti a 5.1 canali.  |

## Collegamento di altoparlanti a 7.1 canali

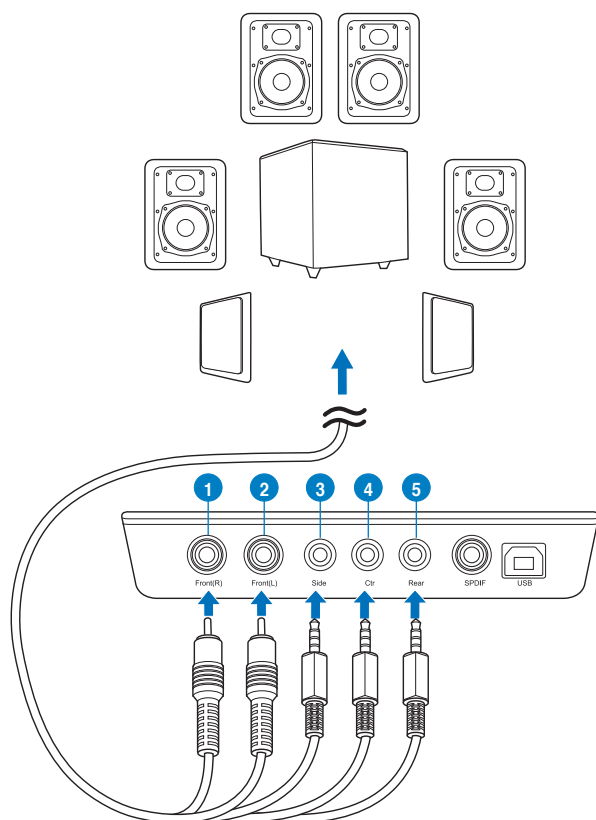

| No | Elemento                            | Descrizione   |
|----|-------------------------------------|---|
| 1  | Porta Uscita Frontale (D)           | Si collega alla porta di ingresso anteriore destra degli altoparlanti a 7.1 canali.                             |
| 2  | Porta Uscita Frontale (S)           | Si collega alla porta di ingresso anteriore sinistra degli altoparlanti a 7.1 canali.                           |
| 3  | Porta di uscita surround laterale   | Si collega alle porte di ingresso surround sinistra e destra degli altoparlanti a 7.1 canali.                   |
| 4  | Porta Uscita Centro/Subwoofer       | Si collega alla porta di ingresso centrale/subwoofer degli altoparlanti a 7.1 canali tramite il cavo mini-jack. |
| 5  | Porta di uscita surround posteriore | Si collega alla porta di ingresso surround posteriore degli altoparlanti a 7.1 canali.                          |

# 1. Introdução

## 1.1 Conteúdo da embalagem

Verifique se a embalagem da sua placa de áudio ASUS Xonar™ U7 contém os seguintes itens:

- Placa de áudio USB ASUS Xonar™ U7 de 7.1 Canais
- CD de controladores
- Adaptador óptico S/PDIF TOSLINK x 1
- Guia de instalação rápida

## 1.2 Requisitos do sistema

Antes de instalar a placa de áudio Xonar U7, certifique-se de que seu computador cumpre os seguintes requisitos:

- PC compatível com IBM com uma porta compatível com USB 1.1 (ou superior) para o dispositivo de áudio USB
- Microsoft® Windows® XP (32/64bit) / Windows® 7 (32/64bit) / Windows® 8 (32/64bit)
- CPU Intel® Pentium® 4 de 1,4 GHz ou AMD Athlon 1400 ou acima
- Mais de 256 MB de memória do sistema
- Mais de 60 MB de espaço de armazenamento disponível para instalação do controlador
- Unidade de CD-ROM (ou de DVD-ROM) para instalação do software
- Auscultadores de alta qualidade, altifalantes analógicos amplificados ou um decodificador Dolby Digital para desfrutar do som de alta-fidelidade da placa de áudio

## 2. Hardware

### Placa de Áudio Xonar U7

#### Vista superior

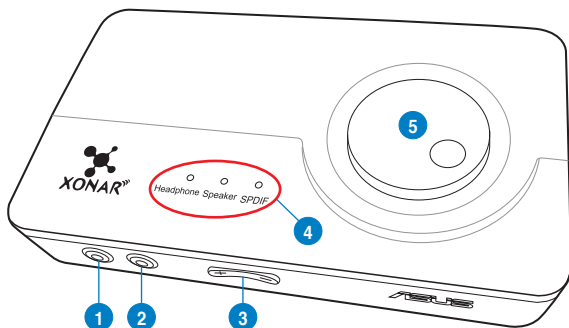

#### Vista posterior

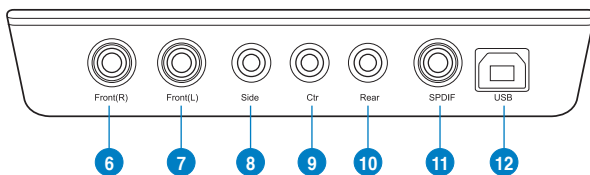

#### Vista inferior

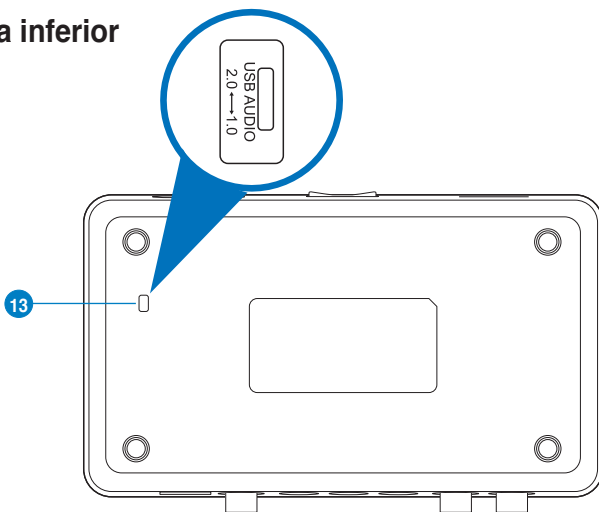



| No | Item                                  | Descrição   |
|----|---------------------------------------|---|
| 1  | Porta de saída auscultadores          | Ligue os seus auscultadores a esta porta.   |
| 2  | Porta de entrada de microfone         | Ligue o seu microfone de PC externo a esta porta de 3.5mm para entrada de voz. Pré-amplificador interno de microfone de alta qualidade.   |
|    | Porta de entrada de linha             | Ligue dispositivos analógicos como leitores de MP3, leitores de CD, sintetizadores e outras fontes de áudio de nível de linha a esta porta de 3.5mm para gravação ou processamento de áudio.  |
| 3  | Controlo de volume do microfone       | Pressione para aumentar ou diminuir o volume do microfone.  |
| 4  | Indicador de selecção de saída        | O indicador LED indica as diferentes selecções de saída (Auscultadores/Altifalante/S/PDIF).   |
| 5  | Seleccção de saída/controlo de volume | Rode para ajustar o volume de reprodução. Pressione para seleccionar uma fonte de entrada.  |
| 6  | Porta de saída frontal (direita)      | Para um sistema de altifalantes de 2/4/5.1/7.1 canais, liga à entrada frontal direita dos altifalantes amplificados.  |
| 7  | Porta de saída frontal (esquerda)     | Para um sistema de altifalantes de 2/4/5.1/7.1 canais, liga à entrada frontal esquerda dos altifalantes amplificados.   |
| 8  | Porta de saída Surround lateral       | Liga à entrada de canal surround em altifalantes 7.1 analógicos amplificados.   |
| 9  | Porta de saída central/Subwoofer      | Liga à entrada central/subwoofer em altifalantes 5.1/7.1 analógicos amplificados.   |
| 10 | Porta de saída traseira               | Liga à entrada traseira/surround em altifalantes 4/5.1/7.1 analógicos amplificados.   |
| 11 | Porta de saída S/PDIF/Lateral         | Porta de saída digital. Liga a descodificadores digitais ou sistemas de altifalantes digitais, sistemas de cinema em casa, receptores AV para saída de áudio digital incluindo PCM, Dolby Digital, DTS, WMA-Pro, etc. Liga à entrada de canal surround em altifalantes 4/5.1/7.1 analógicos amplificados. |
| 12 | Porta USB                             | Ligue ao seu computador utilizando um cabo USB tipo-A.  |
| 13 | Interruptor de áudio USB 1.0/2.0      | Desloque este interruptor para alternar entre a ligação de Áudio USB 2.0 e Áudio USB 1.0. Utilize Áudio USB 1.0 para plug and play. Utilize Áudio USB 2.0 num Mac (computador Apple).   |



O interruptor de Áudio USB 1.0/2.0 está localizado na parte inferior da placa de áudio. A ligação de Áudio USB tem as seguintes limitações:

- Suporta apenas funcionalidades de reprodução.
- Altifalantes 7.1, Auscultadores, Entrada de microfone/linha e Saída SPDIF apenas suportam taxas de amostragem de 44.1KHz / 48KHz a 16 bits.

## 3. Instalação dos Controladores

### 3.1 Instalar o controlador da placa Xonar U7

Depois de instalar a estação de áudio USB externa Xonar U7 no seu computador, deverá instalar os controladores que permitem que a estação de áudio Xonar U7 funcione com o sistema operativo Windows.



A versão e o conteúdo do CD da unidade estão sujeitas a alterações sem aviso prévio.

Para instalar os controladores do dispositivo:

1. Introduza o CD de suporte da ASUS Xonar U7 na unidade óptica. Se a execução automática estiver activa, o ecrã dos controladores da ASUS Xonar aparece automaticamente. Siga para o passo 4. Se a execução automática não estiver activa no seu computador execute o passo 2.
2. Clique em **Computador** na sua área de trabalho e clique duas vezes no ícone da unidade óptica.
3. Clique duas vezes no ícone setup.exe localizado na unidade óptica.
4. Siga as instruções no ecrã para concluir a instalação. Leia o “**ACORDO DE LICENÇA DE UTILIZADOR**” no processo e certifique-se que o entende e aceita antes de continuar a instalação.
5. Ao concluir a instalação JC , poder-lhe-á ser pedido que reinicie o seu computador. Se desejar, poderá reiniciar o computador mais tarde.

### 3.2 Desinstalar ou reinstalar o controlador da placa Xonar Phoebus

#### 3.2.1 Desinstalar o controlador da placa Xonar U7

Para desinstalar o controlador da placa Xonar U7:

1. Clique em **Start (Iniciar) > Control Panel (Painel de controlo) > Programs and Features (Programas e Funcionalidades)**.
2. Clique com o botão direito no controlador que deseja remover e clique em **Uninstall (Desinstalar)**.
3. Na caixa de diálogo **InstallShield Wizard (Assistente InstallShield)**, seleccione a opção **Remove (Remover)**.
4. Reinicie o computador quando lhe for solicitado.

#### 3.2.2 Reinstalar o controlador da placa Xonar U7

Para reinstalar o controlador da placa Xonar U7:

1. Desinstale o software ou controlador existente.
2. Siga o processo de instalação para reinstalar o controlador.

## 4. Ligar altifalantes e periféricos

### 4.1 Ligação de entrada

#### 4.1.1 Ligar a uma porta USB 2.0 do seu computador

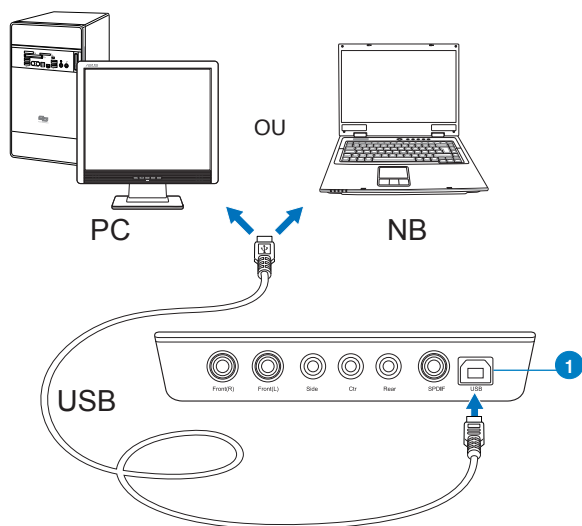

| No | Item      | Descrição  |
|----|-----------|--|
| 1  | Porta USB | Ligue ao seu computador utilizando um cabo USB tipo-A. |

## 4.1.2 Ligar sistemas de áudio digital

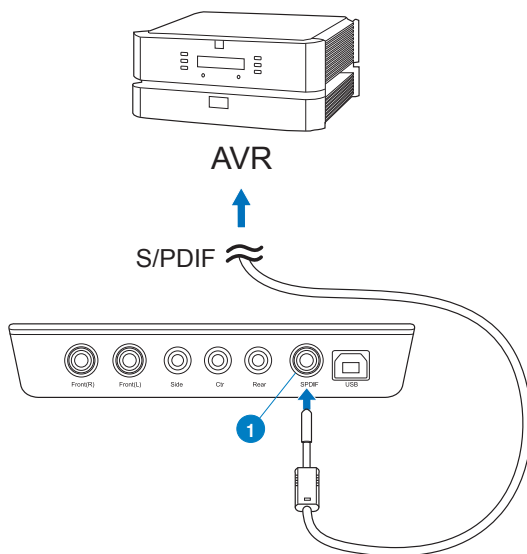

| No | Item                          | Descrição  |
|----|-------------------------------|--|
| 1  | Porta de saída S/PDIF/Lateral | Ligue um RAV (Receptor de Áudio/Vídeo) a esta porta de saída S/PDIF. |

### 4.1.3 Ligar o microfone/entrada de linha

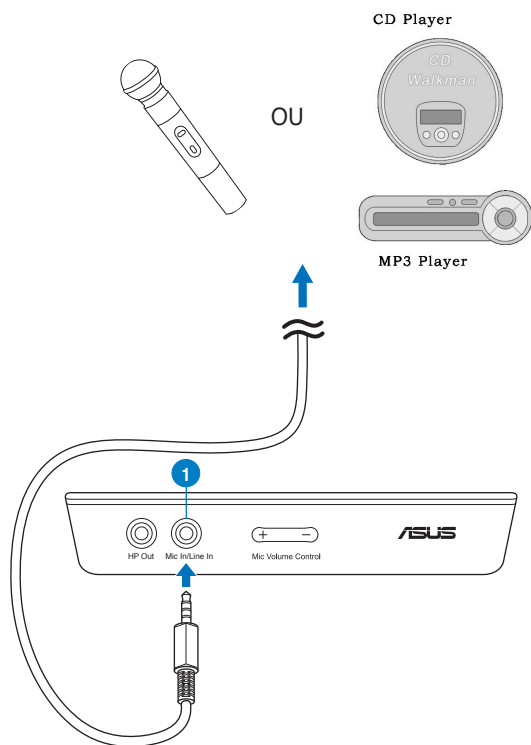

| No | Item                                    | Descrição   |
|----|---|---|
| 1  | Porta de Microfone/<br>Entrada de linha | <p>Ligue a ficha de 3,5 mm do microfone a esta porta de entrada de microfone para comunicação de voz, gravação ou karaoke.</p> <p>Ligue a ficha de 3,5 mm do leitor de CD/MP3 ou de qualquer fonte de áudio analógico com saída de linha a esta porta de entrada de linha para gravação de som.</p> |

## 4.2 Ligação de saída

### 4.2.1 Ligar auscultadores estéreo

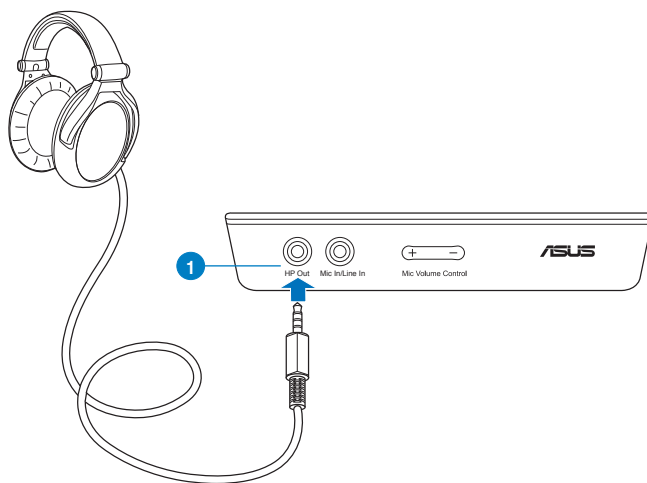

| No | Item                         | Descrição  |
|----|------------------------------|--|
| 1  | Porta de saída auscultadores | A porta de saída para auscultadores está equipada com um amplificador de alta qualidade incorporado para amplificar os auscultadores. Ligue os seus auscultadores estéreo directamente a esta porta. |

## 4.2.2 Ligar auscultadores de 5.1 canais

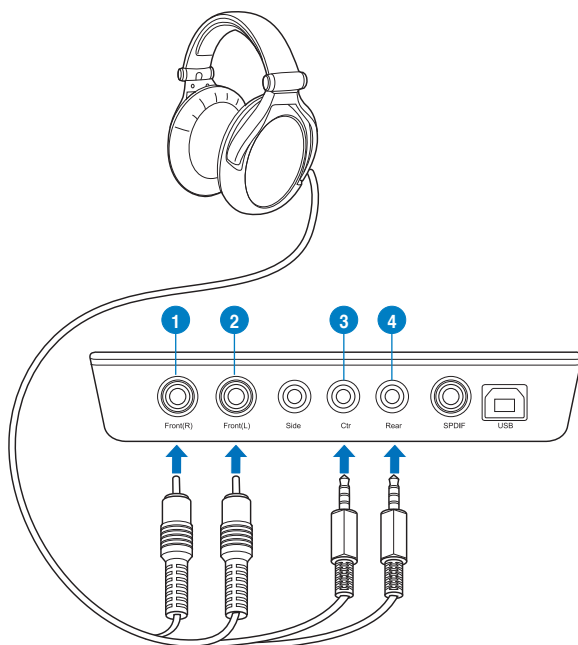

| No | Item                              | Descrição  |
|----|-----------------------------------|--|
| 1  | Porta de saída frontal (direita)  | Liga à porta de entrada frontal direita de auscultadores de 5.1 canais utilizando o cabo RCA.      |
| 2  | Porta de saída frontal (esquerda) | Liga à porta de entrada frontal esquerda de auscultadores de 5.1 canais utilizando o cabo RCA.     |
| 3  | Porta de saída central/Subwoofer  | Ligue a ficha de 3,5 mm do canal Central/Graves dos seus auscultadores de 5.1 canais a esta ficha. |
| 4  | Porta de saída surround traseira  | Ligue à porta de entrada traseira surround dos seus auscultadores de 5.1 canais.                   |

## 4.2.3 Ligar sistemas de altifalantes analógicos

### Ligar altifalantes de 2 canais

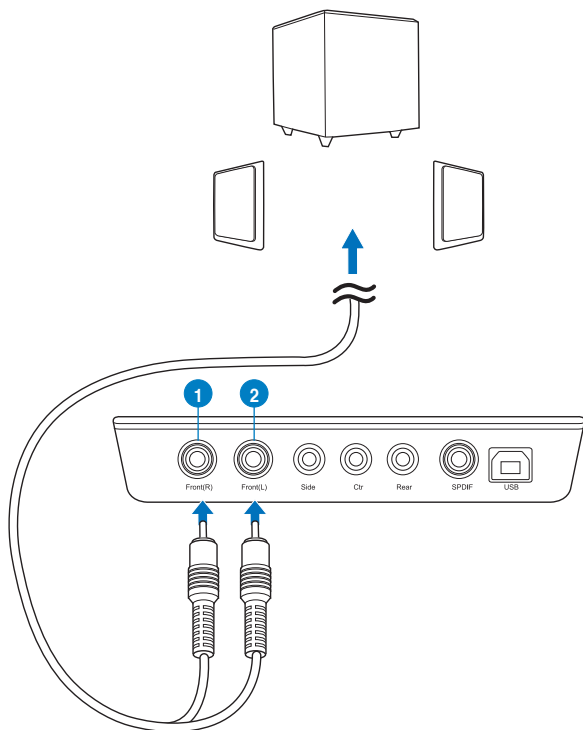

| No | Item                              | Descrição   |
|----|-----------------------------------|---|
| 1  | Porta de saída frontal (direita)  | Liga à porta de entrada frontal direita de altifalantes de 2 canais utilizando o cabo RCA.  |
| 2  | Porta de saída frontal (esquerda) | Liga à porta de entrada frontal esquerda de altifalantes de 2 canais utilizando o cabo RCA. |



## Ligar altifalantes de 4.1 canais/amplificador

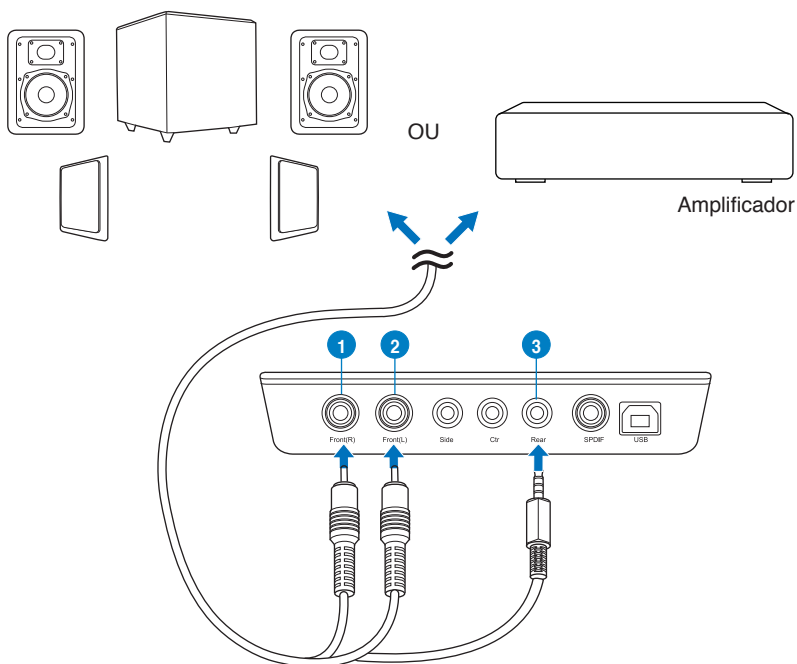

| No | Item                              | Descrição  |
|----|-----------------------------------|--|
| 1  | Porta de saída frontal (direita)  | Liga à porta de entrada frontal direita de altifalantes de 4.1 canais.   |
| 2  | Porta de saída frontal (esquerda) | Liga à porta de entrada frontal esquerda de altifalantes de 4.1 canais.  |
| 3  | Porta de saída surround traseira  | Liga à porta de entrada traseira surround de altifalantes de 4.1 canais. |

## Ligar altifalantes de 5.1 canais

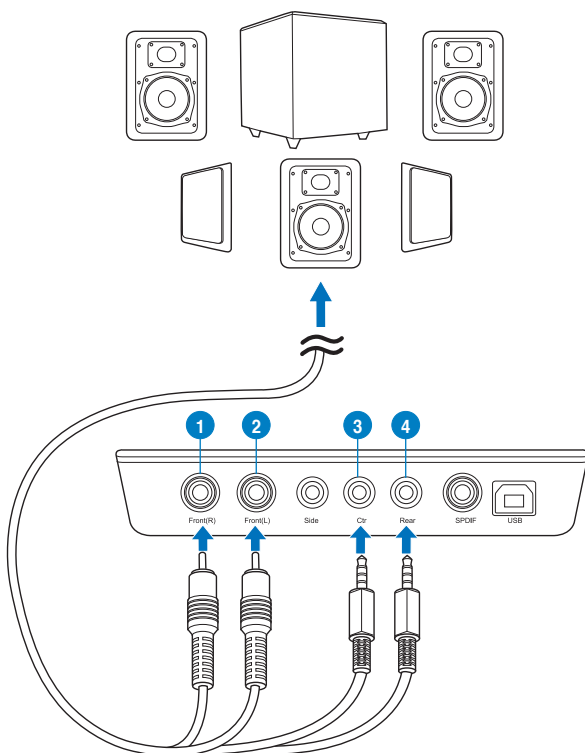

| No | Item                              | Descrição   |
|----|-----------------------------------|---|
| 1  | Porta de saída frontal (direita)  | Liga à porta de entrada frontal direita de altifalantes de 5.1 canais utilizando o cabo de ficha mini.  |
| 2  | Porta de saída frontal (esquerda) | Liga à porta de entrada frontal esquerda de altifalantes de 5.1 canais utilizando o cabo de ficha mini. |
| 3  | Porta de saída central/Subwoofer  | Liga às portas de entrada Central e Subwoofer de altifalantes de 5.1 canais.                            |
| 4  | Porta de saída surround traseira  | Ligue à porta de entrada traseira surround dos seus auscultadores de 5.1 canais.                        |

## Ligar altifalantes de 7.1 canais

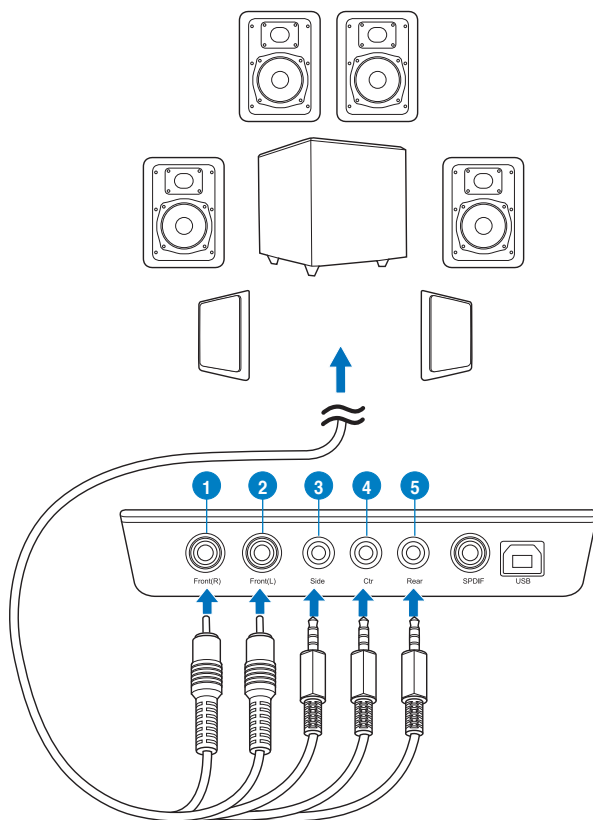

| No | Item                              | Descrição  |
|----|-----------------------------------|--|
| 1  | Porta de saída frontal (direita)  | Liga à porta de entrada frontal direita de altifalantes de 7.1 canais utilizando o cabo de ficha mini.   |
| 2  | Porta de saída frontal (esquerda) | Liga à porta de entrada frontal esquerda de altifalantes de 7.1 canais utilizando o cabo de ficha mini.  |
| 3  | Porta de saída Surround lateral   | Liga às portas de entrada surround Esquerdo e surround Direito de altifalantes de 7.1 canais.            |
| 4  | Porta de saída central/Subwoofer  | Liga à porta de entrada Central/Subwoofer de altifalantes de 7,1 canais utilizando o cabo de ficha mini. |
| 5  | Porta de saída surround traseira  | Ligue à porta de entrada traseira surround dos seus auscultadores de 7.1 canais.                         |

# 1. Введение

## 1.1 Комплект поставки

В комплект поставки аудиокарты ASUS Xonar U7 входит следующее:

- 7.1-канальная аудиокарта ASUS Xonar U7 USB
- Компакт диск с драйверами
- Оптический адаптер S/PDIF TOSLINK x 1
- Краткое руководство

## 1.2 Системные требования

Для обеспечения успешной установки карты Xonar U7, компьютер должен удовлетворять следующим требованиям:

- IBM-совместимый компьютер с портом USB 1.1 (или выше) для USB аудиокарты
- Microsoft® Windows® XP (32/64bit) / Windows® 7 (32/64bit)/ Windows® 8 (32/64bit)
- Процессор Intel Pentium 4 1.4ГГц, AMD Athlon 1400 или более быстрый
- Более 256 МБ системной памяти
- Более 60 МБ свободного пространства на жестком диске для установки драйверов
- CD-ROM (DVD-ROM) привод для установки программного обеспечения
- Высококачественные наушники, активные аналоговые колонки или декодер Dolby Digital

## 2. Аппаратное обеспечение

### Аудиокарта Xonar U7

Вид сверху

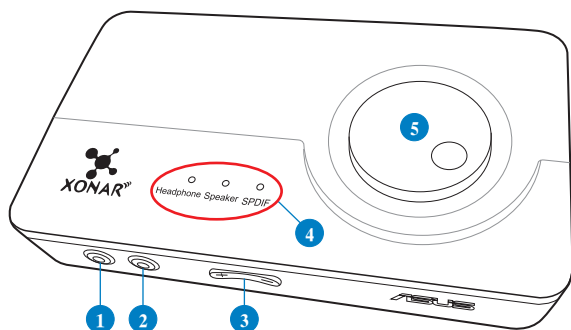

Вид сзади

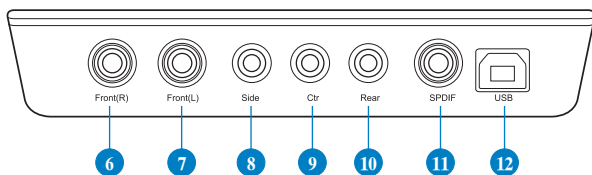

Нижняя панель

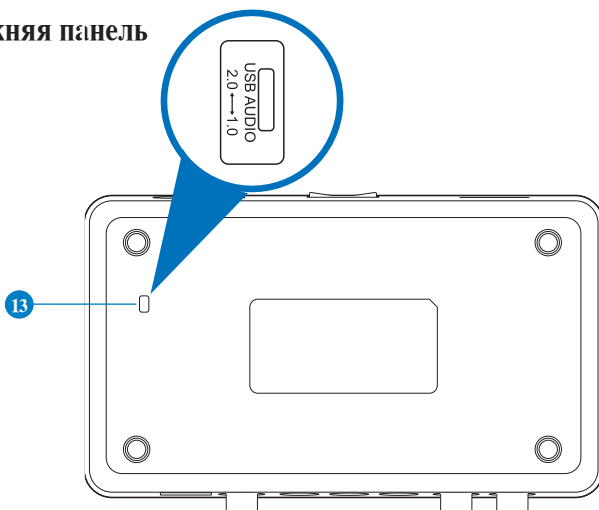

| Нет | Элемент                              | Описание   |
|-----|--------------------------------------|--|
| 1   | Разъем для наушников                 | Подключение наушников.   |
| 2   | Разъем для микрофона                 | Подключение внешнего микрофона для голосового ввода. Имеется встроенный, высококачественный предварительный усилитель для микрофона.   |
|     | Аудиовход                            | Подключение аналоговых устройств (например MP3-плееры, проигрыватели компакт-дисков, музыкальные синтезаторы и другие источники звука) для записи/обработки звука.   |
| 3   | Регулировка громкости микрофона      | Нажмите для увеличения или уменьшения громкости.   |
| 4   | Индикатор выбранного выхода          | Индикатор отображает выбранный выход(Headphone/Speaker/S/PDIF).  |
| 5   | Выбор выхода / Регулировка громкости | Поверните для регулировки громкости звука. Нажмите для выбора выхода.  |
| 6   | Выход правого фронтального канала    | Подключение правого фронтального канала 2/4/5.1/7.1 - канальной акустической системы.  |
| 7   | Выход левого фронтального канала     | Подключение левого фронтального канала 2/4/5.1/7.1 - канальной акустической системы.   |
| 8   | Выход на боковые колонки             | Подключение боковых колонок для многоканальных акустических систем.  |
| 9   | Выход центрального канала/сабвуфера  | Подключение центрального канала/сабвуфера 5.1/7.1 - канальной акустической системы.  |
| 10  | Выход тылового канала                | Подключение тыловых колонок для многоканальных акустических систем.  |
| 11  | S/PDIF-выход                         | Коаксиальный цифровой выход. Подключение к внешнему цифровому декодеру или цифровой акустической системе, домашнему кинотеатру, AV-ресиверу для вывода цифрового звука, в форматах PCM, Dolby Digital, DTS и WMA-Pro и т.д. Подключение тыловых колонок 4//5/7.1 - канальной акустической системы. |
| 12  | USB-порт                             | Подключение к порту USB компьютера.  |
| 13  | Переключатель USB Audio 1.0/2.0      | Переместите переключатель в положение USB Audio 2.0 и USB Audio 1.0. Используйте USB Audio 1.0 для plug and play. Используйте USB Audio 2.0 для Apple-компьютера.  |



Переключатель USB Audio 1.0/2.0 расположен на нижней стороне аудиокарты. Подключение USB Audio 1.0 имеет следующие ограничения:

- Поддерживается только функция воспроизведения.
- Все порты поддерживают частоту дискретизации только 44.1 КГц/48КГц 16-бит.

## 3. Установка драйвера

### Установка драйвера для Xonar U7

После подключения Xonar U7 к компьютеру, необходимо установить драйвер устройства, необходимый для операционной системой Windows.



---

Версия и содержимое ПО на компакт-диске может изменяться без уведомления.

---

Для установки драйвера устройства:

1. Вставьте компакт-диск Xonar U7 в оптический привод. Если автозапуск включен, появится меню установки. Перейдите к пункту 4. Если автозапуск не включен, перейдите к пункту 2.
2. На рабочем столе нажмите **Мой компьютер** и дважды щелкните на иконке оптического привода.
3. Дважды щелкните по файлу **setup.exe** на компакт-диске.
4. Следуйте инструкциям на экране для завершения установки. Перед установкой прочитайте и примите условия **ЛИЦЕНЗИОННОГО СОГЛАШЕНИЯ**.
5. По окончании установки, Вам предложат перезагрузить компьютер. Если желаете, можете перезагрузить компьютер позже.

### 3.2 Удаление или переустановка драйвера Xonar U7

#### 3.2.1 Удаление драйвера Xonar U7

Для установки драйвера Xonar U7:

1. Нажмите **Пуск > Панель управления > Программы > Программы и компоненты**.
2. Щелкните правой кнопкой по драйверу, который нужно удалить и нажмите **Удалить**.
3. В диалоговом окне выберите опцию **Удалить**.
4. Перезагрузите компьютер при появлении соответствующего запроса.

#### Переустановка драйвера Xonar U7

Для переустановки драйвера Xonar U7:

1. Удалите установленный драйвер.
2. Следуйте инструкциям на экране для установки драйвера.

## 4. Подключение колонок и периферии

### 4.1 Подключение

#### 4.1.1 Подключение к USB порту компьютера

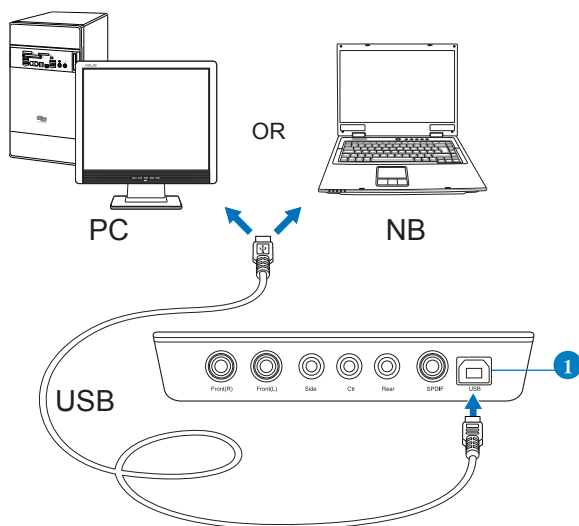

| Нет | Элемент  | Описание                            |
|-----|----------|-------------------------------------|
| 1   | USB-порт | Подключение к порту USB компьютера. |



## 4.1.2 Подключение цифровых колонок

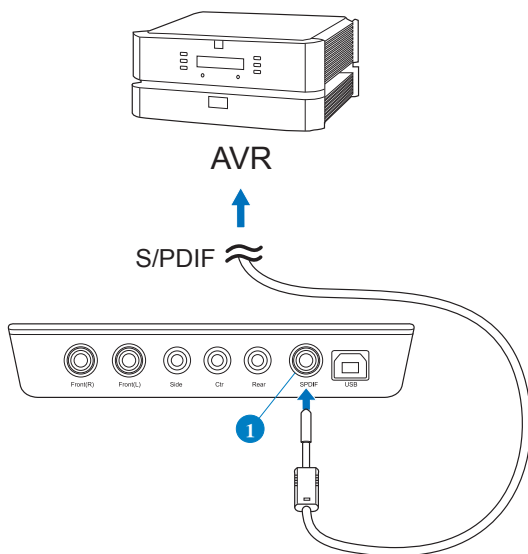

| Нет | Элемент      | Описание                                |
|-----|--------------|---|
| 1   | S/PDIF-выход | Подключите AVR (аудио-/видео ресивера). |

### 4.1.3 Подключение микрофона и устройств

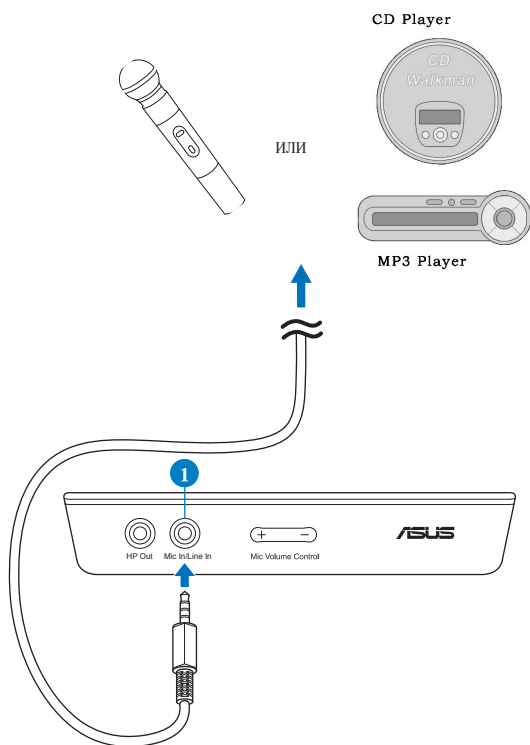

| Нет | Элемент                 | Описание   |
|-----|-------------------------|--|
| 1   | Микрофон /<br>Аудиовход | Предназначен для подключения микрофона для голосовой связи, записи звука или караоке.<br><br>Разъем 3,5 мм предназначен для подключения источника аналогового звука, например CD/MP3 плеера. |

## 4.2 Подключение

### 4.2.1 Подключение стерео наушников

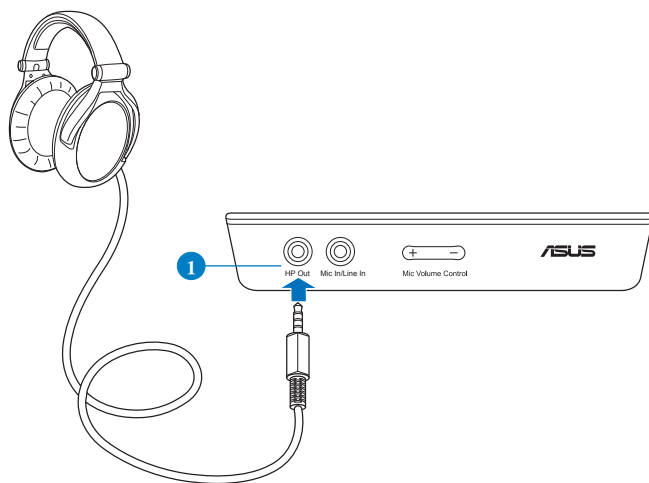

| Нет | Элемент              | Описание  |
|-----|----------------------|---|
| 1   | Разъем для наушников | Разъем для наушников оснащен высококачественным встроенным усилителем. Стереонаушники можно подключить непосредственно к этому разъему. |

## 4.2.2 Подключение 5.1-канальных наушников

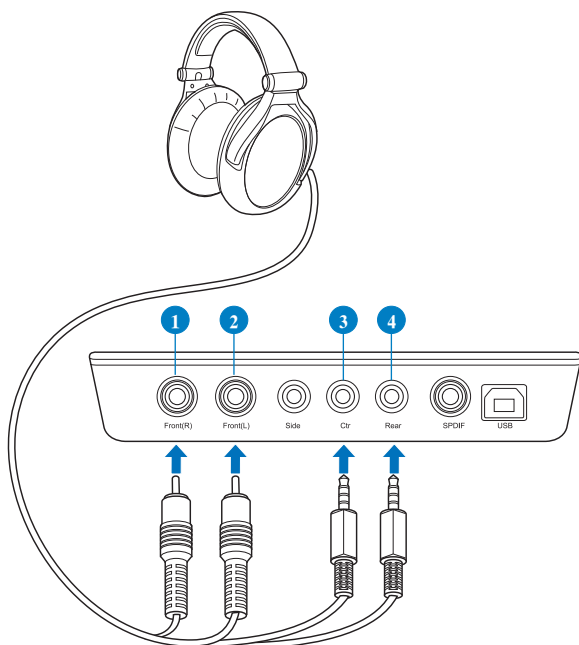

| Нет | Элемент                             | Описание   |
|-----|-------------------------------------|--|
| 1   | Выход правого фронтального канала   | Подключение правого фронтального канала 5.1-канальных наушников. |
| 2   | Выход левого фронтального канала    | Подключение левого фронтального канала 5.1- канальных наушников. |
| 3   | Выход центрального канала/сабвуфера | Подключение центрального канала 5.1-канальных наушников.         |
| 4   | Выход тыловых каналов               | Подключение тылового канала 5.1- канальных наушников.            |

## 4.2.3 Подключение аналоговых колонок

### Подключение 2-канальной акустической системы

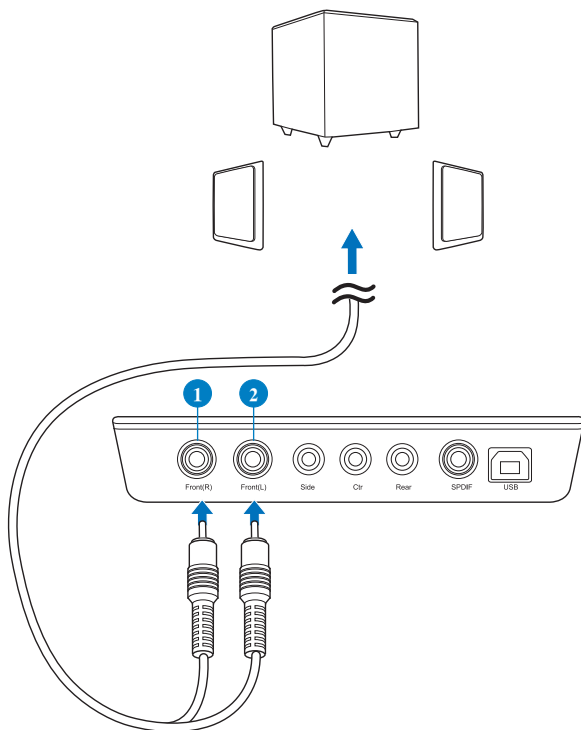

| Нет | Элемент                           | Описание  |
|-----|-----------------------------------|---|
| 1   | Выход правого фронтального канала | Подключение правого фронтального канала колонок 2 - канальной акустической системы. |
| 2   | Выход левого фронтального канала  | Подключение левого фронтального канала колонок 2 - канальной акустической системы.  |

## Подключение 4.1-канальной акустической системы/усилителя

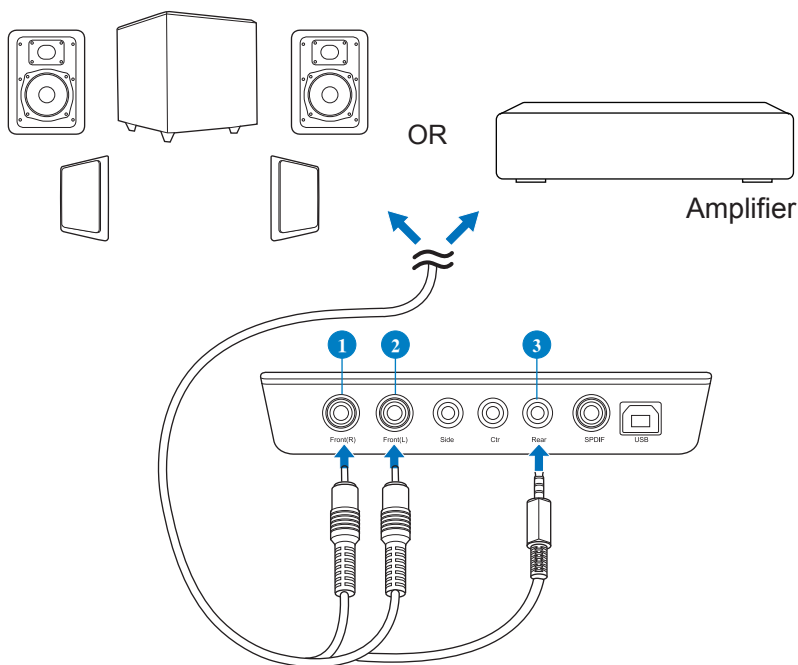

| Нет | Элемент                           | Описание  |
|-----|-----------------------------------|---|
| 1   | Выход правого фронтального канала | Подключение правого фронтального канала 4.1 - канальной акустической системы. |
| 2   | Выход левого фронтального канала  | Подключение левого фронтального канала 4.1 - канальной акустической системы.  |
| 3   | Выход тыловых каналов             | Подключение тыловых колонок 4.1 - канальной акустической системы.             |

## Подключение 5.1-канальной акустической системы

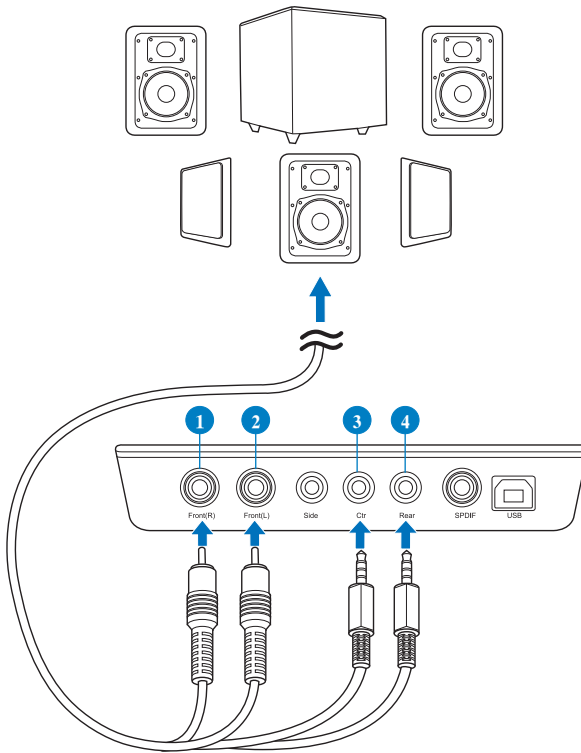

| № | Элемент                             | Описание  |
|---|-------------------------------------|---|
| 1 | Выход правого фронтального канала   | Подключение правого фронтального канала 5.1 - канальной акустической системы.   |
| 2 | Выход левого фронтального канала    | Подключение левого фронтального канала 5.1 - канальной акустической системы.    |
| 3 | Выход центрального канала/сабвуфера | Подключение центральной колонки/сабвуфера 5.1 - канальной акустической системы. |
| 4 | Выход тыловых каналов               | Подключение тыловых колонок 5.1 - канальной акустической системы.               |

## Подключение 7.1-канальной акустической системы

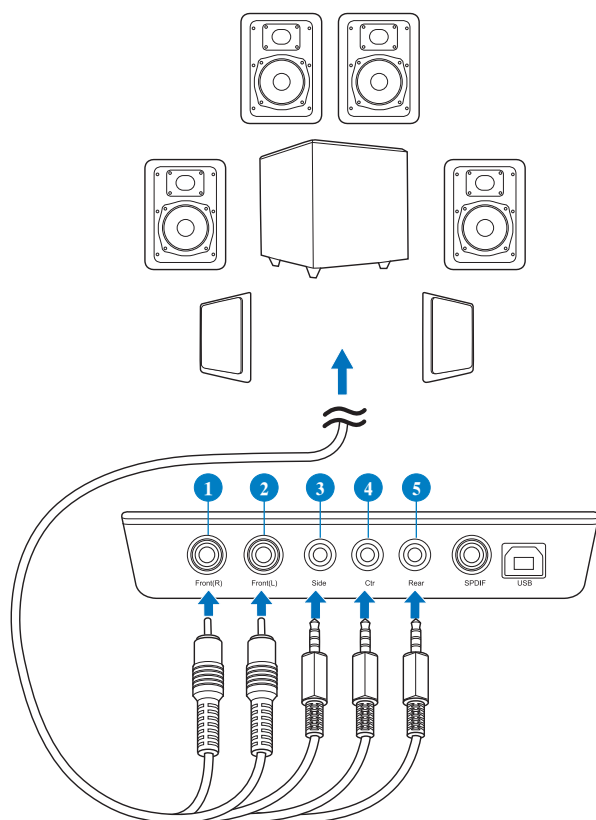

| Нет | Элемент                             | Описание  |
|-----|-------------------------------------|---|
| 1   | Выход правого фронтального канала   | Подключение правого фронтального канала 7.1 - канальной акустической системы.   |
| 2   | Выход левого фронтального канала    | Подключение левого фронтального канала 7.1 - канальной акустической системы.    |
| 3   | Выход на боковые колонки            | Подключение тыловых колонок 7.1 - канальной акустической системы.               |
| 4   | Выход центрального канала/сабвуфера | Подключение центральной колонки/сабвуфера 7.1 - канальной акустической системы. |
| 5   | Выход тыловых каналов               | Подключение тыловых колонок 7.1 - канальной акустической системы.               |



# 1. Introducción

## 1.1 Contenido del paquete

Revise el paquete de la tarjeta de audio ASUS Xonar™ U7 para comprobar que contiene los siguientes elementos:

- Tarjeta de audio USB ASUS Xonar™ U7 con 7.1 canales
- CD con los controladores
- Adaptador óptico TOSLINK S/PDIF
- Guía de inicio rápido

## 1.2 Requisitos del sistema

Antes de instalar la tarjeta de audio Xonar U7, asegúrese de que el equipo cumple los siguientes requisitos:

- PC compatible con IBM, y con un puerto USB1.1 (o superior) libre para conectar la tarjeta de audio USB
- Microsoft® Windows® XP (32/64bit) / Windows® 8 (32/64bits)
- Procesador Intel® Pentium® 4 a 1,4 GHz o AMD Athlon 1400, o un procesador más rápido
- 256 MB de memoria de sistema como mínimo
- 60 MB de espacio de almacenamiento disponible para instalar el controlador
- Unidad de CD-ROM (o DVD-ROM) para instalar el software
- Auriculares de alta calidad, altavoces analógicos con alimentación externa o un decodificador Dolby Digital para disfrutar del sonido de alta fidelidad de la tarjeta de audio

## 2. Hardware

### Tarjeta de audio Xonar U7

#### Vista superior

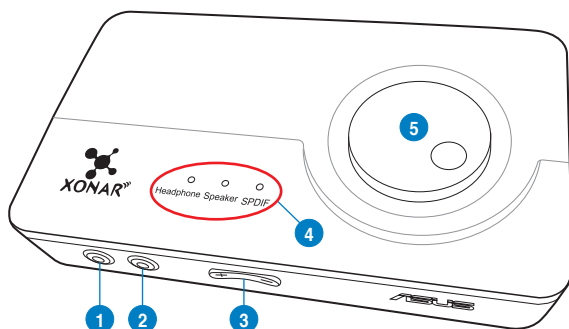

#### Vista posterior

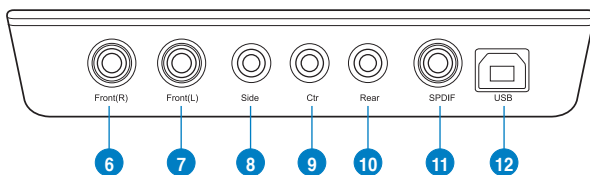

#### Vista inferior

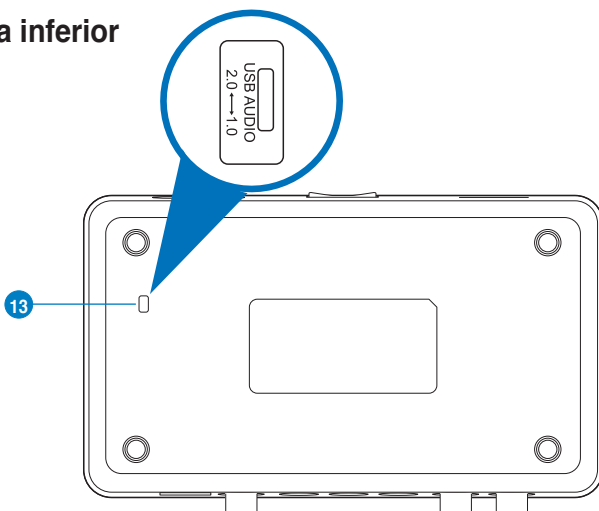

| Nº | Elemento                                   | Descripción  |
|----|--|--|
| 1  | Puerto para Auriculares                    | Conecte los auriculares a este puerto.   |
| 2  | Puerto Entrada de micrófono                | Conecte el micrófono externo de su PC a este puerto de 3,5mm para la entrada de voz. Preamplificador de micrófono de alta calidad integrado.   |
|    | Puerto Entrada de línea                    | Conecte dispositivos analógicos como reproductores MP3, reproductores de CD, sintetizadores de música y otras fuentes de sonido de nivel de línea a este puerto de 3,5 mm para grabar o procesar audio.  |
| 3  | Control de volumen de micrófono            | Permite subir o bajar el volumen del micrófono.  |
| 4  | Indicador de selección de salida           | Muestra las diferentes selecciones de salida: auriculares, altavoz y S/PDIF.   |
| 5  | Selección de salida/<br>Control de volumen | Ajusta el volumen de reproducción. Presiónelo para seleccionar una fuente de salida.   |
| 6  | Puerto para Salida Frontal (derecha)       | Para sistemas de altavoces de 2/4/5.1/7.1 canales, se conecta a la entrada frontal derecha de los altavoces autoamplificados.  |
| 7  | Puerto para Salida Frontal (izquierda)     | Para sistemas de altavoces de 2/4/5.1/7.1 canales, se conecta a la entrada frontal izquierda de los altavoces autoamplificados.  |
| 8  | Puerto de salida envolvente lateral        | Se conecta a la entrada lateral de los sistemas 7.1 externos.  |
| 9  | Puerto de Salida Central/<br>Subwoofer     | Se conecta a la entrada central/subwoofer de los sistemas 5.1/7.1.   |
| 10 | Puerto Salida posterior                    | Se conecta a la entrada Posterior de los sistemas 4/5.1/7.1.   |
| 11 | Puerto Salida S/PDIF/<br>Salida lateral    | Puerto de salida digital coaxial. Permite conectar un descodificador digital externo o sistemas de altavoces digitales, sistemas de cine en casa, receptores de AV para transmitir protocolos digitales como: PCM, Dolby Digital, DTS, WMA-Pro, etc. Conecta a la entrada del canal de sonido envolvente en altavoces analógicos con sistemas 4/5.1/7.1. |
| 12 | Puerto USB                                 | Permite conectar su PC a través de un puerto USB Tipo B-A.   |
| 13 | Conmutador de audio USB 1.0/2.0            | Mueva este conmutador para cambiar entre las conexiones Audio USB 2.0 y Audio USB 1.0. Utilice Audio USB 1.0 para conectar y reproducir. Utilice Audio USB 2.0 en un sistema mac (equipo Apple).   |



El conmutador Audio USB 1.0/2.0 se encuentra situado en el lado inferior de la tarjeta. La conexión Audio USB 1.0 tiene las siguientes limitaciones:

- Solo admite funciones de reproducción.
- Los altavoces 7.1, los auriculares, la entrada de micrófono/entrada de línea y la salida SPDIF solamente admiten tasas de muestreo de 44,1 KHz y 48 KHz a 16 bits.

## 3. Instalación del controlador

### 3.1 Instalación del controlador de la tarjeta Xonar U7

Después de conectar la tarjeta de audio USB externa Xonar U7 con el equipo, es necesario instalar el controlador del dispositivo, que habilita a dicha tarjeta para trabajar con el sistema operativo Windows.



La versión y contenido del CD del controlador pueden verse sujetos a cambios sin previo aviso.

Para instalar el controlador del dispositivo:

1. Inserte el CD de soporte ASUS Xonar U7 en la unidad óptica.  
Si la función de ejecución automática está habilitada, aparecerá automáticamente la pantalla del controlador de la tarjeta ASUS Xonar. Siga con el paso 4. Si la función de ejecución automática no está habilitada en el equipo, continúe con el paso 2.
2. Haga clic en **Computer** en el escritorio y, a continuación, doble clic en el icono de la unidad óptica.
3. Haga doble clic en el icono **setup.exe** ubicado en la unidad óptica.
4. Siga las instrucciones que aparezcan en la pantalla para completar la instalación. Lea el **“CONTRATO DE LICENCIA PARA EL USUARIO FINAL”** que aparecerá durante el proceso de instalación, asegúrese de que lo comprende y acéptelo antes de continuar.
5. Cuando la instalación finalice, es posible que necesite reiniciar el sistema. Si lo desea, también puede reiniciar el sistema en otro momento.

### 3.2 Desinstalación o reinstalación del controlador de la tarjeta Xonar U7

#### 3.2.1 Desinstalación del controlador de la tarjeta Xonar U7

Para desinstalar el controlador de la tarjeta Xonar U7:

1. Haga clic en **Start (Iniciar) > Control Panel (Panel de control) > Programs and Features (Programas y características)**.
2. Haga clic con el botón secundario en el controlador que desee eliminar y, a continuación, haga clic en **Uninstall (Desinstalar)**.
3. En el cuadro de diálogo **InstallShield Wizard (Asistente de InstallShield)**, seleccione la opción **Remove (Quitar)**.
4. Reinicie el equipo cuando el sistema se lo indique.

#### 3.2.2 Reinstalación del controlador de la tarjeta Xonar U7

Para reinstalar el controlador de la tarjeta Xonar U7:

1. Desinstale el software o controlador existente.
2. Siga el proceso de instalación para reinstalar el controlador.

## 4. Conexión de altavoces y periféricos

### 4.1 Conexión de entrada

#### 4.1.1 Conexión al equipo mediante un puerto USB 2.0

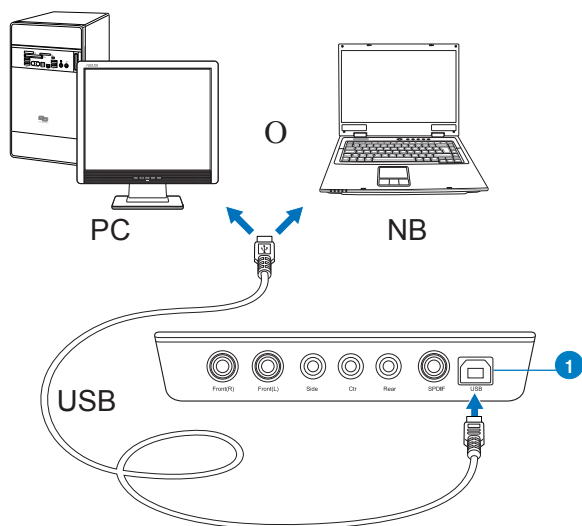

| Nº | Elemento   | Descripción  |
|----|------------|--|
| 1  | Puerto USB | Permite conectar su PC a través de un terminal USB Tipo B-A. |

## 4.1.2 Conexión con sistemas de audio digitales

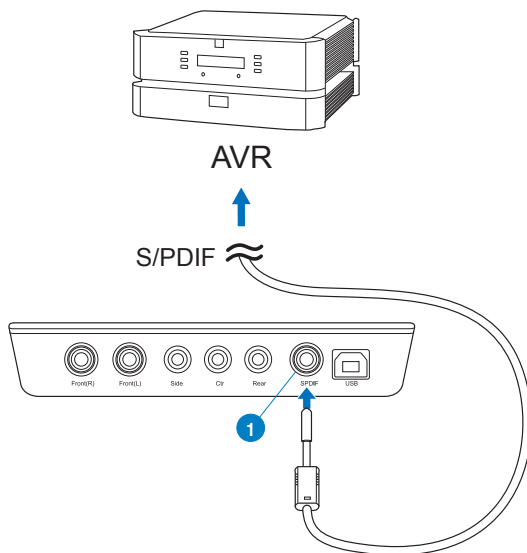

| Nº | Elemento                             | Descripción   |
|----|--------------------------------------|---|
| 1  | Puerto Salida S/ PDIF/Salida lateral | Conecte un receptor de audio y vídeo (AVR, Audio/ Video Receiver) a este puerto de salida S/PDIF. |

### 4.1.3 Conexión del micrófono o la entrada de línea

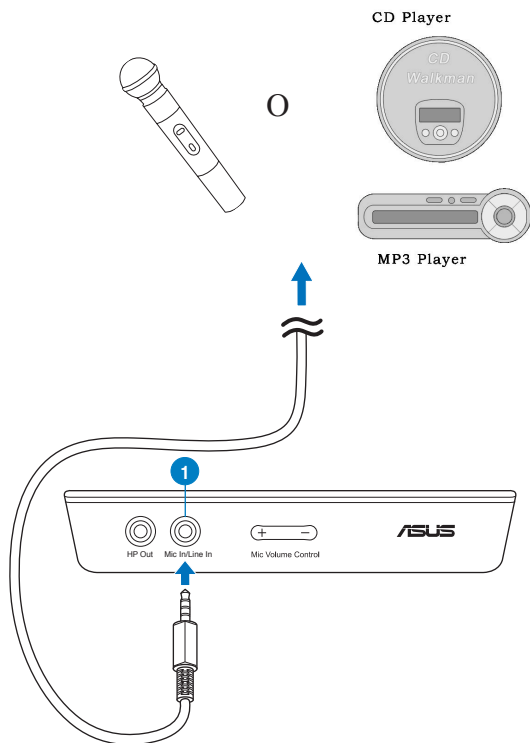

| Nº | Elemento  | Descripción   |
|----|---|---|
| 1  | <b>Puerto Entrada de micrófono / Entrada de línea</b> | <p>Conecte el enchufe de 3,5 mm en el puerto Entrada de micrófono para comunicaciones de voz, grabaciones o karaoke.</p> <p>Conecte el enchufe de 3,5 mm del reproductor de CD/MP3 o cualquier otra fuente de audio analógica de nivel de línea en el puerto Entrada de línea para grabar sonido.</p> |

## 4.2 Conexión de salida

### 4.2.1 Conexión de unos auriculares estéreo

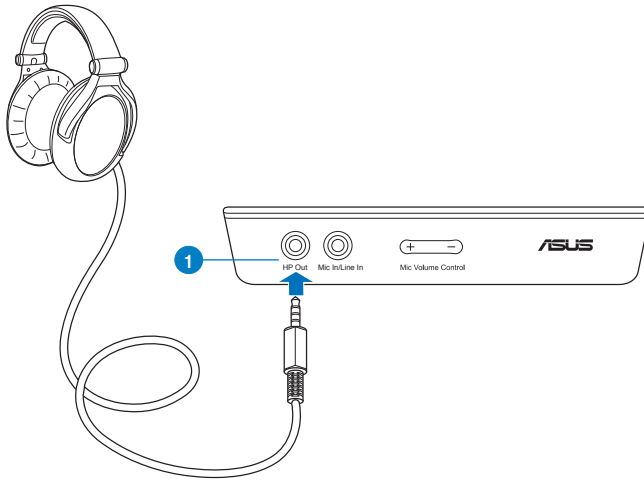

| Nº | Elemento                | Descripción  |
|----|-------------------------|--|
| 1  | Puerto para Auriculares | El puerto Salida de auriculares integra un amplificador de auriculares de alta calidad. Conecte sus auriculares estéreo directamente a este puerto |



## 4.2.2 Conexión auriculares 5.1

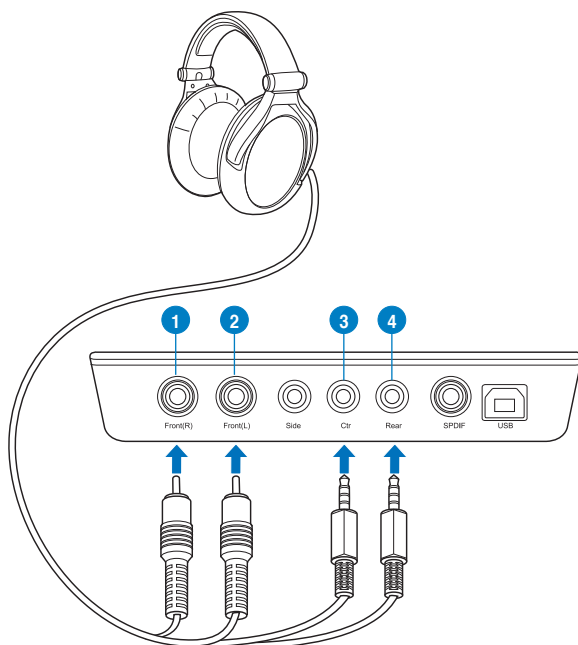

| Nº | Elemento  | Descripción   |
|----|---|---|
| 1  | <b>Puerto para Salida Frontal (derecha)</b>       | Permite conectar el puerto de entrada frontal derecho de los auriculares 5.1 vía un cable RCA.    |
| 2  | <b>Puerto para Salida Frontal (izquierda)</b>     | Permite conectar el puerto de entrada frontal izquierdo de los auriculares 5.1 vía un cable RCA.  |
| 3  | <b>Puerto de Salida Central/Altavoz de Graves</b> | Permite conectar los canales central y de graves de los auriculares 5.1 vía un conector minijack. |
| 4  | <b>Puerto Salida envolvente posterior</b>         | Permite conectar la entrada envolvente posterior de los auriculares 5.1 vía un conector minijack. |

## 4.2.3 Conexión de sistemas de altavoces analógicos

### Conectar altavoces estéreo

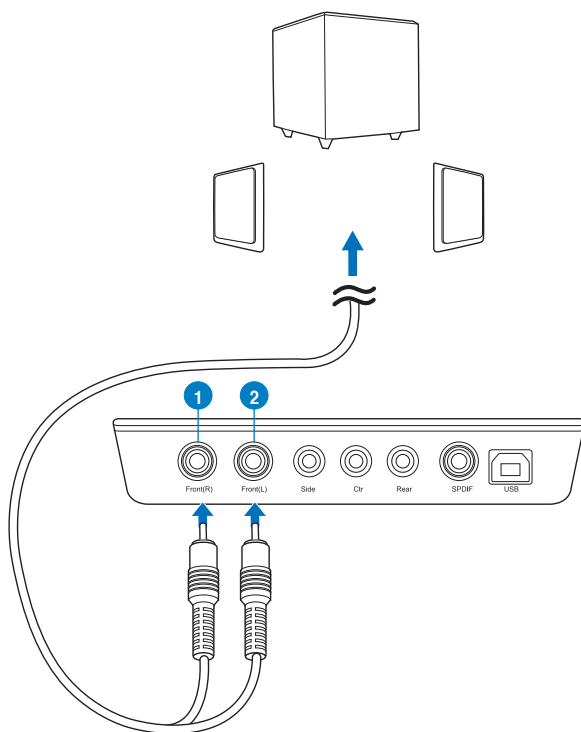

| Nº | Elemento                                      | Descripción   |
|----|---|---|
| 1  | <b>Puerto para Salida Frontal (derecha)</b>   | Permite conectar la entrada frontal derecha de los altavoces estéreo vía un conector RCA.   |
| 2  | <b>Puerto para Salida Frontal (izquierda)</b> | Permite conectar la entrada frontal izquierda de los altavoces estéreo vía un conector RCA. |

## Conexión de los altavoces 4.1 y el amplificador de potencia

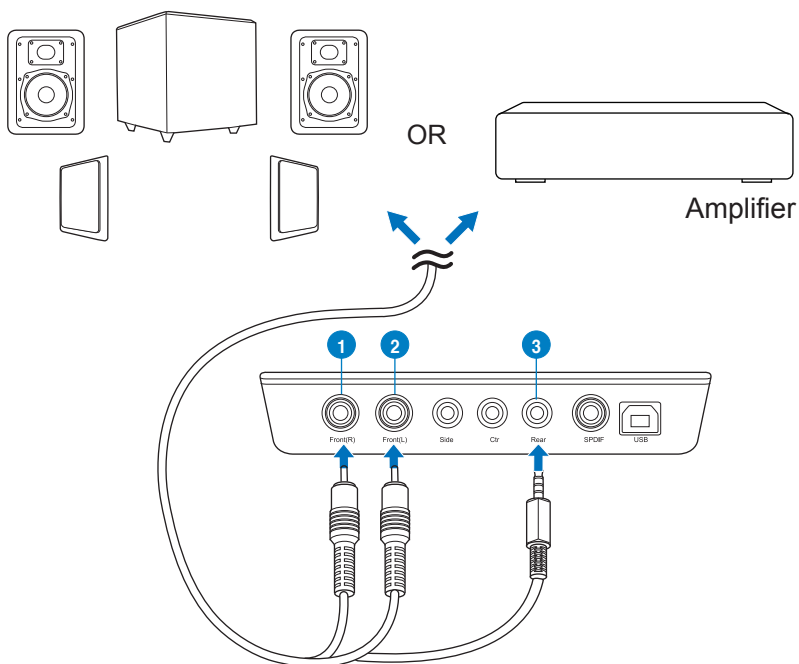

| Nº | Elemento                                      | Descripción  |
|----|---|--|
| 1  | <b>Puerto para Salida Frontal (derecha)</b>   | Permite conectar el puerto de entrada frontal derecho de los altavoces 4.1.      |
| 2  | <b>Puerto para Salida Frontal (izquierda)</b> | Permite conectar el puerto de entrada frontal izquierdo de los altavoces 4.1.    |
| 3  | <b>Puerto Salida envolvente posterior</b>     | Permite conectar el puerto de entrada envolvente posterior de los altavoces 4.1. |

## Conexión de los altavoces 5.1 y el amplificador de potencia

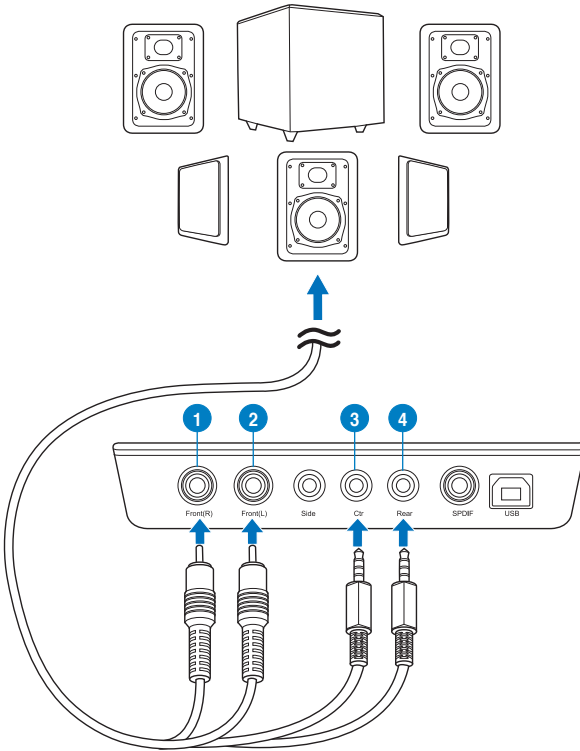

| Nº | Elemento                               | Descripción   |
|----|--|---|
| 1  | Puerto para Salida Frontal (derecha)   | Permite conectar el puerto de entrada frontal derecho de los altavoces 5.1.       |
| 2  | Puerto para Salida Frontal (izquierda) | Permite conectar el puerto de entrada frontal izquierdo de los altavoces 5.1.     |
| 3  | Puerto de Salida Central/Subwoofer     | Permite conectar los puertos de entrada Central y Subwoofer de los altavoces 5.1. |
| 4  | Puerto Salida envolvente posterior     | Permite conectar el puerto de entrada envolvente posterior de los altavoces 5.1.  |

## Conectar altavoces de 7.1 canales y el amplificador de potencia

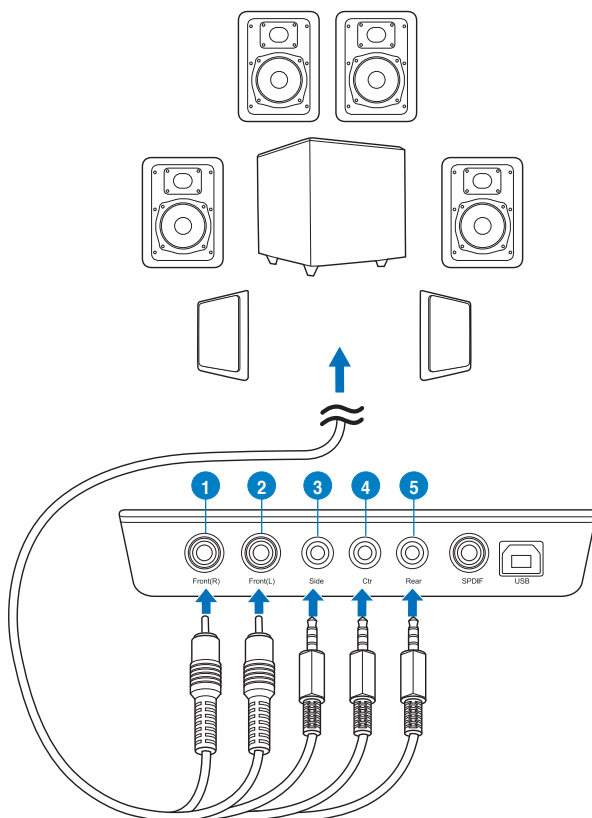

| Nº | Elemento                                   | Descripción   |
|----|--|---|
| 1  | Puerto para Salida Frontal (derecha)       | Permite conectar el puerto de entrada frontal derecho de los altavoces 7.1.                   |
| 2  | Puerto para Salida Frontal (izquierda)     | Permite conectar el puerto de entrada frontal izquierdo de los altavoces 7.1.                 |
| 3  | Puerto de salida envolvente lateral        | Permite conectar las entradas Envolvente izquierdo y Envolvente derecho de los altavoces 7.1. |
| 4  | Puerto de Salida Central/Altavoz de Graves | Permite conectar la entrada Central/Subwoofer de los altavoces 7.1.                           |
| 5  | Puerto Salida envolvente posterior         | Permite conectar la entrada envolvente posterior de los altavoces 7.1.                        |

# 1. Giriş

## 1.1 Paket içeriği

ASUS Xonar™ U7 ses kartı paketinizde aşağıdaki öğelerin bulunup bulunmadığını denetleyin:

- ASUS Xonar™ U7 7.1-Kanallı USB Ses Kartı
- Sürücü CD'si
- S/PDIF TOSLINK optic bağdaştırıcı x1
- Hızlı Başlangıç Kılavuzu

## 1.2 Sistem gereksinimleri

Xonar™ U7 ses kartını takmadan önce, bilgisayarınızın aşağıdaki gereksinimleri karşıladığından emin olun:

- Bir USB1.1 portlu IBM uyumlu PC (veya üstü) USB ses aygıtı ile uyumlu port
- Microsoft® Windows® XP (32/64bit) / Windows® 7 (32/64bit) / Windows® 8 (32/64bit)
- Intel® Pentium® 4 1.4GHz veya AMD Athlon 1400 CPU veya daha hızlı CPU
- 256 MB'dan fazla sistem belleği
- Sürücü kurulumu için 60 MB'dan fazla kullanılabilir depolama alanı
- Yazılım kurulumu için CD-ROM sürücüsü (veya DVD-ROM sürücüsü)
- Ses kartının yüksek doğruluktaki sesinin keyfini çıkarmak için yüksek kalitede kulaklıklar, güç verilmiş analog hoparlörler veya bir Dolby Digital dekoder

## 2. Donanım

### Xonar U7 Ses Kartı

#### Üstten görünüş

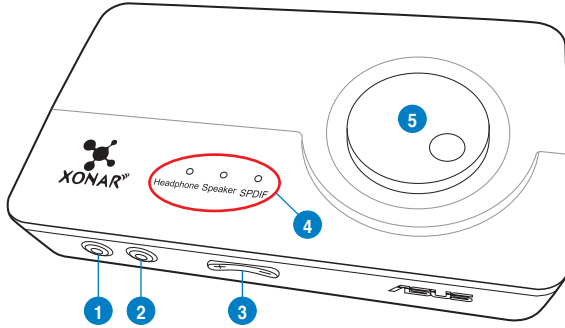

#### Arkadan görünüm

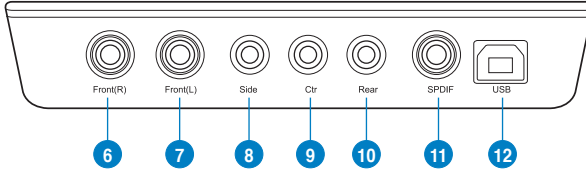

#### Alt görünüm

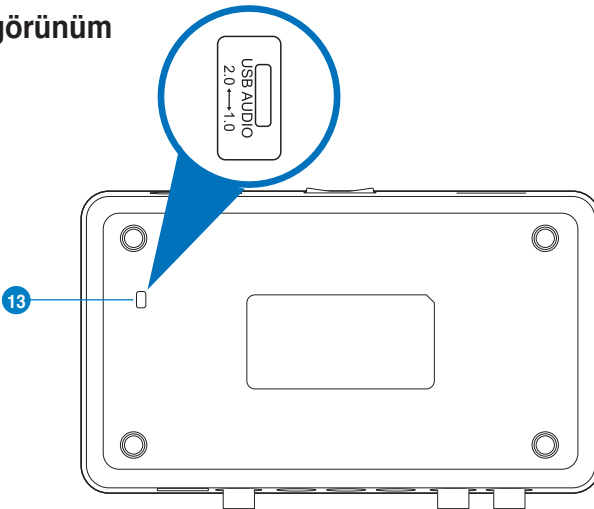

| No | Öge                                      | Açıklama   |
|----|--|--|
| 1  | Kulaklık Çıkış portu                     | Kulaklığınızı bu bağlantı noktasına bağlayın.  |
| 2  | Mikrofon Giriş portu                     | Harici PC mikrofonunuzu ses girişi için olan bu 3,5mm'lik porta bağlayın. Yerleşik yüksek kalitede Mikrofon ön amplifikatörü.  |
|    | Hat Giriş portu                          | Ses kaydetmek veya işlemek için MP3 çalar, CD çalar, müzik synthesizer'ı ve diğer hat düzeyi ses kaynaklarını bu 3,5mm porta bağlayın.   |
| 3  | Mikrofon Ses Kontrolü                    | Mikrofon sesini artırmak veya azaltmak için basın.   |
| 4  | Çıkış Seçimi Göstergesi                  | LED göstergesi farklı çıkış seçimini gösterir (Kulaklık/Hoparlör/S/PDIF).  |
| 5  | Çıkış Seçimi/Ses Kontrolü                | Oynatma ses seviyesini ayarlamak için döndürün. Bir çıkış kaynağı seçmek için basın.   |
| 6  | Ön Çıkış portu (sağ)                     | 2/4/5.1/7.1 kanallı hoparlör sistemleri için, elektrikli hoparlörlerin ön sağ girişine bağlanır.   |
| 7  | Ön Çıkış portu (sol)                     | 2/4/5.1/7.1 kanallı hoparlör sistemleri için, elektrikli hoparlörlerin ön sol girişine bağlanır.   |
| 8  | Yan Surround Çıkış bağlantı noktası      | 7.1 elektrikli analog hoparlörlerin surround kanal girişine bağlanır.  |
| 9  | Merkez/Subwoofer Çıkış portu             | 5.1/7.1 elektrikli analog hoparlörlerin merkez/subwoofer girişine bağlanır.  |
| 10 | Arka Çıkış bağlantı noktası              | 4/5.1/7.1 elektrikli analog hoparlörlerin Arka Surround girişine bağlanır.   |
| 11 | S/PDIF Çıkışı/Yan Çıkış bağlantı noktası | Optik TOSLINK dijital çıkış portu. Harici dijital dekoder veya dijital hoparlör sistemlerine, Ev Sinema sistemlerine, PCM, Dolby Digital, DTS, WMA-Pro, vs. gibi dijital ses çıkışı AV alıcılarına bağlanır. 4/5.1/7.1 elektrikli analog hoparlörlerin surround kanal girişine bağlanır. |
| 12 | USB Bağlantı Noktası                     | Bir USB Tipi B-A ucunu kullanarak bilgisayarınıza bağlanın.  |
| 13 | USB Audio 1.0/2.0 anahtarı               | USB Audio 2.0 ve USB Audio 1.0 bağlantısı arasında geçiş yapmak için bu anahtarı hareket ettirin. Tak ve çalıştır için USB Audio 1.0 kullanın. Bir mac (Apple) bilgisayarda USB Audio 2.0 kullanın.  |



USB Audio 1.0/2.0 anahtarı ses kartının alt kısmına yerleştirilmiştir. USB Audio 1.0 bağlantısında aşağıdaki sınırlandırmalar vardır:

- Sadece oynatma özelliklerini destekler.
- 7.1 hoparlör, Kulaklık, Mik Girişi/ Hat girişi ve SPDIF Çıkışı sadece 44.1KHz / 48KHz @16-bit değerindeki örnekleme hızlarını destekleyebilir.



## 3. Sürücü kurulumu

### 3.1 Xonar U7 Kart Sürücüsünü takma

Xonar U7 harici USB ses kartını bilgisayarınıza taktıktan sonra, Xonar U7 ses kartının Windows işletim sistemi ile çalışmasına olanak sağlayan aygıt sürücüsünü kurmanız gereklidir.



Sürücü CD'sinin sürümü ve içeriği önceden haber verilmeden değiştirilebilir.

Aygıt sürücüsünü kurmak için:

1. ASUS Xonar U7 destek CD'sini optik sürücünüze yerleştirin.  
Autorun etkinse, ASUS Xonar Kart Sürücüsü ekranı kendiliğinden açılır. Adım 4'e gidin.  
Autorun bilgisayarınızda etkinleştirilmemişse, Adım 2'ü yerine getirin.
2. Masaüstünüzden **Bilgisayarım**'a tıklayın ve optik sürücü simgesine çift tıklayın.
3. Optik sürücüye yerleştirilen setup.exe simgesine çift tıklayın.
4. Kurulumu tamamlamak için ekranda verilen talimatları yerine getirin. “**SON KULLANICI LİSANS SÖZLEŞMESİ**”'ni okuyun ve kurulumla devam etmeden önce sözleşmeyi anladığınızdan emin olun ve kabul edin.
5. Kurulum tamamlandığında, bilgisayarınızı yeniden başlatmanız istenebilir. İsterseniz bilgisayarı yeniden başlatmayı seçebilirsiniz.

### 3.2 XonarTM U7 Kartı Sürücüsünü Çıkarma ve Yeniden Takma

#### 3.2.1 XonarTM U7 Kart Sürücüsünün Kurulumunu Kaldırma

XonarTM U7 kartı sürücünüzün kurulumunu kaldırmak için:

1. **Start (Başlat) > Control Panel (Denetim Masası) > Programs and Features (Programlar ve Özellikler)** üzerine tıklayın.
2. Kaldırmak istediğiniz sürücüye sağ tıklayın ve ardından **Uninstall (Kurulumu kaldır)** üzerine tıklayın.
3. **InstallShield Wizard (InstallShield Sihirbazı)** iletişim kutusunda, **Remove (Kaldır)** seçeneğini belirleyin.
4. Uyarı verildiğinde bilgisayarınızı yeniden başlatın.

#### 3.2.2 XonarTM U7 Kart Sürücüsünün Tekrar Kurulması

XonarTM U7 kartı sürücünüzü tekrar kurmak için:

1. Kurulu olan mevcut yazılımı veya sürücüyü kaldırın.
2. Sürücüyü tekrar kurmak için kurulum sürecini izleyin.

## 4. Hoparlör ve Çevre Birimlerinin Bağlanması

### 4.1 Giriş bağlantısı

#### 4.1.1 Bilgisayarınızdaki bir USB 2.0 bağlantı noktasına bağlama

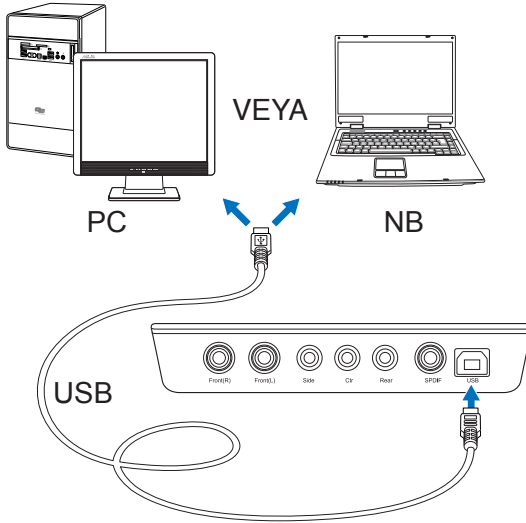

| No | Öğe                  | Açıklama  |
|----|----------------------|---|
| 1  | USB Bağlantı Noktası | Bir USB Tipi B-A ucunu kullanarak bilgisayarınıza bağlanın. |

## 4.1.2 Dijital ses sistemlerine bağlama

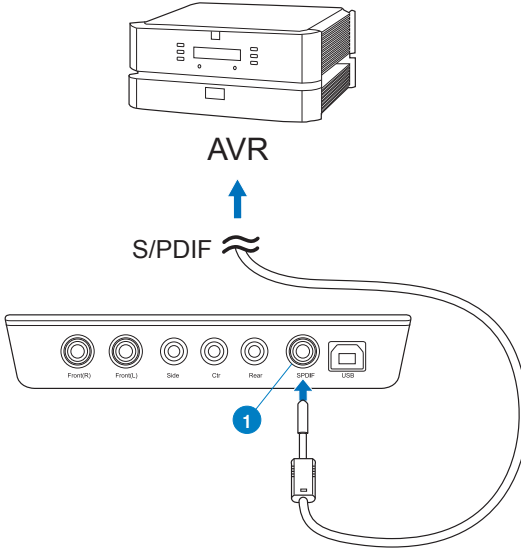

| No | Öğe                                      | Açıklama  |
|----|--|---|
| 1  | S/PDIF Çıkışı/Yan Çıkış bağlantı noktası | Bir AVR (Audio/Video Alıcısı)'nı bu S/PDIF çıkış bağlantı noktasına bağlayın. |

### 4.1.3 Mikrofonu / Hat Girişine bağlama

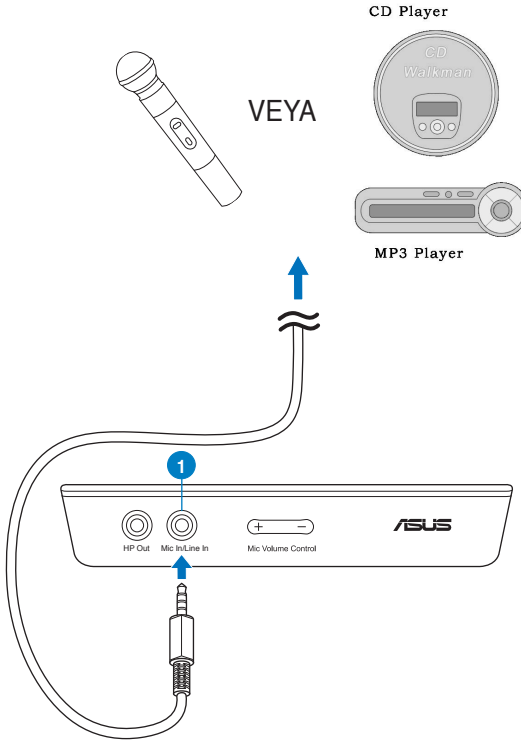

| No | Öge   | Açıklama  |
|----|---|---|
| 1  | Mikrofon Girişi/<br>Hat Girişi bağlantı noktası | Mikrofonun 3,5 mm'lik fişini ses iletişimi, kaydı veya karaoke için bu Mik girişi bağlantı noktasına bağlayın.<br>CD/MP3 Oynatıcısının veya diğer herhangi bir Hat seviyesi analog ses kaynağının 3,5 mm fişini ses kaydı için bu Hat girişi bağlantı noktasına bağlayın. |

## 4.2 Çıkış bağlantısı

### 4.2.1 Stereo Hoparlörleri Bağlama

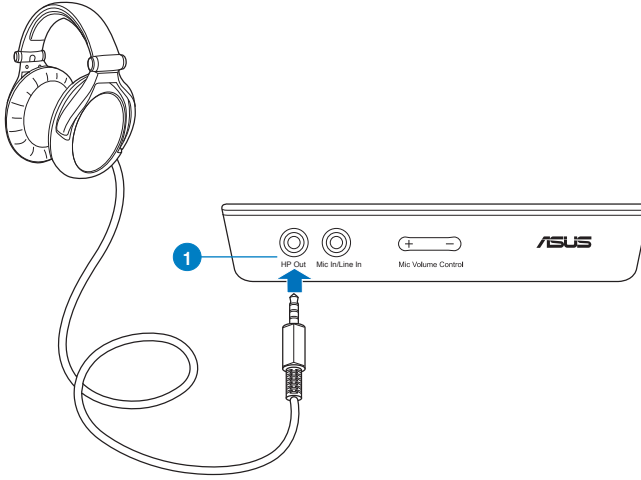

| No | Öğe                  | Açıklama  |
|----|----------------------|---|
| 1  | Kulaklık Çıkış portu | Kulaklık Çıkışı bağlantı noktasında kulaklıkların sürücülerini için yerleşik yüksek kalitede amplifikatör bulunmaktadır. Stereo kulaklıklarınızı doğrudan bu bağlantı noktasına bağlayın. |

## 4.2.2 5.1 kanal kulaklıklarını bağlama

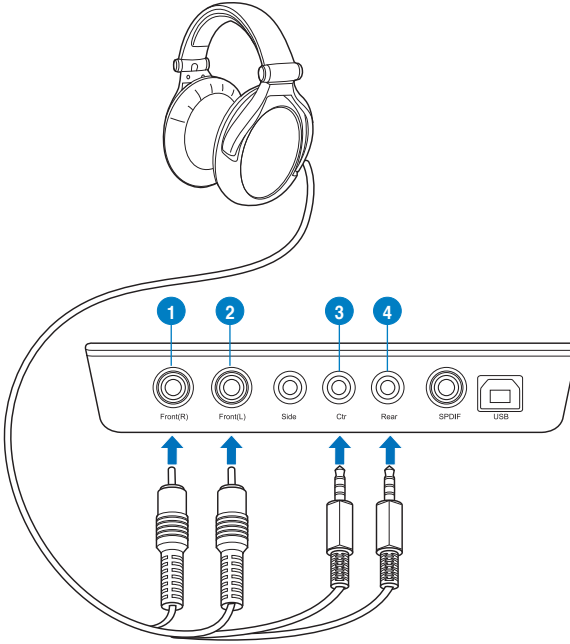

| No | Öge                                  | Açıklama   |
|----|--------------------------------------|--|
| 1  | Ön Çıkış portu (sağ)                 | RCA kablosunu kullanarak 5.1 kanallı kulaklıkların ön sağ giriş bağlantı noktasına bağlanır. |
| 2  | Ön Çıkış portu (sol)                 | RCA kablosunu kullanarak 5.1 kanallı kulaklıkların ön sol giriş bağlantı noktasına bağlanır. |
| 3  | Merkez/Subwoofer Çıkış portu         | 5.1 kanallı kulaklığınızın Orta/Bas kanalı 3.5mm fişini bu jake bağlayın.                    |
| 4  | Arka Surround Çıkış bağlantı noktası | 5.1 kanal kulaklığınızın arka surround giriş bağlantı noktasına bağlayın.                    |

### 4.2.3 Analog hoparlör sistemlerinin bağlanması

#### 2 kanallı hoparlörleri bağlama

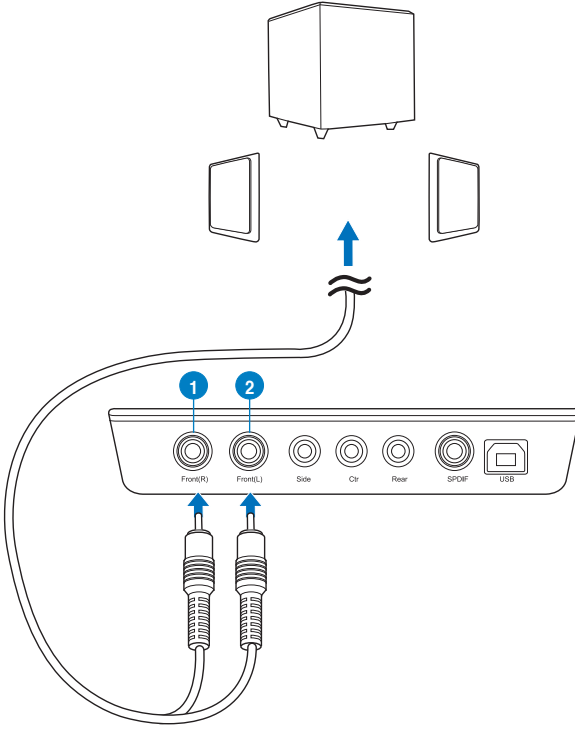

| No | Öge                  | Açıklama   |
|----|----------------------|--|
| 1  | Ön Çıkış portu (sağ) | RCA kablosunu kullanarak 2 kanallı kulaklıkların ön sağ giriş bağlantı noktasına bağlanır. |
| 2  | Ön Çıkış portu (sol) | RCA kablosunu kullanarak 2 kanallı kulaklıkların ön sol giriş bağlantı noktasına bağlanır. |

#### 4.1 kanallı hoparlörleri / güç amplifikatörlerini bağlama

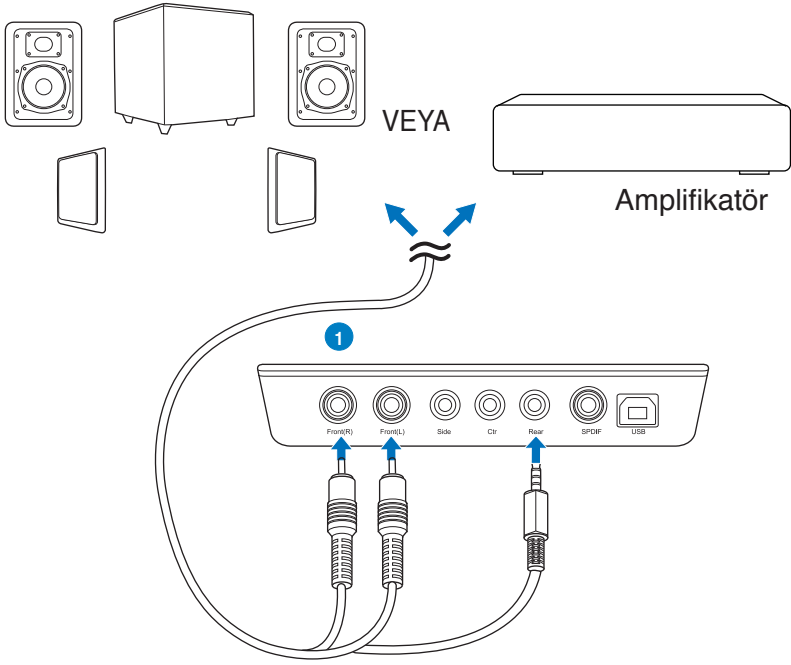

| No | Öge                                  | Açıklama  |
|----|--------------------------------------|---|
| 1  | Ön Çıkış portu (sağ)                 | 4.1 kanal hoparlörlerinin ön sağ giriş bağlantı noktasına bağlar.         |
| 2  | Ön Çıkış portu (sol)                 | 4.1 kanal hoparlörlerinin ön sol giriş bağlantı noktasına bağlar.         |
| 3  | Arka Surround Çıkış bağlantı noktası | 4.1 kanal kulaklığınızın arka surround giriş bağlantı noktasına bağlayın. |



## 5.1 kanallı hoparlörleri bağlama

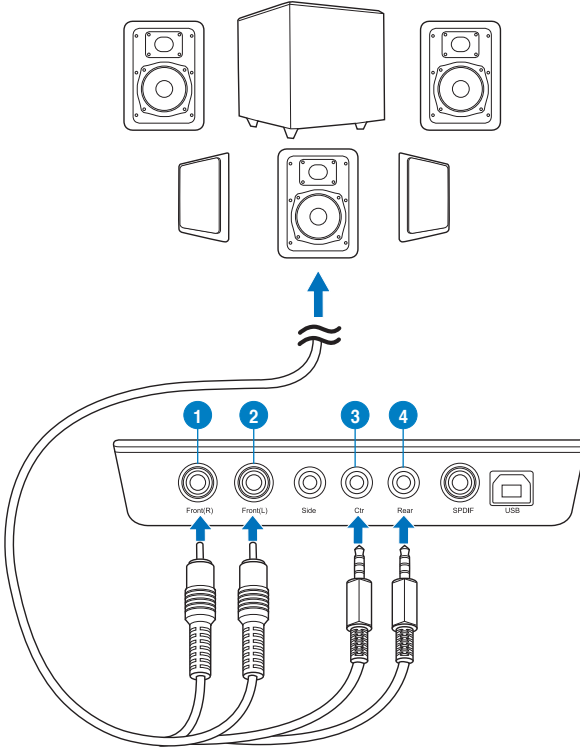

| No | Öge                                  | Açıklama  |
|----|--------------------------------------|---|
| 1  | Ön Çıkış portu (sağ)                 | Mini jak kablosu kullanarak 5.1 kanallı hoparlörlerin ön sağ giriş bağlantı noktasını bağlar. |
| 2  | Ön Çıkış portu (sol)                 | Mini jak kablosu kullanarak 5.1 kanallı hoparlörlerin ön sol giriş bağlantı noktasını bağlar. |
| 3  | Merkez/Subwoofer Çıkış portu         | 5.1 kanallı hoparlörlerin Orta ve Subwoofer giriş bağlantı noktalarına bağlar.                |
| 4  | Arka Surround Çıkış bağlantı noktası | 5.1 kanal kulaklığınızın arka surround giriş bağlantı noktasına bağlayın.                     |

## 7.1 kanallı hoparlörleri bağlama

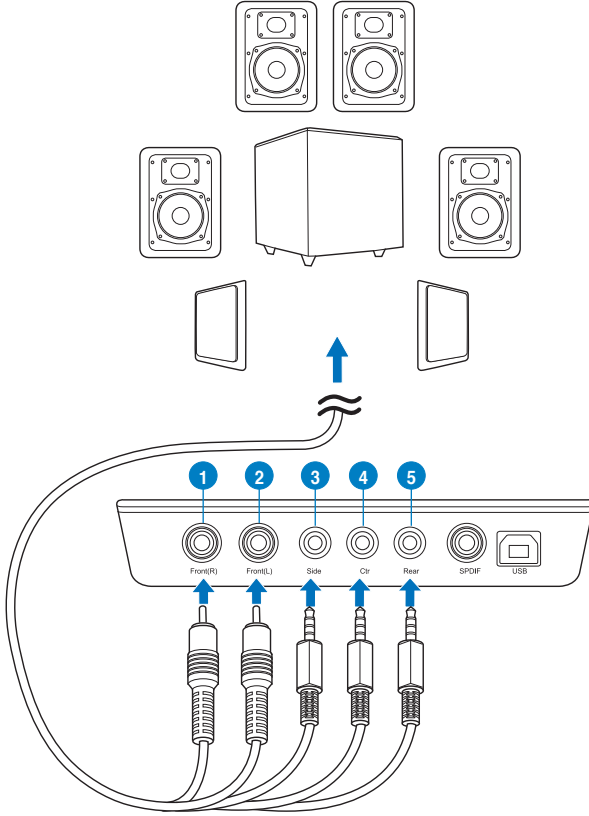

| No | Öğe                                  | Açıklama  |
|----|--------------------------------------|---|
| 1  | Ön Çıkış portu (sağ)                 | Mini jak kablosu kullanarak 7.1 kanallı hoparlörlerin ön sağ giriş bağlantı noktasını bağlar.         |
| 2  | Ön Çıkış portu (sol)                 | Mini jak kablosu kullanarak 7.1 kanallı hoparlörlerin ön sol giriş bağlantı noktasını bağlar.         |
| 3  | Çıkış Seçimi Göstergesi              | 7.1 kanallı hoparlörlerin Sol surround ve Sağ surround giriş bağlantı noktalarına bağlanır.           |
| 4  | Merkez/Subwoofer Çıkış portu         | Mini jak kablosu kullanarak 7,1 kanallı hoparlörlerin Orta/Subwoofer giriş bağlantı noktasını bağlar. |
| 5  | Arka Surround Çıkış bağlantı noktası | 7.1 kanal kulaklığınızın arka surround giriş bağlantı noktasına bağlayın.                             |

# 1. Uvod

## 1.1 Sadržaj pakiranja

Provjerite sadrži li pakiranje ASUS Xonar U7 audio zvučne kartice sljedeće stavke:

- ASUS Xonar™ U7 7.1-Channel USB Audio kartica
- CD s upravljačkim programom
- 1 S/PDIF TOSLINK optički adapter
- Vodič za brzi početak rada

## 1.2 Sadržaj pakiranja

Da bi se osigurala uspješna ugradnja Xonar U7 audio kartice, vaše računalo mora zadovoljiti sljedeće uvjete:

- IBM kompatibilno računalo s jednim USB 1.1 (ili više) kompatibilnim priključkom za USB zvučni uređaj
- Microsoft® Windows® XP (32/64-bitni) / Windows® 7 (32/64-bitni) / Windows® 8 (32/64-bitni)
- Intel® Pentium® 4 1,4 GHz ili AMD® Athlon 1400 CPU ili brži procesor
- 256 MB (ili više) DRAM memorije sustava
- 60 MB dostupnog prostora tvrdog diska za instalaciju paketa upravljačkih programa
- CD-ROM pogon (ili DVD-ROM pogon) za instalaciju softvera
- Visokokvalitetne slušalice ili analogni zvučnici s pojačalom za uživanje u vrlo visokoj kakvoći zvuka kartice

## 2. Hardver

### Xonar U7 zvučna kartica

#### Pogled s gornje strane

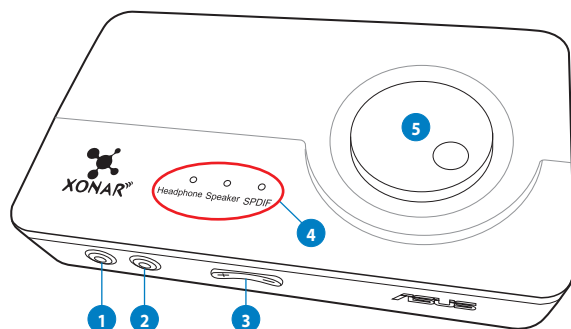

#### Pogled sa stražnje strane

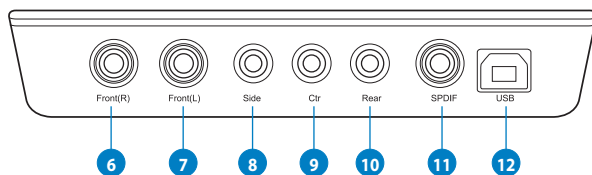

#### Pogled s donje strane

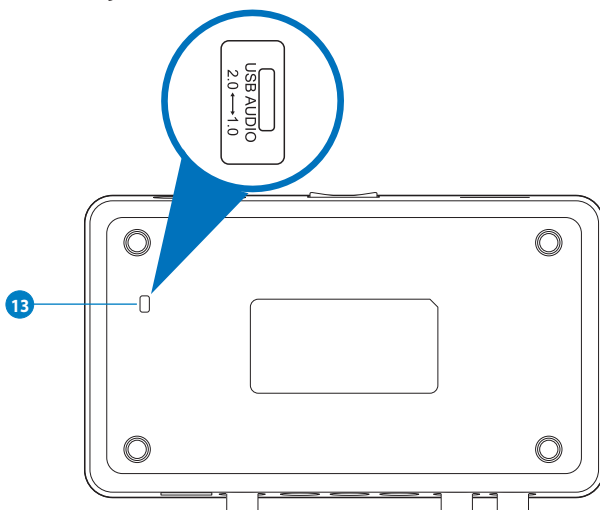

| No. | Stavka                                    | Opis   |
|-----|---|--|
| 1   | Izlazni priključak slušalica              | Priključite slušalice na ovaj priključak.  |
| 2   | Ulazni priključak za mikrofona            | Spojite vanjski mikrofona računala na ovaj priključak od 3,5 mm za ulaz zvuka..Ugrađeno visokokvalitetno predpojačalo mikrofona.   |
|     | Linijski ulazni priključak                | Spojite analogne uređaje kao što su MP3 playeri, CD playeri, glazbeni sintetizatori i ostali izvori zvuka na linijskoj razini na ovaj priključak od 3,5 mm za snimanje ili obradu zvuka.   |
| 3   | Regulacija glasnoće mikrofona             | Pritisnite za povećavanje ili smanjivanje glasnoće mikrofona.  |
| 4   | Indikator odabranog izlaza                | LED indikator pokazuje različite odabire izvora (slušalice/zvučnik/S/PDIF).  |
| 5   | Odabir izlaza/regulator glasnoće          | Okrećite za prilagođavanje glasnoće reprodukcije. Pritisnite za odabir izvora izlaza.  |
| 6   | Priključak prednjeg (D) izlaza            | Za sustave zvučnika s 2/4/5.1/7.1 kanala, spojite na prednji desni ulaz zvučnika s pojačalom.  |
| 7   | Priključak prednjeg (L) izlaza            | Za sustave zvučnika s 2/4/5.1/7.1 kanala, spojite na prednji lijevi ulaz zvučnika s pojačalom.   |
| 8   | Priključak bočnog izlaza prostornog zvuka | Spaja se na ulaz kanalnog prostornog zvuka na 7.1 analognim zvučnicima s pojačalom.  |
| 9   | Priključak izlaza srednjeg/bas zvučnika   | Spaja se na ulaz srednjeg/bas zvučnika na 5.1/7.1 analognim zvučnicima s pojačalom.  |
| 10  | Stražnji izlazni priključak               | Spaja se na stražnji ulaz prostornog zvuka na 4/5.1/7.1 analognim zvučnicima s pojačalom.  |
| 11  | S/PDIF izlazni/bočni priključak           | Digitalni izlazni priključak. Spaja se na vanjski digitalni dekoder ili sustave digitalnih zvučnika, sustave za kućno kino, AV prijemnike za reprodukciju digitalnog zvuka, uključujući PCM, Dolby Digital, DTS, WMA-Pro, itd. Spaja se na ulaz kanala prostornog zvuka na 5.1 analognim zvučnicima s pojačalom. |
| 12  | USB priključak                            | Spaja se na računalo pomoću USB kabela vrste B-A.  |
| 13  | USB Audio 1.0/2.0 preklopnik              | Prebacite ovaj preklopnik radi prijelaza između USB Audio 2.0 i USB Audio 1.0 veze. Koristite USB Audio 1.0 za funkciju plug and play (utakni i koristi) Koristite USB Audio 2.0 na Mac (Apple) računalu.  |



USB Audio 1.0/2.0 preklopnik nalazi se s donje strane zvučne kartice. USB Audio 1.0 veza ima sljedeća ograničenja:

- Podržava samo funkciju reprodukcije.
- 7.1 zvučnici, slušalice, ulaz mikrofona/linijski ulaz i SPDIF izlaz podržavaju samo brzine uzorkovanja od 44,1 kHz/48 kHz pri 16-bitu

## 3. Instalacija upravljačkih programa

### 3.1 Instalacija upravljačkog programa Xonar U7 kartice

Nakon ugradnje zvučne kartice Xonar DX na računalo, potrebno je instalirati upravljački program uređaja koji omogućuje da zvučna kartica Xonar DX radi s operativnim sustavom Windows.



Verzija i sadržaj CD-a za podršku mogu se promijeniti bez prethodne obavijesti.

Instalacija upravljačkog programa uređaja:

1. Stavite ASUS Xonar U7 CD za podršku u optički pogon.  
Ako je automatsko pokretanje omogućeno, zaslon ASUS Xonar Card Driver (upravljački program ASUS Xonar kartice) pojavit će se automatski. Idite na korak 4.  
Ako automatsko pokretanje nije omogućeno na računalu, provedite korak 2.
2. Kliknite **My Computer (Moje računalo)** na radnoj površini i dvaput kliknite ikonu optičkog diska.
3. Dvaput kliknite ikonu **setup.exe** koja se nalazi na optičkom pogonu.
4. Slijedite upute na zaslonu za dovršavanje instalacije. Pročitajte „**END USER LICENSE AGREEMENT**“ (**Licencni ugovor s krajnjim korisnikom**) u postupku i pobrinite se da ga razumijete i prihvaćate prije nastavljanja instalacije.
5. Kad instalacija bude gotova, od vas će se možda zatražiti da ponovno pokrenete računalo. Računalo možete po želji ponovno pokrenuti kasnije.

### 3.2 Deinstalacija ili ponovna instalacija upravljačkog programa Xonar U7 kartice

#### 3.2.1 Deinstaliranje upravljačkog programa Xonar U7 kartice

Deinstalacija upravljačkog programa Xonar U7 kartice:

1. Kliknite **Start -> Control Panel (Upravljačka ploča) -> Programs and Features (Programi i funkcije)**.
2. Kliknite desnim klikom na upravljački program koji želite ukloniti, a zatim kliknite **Uninstall (Deinstaliraj)**.
3. U dijaloškom okviru **InstallShield Wizard (Čarobnjak InstallShield)** odaberite mogućnost **Remove (Ukloni)**.
4. Pokrenite iznova vaše računalo kada se to zatraži.

#### 3.2.2 Ponovno instaliranje upravljačkog programa Xonar U7 kartice

Ponovna instalacija upravljačkog programa Xonar U7 kartice:

1. Prije ponovne instalacije bilo kojeg softvera preporučuje se da prvo deinstalirate postojeći softver.
2. Po dovršetku deinstalacije softvera, temeljem istog postupka za instalaciju ponovno instalirajte isti ili ažurirani softver.

## 4. Spajanje zvučnika i vanjskih uređaja

### 4.1 Povezivanje ulaza

#### 4.1.1 Povezivanje na USB 2.0 priključak na računalu

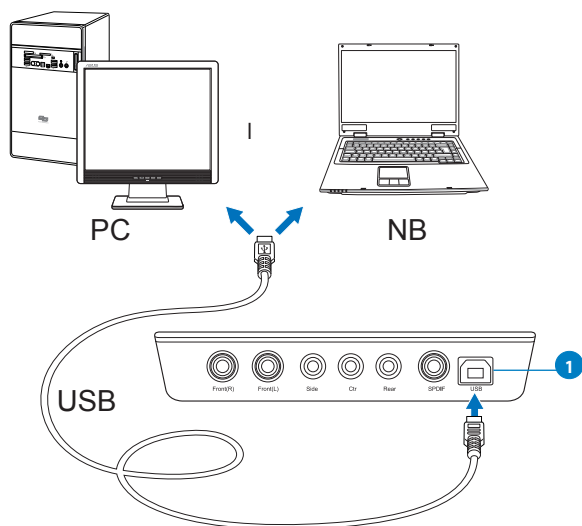

| No. | Stavka         | Opis  |
|-----|----------------|---|
| 1   | USB priključak | Spaja se na računalo pomoću USB kabela vrste B-A. |

## 4.1.2 Povezivanje digitalnih zvučnih sustava

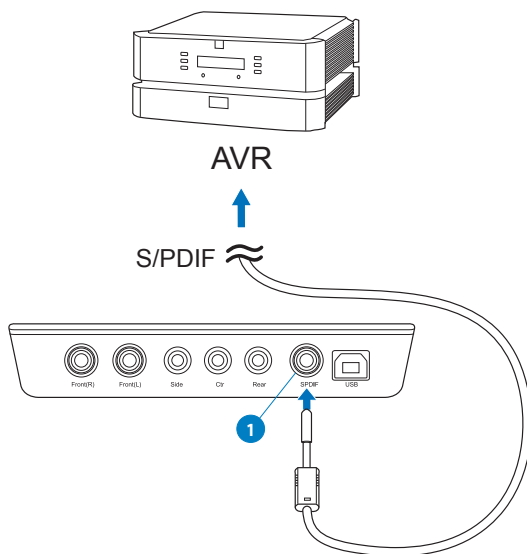

| No. | Stavka                           | Opis  |
|-----|----------------------------------|---|
| 1   | <b>S/PDIF izlazni priključak</b> | Povežite AVR (Audio/Video prijemnik) na ovaj S/PDIF izlazni priključak. |



### 4.1.3 Spajanje mikrofona / Line-In (linijski ulaz)

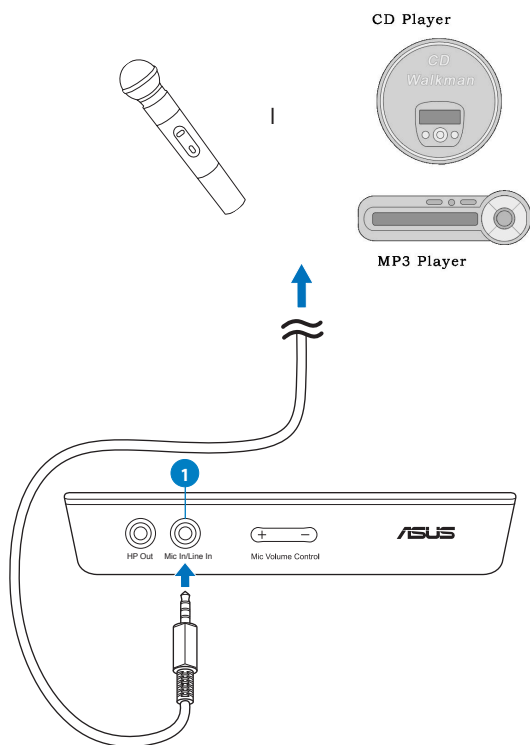

| No. | Stavka   | Opis   |
|-----|--|--|
| 1   | Ulazni priključak za mikrofona / Utičnica za linijski ulaz | <p>Spojite 3,5 milimetarski utikač mikrofona na ovaj Mic-In (Ulaz za mikrofona) priključak za glasovnu komunikaciju, snimanje ili karaoke.</p> <p>Spojite 3,5 milimetarski priključak CD/MP3 plejera ili bilo koji drugi analogni zvučni izvor linijske razine na ovaj Line-In (linijski ulaz) priključak za snimanje zvuka.</p> |

## 4.2 Izlazi

### 4.2.1 Spajanje stereo slušalica

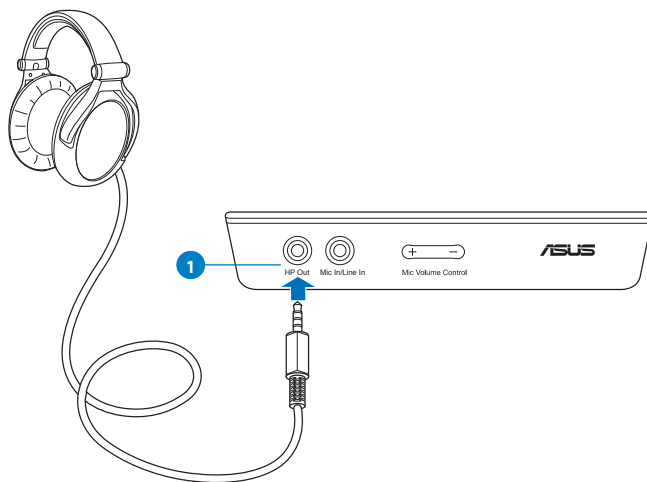

| No. | Stavka                       | Opis   |
|-----|------------------------------|--|
| 1   | Izlazni priključak slušalica | Izlazni priključak slušalica ima ugrađeno pojačalo visoke kvalitete za pobudu slušalica. Stereo slušalice spojite izravno na ovu utičnicu. |

## 4.2.2 Spajanje 5.1 kanalnih slušalica

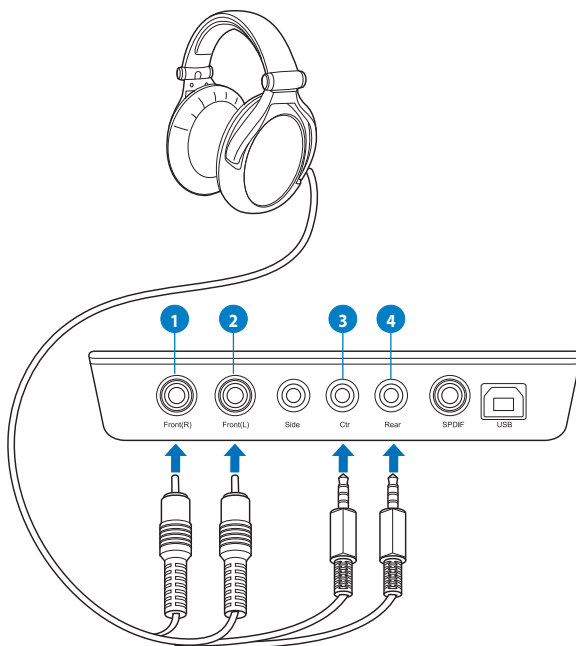

| No. | Stavka                                 | Opis   |
|-----|--|--|
| 1   | <b>Priključak prednjeg (D) izlaza</b>  | Povezuje se na prednji desni utor od 5.1 kanalnih slušalica uz pomoć RCA kabla                   |
| 2   | <b>Priključak prednjeg (L) izlaza</b>  | Povezuje se na prednji levi utor od 5.1 kanalnih slušalica uz pomoć RCA kabla                    |
| 3   | <b>Stražnji izlaz prostornog zvuka</b> | Spaja se na stražnji ulazni priključak prostornog zvuka pomoću kabla s mini priključkom.         |
| 4   | <b>Izlaz za bočne zvučnike</b>         | Spaja se na prednji priključak prostornih zvučnika za 5.1 kanala putem kabla s mini-priključkom. |

## 4.2.3 Spajanje analognih sustava zvučnika

### Spajanje zvučnika za 2 kanala

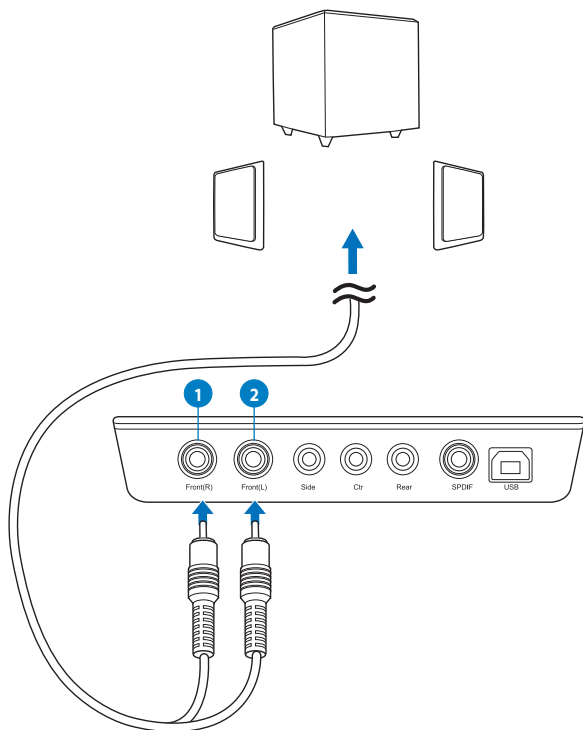

| No. | Stavka                                | Opis   |
|-----|---------------------------------------|--|
| 1   | <b>Priključak prednjeg (D) izlaza</b> | Povezuje se na prednji desni utor od 2 kanalnih slušalica uz pomoć RCA kabla |
| 2   | <b>Priključak prednjeg (L) izlaza</b> | Povezuje se na prednji levii utor od 2 kanalnih slušalica uz pomoć RCA kabla |

## Spajanje zvučnika za 4.1 kanala / pojačala

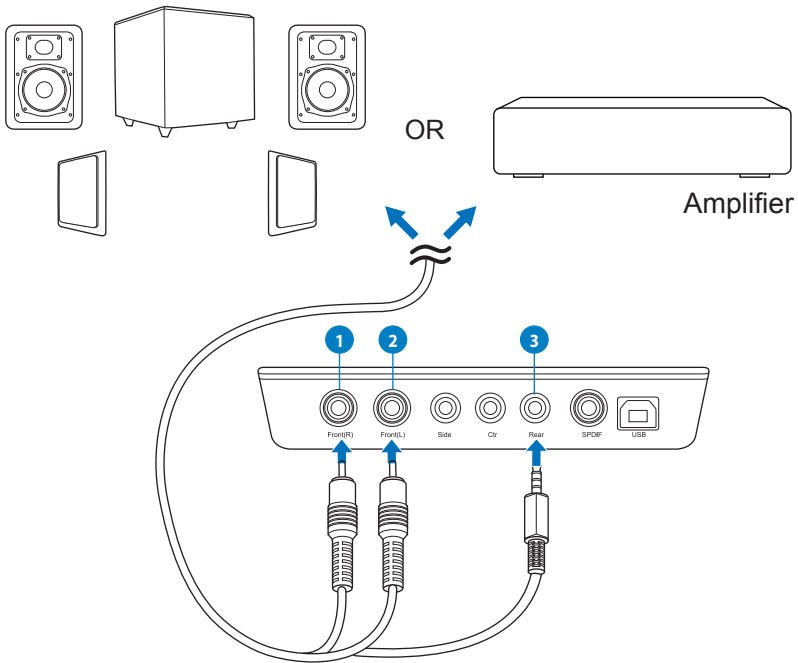

| No. | Stavka                         | Opis  |
|-----|--------------------------------|---|
| 1   | Priključak prednjeg (D) izlaza | Povezuje se na prednji desni utor od 4.1 kanalnih slušalica uz pomoć RCA kabla      |
| 2   | Priključak prednjeg (L) izlaza | Povezuje se na prednji levi utor od 4.1 kanalnih slušalica uz pomoć RCA kabla       |
| 3   | Izlaz za bočne zvučnike        | Spaja se na stražnji ulaz prostornog zvuka na 4.1 analognim zvučnicima s pojačalom. |

## Spajanje zvučnika za 5.1 kanala

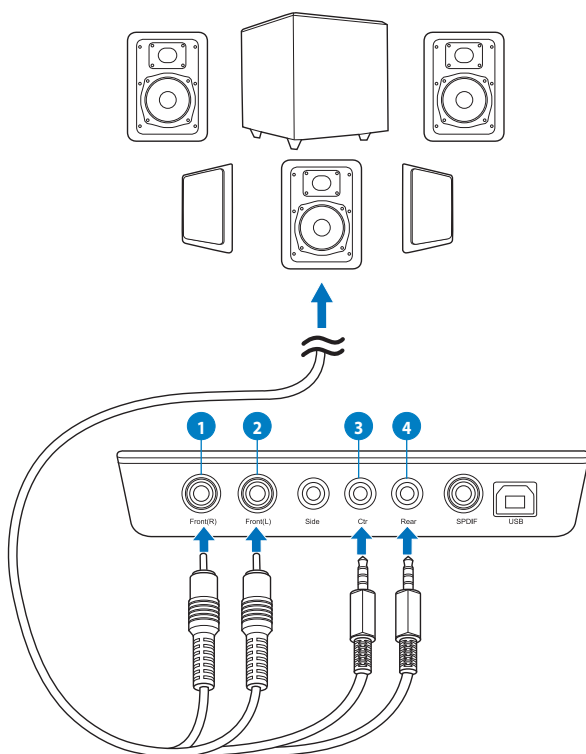

| No. | Stavka                                 | Opis  |
|-----|--|---|
| 1   | <b>Priključak prednjeg (D) izlaza</b>  | Spojite na prednji desni ulaz zvučnika s pojačalom.                                   |
| 2   | <b>Priključak prednjeg (L) izlaza</b>  | Spojite na prednji lijevi ulaz zvučnika s pojačalom.                                  |
| 3   | <b>Stražnji izlaz prostornog zvuka</b> | Spaja se na ulaz srednjeg/bas zvučnika na 5.1 analognim zvučnicima s pojačalom.       |
| 4   | <b>Izlaz za bočne zvučnike</b>         | Spaja se na stražnji ulaz prostornog zvuka na 4/5.1 analognim zvučnicima s pojačalom. |

## Spajanje zvučnika za 7.1 kanala

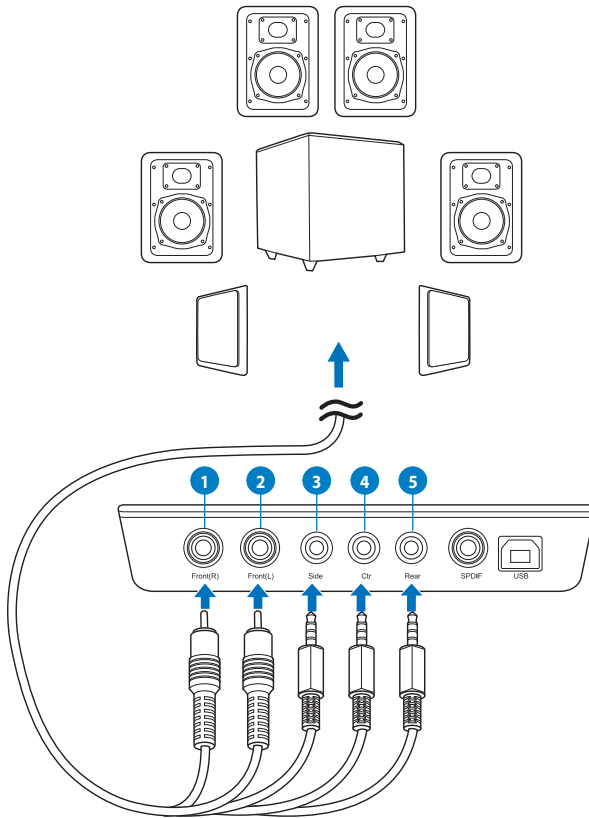

| No. | Stavka   | Opis  |
|-----|--|---|
| 1   | <b>Priključak prednjeg (D) izlaza</b>            | Spojite na prednji desni ulaz zvučnika s pojačalom.                                   |
| 2   | <b>Priključak prednjeg (L) izlaza</b>            | Spojite na prednji lijevi ulaz zvučnika s pojačalom.                                  |
| 3   | <b>Priključak bojnog izlaza prostornog zvuka</b> | Spaja se na ulaz kanalnog prostornog zvuka na 7.1 analognim zvučnicima s pojačalom.   |
| 4   | <b>Stražnji izlaz prostornog zvuka</b>           | Spaja se na ulaz srednjeg/bas zvučnika na 5.1 analognim zvučnicima s pojačalom.       |
| 5   | <b>Izlaz za bočne zvučnike</b>                   | Spaja se na stražnji ulaz prostornog zvuka na 4/5.1 analognim zvučnicima s pojačalom. |