

ASUS®

MX299Q

LCD Monitor

User Guide

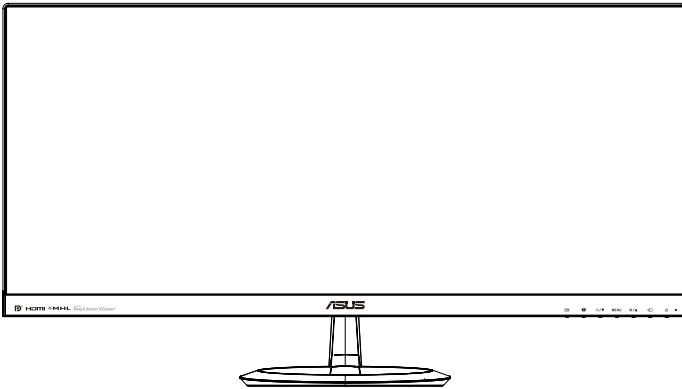

Table of contents

- Notices iii
- Safety information iv
- Care & Cleaning v
- 1.1 Welcome! 1-1
- 1.2 Package contents..... 1-1
- 1.3 Monitor introduction 1-2
 - 1.3.1 Front view 1-2
 - 1.3.2 Back view 1-4
 - 1.3.3 QuickFit function 1-5
- 2.1 Assembling the base 2-1
- 2.2 Connecting cables 2-1
- 2.3 Detaching the base 2-2
- 2.4 Adjusting the monitor 2-3
- 3.1 OSD (On-Screen Display) menu 3-1
 - 3.1.1 How to reconfigure 3-1
 - 3.1.2 OSD Function Introduction..... 3-1
- 3.2 Specifications 3-6
- 3.3 Troubleshooting (FAQ)..... 3-7
- 3.4 Supported Timing List 3-8

Copyright © 2013 ASUSTeK COMPUTER INC. All Rights Reserved.

No part of this manual, including the products and software described in it, may be reproduced, transmitted, transcribed, stored in a retrieval system, or translated into any language in any form or by any means, except documentation kept by the purchaser for backup purposes, without the express written permission of ASUSTeK COMPUTER INC. ("ASUS").

Product warranty or service will not be extended if: (1) the product is repaired, modified or altered, unless such repair, modification of alteration is authorized in writing by ASUS; or (2) the serial number of the product is defaced or missing.

ASUS PROVIDES THIS MANUAL "AS IS" WITHOUT WARRANTY OF ANY KIND, EITHER EXPRESS OR IMPLIED, INCLUDING BUT NOT LIMITED TO THE IMPLIED WARRANTIES OR CONDITIONS OF MERCHANTABILITY OR FITNESS FOR A PARTICULAR PURPOSE. IN NO EVENT SHALL ASUS, ITS DIRECTORS, OFFICERS, EMPLOYEES OR AGENTS BE LIABLE FOR ANY INDIRECT, SPECIAL, INCIDENTAL, OR CONSEQUENTIAL DAMAGES (INCLUDING DAMAGES FOR LOSS OF PROFITS, LOSS OF BUSINESS, LOSS OF USE OR DATA, INTERRUPTION OF BUSINESS AND THE LIKE), EVEN IF ASUS HAS BEEN ADVISED OF THE POSSIBILITY OF SUCH DAMAGES ARISING FROM ANY DEFECT OR ERROR IN THIS MANUAL OR PRODUCT.

SPECIFICATIONS AND INFORMATION CONTAINED IN THIS MANUAL ARE FURNISHED FOR INFORMATIONAL USE ONLY, AND ARE SUBJECT TO CHANGE AT ANY TIME WITHOUT NOTICE, AND SHOULD NOT BE CONSTRUED AS A COMMITMENT BY ASUS. ASUS ASSUMES NO RESPONSIBILITY OR LIABILITY FOR ANY ERRORS OR INACCURACIES THAT MAY APPEAR IN THIS MANUAL, INCLUDING THE PRODUCTS AND SOFTWARE DESCRIBED IN IT.

Products and corporate names appearing in this manual may or may not be registered trademarks or copyrights of their respective companies, and are used only for identification or explanation and to the owners' benefit, without intent to infringe.

Notices

Federal Communications Commission Statement

This device complies with Part 15 of the FCC Rules. Operation is subject to the following two conditions:

- This device may not cause harmful interference, and
- This device must accept any interference received including interference that may cause undesired operation.

This equipment has been tested and found to comply with the limits for a Class B digital device, pursuant to Part 15 of the FCC Rules. These limits are designed to provide reasonable protection against harmful interference in a residential installation. This equipment generates, uses and can radiate radio frequency energy and, if not installed and used in accordance with manufacturer's instructions, may cause harmful interference to radio communications. However, there is no guarantee that interference will not occur in a particular installation. If this equipment does cause harmful interference to radio or television reception, which can be determined by turning the equipment off and on, the user is encouraged to try to correct the interference by one or more of the following measures:

- Reorient or relocate the receiving antenna.
- Increase the separation between the equipment and receiver.
- Connect the equipment to an outlet on a circuit different from that to which the receiver is connected.
- Consult the dealer or an experienced radio/TV technician for help.



As an Energy Star[®] Partner, our company has determined that this product meets the Energy Star[®] guidelines for energy efficiency.

Canadian Department of Communications Statement

This digital apparatus does not exceed the Class B limits for radio noise emissions from digital apparatus set out in the Radio Interference Regulations of the Canadian Department of Communications.

This class B digital apparatus complies with Canadian ICES-003.

Safety information

- Before setting up the monitor, carefully read all the documentation that came with the package.
- To prevent fire or shock hazard, never expose the monitor to rain or moisture.
- Never try to open the monitor cabinet. The dangerous high voltages inside the monitor may result in serious physical injury.
- If the power supply is broken, do not try to fix it by yourself. Contact a qualified service technician or your retailer.
- Before using the product, make sure all cables are correctly connected and the power cables are not damaged. If you detect any damage, contact your dealer immediately.
- Slots and openings on the back or top of the cabinet are provided for ventilation. Do not block these slots. Never place this product near or over a radiator or heat source unless proper ventilation is provided.
- The monitor should be operated only from the type of power source indicated on the label. If you are not sure of the type of power supply to your home, consult your dealer or local power company.
- Use the appropriate power plug which complies with your local power standard.
- Do not overload power strips and extension cords. Overloading can result in fire or electric shock.
- Avoid dust, humidity, and temperature extremes. Do not place the monitor in any area where it may become wet. Place the monitor on a stable surface.
- Unplug the unit during a lightning storm or if it will not be used for a long period of time. This will protect the monitor from damage due to power surges.
- Never push objects or spill liquid of any kind into the slots on the monitor cabinet.
- To ensure satisfactory operation, use the monitor only with UL listed computers which have appropriate configured receptacles marked between 100 ~ 240V AC.
- The socket-outlet shall be installed near the equipment and shall be easily accessible
- If you encounter technical problems with the monitor, contact a qualified service technician or your retailer.

Care & Cleaning

- Before you lift or reposition your monitor, it is better to disconnect the cables and power cord. Follow the correct lifting techniques when positioning the monitor. When lifting or carrying the monitor, grasp the edges of the monitor. Do not lift the display by the stand or the cord.
- Cleaning. Turn your monitor off and unplug the power cord. Clean the monitor surface with a lint-free, non-abrasive cloth. Stubborn stains may be removed with a cloth dampened with mild cleaner.
- Avoid using a cleaner containing alcohol or acetone. Use a cleaner intended for use with the LCD. Never spray cleaner directly on the screen, as it may drip inside the monitor and cause an electric shock.

The following symptoms are normal with the monitor:

- The screen may flicker during the initial use due to the nature of the fluorescent light. Turn off the Power Switch and turn it on again to make sure that the flicker disappears.
- You may find slightly uneven brightness on the screen depending on the desktop pattern you use.
- When the same image is displayed for hours, an afterimage of the previous screen may remain after switching the image. The screen will recover slowly or you can turn off the Power Switch for hours.
- When the screen becomes black or flashes, or cannot work anymore, contact your dealer or service center to fix it. Do not repair the screen by yourself!

Conventions used in this guide



WARNING: Information to prevent injury to yourself when trying to complete a task.



CAUTION: Information to prevent damage to the components when trying to complete a task.



IMPORTANT: Information that you **MUST** follow to complete a task.



NOTE: Tips and additional information to aid in completing a task.

Where to find more information

Refer to the following sources for additional information and for product and software updates.

1. ASUS websites

The ASUS websites worldwide provide updated information on ASUS hardware and software products. Refer to **<http://www.asus.com>**

2. Optional documentation

Your product package may include optional documentation that may have been added by your dealer. These documents are not part of the standard package.

1.1 Welcome!

Thank you for purchasing the ASUS® LCD monitor!

The latest widescreen LCD monitor from ASUS provides a crisper, broader, and brighter display, plus a host of features that enhance your viewing experience.

With these features, you can enjoy the convenience and delightful visual experience that the monitor brings you!

1.2 Package contents

Check your package for the following items:

- ✓ LCD Monitor
- ✓ Monitor Base
- ✓ Quick Start Guide
- ✓ Warranty Card
- ✓ 1x Power Cord
- ✓ 1x Power Adapter
- ✓ 1x DVI Cable (Dual Link)
- ✓ 1x HDMI Cable
- ✓ 1x MHL Cable
- ✓ 1x Audio Cable







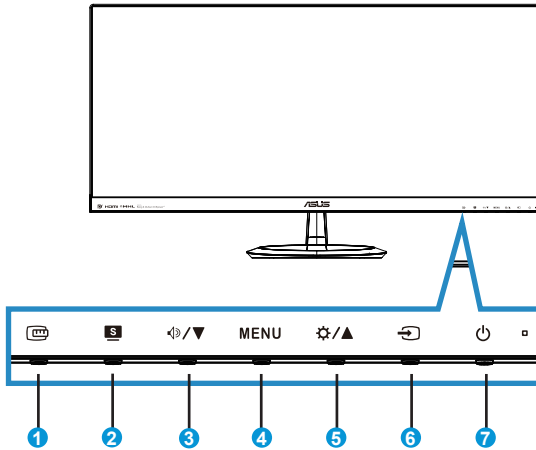

-
- If any of the above items is damaged or missing, contact your retailer immediately.
-

1.3 Monitor introduction

1.3.1 Front view



1.  **QuickFit Button:**
 - This is a hotkey to activate the **QuickFit** function designed for alignment.
 - The **QuickFit** function contains 7 pages of common grid patterns, paper sizes, and photo sizes. See page 1-5 for details.
2.  **S Button:**
 - Use this hotkey to switch from six video preset modes ({**Scenery Mode**}, {**Standard Mode**}, {**Theater Mode**}, {**Game Mode**}, {**Night View Mode**}, and {**sRGB**}) with SPLENDID™ Video Intelligence Technology.
 - Exit the OSD menu or go back to the previous menu as the OSD menu is active.
3.  **Volume/Arrow Button:**
 - Press this button to decrease the value of the function selected or move to the next function.
 - This is also a hotkey for Volume adjustment.
4. **MENU Button:**
 - Press this button to enter the OSD menu.
 - Press this button to enter/select the icon (function) highlighted while the OSD is activated.

5.  /  Button:
 - Press this button to increase the value of the function selected or move to the previous functions.
 - This is also a hotkey for Brightness adjustment.
6.  Input Select Button:
 - Use this hotkey to switch from input signal.
7.  Power Button/Power Indicator:
 - Press this button to turn the monitor on/off.
 - The color definition of the power indicator is as the below table.

Status	Description
White	ON
Amber	Standby mode
OFF	OFF

1.3.2 Back view

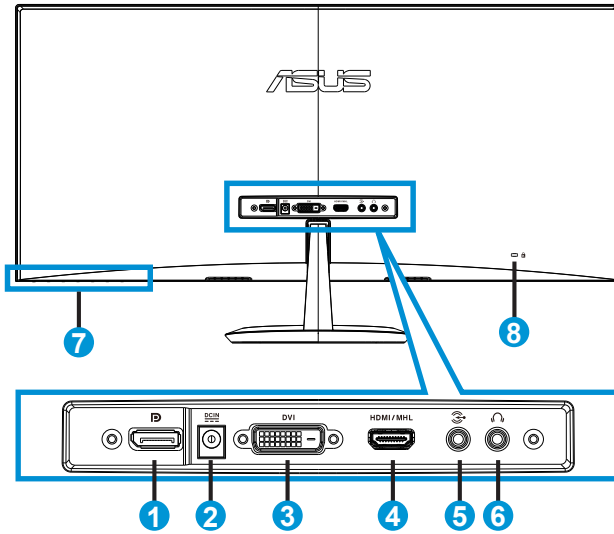

1. DisplayPort
2. DC-in Port
3. DVI Port
4. HDMI/MHL Port
5. Audio-in Port
6. Earphone-out Port
7. Control Buttons
8. Kensington Lock

1.3.3 QuickFit function

The QuickFit function contains three patterns: (1) Grid (2) Paper size (3) Photo size.

1. Grid pattern: Facilitates designers and users to organize content and layout on one page and achieve a consistent look and feel.

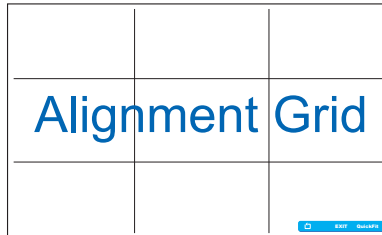

2. Paper size: Provides users to view their documents in real size on the screen.

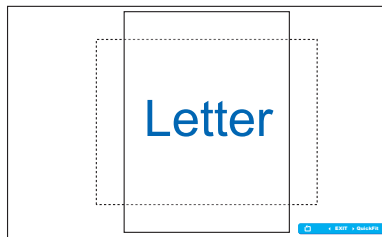

3. Photo size: Provides photographers and other users to accurately view and edit their photos in real size on the screen.

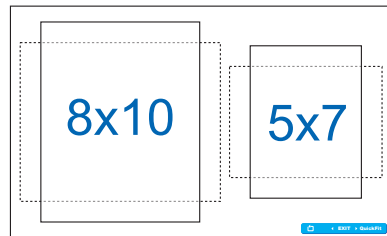
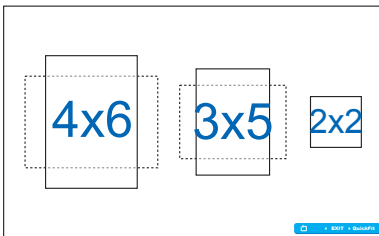

2.1 Assembling the base

To assemble the base:

1. Carefully put the front of the monitor face down on a clean table.
2. Attach the base to the stand.
3. Use a coin to lock the base to the stand tightly. The monitor is now ready for connection.

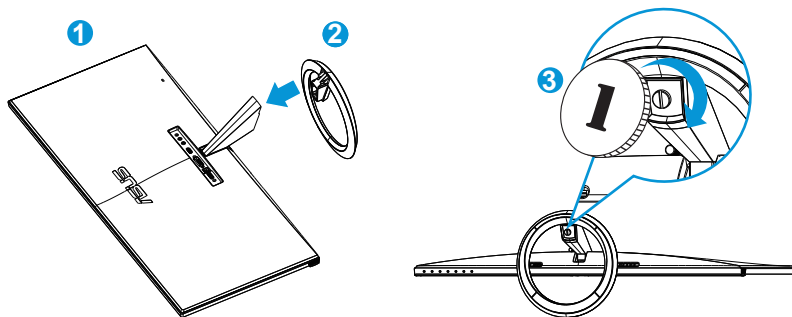

- We recommend that you cover the table surface with soft cloth to prevent damage to the monitor.

2.2 Connecting cables

Connect the cables you need based on the introductions on chapter 1.3.2, page 1-4.

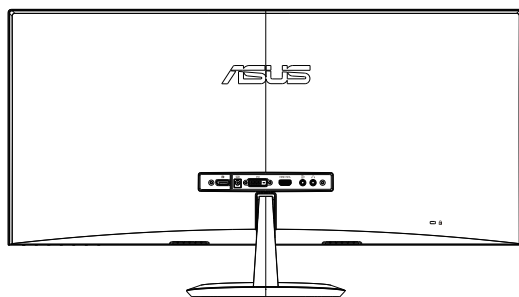

2.3 Detaching the base

To detach the base:

1. Disconnect power and signal cables. Carefully put the front of the monitor face down on a clean table.
2. Use a coin to unlock the base.
3. Detach the base from the stand.



- We recommend that you cover the table surface with soft cloth to prevent damage to the monitor.
- Hold the base while removing the screw.

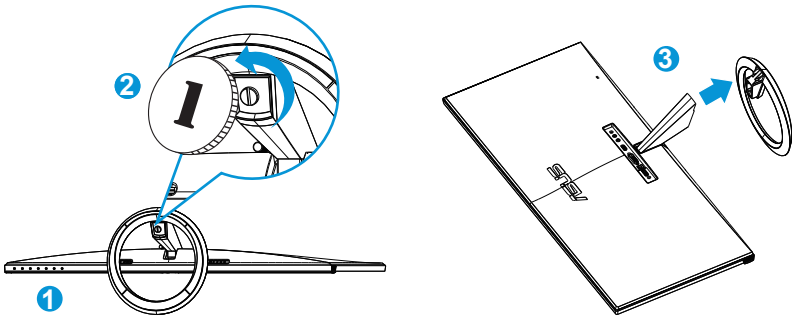

2.4 Adjusting the monitor

- For optimal viewing, we recommend that you look at the full face of the monitor, then adjust the monitor to the angle that is most comfortable for you.
- Hold the stand to prevent the monitor from falling while changing its angle.
- You can adjust the monitor's angle from -5° to $+20^{\circ}$.

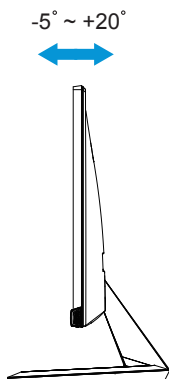

3.1 OSD (On-Screen Display) menu

3.1.1 How to reconfigure

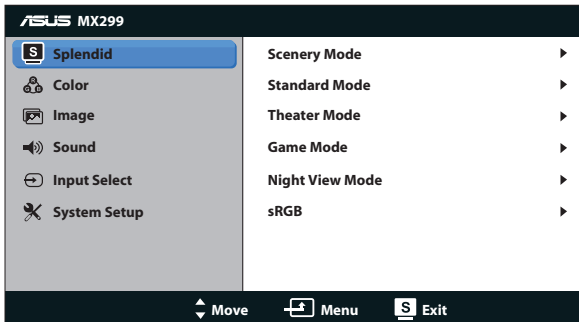

1. Press the **MENU** button to activate the OSD menu.
2. Press **▼** and **▲** to navigate through the functions. Highlight and activate the desired function by pressing the **MENU** button. If the function selected has a sub-menu, press **▼** and **▲** again to navigate through the sub-menu functions. Highlight and activate the desired sub-menu function by pressing the **MENU** button.
3. Press **▼** and **▲** to change the settings of the selected function.
4. To exit the OSD menu, press the **S** button. Repeat step 2 and step 3 to adjust any other function.

3.1.2 OSD Function Introduction

1. Splendid

This function contains six sub-functions that you can select for your preference. Each mode has the Reset selection, allowing you to maintain your setting or return to the preset mode.

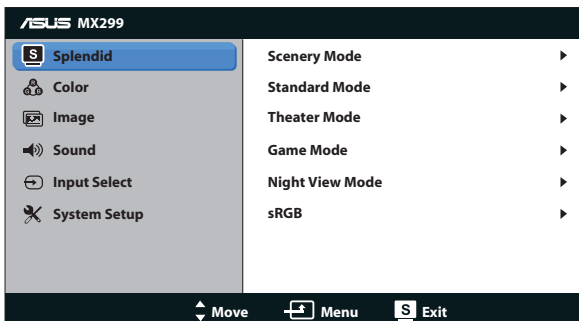

- **Scenery Mode:** This is the best choice for scenery photo displaying with SPLENDID™ Video Intelligence Technology.
- **Standard Mode:** This is the best choice for document editing with SPLENDID™ Video Intelligence Technology.
- **Theater Mode:** This is the best choice for movie watching with SPLENDID™ Video Intelligence Technology.
- **Game Mode:** This is the best choice for game playing with SPLENDID™ Video Intelligence Technology.
- **Night View Mode:** This is the best choice for playing dark-scene game or watching dark-scene movie with SPLENDID™ Video Intelligence Technology.
- **sRGB Mode:** This is the best choice for viewing photos and graphics from PCs.



- In the Standard Mode, the {Saturation}, {Skin Tone}, {Sharpness}, and {ASCR} functions are not user-configurable.
- In the sRGB Mode, the {Saturation}, {Color Temp.}, {Skin Tone}, {Sharpness}, {Brightness}, {Contrast}, and {ASCR} functions are not user-configurable.

2. Color

Select the image color you like from this function.

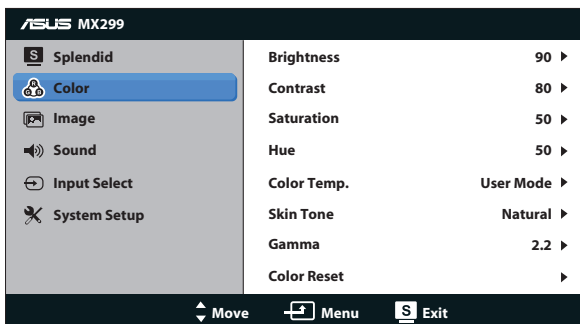

- **Brightness:** The adjusting range is from {0} to {100}. The / button is also a hotkey to activate this function.
- **Contrast:** The adjusting range is from {0} to {100}.
- **Saturation:** The adjusting range is from {0} to {100}.
- **Hue:** Shift the image color between green and purple.
- **Color Temp.:** Contain three preset color modes ({Cool}, {Normal}, {Warm}) and one {User Mode}.

- **Skin Tone:** Contain three color modes including {**Reddish**}, {**Natural**}, and {**Yellowish**}.
- **Gamma:** Set the color mode to {**2.2**} or {**1.8**}.
- **Color Reset:**
 - **Current mode color reset:**
Reset the color settings of current color mode to the factory default value.
 - **All modes color reset:**
Reset the color settings of all color modes to the factory default value.



- In the User Mode, colors of R (Red), G (Green), and B (Blue) are user-configurable; the adjusting range is from {**0**} ~ {**100**}.

3. Image

Set the image related setting from this menu.

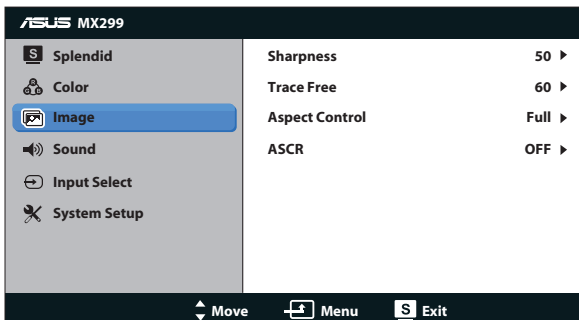

- **Sharpness:** Adjust the picture sharpness. The adjusting range is from {**0**} to {**100**}.
- **Trace Free:** Speed up the response time by Over Drive technology. The adjusting range is from lower {**0**} to faster {**100**}.
- **Aspect Control:** Adjust the aspect ratio to {**Full**}, {**4:3**}, {**OverScan**}, {**1:1**}. The {**OverScan**} is available only for HDMI source.
- **ASCR:** Turn on or off the dynamic contrast ratio function.

4. Sound

Adjust the sound settings to your preference.

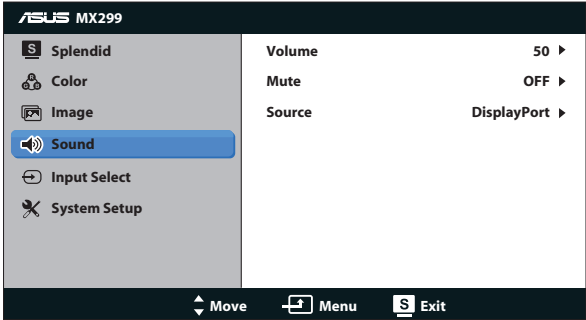

5. Input Select

Select the input source from DVI, HDMI/MHL, or DisplayPort.

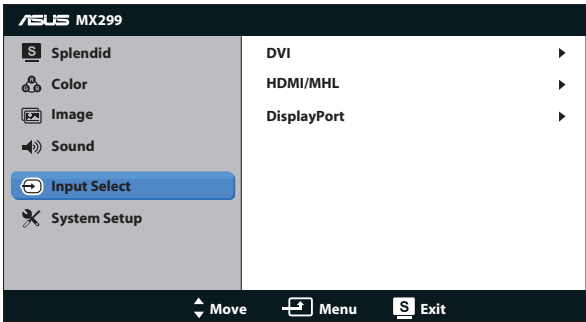

6. System Setup

Adjust the system configuration.

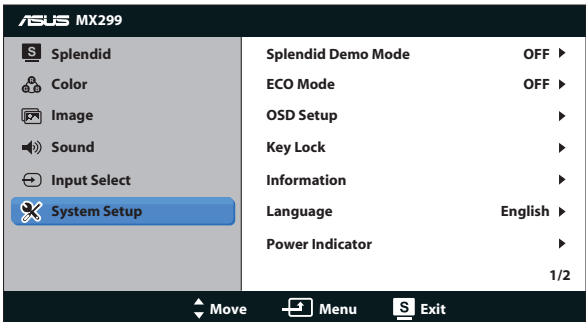

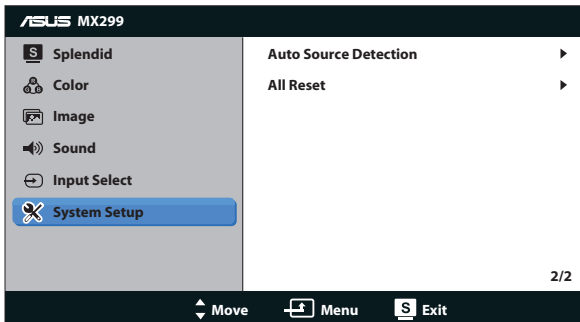

- **Splendid Demo Mode:** Activate the demo mode for the Splendid function.
- **ECO Mode:** Activate the ecology mode for power saving.
- **OSD Setup:** Adjust the horizontal position ({**H-Position**}), vertical position ({**V-Position**}), {**OSD Timeout**}, {**DDC/CI**}, and {**Transparency**} of the OSD screen.
- **Key Lock:** Select {**On**} to lock all buttons (including the Power button) to prevent from being touched accidentally.



- Press and hold the MENU key for 5 seconds to enable or disable this Key Lock function.

- **Information:** Show the monitor information.
- **Language:** Select OSD language.
- **Information:** Display the monitor information.
- **Power Indicator:** Turn the power LED indicator on/off.
- **Auto source detection:** Automatically detects the active source input.



- A screen message pops up at turning on the power. It is recommended to select {**On**} for auto detection. To exit this message, press **MENU** button.
- This message revives after resetting the OSD menu.

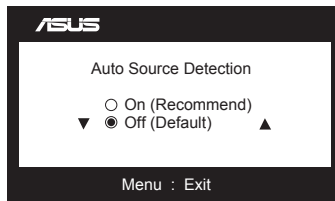

- **All Reset:** Selects {**Yes**} to revert all settings to the factory default mode.

3.2 Specifications

Model	MX299Q
Panel Size	29" W (73.025 cm)
Max. Resolution	2560 x 1080
Brightness (Typ.)	300 cd/m ²
Intrinsic Contrast Ratio (Typ.)	≥ 1000:1
Dynamic Contrast Ratio (Typ.)	≥ 80,000,000:1
Viewing Angle (CR=10)	178°(H) / 178°(V)
Color Saturation (NTSC)	≥ 72% sRGB
Display Colors	16.7 Millions
Response Time (Typ.)	≤ 5 ms (Gray to Gray)
DisplayPort input	Yes
HDMI/MHL Port	Yes (MHL 2.0)
DVI Input	Yes (Dual Link)
Speaker	Yes (3 W x 2)
Earphone	Yes (3.5 mm Mini-jack)
Power Consumption	Power On: < 55 W Energy Star: < 28 W Standby: < 0.5 W Power Off: < 0.5 W
Tilt	-5° ~ +20°
Phys. Dimension (WxHxD)	700.2 x 391 x 215.1
Box Dimension (WxHxD)	814 x 506 x 159
Net Weight (Esti.)	5.5 kg
Gross Weight (Esti.)	8.1 kg
Voltage Rating	AC 100 ~ 240 V (External)
Regulation Approvals	Energy Star 6.0, UL/cUL, CB, CE, ErP, FCC, CCC, BSMI, Gost-R, C-Tick, VCCI, J-MOSS, RoHS, WEEE, Windows 7/8 WHQL, Green ASUS

*Specifications are subject to change without notice.

3.3 Troubleshooting (FAQ)

Problem	Possible Solution
Power LED is not ON	<ul style="list-style-type: none">• Press the  button to check if the monitor is in the ON mode.• Check if the power cord is properly connected to the monitor and the power outlet.
The power LED lights amber and there is no screen image	<ul style="list-style-type: none">• Check if the monitor and the computer are in the ON mode.• Make sure the signal cable is properly connected the monitor and the computer.• Inspect the signal cable and make sure none of the pins are bent.• Connect the computer with another available monitor to check if the computer is properly working.
Screen image is too light or dark	<ul style="list-style-type: none">• Adjust the Contrast and Brightness settings via OSD.
Screen image bounces or a wave pattern is present in the image	<ul style="list-style-type: none">• Make sure the signal cable is properly connected to the monitor and the computer.• Move electrical devices that may cause electrical interference.
Screen image has color defects (white does not look white)	<ul style="list-style-type: none">• Inspect the signal cable and make sure that none of the pins are bent.• Perform Reset via OSD.• Adjust the R/G/B color settings or select the Color Temperature via OSD.
No sound or sound is low	<ul style="list-style-type: none">• Make sure the audio cable is properly connected to the monitor.• Adjust the volume settings of both your monitor and computer.• Make sure the computer sound card driver is properly installed and activated.

3.4 Supported Timing List

VESA / IBM Modes Support Timing (DVI, HDMI/MHL, and DisplayPort inputs)

Resolution	Refresh Rate	Horizontal Frequency
640 x 350	70 Hz	31.469 KHz
640 x 480	60 Hz	31.469 KHz
640 x 480	67 Hz	35 KHz
640 x 480	75 Hz	37.5 KHz
720 x 400	70 Hz	31.469 KHz
800 x 600	56 Hz	35.156 KHz
800 x 600	60 Hz	37.879 KHz
800 x 600	72 Hz	48.077 KHz
800 x 600	75 Hz	46.875 KHz
832 x 624	75 Hz	49.725 KHz
848 x 480	60 Hz	31.02 KHz
1024 x 768	60 Hz	48.363 KHz
1024 x 768	70 Hz	56.476 KHz
1024 x 768	75 Hz	60.023 KHz
1152 x 864	75 Hz	67.5 KHz
1280 x 720	60 Hz	44.772 KHz
1280 x 800	60 Hz	49.702 KHz
1280 x 960	60 Hz	60 KHz
1280 x 1024	60 Hz	63.981 KHz
1280 x 1024	75 Hz	79.976 KHz
1440 x 900	60 Hz	55.935 KHz
1680 x 1050	60 Hz	65.29 KHz
1680 x 1050	60 Hz	64.674 KHz
1920 x 1080	60 Hz	67.5 KHz
1920 x 1080	60 Hz	66.587 KHz
2560 x 1080	60 Hz	66.636 KHz

CEA-861 Formats Supported Timing (HDMI/MHL and DisplayPort input)

Resolution	Refresh Rate	Horizontal Frequency
640 x 480P	59.94 / 60 Hz	31.469 / 31.5 KHz
720 x 480P	59.94 / 60 Hz	31.469 / 31.5 KHz
720 x 576P	50 Hz	31.25 KHz
1280 x 720P	50 Hz	37.5 KHz
1280 x 720P	59.94 / 60 Hz	44.955 / 45 KHz
1440 x 480P	59.94 / 60 Hz	31.469 / 31.5 KHz
1440 x 576P	50 Hz	31.25 KHz
1920 x 1080i	50 Hz	28.125 KHz
1920 x 1080i	59.94 / 60 Hz	33.716 / 33.75 KHz
1920 x 1080P	50 Hz	56.25 KHz
1920 x 1080P	59.94 / 60 Hz	67.433 / 67.5 KHz

* The modes not listed in the above tables may not be supported. For optimal resolution, we recommend that you choose a mode listed in the above tables.