

The background of the cover is a dark, abstract image of a glowing, metallic, three-pronged shape, possibly a stylized 'Z' or a lightning bolt, with a bright yellow and orange glow at its center and a blue glow at its tip. The shape is set against a black background with some light streaks and a subtle grid pattern.

ASRock®

Z97 Pro4

User Manual

Version 1.0

Published April 2014

Copyright©2014 ASRock INC. All rights reserved.

Copyright Notice:

No part of this documentation may be reproduced, transcribed, transmitted, or translated in any language, in any form or by any means, except duplication of documentation by the purchaser for backup purpose, without written consent of ASRock Inc.

Products and corporate names appearing in this documentation may or may not be registered trademarks or copyrights of their respective companies, and are used only for identification or explanation and to the owners' benefit, without intent to infringe.

Disclaimer:

Specifications and information contained in this documentation are furnished for informational use only and subject to change without notice, and should not be constructed as a commitment by ASRock. ASRock assumes no responsibility for any errors or omissions that may appear in this documentation.

With respect to the contents of this documentation, ASRock does not provide warranty of any kind, either expressed or implied, including but not limited to the implied warranties or conditions of merchantability or fitness for a particular purpose.

In no event shall ASRock, its directors, officers, employees, or agents be liable for any indirect, special, incidental, or consequential damages (including damages for loss of profits, loss of business, loss of data, interruption of business and the like), even if ASRock has been advised of the possibility of such damages arising from any defect or error in the documentation or product.



This device complies with Part 15 of the FCC Rules. Operation is subject to the following two conditions:

- (1) this device may not cause harmful interference, and
- (2) this device must accept any interference received, including interference that may cause undesired operation.

CALIFORNIA, USA ONLY

The Lithium battery adopted on this motherboard contains Perchlorate, a toxic substance controlled in Perchlorate Best Management Practices (BMP) regulations passed by the California Legislature. When you discard the Lithium battery in California, USA, please follow the related regulations in advance.

“Perchlorate Material-special handling may apply, see www.dtsc.ca.gov/hazardouswaste/perchlorate”

ASRock Website: <http://www.asrock.com>

The terms HDMI™ and HDMI High-Definition Multimedia Interface, and the HDMI logo are trademarks or registered trademarks of HDMI Licensing LLC in the United States and other countries.



Contents

Chapter 1 Introduction	1
1.1 Package Contents	1
1.2 Specifications	2
1.3 Unique Features	6
1.4 Motherboard Layout	10
1.5 I/O Panel	12
Chapter 2 Installation	14
2.1 Installing the CPU	15
2.2 Installing the CPU Fan and Heatsink	18
2.3 Installing Memory Modules (DIMM)	19
2.4 Expansion Slots (PCI and PCI Express Slots)	21
2.5 Jumpers Setup	22
2.6 Onboard Headers and Connectors	23
2.7 CrossFire™ and Quad CrossFire™ Operation Guide	28
2.7.1 Installing Two CrossFire™-Ready Graphics Cards	28
2.7.2 Driver Installation and Setup	30
2.8 M.2_SSD (NGFF) Module Installation Guide	31
Chapter 3 Software and Utilities Operation	34
3.1 Installing Drivers	34
3.2 A-Tuning	35
3.3 Intel® Rapid Start Technology	41
3.4 Intel® Smart Connect Technology	46

3.5	ASRock Cloud	51
3.6	ASRock APP Shop	61
3.6.1	UI Overview	61
3.6.2	Apps	62
3.6.3	BIOS & Drivers	65
3.6.4	Setting	66
3.7	Start8	67
Chapter 4 UEFI SETUP UTILITY		70
4.1	Introduction	70
4.1.1	UEFI Menu Bar	70
4.1.2	Navigation Keys	71
4.2	Main Screen	72
4.3	OC Tweaker Screen	73
4.4	Advanced Screen	82
4.4.1	CPU Configuration	83
4.4.2	Chipset Configuration	85
4.4.3	Storage Configuration	87
4.4.4	Intel® Rapid Start Technology	89
4.4.5	Intel® Smart Connect Technology	90
4.4.6	Intel® Thunderbolt™	91
4.4.7	Super IO Configuration	92
4.4.8	ACPI Configuration	93
4.4.9	USB Configuration	95
4.4.10	Trusted Computing	97

4.5	Tools	98
4.6	Hardware Health Event Monitoring Screen	101
4.7	Boot Screen	102
4.8	Security Screen	105
4.9	Exit Screen	106

Chapter 1 Introduction

Thank you for purchasing ASRock Z97 Pro4 motherboard, a reliable motherboard produced under ASRock's consistently stringent quality control. It delivers excellent performance with robust design conforming to ASRock's commitment to quality and endurance.

In this manual, Chapter 1 and 2 contains the introduction of the motherboard and step-by-step installation guides. Chapter 3 contains the operation guide of the software and utilities. Chapter 4 contains the configuration guide of the BIOS setup.



Because the motherboard specifications and the BIOS software might be updated, the content of this manual will be subject to change without notice. In case any modifications of this manual occur, the updated version will be available on ASRock's website without further notice. If you require technical support related to this motherboard, please visit our website for specific information about the model you are using. You may find the latest VGA cards and CPU support list on ASRock's website as well. ASRock website <http://www.asrock.com>.

1.1 Package Contents

- ASRock Z97 Pro4 Motherboard (ATX Form Factor)
- ASRock Z97 Pro4 Quick Installation Guide
- ASRock Z97 Pro4 Support CD
- 2 x Serial ATA (SATA) Data Cables (Optional)
- 1 x I/O Panel Shield
- 1 x Screw for M.2_SSD (NGFF) Socket 3

1.2 Specifications

- Platform**
- ATX Form Factor
 - High Density Glass Fabric PCB

- Unique Feature**
- ASRock Super Alloy**
- Premium Alloy Choke (Reduces 70% core loss compared to iron powder choke)
 - NexFET™ MOSFET
 - 12K Platinum Caps (100% Japan made high quality conductive polymer capacitors)
 - Sapphire Black PCB
- ASRock Full Spike Protection**
- ASRock Cloud**
- ASRock APP Shop**

- CPU**
- Supports 4th Gen & 5th Generation Intel® Core™ Processors (Socket 1150)
 - Digi Power design
 - 6 Power Phase design
 - Supports Intel® Turbo Boost 2.0 Technology
 - Supports Intel® K-Series unlocked CPUs
 - Supports ASRock BCLK Full-range Overclocking

- Chipset**
- Intel® Z97

- Memory**
- Dual Channel DDR3 Memory Technology
 - 4 x DDR3 DIMM Slots
 - Supports DDR3 2933+(OC)/2800(OC)/2400(OC)/2133(OC)/1866(OC)/1600/1333/1066 non-ECC, un-buffered memory
 - Max. capacity of system memory: 32GB (see CAUTION)
 - Supports Intel® Extreme Memory Profile (XMP) 1.3 / 1.2

- Expansion Slot**
- 1 x PCI Express 3.0 x16 Slot (PCIe1: x16 mode)
 - 1 x PCI Express 2.0 x16 Slot (PCIe3: x4 mode)
* If PCIe2 or PCIe4 slot is occupied, PCIe3 slot will run at x2 mode.
 - 2 x PCI Express 2.0 x1 Slots
 - 2 x PCI Slots
 - Supports AMD Quad CrossFireX™ and CrossFireX™

Graphics

- Intel® HD Graphics Built-in Visuals and the VGA outputs can be supported only with processors which are GPU integrated.
- Supports Intel® HD Graphics Built-in Visuals : Intel® Quick Sync Video with AVC, MVC (S3D) and MPEG-2 Full HW Encode1, Intel® InTru™ 3D, Intel® Clear Video HD Technology, Intel® Insider™, Intel® HD Graphics 4400/4600
- Pixel Shader 5.0, DirectX 11.1
- Max. shared memory 1792MB
- Three graphics output options: D-Sub, DVI-D and HDMI
- Supports Triple Monitor
- Supports HDMI with max. resolution up to 1920x1200 @ 60Hz
- Supports DVI-D with max. resolution up to 1920x1200 @ 60Hz
- Supports D-Sub with max. resolution up to 1920x1200 @ 60Hz
- Supports Auto Lip Sync, Deep Color (12bpc), xvYCC and HBR (High Bit Rate Audio) with HDMI Port (Compliant HDMI monitor is required)
- Supports HDCP with DVI-D and HDMI Ports
- Supports Full HD 1080p Blu-ray (BD) playback with DVI-D and HDMI Ports

Audio

- 7.1 CH HD Audio with Content Protection (Realtek ALC892 Audio Codec)
- Premium Blu-ray Audio support
- Supports Surge Protection (ASRock Full Spike Protection)
- Nichicon Fine Gold Series Audio Caps

LAN

- Gigabit LAN 10/100/1000 Mb/s
- Giga PHY Intel® I218V
- Supports Intel® Remote Wake Technology
- Supports Wake-On-LAN
- Supports Lightning/ESD Protection (ASRock Full Spike Protection)
- Supports Energy Efficient Ethernet 802.3az
- Supports PXE

Rear Panel I/O

- 1 x PS/2 Mouse/Keyboard Port
- 1 x D-Sub Port
- 1 x DVI-D Port
- 1 x HDMI Port
- 1 x Optical SPDIF Out Port
- 4 x USB 2.0 Ports (Supports ESD Protection (ASRock Full Spike Protection))
- 4 x USB 3.0 Ports (Supports ESD Protection (ASRock Full Spike Protection))
- 1 x RJ-45 LAN Port with LED (ACT/LINK LED and SPEED LED)
- HD Audio Jacks: Rear Speaker / Central / Bass / Line in / Front Speaker / Microphone

Storage

- 6 x SATA3 6.0 Gb/s Connectors, support RAID (RAID 0, RAID 1, RAID 5, RAID 10, Intel Rapid Storage Technology 13 and Intel Smart Response Technology), NCQ, AHCI and Hot Plug
- 1 x SATA Express Connector (shared with SATA3_4, SATA3_5 and M.2_SSD (NGFF) Socket 3)
* Support to be announced
- 1 x M.2_SSD (NGFF) Socket 3, supports M.2 SATA3 6.0 Gb/s module and M.2 PCI Express module up to Gen2 x2 (10 Gb/s)

Connector

- 1 x COM Port Header
- 1 x Chassis Intrusion Header
- 1 x TPM Header
- 1 x Power LED Header
- 2 x CPU Fan Connectors (1 x 4-pin, 1 x 3-pin)
- 2 x Chassis Fan Connectors (1 x 4-pin, 1 x 3-pin)
- 1 x Power Fan Connector (3-pin)
- 1 x 24 pin ATX Power Connector
- 1 x 8 pin 12V Power Connector
- 1 x PCIe Power Connector
- 1 x Front Panel Audio Connector
- 1 x Thunderbolt AIC Connector
- 2 x USB 2.0 Headers (Support 4 USB 2.0 ports) (Supports ESD Protection (ASRock Full Spike Protection))
- 1 x USB 3.0 Header (Supports 2 USB 3.0 ports) (Supports ESD Protection (ASRock Full Spike Protection))

- BIOS Feature**
- 64Mb AMI UEFI Legal BIOS with multilingual GUI support
 - ACPI 1.1 Compliant wake up events
 - SMBIOS 2.3.1 support
 - CPU, DRAM, PCH 1.05V, PCH 1.5V Voltage Multi-adjustment

- Support CD**
- Drivers, Utilities, AntiVirus Software (Trial Version), Google Chrome Browser and Toolbar, Start8 (30 days trial), Kloudian Orbweb.ME Professional (Win 8.1)

- Hardware Monitor**
- CPU/Chassis temperature sensing
 - CPU/Chassis/Power Fan Tachometer
 - CPU/Chassis Quiet Fan (Auto adjust chassis fan speed by CPU temperature)
 - CPU/Chassis Fan multi-speed control
 - CASE OPEN detection
 - Voltage monitoring: +12V, +5V, +3.3V, CPU Vcore

- OS**
- Microsoft® Windows® 8.1 32-bit / 8.1 64-bit / 8 32-bit / 8 64-bit / 7 32-bit / 7 64-bit

- Certifications**
- FCC, CE, WHQL
 - ErP/EuP ready (ErP/EuP ready power supply is required)

* For detailed product information, please visit our website: <http://www.asrock.com>



Please realize that there is a certain risk involved with overclocking, including adjusting the setting in the BIOS, applying Untied Overclocking Technology, or using third-party overclocking tools. Overclocking may affect your system's stability, or even cause damage to the components and devices of your system. It should be done at your own risk and expense. We are not responsible for possible damage caused by overclocking.



Due to limitation, the actual memory size may be less than 4GB for the reservation for system usage under Windows® 32-bit operating systems. Windows® 64-bit operating systems do not have such limitations. You can use ASRock XFast RAM to utilize the memory that Windows® cannot use.

1.3 Unique Features



ASRock Super Alloy

This motherboard is specially designed with Super Alloy Technology for faster, stabler, and more durable performance, including XXL Aluminum Alloy Heatsink, Premium Alloy Choke, Dual-Stack MOSFET, NexFET™ MOSFET, 12K Platinum Cap, and Sapphire Black PCB.



ASRock Full Spike Protection

A technology consists of 3 unique features: Surge Protection, Lightning Protection, and ESD Protection. By adding specialized ICs and reworking circuits, the onboard USB ports, LAN ports, and MOSFETs in critical areas are all well protected from surges, spikes, and electrostatic discharge.



ASRock Cloud

ASRock partners with Kloudian to make your mobile devices connect to your PC seamlessly! ASRock Cloud allows you to get connected with your PC's files, music, photos, and video clips remotely with tablets anytime, anywhere.

* OrbWeb ME is provided by a third party. Restriction may apply and the offer is subject to change, termination or discontinuation by the third party without prior notice. Please visit the website for further details: <http://www.asrock.com/feature/cloud/index.html>



ASRock APP Shop

ASRock APP Shop is designed for your convenience. We provide various apps and support software for users to download on the mainpage of APP Shop. You can easily optimize your system and keep your motherboard up to date with a few clicks.



ASRock A-Tuning

A-Tuning is ASRock's multi purpose software suite with a new interface, more new features and improved utilities.



ASRock Disk Health Report

Displaying detailed HDD information. You can check the model names, capacities, temperatures, SMART info, health status, and other information of your HDDs here.



ASRock USB Key

In a world where time is money, why waste precious time everyday typing usernames to log in to Windows? Why should we even bother memorizing those foot long passwords? Just plug in the USB Key and let your computer log in to windows automatically!



ASRock APP Charger

Simply by installing the ASRock APP Charger makes your iPhone/iPad/iPod Touch charge up to 40% faster than before on your computer. ASRock APP Charger allows you to quickly charge many Apple devices simultaneously and even supports continuous charging when your PC enters into Standby mode (S1), Suspend to RAM (S3), hibernation mode (S4) or power off (S5).



ASRock XFast LAN

ASRock XFast LAN provides faster internet access, which includes the benefits listed below. LAN Application Prioritization: You can configure your application's priority ideally and add new programs to the list. Lower Latency in Game: After setting online game's priority higher, it can lower the latency in games. Traffic Shaping: You can watch Youtube HD videos and download simultaneously. Real-Time Analysis of Your Data: With the status window, you can easily recognize which data streams you are currently transferring.



ASRock XFast RAM

ASRock XFast RAM is included in A-Tuning. It fully utilizes the memory space that cannot be used under Windows® 32-bit operating systems. ASRock XFast RAM shortens the loading time of previously visited websites, making web surfing faster than ever. And it also boosts the speed of Adobe Photoshop 5 times faster. Another advantage of ASRock XFast RAM is that it reduces the frequency of accessing your SSDs or HDDs in order to extend their lifespan.



ASRock Restart to UEFI

Windows® 8 brings the ultimate boot up experience. The lightning boot up speed makes it hard to access the UEFI setup. ASRock Restart to UEFI allows users to enter the UEFI automatically when turning on the PC. By enabling this function, the PC will enter the UEFI directly after you restart.



ASRock Full HD UEFI

All new Full HD UEFI with a resolution of 1920 x 1080. The UEFI should be designed easy to use and setup. With Full HD resolution, now it is much easier and clearer for all users to setup, optimize, and update their BIOS.



ASRock My Favorites in UEFI

Another handy design in ASRock UEFI. You can select and add commonly used BIOS options to "My Favorites" by clicking the asterisk icon at the upper right hand corner of the screen. These chosen options will show up on "My Favorites" page in UEFI.



ASRock UEFI Guide

Need help to optimize your UEFI setting? Got lost among UEFI pages? Just select “UEFI Guide”! The tutorial will explain every detailed setting and help you to customize your UEFI easily.



ASRock Instant Flash

ASRock Instant Flash is a BIOS flash utility embedded in Flash ROM. This convenient BIOS update tool allows you to update the system BIOS in a few clicks without preparing an additional floppy diskette or other complicated flash utility. Just save the new BIOS file to your USB storage and launch this tool by pressing <F6> or <F2> during POST to enter the BIOS setup menu to access ASRock Instant Flash. Please be noted that the USB flash drive or hard drive must use FAT32/16/12 file system.



ASRock Internet Flash

ASRock Internet Flash downloads and updates the latest UEFI firmware version from our servers for you without entering Windows OS. Please setup network configuration before using Internet Flash.



ASRock Crashless BIOS

ASRock Crashless BIOS allows users to update their BIOS without fear of failing. If power loss occurs during the BIOS updating process, ASRock Crashless BIOS will automatically finish the BIOS update procedure after regaining power. Please note that BIOS files need to be placed in the root directory of your USB disk. Only USB 2.0 ports support this feature.



ASRock OMG (Online Management Guard)

Administrators are able to establish an internet curfew or restrict internet access at specified times via OMG. You may schedule the starting and ending hours of internet access granted to other users. In order to prevent users from bypassing OMG, guest accounts without permission to modify the system time are required.



ASRock UEFI System Browser

ASRock System Browser shows the overview of your current PC and the devices connected.



ASRock UEFI Tech Service

Contact ASRock Tech Service by sending a support request from the UEFI setup utility if you are having trouble with your PC.



ASRock Dehumidifier Function

Users may prevent motherboard damages due to dampness by enabling “Dehumidifier Function”. When enabling Dehumidifier Function, the computer will power on automatically to dehumidify the system after entering S4/S5 state.



ASRock Easy RAID Installer

ASRock Easy RAID Installer can help you to copy the RAID driver from the support CD to your USB storage device. After copying the RAID driver to your USB storage device, please change “SATA Mode” to “RAID”, then you can start installing the OS in RAID mode.



ASRock Easy Driver Installer

For users that don't have an optical disk drive to install the drivers from our support CD, Easy Driver Installer is a handy tool in the UEFI that installs the LAN driver to your system via an USB storage device, then downloads and installs the other required drivers automatically.

1.4 Motherboard Layout

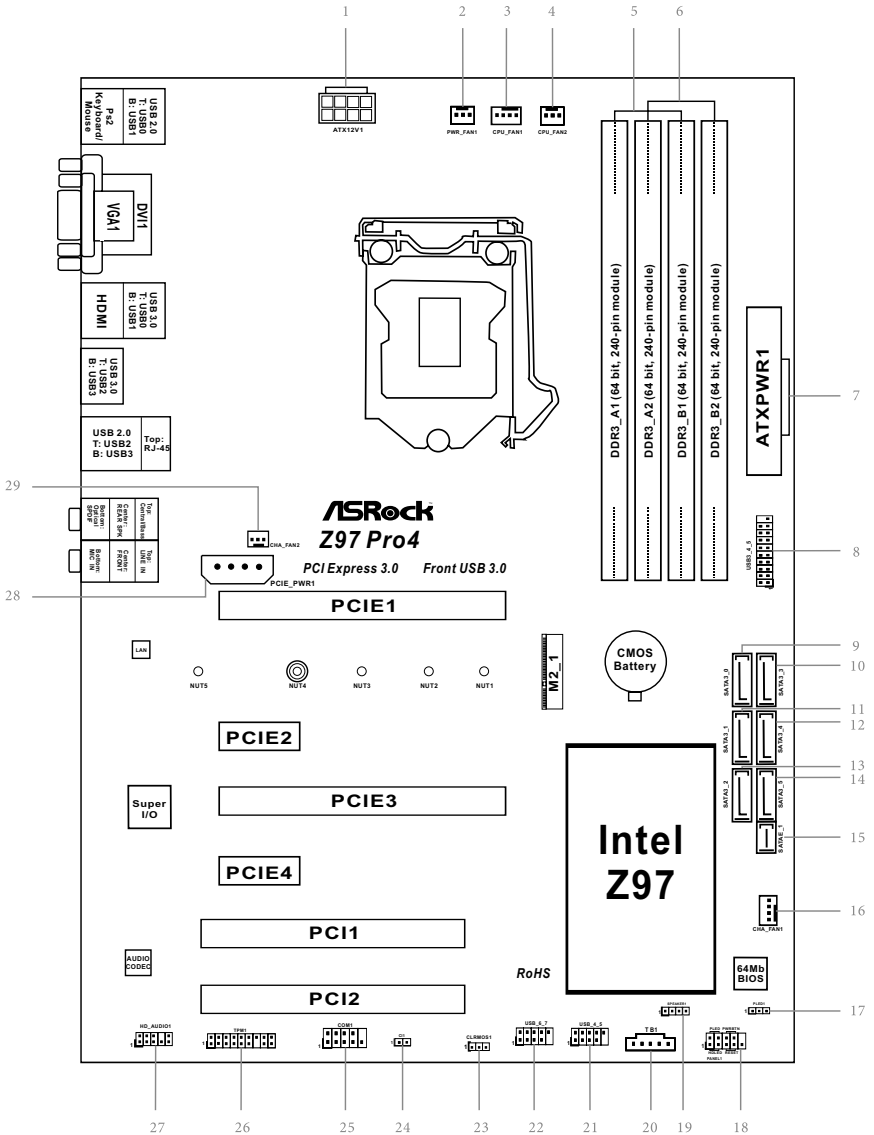

No.	Description
1	ATX 12V Power Connector (ATX12V1)
2	Power Fan Connector (PWR_FAN1)
3	CPU Fan Connector (CPU_FAN1)
4	CPU Fan Connector (CPU_FAN2)
5	2 x 240-pin DDR3 DIMM Slots (DDR3_A1, DDR3_B1)
6	2 x 240-pin DDR3 DIMM Slots (DDR3_A2, DDR3_B2)
7	ATX Power Connector (ATXPWR1)
8	USB 3.0 Header (USB_4_5)
9	SATA3 Connector (SATA3_0)
10	SATA3 Connector (SATA3_3)
11	SATA3 Connector (SATA3_1)
12	SATA3 Connector (SATA3_4)
13	SATA3 Connector (SATA3_2)
14	SATA3 Connector (SATA3_5)
15	SATA Express Connector (SATAE_1)
16	Chassis Fan Connector (CHA_FAN1)
17	Power LED Header (PLED1)
18	System Panel Header (PANEL1)
19	Chassis Speaker Header (SPEAKER1)
20	Thunderbolt AIC Connector (TB1)
21	USB 2.0 Header (USB_4_5)
22	USB 2.0 Header (USB_6_7)
23	Clear CMOS Jumper (CLRCMOS1)
24	Chassis Intrusion Header (CI1)
25	COM Port Header (COM1)
26	TPM Header (TPM1)
27	Front Panel Audio Header (HD_AUDIO1)
28	PCIe Power Connector (PCIE_PWR1)
29	Chassis Fan Connector (CHA_FAN2)

1.5 I/O Panel

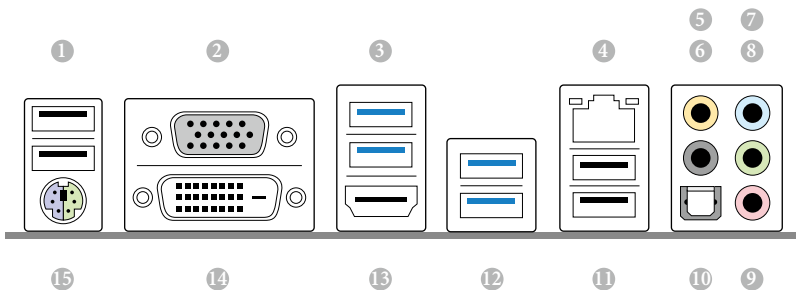

No.	Description	No.	Description
1	USB 2.0 Ports (USB01)	9	Microphone (Pink)
2	D-Sub Port	10	Optical SPDIF Out Port
3	USB 3.0 Ports (USB3_0_1)	11	USB 2.0 Ports (USB23)
4	LAN RJ-45 Port*	12	USB 3.0 Ports (USB3_2_3)
5	Central / Bass (Orange)	13	HDMI Port
6	Rear Speaker (Black)	14	DVI-D Port
7	Line In (Light Blue)	15	PS/2 Mouse/Keyboard Port
8	Front Speaker (Lime)**		

* There are two LEDs on each LAN port. Please refer to the table below for the LAN port LED indications.

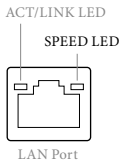

Activity / Link LED		Speed LED	
Status	Description	Status	Description
Off	No Link	Off	10Mbps connection
Blinking	Data Activity	Orange	100Mbps connection
On	Link	Green	1Gbps connection

** If you use a 2-channel speaker, please connect the speaker's plug into "Front Speaker Jack". See the table below for connection details in accordance with the type of speaker you use.

Audio Output Channels	Front Speaker (No. 8)	Rear Speaker (No. 6)	Central / Bass (No. 5)	Line In (No. 7)
2	V	--	--	--
4	V	V	--	--
6	V	V	V	--
8	V	V	V	V



To enable Multi-Streaming, you need to connect a front panel audio cable to the front panel audio header. After restarting your computer, you will find the "Mixer" tool on your system. Please select "Mixer ToolBox" , click "Enable playback multi-streaming", and click "ok". Choose "2CH", "4CH", "6CH", or "8CH" and then you are allowed to select "Realtek HDA Primary output" to use the Rear Speaker, Central/Bass, and Front Speaker, or select "Realtek HDA Audio 2nd output" to use the front panel audio.

Chapter 2 Installation

This is an ATX form factor motherboard. Before you install the motherboard, study the configuration of your chassis to ensure that the motherboard fits into it.

Pre-installation Precautions

Take note of the following precautions before you install motherboard components or change any motherboard settings.

- Make sure to unplug the power cord before installing or removing the motherboard components. Failure to do so may cause physical injuries and damages to motherboard components.
- In order to avoid damage from static electricity to the motherboard's components, NEVER place your motherboard directly on a carpet. Also remember to use a grounded wrist strap or touch a safety grounded object before you handle the components.
- Hold components by the edges and do not touch the ICs.
- Whenever you uninstall any components, place them on a grounded anti-static pad or in the bag that comes with the components.
- When placing screws to secure the motherboard to the chassis, please do not over-tighten the screws! Doing so may damage the motherboard.

2.1 Installing the CPU



1. Before you insert the 1150-Pin CPU into the socket, please check if the **PnP cap** is on the socket, if the CPU surface is unclean, or if there are any **bent pins** in the socket. Do not force to insert the CPU into the socket if above situation is found. Otherwise, the CPU will be seriously damaged.
2. Unplug all power cables before installing the CPU.

1

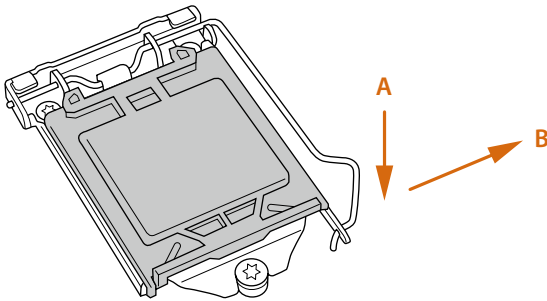

2

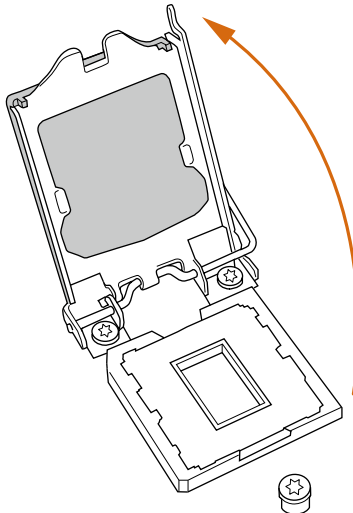

3

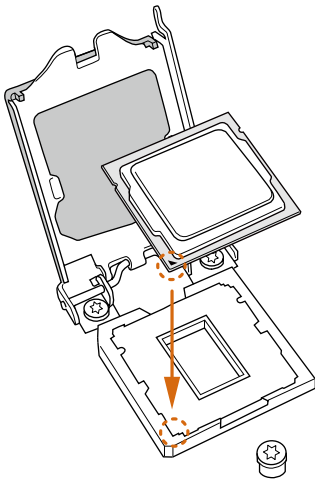

4

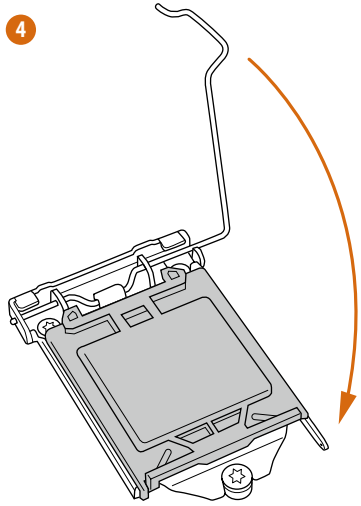

5

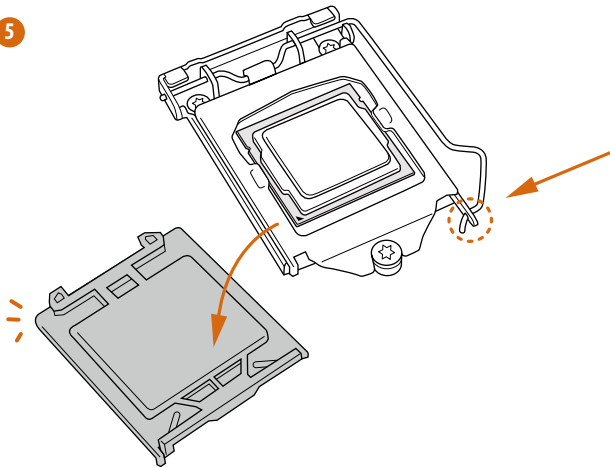



Please save and replace the cover if the processor is removed. The cover must be placed if you wish to return the motherboard for after service.

2.2 Installing the CPU Fan and Heatsink

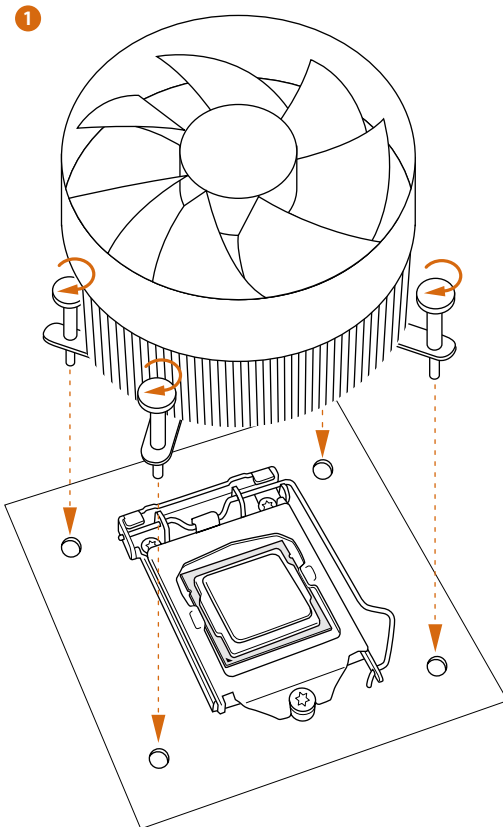
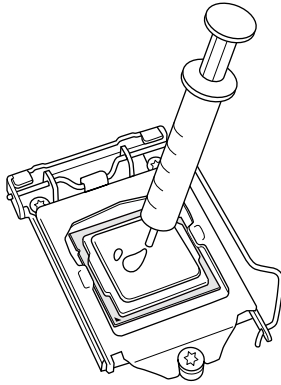

2.3 Installing Memory Modules (DIMM)

This motherboard provides four 240-pin DDR3 (Double Data Rate 3) DIMM slots, and supports Dual Channel Memory Technology.



1. For dual channel configuration, you always need to install identical (the same brand, speed, size and chip-type) DDR3 DIMM pairs.
2. It is unable to activate Dual Channel Memory Technology with only one or three memory module installed.
3. It is not allowed to install a DDR or DDR2 memory module into a DDR3 slot; otherwise, this motherboard and DIMM may be damaged.

Dual Channel Memory Configuration

Priority	DDR3_A1	DDR3_A2	DDR3_B1	DDR3_B2
1		Populated		Populated
2	Populated		Populated	
3	Populated	Populated	Populated	Populated



The DIMM only fits in one correct orientation. It will cause permanent damage to the motherboard and the DIMM if you force the DIMM into the slot at incorrect orientation.

1

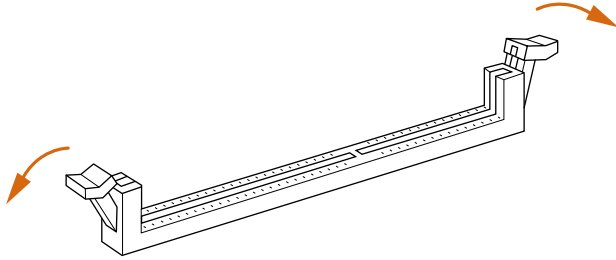

2

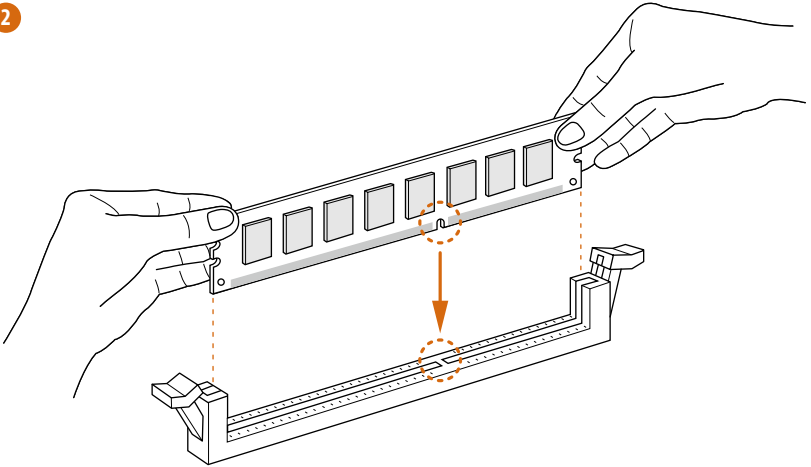

3

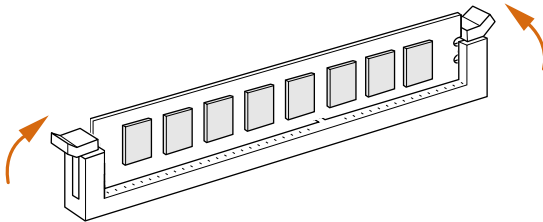

2.4 Expansion Slots (PCI and PCI Express Slots)

There are 2 PCI slots and 4 PCI Express slots on the motherboard.



Before installing an expansion card, please make sure that the power supply is switched off or the power cord is unplugged. Please read the documentation of the expansion card and make necessary hardware settings for the card before you start the installation.

PCI slots:

The PCI1 and PCI2 slots are used to install expansion cards that have 32-bit PCI interface.

PCIe slots:

PCIE1 (PCIe 3.0 x16 slot) is used for PCI Express x16 lane width graphics cards.

PCIE2 (PCIe 2.0 x1 slot) is used for PCI Express x1 lane width cards.

PCIE3 (PCIe 2.0 x16 slot) is used for PCI Express x4 lane width graphics cards.

PCIE4 (PCIe 2.0 x1 slot) is used for PCI Express x1 lane width cards.

PCIe Slot Configurations

	PCIE1	PCIE3
Single Graphics Card	x16	N/A
Two Graphics Cards in CrossFireX™ Mode	x16	x4



For a better thermal environment, please connect a chassis fan to the motherboard's chassis fan connector (CHA_FAN1 or CHA_FAN2) when using multiple graphics cards.

2.5 Jumpers Setup

The illustration shows how jumpers are setup. When the jumper cap is placed on the pins, the jumper is “Short”. If no jumper cap is placed on the pins, the jumper is “Open”. The illustration shows a 3-pin jumper whose pin1 and pin2 are “Short” when a jumper cap is placed on these 2 pins.

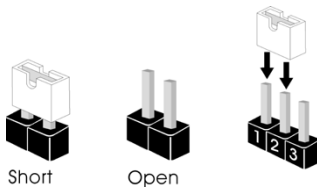

Clear CMOS Jumper
(CLRCMOS1)
(see p.10, No. 23)

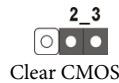

CLRCMOS1 allows you to clear the data in CMOS. To clear and reset the system parameters to default setup, please turn off the computer and unplug the power cord from the power supply. After waiting for 15 seconds, use a jumper cap to short pin2 and pin3 on CLRCMOS1 for 5 seconds. However, please do not clear the CMOS right after you update the BIOS. If you need to clear the CMOS when you just finish updating the BIOS, you must boot up the system first, and then shut it down before you do the clear-CMOS action. Please be noted that the password, date, time, and user default profile will be cleared only if the CMOS battery is removed.

2.6 Onboard Headers and Connectors



Onboard headers and connectors are NOT jumpers. Do NOT place jumper caps over these headers and connectors. Placing jumper caps over the headers and connectors will cause permanent damage to the motherboard.

System Panel Header
(9-pin PANEL1)
(see p.10, No. 18)

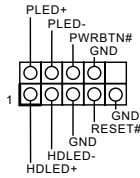

Connect the power switch, reset switch and system status indicator on the chassis to this header according to the pin assignments below. Note the positive and negative pins before connecting the cables.



PWRBTN (Power Switch):

Connect to the power switch on the chassis front panel. You may configure the way to turn off your system using the power switch.

RESET (Reset Switch):

Connect to the reset switch on the chassis front panel. Press the reset switch to restart the computer if the computer freezes and fails to perform a normal restart.

PLED (System Power LED):

Connect to the power status indicator on the chassis front panel. The LED is on when the system is operating. The LED keeps blinking when the system is in S1/S3 sleep state. The LED is off when the system is in S4 sleep state or powered off (S5).

HDLED (Hard Drive Activity LED):

Connect to the hard drive activity LED on the chassis front panel. The LED is on when the hard drive is reading or writing data.

The front panel design may differ by chassis. A front panel module mainly consists of power switch, reset switch, power LED, hard drive activity LED, speaker and etc. When connecting your chassis front panel module to this header, make sure the wire assignments and the pin assignments are matched correctly.

Power LED Header
(3-pin PLED1)
(see p.10, No. 17)

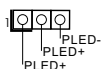

Please connect the chassis power LED to this header to indicate the system's power status.

Serial ATA3 Connectors
(SATA3_0:
see p.10, No. 9)
(SATA3_1:
see p.10, No. 11)
(SATA3_2:
see p.10, No. 13)
(SATA3_3:
see p.10, No. 10)
(SATA3_4:
see p.10, No. 12)
(SATA3_5:
see p.10, No. 14)

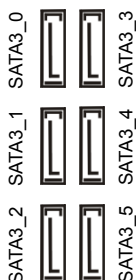

These six SATA3 connectors support SATA data cables for internal storage devices with up to 6.0 Gb/s data transfer rate. The SATA3_4, SATA3_5 are shared with the SATA Express connector.

Serial ATA Express Connector
(SATAE_1:
see p.10, No. 15)



Please connect either SATA or PCIe storage devices to this connector. The SATA Express connector is shared with the SATA3_4, SATA3_5 and the M.2_SSD (NGFF) Socket 3.



*The SATA Express interface is a combination of SATAE_1, SATA3_4, and SATA3_5.

USB 2.0 Headers
(9-pin USB_4_5)
(see p.10, No. 21)
(9-pin USB_6_7)
(see p.10, No. 22)

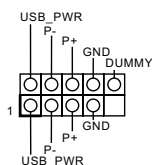

Besides four USB 2.0 ports on the I/O panel, there are two headers on this motherboard. Each USB 2.0 header can support two ports.

USB 3.0 Header

(19-pin USB3_4_5)

(see p.10, No. 8)

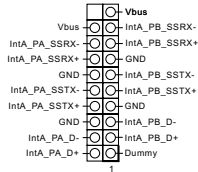

Besides four USB 3.0 ports on the I/O panel, there is one header on this motherboard. Each USB 3.0 header can support two ports.

Front Panel Audio Header

(9-pin HD_AUDIO1)

(see p.10, No. 27)

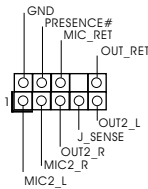

This header is for connecting audio devices to the front audio panel.



- High Definition Audio supports Jack Sensing, but the panel wire on the chassis must support HDA to function correctly. Please follow the instructions in our manual and chassis manual to install your system.
- If you use an AC'97 audio panel, please install it to the front panel audio header by the steps below:
 - Connect Mic_IN (MIC) to MIC2_L.
 - Connect Audio_R (RIN) to OUT2_R and Audio_L (LIN) to OUT2_L.
 - Connect Ground (GND) to Ground (GND).
 - MIC_RET and OUT_RET are for the HD audio panel only. You don't need to connect them for the AC'97 audio panel.
 - To activate the front mic, go to the "FrontMic" Tab in the Realtek Control panel and adjust "Recording Volume".

Chassis Speaker Header

(4-pin SPEAKER1)

(see p.10, No. 19)

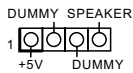

Please connect the chassis speaker to this header.

Chassis and Power Fan Connectors

(4-pin CHA_FAN1)

(see p.10, No. 16)

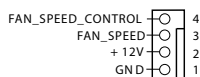

Please connect fan cables to the fan connectors and match the black wire to the ground pin.

(3-pin CHA_FAN2)

(see p.10, No. 29)

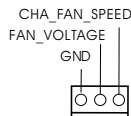

(3-pin PWR_FAN1)
(see p.10, No. 2)

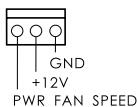

CPU Fan Connectors
(4-pin CPU_FAN1)
(see p.10, No. 3)

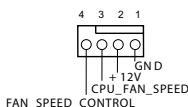

(3-pin CPU_FAN2)
(see p.10, No. 4)

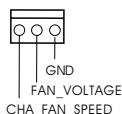

This motherboard provides a 4-Pin CPU fan (Quiet Fan) connector. If you plan to connect a 3-Pin CPU fan, please connect it to Pin 1-3.

ATX Power Connector
(24-pin ATXPWR1)
(see p.10, No. 7)

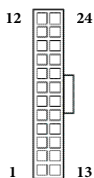

This motherboard provides a 24-pin ATX power connector. To use a 20-pin ATX power supply, please plug it along Pin 1 and Pin 13.

ATX 12V Power Connector
(8-pin ATX12V1)
(see p.10, No. 1)

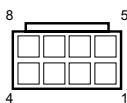

This motherboard provides an 8-pin ATX 12V power connector. To use a 4-pin ATX power supply, please plug it along Pin 1 and Pin 5.

PCIe Power Connector
(4-pin PCIE_PWR1)
(see p.10, No. 28)

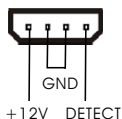

Please connect a 4 pin molex power cable to this connector when more than three graphics cards are installed.

Thunderbolt AIC Connector
(5-pin TB1)
(see p.10, No. 20)

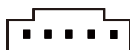

Please connect a 5-pin signal cable (GPIO cable) to this connector when you install a Thunderbolt™ add-in card (AIC).

Serial Port Header
(9-pin COM1)
(see p.10, No. 25)

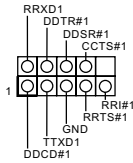

This COM1 header supports a serial port module.

Chassis Intrusion Header
(2-pin CII)
(see p.10, No. 24)



This motherboard supports CASE OPEN detection feature that detects if the chassis cover has been removed. This feature requires a chassis with chassis intrusion detection design.

TPM Header
(17-pin TPMS1)
(see p.10, No. 26)

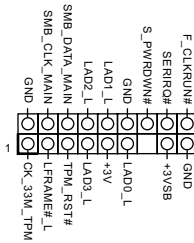

This connector supports Trusted Platform Module (TPM) system, which can securely store keys, digital certificates, passwords, and data. A TPM system also helps enhance network security, protects digital identities, and ensures platform integrity.

2.7 CrossFireX™ and Quad CrossFireX™ Operation Guide

This motherboard supports CrossFireX™ and Quad CrossFireX™ that allows you to install up to two identical PCI Express x16 graphics cards. Currently CrossFireX™ and Quad CrossFireX™ are supported with Windows® 7 / 7 64-bit / 8 / 8 64-bit / 8.1 / 8.1 64-bit OS.



1. You should only use identical CrossFireX™-ready graphics cards that are AMD certified.
2. Make sure that your graphics card driver supports AMD CrossFireX™ technology. Download the drivers from the AMD's website: www.amd.com
3. Make sure that your power supply unit (PSU) can provide at least the minimum power your system requires. It is recommended to use a AMD certified PSU. Please refer to the AMD's website for details.
4. If you pair a 12-pipe CrossFireX™ Edition card with a 16-pipe card, both cards will operate as 12-pipe cards while in CrossFireX™ mode.
5. Different CrossFireX™ cards may require different methods to enable CrossFireX™. Please refer to AMD graphics card manuals for detailed installation guide.

2.7.1 Installing Two CrossFireX™-Ready Graphics Cards

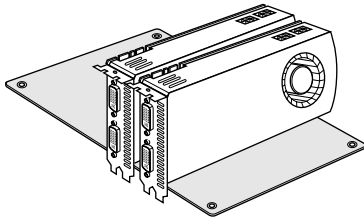

Step 1

Insert one graphics card into PCIE1 slot and the other graphics card to PCIE3 slot. Make sure that the cards are properly seated on the slots.



CrossFire Bridge

Step 2

Connect two graphics cards by installing a CrossFire Bridge on the CrossFire Bridge Interconnects on the top of the graphics cards. (The CrossFire Bridge is provided with the graphics card you purchase, not bundled with this motherboard. Please refer to your graphics card vendor for details.)

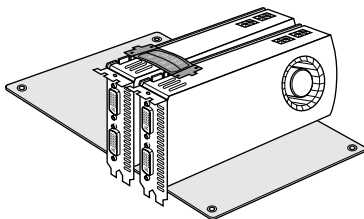

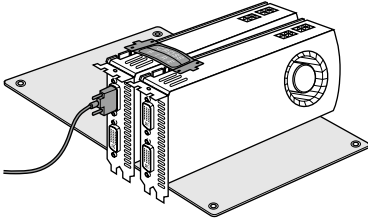
**Step 3**

Connect a VGA cable or a DVI cable to the monitor connector or the DVI connector of the graphics card that is inserted to PCIe1 slot.

2.7.2 Driver Installation and Setup

Step 1

Power on your computer and boot into OS.

Step 2

Remove the AMD drivers if you have any VGA drivers installed in your system.



The Catalyst Uninstaller is an optional download. We recommend using this utility to uninstall any previously installed Catalyst drivers prior to installation. Please check AMD's website for AMD driver updates.

Step 3

Install the required drivers and CATALYST Control Center then restart your computer. Please check AMD's website for details.



AMD Catalyst Control Center

Step 4

Double-click the **AMD Catalyst Control Center** icon in the Windows' system tray.

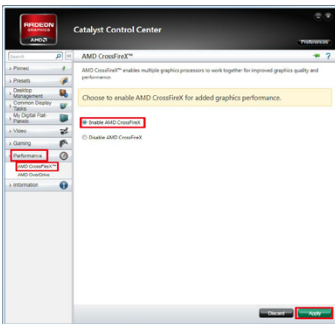

Step 5

In the left pane, click **Performance** and then **AMD CrossFireX™**. Then select **Enable AMD CrossFireX** and click **Apply**. Select the GPU number according to your graphics card and click **Apply**.

2.8 M.2_SSD (NGFF) Module Installation Guide

The M.2, also known as the Next Generation Form Factor (NGFF), is a small size and versatile card edge connector that aims to replace mPCIe and mSATA. The M.2_SSD (NGFF) Socket 3 can accommodate either a M.2 SATA3 6.0 Gb/s module or a M.2 PCI Express module up to Gen 2 x2 (10 Gb/s). Please be noted that the M.2_SSD (NGFF) Socket 3 is shared with the SATA Express connector; you can only choose either the M.2_SSD (NGFF) Socket 3 or the SATA Express connector to use.

*The M.2_SSD (NGFF) Socket 3 supports SSD drives. Please note that the WiFi or other non-SSD M.2 modules are not supported.

Installing the M.2_SSD (NGFF) Module

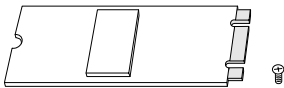

Step 1

Prepare a M.2_SSD (NGFF) module and the screw.

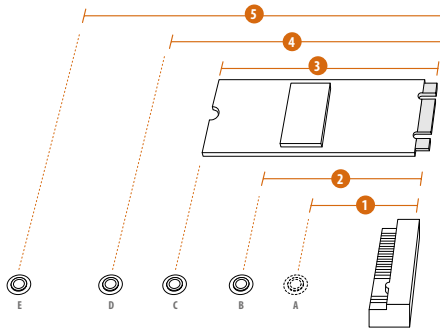

Step 2

Depending on the PCB type and length of your M.2_SSD (NGFF) module, find the corresponding nut location to be used.

No.	1	2	3	4	5
Nut Location	A	B	C	D	E
PCB Length	3cm	4.2cm	6cm	8cm	11cm
Module Type	Type 2230	Type 2242	Type 2260	Type 2280	Type 22110

Step 3



Move the standoff based on the module type and length. The standoff is placed at the nut location D by default. Skip Step 3 and 4 and go straight to Step 5 if you are going to use the default nut. Otherwise, release the standoff by hand.

Step 4

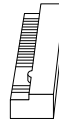

Peel off the yellow protective film on the nut to be used. Hand tighten the standoff into the desired nut location on the motherboard.

Step 5

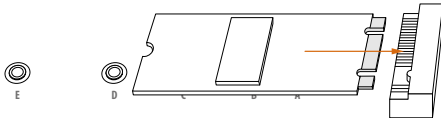
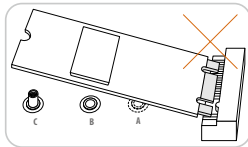

Align and gently insert the M.2 (NGFF) SSD module into the M.2 slot. Please be aware that the M.2 (NGFF) SSD module only fits in one orientation.

Step 6

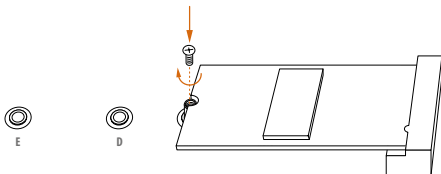

Tighten the screw with a screwdriver to secure the module into place. Please do not overtighten the screw as this might damage the module.

M.2_SSD (NGFF) Module Support List

PCIe Interface	SATA Interface
Plextor PX-AG256M6e	ADATA AXNS381E-128GM-B
Plextor PX-AG512M6e	ADATA AXNS381E-256GM-B
SanDisk SD6PP4M-128G	Crucial CT120M500SSD4/120G
SanDisk SD6PP4M-256G	Crucial CT240M500SSD4/240G
Samsung XP941-512G (MZHPU512HCGL)	Intel SSDSCKGW080A401/80G
	Kingston RBU-SNS8400S3/180GD

For the latest updates of M.2_SSD (NFGG) module support list, please visit our website for details: <http://www.asrock.com>

Chapter 3 Software and Utilities Operation

3.1 Installing Drivers

The Support CD that comes with the motherboard contains necessary drivers and useful utilities that enhance the motherboard's features.

Running The Support CD

To begin using the support CD, insert the CD into your CD-ROM drive. The CD automatically displays the Main Menu if "AUTORUN" is enabled in your computer. If the Main Menu does not appear automatically, locate and double click on the file "ASRSETUP.EXE" in the Support CD to display the menu.

Drivers Menu

The drivers compatible to your system will be auto-detected and listed on the support CD driver page. Please click **Install All** or follow the order from top to bottom to install those required drivers. Therefore, the drivers you install can work properly.

Utilities Menu

The Utilities Menu shows the application software that the motherboard supports. Click on a specific item then follow the installation wizard to install it.



To improve Windows 7 compatibility, please download and install the following hot fix provided by Microsoft.

"KB2720599": <http://support.microsoft.com/kb/2720599/en-us>

3.2 A-Tuning

A-Tuning is ASRock's multi purpose software suite with a new interface, more new features and improved utilities, including XFast RAM, Dehumidifier, Good Night LED, FAN-Tastic Tuning, OC Tweaker and a whole lot more.

3.2.1 Installing A-Tuning

When you install the all-in-one driver to your system from ASRock's support CD, A-Tuning will be auto-installed as well. After the installation, you will find the icon "A-Tuning" on your desktop. Double-click the "A-Tuning" icon, A-Tuning main menu will pop up.



3.2.2 Using A-Tuning

There are six sections in A-Tuning main menu: Operation Mode, Tools, OC Tweaker, System Info, Live Update, Tech Service and Settings.

Operation Mode

Choose an operation mode for your computer.

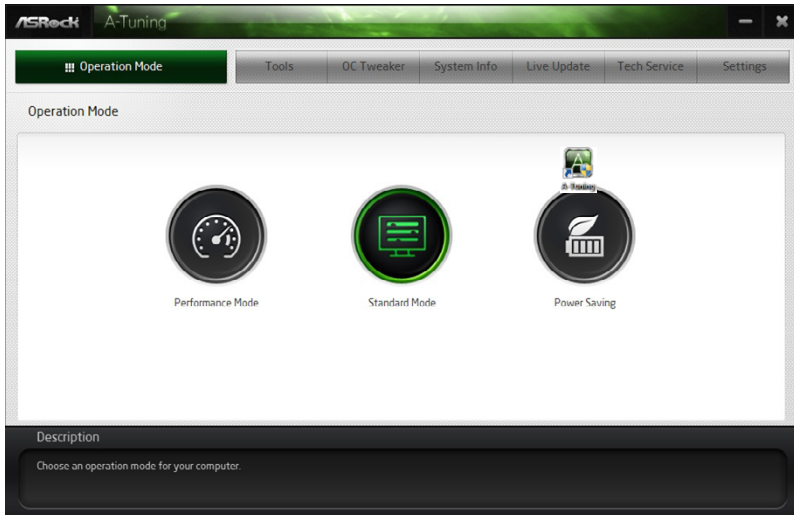

Tools

Various tools and utilities.

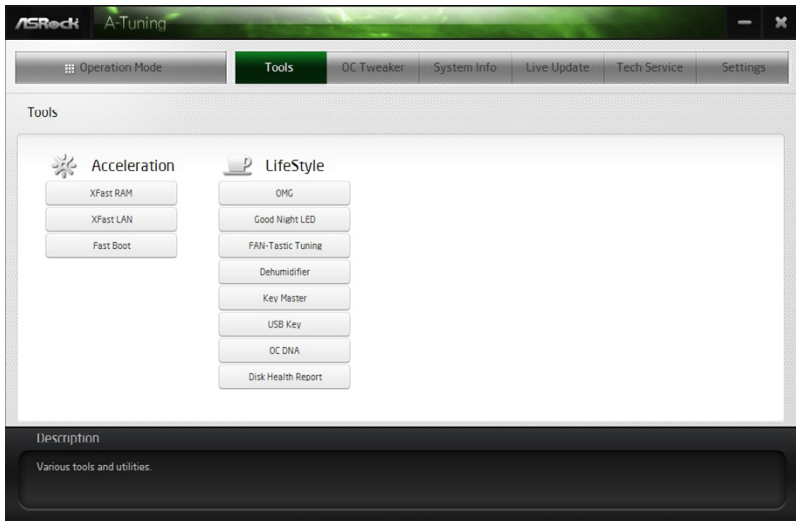

XFast RAM

Boost the system's performance and extend the HDD's or SSD's lifespan! Create a hidden partition, then assign which files should be stored in the RAM drive.

XFast LAN

Boost the speed of your internet connection! Select a specific mode for making the designated program's priority highest.

Fast Boot

Fast Boot minimizes your computer's boot time. Please note that Ultra Fast mode is only supported by Windows 8.1/8 and the VBIOS must support UEFI GOP if you are using an external graphics card.

OMG

Schedule the starting and ending hours of Internet access granted to other users. Place X marks on the time table to disable the Internet.

Good Night LED

Switch off the Power/HDD LEDs when the system is on, and automatically switch off the Power and Keyboard LEDs when the system enters into Standby/Hibernation mode.

FAN-Tastic Tuning

Configure up to five different fan speeds using the graph. The fans will automatically shift to the next speed level when the assigned temperature is met.

Dehumidifier

Prevent motherboard damages due to dampness. Enable this function and configure the period of time until the computer powers on, and the duration of the dehumidifying process.

USB Key

Plug in the USB Key and let your computer log in to windows automatically!

OC DNA

OC DNA is an unique software which helps to save your OC settings as a profile. Then you can send this OC setting profile to the friends.

Disk Health Report

Disk Health Report is a hard disk health monitoring utility that displays detailed HDD information, such as hard disk model, serial number, firmware, power on count, power on hours, S.M.A.R.T. values, current temperature, etc. HDD, SSD and optical disk drives are all supported. The health status block displays Good (in green color), Caution (in yellow color) or Bad (in red color). Click on the health status icon to configure settings for an alert to be triggered.

OC Tweaker

Configurations for overclocking the system.

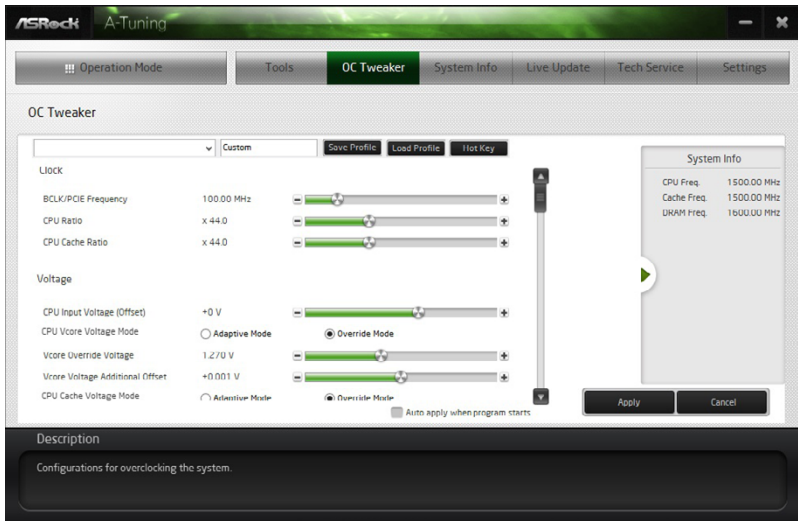

System Info

View information about the system.

*The System Browser tab may not appear for certain models.

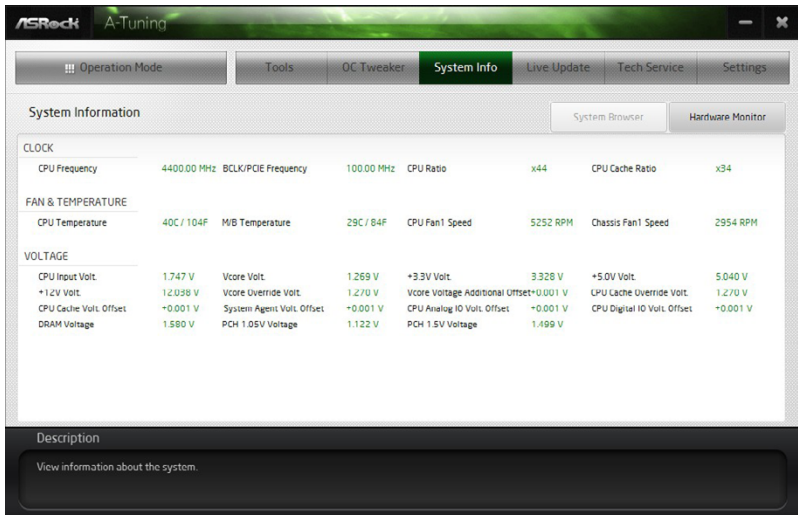

Live Update

Check for newer versions of BIOS or drivers.

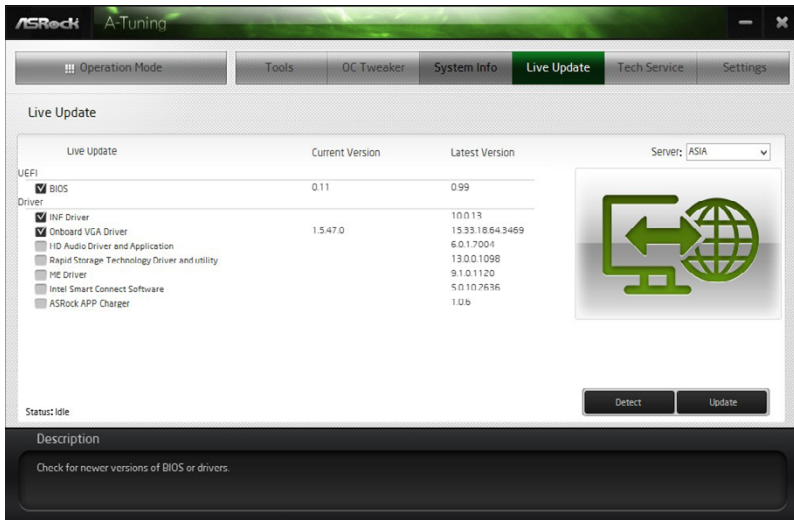

Tech Service

Contact Tech Service if you have problems with your computer. Please leave your contact information along with details of the problem.

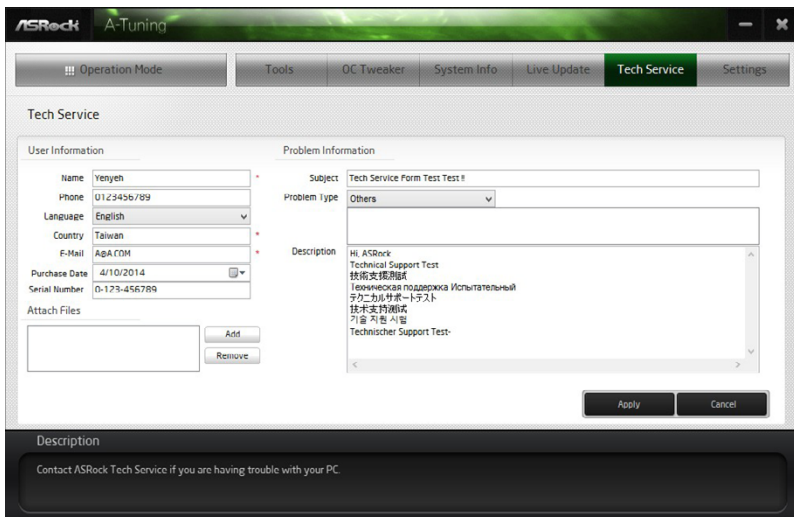

Settings

Configure ASRock A-Tuning. Click to select "Auto run at Windows Startup" if you want A-Tuning to be launched when you start up the Windows operating system.

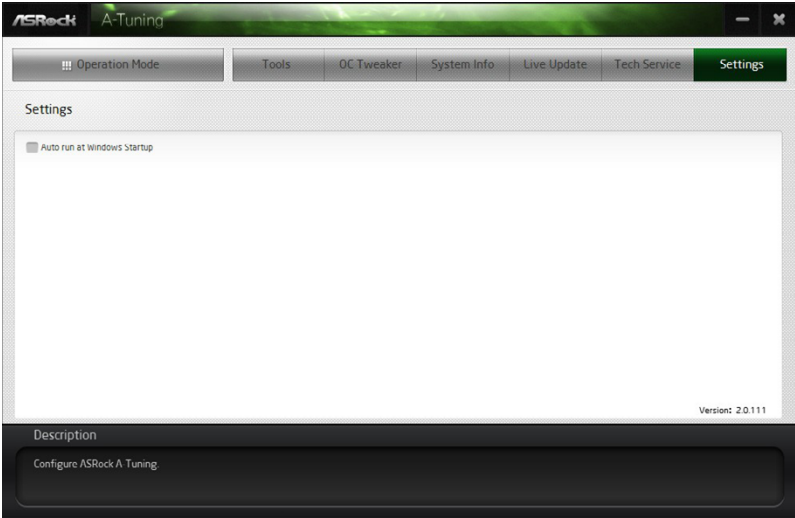

3.3 Intel® Rapid Start Technology

Intel® Rapid Start Technology enables your system to wake up faster from deep sleep, saving time and power consumption. Feel secure to know that your system will resume to working condition even if an unexpected power loss happens while the PC is in sleep mode.

3.3.1 System Requirements

- Confirm whether your motherboard supports this feature.
- Operating system: Microsoft Windows 8.1/8/7 (32- or 64-bit edition)
- Set the SATA mode to AHCI. If Windows 8.1/8/7 is already installed under IDE mode, directly changing the SATA mode to AHCI may cause Windows 8.1/8/7 to crash while booting. If your system is not in AHCI mode, please follow the instructions below.



There are certain risks. Please backup any important data before operating to avoid loss.

1. Press **Win + R** simultaneously in Windows 8.1/8/7, type "Regedit" into the word box then click **OK**.

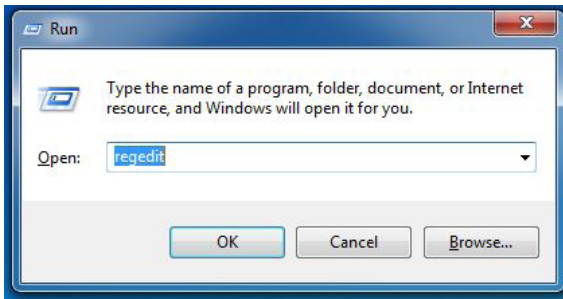

2. Enter into **HKEY_LOCAL_MACHINE\SYSTEM\CurrentControlSet\services\msahci** in Windows Registry Editor. Double click on the value **Start** and change the value from **3** into **0**. Click on **OK**.

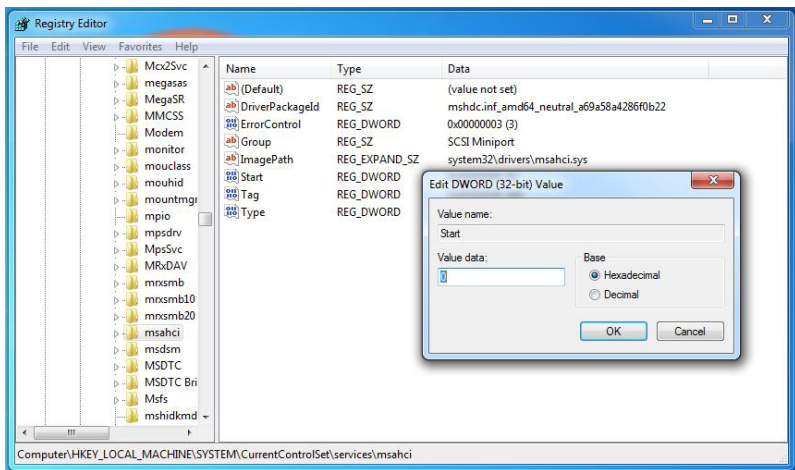

3. Exit the Registry Editor window and restart the computer.
4. Press **F2** to enter BIOS, then go to **Advanced** -> **Storage Configuration** and change SATA Mode to **AHCI**. Press **F10** to save changes and exit.
5. Enter Windows 8.1/8/7. Windows will discover the new device and install AHCI drivers automatically.

3.3.2 Setup Guide

Configuring Rapid Start

Step 1

Run ASRock Rapid Start utility from **Start** -> **All Programs** -> **ASRock Utility**.

Step 2

If you have more than one hard drives in your system, you must select one, then choose the **Partition Size** desired for your hidden partition and click on **Create**. The system will automatically create a hidden partition according to your settings. If there are SSD's installed into your system, it is recommended to create the partition on the SSD.



Step 3

When prompted to restart after the setup, click **Yes** to reboot.

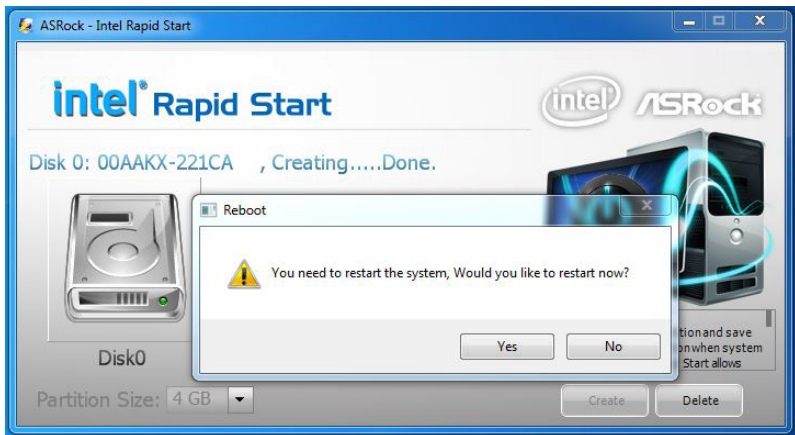

Step 4

Double-click the Intel® Rapid Start Technology Manager icon  in the Windows system tray.

Step 5

Make sure Rapid Start is on. Drag the slider to configure the time. For example, if the timer value is set to ten minutes, the system will enable Rapid Start mode after entering sleep state for ten minutes. If the timer is set to 0 minutes, Windows will immediately enable Rapid Start mode as it enters sleep state.

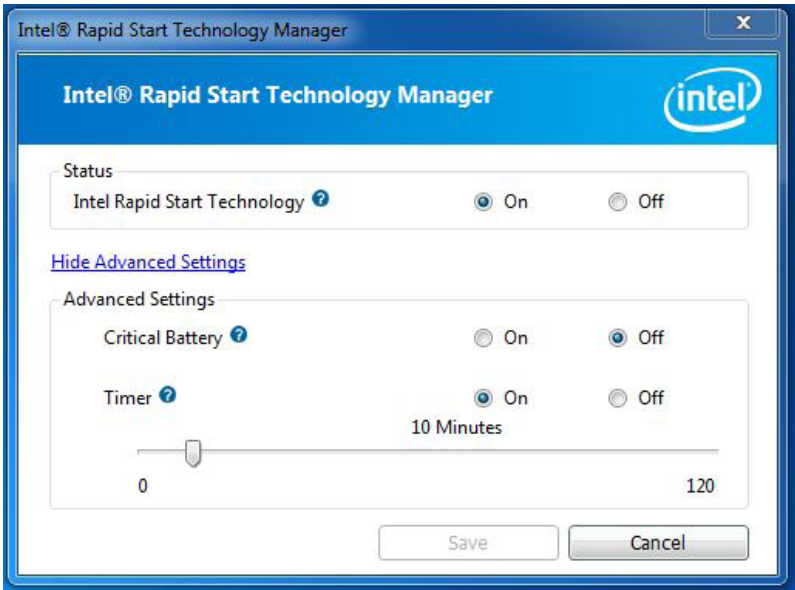

Using Rapid Start

1. You may shut down the computer without terminating the applications or files you are executing currently. Click on Windows Start -> the arrow next to Shut down, and click on **Sleep**.

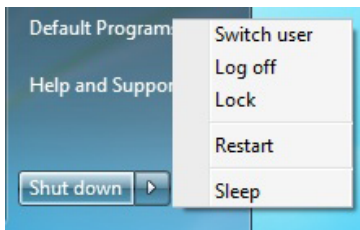

2. Windows system will enter sleep state.
3. According to your settings in Rapid Start Technology Manager, the system will automatically wake up and enable Rapid Start mode after entering sleep

state for a period of time. The power of the computer in Rapid Start mode can be cut off, it will not cause data loss of the programs or files you were executing before entering sleep state.

4. When you wish to continue to use the computer just hit the power button, the system will rapidly return to Windows, the programs and files which you were using before entering sleep state will be accessible immediately.

3.4 Intel® Smart Connect Technology

Intel® Smart Connect Technology is a feature that periodically wakes your computer from Windows® sleep state to refresh email or social networking applications. It saves your waiting time and keeps the content always up-to-date.

3.4.1 System Requirements

- Confirm whether your motherboard supports this feature.
- Operating system: Microsoft Windows 8/7 (32- or 64-bit edition)
- Set the SATA mode to AHCI. If Windows 8/7 is already installed under IDE mode, directly changing the SATA mode to AHCI may cause Windows 8/7 to crash while booting. If your system is not in AHCI mode, please follow the instructions below.



There are certain risks. Please backup any important data before operating to avoid loss.

1. Press **Win + R** simultaneously in Windows 8/7, type "Regedit" into the word box then click **OK**.

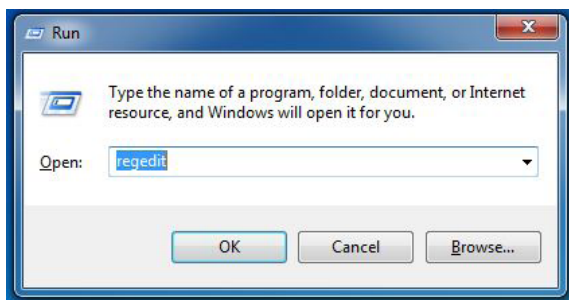

2. Enter into **HKEY_LOCAL_MACHINE\SYSTEM\CurrentControlSet\services\msahci** in Windows Registry Editor. Double click on the value **Start** and change the value from **3** into **0**. Click on **OK**.

3.4.2 Setup Guide

Installing ASRock Smart Connect Utility

Step 1

Install **ASRock Smart Connect Utility**, which is located in the folder at the following path of the Support CD: \ **ASRock Utility** > **Smart Connect**.

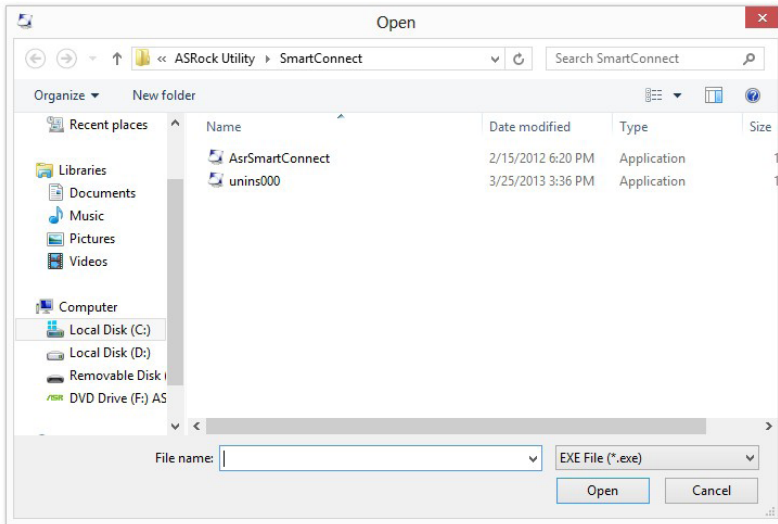

Step 2

Once installed, run ASRock Smart Connect from your desktop or go to Windows **Start -> All Programs -> ASRock Utility**.



Step 3

Click the **Add** button. Take Foxmail as an example, add Foxmail to the Application list.

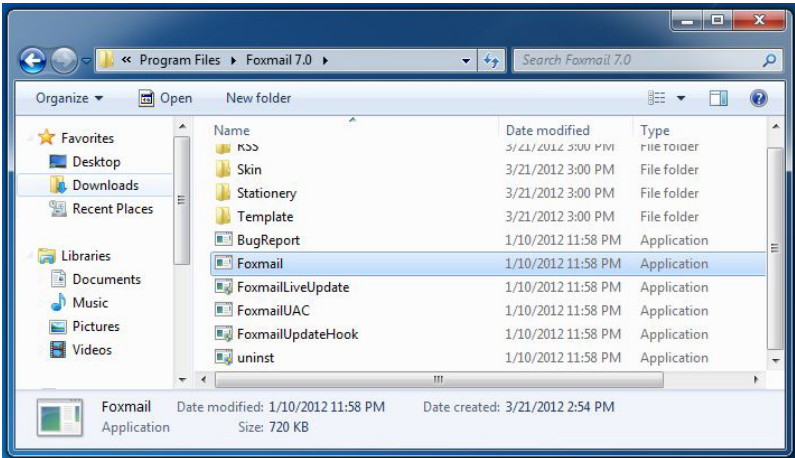

Step 4

Select Foxmail from the **Application List**, then click the arrow pointing right to add this application to the **Smart Connect List**.



Step 5

Click **Apply** to enable Smart Connect.

Step 6

Double-click the Intel® Smart Connect Technology Manager icon  in the Windows system tray.

Step 7

Drag the slider to configure how often the system will connect to the network to download updates. Shorter durations will provide more frequent updates, but may cause more power consumption.

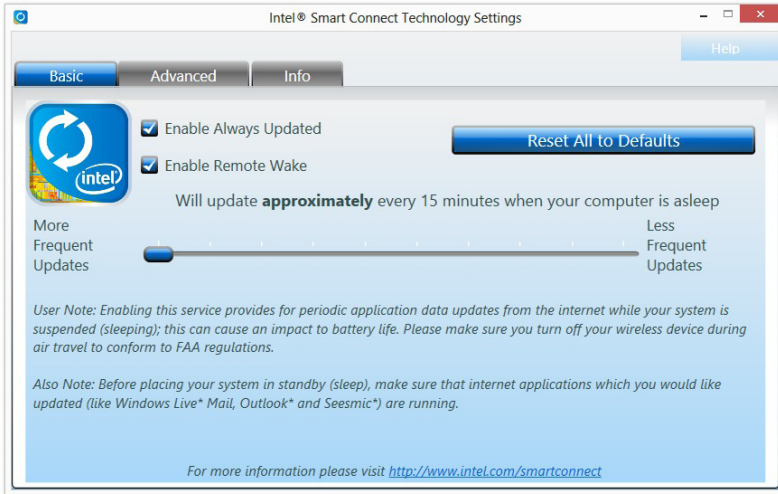
**Using Smart Connect**

1. Keep the applications which you wish to connect to the internet and receive updates while the system is in sleep state running. Foxmail for instance, keep Foxmail running.
2. Click on Windows Start -> the arrow next to Shut down, and click on **Sleep**.

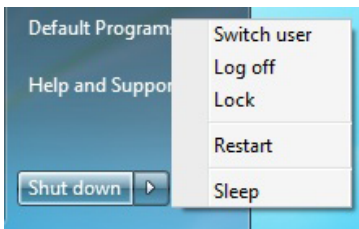

3. Windows system will enter sleep state.

4. The system will wake up from sleep state periodically, and then start to update Foxmail. The screen will not display anything so the computer can maintain minimum power usage. Afterwards, the system will automatically return to sleep state again.
5. Upon waking up the system, you will find the new mail that were sent to you during sleep state are already updated and ready to be read in Foxmail.

3.5 ASRock Cloud

ASRock partners with Kloudian to make your mobile devices connect to your PC seamlessly!



Have you ever been in a situation where you emergently needed certain files in your computer, however the computer was gazillion miles away out of reach? ASRock Cloud includes several technologies and software solutions for remotely controlling your computer, even if the computer is in off mode. For ASRock motherboards with a **Intel®** LAN chip, ASRock Cloud allows users to remotely wake up their computers via the internet by using a secondary device, such as a smartphone or tablet. Users may use **Kloudian® Orbweb.ME Professional** to remotely wake up and control their computers, or they could wake up the computer then use any other preferred remote desktop application. This motherboard supports Remote Wake Technology with the onboard Intel® LAN, so you can connect with your PC from anywhere in the world. You will be able to power your PC on or turn it off, monitor and take control of it remotely with another smartphone, tablet or computer.

3.5.1 Intel® Remote Wake Technology

Intel® Remote Wake Technology allows you to wake up and remote control your home computer from sleep state.

Before configuring this feature, verify the followings on your host computer:

- Make sure that the "PCIe Devices Power On" is enabled in *UEFI SETUP UTILITY > Advanced > ACPI Configuration*.

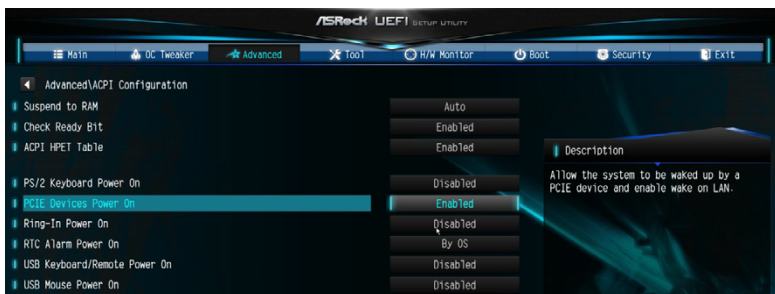

**The UEFI screen is for reference only. The actual screen may differ by model.*

- Make sure that the "Remote Wake" is enabled in "Intel® Smart Connect Technology Manager".

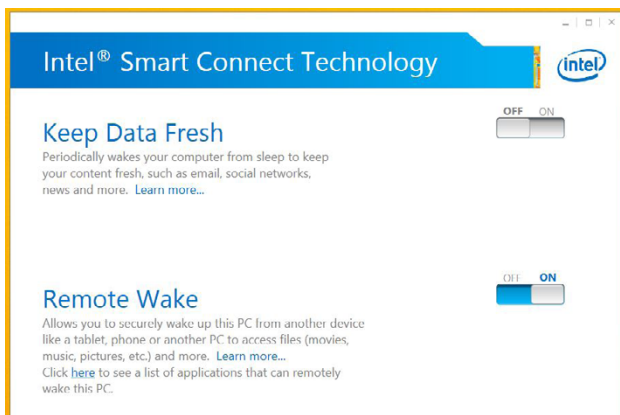

**Intel Remote Wake is supported on Windows 8 or Windows 8 64bit OS.*

3.5.2 Configuring and Using Orbweb.ME Professional

Kloudian® Orbweb.ME Professional is a remote control software allowing you to easily access and control the remote host installed with the Orbweb.ME Professional host software.

Installing Orbweb.ME Professional on the Host Computer

You can find the Orbweb.ME Professional host software in the Support CD or just download it from <http://orbweb.me>.

Step 1

Click on the Orbweb.ME Professional installer package file to start installation.

Step 2

Follow the onscreen instructions to complete the installation.

Step 3

When installation completes, reboot the computer.

Signing Up for Host Computer Registration

Step 1

Double-click the Orbweb.ME Professional icon  on your desktop.

Step 2

On the Orbweb.ME Portal login page, click **Sign Up** to create an Orbweb.ME account and name your host computer.

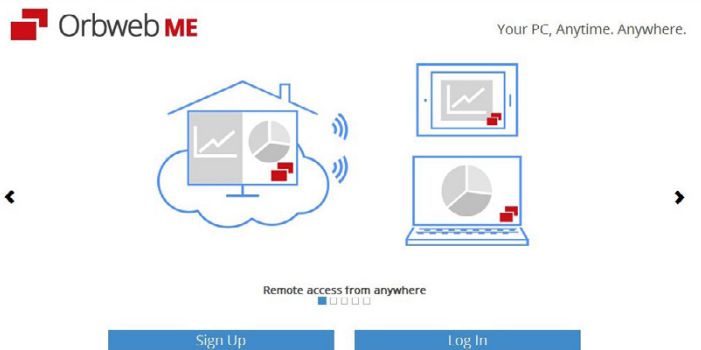

Step 3

You will receive a verification email. Follow the steps in the email to verify your account. After verifying your account, you can access your PC through web browsers at <http://orbweb.me>.

On the Account Verified page, if you click **Go to My Computers**, you will see the Orbweb.ME portal page as a client.

Setting Up Shared Folders on Host Computer

Step 1

Double-click the Orbweb.ME Professional icon  on your desktop.

Or, if you just finished signing up for your host computer, you can click **Configure this computer** in the screen to begin.

Step 2

Click **Folder Settings** tab and the default shared folders display.

To add a folder, click . Select a folder to add it into Orbweb.ME. Then click **Save**.

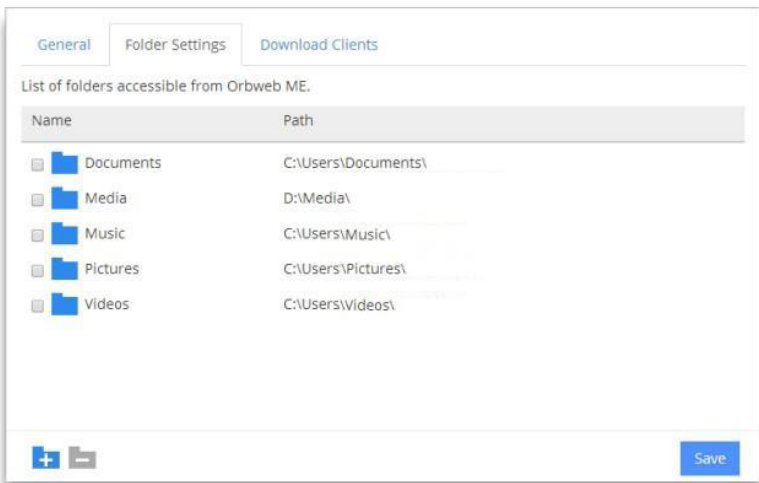

You can access the documents in these shared folders on the host computer remotely through Xplorer from your client device.

REMOTE ACCESS FROM A CLIENT DEVICE



The latest version of Java is required to be installed to use the Remote Desktop and Xplorer functions.



Using Remote Wake-Up

Remote Wake-Up allows you to remotely put your host computer to sleep and wake your host computer up from a client device.



If you use a motherboard with dual LAN ports, please disable one of the LAN ports to use the Remote Wake-Up function. To do so, go to Control Panel > Network and Sharing Center > Manage Network Connections, right-click Local Area Connections and select Disable.

For Windows PC users:

Step 1





Go to Orbweb.ME portal login page: <http://orbweb.me>







Step 2

Log in with your Orbweb.ME account and password.

Step 3









Find the host computer from the list by the computer name you give.

Status	Version	Computer	Connect	Subscription	Properties
	3.0.3 	ASROCK CLOUD	 	Subscribe	
Host Status	Current Version Number	Host Computer Name	Connect	Power Options	Host Properties

 Online / Green	 Ready to Connect / Blue	 Online / Blue
 Offline / Gray	 Unable to Connect / Gray	 Wakable / Red
 Wakeable mode		



Step 4

Click  and power options appear. Click to select **Restart**, **Sleep** or **Shut Down**.

Status	Version	Computer	Connect	Plan	Subscription	Properties
	3.1.1	H97 Performance		Ultimate	Subscribe	
	3.1.1	797 Extreme6	 	Ultimate	Subscribe	
	3.1.1	797 Killer			Subscribe	

Add Computer

Select **Restart** from the options to restart your host computer remotely.

When you select **Sleep**, if the host device is WOW(Wake-On-Wan) compatible, you can put your host computer to sleep (S3/S4). The host status in the Status column shows offline and ready to be awaked  and the power option shows wakable .

To wake up the computer, click .



Please be noted that if the host device is not WOW compatible, the host status icon will turn offline and the power option icon will disappear. You have to physically wake up computer in order to bring power option icon back to online.

If you select **Shut Down**, you can turn off your computer remotely. However, the Intel® Remote Wake Technology does not support remote wake-up from shutdown (S5). Please physically turn on your host computer.

For iOS or Android Mobile Devices users:

Download and install “Orbweb.ME Professional” app from the App Store (iOS) or Play Store (Android).

Step 1

Tap the “Orbweb.ME Professional” app icon  to launch it.

Step 2

Log in with your Orbweb.ME account and password.

Step 3

Tap the **Power Options** icon  and power options appear.

Tap to select **Restart**, **Sleep** or **Shutdown**.



1. Please be noted that if the host device is not WOW compatible, the host status icon will turn offline and the power option icon will disappear. You have to physically wake up computer in order to bring power option icon back to online.
2. The Intel® Remote Wake Technology does not support remote wake-up from shutdown (S5). If you press Shutdown to remotely turn off the host computer, please turn it on physically.

Using Remote Desktop

Remote Desktop allows you to remotely access your host computer from a client device.

For Windows PC users:

Step 1

Go to Orbweb.ME portal login page: <http://orbweb.me>

Step 2

Log in with your Orbweb.ME account and password.

Step 3

Click the **Connect** icon .

Step 4

Click on **Remote Desktop**.

If the **Remote Desktop Connection** dialog appears, click **Connect** to continue.

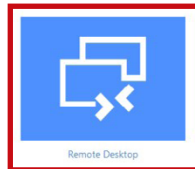

Step 5

Enter the Windows password to log in and you will see the desktop of your host computer.



Please refer to the user manual of the Kloudian® Orbweb.ME Professional for more instructions on how to use Orbweb.ME Professional.

For iOS or Android Mobile Devices users:

Download and install “Orbweb.ME Professional” app from the App Store (iOS) or Play Store (Android).

Step 1

Tap the “Orbweb.ME Professional” app icon  to launch it.

Step 2

Log in with your Orbweb.ME account and password.

Step 3

Tap the host computer name that you want to access under the **Remote Desktop** section.

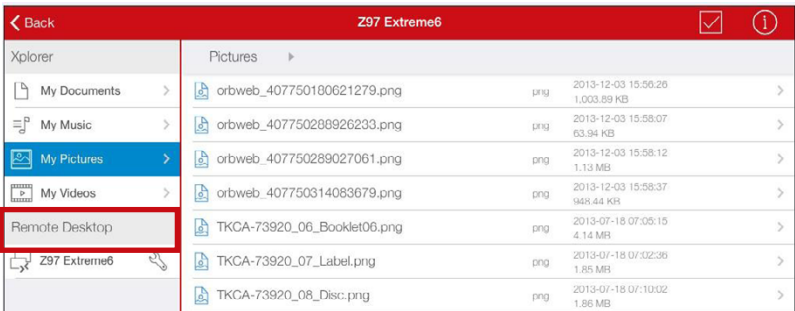

Xplorer		Pictures	
My Documents	>	orbweb_407750180621279.png	png 2013-12-03 15:56:26 1,003.89 KB >
My Music	>	orbweb_407750280926233.png	png 2013-12-03 15:58:07 63.94 KB >
My Pictures	>	orbweb_407750289027061.png	png 2013-12-03 15:58:12 1.13 MB >
My Videos	>	orbweb_407750314083679.png	png 2013-12-03 15:58:37 948.44 KB >
Remote Desktop		TKCA-73920_06_Booklet06.png	png 2013-07-18 07:05:15 4.14 MB >
Z97 Extreme6		TKCA-73920_07_Label.png	png 2013-07-18 07:02:36 1.85 MB >
		TKCA-73920_08_Disc.png	png 2013-07-18 07:10:02 1.86 MB >

Step 4

Enter the Windows password to log in and you will see the desktop of your host computer.

Using Xplorer

Xplorer allows you to remotely access documents on your host computer from a client device.

For Windows PC users:

Step 1

Go to Orbweb.ME portal login page: <http://orbweb.me>

Step 2

Log in with your Orbweb.ME account and password.

Step 3

Click the **Connect** icon .

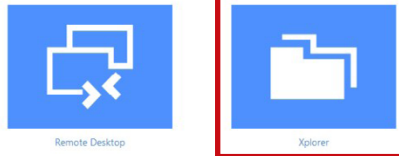

Step 4

Click on **Xplorer**.



Step 5

Root directory displays. Click on a folder name to open the folder.

<input type="checkbox"/> Name ^	Type	Size	Date
<input type="checkbox"/>  Documents	Folder		2014-03-24 21:50:41
<input type="checkbox"/>  Music	Folder		2014-03-24 21:37:03
<input type="checkbox"/>  Pictures	Folder		2014-03-24 21:37:03
<input type="checkbox"/>  Videos	Folder		2014-03-24 21:37:03

Step 6

Click on a file name to preview the file.

You can also delete, rename, move, and copy a selected file. For more instructions on how to use Xplorer, refer to the user manual of the Kloudian® Orbweb.ME Professional.

For iOS or Android Mobile Devices users:

Download and install “Orbweb.ME Professional” app from the App Store (iOS) or Play Store (Android).

Step 1

Tap the “Orbweb.ME Professional” app icon  to launch it.

Step 2

Log in with your Orbweb.ME account and password.

Step 3

Tap the **Connect** icon .

Step 4

Tap a folder name under the **Xplorer** section and you can see the files in this folder.

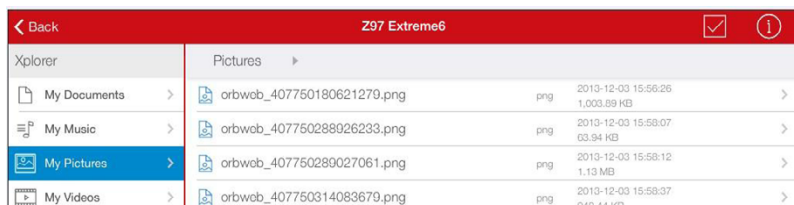

Tap a file name to preview the file.

You can also delete, rename, move, and copy a selected file. For more instructions on how to use Xplorer, refer to the user manual of the Kloudian® Orbweb.ME Professional.



3.6 ASRock APP Shop

The ASRock APP Shop is an online store for purchasing and downloading software applications for your ASRock computer. You can install various apps and support utilities quickly and easily, and optimize your system and keep your motherboard up to date simply with a few clicks.

Double-click  on your desktop to access ASRock APP Shop utility.

**You need to be connected to the Internet to download apps from the ASRock APP Shop.*

3.6.1 UI Overview

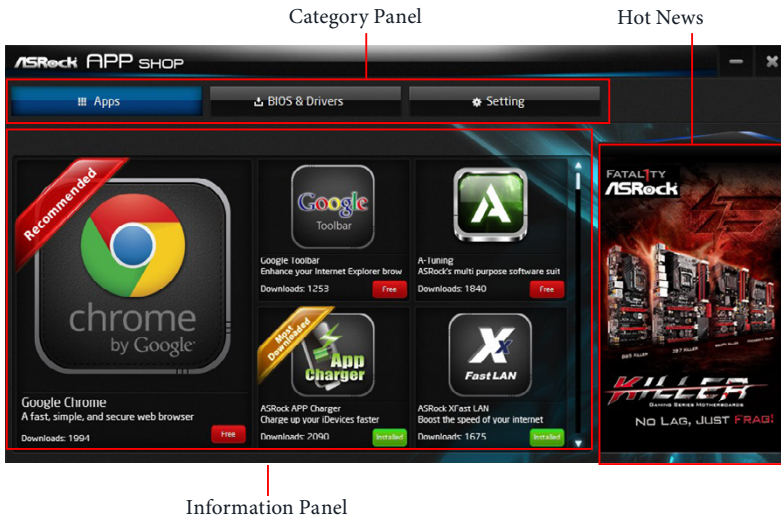

Category Panel: The category panel contains several category tabs or buttons that when selected the information panel below displays the relative information.

Information Panel: The information panel in the center displays data about the currently selected category and allows users to perform job-related tasks.

Hot News: The hot news section displays the various latest news. Click on the image to visit the website of the selected news and know more.

3.6.2 Apps

When the "Apps" tab is selected, you will see all the available apps on screen for you to download.

Installing an App

Step 1

Find the app you want to install.



The most recommended app appears on the left side of the screen. The other various apps are shown on the right. Please scroll up and down to see more apps listed.

You can check the price of the app and whether you have already installed it or not.

Free - The red icon displays the price or "Free" if the app is free of charge.

Installed - The green "Installed" icon means the app is installed on your computer.

Step 2

Click on the app icon to see more details about the selected app.

Step 3

If you want to install the app, click on the red icon  to start downloading.



Step 4

When installation completes, you can find the green "Installed" icon appears on the upper right corner.

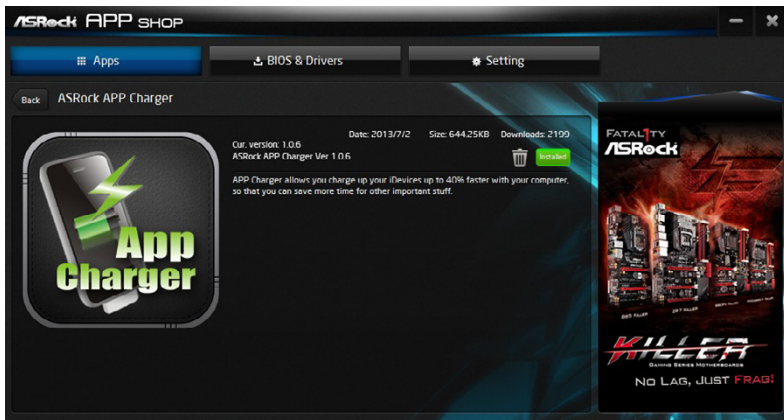

To uninstall it, simply click on the trash can icon .

*The trash icon may not appear for certain apps.

Upgrading an App

You can only upgrade the apps you have already installed. When there is an available new version for your app, you will find the mark of "New Version"  appears below the installed app icon.



Step 1

Click on the app icon to see more details.

Step 2

Click on the yellow icon  to start upgrading.

3.6.3 BIOS & Drivers

Installing BIOS or Drivers

When the "BIOS & Drivers" tab is selected, you will see a list of recommended or critical updates for the BIOS or drivers. Please update them all soon.

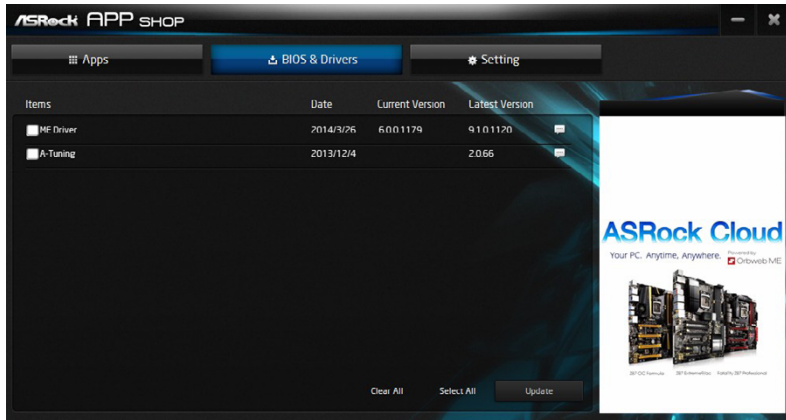

Step 1

Please check the item information before update. Click on ⓘ to see more details.

Step 2

Click to select one or more items you want to update.

Step 3

Click Update to start the update process.

3.6.4 Setting

In the "Setting" page, you can change the language, select the server location, and determine if you want to automatically run the ASRock APP Shop on Windows startup.

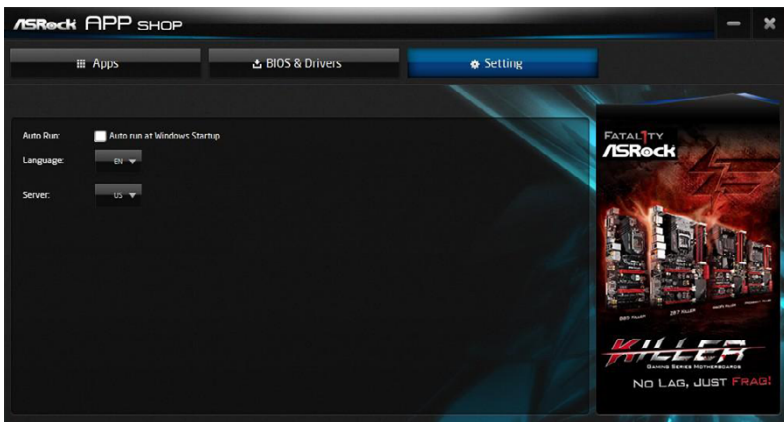

3.7 Start8

For those Windows 8 users who miss the Start Menu, Start8 is an ideal solution that brings back the familiar Start Menu along with added customizations for greater efficiency.

3.7.1 Installing Start8

Install **Start8**, which is located in the folder at the following path of the Support CD:
 \ **ASRock Utility** > **Start8**.

3.7.2 Configuring Start8

Style

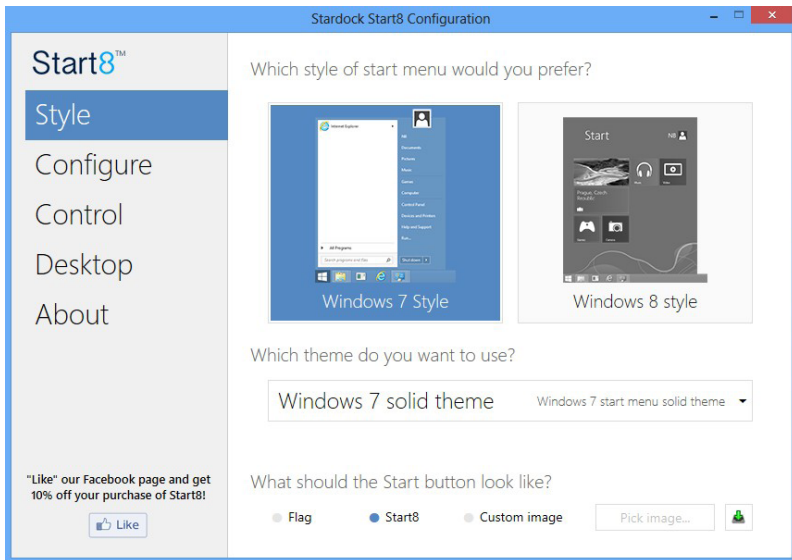

Select between the Windows 7 style and Windows 8 style Start Menu. Then select the theme of the Start Menu and customize the style of the Start icon.

Configure

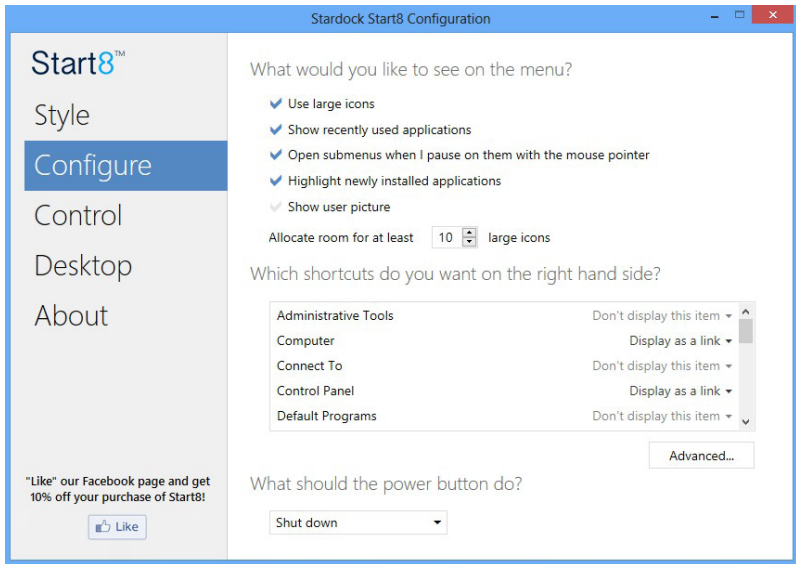

Configure provides configuration options, including icon sizes, which shortcuts you want Start Menu to display, quick access to recently used apps, the functionality of the power button, and more.

Control

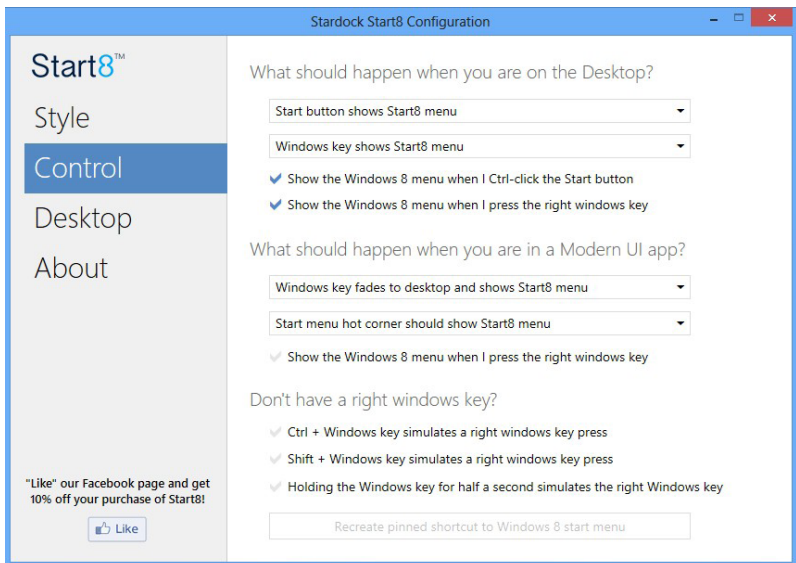

Control lets you configure what a click on the start button or a press on the Windows key does.

Desktop

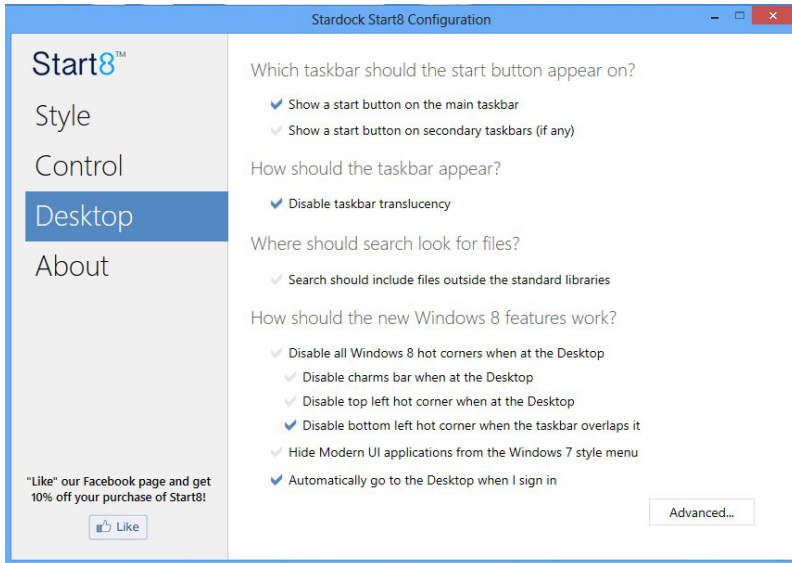

Desktop allows you to disable the hot corners when you are working on the desktop. It also lets you choose whether or not the system boots directly into desktop mode and bypass the Metro user interface.

About

Displays information about Start8.

Chapter 4 UEFI SETUP UTILITY

4.1 Introduction

This section explains how to use the UEFI SETUP UTILITY to configure your system. You may run the UEFI SETUP UTILITY by pressing <F2> or right after you power on the computer, otherwise, the Power-On-Self-Test (POST) will continue with its test routines. If you wish to enter the UEFI SETUP UTILITY after POST, restart the system by pressing <Ctl> + <Alt> + <Delete>, or by pressing the reset button on the system chassis. You may also restart by turning the system off and then back on.



Because the UEFI software is constantly being updated, the following UEFI setup screens and descriptions are for reference purpose only, and they may not exactly match what you see on your screen.

4.1.1 UEFI Menu Bar

The top of the screen has a menu bar with the following selections:

Main	For setting system time/date information
OC Tweaker	For overclocking configurations
Advanced	For advanced system configurations
Tool	Useful tools
H/W Monitor	Displays current hardware status
Boot	For configuring boot settings and boot priority
Security	For security settings
Exit	Exit the current screen or the UEFI Setup Utility

4.1.2 Navigation Keys

Use <←> key or <→> key to choose among the selections on the menu bar, and use <↑> key or <↓> key to move the cursor up or down to select items, then press <Enter> to get into the sub screen. You can also use the mouse to click your required item.

Please check the following table for the descriptions of each navigation key.

Navigation Key(s)	Description
+ / -	To change option for the selected items
<Tab>	Switch to next function
<PGUP>	Go to the previous page
<PGDN>	Go to the next page
<HOME>	Go to the top of the screen
<END>	Go to the bottom of the screen
<F1>	To display the General Help Screen
<F7>	Discard changes and exit the SETUP UTILITY
<F9>	Load optimal default values for all the settings
<F10>	Save changes and exit the SETUP UTILITY
<F12>	Print screen
<ESC>	Jump to the Exit Screen or exit the current screen

4.2 Main Screen

When you enter the UEFI SETUP UTILITY, the Main screen will appear and display the system overview.



Favorite

Display your collection of BIOS items. Press F5 to add/remove your favorite items.

Active Page on Entry

Select the default page when entering the UEFI setup utility.

Full HD UEFI

When [Auto] is selected, the resolution will be set to 1920 x 1080 if the monitor supports Full HD resolution. If the monitor does not support Full HD resolution, then the resolution will be set to 1024 x 768. When [Disable] is selected, the resolution will be set to 1024 x 768 directly.

UEFI Guide

UEFI Guide is a quick tutorial for ASRock's UEFI setup Utility. You may abort the tutorial by pressing "Esc".

4.3 OC Tweaker Screen

In the OC Tweaker screen, you can set up overclocking features.



Because the UEFI software is constantly being updated, the following UEFI setup screens and descriptions are for reference purpose only, and they may not exactly match what you see on your screen.

Advanced Turbo

You can use this option to increase your system performance. This option appears only when your CPU supports this function. This option appears only when you adopt K-Series CPU.

Load Optimized CPU OC Setting

You can use this option to load optimized CPU overclocking setting. Please note that overclocking may cause damage to your CPU and motherboard. It should be done at your own risk and expense. This option appears only when you adopt K-Series CPU.

Load Optimized GPU OC Setting

You can use this option to load optimized GPU overclocking setting. Please note that overclocking may cause damage to your GPU and motherboard. It should be done at your own risk and expense. This option appears only when you adopt K-Series CPU.

CPU Configuration

CPU Ratio

The CPU speed is determined by the CPU Ratio multiplied with the BCLK. Increasing the CPU Ratio will increase the internal CPU clock speed without affecting the clock speed of other components.

CPU Cache Ratio

The CPU Internal Bus Speed Ratio. The maximum should be the same as the CPU Ratio.

BCLK/PCIE Frequency

The CPU speed is determined by the CPU Ratio multiplied with the BCLK. Increasing the BCLK will increase the internal CPU clock speed but also affect the clock speed of other components.

Spread Spectrum

Enable Spread Spectrum to reduce electromagnetic interference for passing EMI tests. Disable to achieve higher clock speeds when overclocking.

CPU OC Fixed Mode

CPU OC fix mode allows you to keep the max CPU ratio as your setting without throttling. Please note that overclocking may cause damage to your CPU and motherboard. It should be done at your own risk and expense.

Intel SpeedStep Technology

Intel SpeedStep technology allows processors to switch between multiple frequencies and voltage points for better power saving and heat dissipation.

Intel Turbo Boost Technology

Intel Turbo Boost Technology enables the processor to run above its base operating frequency when the operating system requests the highest performance state.

Filter PLL Frequency

CPU BCLK Filter Frequency. Choose 1.6 for better overclocking capabilities.

Long Duration Power Limit

Configure Package Power Limit 1 in watts. When the limit is exceeded, the CPU ratio will be lowered after a period of time. A lower limit can protect the CPU and save power, while a higher limit may improve performance.

Long Duration Maintained

Configure the period of time until the CPU ratio is lowered when the Long Duration Power Limit is exceeded.

Short Duration Power Limit

Configure Package Power Limit 2 in watts. When the limit is exceeded, the CPU ratio will be lowered immediately. A lower limit can protect the CPU and save power, while a higher limit may improve performance.

Primary Plane Current Limit

Configure the current limit of the CPU under Turbo Mode in ampere. A lower limit can protect the CPU and save power, while a higher limit may improve performance.

GT Frequency

Configure the frequency of the integrated GPU.

GT Voltage Mode

Auto: For optimized settings.

Adaptive: Add voltage to the integrated GPU when the system is under heavy load.

Override: The voltage is fixed.

GT Adaptive Voltage

Configure the voltage added to the integrated GPU when the system is under heavy load.

GT Voltage Offset

Configure the fixed voltage added to the integrated GPU.

DRAM Timing Configuration

Load XMP Setting

Load XMP settings to overclock the DDR3 memory and perform beyond standard specifications.

DRAM Reference Clock

Select Auto for optimized settings.

DRAM Frequency

If [Auto] is selected, the motherboard will detect the memory module(s) inserted and assign the appropriate frequency automatically.

DRAM Performance Mode

Choose high performance mode to increase memory performance. Use default settings for better system stability.

DRAM Configuration

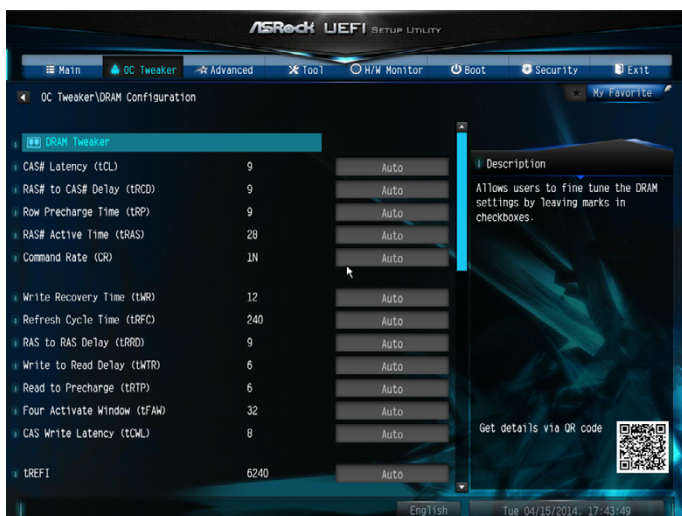

DRAM Tweaker

Fine tune the DRAM settings by leaving marks in checkboxes. Click OK to confirm and apply your new settings.

CAS# Latency (tCL)

The time between sending a column address to the memory and the beginning of the data in response.

RAS# to CAS# Delay (tRCD)

The number of clock cycles required between the opening of a row of memory and accessing columns within it.

Row Precharge Time (tRP)

The number of clock cycles required between the issuing of the precharge command and opening the next row.

RAS# Active Time (tRAS)

The number of clock cycles required between a bank active command and issuing the precharge command.

Command Rate (CR)

The delay between when a memory chip is selected and when the first active command can be issued.

Write Recovery Time (tWR)

The amount of delay that must elapse after the completion of a valid write operation, before an active bank can be precharged.

Refresh Cycle Time (tRFC)

The number of clocks from a Refresh command until the first Activate command to the same rank.

RAS to RAS Delay (tRRD)

The number of clocks between two rows activated in different banks of the same rank.

Write to Read Delay (tWTR)

The number of clocks between the last valid write operation and the next read command to the same internal bank.

Read to Precharge (tRTP)

The number of clocks that are inserted between a read command to a row precharge command to the same rank.

Four Activate Window (tFAW)

The time window in which four activates are allowed the same rank.

CAS Write Latency (tCWL)

Configure CAS Write Latency.

tREFI

Configure refresh cycles at an average periodic interval.

tCKE

Configure the period of time the DDR3 initiates a minimum of one refresh command internally once it enters Self-Refresh mode.

tRDRD

Configure between module read to read delay.

tRDRDDR

Configure between module read to read delay from different ranks.

tRDRDDD

Use this to change DRAM tRWSR Auto/Manual settings. The default is [Auto].

tWRRD

Configure between module write to read delay.

tWRRDDR

Configure between module write to read delay from different ranks.

tWRRDDD

Use this to change DRAM tRRSR Auto/Manual settings. The default is [Auto].

Configure between module write to read delay from different DIMMs.

tWRWR

Configure between module write to write delay.

tWRWRDR

Configure between module write to write delay from different ranks.

tWRWRDD

Configure between module write to write delay from different DIMMs.

tRDWR

Configure between module read to write delay.

tRDWRDR

Configure between module read to write delay from different ranks.

tRDWRDD

Configure between module read to write delay from different DIMMs.

RTL (CHA)

Configure round trip latency for channel A.

RTL (CHB)

Configure round trip latency for channel B.

IO-L (CHA)

Configure IO latency for channel A.

IO-L (CHB)

Configure IO latency for channel B.

ODT WR (CHA)

Configure the memory on die termination resistors' WR for channel A.

ODT WR (CHB)

Configure the memory on die termination resistors' WR for channel B.

ODT NOM (CHA)

Use this to change ODT (CHA) Auto/Manual settings. The default is [Auto].

ODT NOM (CHB)

Use this to change ODT (CHB) Auto/Manual settings. The default is [Auto].

Command Tri State

Enable for DRAM power saving.

MRC Fast Boot

Enable Memory Fast Boot to skip DRAM memory training for booting faster.

DIMM Exit Mode

Select Slow Exit to reduce power consumption, or Fast Exit for better performance.

FIVR Configuration

FIVR Switch Frequency Signature

Select whether to boost or lower the FIVR Switch Frequency.

FIVR Switch Frequency Offset

Configure the percentage of frequency boost or deduction.

Vcore Override Voltage

Add voltage to the Vcore when the system is under heavy load.

Vcore Voltage Additional Offset

Configure the dynamic Vcore voltage added to the Vcore.

CPU Cache Override Voltage

Add voltage to the CPU Cache when the system is under heavy load.

CPU Cache Voltage Offset

Configure the voltage for the CPU Cache. Setting the voltage higher may increase system stability when overclocking.

System Agent Voltage Offset

Configure the voltage for the System Agent. Setting the voltage higher may increase system stability when overclocking.

CPU Analog IO Voltage Offset

CPU I/O Analog Voltage.

CPU Digital IO Voltage Offset

CPU I/O Digital Voltage.

CPU Integrated VR Faults

Disable FIVR Faults to raise the threshold to trigger CPU over current protection and over voltage protection for better overclocking capabilities.

CPU Integrated VR Efficiency Mode

Enable FIVR Efficiency Management for power saving. Disable for better performance and overclocking capabilities.

Voltage Configuration

CPU Input Voltage

Configure the voltage for the CPU.

CPU Load-Line Calibration

CPU Load-Line Calibration helps prevent CPU voltage droop when the system is under heavy load.

DRAM Voltage

Use this to configure DRAM Voltage.

PCH 1.05V Voltage

Chipset 1.05V Voltage. Use default settings for best performance.

PCH 1.5V Voltage

I/O 1.5V Voltage. Use default settings for best performance.

4.4 Advanced Screen

In this section, you may set the configurations for the following items: CPU Configuration, Chipset Configuration, Storage Configuration, Intel® Rapid Start Technology, Intel® Smart Connect Technology, Intel® Thunderbolt™ , Super IO Configuration, ACPI Configuration, USB Configuration and Trusted Computing.

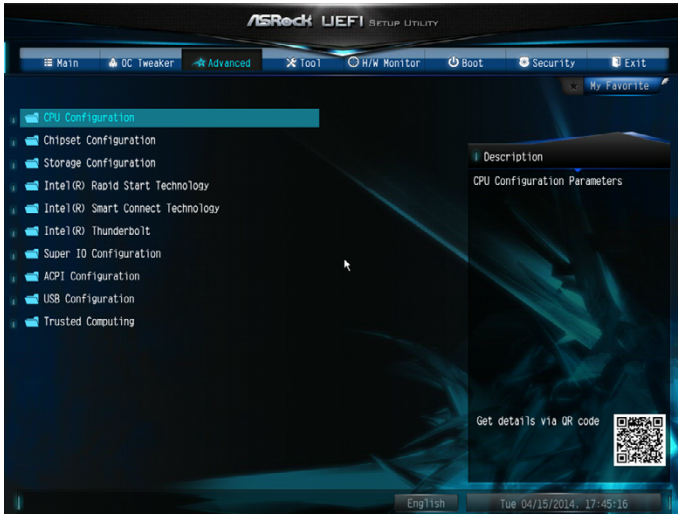

Setting wrong values in this section may cause the system to malfunction.

4.4.1 CPU Configuration

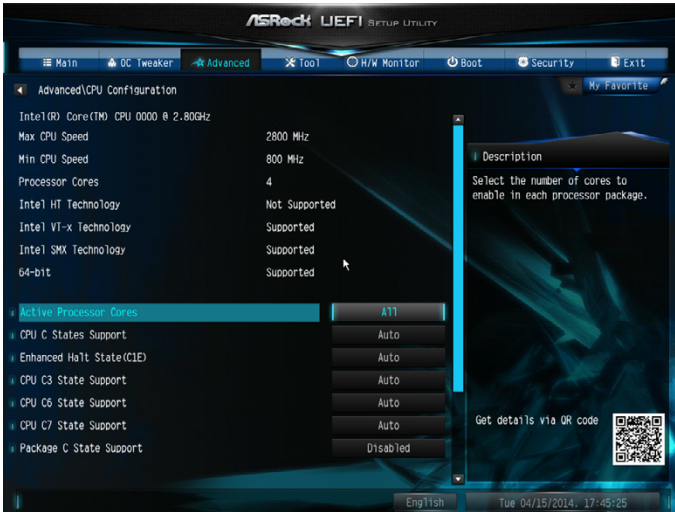

Active Processor Cores

Select the number of cores to enable in each processor package.

CPU C States Support

Enable CPU C States Support for power saving. It is recommended to keep C3, C6 and C7 all enabled for better power saving.

Enhanced Halt State (C1E)

Enable Enhanced Halt State (C1E) for lower power consumption.

CPU C3 State Support

Enable C3 sleep state for lower power consumption.

CPU C6 State Support

Enable C6 deep sleep state for lower power consumption.

CPU C7 State Support

Enable C7 deep sleep state for lower power consumption.

Package C State Support

Enable CPU, PCIe, Memory, Graphics C State Support for power saving.

CPU Thermal Throttling

Enable CPU internal thermal control mechanisms to keep the CPU from overheating.

No-Execute Memory Protection

Processors with No-Execution Memory Protection Technology may prevent certain classes of malicious buffer overflow attacks.

Intel Virtualization Technology

Intel Virtualization Technology allows a platform to run multiple operating systems and applications in independent partitions, so that one computer system can function as multiple virtual systems.

Hardware Prefetcher

Automatically prefetch data and code for the processor. Enable for better performance.

Adjacent Cache Line Prefetch

Automatically prefetch the subsequent cache line while retrieving the currently requested cache line. Enable for better performance.

4.4.2 Chipset Configuration



Primary Graphics Adapter

Select a primary VGA.

VT-d

Intel® Virtualization Technology for Directed I/O helps your virtual machine monitor better utilize hardware by improving application compatibility and reliability, and providing additional levels of manageability, security, isolation, and I/O performance.

PCIE1 Link Speed

Select the link speed for PCIE1.

Share Memory

Configure the size of memory that is allocated to the integrated graphics processor when the system boots up.

IGPU Multi-Monitor

Select disable to disable the integrated graphics when an external graphics card is installed. Select enable to keep the integrated graphics enabled at all times.

Render Standby

Power down the render unit when the GPU is idle for lower power consumption.

Onboard HD Audio

Enable/disable onboard HD audio. Set to Auto to enable onboard HD audio and automatically disable it when a sound card is installed.

Front Panel

Enable/disable front panel HD audio.

On/Off Play

With ASRock On/Off Play users can connect their portable audio devices, such as an MP3 player or a mobile phone to the PC and listen to music through the computer's speakers even when the computer is turned off.

Onboard HDMI HD Audio

Enable audio for the onboard digital outputs.

Onboard LAN

Enable or disable the onboard network interface controller.

Deep Sleep

Configure deep sleep mode for power saving when the computer is shut down.

Restore on AC/Power Loss

Select the power state after a power failure. If [Power Off] is selected, the power will remain off when the power recovers. If [Power On] is selected, the system will start to boot up when the power recovers.

Good Night LED

By enabling Good Night LED, the Power/HDD LEDs will be switched off when the system is on. It will also automatically switch off the Power and Keyboard LEDs when the system enters into Standby/Hibernation mode.

4.4.3 Storage Configuration



SATA Controller(s)

Enable/disable the SATA controllers.

SATA Mode Selection

IDE: For better compatibility.

AHCI: Supports new features that improve performance.

RAID: Combine multiple disk drives into a logical unit.



AHCI (Advanced Host Controller Interface) supports NCQ and other new features that will improve SATA disk performance but IDE mode does not have these advantages.

SATA Aggressive Link Power Management

SATA Aggressive Link Power Management allows SATA devices to enter a low power state during periods of inactivity to save power. It is only supported by AHCI mode.

Dynamic Storage Accelerator

Keep this option enabled for higher HDD and SSD I/O performance, lower latency and increased system responsiveness.

Hard Disk S.M.A.R.T.

S.M.A.R.T stands for Self-Monitoring, Analysis, and Reporting Technology. It is a monitoring system for computer hard disk drives to detect and report on various indicators of reliability.

M2_1/SATA3_4, SATA3_5 Switch

Auto: M2_1/SATA3_4, SATA3_5 auto switch

Force_SATA: Switch to SATA3_4, SATA3_5

Force_M2_1: Switch to M2_1

4.4.4 Intel® Rapid Start Technology

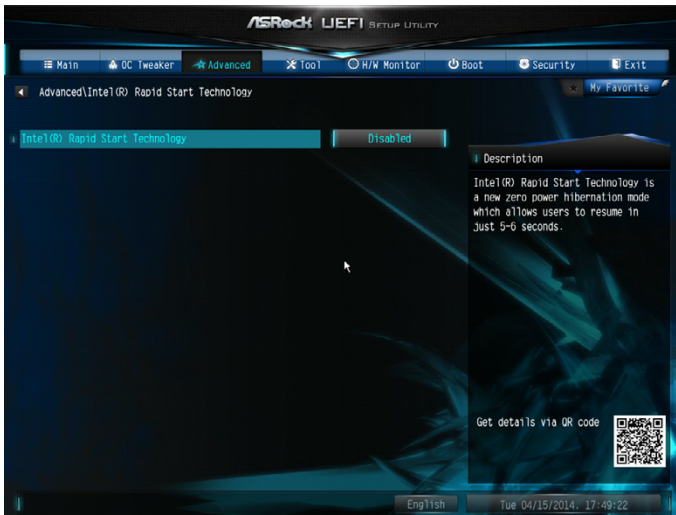

Intel® Rapid Start Technology

Intel® Rapid Start Technology is a new zero power hibernation mode which allows users to resume in just 5-6 seconds.

4.4.5 Intel® Smart Connect Technology

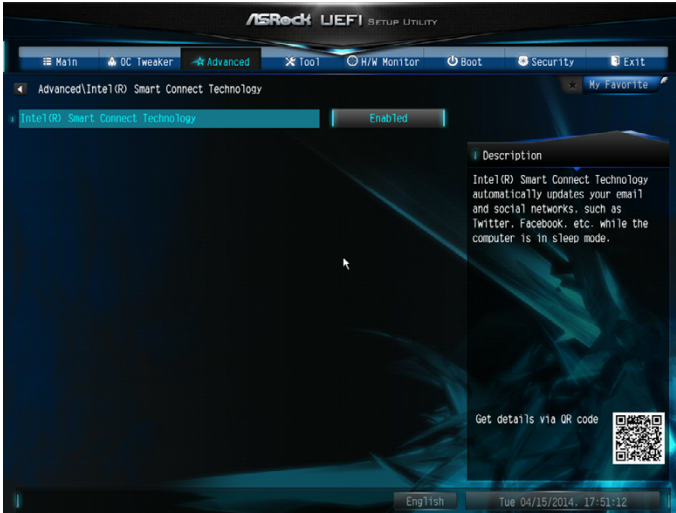

Intel® Smart Connect Technology

Intel® Smart Connect Technology automatically updates your email and social networks, such as Twitter, Facebook, etc. while the computer is in sleep mode.

4.4.6 Intel® Thunderbolt™

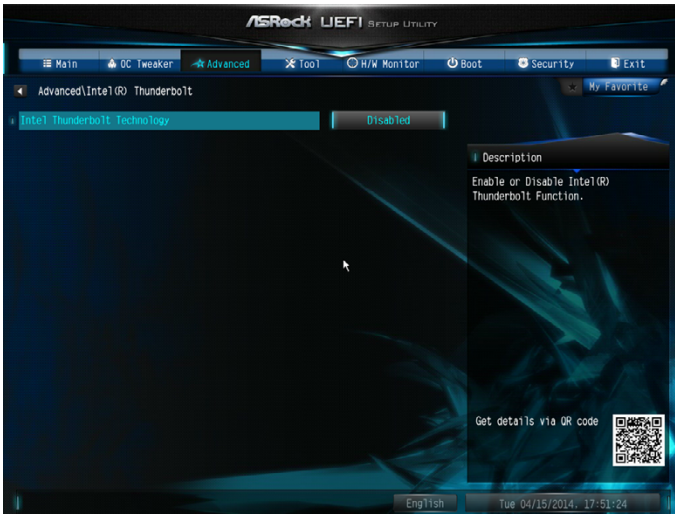

Intel Thunderbolt™ Technology

Enable or disable the Intel® Thunderbolt™ function.

Security Level

Select Legacy to skip the Windows certification checking process for Thunderbolt™ devices. Select Unique ID for checking the Windows certification, and show warning messages if the devices aren't certified. Or select DP++ to support DP 1.2.

Wake From Thunderbolt™ Devices

Allow the system to be waked up by Thunderbolt™ devices.

Ignore Thunderbolt™ Option Rom

Enable to skip Thunderbolt™ Option ROM during POST for faster boot speed.

TBT Device IO resource Support

Enable IO Resource Support if your older Thunderbolt devices have trouble working properly.

Thunderbolt™ PCIe Cache-line Size

Configure the cache-line size of the Thunderbolt PCIe subtree.

4.4.7 Super IO Configuration

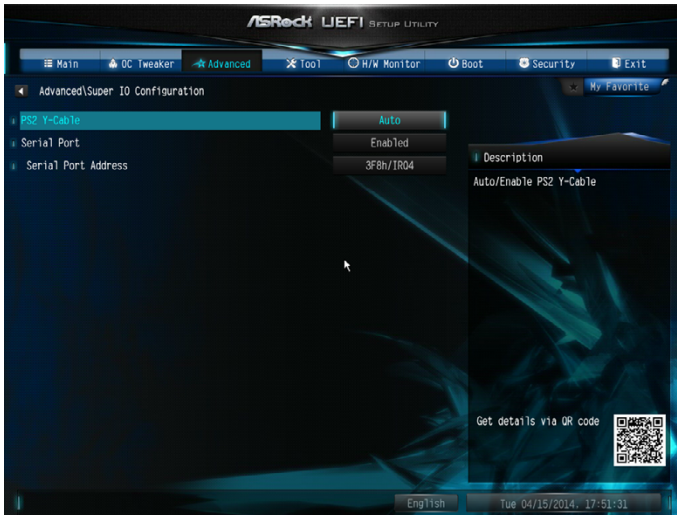

PS2 Y-Cable

Enable the PS2 Y-Cable or set this option to Auto.

Serial Port

Enable or disable the Serial port.

Serial Port Address

Select the address of the Serial port.

4.4.8 ACPI Configuration



Suspend to RAM

Select disable for ACPI suspend type S1. It is recommended to select auto for ACPI S3 power saving.

Check Ready Bit

Enable to enter the operating system after S3 only when the hard disk is ready, this is recommended for better system stability.

ACPI HPET Table

Enable the High Precision Event Timer for better performance and to pass WHQL tests.

PS/2 Keyboard Power On

Allow the system to be waked up by a PS/2 Keyboard.

PCI Devices Power On

Allow the system to be waked up by a PCI device and enable wake on LAN.

Wake From Onboard LAN

Allow the system to be waked up by the onboard LAN.

Ring-In Power On

Allow the system to be waked up by onboard COM port modem Ring-In signals.

RTC Alarm Power On

Allow the system to be waked up by the real time clock alarm. Set it to By OS to let it be handled by your operating system.

USB Keyboard/Remote Power On

Allow the system to be waked up by an USB keyboard or remote controller.

USB Mouse Power On

Allow the system to be waked up by an USB mouse.

4.4.9 USB Configuration



USB Controller

Enable or disable all the USB ports.

Intel USB 3.0 Mode

Select Intel® USB 3.0 controller mode. Set [Smart Auto] to keep the USB 3.0 driver enabled after rebooting (USB 3.0 is enabled in BIOS). Set [Auto] to automatically enable the USB 3.0 driver after entering the OS (USB 3.0 is disabled in BIOS). Set [Enabled] to keep the USB 3.0 driver enabled (Must install driver to use USB devices under Windows® 7). Set [Disabled] to disable the USB 3.0 ports.

Legacy USB Support

Enable or disable Legacy OS Support for USB 2.0 devices. If you encounter USB compatibility issues it is recommended to disable legacy USB support. Select UEFI Setup Only to support USB devices under the UEFI setup and Windows/Linux operating systems only.

Legacy USB 3.0 Support

Enable or disable Legacy OS Support for USB 3.0 devices. If you encounter USB compatibility issues it is recommended to disable legacy USB support. Select UEFI Setup Only to support USB devices under the UEFI setup and Windows/Linux operating systems only.

USB Compatibility Patch

If your USB devices (i.e. USB mouse or storage) encounter compatibility problems, please enable this option to fix it. Please note that after enabling this option, it is normal that the system will postpone booting up after pressing the power button.

4.4.10 Trusted Computing

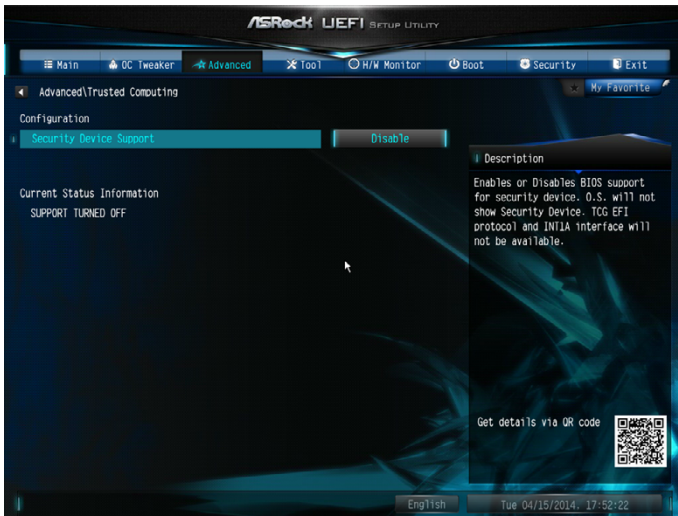

Security Device Support

Enable or disable BIOS support for security device.

4.5 Tools

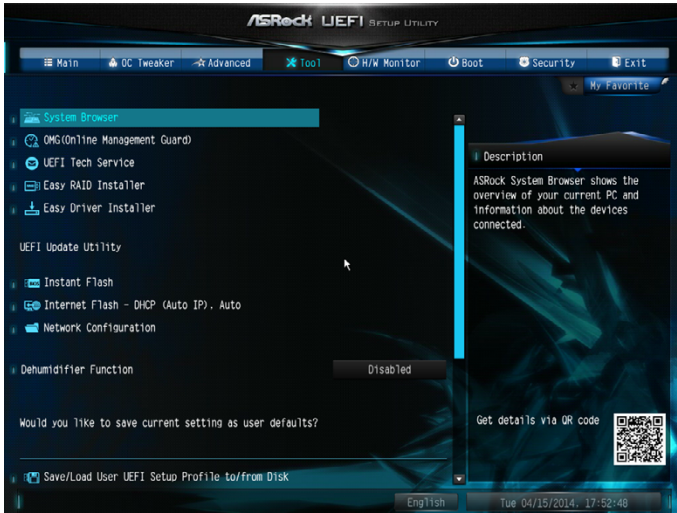

System Browser

ASRock System Browser shows the overview of your current PC and the devices connected.

OMG (Online Management Guard)

Administrators are able to establish an internet curfew or restrict internet access at specified times via OMG. You may schedule the starting and ending hours of internet access granted to other users. In order to prevent users from bypassing OMG, guest accounts without permission to modify the system time are required.

UEFI Tech Service

Contact ASRock Tech Service if you are having trouble with your PC. Please setup network configuration before using UEFI Tech Service.

Easy RAID Installer

Easy RAID Installer helps you to copy the RAID driver from the support CD to your USB storage device. After copying the drivers please change the SATA mode to RAID, then you can start installing the operating system in RAID mode.

Easy Driver Installer

For users that don't have an optical disk drive to install the drivers from our support CD, Easy Driver Installer is a handy tool in the UEFI that installs the LAN driver to your system via an USB storage device, then downloads and installs the other required drivers automatically.

Instant Flash

Save UEFI files in your USB storage device and run Instant Flash to update your UEFI.

Internet Flash

ASRock Internet Flash downloads and updates the latest UEFI firmware version from our servers for you. Please setup network configuration before using Internet Flash.

*For BIOS backup and recovery purpose, it is recommended to plug in your USB pen drive before using this function.

Network Configuration

Use this to configure internet connection settings for Internet Flash.

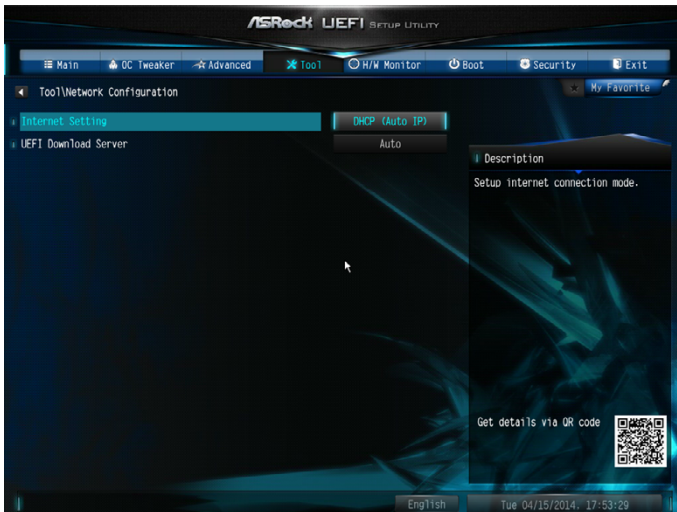

Internet Setting

Enable or disable sound effects in the setup utility.

UEFI Download Server

Select a server to download the UEFI firmware.

Dehumidifier Function

If Dehumidifier Function is enabled, the computer will power on automatically to dehumidify the system after entering S4/S5 state.

Dehumidifier Period

Configure the period of time until the computer powers on and enables Dehumidifier after entering S4/S5 state.

Dehumidifier Duration

Configure the duration of the dehumidifying process before it returns to S4/S5 state.

Dehumidifier CPU Fan Setting

Configure the speed of the CPU fan while Dehumidifier is enabled. The higher the value, the faster the fan speed.

Max: 255

Min: 1

Save User Default

Type a profile name and press enter to save your settings as user default.

Load User Default

Load previously saved user defaults.

4.6 Hardware Health Event Monitoring Screen

This section allows you to monitor the status of the hardware on your system, including the parameters of the CPU temperature, motherboard temperature, fan speed and voltage.

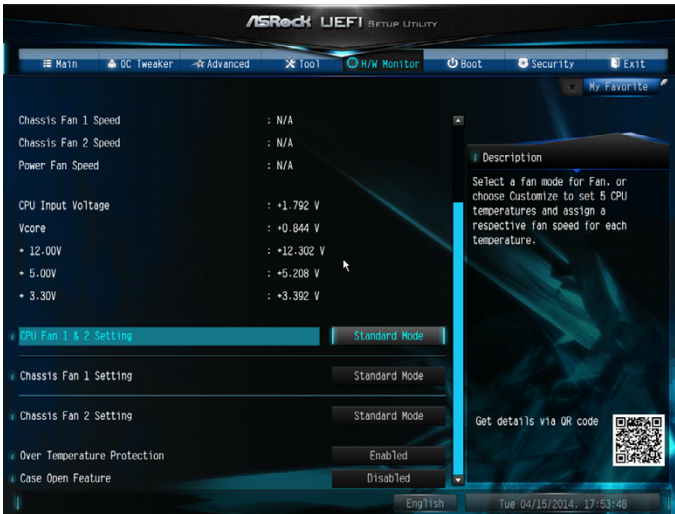

CPU Fan 1 & 2 Setting

Select a fan mode for CPU Fans 1&2, or choose Customize to set 5 CPU temperatures and assign a respective fan speed for each temperature.

Chassis Fan 1 Setting

Select a fan mode for Chassis Fan 1, or choose Customize to set 5 CPU temperatures and assign a respective fan speed for each temperature.

Chassis Fan 2 Setting

Select a fan mode for Chassis Fan 2, or choose Customize to set 5 CPU temperatures and assign a respective fan speed for each temperature.

Over Temperature Protection

When Over Temperature Protection is enabled, the system automatically shuts down when the motherboard is overheated.

Case Open Feature

Enable or disable Case Open Feature to detect whether the chassis cover has been removed.

4.7 Boot Screen

This section displays the available devices on your system for you to configure the boot settings and the boot priority.



Fast Boot

Fast Boot minimizes your computer's boot time. In fast mode you may not boot from an USB storage device. Ultra Fast mode is only supported by Windows 8.1/8 and the VBIOS must support UEFI GOP if you are using an external graphics card. Please notice that Ultra Fast mode will boot so fast that the only way to enter this UEFI Setup Utility is to Clear CMOS or run the Restart to UEFI utility in Windows.

Boot From Onboard LAN

Allow the system to be waked up by the onboard LAN.

Setup Prompt Timeout

Configure the number of seconds to wait for the setup hot key.

Bootup Num-Lock

Select whether Num Lock should be turned on or off when the system boots up.

Boot Beep

Select whether the Boot Beep should be turned on or off when the system boots up. Please note that a buzzer is needed.

Full Screen Logo

Enable to display the boot logo or disable to show normal POST messages.

AddOn ROM Display

Enable AddOn ROM Display to see the AddOn ROM messages or configure the AddOn ROM if you've enabled Full Screen Logo. Disable for faster boot speed.

Boot Failure Guard

If the computer fails to boot for a number of times the system automatically restores the default settings.

Boot Failure Guard Count

Configure the number of attempts to boot until the system automatically restores the default settings.

CSM (Compatibility Support Module)

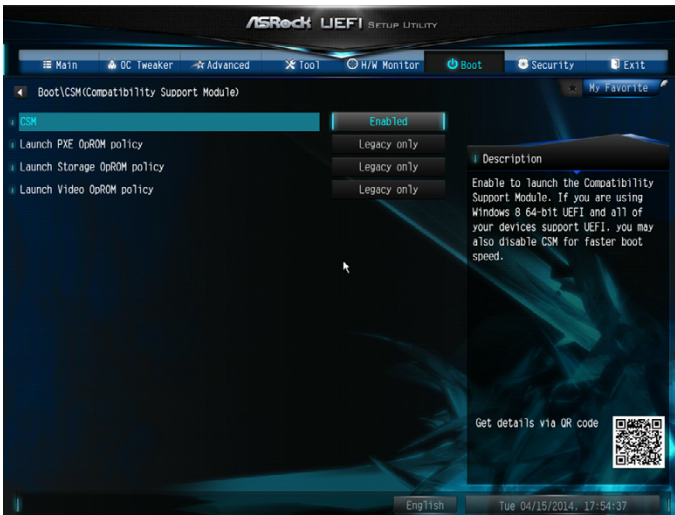

CSM

Enable to launch the Compatibility Support Module. Please do not disable unless you're running a WHCK test. If you are using Windows 8.1/8 64-bit and all of your devices support UEFI, you may also disable CSM for faster boot speed.

Launch PXE OpROM Policy

Select UEFI only to run those that support UEFI option ROM only. Select Legacy only to run those that support legacy option ROM only. Do not launch?

Launch Storage OpROM Policy

Select UEFI only to run those that support UEFI option ROM only. Select Legacy only to run those that support legacy option ROM only. Do not launch?

Launch Video OpROM Policy

Select UEFI only to run those that support UEFI option ROM only. Select Legacy only to run those that support legacy option ROM only. Do not launch?

4.8 Security Screen

In this section you may set or change the supervisor/user password for the system. You may also clear the user password.

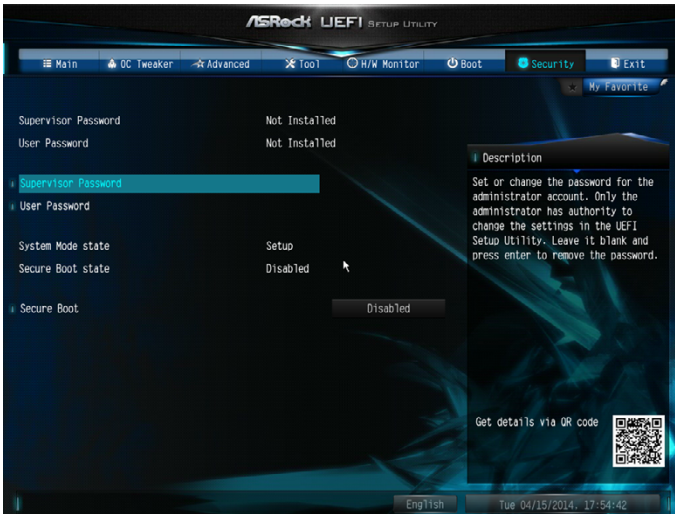

Supervisor Password

Set or change the password for the administrator account. Only the administrator has authority to change the settings in the UEFI Setup Utility. Leave it blank and press enter to remove the password.

User Password

Set or change the password for the user account. Users are unable to change the settings in the UEFI Setup Utility. Leave it blank and press enter to remove the password.

Secure Boot

Enable to support Windows 8.1 / 8 Secure Boot.

4.9 Exit Screen

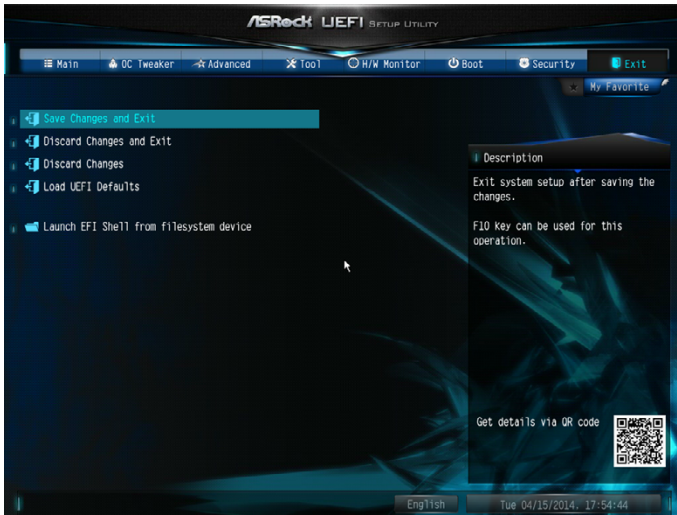

Save Changes and Exit

When you select this option the following message, “Save configuration changes and exit setup?” will pop out. Select [OK] to save changes and exit the UEFI SETUP UTILITY.

Discard Changes and Exit

When you select this option the following message, “Discard changes and exit setup?” will pop out. Select [OK] to exit the UEFI SETUP UTILITY without saving any changes.

Discard Changes

When you select this option the following message, “Discard changes?” will pop out. Select [OK] to discard all changes.

Load UEFI Defaults

Load UEFI default values for all options. The F9 key can be used for this operation.

Launch EFI Shell from filesystem device

Copy shellx64.efi to the root directory to launch EFI Shell.

Contact Information

If you need to contact ASRock or want to know more about ASRock, you're welcome to visit ASRock's website at <http://www.asrock.com>; or you may contact your dealer for further information. For technical questions, please submit a support request form at <http://www.asrock.com/support/tsd.asp>

ASRock Incorporation

2F., No.37, Sec. 2, Jhongyang S. Rd., Beitou District,

Taipei City 112, Taiwan (R.O.C.)

ASRock EUROPE B.V.

Bijsterhuizen 3151

6604 LV Wijchen

The Netherlands

Phone: +31-24-345-44-33

Fax: +31-24-345-44-38

ASRock America, Inc.

13848 Magnolia Ave, Chino, CA91710

U.S.A.

Phone: +1-909-590-8308

Fax: +1-909-590-1026