



H61M-DP3/ASM

User Manual

Version 1.0

Published July 2013

Copyright©2013 ASRock INC. All rights reserved.

Copyright Notice:

No part of this manual may be reproduced, transcribed, transmitted, or translated in any language, in any form or by any means, except duplication of documentation by the purchaser for backup purpose, without written consent of ASRock Inc.

Products and corporate names appearing in this manual may or may not be registered trademarks or copyrights of their respective companies, and are used only for identification or explanation and to the owners' benefit, without intent to infringe.

Disclaimer:

Specifications and information contained in this manual are furnished for informational use only and subject to change without notice, and should not be constructed as a commitment by ASRock. ASRock assumes no responsibility for any errors or omissions that may appear in this manual.

With respect to the contents of this manual, ASRock does not provide warranty of any kind, either expressed or implied, including but not limited to the implied warranties or conditions of merchantability or fitness for a particular purpose.

In no event shall ASRock, its directors, officers, employees, or agents be liable for any indirect, special, incidental, or consequential damages (including damages for loss of profits, loss of business, loss of data, interruption of business and the like), even if ASRock has been advised of the possibility of such damages arising from any defect or error in the manual or product.



This device complies with Part 15 of the FCC Rules. Operation is subject to the following two conditions:

- (1) this device may not cause harmful interference, and
- (2) this device must accept any interference received, including interference that may cause undesired operation.

CALIFORNIA, USA ONLY

The Lithium battery adopted on this motherboard contains Perchlorate, a toxic substance controlled in Perchlorate Best Management Practices (BMP) regulations passed by the California Legislature. When you discard the Lithium battery in California, USA, please follow the related regulations in advance.

“Perchlorate Material-special handling may apply, see

www.dtsc.ca.gov/hazardouswaste/perchlorate”

ASRock Website: <http://www.asrock.com>

Supplies Guaranteed for One Year:

ASRock guarantees immediate brand new replacement from distributors, shipped prior to the return of the defective items with absolutely no questions asked during the first 30 days. Immediate new or buffer replacement from distributors depending on their inventory's availability for the next 11 months. And then regular RMA for the following 2 years.

Contents

1 Introduction	6
1.1 Package Contents	6
1.2 Specifications.....	7
1.3 Unique Features	10
1.4 Motherboard Layout.....	14
1.5 I/O Panel	15
2 Installation	16
2.1 Screw Holes.....	16
2.2 Pre-installation Precautions	16
2.3 CPU Installation	17
2.4 Installation of Heatsink and CPU fan	19
2.5 Installation of Memory Modules (DIMM).....	20
2.6 Expansion Slot (PCI and PCI Express Slots).....	21
2.7 Dual Monitor and Surround Display Features.....	22
2.8 ASRock Smart Remote Installation Guide	25
2.9 Jumpers Setup	27
2.10 Onboard Headers and Connectors	28
2.11 Serial ATA2 (SATA2) Hard Disks Installation	32
2.12 Hot Plug Function for Serial ATA2 (SATA2) HDDs	32
2.13 Serial ATA2 (SATA2) HDD Hot Plug Feature and Operation Guide	33
2.14 Driver Installation Guide	35
2.15 Installing Windows® 8 / 8 64-bit / 7 / 7 64-bit / Vista™ / Vista™ 64-bit / XP / XP 64-bit Without RAID Functions .	35
2.15.1 Installing Windows® XP / XP 64-bit Without RAID Functions.....	35
2.15.2 Installing Windows® 8 / 8 64-bit / 7 / 7 64-bit / Vista™ / Vista™ 64-bit Without RAID Functions.	36
2.16 ASRock XFast 555	37
2.16.1 ASRock XFast RAM.....	38
2.16.2 ASRock XFast LAN.....	41
2.16.3 ASRock XFast USB.....	45

3	UEFI SETUP UTILITY	47
3.1	Introduction	47
3.1.1	UEFI Menu Bar	47
3.1.2	Navigation Keys	48
3.2	Main Screen	48
3.3	OC Tweaker Screen	49
3.4	Advanced Screen	53
3.4.1	CPU Configuration	54
3.4.2	North Bridge Configuration	56
3.4.3	South Bridge Configuration	57
3.4.4	Storage Configuration	58
3.4.5	Intel(R) Rapid Start Technology	59
3.4.6	Intel(R) Smart Connect Technology	60
3.4.7	Super IO Configuration	61
3.4.8	ACPI Configuration	62
3.4.9	USB Configuration	63
3.5	Tool	64
3.6	Hardware Health Event Monitoring Screen	66
3.7	Boot Screen	67
3.8	Security Screen	69
3.9	Exit Screen	70
4	Software Support	71
4.1	Install Operating System	71
4.2	Support CD Information	71
4.2.1	Running Support CD	71
4.2.2	Drivers Menu	71
4.2.3	Utilities Menu	71
4.2.4	Contact Information	71

Chapter 1: Introduction

Thank you for purchasing ASRock **H61M-DP3/ASM** motherboard, a reliable motherboard produced under ASRock's consistently stringent quality control. It delivers excellent performance with robust design conforming to ASRock's commitment to quality and endurance.

In this manual, chapter 1 and 2 contain introduction of the motherboard and step-by-step guide to the hardware installation. Chapter 3 and 4 contain the configuration guide to BIOS setup and information of the Support CD.



Because the motherboard specifications and the BIOS software might be updated, the content of this manual will be subject to change without notice. In case any modifications of this manual occur, the updated version will be available on ASRock website without further notice. You may find the latest VGA cards and CPU support lists on ASRock website as well.

ASRock website <http://www.asrock.com>

If you require technical support related to this motherboard, please visit our website for specific information about the model you are using.

www.asrock.com/support/index.asp

1.1 Package Contents

ASRock **H61M-DP3/ASM** Motherboard (Micro ATX Form Factor)

ASRock **H61M-DP3/ASM** Quick Installation Guide

ASRock **H61M-DP3/ASM** Support CD

2 x Serial ATA (SATA) Data Cables (Optional)

1 x I/O Panel Shield



ASRock Reminds You...

To get better performance in Windows® 8 / 8 64-bit / 7 / 7 64-bit / Vista™ / Vista™ 64-bit, it is recommended to set the BIOS option in Storage Configuration to AHCI mode.

1.2 Specifications

Platform	<ul style="list-style-type: none"> - Micro ATX Form Factor - All Solid Capacitor design
CPU	<ul style="list-style-type: none"> - Supports 3rd and 2nd Generation Intel® Core™ i7 / i5 / i3 in LGA1155 Package - Supports Intel® Turbo Boost 2.0 Technology - Supports K-Series CPU
Chipset	<ul style="list-style-type: none"> - Intel® H61 - Supports Intel® Rapid Start Technology and Smart Connect Technology
Memory	<ul style="list-style-type: none"> - Dual Channel DDR3 Memory Technology - 2 x DDR3 DIMM slots - Supports DDR3 1600/1333/1066 non-ECC, un-buffered memory (DDR3 1600 with Intel® Ivy Bridge CPU, DDR3 1333 with Intel® Sandy Bridge CPU) - Max. capacity of system memory: 16GB (see CAUTION 1) - Supports Intel® Extreme Memory Profile (XMP) 1.3 / 1.2 with Intel® Ivy Bridge CPU
Expansion Slot	<ul style="list-style-type: none"> - 1 x PCI Express 3.0 x16 slot (PCIe1 @ x16 mode) * PCIe 3.0 is only supported with Intel® Ivy Bridge CPU. With Intel® Sandy Bridge CPU, it only supports PCIe 2.0. - 1 x PCI Express 2.0 x1 slot - 1 x PCI slot
Graphics	<ul style="list-style-type: none"> * Intel® HD Graphics Built-in Visuals and the VGA outputs can be supported only with processors which are GPU integrated. - Supports Intel® HD Graphics Built-in Visuals: Intel® Quick Sync Video 2.0, Intel® InTru™ 3D, Intel® Clear Video HD Technology, Intel® Insider™, Intel® HD Graphics 2500/4000 with Intel® Ivy Bridge CPU - Supports Intel® HD Graphics Built-in Visuals: Intel® Quick Sync Video, Intel® InTru™ 3D, Intel® Clear Video HD Technology, Intel® HD Graphics 2000/3000, Intel® Advanced Vector Extensions (AVX) with Intel® Sandy Bridge CPU - Pixel Shader 5.0, DirectX 11 with Intel® Ivy Bridge CPU. Pixel Shader 4.1, DirectX 10.1 with Intel® Sandy Bridge CPU. - Max. shared memory 1760MB with Intel® Ivy Bridge CPU. Max. shared memory 1759MB with Intel® Sandy Bridge CPU.

	<ul style="list-style-type: none"> - Dual VGA Output: support DVI and D-Sub ports by independent display controllers - Supports DVI with max. resolution up to 1920x1200 @ 60Hz - Supports D-Sub with max. resolution up to 2048x1536 @ 75Hz - Supports HDCP function with DVI port - Supports Full HD 1080p Blu-ray (BD) / HD-DVD playback with DVI port
Audio	<ul style="list-style-type: none"> - 5.1 CH HD Audio (Realtek ALC662 Audio Codec)
LAN	<ul style="list-style-type: none"> - PCIE x1 Gigabit LAN 10/100/1000 Mb/s - Realtek RTL8111E - Supports LAN Cable Detection - Supports Energy Efficient Ethernet 802.3az - Supports PXE
Rear Panel I/O	<p>I/O Panel</p> <ul style="list-style-type: none"> - 1 x PS/2 Mouse Port - 1 x PS/2 Keyboard Port - 1 x D-Sub Port - 1 x DVI-D Port - 4 x Ready-to-Use USB 2.0 Ports - 1 x RJ-45 LAN Port with LED (ACT/LINK LED and SPEED LED) - HD Audio Jack: Line in / Front Speaker / Microphone
Connector	<ul style="list-style-type: none"> - 4 x SATA2 3.0 Gb/s connectors, support NCQ, AHCI and Hot Plug functions - 1 x CIR header - 1 x Print Port header - 1 x COM port header - 1 x Chassis Intrusion header - 1 x CPU Fan connectors (4-pin) - 1 x Chassis Fan connector (4-pin) - 1 x Power Fan connector (3-pin) - 24 pin ATX power connector - 4 pin 12V power connector - Front panel audio connector - 2 x USB 2.0 headers (support 4 USB 2.0 ports)
BIOS Feature	<ul style="list-style-type: none"> - 32Mb AMI UEFI Legal BIOS with GUI support - Supports "Plug and Play" - ACPI 1.1 Compliance Wake Up Events - Supports jumperfree

	- SMBIOS 2.3.1 Support
Support CD	- Drivers, Utilities, AntiVirus Software (Trial Version), CyberLink MediaEspresso 6.5 Trial, Google Chrome Browser and Toolbar
Hardware Monitor	- CPU Temperature Sensing - Chassis Temperature Sensing - CPU Fan Tachometer - Chassis Fan Tachometer - CPU Quiet Fan (Allow Chassis Fan Speed Auto-Adjust by CPU Temperature) - CPU/Chassis Fan Multi-Speed Control - CASE OPEN detection - Voltage Monitoring: +12V, +5V, +3.3V, CPU Vcore
OS	- Microsoft® Windows® 8 / 8 64-bit / 7 / 7 64-bit / Vista™ / Vista™ 64-bit / XP / XP 64-bit compliant
Certifications	- FCC, CE, WHQL - ErP/EuP Ready (ErP/EuP ready power supply is required)

* For detailed product information, please visit our website: <http://www.asrock.com>

WARNING

Please realize that there is a certain risk involved with overclocking, including adjusting the setting in the BIOS, applying Untied Overclocking Technology, or using third-party overclocking tools. Overclocking may affect your system's stability, or even cause damage to the components and devices of your system. It should be done at your own risk and expense. We are not responsible for possible damage caused by overclocking.

CAUTION!

1. Due to the operating system limitation, the actual memory size may be less than 4GB for the reservation for system usage under Windows® 8 / 7 / Vista™ / XP. For Windows® OS with 64-bit CPU, there is no such limitation. You can use ASRock XFast RAM to utilize the memory that Windows® cannot use.

1.3 Unique Features

ASRock Extreme Tuning Utility (AXTU)

ASRock Extreme Tuning Utility (AXTU) is an all-in-one tool to ne-tune different system functions in a user-friendly interface, which includes Hardware Monitor, Fan Control and XFast RAM. In Hardware Monitor, it shows the major readings of your system. In Fan Control, it shows the fan speed and temperature for you to adjust. In XFast RAM, it fully utilizes the memory space that cannot be used under Windows® OS 32-bit CPU.

ASRock Instant Boot

ASRock Instant Boot allows you to turn on your PC in just a few seconds, provides a much more efficient way to save energy, time, money, and improves system running speed for your system. It leverages the S3 and S4 ACPI features which normally enable the Sleep/Standby and Hibernation modes in Windows® to shorten boot up time. By calling S3 and S4 at specific timing during the shutdown and startup process, Instant Boot allows you to enter your Windows® desktop in a few seconds.

ASRock Instant Flash

ASRock Instant Flash is a BIOS flash utility embedded in Flash ROM. This convenient BIOS update tool allows you to update system BIOS without entering operating systems first like MS-DOS or Windows®. With this utility, you can press the <F6> key during the POST or the <F2> key to enter into the BIOS setup menu to access ASRock Instant Flash. Just launch this tool and save the new BIOS file to your USB flash drive, floppy disk or hard drive, then you can update your BIOS only in a few clicks without preparing an additional floppy diskette or other complicated flash utility. Please be noted that the USB flash drive or hard drive must use FAT32/16/12 file system.

ASRock APP Charger

If you desire a faster, less restricted way of charging your Apple devices, such as iPhone/iPad/iPod Touch, ASRock has prepared a wonderful solution for you - ASRock APP Charger. Simply install the APP Charger driver, it makes your iPhone charge much quickly from your computer and up to 40% faster than before. ASRock APP Charger allows you to quickly charge many Apple devices simultaneously and even supports continuous charging when your PC enters into Standby mode (S1), Suspend to RAM (S3), hibernation mode (S4) or power off (S5). With APP Charger driver installed, you can easily enjoy the marvelous charging experience.

ASRock XFast USB

ASRock XFast USB can boost USB storage device performance. The performance may depend on the properties of the device.

ASRock XFast LAN

ASRock XFast LAN provides a faster internet access, which includes the benefits listed below. LAN Application Prioritization: You can configure your application's priority ideally and/or add new programs. Lower Latency in Game: After setting online game's priority higher, it can lower the latency in games. Traffic Shaping: You can watch Youtube HD videos and download simultaneously. Real-Time Analysis of Your Data: With the status window, you can easily recognize which data streams you are transferring currently.

ASRock XFast RAM

ASRock XFast RAM is a new function that is included into ASRock Extreme Tuning Utility (AXTU). It fully utilizes the memory space that cannot be used under Windows® OS 32-bit CPU. ASRock XFast RAM shortens the loading time of previously visited websites, making web surfing faster than ever. And it also boosts the speed of Adobe Photoshop 5 times faster. Another advantage of ASRock XFast RAM is that it reduces the frequency of accessing your SSDs or HDDs in order to extend their lifespan.

ASRock Crashless BIOS

ASRock Crashless BIOS allows users to update their BIOS without fear of failing. If power loss occurs during the BIOS update process, ASRock Crashless BIOS will automatically finish the BIOS update procedure after regaining power. Please note that BIOS files need to be placed in the root directory of your USB disk. Only USB2.0 ports support this feature.

ASRock OMG (Online Management Guard)

Administrators are able to establish an internet curfew or restrict internet access at specified times via OMG. You may schedule the starting and ending hours of internet access granted to other users. In order to prevent users from bypassing OMG, guest accounts without permission to modify the system time are required.

ASRock Internet Flash

ASRock Internet Flash searches for available UEFI firmware updates from our servers. In other words, the system can auto-detect the latest UEFI from our servers and flash them without entering Windows® OS. Please note that you must be running on a DHCP configured computer in order to enable this function.

ASRock Dehumidifier Function

Users may prevent motherboard damages due to dampness by enabling "Dehumidifier Function". When enabling Dehumidifier Function, the computer will power on automatically to dehumidify the system after entering S4/S5 state.

ASRock Fast Boot

With ASRock's exclusive Fast Boot technology, it takes less than 1.5 seconds to logon to Windows® 8 from a cold boot. No more waiting! The speedy boot will completely change your user experience and behavior.

ASRock Restart to UEFI

Windows® 8 brings the ultimate boot up experience. The lightning boot up speed makes it hard to access the UEFI setup. ASRock Restart to UEFI technology is designed for those requiring frequent UEFI access. It allows users to easily enter the UEFI automatically when turning on the PC next time. Just simply enable this function; the PC will be assured to access the UEFI directly in the very beginning.

ASRock Combo Cooler Option (C.C.O.)

Combo Cooler Option (C.C.O.) provides the flexible option to adopt three different CPU cooler types, Socket LGA 775, LGA 1155 and LGA 1156. Please be noticed that not all the 775 and 1156 CPU Fan can be used.

ASRock Good Night LED

ASRock Good Night LED technology can offer you a better environment by extinguishing the unessential LED. By enabling Good Night LED in BIOS, the Power / HDD / LAN LED will be switched off when system is on. Not only this, Good night LED will automatically switch off Power and Keyboard LED when the system enters into Standby / Hibernation mode as well.

1.4 Motherboard Layout

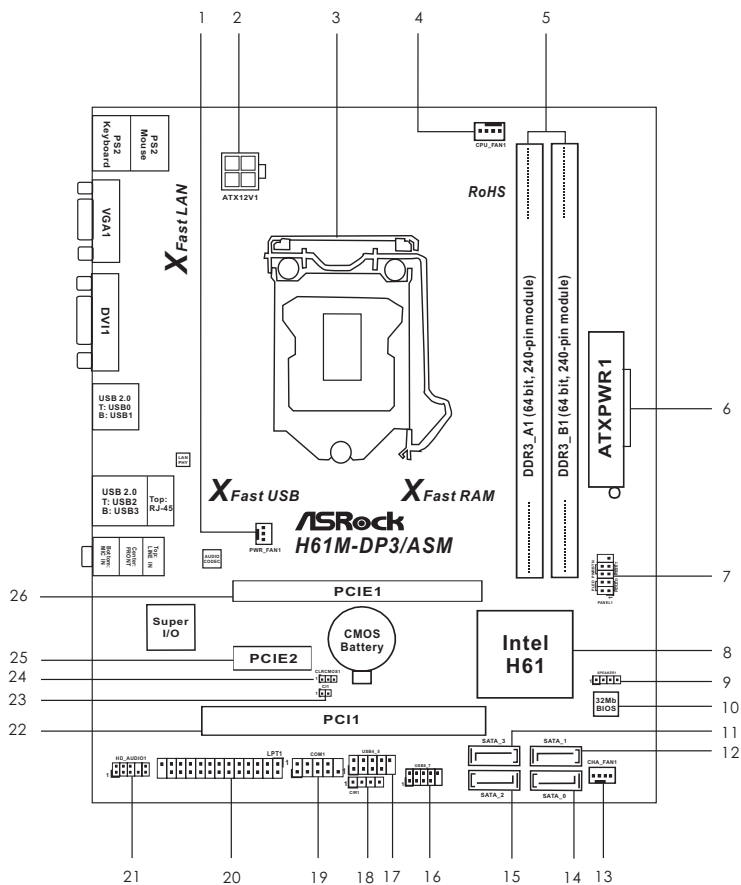

- | | | | |
|----|---|----|--|
| 1 | Power Fan Connector (PWR_FAN1) | 14 | SATA2 Connector (SATA_0) |
| 2 | ATX 12V Power Connector (ATX12V1) | 15 | SATA2 Connector (SATA_2) |
| 3 | 1155-Pin CPU Socket | 16 | USB 2.0 Header (USB6_7) |
| 4 | CPU Fan Connector (CPU_FAN1) | 17 | USB 2.0 Header (USB4_5) |
| 5 | 2 x 240-pin DDR3 DIMM Slots
(Dual Channel: DDR3_A1, DDR3_B1) | 18 | Consumer Infrared Module Header (CIR1) |
| 6 | ATX Power Connector (ATXPWR1) | 19 | COM Port Header (COM1) |
| 7 | System Panel Header (PANEL1) | 20 | Print Port Header (LPT1) |
| 8 | Intel H61 Chipset | 21 | Front Panel Audio Header (HD_AUDIO1) |
| 9 | Chassis Speaker Header (SPEAKER1) | 22 | PCI Slot (PCI1) |
| 10 | 32Mb SPI Flash | 23 | Chassis Intrusion Header (CI1) |
| 11 | SATA2 Connector (SATA_3) | 24 | Clear CMOS Jumper (CLRCMOS1) |
| 12 | SATA2 Connector (SATA_1) | 25 | PCI Express 2.0 x1 Slot (PCIE2) |
| 13 | Chassis Fan Connector (CHA_FAN1) | 26 | PCI Express 3.0 x16 Slot (PCIE1) |

1.5 I/O Panel

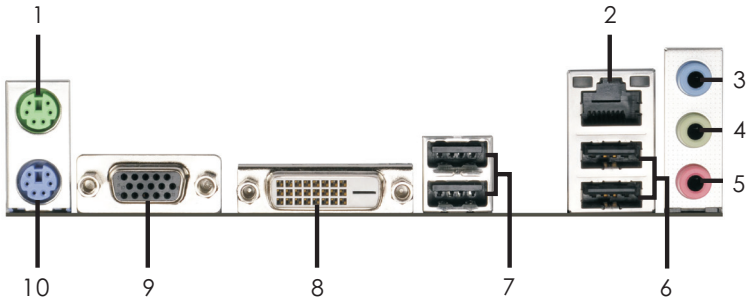

- | | | | |
|-----|-------------------------|----|-----------------------------|
| 1 | PS/2 Mouse Port (Green) | 6 | USB 2.0 Ports (USB23) |
| *2 | LAN RJ-45 Port | 7 | USB 2.0 Ports (USB01) |
| 3 | Line In (Light Blue) | 8 | DVI-D Port |
| **4 | Front Speaker (Lime) | 9 | D-Sub Port |
| 5 | Microphone (Pink) | 10 | PS/2 Keyboard Port (Purple) |

* There are two LED next to the LAN port. Please refer to the table below for the LAN port LED indications.

LAN Port LED Indications

Activity/Link LED		SPEED LED	
Status	Description	Status	Description
Off	No Link	Off	10Mbps connection
Blinking	Data Activity	Orange	100Mbps connection
On	Link	Green	1Gbps connection

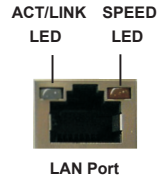

** To enable Multi-Streaming function, you need to connect a front panel audio cable to the front panel audio header. Please refer to below steps for the software setting of Multi-Streaming.
For Windows® XP:

After restarting your computer, you will find "Mixer" tool on your system. Please select "Mixer ToolBox" , click "Enable playback multi-streaming", and click "ok". Choose "2CH" or

"4CH" and then you are allowed to select "Realtek HDA Primary output" to use Rear Speaker and Front Speaker, or select "Realtek HDA Audio 2nd output" to use front panel audio. Then reboot your system.

For Windows® 8 / 7 / Vista™:

After restarting your computer, please double-click "Realtek HD Audio Manager" on the system tray. Set "Speaker Configuration" to "Quadraphonic" or "Stereo". Click "Device advanced settings", choose "Make front and rear output devices playbacks two different audio streams simultaneously", and click "ok". Then reboot your system.

Chapter 2: Installation

This is a Micro ATX form factor motherboard. Before you install the motherboard, study the configuration of your chassis to ensure that the motherboard fits into it.



Make sure to unplug the power cord before installing or removing the motherboard. Failure to do so may cause physical injuries to you and damages to motherboard components.

2.1 Screw Holes

Place screws into the holes indicated by circles to secure the motherboard to the chassis.



Do not over-tighten the screws! Doing so may damage the motherboard.

2.2 Pre-installation Precautions

Take note of the following precautions before you install motherboard components or change any motherboard settings.

1. Unplug the power cord from the wall socket before touching any component.
2. To avoid damaging the motherboard components due to static electricity, NEVER place your motherboard directly on the carpet or the like. Also remember to use a grounded wrist strap or touch a safety grounded object before you handle components.
3. Hold components by the edges and do not touch the ICs.
4. Whenever you uninstall any component, place it on a grounded antistatic pad or in the bag that comes with the component.



Before you install or remove any component, ensure that the power is switched off or the power cord is detached from the power supply. Failure to do so may cause severe damage to the motherboard, peripherals, and/or components.

2.3 CPU Installation

For the installation of Intel 1155-Pin CPU, please follow the steps below.

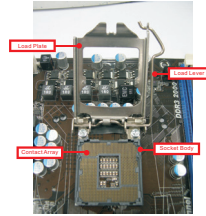

1155-Pin Socket Overview



Before you insert the 1155-Pin CPU into the socket, please check if the CPU surface is unclean or if there is any bent pin on the socket. Do not force to insert the CPU into the socket if above situation is found. Otherwise, the CPU will be seriously damaged.

Step 1. Open the socket:

Step 1-1. Disengaging the lever by depressing down and out on the hook to clear retention tab.

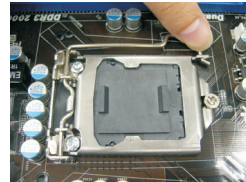

Step 1-2. Rotate the load lever to fully open position at approximately 135 degrees.

Step 1-3. Rotate the load plate to fully open position at approximately 100 degrees.

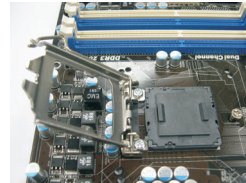

Step 2. Remove PnP Cap (Pick and Place Cap).

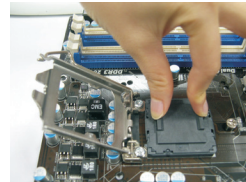

1. It is recommended to use the cap tab to handle and avoid kicking off the PnP cap.
2. This cap must be placed if returning the motherboard for after service.

Step 3. Insert the 1155-Pin CPU:

Step 3-1. Hold the CPU by the edge where is marked with black line.



Step 3-2. Orient the CPU with IHS (Integrated Heat Sink) up. Locate Pin1 and the two orientation key notches.

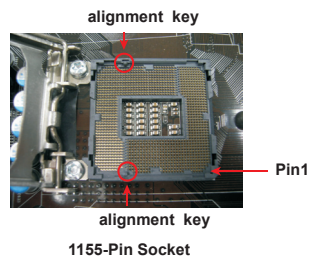
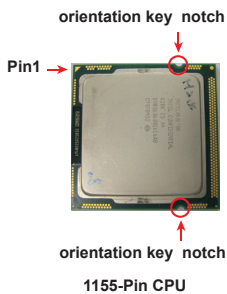

For proper inserting, please ensure to match the two orientation key notches of the CPU with the two alignment keys of the socket.

Step 3-3. Carefully place the CPU into the socket by using a purely vertical motion.



Step 3-4. Verify that the CPU is within the socket and properly mated to the orient keys.

Step 4. Close the socket:

Step 4-1. Rotate the load plate onto the IHS.

Step 4-2. While pressing down lightly on load plate, engage the load lever.



2.4 Installation of CPU Fan and Heatsink

This motherboard is equipped with 1155-Pin socket that supports Intel 1155-Pin CPU. Please adopt the type of heatsink and cooling fan compliant with Intel 1155-Pin CPU to dissipate heat. Before you installed the heatsink, you need to spray thermal interface material between the CPU and the heatsink to improve heat dissipation. Ensure that the CPU and the heatsink are securely fastened and in good contact with each other. Then connect the CPU fan to the CPU_FAN connector (CPU_FAN1, see page 14, No. 4).

For proper installation, please kindly refer to the instruction manuals of your CPU fan and heatsink.

Below is an example to illustrate the installation of the heatsink for 1155-Pin CPU.

Step 1. Apply thermal interface material onto center of IHS on the socket surface.



Step 2. Place the heatsink onto the socket. Ensure fan cables are oriented on side closest to the CPU fan connector on the motherboard (CPU_FAN1, see page 14, No. 4).

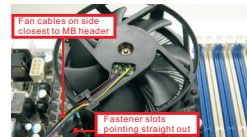

Step 3. Align fasteners with the motherboard through-holes.

Step 4. Rotate the fastener clockwise, then press down on fastener caps with thumb to install and lock. Repeat with remaining fasteners.

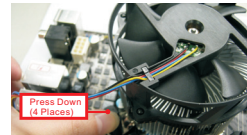

If you press down the fasteners without rotating them clockwise, the heatsink cannot be secured on the motherboard.

Step 5. Connect fan header with the CPU fan connector on the motherboard.

Step 6. Secure excess cable with tie-wrap to ensure cable does not interfere with fan operation or contact other components.



Please be noticed that this motherboard supports Combo Cooler Option (C.C.O.), which provides the flexible option to adopt three different CPU cooler types, Socket LGA 775, LGA 1155 and LGA 1156. The white throughholes are for Socket LGA 1155/1156 CPU fan.



2.5 Installation of Memory Modules (DIMM)

This motherboard provides two 240-pin DDR3 (Double Data Rate 3) DIMM slots, and supports Dual Channel Memory Technology. For dual channel configuration, you always need to install two identical (the same brand, speed, size and chip-type) memory modules in the DDR3 DIMM slots to activate Dual Channel Memory Technology. Otherwise, it will operate at single channel mode.



1. It is not allowed to install a DDR or DDR2 memory module into DDR3 slot; otherwise, this motherboard and DIMM may be damaged.
2. If you install only one memory module or two non-identical memory modules, it is unable to activate the Dual Channel Memory Technology.
3. Some DDR3 1GB double-sided DIMMs with 16 chips may not work on this motherboard. It is not recommended to install them on this motherboard.

Installing a DIMM



Please make sure to disconnect power supply before adding or removing DIMMs or the system components.

- Step 1. Unlock a DIMM slot by pressing the retaining clips outward.
- Step 2. Align a DIMM on the slot such that the notch on the DIMM matches the break on the slot.

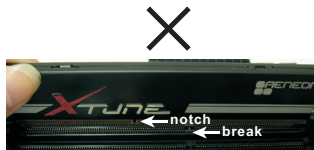
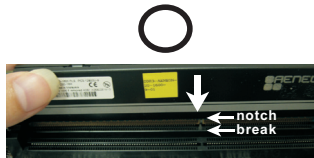

The DIMM only fits in one correct orientation. It will cause permanent damage to the motherboard and the DIMM if you force the DIMM into the slot at incorrect orientation.

- Step 3. Firmly insert the DIMM into the slot until the retaining clips at both ends fully snap back in place and the DIMM is properly seated.

2.6 Expansion Slots (PCI and PCI Express Slots)

There is 1 PCI slot and 2 PCI Express slots on this motherboard.

PCI slots: PCI slots are used to install expansion cards that have the 32-bit PCI interface.

PCIe slots:

PCIe1 (PCIe 3.0 x16 slot) is used for PCI Express x16 lane width graphics cards.

PCIe2 (PCIe 2.0 x1 slot) is used for PCI Express cards with x1 lane width cards, such as Gigabit LAN card, SATA2 card, etc.



Only PCIe1 slot supports Gen 3 speed. To run the PCI Express in Gen 3 speed, please install an Ivy Bridge CPU. If you install a Sandy Bridge CPU, the PCI Express will run only at PCI Express Gen 2 speed.

Installing an expansion card

- Step 1. Before installing the expansion card, please make sure that the power supply is switched off or the power cord is unplugged. Please read the documentation of the expansion card and make necessary hardware settings for the card before you start the installation.
- Step 2. Remove the system unit cover (if your motherboard is already installed in a chassis).
- Step 3. Remove the bracket facing the slot that you intend to use. Keep the screws for later use.
- Step 4. Align the card connector with the slot and press firmly until the card is completely seated on the slot.
- Step 5. Fasten the card to the chassis with screws.
- Step 6. Replace the system cover.

2.7 Dual Monitor and Surround Display Features

Dual Monitor Feature

This motherboard supports dual monitor feature. With the internal VGA output support (D-Sub and DVI-D), you can easily enjoy the benefits of dual monitor feature without installing any add-on VGA card to this motherboard. This motherboard also provides independent display controllers for D-Sub and DVI-D to support dual VGA output so that D-sub and DVI-D can drive same or different display contents.

To enable dual monitor feature, please follow the below steps:

1. Connect D-Sub monitor cable to D-Sub port on the I/O panel, or connect DVI-D monitor cable to DVI-D port on the I/O panel.

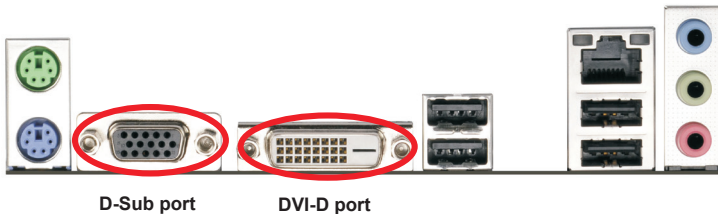

2. If you have installed onboard VGA driver from our support CD to your system already, you can freely enjoy the benefits of dual monitor function after your system boots. If you haven't installed onboard VGA driver yet, please install onboard VGA driver from our support CD to your system and restart your computer.

Surround Display Feature

This motherboard supports surround display upgrade. With the internal VGA output support (D-Sub and DVI-D) and external add-on PCI Express VGA cards, you can easily enjoy the benefits of surround display feature.

Please refer to the following steps to set up a surround display environment:

1. Install the PCI Express VGA card on PCIE1 slot. Please refer to page 21 for proper expansion card installation procedures for details.
2. Connect D-Sub monitor cable to D-Sub port on the I/O panel, or connect DVI-D monitor cable to DVI-D port on the I/O panel. Then connect other monitor cables to the corresponding connectors of the add-on PCI Express VGA card on PCIE1 slot.
3. Boot your system. Press <F2> or to enter UEFI setup. Enter "Share Memory" option to adjust the memory capability to [32MB], [64MB], [128MB], [256MB] or [512MB] to enable the function of D-sub. Please make sure that the value you select is less than the total capability of the system memory. If you do not adjust the UEFI setup, the default value of "Share Memory", [Auto], will disable D-Sub function when the add-on VGA card is inserted to this motherboard.
4. Install the onboard VGA driver and the add-on PCI Express VGA card driver to your system. If you have installed the drivers already, there is no need to install them again.
5. Set up a multi-monitor display.

For Windows® XP / XP 64-bit OS:

Right click the desktop, choose "Properties", and select the "Settings" tab so that you can adjust the parameters of the multi-monitor according to the steps below.

- A. Click the "Identify" button to display a large number on each monitor.
- B. Right-click the display icon in the Display Properties dialog that you wish to be your primary monitor, and then select "Primary". When you use multiple monitors with your card, one monitor will always be Primary, and all additional monitors will be designated as Secondary.
- C. Select the display icon identified by the number 2.
- D. Click "Extend my Windows desktop onto this monitor".
- E. Right-click the display icon and select "Attached", if necessary.
- F. Set the "Screen Resolution" and "Color Quality" as appropriate for the second monitor. Click "Apply" or "OK" to apply these new values.
- G. Repeat steps C through E for the diaplay icon identified by the number one, two, three and four.

For Windows® 8 / 8 64-bit / 7 / 7 64-bit / Vista™ / Vista™ 64-bit OS:

Right click the desktop, choose “Personalize”, and select the “Display Settings” tab so that you can adjust the parameters of the multi-monitor according to the steps below.

- A. Click the number “2” icon.
 - B. Click the items “This is my main monitor” and “Extend the desktop onto this monitor”.
 - C. Click “OK” to save your change.
 - D. Repeat steps A through C for the display icon identified by the number three and four.
6. Use Surround Display. Click and drag the display icons to positions representing the physical setup of your monitors that you would like to use. The placement of display icons determines how you move items from one monitor to another.



HDCP Function

HDCP function is supported on this motherboard. To use HDCP function with this motherboard, you need to adopt the monitor that supports HDCP function as well. Therefore, you can enjoy the superior display quality with high-definition HDCP encryption contents. Please refer to below instruction for more details about HDCP function.

What is HDCP?

HDCP stands for High-Bandwidth Digital Content Protection, a specification developed by Intel® for protecting digital entertainment content that uses the DVI interface. HDCP is a copy protection scheme to eliminate the possibility of intercepting digital data midstream between the video source, or transmitter - such as a computer, DVD player or set-top box - and the digital display, or receiver - such as a monitor, television or projector. In other words, HDCP specification is designed to protect the integrity of content as it is being transmitted.

Products compatible with the HDCP scheme such as DVD players, satellite and cable HDTV set-top-boxes, as well as few entertainment PCs requires a secure connection to a compliant display. Due to the increase in manufacturers employing HDCP in their equipment, it is highly recommended that the HDTV or LCD monitor you purchase is compatible.

2.8 ASRock Smart Remote Installation Guide

ASRock Smart Remote is only used for ASRock motherboard with CIR header. Please refer to below procedures for the quick installation and usage of ASRock Smart Remote.

Step1. Find the CIR header located next to the USB 2.0 header on ASRock motherboard.



Step2. Connect the front USB cable to the USB 2.0 header (as below, pin 1-5) and the CIR header. Please make sure the wire assignments and the pin assignments are matched correctly.

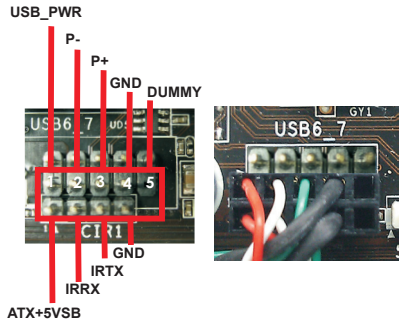

Step3. Install Multi-Angle CIR Receiver to the front USB port.

Step4. Boot up your system. Press <F2> or to enter BIOS Setup Utility. Make sure the option "CIR Controller" is setting at [Enabled]. (Advanced -> Super IO Configuration -> CIR Controller -> [Enabled])



If you cannot find this option, please shut down your system and install Multi-Angle CIR Receiver to the other front USB port then try again.

Step5. Enter Windows. Execute ASRock support CD and install CIR Driver. (It is listed at the bottom of driver list.)

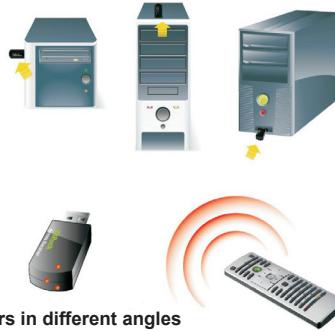



1. Only one of the front USB port can support CIR function. When the CIR function is enabled, the other port will remain USB function.
2. Multi-Angle CIR Receiver is used for front USB only. Please do not use the rear USB bracket to connect it on the rear panel. Multi-Angle CIR Receiver can receive the multi-direction infrared signals (top, down and front), which is compatible with most of the chassis on the market.
3. The Multi-Angle CIR Receiver does not support Hot-Plug function. Please install it before you boot the system.

* ASRock Smart Remote is only supported by some of ASRock motherboards. Please refer to ASRock website for the motherboard support list: <http://www.asrock.com>

2.9 Jumpers Setup

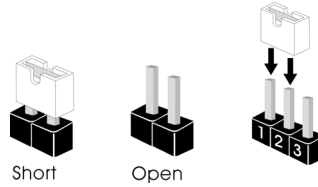
The illustration shows how jumpers are setup. When the jumper cap is placed on pins, the jumper is “Short”. If no jumper cap is placed on pins, the jumper is “Open”. The illustration shows a 3-pin jumper whose pin1 and pin2 are “Short” when jumper cap is placed on these 2 pins.



Jumper	Setting	Description
Clear CMOS Jumper (CLR CMOS1) (see p.14, No. 23)	 1_2 Default	 2_3 Clear CMOS

Note: CLR CMOS1 allows you to clear the data in CMOS. To clear and reset the system parameters to default setup, please turn off the computer and unplug the power cord from the power supply. After waiting for 15 seconds, use a jumper cap to short pin2 and pin3 on CLR CMOS1 for 5 seconds. However, please do not clear the CMOS right after you update the BIOS. If you need to clear the CMOS when you just finish updating the BIOS, you must boot up the system first, and then shut it down before you do the clear-CMOS action. Please be noted that the password, date, time and user default profile will be cleared only if the CMOS battery is removed.



If you clear the CMOS, the case open may be detected. Please adjust the BIOS option “Clear Status” to clear the record of previous chassis intrusion status.

2.10 Onboard Headers and Connectors



Onboard headers and connectors are NOT jumpers. Do NOT place jumper caps over these headers and connectors. Placing jumper caps over the headers and connectors will cause permanent damage of the motherboard!

Serial ATA2 Connectors

(SATA_0: see p.14, No. 13)

(SATA_1: see p.14, No. 11)

(SATA_2: see p.14, No. 14)

(SATA_3: see p.14, No. 10)

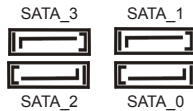

These four Serial ATA2 (SATA2) connectors support SATA data cables for internal storage devices. The current SATA2 interface allows up to 3.0 Gb/s data transfer rate.

Serial ATA (SATA) Data Cable (Optional)



Either end of the SATA data cable can be connected to the SATA2 hard disk or the SATA2 connector on this motherboard.

USB 2.0 Headers

(9-pin USB4_5)

(see p.14 No. 16)

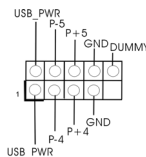

(9-pin USB6_7)

(see p.14 No. 15)

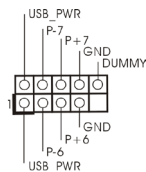

Besides four default USB 2.0 ports on the I/O panel, there are two USB 2.0 headers on this motherboard. Each USB 2.0 header can support two USB 2.0 ports.

Consumer Infrared Module Header

(4-pin CIR1)

(see p.14 No. 17)



This header can be used to connect the remote controller receiver.

Front Panel Audio Header

(9-pin HD_AUDIO1)

(see p.14 No. 20)

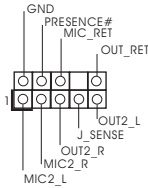

This is an interface for front panel audio cable that allows convenient connection and control of audio devices.



1. High Definition Audio supports Jack Sensing, but the panel wire on the chassis must support HDA to function correctly. Please follow the instruction in our manual and chassis manual to install your system.
2. If you use AC'97 audio panel, please install it to the front panel audio header as below:

- A. Connect Mic_IN (MIC) to MIC2_L.
- B. Connect Audio_R (RIN) to OUT2_R and Audio_L (LIN) to OUT2_L.
- C. Connect Ground (GND) to Ground (GND).
- D. MIC_RET and OUT_RET are for HD audio panel only. You don't need to connect them for AC'97 audio panel.
- E. To activate the front mic.

For Windows® XP / XP 64-bit OS:

Select "Mixer". Select "Recorder". Then click "FrontMic".

For Windows® 8 / 8 64-bit / 7 / 7 64-bit / Vista™ / Vista™ 64-bit OS:

Go to the "FrontMic" Tab in the Realtek Control panel. Adjust "Recording Volume".

System Panel Header

(9-pin PANEL1)

(see p.14 No. 7)

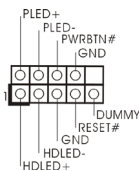

This header accommodates several system front panel functions.



Connect the power switch, reset switch and system status indicator on the chassis to this header according to the pin assignments below. Note the positive and negative pins before connecting the cables.

PWRBTN (Power Switch):

Connect to the power switch on the chassis front panel. You may configure the way to turn off your system using the power switch.

RESET (Reset Switch):

Connect to the reset switch on the chassis front panel. Press the reset switch to restart the computer if the computer freezes and fails to perform a normal restart.

PLED (System Power LED):

Connect to the power status indicator on the chassis front panel. The LED is on when the system is operating. The LED keeps blinking when the system is in S1 sleep state. The LED is off when the system is in S3/S4 sleep state or powered off (S5).

HDLED (Hard Drive Activity LED):

Connect to the hard drive activity LED on the chassis front panel. The LED is on when the hard drive is reading or writing data.

The front panel design may differ by chassis. A front panel module mainly consists of power switch, reset switch, power LED, hard drive activity LED, speaker and etc. When connecting your chassis front panel module to this header, make sure the wire assignments and the pin assignments are matched correctly.

Chassis Speaker Header

(4-pin SPEAKER 1)

(see p.14 No. 8)

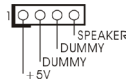

Please connect the chassis speaker to this header.

Chassis and Power Fan Connectors

(4-pin CHA_FAN1)

(see p.14 No. 12)

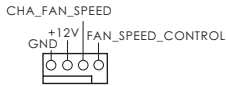

(3-pin PWR_FAN1)

(see p.14 No. 1)



Please connect the fan cables to the fan connectors and match the black wire to the ground pin.

CPU Fan Connector

(4-pin CPU_FAN1)

(see p.14 No. 4)

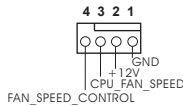

Please connect the CPU fan cable to the connector and match the black wire to the ground pin.



Though this motherboard provides 4-Pin CPU fan (Quiet Fan) support, the 3-Pin CPU fan still can work successfully even without the fan speed control function. If you plan to connect the 3-Pin CPU fan to the CPU fan connector on this motherboard, please connect it to Pin 1-3.

Pin 1-3 Connected ←



3-Pin Fan Installation

ATX Power Connector

(24-pin ATXPWR1)

(see p.14 No. 6)

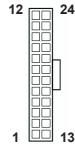

Please connect an ATX power supply to this connector.



Though this motherboard provides 24-pin ATX power connector, it can still work if you adopt a traditional 20-pin ATX power supply. To use the 20-pin ATX power supply, please plug your power supply along with Pin 1 and Pin 13.



20-Pin ATX Power Supply Installation

ATX 12V Power Connector

(4-pin ATX12V1)

(see p.14 No. 2)



Please connect an ATX 12V power supply to this connector.

Chassis Intrusion Header

(2-pin CI1)

(see p.14, No. 22)



This motherboard supports CASE OPEN detection feature that detects if the chassis cover has been removed. This feature requires a chassis with chassis intrusion detection design.

Print Port Header

(25-pin LPT1)

(see p.14 No. 19)

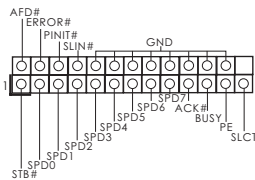

This is an interface for print port cable that allows convenient connection of printer devices.

Serial port Header

(9-pin COM1)

(see p.14 No. 18)

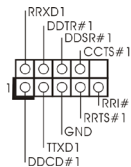

This COM1 header supports a serial port module.

2.11 Serial ATA2 (SATA2) Hard Disks Installation

This motherboard adopts Intel® H61 chipset that supports Serial ATA2 (SATA2) hard disks. You may install SATA2 hard disks on this motherboard for internal storage devices. This section will guide you to install the SATA2 hard disks.

STEP 1: Install the SATA2 hard disks into the drive bays of your chassis.

STEP 2: Connect the SATA power cable to the SATA2 hard disk.

STEP 3: Connect one end of the SATA data cable to the motherboard's SATA2 connector.

STEP 4: Connect the other end of the SATA data cable to the SATA2 hard disk.

2.12 Hot Plug Function for Serial ATA2 (SATA2) HDDs

This motherboard supports Hot Plug function for SATA2 in AHCI mode. Intel® H61 chipset provides hardware support for Advanced Host controller Interface (AHCI), a new programming interface for SATA host controllers developed thru a joint industry effort.



NOTE

What is Hot Plug Function?

If the SATA2 HDDs are NOT set for RAID configuration, it is called "Hot Plug" for the action to insert and remove the SATA2 HDDs while the system is still power-on and in working condition.

However, please note that it cannot perform Hot Plug if the OS has been installed into the SATA2 HDD.

2.13 Serial ATA2 (SATA2) HDD Hot Plug Feature and Operation Guide

This motherboard supports Hot Plug feature for SATA2 HDD in AHCI mode. Please read below operation guide of Hot Plug feature carefully. Before you process the SATA2 HDD Hot Plug, please check below cable accessories from the motherboard gift box pack.

A. 7-pin SATA data cable

B. SATA power cable with SATA 15-pin power connector interface

A. SATA data cable (Red)

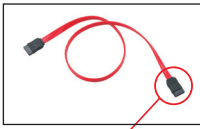

SATA 7-pin connector

B. SATA power cable

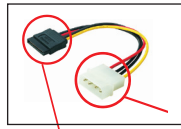

The SATA 15-pin power connector (Black) connect to SATA2 HDD

1x4-pin conventional power connector (White) connect to power supply

Caution

1. Without SATA 15-pin power connector interface, the SATA2 Hot Plug cannot be processed.
2. Even some SATA2 HDDs provide both SATA 15-pin power connector and IDE 1x4-pin conventional power connector interfaces, the IDE 1x4-pin conventional power connector interface is definitely not able to support Hot Plug and will cause the HDD damage and data loss.

Points of attention, before you process the Hot Plug:

1. Below operation procedure is designed only for our motherboard, which supports SATA2 HDD Hot Plug.
 - * The SATA2 Hot Plug feature might not be supported by the chipset because of its limitation, the SATA2 Hot Plug support information of our motherboard is indicated in the product spec on our website: www.asrock.com
2. Make sure your SATA2 HDD can support Hot Plug function from your dealer or HDD user manual. The SATA2 HDD, which cannot support Hot Plug function, will be damaged under the Hot Plug operation.
3. Please make sure the SATA2 driver is installed into system properly. The latest SATA2 driver is available on our support website: www.asrock.com
4. Make sure to use the SATA power cable & data cable, which are from our motherboard package.
5. Please follow below instructions step by step to reduce the risk of HDD crash or data loss.

How to Hot Plug a SATA2 HDD:

Points of attention, before you process the Hot Plug:

Please do follow below instruction sequence to process the Hot Plug, improper procedure will cause the SATA2 HDD damage and data loss.

Step 1 Please connect SATA power cable 1x4-pin end (White) to the power supply 1x4-pin cable.

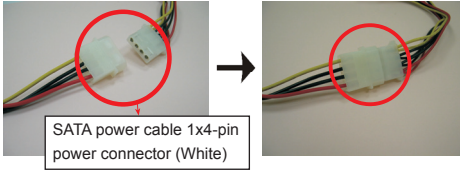

Step 2 Connect SATA data cable to the motherboard's SATA2 connector.

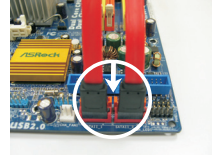

Step 3 Connect SATA 15-pin power cable connector (Black) end to SATA2 HDD.



Step 4 Connect SATA data cable to the SATA2 HDD.



How to Hot Unplug a SATA2 HDD:

Points of attention, before you process the Hot Unplug:

Please do follow below instruction sequence to process the Hot Unplug, improper procedure will cause the SATA2 HDD damage and data loss.

Step 1 Unplug SATA data cable from SATA2 HDD side.

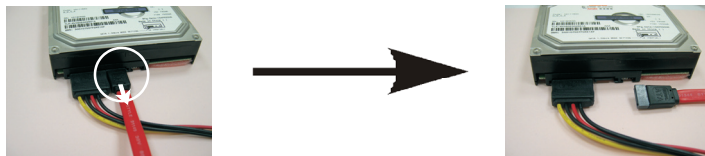

Step 2 Unplug SATA 15-pin power cable connector (Black) from SATA2 HDD side.

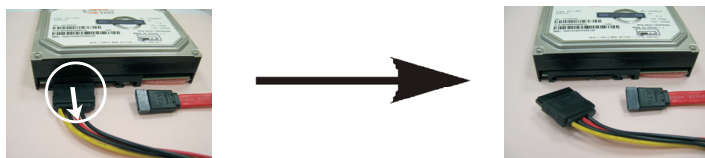

2.14 Driver Installation Guide

To install the drivers to your system, please insert the support CD to your optical drive first. Then, the drivers compatible to your system can be auto-detected and listed on the support CD driver page. Please follow the order from up to bottom side to install those required drivers. Therefore, the drivers you install can work properly.

2.15 Installing Windows® 8 / 8 64-bit / 7 / 7 64-bit / Vista™ / Vista™ 64-bit / XP / XP 64-bit Without RAID Functions

If you want to install Windows® 8 / 8 64-bit / 7 / 7 64-bit / Vista™ / Vista™ 64-bit / XP / XP 64-bit OS on your SATA2 HDDs without RAID functions, please follow below procedures according to the OS you install.

2.15.1 Installing Windows® XP / XP 64-bit Without RAID Functions

If you want to install Windows® XP / XP 64-bit OS on your SATA2 HDDs without RAID functions, please follow below steps.

Using SATA2 HDDs with NCQ function

STEP 1: Set Up UEFI.

- A. Enter UEFI SETUP UTILITY → Advanced screen → Storage Configuration.
- B. Set the option "SATA Mode Selection" to [AHCI].

STEP 2: Make a SATA2 driver diskette. (Please use an USB floppy or a floppy disk.)

- A. Insert the Support CD into your optical drive to boot your system.
- B. During POST at the beginning of system boot-up, press <F11> key, and then a window for boot devices selection appears. Please select CD-ROM as the boot device.
- C. When you see the message on the screen, "Do you want to generate Serial ATA driver diskette [YN]?", press <Y>.
- D. Then you will see these messages,

Please insert a diskette into the floppy drive.

WARNING! Formatting the floppy diskette will lose ALL data in it!

Start to format and copy files [YN]?

Please insert a floppy diskette into the floppy drive, and press <Y>.

- E. The system will start to format the floppy diskette and copy SATA2 drivers into the floppy diskette.

STEP 3: Install Windows® XP / XP 64-bit OS on your system.

After making a SATA2 driver diskette, you can start to install Windows® XP / XP 64-bit on your system. At the beginning of Windows® setup, press F6 to install a third-party AHCI driver. When prompted, insert the SATA2 driver diskette containing the Intel® AHCI driver. After reading the floppy disk, the driver will be presented. Select the driver to install according to the mode you choose and the OS you install.

Using SATA2 HDDs without NCQ function

STEP 1: Set up UEFI.

- A. Enter UEFI SETUP UTILITY → Advanced screen → Storage Configuration.
- B. Set the option "SATA Mode Selection" to [IDE].

STEP 2: Install Windows® XP / XP 64-bit OS on your system.

2.15.2 Installing Windows® 8 / 8 64-bit / 7 / 7 64-bit / Vista™ / Vista™ 64-bit Without RAID Functions

If you want to install Windows® 8 / 8 64-bit / 7 / 7 64-bit / Vista™ / Vista™ 64-bit OS on your SATA2 HDDs without RAID functions, please follow below steps.

Using SATA2 HDDs with NCQ function

STEP 1: Set Up UEFI.

- A. Enter UEFI SETUP UTILITY → Advanced screen → Storage Configuration.
- B. Set the option "SATA Mode Selection" to [AHCI].

STEP 2: Install Windows® 8 / 8 64-bit / 7 / 7 64-bit / Vista™ / Vista™ 64-bit OS on your system.

Using SATA2 HDDs without NCQ function

STEP 1: Set up UEFI.

- A. Enter UEFI SETUP UTILITY → Advanced screen → Storage Configuration.
- B. Set the option "SATA Mode Selection" to [IDE].

STEP 2: Install Windows® 8 / 8 64-bit / 7 / 7 64-bit / Vista™ / Vista™ 64-bit OS on your system.

2.16 ASRock XFast 555

ASRock's unique XFast 555 Technology includes three tools that allow users to experience huge performance boosts. There is XFast RAM for 5 times better system speed, XFast LAN for 5 times faster LAN speed and XFast USB for 5 times faster USB speed.



2.16.1 ASRock XFast RAM

ASRock XFast RAM is a new function that is included in ASRock Extreme Tuning Utility (AXTU). It fully utilizes the memory space that cannot be used under Windows® 32-bit OS. ASRock XFast RAM shortens the loading time of previously visited websites, making web surfing faster than ever. And it also boosts the speed of Adobe Photoshop 5 times faster. Another advantage of ASRock XFast RAM is that it reduces the frequency of accessing your SSDs or HDDs in order to extend their lifespan.



XFast RAM Settings



You may find the XFast RAM setup page in the left panel of ASRock Extreme Tuning utility.

First select the desired drive and disk size to create a virtual drive.

To access more than 4GB of RAM in Windows® 32-bit OS, please leave PAE mode set to ON.

In the options section, users may enable and assign the size of a partition for Ready Boost if they're using a 32-bit OS. We suggest setting the size of Ready Boost one to three times larger than your RAM for optimized performance.

Normally, when the memory being used by all the existing processes exceeds the available RAM, the operating system moves pages (4-KB pieces) of one or more virtual address spaces to the computer's hard disk. By enabling Memory Pagefile, the system puts the pages into the virtual drive instead of the hard disk drive to accelerate performance speed.

Lastly, select the files that are supposed to go in the virtual drive to speed up the system's performance. Such as temporary files created by computer programs when they cannot allocate enough memory for its tasks. Or internet cache files including html, images, Cascading Style Sheets and JavaScript scripts from IE, Firefox and Google Chrome.

Click Backup XFast RAM if you wish to make a backup. Then click on the APPLY button to activate XFast RAM. Click on STOP if you wish to deactivate XFastRAM.

The virtual disk will appear once you restart the system.

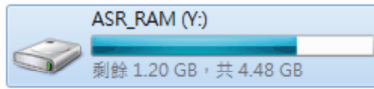

2.16.2 ASRock XFast LAN

ASRock XFast LAN provides several special features for faster internet access. For example, LAN Application Prioritization allows you to configure your application's priority ideally or add new programs to the priority list. Traffic Shaping helps you watch Youtube HD videos and download files simultaneously without hiccups. And in the status window there's Real-Time Analysis of Your Data so you can easily recognize the data streams you are transferring currently.



ASRock XFast LAN UI Overview

The default status window

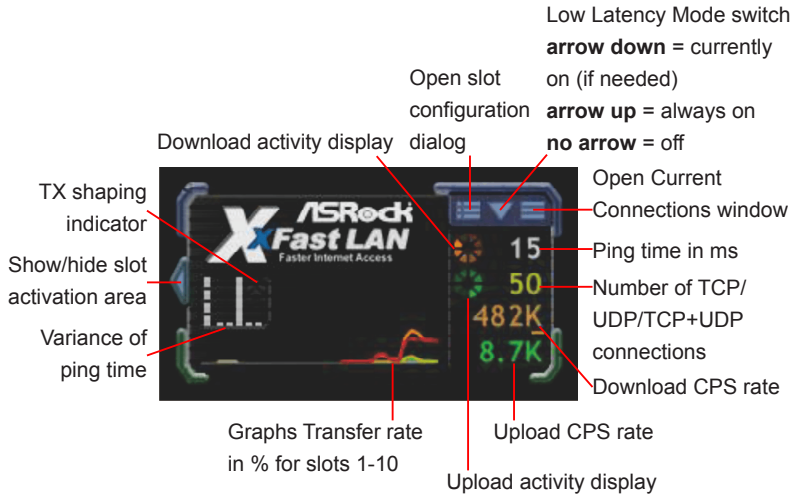

Right click for more options

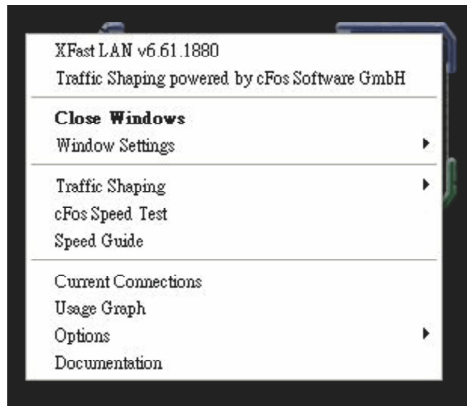

Close Windows

Hides the status window. Can also be done by double clicking on the status window. Reopen by right clicking on the XFast LAN icon on the bottom right and selecting **Open windows**.

Window settings

Users may configure the skin and effects of the user interface. Make the keyboard LEDs display Traffic Shaping information. Or display the XFast LAN status window on a Logitech gamer keyboard instead of Windows desktop.

Traffic Shaping

Traffic Shaping is used to optimize or guarantee performance, improve latency, and/or increase usable bandwidth for some kinds of packets by delaying other kinds of packets that meet certain criteria. In other words, it increases the speed while keeping the overall ping time low.

cFos Speed Test

Quickly test the upload and download speed of your Internet connection.

Speed Guide

This guide can either help you get the maximum out of your connection or solve problems with speed, ping time or connections.

Current Connection

Shows the details of current internet connections.

Usage Graph

Displays the Usage Graph.

Options

Configure settings such as program prioritization, language and update the program.

Documentation

Opens detailed help for XFast LAN in a browser.

Adding a new application and changing its priority

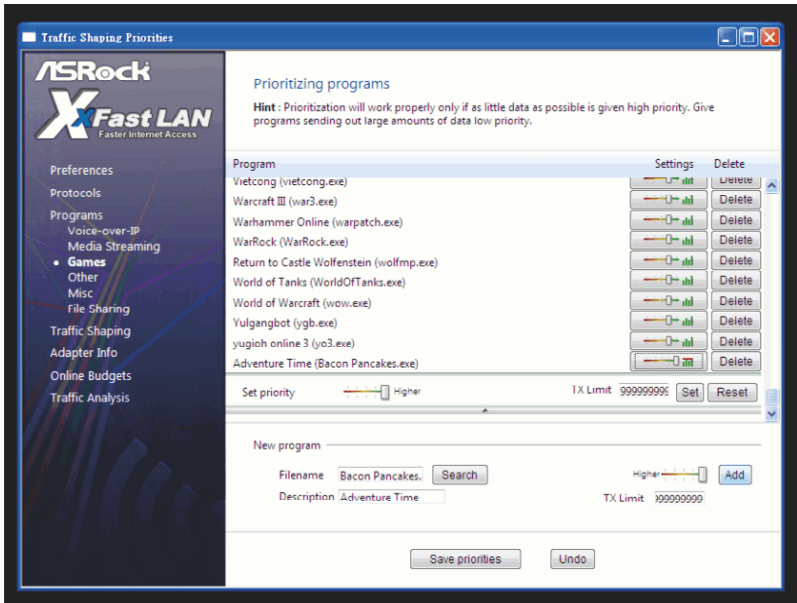

Click search and choose a new program you wish to add. You can also type in a short description for the program.

Set the priority for the program and TX Limit then click Add to confirm.

Hit the switch button to change configurations or Delete to remove the application from the priority list.

2.16.3 ASRock XFast USB

Not only does ASRock XFast USB boost up the performance of USB 2.0 storage devices, but also USB 3.0 devices. Users may experience up to five times faster USB data transfer speed!



ASRock XFast USB UI Overview



Plug in your USB storage device and XFast USB automatically sets it to Turbo mode!

Chapter 3: UEFI SETUP UTILITY

3.1 Introduction

This section explains how to use the UEFI SETUP UTILITY to configure your system. The UEFI chip on the motherboard stores the UEFI SETUP UTILITY. You may run the UEFI SETUP UTILITY when you start up the computer. Please press <F2> or during the Power-On-Self-Test (POST) to enter the UEFI SETUP UTILITY, otherwise, POST will continue with its test routines.

If you wish to enter the UEFI SETUP UTILITY after POST, restart the system by pressing <Ctl> + <Alt> + <Delete>, or by pressing the reset button on the system chassis. You may also restart by turning the system off and then back on.



Because the UEFI software is constantly being updated, the following UEFI setup screens and descriptions are for reference purpose only, and they may not exactly match what you see on your screen.

3.1.1 UEFI Menu Bar

The top of the screen has a menu bar with the following selections:

Main	To set up the system time/date information
OC Tweaker	To set up overclocking features
Advanced	To set up the advanced UEFI features
Tool	Useful tools
H/W Monitor	To display current hardware status
Boot	To set up the default system device to locate and load the Operating System
Security	To set up the security features
Exit	To exit the current screen or the UEFI SETUP UTILITY

Use <←> key or <→> key to choose among the selections on the menu bar, and then press <Enter> to get into the sub screen. You can also use the mouse to click your required item.

3.1.2 Navigation Keys

Please check the following table for the function description of each navigation key.

Navigation Key(s)	Function Description
← / →	Moves cursor left or right to select Screens
↑ / ↓	Moves cursor up or down to select items
+ / -	To change option for the selected items
<Tab>	Switch to next function
<Enter>	To bring up the selected screen
<PGUP>	Go to the previous page
<PGDN>	Go to the next page
<HOME>	Go to the top of the screen
<END>	Go to the bottom of the screen
<F1>	To display the General Help Screen
<F7>	Discard changes and exit the UEFI SETUP UTILITY
<F9>	Load optimal default values for all the settings
<F10>	Save changes and exit the UEFI SETUP UTILITY
<F12>	Print screen
<ESC>	Jump to the Exit Screen or exit the current screen

3.2 Main Screen

When you enter the UEFI SETUP UTILITY, the Main screen will appear and display the system overview.



3.3 OC Tweaker Screen

In the OC Tweaker screen, you can set up overclocking features.



CPU Configuration

CPU Ratio

Use this item to change the ratio value of this motherboard.

Intel SpeedStep Technology

Intel SpeedStep technology is Intel's new power saving technology. Processors can switch between multiple frequencies and voltage points to enable power saving. The default value is [Enabled]. Configuration options: [Enabled] and [Disabled]. If you install Windows® Vista™ / 7 / 8 and want to enable this function, please set this item to [Enabled]. This item will be hidden if the current CPU does not support Intel SpeedStep technology.



Please note that enabling this function may reduce CPU voltage and lead to system stability or compatibility issues with some power supplies. Please set this item to [Disabled] if above issues occur.

Intel Turbo Boost Technology

Use this item to enable or disable Intel Turbo Boost Mode Technology. Turbo Boost Mode allows processor cores to run faster than marked frequency in specific conditions. The default value is [Enabled].

Long Duration Power Limit

Use this item to configure long duration power limit in watts. The default value is [Auto].

Long Duration Maintained

Use this item to configure time window which the long duration power is maintained. The default value is [Auto].

Short Duration Power Limit

Use this item to configure short duration power limit in watts. The default value is [Auto].

Primary Plane Current Limit

Use this item to configure the maximum instantaneous current allowed for the primary plane. The default value is [Auto].

Secondary Plane Current Limit

Use this item to configure the maximum instantaneous current allowed for the secondary plane. The default value is [Auto].

GT OverClocking Support

Use this item to enable or disable GT OverClocking Support. The default value is [Disabled].

DRAM Timing Configuration

Load XMP Setting

Use this to load XMP setting. Configuration options: [Auto], [Default], [Profile 1] and [Profile 2]. The default value is [Auto].

DRAM Frequency

If [Auto] is selected, the motherboard will detect the memory module(s) inserted and assign the appropriate frequency automatically.

DRAM Timing Configuration



DRAM tCL

Use this item to change CAS# Latency (tCL) Auto/Manual setting. The default is [Auto].

DRAM tRCD

Use this item to change RAS# to CAS# Delay (tRCD) Auto/Manual setting. The default is [Auto].

DRAM tRP

Use this item to change Row Precharge Time (tRP) Auto/Manual setting.
The default is [Auto].

DRAM tRAS

Use this item to change RAS# Active Time (tRAS) Auto/Manual setting.
The default is [Auto].

Command Rate (CR)

Use this item to change Command Rate (CR) Auto/Manual setting. The default is [Auto].

DRAM tWR

Use this item to change Write Recovery Time (tWR) Auto/Manual setting.
The default is [Auto].

DRAM tRFC

Use this item to change Refresh Cycle Time (tRFC) Auto/Manual setting.
The default is [Auto].

DRAM tRRD

Use this item to change RAS to RAS Delay (tRRD) Auto/Manual setting.
The default is [Auto].

DRAM tWTR

Use this item to change Write to Read Delay (tWTR) Auto/Manual setting.
The default is [Auto].

DRAM tRTP

Use this item to change Read to Precharge (tRTP) Auto/Manual setting.
The default is [Auto].

DRAM tFAW

Use this item to change Four Activate Window (tFAW) Auto/Manual setting. The default is [Auto].

DRAM tCWL

Use this item to change CAS# Write Latency (tCWL) Auto/Manual setting.
The default is [Auto].

ODT WR (CHA)

Use this item to change ODT WR (CHA) setting. The default is [Auto].

ODT WR (CHB)

Use this item to change ODT WR (CHB) setting. The default is [Auto].

ODT NOM (CHA)

Use this item to change ODT NOM (CHA) setting. The default is [Auto].

ODT NOM (CHB)

Use this item to change ODT NOM (CHB) setting. The default is [Auto].

MRC Fast Boot

Use this item to enable or disable MRC Fast Boot. The default is [Enabled].

Voltage Configuration

DRAM Voltage

Use this to select DRAM Voltage. The default value is [Auto].

3.4 Advanced Screen

In this section, you may set the configurations for the following items: CPU Configuration, North Bridge Configuration, South Bridge Configuration, Storage Configuration, Intel(R) Rapid Start Technology, Intel(R) Smart Connect Technology, Super IO Configuration, ACPI Configuration and USB Configuration.



Setting wrong values in this section may cause the system to malfunction.

3.4.1 CPU Configuration



Intel Hyper-Threading Technology

To enable this feature, a computer system with an Intel processor that supports Hyper-Threading technology and an operating system that includes optimization for this technology, such as Microsoft® Windows® XP / Vista™ / 7 / 8 is required. Set to [Enabled] if using Microsoft® Windows® XP, Vista™, 7, 8, or Linux kernel version 2.4.18 or higher. This option will be hidden if the installed CPU does not support Hyper-Threading technology.

Active Processor Cores

Use this item to select the number of cores to enable in each processor package. The default value is [All].

Enhance Halt State (C1E)

All processors support the Halt State (C1). The C1 state is supported through the native processor instructions HLT and MWAIT and requires no hardware support from the chipset. In the C1 power state, the processor maintains the context of the system caches.

CPU C3 State Support

Use this to enable or disable CPU C3 (ACPI C2) report to OS.

CPU C6 State Support

Use this to enable or disable CPU C6 (ACPI C3) report to OS.

Package C State Support

Selected option will program into C State package limit register. The default value is [Auto].

CPU Thermal Throttling

You may select [Enabled] to enable CPU internal thermal control mechanism to keep the CPU from overheating.

No-Execute Memory Protection

No-Execution (NX) Memory Protection Technology is an enhancement

to the IA-32 Intel Architecture. An IA-32 processor with “No Execute (NX) Memory Protection” can prevent data pages from being used by malicious software to execute codes. This option will be hidden if the current CPU does not support No-Execute Memory Protection.

Intel Virtualization Technology

When this option is set to [Enabled], a VMM (Virtual Machine Architecture) can utilize the additional hardware capabilities provided by Vanderpool Technology. This option will be hidden if the installed CPU does not support Intel Virtualization Technology.

Hardware Prefetcher

Use this item to turn on/off the MLC streamer prefetcher.

Adjacent Cache Line Prefetch

Use this item to turn on/off prefetching of adjacent cache lines.

3.4.2 North Bridge Configuration



Primary Graphics Adapter

This allows you to select [Onboard], [PCI] or [PCI Express] as the boot graphic adapter priority. The default value is [PCI Express].

VT-d

Use this to enable or disable Intel® VT-d technology (Intel® Virtualization Technology for Directed I/O). The default value of this feature is [Disabled].

PCIE1 Link Speed

This allows you to select PCIE1 Link Speed. The default value is [Auto].

Share Memory

This allows you to set onboard VGA share memory feature. The default value is [Auto].

IGPU Multi-Monitor

This allows you to enable or disable IGPU Multi-Monitor. The default value is [Disabled]. If you install the PCI Express card under Windows® XP / Vista™ OS, please disable this option.

Render Standby

Use this to enable or disable Render Standby by Internal Graphics Device. The default value is [Enabled].

3.4.3 South Bridge Configuration



Onboard HD Audio

Select [Auto], [Enabled] or [Disabled] for the onboard HD Audio feature.

Front Panel

Select [Auto] or [Disabled] for the onboard HD Audio Front Panel.

Onboard HDMI HD Audio

This allows you to enable or disable the Onboard HDMI HD Audio feature.

Onboard LAN

This allows you to enable or disable the Onboard LAN feature.

Deep Sleep

Mobile platforms support Deep S4/S5 in DC only and desktop platforms support Deep S4/S5 in AC only. The default value is [Enabled in S5].

Restore on AC/Power Loss

This allows you to set the power state after an unexpected AC/power loss. If [Power Off] is selected, the AC/power remains off when the power recovers. If [Power On] is selected, the AC/power resumes and the system starts to boot up when the power recovers.

Good Night LED

Use this item to enable or disable Power LED and LAN LED.

3.4.4 Storage Configuration



SATA Controller(s)

Use this item to enable or disable the SATA Controller feature.

SATA Mode Selection

Use this to select SATA mode. Configuration options: [IDE Mode], [AHCI Mode] and [Disabled]. The default value is [AHCI Mode].



AHCI (Advanced Host Controller Interface) supports NCQ and other new features that will improve SATA disk performance but IDE mode does not have these advantages.

SATA Aggressive Link Power Management

Use this item to configure SATA Aggressive Link Power Management.

Hard Disk S.M.A.R.T.

Use this item to enable or disable the S.M.A.R.T. (Self-Monitoring, Analysis, and Reporting Technology) feature. Configuration options: [Disabled] and [Enabled].

3.4.5 Intel(R) Rapid Start Technology



Intel(R) Rapid Start Technology

Use this item to enable or disable Intel(R) Rapid Start Technology. Intel(R) Rapid Start Technology is a new zero power hibernation mode which allows users to resume in just 5-6 seconds. The default is [Enabled].

Entry After

Select a time to enable RTC wake timer at S3 entry. The default is [10 minutes].

Active Page Threshold Support

This allows you to enable or disable Active Page Threshold Support. The default is [Disabled].

3.4.6 Intel(R) Smart Connect Technology



Intel(R) Smart Connect Technology

Use this item to enable or disable Intel(R) Smart Connect Technology. Intel(R) Smart Connect Technology keeps your e-mail and social networks, such as Twitter, Facebook, etc. updated automatically while the computer is in sleep mode. The default is [Enabled].

3.4.7 Super IO Configuration



Serial Port

Use this item to enable or disable the onboard serial port.

Port Address

Use this item to set the address for the onboard serial port.

Configuration options: [3F8 / IRQ4] and [3E8 / IRQ4].

Parallel Port

Use this item to enable or disable the onboard parallel port.

Device Mode

Use this item to change the Printer Port mode.

Change Settings

Use this item to select an optional setting for Super IO device.

3.4.8 ACPI Configuration



Suspend to RAM

Use this item to select whether to auto-detect or disable the Suspend-to-RAM feature. Selecting [Auto] will enable this feature if the OS supports it.

Check Ready Bit

Use this item to enable or disable the feature Check Ready Bit.

ACPI HPET Table

Use this item to enable or disable ACPI HPET Table. The default value is [Enabled]. Please set this option to [Enabled] if you plan to use this motherboard to submit Windows® certification.

PS/2 Keyboard Power On

Use this item to enable or disable PS/2 keyboard to turn on the system from the power-soft-off mode.

PCI Device Power On

Use this item to enable or disable PCI devices to turn on the system from the power-soft-off mode.

Ring-In Power On

Use this item to enable or disable Ring-In signals to turn on the system from the power-soft-off mode.

RTC Alarm Power On

Use this item to enable or disable RTC (Real Time Clock) to power on the system.

USB Keyboard/Remote Power On

Use this item to enable or disable USB Keyboard/Remote to turn on the system from the power-soft-off mode.

USB Mouse Power On

Use this item to enable or disable USB Mouse to turn on the system from the power-soft-off mode.

CSM

Please disable CSM when you enable Fast Boot option. The default value is [Enabled].

3.4.9 USB Configuration



USB 2.0 Controller

Use this item to enable or disable the use of USB 2.0 controller.

Legacy USB Support

Use this option to select legacy support for USB devices. There are four configuration options: [Enabled], [Auto], [Disabled] and [UEFI Setup Only]. The default value is [Enabled]. Please refer to below descriptions for the details of these four options:

[Enabled] - Enables support for legacy USB.

[Auto] - Enables legacy support if USB devices are connected.

[Disabled] - USB devices are not allowed to use under legacy OS and UEFI setup when [Disabled] is selected. If you have USB compatibility issue, it is recommended to select [Disabled] to enter OS.

[UEFI Setup Only] - USB devices are allowed to use only under UEFI setup and Windows / Linux OS.

3.5 Tool



OMG(Online Management Guard)

Administrators are able to establish an internet curfew or restrict internet access at specified times via OMG. You may schedule the starting and ending hours of internet access granted to other users. In order to prevent users from bypassing OMG, guest accounts without permission to modify the system time are required.

UEFI Update Utility

Instant Flash

Instant Flash is a UEFI flash utility embedded in Flash ROM. This convenient UEFI update tool allows you to update system UEFI without entering operating systems first like MS-DOS or Windows®. Just save the new UEFI file to your USB flash drive, floppy disk or hard drive and launch this tool, then you can update your UEFI only in a few clicks without preparing an additional floppy diskette or other complicated flash utility. Please be noted that the USB flash drive or hard drive must use FAT32/16/12 file system. If you execute Instant Flash utility, the utility will show the UEFI files and their respective information. Select the proper UEFI file to update your UEFI, and reboot your system after the UEFI update process is completed.

Internet Flash

Internet Flash searches for available UEFI firmware updates from our servers. In other words, the system can auto-detect the latest UEFI from our servers and flash them without entering Windows OS. Please note that you must be running on a DHCP configured computer in order to enable this function.

Network Configuration



Internet Setting

Use this item to set up the internet connection mode. Configuration options: [DHCP (Auto IP)] and [PPPOE].

UEFI Download Server

Use this item to select UEFI firmware download server for Internet Flash. Configuration options: [Asia], [Europe], [USA] and [China].

Dehumidifier Function

Users may prevent motherboard damages due to dampness by enabling “Dehumidifier Function”. When enabling Dehumidifier Function, the computer will power on automatically to dehumidify the system after entering S4/S5 state.

Dehumidifier Period

This allows users to configure the period of time until the computer powers on and enables “Dehumidifier” after entering S4/S5 state.

Dehumidifier Duration

This allows users to configure the duration of the dehumidifying process before it returns to S4/S5 state.

Dehumidifier CPU Fan Setting

Use this setting to configure CPU fan speed while “Dehumidifier” is enabled.

Would you like to save current setting user defaults?

In this option, you are allowed to load and save three user defaults according to your own requirements.

3.6 Hardware Health Event Monitoring Screen

In this section, it allows you to monitor the status of the hardware on your system, including the parameters of the CPU temperature, motherboard temperature, CPU fan speed, chassis fan speed, and the critical voltage.



CPU Fan Setting

This allows you to set the CPU fan speed. Configuration options: [Full On] and [Automatic Mode]. The default is value [Full On].

Chassis Fan Setting

This allows you to set the chassis fan speed. Configuration options: [Full On] and [Automatic Mode]. The default is value [Full On].

Case Open Feature

This allows you to enable or disable case open detection feature. The default is value [Disabled].

Clear Status

This option appears only when the case open has been detected. Use this option to keep or clear the record of previous chassis intrusion status.

3.7 Boot Screen

In this section, it will display the available devices on your system for you to configure the boot settings and the boot priority.



Fast Boot

Fast Boot minimizes your computer's boot time. There are three configuration options: [Disabled], [Fast] and [Ultra Fast]. The default value is [Disabled]. Please refer to below descriptions for the details of these three options:

[Disabled] - Disable Fast Boot.

[Fast] - The only restriction is you may not boot by using an USB flash drive.

[Ultra Fast] - There are a few restrictions.

1. Only supports Windows® 8 UEFI operating system.
2. You will not be able to enter BIOS Setup (Clear CMOS or run utility in Windows® to enter BIOS Setup).
3. If you are using an external graphics card, the VBIOS must support UEFI GOP in order to boot.

Boot From Onboard LAN

Use this item to enable or disable the Boot From Onboard LAN feature.

Setup Prompt Timeout

This shows the number of seconds to wait for setup activation key. 65535(0xFFFF) means indefinite waiting.

Bootup Num-Lock

If this item is set to [On], it will automatically activate the Numeric Lock function after boot-up.

Full Screen Logo

Use this item to enable or disable OEM Logo. The default value is [Enabled].

AddOn ROM Display

Use this option to adjust AddOn ROM Display. If you enable the option "Full Screen Logo" but you want to see the AddOn ROM information when the system boots, please select [Enabled]. Configuration options: [Enabled] and [Disabled]. The default value is [Enabled].

Boot Failure Guard

Enable or disable the feature of Boot Failure Guard.

Boot Failure Guard Count

Enable or disable the feature of Boot Failure Guard Count.

3.8 Security Screen

In this section, you may set or change the supervisor/user password for the system. For the user password, you may also clear it.



Secure Boot

Use this to enable or disable Secure Boot. The default value is [Disabled].

3.9 Exit Screen



Save Changes and Exit

When you select this option, the following message “Save configuration changes and exit setup?” will pop-out. Select [Yes] to save the changes and exit the UEFI SETUP UTILITY.

Discard Changes and Exit

When you select this option, the following message “Discard changes and exit setup?” will pop-out. Select [Yes] to exit the UEFI SETUP UTILITY without saving any changes.

Discard Changes

When you select this option, the following message “Discard changes?” will pop-out. Select [Yes] to discard all changes.

Load UEFI Defaults

Load UEFI default values for all the setup questions. F9 key can be used for this operation.

Launch EFI Shell from filesystem device

Attempts to Launch EFI Shell application (Shell64.efi) from one of the available filesystem devices.

Chapter 4: Software Support

4.1 Install Operating System

This motherboard supports various Microsoft® Windows® operating systems: 8 / 8 64-bit / 7 / 7 64-bit / Vista™ / Vista™ 64-bit / XP / XP 64-bit. Because motherboard settings and hardware options vary, use the setup procedures in this chapter for general reference only. Refer to your OS documentation for more information.

4.2 Support CD Information

The Support CD that came with the motherboard contains necessary drivers and useful utilities that enhance the motherboard features.

4.2.1 Running The Support CD

To begin using the support CD, insert the CD into your CD-ROM drive. The CD automatically displays the Main Menu if "AUTORUN" is enabled in your computer. If the Main Menu did not appear automatically, locate and double click on the file "ASSETUP.EXE" from the BIN folder in the Support CD to display the menus.

4.2.2 Drivers Menu

The Drivers Menu shows the available devices drivers if the system detects installed devices. Please install the necessary drivers to activate the devices.

4.2.3 Utilities Menu

The Utilities Menu shows the applications software that the motherboard supports. Click on a specific item then follow the installation wizard to install it.

4.2.4 Contact Information

If you need to contact ASRock or want to know more about ASRock, welcome to visit ASRock's website at <http://www.asrock.com>; or you may contact your dealer for further information.

Installing OS on a HDD Larger Than 2TB

This motherboard is adopting UEFI BIOS that allows Windows® OS to be installed on a large size HDD (>2TB). Please follow below procedure to install the operating system.

1. Please make sure to use **Windows® Vista™ 64-bit (with SP1 or above)**, **Windows® 7 64-bit** or **Windows® 8 64-bit**.
2. Press <F2> or <Delete> at system POST. Set **AHCI Mode** in UEFI Setup Utility > Advanced > Storage Configuration > SATA Mode.
3. Choose the item “**UEFI:xxx**“ to boot in UEFI Setup Utility > Boot > Boot Option #1. (“xxx” is the device which contains your Windows® installation files. Normally it is an optical drive.) You can also press <F11> to launch boot menu at system POST and choose the item “**UEFI:xxx**“ to boot.
4. Start Windows® installation.
5. If you install **Windows® 7 64-bit** OS, OS will be formatted by GPT (GUID Partition Table). Please install the hotfix file from Microsoft®:
<http://support.microsoft.com/kb/979903>