

SAL724

SMARTMOUNT LT

Articulating Wall Mount

For 10" to 29" Displays

The SmartMountLT™ series articulating wall mounts give the ultimate in display positioning, with one-person, Hook-and-Hang™ easy installation. The articulating arm allows you to extend the display up to 14.58" (370mm) from the wall, and can retract to just 2.48" (63mm) from the wall. The integrated cable management provides a clean, professional finish. One-Touch™ tilt of $\pm 15^\circ$, $\pm 5^\circ$ roll for post-installation leveling and $\pm 90^\circ$ pivoting means the display will be perfectly positioned for the optimum viewing angle.



Display size: 10"-29"



Max load: 25lb (11kg)

FEATURES

- Fits 10" to 29" displays, up to 25lb (11kg)
- Extends display 14.58" (370mm) from the wall
- Retracts to hold display just 2.48" (63mm) from the wall
- $\pm 90^\circ$ of pivot allows for perfect display positioning
- Quick and easy, Hook-and-Hang™ one-person installation
- Integrated cable management provides clean, professional installation finish
- Easy leveling $\pm 5^\circ$ after display installation
- Landscape or portrait mounting options increases display versatility
- Mounts to wood studs, concrete, cinder block or metal studs (metal stud accessory required)
- VESA® 75 and 100mm compliant
- Installation hardware included
- UL Listed
- Five-year warranty

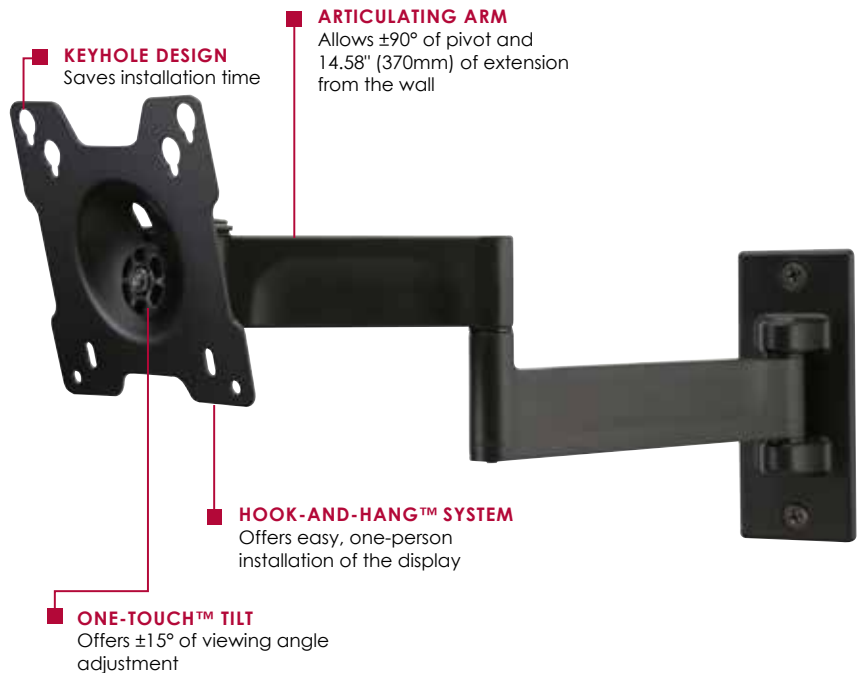

$\pm 15^\circ$ of viewing angle adjustment

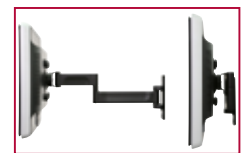

Arm retracts to just 2.48" (63mm) and extends up to 14.58" (370mm) from the wall



Patent Pending.

CLICK: peerless-av.com

CALL: 800.865.2112

FAX: 800.359.6500

peerless-AV

SAL724	SmartMountLT™ Articulating Wall Mount for 10" to 29" Displays
---------------	---

Product Specifications

	DIMENSIONS (W x H x D)	PRODUCT WEIGHT	LOAD CAPACITY	FINISH	AVAILABLE COLORS
SAL724	8.97" x 7.53" x 2.48"-14.58" (228 x 191 x 63-370mm)	2.16lb (0.98kg)	25lb (11kg)	Matte	Black

Package Specifications

	PACKAGE SIZE (W x H x D)	PACKAGE SHIP WEIGHT	PACKAGE UPC CODE	PACKAGE CONTENTS	UNITS IN PACKAGE
SAL724	9.45" x 8.00" x 2.25" (240 x 203 x 57mm)	2.75lb (1.25kg)	735029292524	Wall mount, attachment hardware and installation instructions	1

Accessories

ACC972:	VESA® 200 x 100mm Adaptor Plates	ACC918:	Security Fasteners for Wall Arms
ESHV10:	Single AV Wall Shelf	WSP700/701:	Metal Stud Wall Plate
ESHV20:	Single AV Wall Shelf with Glass		
ESHV30:	Dual AV Wall Shelf with Glass		

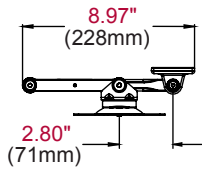

TOP VIEW

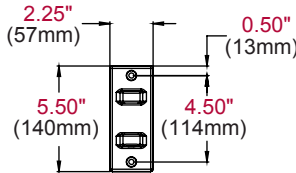

WALL PLATE

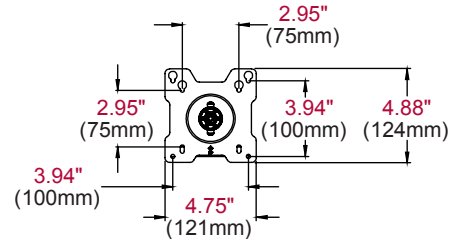

ADAPTER PLATE

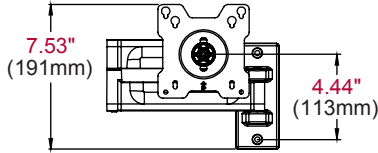

FRONT VIEW

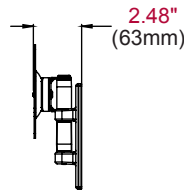

SIDE VIEW

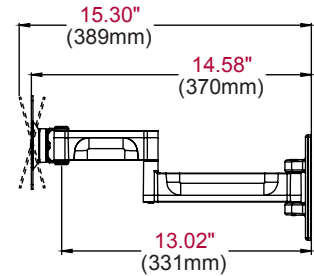

SIDE VIEW
EXTENDED
+/-15° TILT

ARCHITECTS SPECIFICATIONS

The Articulating Wall Mount shall be a Peerless-AV model SAL724 and shall be located where indicated on the plans. Assembly and installation shall be done according to instructions provided by the manufacturer.