











Please unscrew all hardware from cushion before assembly.
Por favor de destornillar todos los tornillos del cojin antes de assamblar la silla.

MODEL : B700 B706

(1)x1	(2)x1	(3)x1 (L)x1 (R)
		
Back	Seat	Left / Right Arm
(4)x5	(5)x1	(6)x1
		
Caster	Gas Lift W/ Cover	Nylon Base
(7)x1	<p>(A)x4  M6*22 MECHANISM SCREW</p> <p>(B)x3  M8*22 L-bar Screw</p> <p>(C)x8  M6*30 ARM SCREW</p>	
	Mechanism	

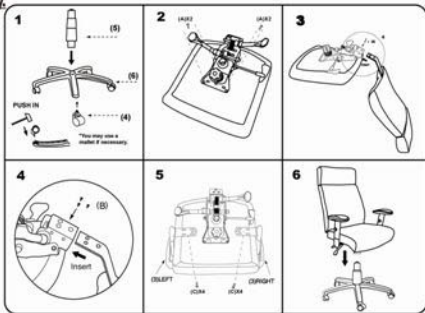

Insert and loosely tighten all screws.
 When assembly is completed, fully tighten all screws before using.
 This chair is only intended for sitting. Any other use will void the warranty.



Customer Service Hotline: 1-800-593-1888
 For further assembly instructions,
 please visit our website at www.bossschair.com